











# Nature

A WEEKLY

ILLUSTRATED JOURNAL OF SCIENCE





*Supplement to Nature.* ]  
May 30, 1895.

# Nature

A WEEKLY

ILLUSTRATED JOURNAL OF SCIENCE

VOLUME LI

NOVEMBER 1894 to APRIL 1895

*"To the solid ground  
Of Nature trusts the mind which builds for aye."*—WORDSWORTH

London and New York  
MACMILLAN AND CO



# INDEX

- ABEADIE (M. D.), Sulphur Fumigation—a Remedy for Malaria Fevers, 480
- Abbe (Prof. C.), Insignificant Sequels of Forest Fires, 158; the Possibilities of Long-Range Weather Forecasts, 212
- Aberdeenshire Agricultural Research Association, 614
- Abery (Dr.), the Transmission of Yellow Fever, 300
- Abney (Capt. W. de W., C.B., F.R.S.), the Artificial Sun, 170; Top, 202
- Abnormal Atlantic Waves, C. E. Stromeyer, 437
- Aborigines of Australia, the, Dr. E. C. Stirling, 112
- Absoluteness of Motions of Rotation, the, Algebr. A. B. Bassett, F.R.S., 271; Prof. Oliver J. Lodge, F.R.S., 272
- Aburi (Gold Coast), Botanical Station, the, 423
- Acetylene and Oxygen, the Explosion of a Mixture of, Dr. T. E. Thorpe, F.R.S., 109
- Achromatic Object-Glass, the New, 169
- Acoustics: Acoustic Fog Signal and Navigation, A. B. Johnson, 130; Application of Sound-Vibrations to Analysis of two Gases of different Densities, E. Hanly, 497; Objective Reality of Combination Tones, Prof. A. W. Rucker, and E. Eiser, 550; Subjective Lowering of Pitch of Note, Dr. C. V. Burton, 550; Objective Demonstration of Combination Tones, Dr. C. V. Burton, 550; a Simplified Phonograph, A. K. Itzow, 588
- Acquired Characters: Right Hon. Sir Edward Fry, F.R.S., 8, 197; Prof. E. Ray Lankester, F.R.S., 54, 102, 245; Edward B. Poulton, F.R.S., 55, 126; Francis Galton, F.R.S., 50; J. T. Cunningham, 120, 293; John Cleland, 204
- Acton (E. Hamilton), Practical Physiology of Plants, 577
- Adams (Prof.), Collected Memoirs, 254
- Aeronautics: Lilienthal's Experiments in Flying, 177; Moynier's Experiments in Aerial Navigation, 259; Aeronautics in France, Prof. Cornu, 200; Balloon Ascent by S. Andree, Prof. H. A. Hazen, 325; Andree's North Pole Balloon Scheme, W. de Fonvielle, 421; the Andree Ballooning Expedition to the North Pole, 513; Aerial Navigation, 439; Remarkable Balloon Ascent by Dr. A. Berson, 491
- Æsthetic Tastes in Birds, 259
- Africa: Death of Dr. Lent, 18; Death of Dr. Kretschmar, 18; the Anglo-German Frontier Survey in East Africa, C. S. Smith, 19; Le Centre de l'Afrique, l'Autour du Tchad, P. Brauache, 20; Dr. Donaldson Smith's Expedition to Lake Rudolf, 61; British Central Africa Protectorate, H. H. Johnston, 66; Forestry in Natal, Prof. W. R. Fisher, 244; Return of Mr. G. F. S. Elliot, 208; How to live in Tropical Africa, J. Murray, 304; the Death of Emin Pasha, R. D. Mohun, 381; the Aburi Botanical Station, 423; the Glaciation of Mount Ruwenzori, Scott Elliot, 441; Mr. Scott Elliot's Explorations of Mount Ruwenzori, 527; Captain Manning's Ascent of Mount Manje, 441; Conspectus Floræ Africae, 441; Énumération des Plantes d'Afrique, Th. Danard et Hans Schinz, 459; Botanic Gardens in South Africa, 491
- Agamemnon (Dr.), the Alleged Diminution with Distance of Radiation of Velocity of Earthquake Waves, 269
- Age of the Earth, on the, Prof. John Perry, F.R.S., 224, 311, 382; Prof. F. Tait, 226; Lord Kelvin, F.R.S., 227, 458; Prof. W. J. Sollas, F.R.S., 533, 558; Dr. Bernard Hobson, 558; Dr. Alfred R. Wallace, F.R.S., 607; C. Davidson, 607
- Agriculture: a Dictionary of the Economic Products of India, George Watt, 4; W. T. Thiselton-Dyer, F.R.S., 150; Dr. A. Ball, F.R.S., 159; the Waulse Fly, W. E. Kirby, 154; Farm Vermin, Helpful and Harmful, 174; Out-growing Experiments, Prof. Kinch, 290; Death and Obituary Notice of Prof. Allen Harker, 209; Advanced Agriculture, H. J. Webb, 218; Canadian Experimental Farms, 237; the Royal Agricultural Society, 252; the Anarchy Law, Dr. J. P. F. W. Somerville, 251; the "Finger and Thumb" Disease, George Masee, 455; Foxtail Grass, Pest in America, 391; A Letter to Cultivators for Green Manures, P. P. Deherain, 311; Agricultural Art and Science, Prof. R. Warington, F.R.S., 372; Experiments with Dormant Seeds, Dr. A. Peter, 422; Horse-Breeding for Farmers, Alfred E. Pease, 435; Fertilizers, Pease, Eleanor A. Ormerod, 471; the Composition of Drainage Waters, P. P. Deherain, 576; the Department of Agriculture in the Leeward Islands, 613; Field Experiments in Wales, 614; Fertility and Degeneration of Ryegrass and possible Recovery, 614; Assimilable Nitrogen and its Transformations in Arable Land, M. Pagnoul, 622
- Aikman (C. M.), Air, Water, and Disinfectants, 412
- Air, the Weight of a Litre of, Prof. Memleben, 452
- Air and other Gases, Electrification of, Lord Kelvin, F.R.S., Magnus Moilan, and Alexander Galt, 405
- Air, Water, and Disinfectants, C. M. Aikman, 412
- Alaskan Frontier Survey, the, Mount Logan and Mount St. Elias, 19
- Algal Nitrogen Fixation, Rudolf Beer, 392
- Algal, the System of, M. Tassier, 328
- Algal Type, a New Variable Star of the, Dr. L. Harwig, 64
- Allen (H. N.), Energy Movement in Motion, separating Floating and Gravitating Particles, 310
- Almanac, the Nautical, 1898, 472
- Alpengluhen, das, Dr. J. Anslar, 340
- Alpine Climates for Consumption, H. J. Harwig, 53
- Altona Water-Supply, Bacteriological Investigation of the, Dr. Reinsch, 231
- Alshul (Dr.), Phosphorescence at very Low Temperature, 199, 200; Behaviour of Bodies at Critical Temperature, 137
- Amalitsky (Dr.), Comparison of Russian and African (Kerak) Permian Freshwater Shells, 569
- Amber, Chinese Theories of the Origin of, Kunigutsu, Mizuno, 204
- America: the Alaskan Frontier Survey, Mount Logan and Mount St. Elias, 19; Journal of the Academy of Natural Sciences of Philadelphia, 26; Travels among American Indians, from Ancient Earthworks and Temples, Vice-Admiral Libby Bibo, 20; American Meteorological Journal, 45, 142, 350, 451; American Journal of Mathematics, 49, 499; Bulletin of American Mathematical Society, 49, 167, 201, 439, 525, 573; a pre-Columbian Discovery of America, Yale Oldham, 83; American Journal of Science, 93, 199, 333, 439, 525, 619; American Museum of Natural History, 120; American Geography, A. Fowler, 274; the American Association, Dr. W. H. Hale, 300; Copper-sheathed Objects made by American Metallurgists of America, Prof. Putnam, and Mason, 404; Entomology in America, L. J. Howard, 499; American Soldiers and their Spinning Work, Dr. Henry C. M. Child, Rev. O. P. Cambridge, F.R.S., 505; American Freshwater Sponges in Ireland, Dr. R. Hamisch, 511; Public Libraries in America, 514
- Amphioxus, the Cranial Nerves of Vertebrates in, M. van Wijhe, 120
- Amphioxus and the Ancestry of the Vertebrates, Arthur Willey, 433
- Anslar (Dr. J.), Das Alpengluhen, 340
- Amsterdam Royal Academy of Sciences, 47, 119, 216, 497, 504, 625
- Anatomy: Death of Dr. Francesco Gasco, 35; Journal of Anatomy and Physiology, 93; the Life of Sir Richard Owen, 199; the Cerebral Commissures of the Mammalia, G. Elliot Smith, 102; a Peculiarity in the Mammalian Tooth, Dr. John Smith, 215; Lehrbuch der Vergleichenden Anatomie, Arnold



- Gibberne, 174; Obituary Notice of Dr. C. J. W. Peters, Father F. Denza, and A. C. Kinyard, 179; Secular Variations of the Interior Planets, Prof. Newcomb, 183; the Radcliffe Catalogue, 183; L'Astronomie, 183; the Lick Observatory, A. Fowler, 201; Advances in Lunar Photography, MM. Loewy and Paiseux, 207; Cometary Ephemerides, 207; Russian Astronomical Observations, 207; the Greater Nebula of Orion, Prof. E. L. Barnard, 253; Spectrum of the Orion Nebula, 471; the Orion Nebula, Prof. W. H. Pickering, 504; an Important Asteroid, M. Tisserand, 254; Collected Memoirs of Prof. Adams, 254; Doppler's Principle, Dr. Belopolsky, 233; the Astro-Physical Journal, 234; Elliptical Orbits, Mr. H. Larkin, 234; Elements of Astronomy, G. W. Parker, 270; Intercolonial Astronomy and Meteorology, 278; the Vatican Observatory, 282; an Indispensable Almanac, 282; the Unification of Civil and Astronomical Days, 282; the Planet Earth, an Astronomical Introduction to Geography, R. A. Gregory, 201; the Perseid Meteors, Dr. Brodhelm, 301; W. E. Denning, 320; Stars having Peculiar Spectra, Prof. E. C. Pickering, 302; Comet 1804 I. (Denning) and Brorsen's Comet, Dr. Hind, 302; Dr. E. Lamp, 302; the Identity of Denning's and Brorsen's Comets, 425; the Natal Observatory, Mr. Nevill, 327; the New Dudley Observatory, 327; the Milky Way, C. Easton, 327; the System of Algol, M. Tisserand, 328; Recent Work at Harvard College Observatory, Prof. E. C. Pickering, 320; New Stars and Nebulae, 347; the Designation of Comets, 347; the Mass of the Asteroids, B. M. Koszei, 373; the Variation of Latitude, 373; the Sun's Place in Nature, J. Norman Lockyer, C.B., F.R.S., 374, 399, 505, 506; the Zodiacal Light, Rear-Admiral J. P. Maclear, 301; Novel Methods in Photometry, Dr. Janssen, 305; Atmospheric Dispersion, Dr. Rambaut, 306; Hesper and Phosphor, Kumagata Minakata, 417; Origin of the Lunar Formations, M. Stanislas Meunier, 425;  $\gamma$  Cassiopeie, 425; the Story of the Stars, George F. Chambers, 430; Spectroscopic Measures of Planetary Velocities, M. Deslandres, 443; Eclipse of the Moon, 444; the Eclipse of the Moon, 472; the Nautical Almanac, 1808, 472; Observations on Sun-Spot Spectra, J. Norman Lockyer, F.R.S., 448; Photographic Measurement of Time, G. Lippmann, 455; Determination of Position of Pole by Photography, C. Flammarion, 455; a Few Chapters in Astronomy, Claudius Kennedy, 484; Partial Eclipse of the Sun, March 20, 403; Distribution of Minor Planets, General Parmentier, 403; the Royal Observatory, Edinburgh, 403; Stoney's Local Heliostat and Improved Siderostat, 500; Astronomische Chronologie, Walter F. Wislicenus, 500; Argon in Nebulae, Dr. B. Brauner, 513; the Moon and Atmospheric Waves, Bouquet de la Grye, 510; Stellar Photography, 516; Standard Time in Australia, 516; Nova Aurige, 516; a Possible New Satellite of Neptune, Prof. Schaeberle, 542; the Diameter of Neptune, Prof. Barnard, 617; Improvements in Photometry, 558; Death of Theodor Brorsen, 501; the Lyrid Meteors, 564; a New Form of Zenith Telescope, Louis Fabry, 564; Lunar River Beds and Variable Spots, Prof. W. H. Pickering, 580; the Ultra-Violet Spectrum of the Corona, 580; M. Deslandres' Stellar Parallaxes, T. Lewis, 580; Astronomical Coordinates referred to Astronomical and Geographical Poles, respectively compared, Ch. Lagrange, 620
- Atkinson (Rev. J. C.), Memorials of Old Whithy, 149
- Atlantic Waves, Abnormal, C. E. Stromeyer, 437
- Atmosphere, the New Constituent of the, Lord Rayleigh, Sec. R.S., and Prof. William Ramsay, F.R.S., 347
- Atmospheric Dispersion, Dr. Rambaut, 306
- Atmospheric Waves, the Moon and, M. Bouquet de la Grye, 516
- Atoll, Studies of a Growing, Dr. Hugh Robert Mill, 203
- Attitudes, Instinctive, S. S. Buckman, 31
- Aubertin (J. J.), "By Order of the Sun to Chile to see his Total Eclipse, April 16, 1893," 101
- Auk, Great, Sale of Specimen of, 613
- Auk, the Little, Invasion of North and North-East Coasts by, J. E. Harting, 422
- Aurora: Aurora of November 23, J. Shaw, 107; Prof. A. S. Herschel, F.R.S., 246, 300; W. H. Wood, 300; Les Aurores Polaires, Alfred Angot, 484; Aurora of March 13, 517; the Recent Auroral Phenomena, James G. Richmond, 581
- Australia, the Aborigines of, Dr. E. C. Stirling, 112; the Province of South Australia, J. D. Woods, 221; the Horn Expedition to Central Australia, Prof. Baldwin Spencer, 222
- Meteorological Work in Australia, Sir C. Todd, F.R.S., 220
- Standard Time in, 316
- Austria-Hungary, Earthquake in, 587
- Aventurine Glass, H. S. Washington, 112
- Avogadro's Rule, and Thermodynamics, Theoretical Chemistry, from the Standpoint of, Prof. Walter Nernst, M. M. Perrin and Muir, 530
- Ayrton (Prof.), Student's Apparatus for Verifying Ohm's Law, 142; Student's Apparatus for Determining Mechanical Equivalent of Heat, 239; Tests of Glow Lamps, 239, 358
- Bach (A.), New Reagent allowing Demonstration of Presence of Hydrogen in Green Plants, 240
- Bacillus (*Citri-vitæ*), a New Anthrax, A. Chauveau and C. Phisalix, 622
- Bäcklund (Dr. O.), Ephemeris of Encke's Comet, 85
- Bacteriology: the Treatment of Diphtheria by Anti-Toxin Serum, Dr. M. A. Ritter, 16; Dr. G. S. Woodhead, 402, 425; Relative Efficiency of Water-Filters, Surgeon-Major Johnstone, 38; Reduction of Sulphates by Specific Sulphide Ferments, M. Beyersbeck, 47; Action of High Pressures on Bacteria, H. Roger, 168; the Disinfection of Fecal Matter by Copper Sulphate, H. Vincent, 168; Bacteriological Institute (the established at Kiev University, 260; Investigation of the Art of Water Supply, Dr. Keinsch, 231; Death of Dr. Josef Schröter, 251; Nitrogen Fixation in Algae, Rudolf Beer, 302; the Harmlessness of Sewer Air, Messrs. Laws and Andrews, 371; Oysters and Typhoid, 301; Mrs. Percy Frankland, 415; Lehrbuch der Bakteriologischen Untersuchung und Diagnostik, Dr. Ludwig Heim, Mrs. Percy Frankland, 481; Conditions limiting Bacterial Life in Thames Water, Dr. F. Frankland, F.R.S., 500; a New Anthrax Bacillus (*Citri-vitæ*), A. Chauveau and C. Phisalix, 622
- Baker (J. L.) Action of Diastase on Starch, 350
- Baker (R. T.), New Isopogon from New South Wales, 192
- Balances, Improvements in Sensitive, W. H. P. Kuhlmann and Dr. Classen, 540
- Ball (Sir Robert, F.R.S.), the Possibility of Life in other Worlds, 44
- Ball (Dr. A.), F.R.S.), Dr. Warts' Dictionary of the Teosinte Products of India, 150
- Balloon Ascent by Dr. A. Borsen, Remarkable, 401
- Ballore (M. de Montessus de), the Frequency of Earthquakes, 540
- Baldy (E. C. C.), Possible Explanation of Two-fold Spectra of Oxygen and Nitrogen, 550
- Baratta (Dr. M.), the Sicilian Earthquakes of August 1894, 207; Seismic History of *Calabria ulima*, 408
- Barber (Rev. Samuel), a White Rainbow, 274
- Baring Gault (S.), the Deserts of Southern France; an Introduction to the Limestone and Chalk Plateaux of Ancient Aquitaine, Canon Bonney, F.R.S., 100
- Barlow (Wm.), Homogeneity of Structure the Source of Crystal Symmetry, 58
- Barnard (Prof. E. L.), Recent Observations of Jupiter, 85; the Greater Nebula of Orion, 253; the Apparent Diameters of Mercury, 373; the Diameter of Neptune, 617
- Barometer, the Invention of the, Prof. G. Hellmann, 422
- Barrenness of Pre-Cambrian Rocks, the, Dr. C. Callaway, 402
- Bartoli (Prof. A.), Determinations of Absorption of Solar Radiation by Fog and Cirrus Cloud, 180; Solar Heat intercepted by Volcanic Dust, 270
- Barus (Carl), a Simple Chronograph Pendulum, 84; Colloidal Silver, 100
- Bischoff (Rev. F.), the Measurement of Pressures in Guns, 401
- Bisset (A. B.), F.R.S.), Discontinuous Motion, 11; the Alleged Absoluteness of Motions of Rotation, 271
- Bites in (W.), F.R.S.), the Origin of the Cultivated Cineraria, 605
- Bateson's Theory of Organic Evolution, Reason of Failure of, Dr. A. R. Wallace, 450
- Battandier (M.), Reactions of Chelidonium with Phenols in Sulphuric Solution, 384
- Battle of the Forests, the, Prof. B. F. Fernow, 116, 130
- Baugny (H.), Antimony Vermilion not an Oxysulphide, 24
- Bauer (L. A.), Wille's Theory of the Secular Variation of Terrestrial Magnetism, 103; some Early Terrestrial Magnetic Discoveries pertaining to England, Will Whiston, 205; Secular Changes of Terrestrial Magnetism, 431; the Secular Variation of Terrestrial Magnetism, 401

- Boyer (Dr. H.), D., Resultate der Aetzmethode in der Krystall-graphischer-Forschung, an einer Reihe von krystallisierten Körpern dargestellt, 340
- Boyer (E. C.), the Frost of January and February 1895, 621
- Boyer's (H.), Photographs, Researches, W. H. Harrison, 299
- Boyer (Dr.), New Element in the Nitrogen Group discovered by, 258
- Boyer, Feeling of, in Birds, 250
- Boyle (C. Raymond), Prince Henry the Navigator, 532
- Boyer (F. E., F.R.S.), the Visceral Anatomy of Ornithorhynchus, 101
- Boyer (C. F.), Trinititeus, 610
- Boyer, Knoddt, Nitrogen Fixation in Algae, 342
- Boyer, December, a Swarm of, 230
- Boyerham (A. W., F.R.S.), Death of, 488
- Boyerham, Bulletin de l'Académie Royale, 19, 20, 167, 477, 623
- Boyerham's, the Telegraphist's Guide, 484
- Boyerholtsky (M. A.), the Spectrum of  $\delta$  Cephei, 21, 282; Doppler's Principle, 234
- Boyer (Dr.), Influence of Sterilisation on Digestibility of Milk, 69
- Boyer, Journal of Asiatic Society of, 530
- Boyerham (C. F.), an Artificial Spectrum, 1, 113, 269, 321; Prof. Lyving, 107
- Boyerham (Alfred W.), on Planting of Timber Trees, 35
- Boyerham (W. H.), Metallurgy, Laetia, Vol. 529
- Boyerham (Earl of), Accurate Method of determining Densities of Solids, 431
- Böhm, Meteorological Society, 72, 102, 431, 503, 623
- Böhm Physical Society, 90, 198, 101, 288, 431, 503, 623
- Böhm, Physiological Society, 96, 192, 210, 288, 312, 431, 503, 623
- Boyer and Ayres, Field, Communication opened between, 129
- Boyer, M., Theory of Action of Currents of High Frequency, 528
- Boyer (H. M.), on Spinning Gland in Phyrus, 203; Comparative Morphology of *Orithya*, 455
- Boyer (M.), Principles in Plants capable of Condensation with Production of Carbonic Acid, 40; Argon, 384; Attempts to produce Chemical Combinations with Argon, 527; the Spectrum of Argon and of the Aurora Borealis, 552; Alumina in Plants, 407; Fluorescence Spectrum of Argon, 622; Booyerholts, 586
- Boyer (Dr.), New Method of Temperature measurement, 622
- Boyer (G.), Peat and Peat Fermentation, 101, 312
- Boyer (A.), Carbonyl Chloro Bromide and Dibromide, 359
- Boyer (M.), Reduction of Sulphates by Specific Sulphide Elements, 47
- Boyer (Dr.), Cause of Damage by Lightning, 20; Cause of the Effects of Atmosphere before Thunderstorms, 53
- Boyer (Dr.), Dr. Prout, 143
- Boyer, Sir, Successor of, William L. Plummer, 272
- Boyer (Dr. W.), Entomophysiology, Prof. J. Burdon Sanderson, F.R.S., 353
- Boyer (J. H.), Fluctuations of Temperatures in 2608 Day Solar Magnetism, 199; Solar Magnetism in Meteorology, 359
- Boyer, Absolute Electrodynamics, Calculations of Ions in Electrolytic Cells, F.R.S., 75
- Boyer, No. A. (Dr.), Francis A. Wollay, 23; the Present State of Entomology, 1894, 58; Report by Prof. Boyer, *Ann. Bur. Entom.*, 61; Biology in the United States, A. French, Sr., O. H. Silliman, P. Chalmers Mitchell, H. G. Wells, 195; Biological Lectures and Addresses delivered at the Arthur Mills Marshall, F.R.S., 217; *Ann. Bur. Entom.*, 61; *Bull. Geol. Surv.*, Dr. Oscar Hertwig, G. C. Beane, 265; *Ann. Bur. Entom.*, 278; Biological Station established in North Carolina, 422; Influence of Temperature of Dipsosaurus on Animals of Plants, Dr. C. H. Merriam, 441; *Bull. Geol. Surv.*, Illinois River, 504; Marine Biology of Living Corals, Dr. Osborn, 20; *Entomol. Soc. Trans.*, Hertwig, 30; *Ann. Bur. Entom.*, 83; *Dr. Prout's Physical Investigations in Entomology*, Sanderson, 115; Effects of Compression on Segmentation of *Scolopend. Fagin*, Dr. A. Grant, 157; *Entomol. Soc. Trans.*, Vol. 1, W. L. Chubb, 213; *Hermaphrodite*, Muller, Dr. P. L. Johnson, 213; the Development of *Hexagram. Mel.*, Dr. H. Hyde, 231; *The Entomologist's Magazine*, Prof. Johannes Wulther, 260; the Port Erin Station, Prof. Herdman, 281; Effect on Environment on Development of Echinoderm Larvae, H. M. Vernon, 454; Comparative Morphology of *Galathea*, H. M. Bernard, 455; Role of Annelids in Annelids, E. G. Kacovitz, 455; the Brooklyn Summer School, 537
- Bird-Winged Butterflies of the East, the, W. F. Kirby, 254; Robert H. F. Rippon, 343
- Birds, the Crommellin Collection of Dutch, 18; the Nests and Eggs of Non-indigenous British Birds, Charles Dixon, 30; the Wind and the Flight of Birds, Profs. Langley and Curtis, 150; Birds of the Wave and Woodland, Phil Robinson, 243; the Tongue and Hyoid Apparatus of Birds, Herr Schenkling-Brevot, 252; Feeling of Beauty in, 250; British Birds, Claude W. Wyatte, 318; Summer Studies of Birds and Books, W. Warde Fowler, 341; Forest Birds, their Haunts and Habits, Harry F. Witherby, 341; the Birds of Eastern Pennsylvania and New Jersey, 458; Bird Notes, Jane Mary Hayward, 532; Catalogue of the Birds of Frey (Accipitres and Striges), J. H. Gurney, 532
- Birmingham, Strassburg, and Nicolaw, on a Remarkable Earthquake Disturbance observed on June 3, 1893, C. Davison, Dr. E. von Reuep Paschwitz, 203
- Bischoff (Dr. C. A.), Handbuch der Stereochemie, 490
- Bjerknes (A.), Different Forms of Multiple Resonance, 357
- Black-Damp, Dr. John Haldane, 477
- Black-Veined White Butterfly, the, W. Warde Fowler, 307
- Blackman (F. L.), New Method for investigating Carbonic Acid Exchanges of Plants, 238; Paths of Gaseous Exchange between Aerial Leaves and Atmosphere, 238
- Blake (J. E.), Annals of British Geology, 1893, 557
- Blanford (Dr. W. E., F.R.S.), the Barmese Chipped Flints, Pliocene not Miocene, 608
- Blass (E.), Do Plants assimilate Argon? 491
- Blindfold Chess-Players, Psychology of Mental Arithmeticians and, Alfred Binet, Francis Galton, F.R.S., 73
- Blue Grotto of Capri Spectroscopically Tested, Dr. H. W. Vogel, 300
- Blythe (W. H.), Model of the 27 lines on a Cubic Surface, 95
- Boek (A.), Ratio between Lateral Contraction and Longitudinal Dilatation in Magnetised Iron Rods, 612
- Boernstein (Prof.), Influence of Polarisation on Outflow of Negative Electricity caused by Light, 60
- Boiler Explosions, W. H. Fowler, 345
- Boiler Explosions, Kitchen, R. D. Munro, 107
- Boiler Shells, Drilling Machines for, Samuel Dixon, 22
- Boisbaudran (Leopold), Atomic Weights, 432
- Boltzmann (Prof.) and the Kinetic Theory of Gases, 413, 581; G. H. Bryan, 31; Edward P. Culverwell, 581; Boltzmann's Minimum Function, S. H. Burbury, F.R.S., 78, 320; Boltzmann's Minimum Theorem, Rev. H. W. Watson, F.R.S., 105; Edward P. Culverwell, 105, 240
- Bone (W. A.), Incomplete Combustion of some Gaseous Carbon Compounds, 143
- Bonney (Canon, F.R.S.), the Deserts of Southern France, an Introduction to the Limestone and Chalk Plateaux of Ancient Aquitaine, S. J. Barrow-Gould, 100; Les Abîmes, les eaux souterraines, les Cavernes, les Sources, la Spelologie, L. A. Martel, 410
- Boyers (Dr. W.), the Relation of Energy of Combination to Electrical Energy, 141
- Boyd (E.), Chemical Process for Purification of Water, 552
- Botany, Deal, of Dr. Lent, 18; Nuovo Giornale Botanico Italiano, 23; the Mechanism of Vegetable Respiration, L. Maquenne, 20; Death of Prof. M. Duchartre, 35; Sauer's Rhodologia, 34; Principles in Plants capable of Condensation with Production of Carbonic Acid, M. Berthelot and G. André, 36; Index kewensis Plantarum Phanerogamarum, Sumptibus Beatr. Carol. Robert. Duxon ductu et consilio Josephi D. Hooker, comitibus B. Daydon Jackson, Fasciculus III, 54; Hydropnism, Dr. W. Robert, 84; the New Cypress of Nyasaland, 85; the Ascent of Sap, H. H. Dixon and Dr. J. Joly, F.R.S., 93; the Soaking of Seeds, P. C. Ghubb, 107; the Centropheres of Plant Nuclei, Leon Guignard, 113; the Bang Plant, Dr. Prout, 143; New Isopogon from New South Wales, R. T. Baker, 192; New South Wales Linnean Society, 192, 204; Additions to British Museum Herbarium, 206; a New Revision of the *Dipterocarpaceae*, Sir D. Brandis, 214; the Fertilisation of *Tranthus leucostamus* and *L. ibe.*, M. M. S. Evans, 235; New Method for Investigating Carbonic Acid Exchanges of Plants, F. E. Blackman, 238; Paths of Gaseous Exchange between Aerial Leaves

- and Atmosphere, F. F. Blackman, 238; Death of Dr. J. G. Brinton, 251; Monocotyledonous Saprophytes, Percy Groom, 263; Remarkable Oak Trees in Essex, J. C. Shenstone, 280; Death of Dr. Flückiger, 208; Foxtail Grass Pest in America, 301; Nitrogen Fixations in Algae, Rudolf Beer, 302; Development of Sieve-tubes in Angiosperms, M. Chauveaud, 330; Lehrbuch der Botanik, Drs. E. Strasburger, F. Noll, H. Schenck, and A. F. W. Schimper, 330; Obituary Notice of Pierre Duchartre, 344; Variations in Number of Stamens and Carpels, L. H. Burkill, 350; Variation in Floral Symmetry of *Potentilla tormentilla*, A. G. Tansley and E. Dale, 350; Death of Marquis de Saporta, 370; Death of Dr. F. Schmitz, 392; Obituary Notice of Nathanael Pringsheim, D. H. Scott, 399; Alumina in Plants, M. Berthelot and Andre, 407; Volatile Constituents of Coca Leaves, Dr. P. von Romburgh, 408; Bulletin of the Botanical Department, Jamaica, 412; Experiments with Dormant Seeds, Dr. A. Peter, 422; the Aburi Gold Coast Station, 423; Journal of Botany, 23, 430; the Finger and Toe Disease, Geo. Massee, 453; Conspectus Floræ Africae ou Enumeration des Plantes d'Afrique, Th. Durand et Hans Schinz, 459; Variation in *Caltha palustris*, Prof. T. D. A. Cockerell, 487; Addition to Kew Gardens, 489; Botanic Gardens in South Africa, 491; Botanical Expedition to Asia Minor, W. Sieber, 513; Green Glass in Plane-Houses, 514; Cassava as Food, H. W. Wiley, 515; Death of Isaac Sprague, 538; Death of A. G. Meyer, 538; Polyembryony, M. Tretjakow, 540; Polyembryony, Frank J. Cole, 558; a Popular Treatise on the Physiology of Plants, Dr. Paul Sorauer, 554; the Terminal Flower in *Cypripedium*, C. B. Clarke, 575; a Monograph of the Mycetozoa, being a Descriptive Catalogue of the Species in the British Museum, Arthur Lister, 603; the Origin of the Cultivated Cineraria, W. Bateson, F.R.S., 605
- Boulliau (Ismael), First Mercury Thermometer used by, Abbe Maze, 576
- Bourne (G. C.), Zeit- und Streitfragen der Biologie, Prof. Dr. Oscar Hertwig, 265
- Bovey (Dr. H.), Experiments on Strength of Canadian Timber, 402
- Brackett (S. H.), Magnetic Properties of Iridium, 158
- Brady (G. Stewardson), the Natural History of the Selway, 322
- Brandis (Sir D.), a New Revision of the Dipteroptera, 214
- Brauner (Dr. B.), Argon in Nebula, 513; Atomic Weight of Tellurium, 620
- Brazil, the New Capital of, H. Faye, 500
- Bredichin (Dr.), the Perseid Meteors, 301
- Briggs (William), a Text-book of Dynamics, a Text-book of Statics, 76; an Elementary Text-book of Hydrostatics, 509
- Brigham, (R. P.), Drift Boulders between Mohawk and Susquehanna Rivers, 525
- Brightmore (A. W.), the Principles of Waterworks Engineering, J. H. Tinsley-Turner, 146
- Brine (Vice-Admiral Lindsay), Travels among American Indians, their Ancient Earthworks and Temples, 26
- Brinton (Dr. J. G.), Death of, 251
- Britain, Twenty-five Years of Geological Progress in, Sir Archibald Geikie, F.R.S., 367; a History of Epidemics in, Dr. Chas. Creighton, 579
- British Birds, the Nests and Eggs of Non-Indigenous, Charles Dixon, 30
- British Birds, Claude W. Wyatt, 318
- British Butterflies and Moths, W. Turneaux and W. F. Kirby, 339
- British Central Africa Protectorate, H. H. Johnstone, 66
- British Museum Herbarium, Additions to, 206
- British Museum, a Monograph of the Mycetozoa, being a Descriptive Catalogue of the Species in the, Arthur Lister, 603
- British Races, Early, Dr. E. G. Garson, 67, 99
- Braehet (A.), Action of Chlorine on Secondary Alcohols, 264; Action of Formaldehyde on Ammoniacal Salts, 503
- Brooke (Sir Victor), Sportsman and Naturalist, O. L. Stephen, 76
- Brooker (A.), Electrical Engineering, 318; Problems and Solutions in Elementary Electricity and Magnetism, 589
- Brooklyn Summer School of Marine Biology, 537
- Brooks (Prof. W. K.), the Fauna of the Lower Cambrian, 423
- Brosen (Theodor), Death of, 501
- Brosen's Comet, Comet 1804 I. (Denning) and, Dr. Hind, 302; Dr. E. Lamp, 362
- Brosen's Comets, the Discovery of Denning and, 425
- Brown (Addison), Endowment for Scientific Research and Publication, 164, 186
- Bruce (L. C.), Dual Brain Action, 441
- Brunache (P.), Le Centre de l'Afrique; A tout du Tchad, 29
- Branhes (Prof. Julien), Death of, 488
- Bryan (M. Loby de), Isolation of Free Hydrazine, N<sub>2</sub>H<sub>4</sub>, 544
- Bryan (G. H.), Prof. Boltzmann and the Kinetic Theory of Gases, 31, 152, 170, 319; a Text-book of Dynamics, a Text-book of Statics, 76; Maxwell's Law of Partition of Energy, 262; Mechanical Analogue of Thermal Equilibrium between Bodies in Contact, 454; an Elementary Text book of Hydrostatics, 509
- Buchanan (J. Y., F.R.S.), on the Use of the Globe in the Study of Crystallography, 184; the Relative Densities, &c., of Atlantic and Mediterranean Waters, 468
- Buckland (William, D.D., F.R.S.), the London Correspondence of, Mrs. Gordon, 457
- Buckman (S. S.), Instinctive Attitudes, 31
- Bulletin de l'Academie Royale de Belgique, 46, 167, 477, 629
- Bulletin de l'Academie Royale de St. Petersburg, 477
- Bulletin of American Mathematical Society, 46, 167, 261, 439, 525, 573
- Bulletin de la Société de Naturalistes de Monaco, 334, 357
- Bunbury (Sir Edward), Death of, 468
- Burbury (S. H., F.R.S.), Boltzmann's Minimum Function, 58, 320; the Ratio of the Specific Heats of Gases, 127; the Kinetic Theory of Gases, 175
- Burkill (L. H.), Variations in Number of Stamens and Carpels, 350
- Burmese Chipped Flints, the, Pliocene to Miocene, Dr. W. T. Blanford, F.R.S., 608
- Barnside (Prof. W., F.R.S.), the Theory of Groups of Finite Order, iii, and iv., 478
- Burrows (W. H.), Methylisobutylic Acid, 526
- Burton (Dr. C. V.), Subjective Lowering of Pitch of Note, 530; Objective Demonstration of Combination Tones, 559
- Burton (W. K.), the Water Supply of Towns, 146
- Butler (Gerard W.), Death-tugging in Snakes, 153
- Butterflies: Butterflies from China, Japan, and Corea, John Henry Leech, 61; the Owl-Wing Butterfly of the East, W. F. Kirby, 254; Robert H. F. Knyon, 343; Butterflies and Moths (British), W. Furness and W. F. Kirby, 339; the Black-Veined White Butterfly, W. Waide Fowler, 367; H. Goss, 391; Geographical Distribution of Butterflies, Prof. Meldola, Dr. Sharp, F.R.S., and Mr. McLachlan, F.R.S., 478; New Indo-Malayan Butterflies, Lucie Niccville, 500
- Cailletet (L.), the Condensation of Electrolytic Gases by Means of Platinum Group, 95, 113
- Cain (J. C.), Incomplete Combustion of some Gaseous Carbon Compounds, 143
- Calabria Ultra, Seismic History of, Dr. Mario Baratta, 468
- Calderwood (W. L.), Muscle Culture and the Rait Supply, 578
- California, the Mountains of, John Muir, 125
- Callaway (Dr. C.), the Barrenness of Pre-Cambrian Rocks, 462
- Calman (H. T.), Julina, New Antarctic Compound Acidian, 213
- Caltha palustris*, Variation in, Prof. T. D. A. Cockerell, 487
- Cambier (R.), Action of Formaldehyde on Ammoniacal Salts, 503
- Cambridge Philosophical Society, 95, 110, 167, 407, 431, 489
- Cambridge (Rev. O. P., F.R.S.), American Spiders and their Spinning Work; a Natural History of the Orb-Weaving Spiders of the United States, with special regard to their Industry and Habits, Dr. Henry C. McCook, 505
- Camerer (R.), Total Reflection of Light in Dense Crystalline Substances, 357
- Cameron (Jas.), Cod-liver Oil and Chemistry, F. Peckell Moller, 508
- Camerton Explosion, Coal-dust an Explosive Agent, as shown by an Examination of the, Donald M. D. Stuart, 208
- Campbell (Mr.), the Supposed Magnetic Fatigue, 614
- Campbell (Prof. W. W.), the Spectrum of Mars, 132; the Satchlites of Mars, 443
- Canada: Scientific Investigation in Canada, Dr. G. M. Daws on, F.R.S., 236; Canadian Geological Survey, 230; Canadian Meteorological Service, 237; Canadian Experimental Farms, 237; Experiments on Strength of Canadian Timber, Dr. H. Berry, 402
- Caneani (Dr. A.), the Constantinople Earthquake of July 1, 1804, 440

- Catalysis, S. P. H. 1st ed., 321; Baron C. R. Osten Sacken, 322; J. S. Holland, 511
- Catalytic Heat, F. H. Griffiths, 11
- Catalytic Properties of Testol, the Blue Gout of, Dr. H. W. Vogel, 306
- Catalytic Properties of Specific Heat in Comp. and Gases, 452
- Catalysis, the Accretion of, Henri Moissan, 71
- Cave, Major, Probable Cause of St. Pancras Explosion, 440; the "Lion" Electric Light" Man Accidents, 530; Report on St. Pancras Bridge Explosion, 614
- Cave, H. H., Aryl Derivatives of Benzazone and Adonitine, 25
- Cave, Wilson, Cecilia, Cleaning Tobacco Pipes, 511
- Cavillat, L., the Laws of Crystalline Absorption, 455
- Casseras Food, H. W. Wiley, 515
- Cassiopeia, 7, 425
- Caswell Construction Company's Works at Niagara, Progress of, 100, 100
- Cass, M., Marey's Photographs of a Tumbling, 80
- Cass, Movement in order to Fall on their Feet made by, M. Marey, 47
- Cassiopeia, a Text-book of Sound, 244
- Cellular Free-plaque, in Jomina and Hong Kong, 231
- Cellular, the Electrostatic Capacity of Resistance Bobbins, 407; Electrostatic Capacity of Resistance Coils, 442
- Ceres, Chinese Beliefs about, Kumagata Minakata, 57
- Ceres, Cows' Key by Arabs, Colonel A. T. Fraser, 325
- Ceres and Swallow Holes, E. A. Martel, Canon T. G. Bonney, F.R.S., 416
- Ceroids (L.) Remains of Sponges in *Phanites* of Pre-Cambrian in Brittany, 384; Mineralogical Composition of Silex of Paris Gypsum, 432
- Ceryle, Prof. Arthur, F.R.S., Death and Obituary Notice of, 323; *Fauna* list, 311
- Ceryle, Henry, an Observation on Moths, 127
- Ceryle, Entomology, Photomicrographic Method of Studying, C. B. Moore, Dr. C. L. Leonard, 341
- Ceryle, Physiology, 50
- Ceryle Magazine, Science in, 250, 380
- Ceryle, the Spectrum of, M. A. Belopolsky, 21, 282
- Ceryle, the Dawn of Civilisation, G. Maspero, 122
- Ceryle, George, the Story of the Stars, 430
- Ceryle's Journal, Science in, 250
- Ceryle, H. J., English Weights and Measures, 422
- Ceryle, the, Foraminifera from Arabian Sea, 311
- Ceryle, Agnes, Right Hon. Sir Edw. Fry, F.R.S., 8, 147; Prof. F. Kay-Lankester, F.R.S., 54, 102, 245; Edward B. Faulstich, F.R.S., 55, 120; Francis Galton, F.R.S., 50; J. E. Clinton, 120, 203; John Cleland, 204
- Ceryle, G. B. R. Steel, 330; *Leyons de Chimie*, 450
- Ceryle, A. J., New Anthrax Bacillus *C. anthracis*, 622
- Ceryle, M., Development of *Stycolites* in Angiosperms, 330
- Ceryle, H. J., Ethereal Salts derived from Active Amyl Alcohol, 144
- Ceryle, a New Method of Preparing Phosphoretted Hydrogen, Prof. E. G. G. 23; Study of Combination of Hydrogen Cyanide with Water, R. Metzner, 24; Researches on Phosphoric Sulphates, Louis Varet, 24; Antimony Vermilion Cyan Oxysulphide, H. Baudouin, 24; Dr. Watt's Dictionary of Chemistry, M. M. Pearson Muir and H. Foster Morley, 27; Carbazide and Dione, Prof. Curtius and Herr Heidenreich, 30; Reduction of Sulphates by Specific Sulphide Element, M. Beveridge, 47; a Text-book of Inorganic Chemistry, G. S. Newell, M. M. Pattison Muir, 52; Newell's Inorganic Chemistry, G. S. Newell, 100; M. M. Pattison Muir, 17; Effects of Cathode Rays on Colour of Certain Salts, Prof. Goldstein, 62, 406; the Properties of Liquid Ethane and Ethylene, A. E. Tutton, 65; Researches on Mineral Nitrates, Louis Varet, 72; Dimer of Explosive Mixtures of Acetylene and Oxygen, Prof. F. Meyer, 84; the Explosion of a Mixture of Acetylene and Oxygen, Dr. F. E. Thorpe, F.R.S., 100; the Properties of Gaseous Glass Vessels, Prof. H. B. Dixon, F.R.S., 15; the Use of Carbon Disulphide of Lin, Dr. Schmidt, 85; New Method of Preparing Phosphorochlorides, M. C. Lea, 93; Active Acetylene, A. E. Wolf, 95; the Oxidation of Alcohols by Dehydrogenation, F. Goud, 96; a New Series of Nitrogen Compounds, Prof. A. Beckman and Herr Runge, 114; a new Method of Preparing Nitrogen Comp., A. E. Tutton, 258; Study of Acetylene Nitrogen, H. van Eep, 419; Liquid Sulphuretted Hydrogen, Preparation of Chlorides of Carbon during pre-paration of Carbon Tetrachloride, Prof. V. Meyer, 131; Re-determination of Atomic Weights of Bismuth, Prof. Schneider, 131; the Relation of Energy of Combination to Electrical Energy, Dr. W. Borchers, 141; the Chemical Society, 143, 239, 310, 430, 454, 520, 620; the Proceedings of the Chemical Society, Prof. William Ramsay, F.R.S., 204; the Anniversary of the Chemical Society, 534; Dr. Armstrong's Address, 535; a Product of Action of Nitric Oxide on Sodium Ethylate, G. W. Macdonald and O. Masson, 143; Incomplete Combustion of some Gaseous Carbon Compounds, W. A. Bone and J. C. Cann, 143; Homologues of Butanetetracarboxylic Acid and Adipic Acid, B. Leam, 143; Cellulose Sulphuric Acid, A. L. Stern, 143; Condensation of Benzil with Ethyl Malonate, F. R. Japp and W. B. Davidson, 143; the Conversion of Lactic Acid into Propionic Acid, Fernand Gaud, 144; the Ethereal Salts derived from Active Amyl Alcohol, P. A. Guye and L. Chavanne, 144; the so-called Organic Chlorine of the Gastric Juice, H. Lescour, 144; the Conversion of Black Mercury Sulphide with Red Sulphide, W. Spring, 167; Reduction of Alumina by Carbon, Henri Moissan, 167; Solubility of Ozone, Abbé Maillfert, 168; Superposition of Optical Effects of Different Asymmetric Carbon Atoms in same Active Molecule, P. A. Guye and M. Gautier, 168; Isolation of Anhydrous Hydrogen Peroxide, Dr. Wolfenstein, 182; Colloidal Silver, C. Barus, 100; the Varieties of Graphite, Henri Moissan, 191; Pectase and Pectic Fermentation, G. Bertrand and A. Malleve, 191; a Treatise on Chemistry, Sir H. E. Rose, F.R.S., and C. Schorlemmer, M. M. Pattison Muir, 193; Phosphorescence at very Low Temperatures, MM. Raoul Pietet and Altschul, 200; Displacement of Carbon by Boron or Silicon in Fused Cast Iron, Henri Moissan, 240; the Chromates of Iron, Charles Leprieux, 240; New Reagent allowing Demonstration of Presence of Hydrogen in Green Plants, A. Baeh, 240; Valency of Glucinum (Beryllium) and Formula of Glucina, Alph-Combes, 240; Study of Iron Graphites, Henri Moissan, 263; Calcium Ethoxide, M. de Forcrand, 263;  $\beta$ -Oxycinchonine, E. Jungfleisch and E. Léger, 264; Action of Chlorine on Secondary Alcohols, A. Brochet, 264; Physiological Properties of Oxalate and Crystalline Salts of Nicotine, H. Parenty and E. Grasset, 264; Elementary Qualitative Chemical Analysis, Prof. Frank Cowles and J. B. Coleman, 270; Tables and Directions for the Qualitative Chemical Analysis of Moderately Complex Mixtures of Salts, M. M. Pattison Muir, 270; Laboratory Exercise Book for Chemical Students, E. Francis, 270; the Atomic Weights of Nickel and Cobalt, Prof. Winkler, 281; Preparation of Graphites Poissonants, Henri Moissan, 287; Qualitative Separation of Nickel and Cobalt, A. Villiers, 288; Inorganic Mode of Preparing Hydrazine, Dr. Duden, 301; Compound of Grape Sugar with Acid Radicle of Hydrazine, Herr Struve, 305; New Compounds of Hydrazine with Fatty Acids, A. E. Tutton, 516; Isolation of Free Hydrazine, N<sub>2</sub>H<sub>4</sub>, M. Lohy de Bruyn, A. E. Tutton, 544; the Commercial Synthesis of Illuminating Hydrocarbons, Prof. Vivian E. Lewes, 303; Chemical Changes between Sea-Water and Organic Deposits, Dr. John Murray and Robert Irvine, 304; Pellitorine and Piperovatine, W. R. Dunstan and H. Gamett, 310; Adipic Acid and Derivatives, W. H. Ince, 311; Action of Hydrogen Chloride on Quicklime, Magnesia, and Bayta, W. H. Veley, 311; Metallic Tartrates, G. G. Henderson and A. R. Ewing, 311; Preparation of Amorphous Silicon, M. Vigoureux, 312; Pectase and Pectic Fermentation, G. Bertrand and A. Malleve, 312; the Rise and Development of Organic Chemistry, Carl Schorlemmer, 317; the Explosive Nature of the Sodium and Potassium Derivatives of Nitromethane, A. E. Tutton, 328; the Production of the Glycolitic Ferment, R. Lepine, 330; Failure of Kjeldahl Method for Estimation of Nitrogen when applied to Chloroplatimates, M. Delepine, 336; a new System of Anthracene, M. Delecre, 339; Argon, 323, 337; Argon, M. Berthelot, 384; Argon, Dr. J. H. Gladstone, F.R.S., 380; Prof. Mendeleef, on Argon, 543; the New Constituent of the Atmosphere, Argon, Lord Rayleigh, Soc. R.S., and Prof. William Ramsay, F.R.S., 317; on the Spectra of Argon, William Crookes, F.R.S., 354; H. E. Newall, 454; Fluorescence Spectrum of Argon, M. Berthelot, 622; the Liquefaction and Solidification of Argon, Dr. K. Olszewski, 355; Do Plants assimilate Argon?, F. Blass, 401; Prof. W. Ramsay, F.R.S., 401; Argon and the Periodic System, Prof. J. Emerson Reynolds, F.R.S., 480; Argon in Nebula, Dr. B. Brauner, 513;



- Attempts to produce Chemical Combinations with Argon, M. Berthelot, 527; Simple Demonstration of Presence of Argon in Atmospheric Nitrogen, M. Guntz, 500; Argon not in Vegetable or Animal Substances, G. W. MacDonall and A. M. Kellas, 620; die Resultate der Aetzmethode in der Krystallographischen Forschung, an einer Reihe von Krystal-lisirten Körpern dargestellt, Dr. H. Baumbauer, 340; Speed of Liberation of Iodine in Mixed Solutions, H. Schmidt, 340; the New Iodine Bases, John McCrae and Mr. Wilkinson, 340; Action of Diastase on Starch, A. K. Ling and J. L. Baker, 350; New  $\alpha$ -Dibromocamphor Derivatives, M. O. Forster, 350; Acid Sulphate of Hydroxylamine, L. Divers, 350; Hypophosphites of Mercury and Bismuth, S. Hada, 350; Kamala (ii.), A. G. Perkin, 350; Action of Aqueous Potassium Cyanide on Gold and Silver in Presence of Oxygen, J. S. Maclaurin, 350; Boride of Iron, Henri Moissan, 350; Properties of Bismuth Sulphide, A. Ditte, 350; Action of Electric Current on Fused Metallic Sulphates, Jules Garnier, 350; Carbonyl Chlorobromide and Dibromide, A. Besson, 350; Acetic Ethers from Sugars, C. Tanret, 350; Hexamethylene-Amine, M. Delépine, 360; Elementary Practical Chemistry, Inorganic and Organic, J. T. Hewitt and F. G. Pope, 364; the Liquetaction of Gases, M. M. Pattison Muir, 364, 388, 430; Prof. James Dewar, F.R.S., 395, 413; Ammonium Thioacetate as Substitute for Sulphuretted Hydrogen, Prof. Schiff and Dr. Tarugi, 373; Methylammonium Derivatives of Hexamethyltriiodotriphenylmethane, A. Rosenstiehl, 384; Reactions of Chelidonic with Phenols in Sulphuric Solution, M. Battandier, 384; the New Laboratory at St. Petersburg University, 302; Death of Dr. Gerhard Krüss, 302; the Commercial Extraction of Pure Dextrose from Syrup Mixtures, Dr. Wollt, 395; Application of Sound-Vibrations to Analysis of Two Gases of different Densities, E. Hardy, 407; Alumina in Plants, MM. Berthelot and Andre, 407; Titanium, H. Moissan, 407; Lowering of Freezing-Point of Dilute Solutions of Sodium Chloride, A. Ponsot, 407; Sulphide of Gold, A. Ditte, 407; Cinchonine, MM. E. Jungfleisch and E. Leger, 407; the Leyden Kyrogene Labora-tory, Prof. Kamerlingh Onnes, 408; Handbüch der Stereo-chemie, Dr. C. A. Bischoff, 409; die Maschinellen Hilfsmittel der Chemischen Technik, A. Barmick, 412; the Atomic Weight of Tungsten, Prof. E. G. Smith, 424; the Specific Heat of Tungsten, Prof. E. G. Smith and Mr. Grod-speed, 424; Action of Heat on Ethylic  $\beta$ -Amidoacetate (ii.), J. N. Collie, 430; Acidimetry of Hydrogen Fluoride, T. Haga and Y. Osaka, 430; Molecular Change in Silver Amalgam, F. T. Littleton, 430; Sulphocamphylic Acid, H. W. H. Perkin, jun., 430; Acetyl Derivatives of Benzacoline and Aconitine, W. R. Dunstan and F. H. Carr, 430; Aconitine Aurichlorides, W. R. Dunstan and H. A. D. Jowett, 430; Atomic Weights, Lecoq de Boisbaudran, 432; Amorphous Silicon, M. Vigouroux, 432; Melting-Points of Mixture, H. Crompton and M. A. Whiteley, 454; the Volumetric Determination of Manganese, J. Keddorp and H. Ramage, 454; Bromocamphoric Acid, F. S. Kipping, 455; Ebullioscopic Study of Colouring Matters from Triphenylmethane, A. Haller and P. T. Muller, 455; Combinations of Nitric Oxide and Iron Chlorides, V. Thomas, 455; *Leçons de Chimie*, H. Gautier et G. Charpy, 450; New Method of Preparing Unsaturated Hydrocarbon Allylene, Prof. Keiser, 471; Double Decompositions of Vapours, Henryk Arctowski, 477; Black-Damp, Dr. John Haldane, 477; Composition of Extinctive Atmospheres produced by Flames, Prof. Frank Clowes, 478; Production of Primary Amines, M. Delépine, 480; Die Wissenschaftlichen Grund-lagen der Analytischen Chemie, W. Ostwald, J. W. Rodger, 482; Sodium Compounds of Nitro-Paraffins, Prof. Victor Meyer, 402; Action of Formaldehyde on Ammoniacal Salts, A. Brochet and R. Cambier, 503; Optical Resolution of  $\alpha$ -Oxybutyric Acid, P. A. Guye and Ch. Jordan, 503; Urea-ethanol, M. Franchimont, 504; Magnetic Rotational Dis-persion of Oxygen and Nitrogen, Dr. Siertsema, 504; Cod-liver Oil and Chemistry, F. Peckel Moller, Jas. Cameron, 508; Terrestrial Helium (?), 512; Prof. Ramsay, 543; W. Crookes, F.R.S., 543; J. Norman Lockyer, C.B., F.R.S., 586; Dimethylhexamethylene, F. S. Kipping, 526; Use of Barium Thiosulphate in Standardising Iodine Solution, R. T. Plimpton and G. C. Chorley, 520; Melting Points of Raecemic Modifications and Optically Active Isomerides, F. S. Kipping and W. J. Pope, 526; Synthesis of a Methyl Butyrolactone, F. Haworth and W. H. Perkin, jun., 520; Methylisobutylacetic Acid, W. H. Bentley and M. W. Burrows, 520; Aromatic Nitro-s Oxide on Metals and Metallic Oxides, Paul S. Meyer and J. B. Senderens, 528; Isomer-Synthesis of Oxidized Mercury, Raoul Varet, 528; a Mercury Compound of Thiophene, G. Deugs, 528; Chemical Composition of Oceanic Deposits, Prof. J. B. Harrison and A. J. Fisher-Browne, 527; Theoretical Chemistry from the Standpoint of Avogadro's Rule, and Thermodynamics, Prof. Walter Nernst, M. M. Pattison Muir, 530; the Atomic Weight of Chlorine, E. Schutzenberger, 552; New Method for Preparation of Chloroplatinous Acid, Leon Fignon, 552; Heat of Formation of Calcium Acetylde, M. de Foreland, 552; Alterations in Saccharine Matters during Germination, G. Barley, P. 552, 552; Chemical Process for Parmenting, J. Water, F. Berles and Ch. Girard, 552; Organic Chemistry, the Fatty Com-pounds, R. Lloyd Whiteley, 557; Carbon Monosulphide, Dr. Deninger, 504; Gases of Swimming Bladder of Fishes, Jules Richard, 570; Alcoholates of Lime and Baryta, M. de Foreland, 570; Quantitative Chemical Analysis of Organic Substances, 580; Grundzüge der Mathematischen Chemie, Dr. G. Helm, 580; New Compounds of Phosphorus Nitro-gen and Chlorine, H. N. Stokes, 502; Estimation of Thiophene in Benzene, G. Deniges, 600; Calcium Phosphate of Milk, L. Vaudin, 600; an Improved Method for the Microscopic Investigation of Crystals, A. E. Tutton, 608; Aromatic Esters of Arsenious Acid, Dr. Fromm, 610; the Freezing Point of Dilute Solutions, J. W. Rodger, 617; Assimilable Nitrogen in Arable Land, M. Pagnoul, 622; Methylene Lactate, L. Bis Henry, 620; Critical Temperatures of Mixtures and of Water, F. A. Dwelshauvers-Dery, 620; Action of Heat on Carbon Bisulphide, Henryk Arctowski, 620; Atomic Weight of Tellurium, B. Brauner, 620; Studies in Isomer-Change, G. I. Moody, A. Lapworth, 620; Electrolysis of Potassium Allo-Ethylie Camphorate, J. Walker and J. Henderson, 621; Nitro Derivatives of Dimethylamine, Dr. P. van Rombergh, 624; Addition Products of Symmetrical Trimethenol, Dr. P. van Rombergh, 624; Behaviour of Hydrogen to Palladium at Various Temperatures and Pressures, Bakhuis Roozboom and Dr. Houtsema, 624
- Chesney (General Sir George), Death of, 538
- Chess-Players, Psychology of Mental Arithmeticians and Blind-fold, Alfred Binet, Francis Galton, F.R.S., 73
- Children, the Growth of, St. Louis, William Townsend Porter, Prof. Karl Pearson, 145
- Chilo-Argentine Earthquake of October 27, 1804, and Contemporaneous European Pulsations, 371
- Chilo-Argentine Earthquake of October 1804, A. F. Niggess, 303
- China; Butterflies from China, Japan, and Corea, John Henry Leech, 6; Chinese Beliefs about the North, Kumagusi Minakata, 32; Chinese Beliefs about Caves, Kumagusi Minakata, 57; Chinese Theories of the Origin of Amber, Kumagusi Minakata, 204; Typhoons in 1803 in Chinese Seas, 130; Superficial Deposits of Shantung, S. B. J. Skerletchly and L. W. Kingsmill, 478
- Chlorine, New Compounds of Phosphorus Nitrogen and, H. N. Stokes, 502
- Chloroform at very Low Temperatures, Anomalous Behaviour of, Raoul Pietet, 20
- Chorley (J. C.), Use of Barium Thiosulphate in Standardising Iodine Solution, 520
- Chree (C.), Neotropic Elastic Solids of nearly Spherical Form, 40
- Christiansen (C.), the Origin of Frictional Electricity, 70
- Chronograph Pendulum, a Simple, Carl Barus, 84
- Chronometer Trials, William E. Plummer, 153
- Church (Prof.), Determination of Mineral Densities, 431
- Cinelli (M.), the Transmission of Electricity through Gases, 514
- Cinerraria, the Origin of the Cultivated, W. Baccson, F.R.S., 605
- Civil Engineers, Institution of, Annual Banquet, 538
- Civilisation, the Dawn of, G. Maspero, 122
- Clark (Prof. H. E.), an Elementary Text-book of Anatomy, 412
- Clarke (C. B.), the Terminal Flower in Cyperaceæ, 575
- Clarke (Hyde), Death of, 468
- Classen (Dr.), Improvement in Sensitive Balances, 540
- Clayton (H. Helm), Eleven-year Sun spot Weather Period and its Multiples, 430
- Clayton (J.), Contraction of Trees caused by Cold, 402
- Cleland (John), Acquired Characters, 204
- Climbing and Exploration in the Karakoram Himalayas, William Martin Conway, 190
- Clouds, the Study of, 248

- C... S. M., on the ... of W. H. Shaw, F.R.S., 527
- C... (Prof. F. H.), Elementary Qualitative Chemical Analysis, 270; Composition of Extinctive Atmospheres produced by Flames, 278
- C... (W. L.), ... of Naval Officers, 250
- C... (Dr. J.), ... Agent, as shown by an Examination of the Cancer in Expts. on Donald M. D. Stuart, 268
- C... (Prof. J. D. A.), Variation in *Cyberbium*, 487
- C... (Sir James F.R.S.), Death of, 324
- C... (Dr. J. and Chemist, F. Pöckel, Mollin, Jas. Cameron, 508
- C... (Dr. J.), the Mode of Formation of Lymph, 210; Action of Irritating Injections of Sodium Chloride on Composition of Lymph and Blood, 431
- C... (Dr. J.), Contraction of Trees caused by, J. Clay, 402
- C... (Dr. J.), Intense, as a Therapeutic Application, Dr. Ferey, 588
- C... (Dr. J.), the Occurrence of very, 410
- C... (Prof. J.), Mineral Variations of Basalt, Andesite and Later Tuffe, 112
- C... (Frank J.), Polyembryony, 558
- C... (J. B.), Elementary Qualitative Chemical Analysis, 270
- C... (E.), the Condensation of Electrolytic Gases by Metals of Platinum Group, 95, 113
- C... (H. N.), Action of Heat on Ethyl 3-Aminodimethyl, 430
- C... (John), Rain-making and Sunshine, 7
- C... (Blindness), a Case of Yellow-Blue Blindness, Dr. W. Peddie, 335, 621; the Normal Defect of Vision in the Fovea, C. L. Franklin, 615
- C... (Dr. J.), Experiments on, H. W. Vogel, 460
- C... (K.), Conditions necessary to obtain Correct Results when measuring Lap of Resistances with Alternating Currents and a Telephone, 280
- C... (Alph.), Valency of Beryllium (Beryllium) and Formula of Ghonia, 240
- C... (Comets), a Comet on the Eclipse, Photographs of, 1803, 40; Encke's Comet, Prof. M. Wolf, 64; Return of Encke's Comet, 40; Ephemeris of, Dr. O. Backlund, 85; History of, W. T. Lynn, 108; a New Comet, Mr. Edward Swift, 114, 132; Ephemeris for Swift's Comet, 160; Comet, 1804 (Swift), 542; Cometary Periodicity, 207; Comet 1804 I. (Denning) and Brorsen's Comet, 425; Dr. Hind, 302; Dr. L. Lamp, 302; the Designation of, 347
- C... (Commercial Geography), L. C. K. Gonner, 30
- C... (Zoology), Structure of Gastropod Shells, W. H. Dall, 181; Foraminifera from Arabian Sea, I. Chapman, 311
- C... (Electricity of Pure Water), the Electric, J. W. Rodger, 42
- C... (Constantinople), Seismological Observatory to be Founded at, 180
- C... (Constantinople Earthquakes of July 10, 1891), Dr. Cancani, 440
- C... (Constitution), the New, of the Atmosphere, Lord Rayleigh, Sec. F.R.S., and Prof. William Ramsay, F.R.S., 347
- C... (Consumption), Alpine Climates for, H. J. Budwick, 54
- C... (Contemporary Review), Science in, 581
- C... (Contraction of Trees), caused by Cold, J. Clay, 402
- C... (Contraction, Muscular, on the Nature of, Prof. Dr. W. Engelmann, 510)
- C... (Cretaceous Geology), Joseph Prestwich, F.R.S., Prof. John W. Judd, F.R.S., 601
- C... (C... way (William Martin, F.R.S.), Climbing and Exploration in the Karakoram Himalayas, 100
- C... (C... (H.), the Miocene Platyzoan Beds, 143
- C... (C... (Dr. M. C.), Fiddle and Porcini Mushrooms, 8
- C... (C... (Dr. H.), a Flying, Dr. Ostroumoff, 201; Captain Hembutt, 360
- C... (C... (Dr. Henry), Death of, 538
- C... (C... (M. J.), Preliminary of Temperature of Greatest Density of Water, 37
- C... (C... (Dr. J.), Studies of a Growing Acell, Dr. Hugh Robert Mill, 203
- C... (C... (Dr. J.), Butterflies from China, Japan, and John Henry Leach, 6
- C... (C... (C. J.), Lake of the Zoo, 270
- C... (C... (Dr. J.), the Unsolved Problem of, Howard Ford, 30
- C... (C... (Prof. J.), Aeronautics in France, 200
- C... (C... (Dr. J.), the Ultra-Violet Spectrum of the M. De la Roche, 580
- C... (C... (Dr. J.), Cartography, Researches on Mammals, 60
- C... (C... (Dr. J.), Crosses by Arabs, Colonel A. T. Frisby, 325
- C... (C... (M.), a Fine London University, 161
- C... (C... (A.), Geology of Distribution of Brachopoda, 514
- C... (C... (Dr. J.), the Varieties of the Human Species, Prof. Giuseppe Sergi, 505
- C... (C... (Dr. J.), the ... of New York, 1891, in Niagara and the Great Lakes, 280
- C... (Creighton (Dr. Charles), a History of Epidemics in Britain, 570
- C... (Critical Point), the, Raoul Pictet, 504
- C... (Croft (W. B.), Singing Water-Pipes, 107; Simple Physical Apparatus, 383
- C... (Crommelin Collection of Dutch Birds, the, 18
- C... (Crompton (H.), Melting-Points of Mixtures, 454
- C... (Crookes (W., F.R.S.), on the Spectra of Argon, 354; Terrestrial Helium (2), 543
- C... (Crump (W. B.), Science Teaching in Schools, 50
- C... (Crustacea; a Flying Copepod, Dr. Ostroumoff, 201
- C... (Crystallography; Homogeneity of Structure the Source of Crystal Symmetry, Wm. Barlow, 58; H. A. Miers, 70; Ink-Crystals, 60; on the Use of the Globe in the Study of Crystallography, J. V. Buchanan, F.R.S., 184; William J. Pope, 223; Die Resultate der Aetzmethode in der kristallographischen Forschung, an einer Reihe von kristallisirten Körpern dargestellt, Dr. H. Baumhauer, 340; an Instrument for Cutting Section-Plates and Prisms, A. E. Tutton, 452; the Laws of Crystalline Absorption, L. Carvallo, 455; an Improved Method for the Microscopic Investigation of Crystals, A. E. Tutton, 608
- C... (Culverwell (Edward P.), a Criticism of the Astronomical Theory of the Ice Age, 33; the Astronomical Theory of the Ice Age, 371; the Kinetic Theory of Gases, 78; Prof. Boltzmann's Letter on the Kinetic Theory of Gases, 581; Boltzmann's Minimum Theorem, 105, 240
- C... (Cunningham (Lieut.-Colonel Allan), on Mersenne's Numbers, 533
- C... (Cunningham (J. T.), Acquired Characters, 120, 293; the Statistical Investigation of Evolution, 510
- C... (Curie (M.), Experiments to see if Light Rays deviated by Magnetic Field, 304
- C... (Currents, Ocean; the Travels of Three Bottle-Papers, H. C. Russell, 35
- C... (Curtis (Prof. G. L.), the Wind and Bird-Flight, 150
- C... (Curtius (Prof.), Carbazole and Di-urea, 30
- C... (Curve, the Examining, Prof. C. Lloyd Morgan, 617
- C... (Cycles, Involution and Evolution according to the Philosophy of, 125
- C... (Cyclopædia of Names, the, 434
- C... (Cypress of Nyasaland, the New, 85; W. T. Thiselton-Dyer, F.R.S., 175
- D... (Denme Vand Glacier Lake, the, Capt. Ferryman, 130
- D... (Dahms (Albert), Freezing Points of Binary Mixtures of Heteromorphous Substances, 610
- D... (Dale (E.), Variations in Floral Symmetry of *Potentilla Tormentilla*, 350
- D... (Dall (W. H.), Structure of Gastropod Shells, 181
- D... (Dana (Dr. C. L.), Giants and Giantism, 381
- D... (Dana (Prof. James Dwight), Death of, 587; Obituary Notice of, 611
- D... (Danckelmann (Prof. von), Dr. Steinbach's Observations on the Climate of Jahu, 102
- D... (Darriens (G.), Chemical Reactions in Ordinary Lead Accumulator, 37
- D... (Darwin (Francis, F.R.S.), Practical Physiology of Plants, 577
- D... (Daubree (M.), Statistical Account of French Forests, Prof. W. R. Fisher, 64
- D... (Daubree (Prof.), Hayden Medal awarded to, 345
- D... (Dauphine, the Lake of, A. Delebecque, 35
- D... (Davidson (W. B.), Condensation of Benzil with Ethyl Malonate, 143
- D... (Davis (Prof. J. R. Amisworth), the Habits of Limpets, 514
- D... (Davison (C.), on a Remarkable Earthquake Disturbance observed at Strassburg, Neudauw, and Birmingham, on June 3, 1893, 208; the Velocity of the Argentine Earthquake Pulsations of October 27, 1891, 402; the Age of the Earth, 607
- D... (Dawkins (Prof. W. Boyd, F.R.S.), Man, the Primeval Savage, Worthington G. Smith, 104
- D... (Dawn of Civilisation, the, G. Maspero, 122
- D... (Dawson (Dr. G. M., F.R.S.), Scientific Investigation in Canada, 236
- D... (Days, the Occurrence of very Cold, 410
- D... (Death, the Feigning of, in Snakes, R. Harry Vincent, 223
- D... (Death, Longevity and, Dr. G. J. Romanes, 381
- D... (Dechyens (Rev. Marc), Modifications of an Electrical Anemometer, 320
- D... (Deherain (P. P.), Autumn Cultivation of Green Manure, 311; the Composition of Drainage Waters, 576
- D... (Delore (M.), a New System of Anthracene, 330

- Delebecque (A.), the Lakes of Dauphine, 35  
 Delépine (M.), Failure of Kjeldahl, Method of Estimation of Nitrogen when applied to Chloroplatinates, 336; Hexamethylene-Amine, 360; Production of Primary Amines, 478  
 Deniges (G.), a Mercuric Combination of Thiophene, 528; Estimation of Thiophene in Benzene, 600  
 Deninger (Dr.), Carbon Monosulphide, 504  
 Denning (W. F.), Jupiter, 227; the Perseid Meteors, 320; Denning's Comet, 1804 I. and Brorsen's Comet, Dr. Hind, 302; Dr. E. Lamp, 302; the Identity of Denning's and Brorsen's Comets, 425  
 Denza (Father F.), Obituary Notice of, 170  
 Desaint (H.), Functions Enticres, 593  
 Deserts of Southern France, the, S. Baring-Gould, Canon Bonney, F.R.S., 160  
 Designation of Comets, the, 347  
 Deslandres (H.), Radial Velocity of  $\zeta$  Hercules, 263; Spectroscopic Measures of Planetary Velocities, 443; Ultra-Violet Radiation of Solar Corona during total Eclipse of April 16, 1893, 575; the Ultra-Violet Spectrum of the Corona, 580  
 Dewar (Prof. James, F.R.S.), the Liquefaction of Gases, 245, 365, 413  
 Deyrolle's Nickel Entomological Fastening Pin, 130  
 Diameter of Neptune, the, Prof. Barnard, 617  
 Diameters of Mercury, the Apparent, Prof. Barnard, 373  
 Dickson (Dr. Walter, R.N.), Death of, 61  
 Dickson's Physical Investigations in Laroo-Shetland Seas, 115  
 Dilute Solutions, the Freezing Point of, J. W. Rodger, 617  
 Dines (W. H.), Cause of Cyclones of Temperate Latitudes, 451  
 Dinsc (P.), the Morphology of Fjords, 111  
 Diphtheria, the Antitoxic Serum Treatment of, Dr. M. A. Ruffer, 16; Dr. G. Sims Woodhead, 402, 425; the Antitoxin Treatment of Diphtheria in France, 83; Protest against New Treatment of Diphtheria, 150; Statistics of Results of Behring and Roux's Method, 324  
 Discontinuous Motion, A. B. Basset, F.R.S., 11  
 Diseases of Trees, Text-book of the, Prof. K. Hartig, Prof. W. R. Fisher, 28  
 Disinfectants, Air, Water and, C. M. Aikman, 412  
 Disinfection by Copper Sulphate of Fœcal Matter, H. Vincent, 168  
 Dispersion, Atmospheric, Dr. Rambaut, 306  
 Dite (A.), Properties of Bismuth Sulphide, 350; Sulphide of Gold, 407  
 Divers (E.), Acid Sulphate of Hydroxylamine, 350  
 Dixon (A. F.), Development of Branches of Fifth Cranial Nerve in Man, 599  
 Dixon (Charles), the Nests and Eggs of Non-Indigenous British Birds, 30; New Law of Geographical Distribution of Species, 545  
 Dixon (Edward J.), Peculiarities of Psychical Research, 200, 223; the Expansion of Functions, 308  
 Dixon (Prof. H. B., F.R.S.), the Explosion of Gases in Glass Vessels, 151  
 Dixon (H. H.), the Ascent of Sap, 93  
 Dixon (Samuel), Drilling Machines for Boiler Shells, 22  
 Djakonow (D.), Die Bearbeitung des Glases auf dem Blasstische, he, 580  
 Dogs' Eyes, Spots over, Worthington G. Smith, 57  
 Dogs' Eyes, Tan-spots over, J. Shaw, 33; S. S. Peal, 533; Dr. Alfred R. Wallace, F.R.S., 533  
 Donnan (F. G.), "Solute," 200  
 Donnelly (Major-General Sir John) on Technical Education, 116  
 Doppler's Principle, Dr. Belopolsky, 233  
 Dorsey (Prof. J. O.), Death of, 302  
 Drainage Waters, the Composition of, P. P. Dohérain, 570  
 Drift-Bottles in the Irish Sea, Prof. W. A. Herdman, F.R.S., 151  
 Bruide (P.), Studies of Electric Resonator, 100; Electric Dispersion, 400  
 Dublin, a Foucault Pendulum at, W. R. Westropp Roberts, 510  
 Dublin Royal Society, 502, 622  
 Dubois (E.), Pithecanthropus Erectus, eine Menschenähnliche Uebergangsform aus Java, 291; so called Missing Link, 428; Dubois on Pithecanthropoid Remains in Java, Sir W. Turner, 619  
 Duchartre (Prof. P.), Death of, 35; Obituary Notice of, 344  
 Duckworth (W. L. H.), New Ossiferous Fissure in Cresswell Crags, 527  
 Duden (Dr.), Inorganic Mode of Preparing Hydrazine, 301  
 Dudley Observatory, the New, 327  
 Dumesnil (C.), Tableau Métrique de Logarithmes, 386  
 Dunkeld, Original Larch Trees at, 111  
 Dunstan (W. R.), Pellitorine and Piperovatine, 310; Acetyl Derivatives of Benzatonine and Aconitine, 439; Aconitine Aurichlorides, 430  
 Dapré's (Dr.) Report on the Compressed Oxygen Cylinder Explosion, 502  
 Durand (Th.), Conspectus Floræ Africæ, on Enumeration des Plantes d'Afrique, 459  
 Dutch Birds, the Crommelin Collection, 2, 2, 18  
 Dyeing: La Pratique du Teinturier, Jules Garçon, Walter M. Gardner, 604  
 Dynamics: a Text-book of Dynamics, William Briggs and G. H. Bryan, 76; the Foundations of Dynamics, Prof. G. F. Fitzgerald, F.R.S., 283; Dynamometers and the Measurement of Power, John J. Hather, 30  
 Early British Races, Dr. J. G. Garson, 67, 90  
 Earth, on the Age of the, Prof. John Perry, F.R.S., 224, 341, 582; Prof. Tai, 220; Lord Kelvin, F.R.S., 227, 438; Prof. W. J. Sollas, F.R.S., 533, 558; Dr. Bernard Hobson, 538; Dr. Alfred R. Wallace, F.R.S., 607; C. Davison, 607  
 Earth, the Plane, an Astronomical Introduction to Geography, R. A. Gregory, 201  
 Earth-Waves and Vibrations, the Observation of, Prof. John Milne, F.R.S., 548  
 Earth-Worms, Rhynchodemus Terrestis in Germany, H. Sinaroth, 204  
 Earthquakes: the Chilo-Argentine Earthquake of October 27, 1804, 18; A. F. Nognes, 393; Connection between Contemporary European Pulsation Series and, 232, 371; the Velocity of the Argentine Earthquake Pulsations of October 27, 1804, C. Davison, 402; Earthquake in New Hebrides, 61; in Sicily, 82, 513; the Sicilian Earthquakes of August 1804, Dr. M. Baratta and Prof. Riccio, 207; Earthquakes in Italy, 110, 513, 587; the South Italian Earthquake of November 16, 1804, Prof. Tacchini, 340; in Vienna, 110; Earthquake in Hungary, 200; in Austria-Hungary, 587; Catalogue of Earthquakes in Russia, Mushketoff and Orloff, 181; on a Remarkable Earthquake Disturbance observed at Strassburg, Nicolaiew, and Binningham, on June 3, 1803, C. Davison, Dr. F. von Reber Paschwitz, 208; Earthquake of November 1804 in Nicaragua and Honduras, J. Crawford, 288; Earthquake in Persia, 208; in Norway, 344; Dr. Hans Reusch, 300; Dislocation of Sumatra Mountain System by Earthquake of May 17, 1802, J. J. A. Müller, 408; the After-Shock of Earthquakes, F. Omori, 423; the Constantinople Earthquake of July 19, 1804, Dr. Cancani, 440; Earthquake in Pacific Ocean, 408; the Frequency of Earthquakes, M. de Montessus de Ballore, 540; the Tokio Earthquake of June 24, 1804, 593  
 Eas, the Bird-Winged Butterflies of the, H. F. Rippon, 343  
 Easton (C.), the Milky Way, 327  
 Eaton (Dr. Darwin G.), Death of, 538  
 Eclipse of the Moon, 444, 472  
 Eclipse of the Sun, March 20, Partial, 493  
 Eclipse, Total, by Order of the Sun to Observe his, April 16, 1893, J. J. Auberlin, 101  
 Eclipse Photographs of 1893, a Comet, on, 40  
 Eder (J. M.), Studies of Bunsen Flame Spectra of Alkali and Alkaline Earth Metals, 20  
 Edible and Poisonous Mushrooms, Dr. M. C. Cooke, 8  
 Edinburgh, the Royal Observatory, 493  
 Edinburgh Royal Society, 215, 335, 621  
 Edridge Green (Dr. F. W.), the Artificial Spectrum Top, 321  
 Eder (J.), Objective Reality of Combination Tones, 550  
 Education: Science Teaching in Schools, W. B. Crump, Grace Heath, 50; Geometry in Schools, Edward M. Langley, 170; a True University of London, M. Crackenthorpe, 161; Education of Naval Officers, the, W. L. Clowes, 250; the Teaching University for London, Dr. W. Palmer Wynne, 207; Research in Education, Dr. H. E. Armstrong, F.R.S., 403; Dr. M. Foster on the Teaching of Physiology in Schools, 487; the New Technical Educator, vol. iv., 53; Major-General Sir John Donnelly on Technical Education, 116; Technical Education, Science Teaching, H. G. Wells, 182; the Advance of Technical Education, R. A. Gregory, 379  
 Egypt, the Nile Reservoir at Assam, 110; the Nile, Sir Colin Scott Moncrieff, 444

- 1895; *Journal of the Royal Society of London*, Egyptian Chalices, G. Maspero, 122; Death of Dr. F. J. Lamb, 421
- 1895; T. W. K. (1895) Wind Measurement Experiments at Marine Observatory, 181
- 1895; Force Acting at Surface of Separation of Two Dielectrics, H. Pellat, 24; Electric Light and Power, Arthur E. Gray, 30; Effect of Cathode Rays on Colour of Certain Salts, Prof. Goldstein, 62; Production of Cathode Rays, J. de Kowalski, 312; Conditions necessary for Production of Cathode Rays, M. de Kowalski, 304; Effect of Cathode Rays on Some Salts, J. Goldstein, 469; the Kerr Phenomenon, C. H. Wind, 62, 168; the Origin of Frictional Electricity, C. Christiansen, 70; Thermo-Couples of Metals and Saline Solutions, August Hagenbach, 70; Changes of Length produced by Magnetisation, H. Nagaoka, 70; Elliptically Polarised Rays of Electric Force, L. Zehnder, 70; Refraction and Dispersion of Rays of Electric Force, A. Garbass and E. Aschkinass, 70; Resonance Analysis of Alternating Currents, M. J. Pyron, 93, 100; the Condensation of Electrolytic Gases by Metals of Platinum Group, Chilletet and Colardain, 95; Condensation of Gases produced by Electrolysis of Platinum and Palladium Electrodes, MM. Chilletet and Colardain, 113; Influence of Polarisation on Outflow of Negative Electricity caused by Light, Prof. Boerstein, 95; Progress of the Cataract Construction Company's Works at Niagara, 100; the Utilisation of Niagara Falls, Prof. George Forbes, F.R.S., 205; the Relation of Energy of Combination to Electrical Energy, Dr. W. Borchers, 141; a Modification of Ballistic Galvanometer Method of Determining Electromagnetic Capacity of Condenser, M. Womack, 142; Seebeck's Apparatus for Verifying Ohm's Law, Prof. Ayrton, 142; New Method for Measuring Small Resistances, Dr. Esquidin, 158; Temperature of Electric Arc, J. Violle, 168; Electromagnetic Theory, Oliver Heaviside, F.R.S., 1; Swinburne, 171; New Interruption for Luge Deduction Coils, E. L. O. Wadsworth, 169; Thermochemical Process of Secondary Cell, Franz Streinz, 169; Magnetisation of Iron and Nickel Wires by Rapid Electric Oscillations, Ignaz Klotzinger, 169; Studies of Electric Resonance, P. Ducloux, 169; Distance Telegraphy without Wires, Dr. Debus, 191; Determination of Specific Heat of Water in the Liquid State, Prof. A. Schuster, F.R.S., and W. Cannon, 214; Method of Measuring Specific Inductive Capacity and Resistance of Liquids, Prof. Nernst, 232; Tests of Glow Discharge, Prof. W. E. Ayrton and E. A. Medley, 230, 358; Electric Potentials in Liquid Conductor in Uniform Motion, G. G. de Villemonais, 240; Electrostatic Capacity of Dielectric Transversed by Current, M. Vaschy, 240; Electrical Vibrations in Condensing Systems, Dr. J. Larmor, F.R.S., 263; Conditions necessary to obtain Correct Results when Measuring Liquid Resistances with Alternating Currents, Debye and R. C. Johnson, 280; Thermo-Electric Properties of Platinum and Manganite, B. D. Peirce, 280; Influence of Electric Waves on Galvanic Resistance of Metallic Conductors, Dr. Aschkinass, 288; Electrolysis of Solution of Mercuric Nitrate and Sulphate of Silver plus a little Nitric Acid, Debus, 288; some Early Terrestrial Magnetic Discoveries, Prof. G. G. de Villemonais, Will Whiston, L. A. B. Co., 295; Effect of Distribution on Two Intersecting Spheres, H. M. Taylor, 308; Passage of Oscillator Wave Train through Dielectric of Changing Dielectricity, G. N. Vail, 310; The Electric Arc, W. Slings and A. Brooker, 318; Seebeck's Magneto-Thermoelectricity and Electricity Criticised, H. Nernst, 318; Electroscopes in Lecture, Prof. Oliver J. Lodge, F.R.S., 323; Prof. P. G. A. Ashworth, 343; the Elinth Electric Engine, 324; Modifications of an Electrical Memoir, Prof. M. D. Boyen, 326; The tromagnet, Bull. Soc. Weiser, 326, 357; Electric Discharge through Gases, Prof. F. J. Morley, 330; Capillary Electrometer, and Drop Electrometer, M. J. Pyron, 334; Different Forms of Multiple Induction, B. D. Peirce, 357; Action of Electric Current on Liquid Mercury, S. J. Child, L. J. Cornin, 359; Resonance Oscillations, H. Pellat, Prof. A. Gray, 361; the Tin Condenser, Prof. S. S. Stevens, 383; Experiments on the Electrolysis of Water by Magneto-Electricity, 364; Elemental Galvanic Cells, Prof. W. C. Unwin, F.R.S., 377; Death of Alfred Gibbs, 368; Death of J. C. Smith, P. Inst. C.E., Dispersion, P. Ducloux, 409; Electrostatic Capacity of Resistance Bobbins, J. Cannon, 407; Double Refraction of Electric Waves in Wood, K. Maek, 423; Method of Determining Conductivities of Badly-conducting Substances, Prof. J. J. Thomson, 431; Probable Cause of St. Pancras Explosion, Major Cardew, 440; Major Cardew on the London Electric Light Main Accidents, 530; Major Cardew's Report on the Southwark Bridge Explosions, 614; the St. Pancras Electric Light Main Explosion, 502; Electric Light Main Explosion at Providence, Rhode Island, 502; Electrostatic Capacity of Resistance Coils, J. Cannon, 442; Electromotive Force of Iodine Cell, A. P. Laurie, 454; Electrical Haulage at Earnock Colliery, R. Robertson, 460; Water-Power applied by Electricity to Gold-Dredging, Robert Hay, 470; the Telegraphist's Guide, James Bell, 484; Electrification of Air and other Gases, Lord Kelvin, F.R.S., Magnus Maclean, and Alexander Galt, 495; Action of Light in Producing Electric Discharge through Vacuum Tube, Elster and Geitel, 514; the Transmission of Electricity through Gases, G. Vincentini and M. Cincelli, 514; the United States Units of Electrical Measure, 518; a Class of Secondary Batteries, Lucien Poincaré, 528; Thermochemical Carbon Battery, Desiré Korda, 528, 541; Therapeutic Action of Currents of High Frequency, Apostoli and Berlioz, 528; Electrophysiology, Prof. W. Biedermann, Prof. J. Bindon Sanderson, F.R.S., 553; a Battery with Liquid Metallic Electrodes, Lucien Poincaré, 593; a New Determination of the Ohm, F. Himstedt, 571; the Dielectricification of Air, Lord Kelvin, Magnus Maclean, and Alexander Galt, 503; the Question of Dielectric Hysteresis, A. W. Porter and D. K. Morris, 574; Problems and Solutions in Elementary Electricity and Magnetism, W. Slings and A. Brooker, 580; Electrical Resistance of Woods and Stones, B. D. Peirce, 588; the Supposed Magnetic Fatigue, Messrs. Campbell and Lovell, 614; Electrolysis of Potassium Allo-Ethylie Camphorate, J. Walker and J. Henderson, 621; Carbon Monoxide produced by Combustion in Electric Arc, N. Gréhan, 622; Conduction and Convection in Feebly Conducting Dilute Solutions, E. Warburg, 610; Glow Discharge in Air, C. A. Melms, 620; the Testing of Platinum Pyrometers, Dr. W. Wier, 623
- Elgar (Dr. Francis), James Watt and Ocean Navigation, 475
- Elliot (G. E. Scott); Return of, 208; Exploration at Ruwenzori, 271; the Glaciation of Mt. Ruwenzori, 441; Exploration of Mt. Ruwenzori, 527
- Elliott (Surg.-Capt., R.A.); Strychnine no Antidote to Snake-Poison, 540
- Elliptical Orbits, Mr. H. Larkin, 234
- Elster (Herr), Action of Light in Producing Electric Discharge through Vacuum Tube, 514
- Embryology; Death of J. A. Ryder, 587
- Emin Pasha, the Death of, R. D. Mohun, 381
- Enargite, Mr. Spencer, 621
- Locke's Comet, Prof. M. Wolf, 64; Return of, 40; Ephemeris of Dr. O. Backlund, 85; History of, W. T. Lynn, 108
- Energy of Combination, the Relation of, to Electrical Energy, Dr. W. Borchers, 141
- Engelmann (Prof. Th. W.) on the Nature of Muscular Contraction, 519
- Engineering; the Elements of Graphic Statics, L. M. Hoskins, 71; Institution of Mechanical Engineers, 22, 377; Manufacture of Standard Screws for Machine made Watches, C. J. Hewitt, 22; Drilling Machine for Boiler Shells, Samuel Dixon, 22; Dynamometers and the Measurement of Power, John J. Fisher, 30; Helical Gears, a Foreman Pattern Maker, 30; Kieou's Experiments to Overcome Air Resistance to Locomotive at High Speed, Max de Nansouty, 62; the Construction of the Modern Locomotive, George Hughes, N. J. Lockyer, 97; Progress of the Cataract Construction Company's Works at Niagara, 100; the Development and Transmission of Power, Prof. William Cawthorne Unwin, F.R.S., 124; Advice to Young Engineers, A. Siemens, 131; the Principles of Waterworks Engineering, J. H. Tudsbery Tunner and A. W. Brightmore, 149; the Water Supply of Fowls, W. K. Burton, 149; the Mechanism of Weaving, J. W. Fox, 149; the Steam Engine and other Heat Engines, Prof. J. A. Ewing, F.R.S., 210; Measurement Conversion Diagrams, Robert H. Smith, 221; Electrical Engineering, W. Slings and A. Brooker, 318; Death of Hermann Carlson, 344; the Determination of the Dryness of Steam, Prof. W. C. Unwin, F.R.S., 377; Death of Alfred Gibbs, 368; Death of J. C. Smith, P. Inst. C.E.,

- Ireland, 488; Naval Engineering, the Launching of Steam Propulsion, J. I. Thornycroft, F.R.S., and S. W. Barnaby, 562; Institution of Civil Engineers, Annual Banquet, 538.
- England, *Rhynchosia terestris*, in, L. W. Gumble, 33; some Early Terrestrial Magnetic Discoveries pertaining to, Will Whiston, L. A. Bauer, 295; the Development of Telegraphy in, 324.
- Entomology: Butterflies from China, Japan, and Corea, John Henry Leech, 6; Development of Laings of Spiders, O. L. Simmons, 37; Entomological Society, 46, 94, 160, 311, 430, 479, 591, 551, 575; an Observation on Moths, Dr. L. C. Jones, 79; Henry Cecil, 127; More about Moths, Dr. L. C. Jones, 324; Fomika Smaragdina, Mr. Kirley, 95; Origin of Classes among the "Parasol" Ants, Herbert Spencer, 125; Deyolle's Nickel Fastening Pin, 139; Pigments of Fleas, F. G. Hopkins, 142; the Warble Fly, W. T. Kirby, 154; a Swarm of Bees in December, 230; the Bird Winged Butterflies of the East, W. T. Kirby, 254; Robert H. T. Rippon, 343; Butterflies and Moths (British), W. Furneaux, W. T. Kirby, 369; the Black-Veined White Butterfly, W. Warde Fowler, 397; H. Goss, 391; Geographical Distribution of Butterflies, Prof. Mellblom, Dr. Sharp, F.R.S., and Mr. McLachlan, F.R.S., 479; New Indo-Malayan Butterflies, L. de Nicéville, 500; the Spinning Glands in Phymus, H. M. Bernard, 203; Injurious Insects, Eleanor A. Ormerod, 474; Entomology in America, L. P. Howard, 490; Questions bearing on Specific Stability, Dr. Francis Galton, F.R.S., 579; New Species of Termites found by Dr. Haviland, 575.
- Eocene Fossils at Murren, Right Hon. Sir John Lubbock, F.R.S., 223.
- Epidemics: a History of Epidemics in Britain, Dr. Chas. Creighton, 579.
- Epigenesis or Evolution, Prof. Dr. Oscar Hertwig, G. C. Bourne, 265.
- Erp (H. van), Study of Aliphatic Nitramines, 119.
- Espin (Rev. F. E.), Two Variable Stars, 49; a New Star, 161.
- Essex, Remarkable Oak Trees in, J. C. Shenstone, 280.
- Ethane, Liquid, the Properties of, and Propane, A. E. Tutton, 65.
- Ethnography: Internationales Archiv für Ethnographie, 525, 573.
- Ethnology: Death of Lieut.-Colonel Garriek Mallery, 91; Early British Races, Dr. J. G. Garson, 67, 90; Album von Papua-Typen, A. B. Meyer and R. Parkinson, 174; Death of Prof. J. O. Dorsey, 392.
- Eumorphopoulos (Mr.), Determination of Thermal Conductivity and Emissivity, 310.
- Evans (Maurice S.), the Fertilisation of *T. anthracinus* and *T. dregei*, 235.
- Evolution: Involution and Evolution according to the Philosophy of Cycles, 125; Epigenesis or Evolution, Prof. Dr. Oscar Hertwig, G. C. Bourne, 265; Variation in Animals and Plants, Prof. W. E. R. Weldon, F.R.S., 449; Organic Reason of Failure of Bateson's and Galton's Theories of Evolution, Dr. A. R. Wallace, 450; the Statistical Investigation of Evolution, J. T. Cunningham, 519.
- Ewing (A. R.), Metallic Tartrates, 311.
- Ewing (Prof. J. A., F.R.S.), the Steam Engine and other Heat Engines, 219.
- Ex-Meridian Altitudes, Corrections of Maximum and, J. White, 485.
- Examination Curve, the, Prof. C. Lloyd Morgan, 617.
- Exploration at Ruwenzori, G. F. Scott Elliot, 271, 527.
- Explosion, Dr. Dupré's Report on Compressed Oxygen Cylinder, 562.
- Explosion of Gases in Glass Vessels, the, Prof. H. B. Dixon, F.R.S., 151.
- Explosions, Kitchen Boiler, R. D. Munro, 197.
- Explosions in Mines, 211.
- Explosive Nature of the Sodium and Potassium Perivalates of Nitromethane, the, A. E. Tutton, 328.
- Explosives in Mines, the Use of Safety, 184.
- Explosives: Coal Dust an Explosive Agent, as shown by an Examination of the Camerton Explosion, Donald M. D. Stuart, 268.
- Fabry (Ch.), Passage of Light across Thin Plate in Case of Total Reflection, 497.
- Fabry (M. Louis), a New Form of Zenith Telescope, 594.
- Farm Vermin, Helpful and Harmful, 174.
- Fatty Acid, N. A. C., Synthesis of Hydrazine with, A. F. T. 519.
- Fauna of British Isles, including Ceylon and the Malay Moths, W. F. Kirby, 63.
- Faye (Herve), Press, 10, 30.
- Faye (H.), the New Capital of Brazil, 599.
- Fighting of Death in Schools, the, R. Harry Vincent, 224.
- Fernow (Prof. B. E.), the Battle of the Forests, 119, 139.
- Ferryman (Capt.), the Denner and Glacial Lake, 139.
- Fertilisation of *T. anthracinus* and *T. dregei*, Maurice S. Evans, 235.
- Féry (Ch.), Gratings used in Photogramy, 579.
- Fewkes (J. W.), the New Year Ceremony among the Tisbury Indians, 515.
- Figuier (Louis), Death and Obituary Notice of, 82.
- Filters, Water, Relative Efficiency of, Surgeon Major, 38, 38.
- Finger and Toe Disease, the, George Massee, 453.
- Finger-Print Method, Kumagusi Mmakata, 274; the Accuracy of the, Kumagusi Mmakata, 199.
- Finger-Prints, Sir W. J. Herschel, Bart., 77.
- Finnegan (J. M.), the Artificial Spectrum Top, B. Merritt, 292.
- Fire Ceremony, the New, among the Tisbury Indians, J. W. Fewkes, 515.
- Fisher (Prof. W. R.), Text-book of the Diseases of Trees, Prof. R. Hartig, 28; Statistical Account of French Forests, M. Daulbec, 94; Forestry in Natal, 234.
- Fisheries: the Trawling Question, Prof. McIntosh, 115; Scientific Investigations of Scottish Fishery Board, 115.
- Fitch (R.), Death of, 587.
- Fitzgerald (Prof. G. I., F.R.S.), the Kinetic Theory of Gases, 221; the Foundations of Dynamics, 283; Maxwell's Theorem of Equal Partition of Energy not inconsistent with Thermal Movement of Gas Spectra, 452.
- Fixation in Algae, Nitrogen, Rudolf Beer, 392.
- Fjords, Morphology of, P. Dunse, 111.
- Flames, Composition of Exhauptive Atmospheres produced by, Prof. Frank Chloves, 475.
- Flammation (M.), the Rotation of Venus, 21; Photographic Determination of Position of Pole, 455.
- Flather (John J.), Dynamometers and the Measurement of Power, 39.
- Flight of Birds, the Wind and the, Profs. Langley and Curtis, 159.
- Flints, the Burmese Chipped, Pliocene not Miocene, Dr. W. T. Blanford, F.R.S., 608.
- Floods in the West Midlands, H. Southall, 215.
- Floekiger (Dr.), Death of, 298.
- Flying, Lilienthal's Experiments in, 177.
- Log Signals, Acoustic, and Navigation, A. B. Johnson, 139.
- Föhn Wind in the Riesengebirge, a, Dr. Kassner, 431.
- Folgeraiter (G.), Induced Magnetism in Volcanic Rocks, 617.
- Folk-lore: on Chinese Beliefs about the North, 32; Chinese Beliefs about Caves, 57; the Mandrake, Kumagusi Mmakata, 608.
- Fonvielle (W. de), Andrée's North Pole Balloon Scheme, 421.
- Forbes (Prof. Geo., F.R.S.), the Utilisation of Niagara Falls, 205.
- Forbes (H. O.), a Handbook to the Primates, 242.
- Forand (M. de), Calcium Ethoxide, 263; Heat of Formation of Calcium Acetylide, 552; Alcoholates of Lime and Baryta, 579.
- Forecasters, the Possibilities of Long Range Weather, Prof. Cleveland Abbe, 212.
- Forecasters, Popular Weather, 612.
- Foreign Societies, Physical Society's Abstract of Physical Transactions, 321.
- Forest Birds, their Habits and Habits, Harry T. Wilson, 341.
- Forestry: Text-book of the Diseases of Trees, Prof. R. Hartig, Prof. W. R. Fisher, 28; the Planting of Timber Trees, Alfred W. Bennett, 33; Statistical Account of French Forests, M. Daulbec, Prof. W. R. Fisher, 64; the New Cypress of Nyssa, Lind. 85, W. T. Threlson Dyer, F.R.S., 175; the Battle of the Forests, Prof. B. E. Fernow, 119, 139; Forestry in Natal, Prof. W. R. Fisher, 234; Forest Preservation, Prof. W. R. Sargent, 389; Contribution of Trees caused by Cold, J. Clayton, 392.
- Forster (Dr. A. L.), Central European River Temperature Variations, 83.
- Forster (M. O.), New Diatomic Amphor Derivatives, 359.

- Fertilizing Reagents, Science in the, 44, 161, 450, 545.  
 Fossil "Lumps," or Calamities, Drs. Williamson and Scott, 94.  
 Fossils: Fossil Fossils at Marren, Right Hon. Sir John Lubbock, F.R.S., 223; the Mastodons of Russia, Marie Farkas, 357; the Fossiliferous Mammals of East Russia, Prof. S. P. Lavrenko, 357; the Geological Distribution of Fossils, Messrs. James Frowie, Meyer and Gregory, 470; Pachytherium, A. G. Seward, 487.  
 Foster (Prof. M.), F.R.S., Physiology for Beginners, 165; on the Teaching of Physiology in Schools, 487; *Algeologie*, physiologische Grundriss der Lehre vom Leben, Max Avenhorn, 520.  
 Foster-Melliar (Rev. A.), the Book of the Rose, 302.  
 Foucault's Pendulum Experiment, the, G. A. R., 70.  
 Foucault's Pendulum at Dublin, A. W. K. Westropp Roberts, 510.  
 Foucault's Photographical Researches, W. H. Harrison, 200.  
 Fowler (A.), *Mira*, Oct., 40; the Lick Observatory, 201; American Topography, Prof. Henry Gamet, 274.  
 Fowler (W. H.), Boiler Explosions, 345.  
 Fowler (W. Warde), Summer Studies of Birds and Bees, 321; the Black-veined White Butterfly, 307.  
 Fox (Howard), the Unsolved Problems of Cornish Rocks, 30.  
 Fox (J. W.), the Mechanism of Weaving, 140.  
 France: France, the Elasticity of Solid Gelatine Solutions, 320.  
 France: Statistical Account of French Forests, M. Dautzenberg, Prof. W. K. Fisher, 64; the Anti-Tubercle Treatment of Diptheria in France, 83; the Deserts of Southern France: an Introduction, S. Baring Gould, and Chalk Plateaux of Ancient Aquitaine, S. Baring Gould, Canon Benney, F.R.S., 100; Oyster Culture on the West Coast of France, Prof. W. A. Herdman, F.R.S., 162; Aeronautes in France, Prof. Cornia, 200; French Scientific Expedition to Central Asia, 421; New Metric System adopted, 613; Annual Exhibition of French Physical Society, 613.  
 Frenching (Dr. M.), Urethral, 504.  
 French: French Laboratory Exercise Book for Chemical Students, 270.  
 French: French (Dr. F.), F.R.S., Conditions affecting Bacterial Life in Tissues, Water, 500.  
 French: French (Mrs. Percy), *Lehrbuch der Bakteriologischen Untersuchungen und Diagnostik*, Dr. Ludwig Heintz, 481; *Microbiologie Médicale*, 611.  
 French: French (C. L.), the Normal Defect of Vision in the Fovea, 615.  
 French: French (A. E.), Cows kept in Caves by Anal, 325.  
 French: French (J. J.), Dilute Solution, the, J. W. Rodgers, 617.  
 French: French (Dr. Armand), Esters of Arsenious Acid, 616.  
 French: French (J. E.), Balance and Steadiness in First-class Battleships, 590.  
 French: French (Sir Edward), F.R.S., What are Acquired Characters? 83; Acquired Characters, 107.  
 French: French (J. D.), Lannay, *Traité des Gênes Mûnières et des Maladies*, 555.  
 French: French (W.), Fleas and Moths (British), W. E. Kirby, 330.  
 French: French (Companions), Morphology of, H. M. Bernard, 455.  
 French: French (G.), Evaporation of Air and other Gases, 495; the Diffusion of Air, 573.  
 French: French (F. R. S.), Acquired Characters, 56; Psychology of Organic Cells, Journ. of Echees, Alfred Binet, 731; New Steps in Animal Science, 319; Questions bearing on Spontaneous Generation, 579; Relation of Failure of Galton's Theory of Organic Evolution, Dr. A. R. Wallace, 450.  
 French: French (W.), *Chrysothrix*, 53.  
 French: French (A.), Petrol and Dipropylol Rays of Electric Force, 76.  
 French: French (F.), Progress of Invention, 614.  
 French: French (M.), *Introduction à l'Étude de Jules Garçon*, 164.  
 French: French (F. R. S.), the Spontaneous Generation of Stars, 274; the First Echinoderm in the Vertebrate, 343.  
 French: French (A.), *Electricity and Propagation*, 340.  
 French: French (A.), *Atmosphere and Electric Currents*, 340; *Met. Soc. Suppl.*, 359.  
 French: French (J.), *Éclairage*, New Electric Lamps, 340; *Éclairage*, M. J. B. de la Nativité, H. J. P. de la Nativité, 340; *Éclairage*, M. J. B. de la Nativité, 340.  
 French: French (J.), *Éclairage*, British Paper, 307.  
 French: French (Dr. F.), *Éclairage*, 35.  
 French: French (K.), *Éclairage*, F. W. L. G., 78, 581; *Éclairage*, F. W. L. G., 152; S. H. B., 152; F. W. L. G., 75; Prof. G. F. Fitzgerald, F.R.S., 221; Rev. H. W. Watson, F.R.S., 222; Prof. Arthur Schuster, F.R.S., 203; G. H. Bryan, 31, 152, 176, 310; Prof. Boltzmann's Letter on the Kinetic Theory of Gases, 581; on Certain Questions of the Theory of Gases, Prof. Ludwig Boltzmann, 413; the Ratio of the Specific Heats of Gases, S. H. Burbury, F.R.S., 127; the Explosion of Gases in Glass Vessels, Prof. H. B. Dixon, F.R.S., 151; Electric Discharge through Gases, Prof. J. J. Thomson, 330; Electrification of Air and other Gases, Lord Kelvin, F.R.S., Magnus Maclean, and Alexander Galt, 495; on the Liquefaction of Gases, Prof. Charles Olszewski, 245; Prof. James Dewar, F.R.S., 245, 305, 413; M. M. Pattison Muir, 304, 388, 439.  
 French: French (Fernand), the Oxidation of Acids by Fehling's Solution, 600; the Conversion of Lactic Acid into Propionic Acid, 144.  
 French: French (M.), Superposition of Optical Effects of Several Asymmetric Carbon Atoms in same Active Molecule, 47; Superposition of Optical Effects of different Asymmetric Carbon Atoms in same Active Molecule, 168.  
 French: French (H.), *Leçons de Chimie*, 450.  
 French: French (H.), Variations in Character of Seasons, 357.  
 French: French (William), Short Studies in Nature Knowledge, 557.  
 French: French (Sir Archibald), F.R.S., Twenty-five Years of Geological Progress in Britain, 307; Memoir of Sir A. C. Ramsay, 385.  
 French: French (Herr), Action of Light in producing Electric Discharge through a Vacuum Tube, 514.  
 French: French (Prof. Eugenio), *Optica*, 244.  
 French: French (Morphology): Lithogenesis der Gegenwart, J. Walther, 313; Geotektonische Probleme, A. Rothpletz, 313; Morphologie der Erdoberfläche, Dr. A. Penck, 313.  
 French: French (Geography): American Government Surveys, 19; the Alaskan Frontier Survey, 19; Mount Logan and Mount St. Elias, 19; the Absorption of the North American Indian Reservations, 19; the Anglo-German Frontier Survey in East Africa, C. S. Smith, 19; Commercial Geography, E. C. K. Gomper, 30; M. Trevon-Battye's Visit to Kolguet Island, 36; Dr. Donaldson-Smith's Expedition to Lake Rudolf, 61; British Central Africa Protectorate, H. H. Johnston, 66; a pre-Columbian Discovery of America, Yale Oldham, 83; the Morphology of Fjords, P. Düse, 114; Climbing and Exploration in the Karakoram-Himalayas, William Martin Conway, 160; American Topography, A. Fowler, 274; Recon of Mr. G. L. S. Elliot, 208; M. Scott Elliot's Exploration of Mount Kuwenzi, 271, 208, 441, 527; Baner-Toll's Siberian Expedition, 327; Peru, E. W. Mendenhall, 388; Relation of Gravity to Continental Elevation, T. C. Mendenhall, 430; Influence of Temperature on Distribution of Animals and Plants, Dr. C. H. Merriam, 441; the Nile, Sir Colin Scott-Moncrieff, 444; Paris Geographical Society's Prize Award for 1895, 489; Death of Sir Edward Bulbary, 498; Survey of Lakechun (Tibet) Depression, M. Kobrovsky, 491; New Law of Geographical Dispersal of Species, Chas. Dixon, 545; the New Capital of Brazil, H. Lave, 500.  
 French: French (Geology): the Unsolved Problems of Cornish Rocks, Howard Fox, 30; the Roots of Calamities, Drs. Williamson and Scott, 94; Eugene Rock at Marren, Sir J. Lubbock, 94; Recent Sections in Malvern Hills, Prof. A. H. Green, F.R.S., 94; the South Denbighshire Series, Philip Lake, 94; Geological Society, 94, 143, 190, 230, 357, 400, 478, 502, 527, 575, 599; the Deserts of Southern France, S. Baring Gould, Canon Benney, F.R.S., 160; Mutual Alterations of Basaltic Andesite and Later Lignite, Prof. Cole, 112; the Malta Pleistocene Beds, J. H. Cooke, 143; the Iowa Survey, 157; Curious Limestone Cascade Formation in Iowa, 157; Eocene at Marren (Correction of Sir John Lubbock, p. 94), Dr. E. de Tollenberg, 180; the Iron-bearing Rocks of Mesabi Range in Minnesota, J. E. Spurr, 182; the Tarns of Lakeland, J. E. Marr, F.R.S., 190; Eocene Fossils at Marren, Right Hon. Sir John Lubbock, F.R.S., 223; on the Age of the Earth, Prof. John Perry, F.R.S., 224, 341, 582; Prof. Tait, 226; Lord Kelvin, 227, 438; Prof. W. J. Sollas, F.R.S., 533, 558; Dr. Bernard Hobson, 558; Dr. Alfred R. Wallace, F.R.S., 677; C. Davison, 607; Canadian Geological Survey, 230; Lower Green Sand of East Surrey, T. Leighton, 230; Study of Erupted Blocks from Monte Somma, Prof. Johnston Lavis and Dr. J. W. Gregory, 251; Disproof of Organic Nature of Fozzon, Prof. Johnston-Lavis and Dr. J. W. Gregory, 251; the Lebensweise der Meeressthere, Beobachtungen über das Leben der Geologisch-wichtigen Thiere, Prof. Johannes Richter, 260; Similarity of Baluchistan and Pyrenean

- Echinoids, Dr. Noetting, 280; L. C. L. der Echinoderm, Dr. Ferdinand Zirkel, 200; L. C. L. der Echinoderm, Dr. Johannes Wulther; Geotektonische Probleme, A. K. 1895, 21; Morphologie der Erdoberfläche, Dr. Albert Penck; Dr. J. W. Gregory, 313; Origin of Alpine Serpentine, Dr. W. S. Chenk, 320; Alpine Gneiss and Granite, Dr. Weissbach, 313; Prof. Low, 320; Late Glacial of Champlain Submergence, Re-elevation of St. Lawrence River Basin, Warren Upland, Hayden Medal awarded to Prof. D. Price, 345; the Mesozoics of Russia, Marie Pavlova, 357; the Post-Pliocene Mammals of East Russia, Prof. Stuckenberg, 357; the Formation of Oolite, E. B. Wehberd, 357; Liass Irons, around Bailany, L. A. Walford, 358; Geology of Anatolia, W. F. Wilkinson, 358; Twenty-Five Years of Geological Progress in Britain, Sir Archibald Geikie, F.R.S., 307; the Astronomical Theory of the Ice Age, E. P. Culverwell, 373; Japanese Additions to Paleobotany, 371; Remains of Sponges in Phylinites of Pre-Cambrian of Brittany, L. Cayeux, 382; Memoir of Sir Andrew Crombie Ramsay, Sir Archibald Geikie, 385; Carrock Fell, Alfred Harker, 406; Les Abîmes, les eaux souterraines, les Cavernes, les sources, la speleologie, L. A. Martel, Camille G. Bonney, F.R.S., 410; the Fauna of the Lower Cambrian, Prof. W. K. Brooks, 423; Glacial Phenomena of Newfoundland, Labrador, and South Greenland, G. L. Wright, 430; the Glaciation of Mount Rawson, Scott Ethor, 441; the Late and Correspondence of William Buckland, D.D., F.R.S., Mrs. Gordon, 457; the Barrenness of Pre-Cambrian Rocks, Dr. C. Callaway, 462; the Geological Distribution of Fossils, Messrs. Jukes-Browne, Meyer, and Gregory, 470; Physical Conditions of Mediterranean Basin, Prof. E. Hull, 478; Superficial Deposits of Shanang, S. B. J. Skeriffly and T. W. Kingsmill, 478; Parky, A. C. Seward, 480; Sequence of Barbados Rocks, Dr. J. W. Gregory, 502; Sea and Land, Features of Coasts and Oceans, with Special Reference to the Life of Man, Prof. N. S. Shaler, 507; Geological Researches in Connection with Siberian Railway, 500; Geological Distribution of Brachiopoda, Agnes Gauc, 514; Appalachian Type of Folding, C. D. Walcott, 525; Fossil Faunas at Springfield, Missouri, Stuart Weller, 525; Duff Boulders between Mohawk and Susquehanna Rivers, A. P. Brigham, 525; New Ossiferous Fissure in Creswell Crags, W. L. H. Duckworth and L. E. Swainson, 527; Chemical Composition of Oceanic Deposits, Prof. J. B. Harrison and A. J. Jukes-Browne, 527; Traité des Gîtes Minéraux et Métallifères, E. Fuchs and L. de Launay, 555; Etude industrielle des Gîtes Métallifères, George Moreau, 555; Annals of British Geology, 1893, J. E. Blake, 557; the Fossil of the Gotland Silurian, Prof. Lindström, 563; Fluvio-Glacial and Tertiary Glacial Deposits in Switzerland, Dr. Piellen, 575; Death of Prof. J. D. Dana, 587; Death of R. Fitch, 587; Comparison of Russian and African (Karoo) Permian Freshwater Shells, Dr. Amalitsky, 599; Collected Papers on some Connected Questions of Geology, Joseph Prestwich, F.R.S., Prof. F. W. Judd, F.R.S., 601; the Barrowe Chipped Flint, Pliocene not Miocene, Dr. W. T. Blanford, F.R.S., 608; Niagara and the Great Lakes, F. B. Taylor, 610
- Geometry: Anwendung der Quaternionen auf die Geometrie, Dr. P. Molenbroek, 76; the Outlines of Quaternions, Lieut. Colonel H. W. L. Hime, 70; Geometry in Schools, Edward M. Langley, 176; an Introductory Account of certain Modern Ideas and Methods in Plane Analytical Geometry, Charlotte Angus Scott, 483
- German Imperial Physico-Technical Institute, Fifth Report of, 20
- Germany, *Alysi hodimus terrestri* in, H. Sauerh, 204
- Giacoia (Dr. Piero), Italian Scientific Expedition to Mount Rosa, 57
- Giantes and Gigantism, Dr. C. L. Dorr, 381
- Gilbes (Prof. L. Lewis R.), Death of, 324
- Gilberne (Agnes), Radiant Suns, 174
- Gilbert's (Dr.), Researches on Development of School-children, 232
- Giles (Alfred), Death of, 468
- Girard (Ch.), Chemical Process for Purification of Water, 552
- Gîtes Metallifères, Etude Industrielle des, George Moreau, 555
- Gîtes Minéraux et Métallifères, Traité des, E. Fuchs and L. de Launay, 555
- Glacial Phenomena of Newfoundland, Labrador, and South Greenland, E. F. Wright, 430
- Glaciation: a Criticism of the Action and a Theory of the Ice Age, Edward P. Culverwell, 373
- Glover L., 214; the Cephalopod Embryo, 13
- Gluster, Dr. J. H., F.R.S., Argon, 380; the Gluster System, 502
- Gluster (John), Sir William, Smellie and his Chemistry, 144
- Glass, Aventurine, H. S. Wasington, 112
- Glass, Green, in Plant Houses, 514
- Glass, Simplified Process for Silver, G. A. and L. L., 375
- Glass Vessels, the Explosion of, G. A. and L. L., 375
- Glass, F.R.S., 151
- glass-blowing: Die Bearbeitung von Glasen und dem Blasen von Glas, D. Diakonow und W. Lennart, 359
- Glazebrook (F. T.), F.R.S., Meteorology, Colleges and Schools; Statistics, 484
- Glebe, the Use of, in Crystallography, J. V. B. F. and F. R. S., 184; William J. Pope, 223
- glow Lamps, 250, 358
- Glibbo P. C., the Sowing of Seeds, 1-7
- Glycerin in Blood, M. Käuffmann, 593
- Göbeln (Dr. F. A.), Breeding Habits of Brazil, T. J. G., 497
- Gold Discovered in Isle of Man, 200
- Gold Nuggets, the Structure of, Prof. Liversidge, F.R.S., 47
- Goldsmith (E. G.), Volcanic Sulfates, 128
- Goldstein (Prof.), Effect of Cathode Rays on Chloride of Ammonium Salts, 62, 400
- Gorner (F. C. K.), Commercial Geography, 30
- Gordon (Suggon General C. A.), the Island of Man, and the Invald and Naturalist, 107
- Gordon, Mrs., the Late and Correspondence of William Buckland, D.D., F.R.S., 457
- Goss (H.), the Black-veined White Butterfly, 301
- Goth (Prof. Francis, F.R.S.), the Present State of Physics, 200
- Goto (Seitaro), Studies on the Leco-parasite, Frenates in Japan, 244
- Göttingen Royal Academy, 408
- Göttingen Royal Society, 60, 624
- Gradient-Telemeter Level, 412
- Granite, the Quarrying of, in India, Dr. H. Worth, 272
- Graphic Statics, the Elements of, L. M. Hoskins, 7
- Graphite, the Varieties of, H. Moissan, 101
- Grasset (E.), Physiological Properties of Oxalate and Citrate of Stilled Salts of Nootine, 204
- gravitation: Dr. J. Joly, F.R.S., 57, 127, 223; Prof. A. J. Worthington, F.R.S., 70; Prof. Oliver J. Lodge, F.R.S., 154
- gray (Prof. A.), Les Oscillations Electriques, H. Poincaré, 301
- Green (Prof. A. H.), F.R.S., Recent Sections in Malvern Hills, 194
- green Glass in Plant Houses, 514
- Greener (J. H.), Death of, 501
- Greenhall (Prof. A. G.), F.R.S., the Science of Medicine in a Critical and Historical Exposition of its Principles, Dr. Ernest Mach, 191; the Alleged Absoluteness of Motions of Rotation, 105; the Dynamics of a Top, 309
- Greenland, Meteorological Station established at Angmagssalik, 27
- Gregory (Dr. J. W.), Analogy between Vesuvian Block and African Rock masses, 251; Lithogenesis der Gegenwart, Johannes Walther, 313; Geotektonische Probleme, A. K. 1895, 21; Morphologie der Erdoberfläche, Dr. Albert Penck, 313; the Geological Distribution of Fossils, 470; Sequence of Barbados Rocks, 502
- Gregory (R. A.), the Planet Lathra; an Astronomical Introduction to Geography, 201; the Advancement of Technical Education, 370
- Gregory (N.), Carbon Monoxide Produced by Combustion of Electric Arc, 922
- Gregorys (E. H.), Capacity for Heat, 114; Specific Heat of Air, 714; Latent Heat of Evaporation of Water, 334
- Grisebach (M.), the Specific Heat of Tungsten, 424
- Grison (Beny), Monocyclodolones Saprophytes, 203
- Gross (Dr.), Electrolysis of Solution of Mixed Nitrate of Silver-plasma with Nitric Acid, 288
- Grosse (Dr. F.), Die Anfänge der Kunst, 241
- Gross (Dr. Hermann), Death of, 488
- Gross (E.), Fossils in Yorkshire, J. F. Harting, 422
- Growth of St. Louis Children, the, William Fowles; Porter, Prof. Karl Pearson, 145
- Gross (Hermann), Death of, 344
- Guélin (Sig.), Method of Identifying Foucault's Water without Withdrawal of Solid immersed therein, 237
- Gulf Forest, in the, James Rodway, 387

- Geometric Centre, the Centres of Mass of Plant-Nuclei, 113  
 Geysers, the Measurement of Pressures in, Rev. F. Haskforth, 401  
 Geysers, the Simple Demonstration of Presence of Argon in Atmospheric Nitrogen, 500  
 Geysers, Dr. H. B., Method of Determining Influence of Springs on Water-Temperature, 110  
 Geysers, H., Catalogue of the Birds of Prey (Accipitres and Strigidae), 532  
 Geysers, Arthur E., Electric Light and Power, 30  
 Geysers, P. A., Superposition of Optical Effects of several Asymmetric Carbon Atoms in same Active Molecule, 47; the Essential Salts derived from Active Amyl Alcohol, 144; Superposition of Optical Effects of Different Asymmetric Carbon Atoms in same Active Molecule, 168; Optical Resolution of  $\alpha$ -Oxybutyric Acid, 503  
 Geysers, Prof. Hugo, the Mean Parallax of Stars, 21  
  
 Geology (Dr. Wilhelm) Die Schöpfung der Tierwelt, 140  
 Geology, Hypophosphites of Mercury and Bismuth, 350  
 Geology (Prof. A. C.), Die Anfänge der Kunst, Dr. E. Grösser, 241  
 Geology (G. F.), Snakes, "Playing Possum," 127  
 Geology, Acidimetry of Hydrogen Fluoride, 430  
 Geology (August), Thermocouples of Metals and Saline Solutions, 70  
 Geology, F. Norman, G. J. Symons, 24  
 Geology of Switzerland, 1883-93, Dr. C. Hess, 230  
 Geology (Dr.), the Properties of Liquid Ethane and Propane, 65  
 Geology (Dr. John), Black Damp, 477  
 Geology (Dr. Wm. H.), the American Association, 300; the Recent Storm in the United States, 417  
 Geology (A.), Philoosophic Study of Colouring Matters from Terphenylmethane, 455  
 Geology (Dr. J.), a Text-book of Pathology, 148  
 Geology (Dr. K.), American Fresh-water Sponges in Ireland, 511  
 Geology (Dr. J.), Kantal of Sandwich Islands, 500  
 Geology (C.), the Gale of December 21, 22, 1894, 311  
 Geology (H. J.), Alpine Climates for Consumption, 54  
 Geology (E.), Application of Sound-Vibrations to Analysis of Two Gases of Different Densities, 407  
 Geology, the Arctic, in Ireland, 614  
 Geology (Alfred), Carrook Fell, 406  
 Geology (Prof. Allen), Death and Obituary Notice of, 206  
 Geology, Harmonic Analyser, a Simple Form of, G. C. Vule, 501  
 Geology (Prof. J. B.), Chemical Composition of Oceanic Deposits, 527  
 Geology (W. H.), Foucault's and Bayard's Photographic Researches, 260  
 Geology (H.), Fernatus in the West Indian Islands, 511  
 Geology (Prof. R.), Text-book of the Diseases of Trees, Prof. W. K. Fisher, 20  
 Geology (J. L.), Attitudes adopted by Birds for Concealment, 181; Invasion of North and North-East Coasts by Little Auk, 422; Grouse Food in Yorkshire, 422  
 Geology (Dr. F.), a New Variable Star of the Algol Type, 64  
 Geology (Prof. Leonard), Recent Work at, Prof. E. C. Hilberking, 320  
 Geology, Harvard College by an Oxonian, George Birkbeck Hill, 386  
 Geology (Brown G. A.), the Starling in Scotland, 286  
 Geology (Prof. von), Death of, 278  
 Geology (Dr.), New Species of Ternites found by, 575  
 Hawaiian Islands, Disturbances in Direction of Plumb-line in, F. D. Preston, 610  
 Hawkins (Dr. F. R.), F.R.S., Death of, 180  
 Hawthorn (L.), Synthesis of  $\alpha$ -methylbutyrolactone, 526  
 Hay (Dr. Geo.), New Method of Carrying Courses at Sea, 215  
 Hay (Roberts), Water Power applied by Electricity to Gold-dredging, 470  
 Haycraft (H. C.), Student's Apparatus for Determining Mechanical Equivalent of Heat, 230  
 Haycraft (H. H.), Death of, 513  
 Hayward (Jane Mary), Bird Notes, 532  
 Haze (Prof. H. A.), Sun-spots and Auroræ, 46; Balloon Ascent by F. A. Andree, 325; the Moon and Kantall, 451  
 Heat, Capacity for, F. H. Griffiths, 11  
 Heat of Water, Determination in Electrical Units, of Specific, F. C. A. Schuster, F.R.S., and W. Cannon, 214  
 Heat, Student Apparatus for Determining Mechanical Equivalent of, Prof. W. T. Ayrton, and H. C. Haycraft, 230  
 Heat Engines, the Steam Engine and other, Prof. J. A. Ewing, F.R.S., 210  
 Heath (Grace), Science Teaching in Schools, 50  
 Heaviside (Oliver, F.R.S.), Electromagnetic Theory, J. Swinburne, 171  
 Heidenreich (Herr), Carbazide and Di-urea, 30  
 Heim (Dr. Ludwig), Lehrbuch der Bakteriologischen Untersuchung und Diagnostik, Mrs. Percy Frankland, 481  
 Helical Gears, A Foreman Pattern Maker, 30  
 Heliotropism, Dr. W. Kothert, 84  
 Helium, Terrestrial, 512; Prof. Ramsay, 543; W. Crookes, F.R.S., 543; J. Norman Lockyer, C.B., F.R.S., 580  
 Hellmann (Prof. G.), the Invention of the Barometer, 422; Wind Velocity at Berlin, 401, 623; Die ältesten Karten der Isogonen, Isoclimen, Isodynamen, 500  
 Helm (Dr. G.), Grundzüge der Mathematischen Chemie, 580  
 Helmholtz (Hermann von), the Physical Work of, Prof. A. W. Rucker, F.R.S., 44, 472, 403; Proposed Monument to, 613  
 Henderson (G. G.), Metallic Tartar-emites, 311  
 Henderson (J.), Electrolysis of Potassium Azo Ethylic Camphorate, 621  
 Henderson (Capt.), Flying Copepods, 300  
 Hendri (O.), Science Teaching in Schools, 100  
 Henry (Charles), Influence of Rhythm of Successions of Interruptions on Sensitiveness to Light, 330; Effect of Rhythm on Visibility of Signals, 588  
 Henry (Louis), Methylene Lactate, 620  
 Hercules, the Variable Star Z, 616  
 Herdman (Prof. W. A., F.R.S.), Drift Bottles in the Irish Sea, 151; Oyster Culture on the West Coast of France, 102; the Port Erin Marine Biological Station, 281  
 Heredity, Acquired Characters, Rt. Hon. Sir Edw. Fry, F.R.S., 8, 107; Prof. E. Kay Lankester, F.R.S., 54, 102, 245; Prof. Edward B. Poulton, F.R.S., 55, 120; Francis Galton, F.R.S., 50; J. T. Cunningham, 120, 203; John Cleland, 204  
 Hermaphroditism in Mollusca, Dr. Paul Pelsener, 213  
 Herschel (Prof. A. S., F.R.S.), Aurora of November 23, 1894, 240; the Aurora of November 23, 1894, 350  
 Herschel (Sir W. J., Bart.), Finger Prints, 70  
 Hertwig (Prof. Dr. Oscar), Zeit und Streithagen der Biologie, 205  
 Hertz, the Foundations of Dynamics, Prof. G. F. Fitzgerald, F.R.S., 283  
 Hertz (A.), Potential Gradient in Positive Portion of Glow Discharge, 406  
 Hesper and Phosphor, Kumagusu Minakata, 417  
 Hess (Dr. C.), Swiss Hailstorms, 1883-93, 230  
 Hewitt (C. J.), Manufacture of Standard Screws for Machine-made Watches, 22  
 Hewitt (J. T.), Elementary Practical Chemistry, Inorganic and Organic, 364  
 Hill (George Birkbeck), Harvard College by an Oxonian, 386  
 Hill (J. P.), New Species of Enteropennea from New South Wales, 264; Platypus Embryo from Intrauterine Egg, 204  
 Hill (Prof. Leonard), Influence of Force of Gravity on Circulation, 238  
 Hime (Lieut.-Colonel H. W. L.), Outlines of Quaternions, 154; the Elements of Quaternions, 201  
 Himstedt (E.), a New Determination of the Ohm, 571  
 Hind (Dr.), Comet 1894 E. (Denning and Brorsen's Comet), 302  
 Historical Epidemiology, 570  
 History, the Beginnings of, G. Maspero, 122  
 History as a Science, Prof. Prothero, 162  
 History, Science and, Alfred H. Huth, 176  
 Hobson (Dr. Bernard), the Age of the Earth, 558  
 Hodgkins Prizes, the, Prof. S. P. Langley, 202  
 Hoernes (Dr.), Prehistoric Objects in North-east Italian Museums, 157  
 Hofsma (Dr.), Behaviour of Hydrogen to Palladium at Various Temperatures and Pressures, 624  
 Holtzapffel (J. J.), Applications of the Sand-Blast, 588  
 Homing of Lempits, the, Prof. C. Lloyd Morgan, 127  
 Homogeneity of Structure the Source of Crystal Symmetry, Wm. Barlow, 58; H. A. Miers, 79  
 Honduras, the Earthquake of November 1894 in, J. Crawford, 280  
 Hong Kong and Jamaica, Caterpillar Tree Plagues in, 231  
 Hopkins (E. G.), Pigments of Ferriide, 142  
 Hopkins (William J.), Preparatory Physics, 436



- Horn Expedition to Central Australia, the, Prof. Wm. Spencer, 222
- Hoise, the, Prof. N. S. Shaler, 44
- Horse Breeding for Farmers, Alfred F. Pease, 435
- Horticulture: Royal Horticultural Society, 281; the London Rose, Rev. A. Foster-Melliar, 302; the Origin of the Cultivated *Cineraria*, W. Bateson, F.R.S., 605
- Hoskins (L. M.), the Elements of Graphic Statics, 7
- Howard (L. P.), Entomology in America, 400
- Hübner (Prof.), Origin of the Ammon, 624
- Hughes (Prof. D. E., F.R.S.), the Early History of Photography, 541
- Hughes (George), the Construction of the Modern Locomotive, N. J. Lockyer, 97
- Hulke (John Whitaker, F.R.S.), Death and Obituary Notice of, 392
- Hull (Prof. E., F.R.S.), Physical Conditions of Mediterranean Basin, 478
- Human Species, the Varieties of the, Prof. Giuseppe Sergi, 595
- Hungary, Earthquake in, 206
- Hunt (H. A.), Southerly Barsters, 230
- Hurricane Signal, New, 344
- Hurst (Dr. C. Herbert), a True Spectrum Top and a Complementary One, 516
- Huth (Alfred H.), Science and History, 176
- Hutton (Arthur Wollaston), the Vaccination Question, 140
- Huxley (Right Hon. T. H., F.R.S.), Past and Present, 1; the Life of Sir Richard Owen, 160; Paleontology at the Royal School of Mines, 223
- Hyde (Ida H.), the Developmental History of Medusa, 231
- Hydrazine, an Inorganic Mode of Preparing, Dr. Duden, 361
- Hydrazine, New Compounds of, with Fatty Acids, A. E. Tutton, 516
- Hydrazine  $N_2H_4$ , Isolation of Free, M. Lohry de Bruyn, A. E. Tutton, 544
- Hydrocarbons, the Commercial Synthesis of Illuminating, Prof. Vivian B. Lewes, 303
- Hydrogen, Determination of Critical Temperature and Boiling Point of, Prof. Olszewski, 488
- Hydrogen, Phosphoretted, a New Method of Preparing, Prof. Retgers, 23
- Hydrography, Critical Revision of Estimates of Average Ocean Depth, Dr. Karstens, 111; the Relative Densities, &c., of Atlantic and Mediterranean Waters, J. V. Buchanan, 468; Cruise of *Nagasaki* in Arctic Ocean, N. Knipovich, 500
- Hydrostatics, an Elementary Text-book of, W. Briggs and G. H. Bryan, 509
- Hygiene: a Treatise on Hygiene and Public Health, Thomas Stevenson and Shirley F. Murphy, 124; the Disinfection of Fecal Matter by Copper Sulphate, H. Vincent, 168; Air, Water, and Disinfectants, C. M. Akman, 412
- Hygrometer, a New, Dr. Verschaffelt, 167
- Ice Age, a Criticism of the Astronomical Theory of the, Edward P. Culverwell, 33; E. P. Culverwell, 371
- Icthyology: the Achromatic Spindle in Spermatoocytes of Elasmobranch Fishes, J. E. S. Moore, 140; Studies on the Ectoparasitic Trematodes of Japan, Seitaro Goto, 244; New Species of Enteropneusta from New South Wales, J. P. Hill, 264; Gases of Swimming Bladder of Fishes, Jules Richard, 576
- Identification: Finger-Prints, Sir W. J. Herschel, Bart, 77; the Antiquity of the Finger-Print Method, Kumagusu Mumakata, 199, 274
- Illinois River, Biological Work on the, 503
- Illuminating Hydrocarbons, the Commercial Synthesis of, Prof. Vivian B. Lewes, 303
- Ince (W. H.), Adipic Acid and Derivatives, 311
- Index: Kewensis Plantarum Phanerogamarum, Sumpfbius Beatr. Caroli Roberti Darwin ductu et consilio, Josephine D. Hooker, confect B. Daydon Jackson, Fasciculus in., 54
- India: Dr. Watt's Dictionary of the Economic Products of India, 4; W. T. Thiselton-Dyer, F.R.S., 150; Dr. V. Ball, F.R.S., 150; Reise nach Südindien, Emil Schmidt, 161; the Quarrying of Granite in India, Dr. W. H. Warth, 272; the Fauna of British India, including Ceylon and Burma Moths, W. F. Kirby, 605
- Indian (North American) Reservations, the Absorption of the Indian Islands, West, F. J. G. S. The, H. Hart, 511
- Indiana University, a Bill for its Status to be Established in North Indiana Lake, 422
- Indo-Malayan Spiders, The, Prof. J. M. E. Workman, R. I. Pocock, 60; E. A. Munn, 153
- Infra-Red Spectrum, on Recent Researches in the, Prof. S. I. Langley, 12
- Ink-Crystals, 60
- Instinctive Attitudes, S. S. F. E. E., 31
- Institution of Civil Engineers, Annual Banquet, 538
- Institution of Mechanical Engineers, 22, 377
- Institution of Naval Architects, 568
- Intercolonial Astronomy and Meteorology, 278
- Internationales Archiv für Ethnographie, 525, 573
- Invention, the Origins of, Oms T. Mason, 557
- Involution and Evolution according to the Philosophy of Coleridge, 125
- Ireland, American Fresh-water Sponges in, Dr. R. Hamilton, 511
- Ireland, the Arctic Hare in, 614
- Iridium, Magnetic Properties of, S. H. Brackett, 158
- Irish Sea, Drift Bottles in the, Prof. W. A. Herdman, F.R.S., 151
- Iron, Slow Changes in Magnetic Permeability of, W. M. Morley, 526
- Irvine (Robert), Dr. John Murray and, Chemical Changes between Sea-Water and Oceanic Deposits, 304
- Isle of Man, Gold discovered in, 200
- Isolation of Free Hydrazine  $N_2H_4$ , M. Lohry de Bruyn, A. E. Tutton, 544
- Italian Scientific Expedition to Monte Rosa, Dr. Piero Guaiardotti, 57
- Italy, Earthquake in, 110, 513, 587
- Jamaica, Bulletin of the Botanical Department, 412
- Jamaica and Hong Kong, Caterpillar Tree-Plagues in, 231
- Janssen (Dr.), Novel Methods in Photometry, 395
- Janssen (J.), this Winter's Minimum Temperatures on Mont Blanc, 622
- Japan: Butterflies from China, Japan, and Corea, John Henry Leech, 6; Studies on the Ectoparasitic Trematodes of Japan, Seitaro Goto, 244; Japanese Additions to Palaeobotany, 371; Destruction of the Seismological Observatory at Tokio, Prof. I. W. Judd, F.R.S., 533
- Japp (F. K.), Condensation of Benzil into Ethyl Malonate, 143
- Jannuani (G.), the Process of Light Emission, 334
- Joachim (Dr. G.), Effect of Suspension of Heat on Circulation, 288
- Johnson (A. B.), Acoustic Log Signals and Navigation, 130
- Johnson (Charles, W. L.), Pseudo-Satellites of Jupiter in the Seventeenth Century, 285
- Johnston (Surgeon-Major), Relative Efficiency of Water-Filters, 38
- Johnston-Lavis (Prof.), Study of Ejected Blocks from Monte Somma, 251
- Johnstone (H. H.), British Central Africa Protectorate, 66
- Johstrup (Prof. F.), Death of, 229
- Joly (Dr. J., F.R.S.), Gravitation, 57, 127, 223; the Ascent of Sap, 93
- Jones (Dr. L. C.), an Observation on Moths, 79; More about Moths, 321; a Snake "Playing Possum," 107
- Jouquier (M. de), Demonstration of a Theorem of Whole Numbers, 503
- Jordan (Ch.) Optical Resolution of  $\alpha$ -Oxybutyric Acid, 503
- Journal of the Academy of Natural Sciences of Philadelphia, 26
- Journal of Anatomy and Physiology, 93
- Journal of Asiatic Society of Bengal, 500
- Journal of Botany, 23, 430
- Journal of Russian Chemical and Physical Society, 452
- Jovett (H. A. D.), Avonitine Aurichlorides, 430
- Judd (Prof. J. W., F.R.S.), Massive Minerals from India and Australia, 431; Destruction of the Seismological Observatory at Tokio, Japan, 533; Collected Papers on some Controversial Questions of Geology, Joseph Prestwich, F.R.S., 601
- Jukes Browne (A. J.), the Geological Distribution of Fossils, 470; Chemical Composition of Oceanic Deposits, 527
- Jungfleisch (E.),  $\beta$ -Oxybenzoinone, 264; Cinchonine, 407
- Jupiter: W. F. Denning, 227; Recent Observations of, Prof. F. E. Barnard, 85; Pseudo-Satellites of Jupiter in the Seventeenth Century, Chas. W. L. Johnson, 285

- Kaiser (H.), Phenomenon of Spectrum with Mixing of Infrared Rays, 158
- Kellogg (A. A.), H. D. Rolleston, and Manual of Practical Medical Anatomy, 328
- Kellogg (A. A.), Himalayas, Climbing and Exploration in the, William Martin Conway, 196
- Kellogg (Dr.), Critical Revision of Estimate of Average Ocean Depth, 111
- Kelton (Dr. Alister), on Isogonen, Isochimen, Isodynamen, Prof. Dr. G. Hellmuth, 594
- Keller (Dr.), a "Föhn" Wind in the Riesengänge, 431; Cloud Waves, 72
- Keller (J.), Invariable Pendulum, Observations with, L. E. J. Lloyd, 516
- Kellner (A.), Influence of Nervous System on Glucose Formation and Hydrolysis, 400; Glycogen in Blood, 503
- Kelso (Prof.), New Method of Preparing Unsaturated Hydrocarbon Allylene, 471
- Kellas (A. M.), Argon not in Vegetable or Animal Substances, 620
- Kelvin (Lord, F.R.S.), the Age of the Earth, 227, 438; Electrification of Air and other Gases, 495; the Dielectricity of Air, 573
- Kemp (Claudius), a Few Chapters in Astronomy, 484
- Kemp (W.), the Suspended Animation of Snakes, 274
- Kerr's Magneto-Optic Phenomenon, C. H. Wind, 48
- Kerr's Phenomenon, C. H. Wind, 168
- Kew Gardens, Addition to, 488
- Kewensis Plantarum Phanerogamarum Index. Sumptibus Beati Caroli Roberti Darwin ductu et consilio Josephi D. Hooker et Roberti E. Daydon Jackson, Fasciculus III., 54
- Kew University, Bacteriological Institute to be Established at, 266
- Kew's (Prof.), Out-growing Experiments, 266
- Kinetic Theory of Gases, the, G. H. Bryan, 31, 152, 176, 310; Edward P. Culverwell, 78; Dr. J. Larmor, F.R.S., 152; S. H. Burbary, F.R.S., 175; Prof. G. F. Fitzgerald, F.R.S., 221; Rev. H. W. Watson, F.R.S., 222; Prof. Arthur Schuster, F.R.S., 203; Prof. Boltzmann's Letter on the, Edward P. Culverwell, 581; Prof. Ludwig Boltzmann, 581
- Kirk (Prof. E. H.), the Variations in Level of Well Water, 62
- Kirk (T. W.), Superficial Deposits of Shantung, 478
- Kirpich (I. S.), Bromoamphoric Acid, 455; Dimethylketoxymethylene, 526; Melting Points of Racemic Modifications and Optically Active Isomerides, 526
- Kirby (W. L.), the Wasp Fly, 154; the Bird Winged Buterflies of the East, 254; Butterflies and Moths (British), 330; Fauna of British India, including Ceylon and Burma, Moths, 695
- Kirkton (Rev. L. P.), Death of, 302
- Kirkton Boiler Explosions, R. D. Munro, 197
- Kirkton (Ignat), Magnetisation of Iron and Nickel Wires by Rapid Electric Oscillations, 199
- Kirkpatrick (N.), Cause of *Vulpes arcticus* in Arctic Ocean, 500
- Kirkland (O.), Fluorescence of Solutions, 496
- Kirk's (Wind) Measurement Experiments at Eiffel Tower, Max de Nansouty, 181
- Kirkwood (A.), a Simplified Photograph, 588
- Kirkwood (Arthur), a New Spectrum Photometer, 334
- Kirkwood (Desiré), Thermochemical Carbon Batteries, 528; a Thermochemical Carbon Cell, 541
- Kirkwood (L. de), Production of Cathode Rays, 312; Conditions necessary for Production of Cathode Rays, 394
- Kirner (Prof.), Fortschritt, 392
- Kirshner (Dr.), Death of, 18
- Kirshner (H.), Mercuric Sickness, 394
- Kirby (Dr. George), Death of, 302
- Kirby (Dr. George), the Leyden, Prof. Kernerling, Omnes, 418
- Kirby (W. H. L.), New Contrivance for Recording Position of Electrons, Sensitive Balance, 546
- Kirkwood (W. D.), Grandeur der Psychologie, 173
- Kirkwood (Dr. L.), Death of, 324
- Kirkwood (Dr. George), Dr. Dr. F. Grosse, Prof. A. C. Haddon, 240
- Kirkwood (M. B.), on the Moon and Atmospheric Waves, 516
- Kirkwood (Dr. George), Study of System of Laws Proposed by E. C. Rieu, Prof. 242
- Laboratory Exercise Book for Chemical Students, E. Francis, 270
- Laboratory Manual, a, Dr. W. R. Orndorff, 77
- Ladd (George Trumbull), Primer of Psychology, 173
- Lafon (Ph.), Modifications of Blood by Thermal Treatment with Bourboule Water, 432
- Lagrange (Ch.), Is Declination indicated by Compass, independent of its Magnetic Moment? 477; Astronomical Coordinates referred to Astronomical and Geographical Poles respectively Compared, 620
- Lake (Philip), the South Denbighshire Rock Series, 94
- Lake, the Denme Vand Glacier, Capt. Perryman, 130
- Lake Biological Station to be Established in Northern Indiana, 422
- Lake Derravaragh, Seiches in, J. H. R. MacFarlane, 502
- Lake-Dwelling Research, Dr. Munro, 621
- Lakeland, the Tarns of, J. E. Marr, F.R.S., 190
- Lakes of Dauphiné, the, A. Delebecque, 35
- Lamp (Dr. E.), Comet 1894 I. (Denning) and Brunsen's Comet, 302
- Landerer (J. J.), a Passage of Shadow of Jupiter's Fourth Satellite, 384
- Lambert (Herr), Method of obtaining Light of Different Wavelengths in Polarimetric Work, 37
- Lang (Arnold), Lehrbuch der Vergleichenden Anatomie, 280
- Lang (Sir D. A.), Death of, 35
- Langley (Edward M.), Geometry in Schools, 176
- Langley (Prof. S. P.), on Recent Researches in the Infra-Red Spectrum, 12; the Wind and Birds' Flight, 156; the Hodgkins Prizes, 202
- Lankaster (Prof. E. Ray, F.R.S.), Acquired Characters, 54, 102; the Term "Acquired Characters," 245; Lehrbuch der Vergleichenden Anatomie, Arnold Lang, 289
- Lapworth (A.), Studies in Isomeric Change, 620
- Larch Trees at Dunkeld, Original, 111
- Larkin (M. H.), Elliptical Orbits, 234
- Larmor (Dr. J., F.R.S.), the Kinetic Theory of Gases, 152; Electrical Vibrations in Condensing Systems, 263
- Latitude, the Variation of, 373
- Lanmay (L. de), E. Fuchs and, Traité des Gîtes Minéraux et Métallifères, 555
- Laurie (A. P.), Electromotive Force of Iodine Cell, 454
- Lauth (Dr. F. J.), Death of, 421
- Lawrence (G. N.), Death of, 488
- Laws and Andrewes (Messrs.), the Harmlessness of Sewer Air, 374
- Lea (M. C.), New Methods of Obtaining Platinochlorides, 93
- Lean (B.), Homologues of Butanetetra-carboxylic Adipic Acids, 143
- Lebet (A.), Variation of Hall Effect in Bismuth with Temperature, 594
- Lecher (E.), Experiment to test Movement of Lines of Force of Rotating Magnet, 84; Unipolar Induction, 400
- Lee (J. B.), Instrument for Surveying by Aid of Photography, 191
- Leech (John Henry), Butterflies from China, Japan, and Corea, 6
- Leeward Islands, the Department of Agriculture in the, 613
- Leger (E.), *B-Oxynecholine*, 264; *Cinchonine*, 497
- Leighton (T.), Lower Greensand of East Surrey, 239
- Lens Work for Amateurs, Henry Orford, 318
- Lent (Dr.), Death of, 18
- Leonard (Dr. C. L.), Photomicrographic Method of Studying Cell Motion, 541
- Lepierre (Charles), the Chromates of Iron, 249
- Lepinay (J. M. de), Determination of Mass of Cubic Decimetre of Distilled Water at 4°, 599
- Leprie (R.), the Production of the Glycolitic Ferment, 330
- Lermantoff (W.), Die Bearbeitung des Glases auf dem Blasensische, 580
- Lescouq (H.), the so-called Organic Chlorine of the Gastric Juice, 144
- Lesseps (Ferdinand de), Obituary Notice of, 155
- Level, Gradient Telemeter, 112
- Lévy (A. M.), Retraction in Polychroic Aucoles, 384
- Levy Dorn (Dr.), Effect of Temperature on Secretion of Sweat, 192
- Lewes (Prof. Vivian B.), the Commercial Synthesis of Illuminating Hydrocarbons, 303; Action of Heat on Ethylene, H., 529; Cause of Luminosity in Flames of Hydrocarbon Gases, 529

- Lewin (Prof. L.), the Peyotl Cactus Alkaloid, 288  
 Lewis (J.), Stellar Parallaxes, 589  
 Leyden Kryogene Laboratory, the, Prof. Kammerlingh Onnes, 408  
 Libraries, Public, in America, 514  
 Lick Observatory, the, A. Fowler, 201  
 Liebreich (Prof.), Propyl Alcohol as a Separator of Cholesterol Skin-Fats into High and Low Melting-Points, 623  
 Liechtenstein (Herr von), Method of Turning True Spheres, 491  
 Lighting: the Commercial Synthesis of Illuminating Hydrocarbons, Prof. Vivian B. Lewes, 303  
 Lightning, Increase of Damage by, Prof. von Bezold, 20  
 Lihenthal's Experiments in Flying, 177  
 Limpets, the Habits of, Prof. J. K. Ainsworth Davis, 511  
 Limpets, the Homing of, Prof. C. Lloyd Morgan, 127  
 Lindström (Prof.), the Fossils of the Gotland Silurian, 503  
 Lineberger (C. E.), Solutions of Salts in Organic Liquids, 334  
 Ling (A. K.), Action of Diastase on Starch, 350  
 Linnean Society, 64, 143, 214, 203, 359, 455, 470, 527, 575  
 Lippmann (G.), Photographic Measurement of Time in Astronomy, 455  
 Lippmann's Method, Colour Photographs by, Dr. Neubaus, 503  
 Liquefaction of Gases, on the, Prof. Charles Olszewski, 245; Prof. James Dewar, F.R.S., 245, 305, 413; M. M. Pattison Muir, 364, 388, 430  
 Liquefaction and Solidification of Argon, the, Dr. K. Olszewski, 355  
 Liquids holding Solids in Solution, Critical Point of, Raoul Pictet, 311  
 Liquids, Measurement of Latent Heat of Vaporisation of Various Organic, Prof. Ramsay and Miss Dorothy Marshall, 309  
 Liquids, Use of Critical Temperature for Recognition of Parity of, Raoul Pictet, 288  
 Lister (Arthur), a Monograph of the Mycetozoa; being a Descriptive Catalogue of the Species in the British Museum, 603  
 Littleton (F. T.), Molecular Change in Silver Amalgam, 430  
 Liveing (Prof. G. D.), F.R.S., Benham's Artificial Spectrum Top, 167, 200  
 Liversidge (Prof., F.R.S.), the Structure of Gold Nuggets, 47  
 Lockyer (J. Norman, C.B., F.R.S.), the Sun's Place in Nature, 374, 396, 505, 500; Observations on Sun-Spot Spectra, 438; Terrestrial Helium, 586  
 Lockyer (N. J.), the Construction of the Modern Locomotive, George Hughes, 97  
 Locomotive, the Construction of the Modern, George Hughes, N. J. Lockyer, 97  
 Lodge (Prof. Oliver J., F.R.S.), Gravitation, 154; Peculiarities of Psychical Research, 247; the Alleged Absoluteness of Motions of Rotation, 271; Electroscopes in Lecture, 320  
 Lowy (M.), Photographic Studies of Lunar Surface, 143; Advances in Lunar Photography, 207  
 Logarithms: Tableau Métrique de Logarithmes, C. Dumesnil, 386  
 Lombard (Dr.), Death of, 344  
 London, a True University of, Mr. Crackenthorpe, 161  
 London, the Teaching University for, Dr. W. Palmer Wynne, 207  
 Long-Range Weather Forecasts, the Possibilities of, Prof. Cleveland Abbe, 212  
 Longevity and Death, Dr. G. J. Romanes, 381  
 Longitudes, Annuaire du Bureau des, 282  
 Loranite, Prof. Krenner, 302  
*Loranthus kraussianus* and *L. bogii*, the Fertilisation of, Maurice S. Evans, 235  
 Love (A. E. H., F.R.S.), the Alleged Absoluteness of Motions of Rotation, 105, 153, 108  
 Love (E. F. J.), Observations with Kater's Invariable Pendulum, 516  
 Lovell (Mr.), the Supposed Magnetic Fatigue, 614  
 Lowe Observatory, the, 21  
 Lowell (Mr. Percival), Seasonal Changes on Mars, 250  
 Löwl (Dr.), Alpine Gneiss and Granite, 320  
 Lubbock (Right Hon. Sir J., F.R.S.), Eocene Rock at Murren, 94; Eocene Fossils at Murren, 223  
 Lumière (A. and L.), Simplified Process for Silvering Glass, 371  
 Lunar Formations, Origin of the, Stanislas Meunier, 425  
 Lunar Photography, Advances in, MM. Lowy and Paiseux, 207  
 Lunar River Boats and Variable Spots, 119, A. W. Picken, 21, 589  
 Lunar Surface, Photographic Studies of, MM. Lowy and Paiseux, 143  
 Lydekker (R.), the Royal Natural History, 167  
 Lynn (W. T.), History of Locke's Canon, 168  
 Lyon (Prof. James), Errors arising from 'Imperfect Alignment' of Slide Plates, 622  
 Lyril Meteors, the, 564  
 McClelland (J. A.), Temperature of Titanium, Density of Water and its Coefficient of Expansion in neighbourhood of this Temperature, 358  
 McCook (Dr. Henry C.), American Spiders and their Spinning Work, a Natural History of the Out-Wearing Spiders of the United States, with special regard to their Industry and Habits, 505  
 McCrac (John), the New Lanth Bases, 429  
 MacDonnell (Dr. A.), Statistics of Sensibility to Pain, 290  
 Macdonald, G. W., a Product of Action of Natrio Oxide on Sodium Ethylate, 143; Argon not a Vegetable or Animal Substance, 620  
 Macdonald (H. M.), Electrical Distribution in Two Intersecting Spheres, 368  
 MacFarlane (J. H. R.), Seiches in Lake Linnavatagh, 502  
 MacGillivray (D.), Tuberculosis Germ-possessed of Locomotive Power, 623  
 Mach (Dr. Ernst), the Science of Mechanics; a Critical and Historical Exposition of its Principles, Prof. A. G. Greenhill, F.R.S., 40  
 McIntosh (Prof.), the Trawling Question, 115; the Artificial Hatching of Marine Food-Fishes, 150  
 Mack (Herr K.), Double Refraction of Electric Waves in Wood, 423  
 MacLachlan (Mr., F.R.S.), Geographical Distribution of Butterflies, 479  
 MacLaurin (J. S.), Action of Aqueous Potassium Cyanide on Gold and Silver in Presence of Oxygen, 350  
 Madan (Magnus), Electrification of Air and other Gases, 495; the Diselectrification of Air, 573  
 Maclear (Rear-Admiral, J.P.), the Zodiacal Light, 301  
 Madeira, the Island of, for the Invalid and Naturalist, Surgeon-General C. A. Gordon, 197  
 Magazines, Science in the, 44, 161, 250, 380, 450, 545  
 Magnetism, Kerr's Magneto-Optic Phenomenon, C. H. Wind, 48, 168; Changes of Length produced by Magnetisation, H. Nagasaki, 70; Experiment to Test Movement of Lines of Force of Rotating Magnet, F. Lecher, 84; Wille's Theory of the Secular Variation of Terrestrial Magnetism, L. A. Bauer, 103; Secular Changes of Terrestrial Magnetism, Dr. L. A. Bauer, 431, 401; Mirrors of Magnetism, Prof. S. P. Thompson and Miles Walker, 142; Magnetic Properties of Iridium, S. H. Brackett, 158; Electromagnetic Theory, Oliver Heaviside, F.R.S., J. Swinburne, 171; Toronto Observatory, 237; Absolute Value of Magnetic Elements, January 1, 1865, Th. Mouraux, 287; some Early Terrestrial Magnetic Discoveries pertaining to England, Will Whiston, L. A. Bauer, 205; Solar Magnetism in Meteorology, Prof. F. H. Bigelow, 356; Influence of Low Temperatures on Attractive Power of Artificial Permanent Magnets, Raoul Pictet, 384; Experiments to see if Light Rays deviated by Magnetic Field, M. Curie, 304; Magnetic Rotary Dispersion in Oxygen, Kammerlingh Onnes, 470; Is Declination indicated by Compass independent of its Magnetic Moment? Ch. Lagrange, 477; Magnetic Rotational Dispersion of Oxygen and Nitrogen, Dr. Siegfried, 504; Slow Changes in Magnetic Permeability of Iron, W. M. Morley, 526; Problems and Solutions in Elementary Electricity and Magnetism, W. Slingo and A. Bucker, 580; the Supposed Magnetic Fatigue, Messrs. Campbell and Lovell, 614; Ratio between Lateral Contraction and Longitudinal Dilatation in Magnetised Iron Rods, A. Bock, 614; Induced Magnetism in Volcanic Rocks, G. Edgheiser, 617  
 Mahlike (A.), High Temperature Thermometers of Jena Glass No. 59, 334  
 Mallett (Abbe), Solubility of Ozone, 168  
 Malaysian Spiders, Thos. and M. E. Workman, R. I. Pocock, 60; B. A. Murhead, 153  
 Mallery (Lt.-Col. Garrick), Death of, 61  
 Malville (A.), Pectase and Pectic Fermentation, 101, 312  
 Mallock (W.), Vibration of Steamers, 570



- pharastus of Eresus on Winds and on Weather Signs. Translated by Jas. G. Wood, 25; Early English Meteorological Literature, G. J. Symonds, 38; Report of U.S. Weather Bureau for 1893, 39; American Meteorological Journal, 45, 142, 359, 451; the Services of South America, A. L. Kitch, 45; Sun-spots and Auroras, Prof. H. A. Hazen, 49; Berlin Meteorological Society, 72, 192, 431, 503, 623; Dr. Schwab's Endeavours to Utilise for Scientific Purposes the Curves of Temperatures obtained from the "Uranus" Pillars, 72; Cloud-Waves, Dr. Kassner, 72; Central European River Temperature Variations, Dr. A. L. Forster, 83; the "Baric" Condition of the Atmosphere, A. Ramsay, 84; Royal Meteorological Society, 119, 245, 311, 527, 621; Methods of Determining Influence of Springs on River Temperature, Dr. H. B. Guppy, 119; the China Seas Typhoons of 1893, 139; Cyclonic Precipitation in New England, Prof. W. L. Linton, 142; the Barometer at Sea, T. S. O'Leary, 142; Insignificant Sequelæ of Forest Fires, Prof. C. Abbe, 158; Determinations of Absorption of Solar Radiation by Fog and Cirrus Clouds, Profs. Bartoli and Stracciati, 186; Pilot Chart of North Atlantic for November 1894, 181; Föschle's Wind-Measurement Experiments at Eiffel Tower, Max de Nansouty, 181; the Upsala Meeting of the International Meteorological Committee, 185; Inversion of Temperatures in 26-68 Day Solar Magnetic Period, I. H. Bigelow, 199; Sheet-Lightning, Dr. Meinardus, 192; Dr. Steinbach's Observations on Climate of Jalu, Prof. von Danckelmann, 192; the Possibilities of Long-Range Weather Forecasts, Prof. Cleveland Abbe, 212; Floods in the West Midlands, H. Southall, 215; Meteorology, Practical and Applied, John William Moore, 220; Swiss Hailstones, 1883-93, Dr. C. Hess, 239; Southerly Bursters, H. A. Hunt, 239; Dr. Steinbach's Observations at Jahnit Island, 233; Canadian Meteorological Society, 237; Aurora of November 23, 1894, Prof. A. S. Herschel, F.R.S., 240; Auroras in N.E. Scotland, R. C. Mossman, 622; the Study of Clouds, 248; Meteorology in Argentina, 253; Storm Statistics at Bidston, William E. Plummer, 272; a White Rain-bow, Rev. Samuel Barber, 274; Interzonal Astronomy and Meteorology, 278; Solar Heat Intercepted by Volcanic Dust, Prof. A. Bartoli, 279; Meteorological Station established at Angmagssalik, Greenland, 279; Meteorological Work in Australia, Sir C. Todd, F.R.S., 309; the Gale of December 21, 22, 1894, C. Harding, 311; Meteorological Results of Balloon Ascent, by S. A. Andree, Prof. H. A. Hazen, 325; Effect of Gales on Height of Tides, 325; High Temperature Thermometers of Jené Glass No. 5099, A. Mahlikar, 334; New "Hurricane" Signal, 344; Das Alpenglühén, Dr. J. Anslér, 349; Solar Magnetism in Meteorology, Prof. F. H. Bigelow, 359; Variations in Character of Seasons, H. Gawthrop, 357; New Relations between Barometric Movements in Northern Hemisphere and those of Sun and Moon in Declination, P. Garrigon-Lagrange, 407; the Occurrence of very Cold Days, 410; the Recent Storm in the United States, Dr. William H. Hale, 417; the Invention of the Barometer, Prof. G. Hellmann, 422; Secular Changes of Terrestrial Magnetism, Dr. L. A. Bauer, 431, 491; a "Fohn" Wind in the Riesengebirge, Dr. Kassner, 431; Eleven-Year Sun-Spot Weather Period and its Multiples, H. Helm Clayton, 439; February Snowfall in the United States, 440; Atmospheric Circulation, Prof. M. Müller, 449; Cause of Cyclones of Temperate Latitudes, W. H. Dines, 451; Recent Russian Studies of Thunderstorms, R. de C. Ward, 451; the Moon and Rainfall, Prof. H. A. Hazen, 451; Anemometry and Vertical Currents of Atmosphere, M. Ritter, 469; Report of Meteorological Society, 490; Meteorological Conditions of Neighbourhood of Paris for February 1895, L. Renou, 489; Death of General de Nansouty, 488; Wind Velocity at Berlin, Prof. Hellmann, 491, 623; Kandal of Sandwich Islands, Dr. J. Hann, 500; Meteorologische Zeitschrift, 500; the Thunderstorm of January 23, 1895, W. Marnett, 502; Phenological Observations for 1894, F. Mawley, 502; "Seiches" in Lake Denavaragh, J. H. K. Macfarlane, 502; Unstable Equilibrium of Atmosphere before Thunderstorm, Prof. von Bezold, 503; the New York Signal Service Office, 539; Storm of March 24, 1895, 513; Twelve-Year Intervals in Rise and Fall of Temperature, Dr. M. A. Veeler, 513; the Frost of February 1895, 525; the Frost of January-February 1895, F. C. Bayard and W. Marnett, 621; R. C. Mossman, 621; Motion and Formation of Clouds, W. N. Shaw, F.R.S., 527; Scottish Meteorological Society, 542, 621; Connection of Latitudinal Displacements of Lines of
- Barometric Maxima, De Linnæus, 65; of Mercurial, A. P. L. 66; of M. Weatherwise, Compar., 662; of W. of Minima, Temperatures on Mount Blanc, J. Janssen, 622; New Methods of Temperature Measurement, Dr. Berlin, 622; Observations of Temperature and Humidity on Snow-surfaces, Dr. S. S. 623;
- Meteors: the Persian, Meteors, Dr. Brodichm, 391; W. L. Deuring, 329; the Lyrid Meteors, 594; Bright Meteor, Taylor, 587;
- Metric Standards, Now, 429;
- Metric System, the, Cf. Ann. H. R. Society, 592; Dr. G. L. Gladstone, 593;
- Metric System; New Scales adopted in France, 613;
- Metric System in Trans, the, 324;
- Metzner (R.), Study of Combinations of Hydrogen, Chlorine and Water, 24;
- Mieman (M. Stanislas), Origin of the Lunar Eruptions, 425;
- Meyer (M.), the Geological Distribution of Fossils, 479;
- Meyer (Dr. A. B.), Album von Papua Typen, 174; Two New Birds of Paradise, 519;
- Meyer (G.), Capillary Electrometers and Drop Electrodes, 331;
- Meyer (Prof. L.), Danger of Explosive Mixtures of Acetylene and Oxygen, 84;
- Meyer (Prof. Lothar von), Death of, 587;
- Meyer (Prof. V.), Synthesis of Chloride of Carbon during Fractionation of Carbon Tetrachloride, 131; New Method of Determining High Melting Points, A. E. Tutton, 191; Sodium Compounds of Nitro-Paraffin, 492;
- Michael (A. D.), the History of the Royal Microscopical Society, 335;
- Microbes and Metals, Mrs. Percy Frankland, 611;
- Microscopy: Royal Microscopical Society, 95, 191, 335; the History of the Royal Microscopical Society, A. D. Michael, 335; New Microtome, Messrs. Swift, 191; Practical Methods in Microscopy, C. H. Clark, H. G. Wells, 195; Quarterly Journal of Microscopical Science, 213; Death of Dr. George A. Rex, 538; an Improved Method for the Microscopical Investigation of Crystals, A. E. Tutton, 608;
- Microsporion, Paul Vuillemin, 593;
- Muldendorff (O. W.), "Peru," 388;
- Miers (H. A.), Homogeneity of Structure, the Source of Crystal Symmetry, 79; Precious Stones, and How to Distinguish them, 545;
- Milk, Influence of Sterilisation on Digestibility of, Dr. Bendix, 66;
- Milky Way, the, C. Easton, 327;
- Mill (Dr. Hugh Robert), Studies of a Growing Atoll, 203;
- Miller (Dr. A. C.), Advantage of High Level Residence for Tuberculous Patients, 379;
- Milne (Prof. John, F.R.S.), the Observation of Earth-Waves and Vibrations, 548;
- Minerals (Kumagata), on Chinese Beliefs about the North, 32; Chinese Beliefs about Caves, 57; Chinese Theories of the Origin of Amber, 294; the Antiquity of the Finger-Print Method, 199; Finger-Print Method, 274; Hesper and Porphron, 417; the Mandrake, 608;
- Mineralogy: the Structure of Gold Nuggets, Prof. Laverstidge, F.R.S., 47; Mineralogical Society, 143, 431, 621; Death of Prof. F. Johnstrup, 229; Study of Iron Graphites, Henri Moissan, 293; Death of Prof. von Hausnoter, 278; Gold Discovered in Isle of Man, 299; Leonardite, Prof. Krenner, 392; Mineral Minerals from India and Australia, Prof. Judd, 431; A New Method of Determining Densities of Solids, E. L. Berkeley, 431; Determination of Mineral Densities, Prof. U. von, 431; the Siles of Paris Gypsum, L. Cayeux, 432; Precious Stones, and How to Distinguish them, H. A. Miers, 515; Traité des Gîtes Minéraux et Métallifères, I. Fuchs et J. de Launay, 555; Etude industrielle des Gîtes Métallifères, George Moreau, 555; Enargite, Mr. Spencer, 621;
- Mines, the Use of Safety Explosives in, 184;
- Mines, Explosions in, 211;
- Mines, Palæontology at the Royal School of, Right Hon. T. H. Huxley, F.R.S., 223;
- Misconception, Boltzmann's, S. H. Burbury, F.R.S., 578, 529;
- Misconception, Theorem, Boltzmann's, Rev. H. W. Watson, F.R.S., 195; Edward P. Culverwell, 195, 249;
- Mining, Coal Dust an Explosive Agent, as shown by an Examination of the Camera in Explosion, Donald M. D. Stuart, 268; Traité des Gîtes Minéraux et Métallifères, I.

- Luchs and L. de Launay, 555; Etude industrielle des Gites Metalliferes, George Merleau, 555
- Mira Cen, Mr. Fowler, 49
- Missing Link, Dr. Dabbs is so called, 201, 428, 621
- Mitchell (F. Chambers), Outlines of Biology, 105; Vertebrate Segmentation, 307
- Miame (Mr. Captain Manning's Ascent of, 441
- Missan (Henri), the Vaporisation of Carbon, 71; Reaction of Amalga by Carbon, 107; the Varieties of Graphites, 101; Displacement of Carbon by Boron or Silicon in Fused Cast Iron, 240; Study of Iron Graphites, 263; Preparation of Graphites from Amalga, 287; Boron Steel, 330; Boride of Iron, 350; Titanium, 407
- Moller (F. Peckel), Coal-tiver Oil and Chemistry, 508
- Mollusc at the Honing of Limpets, Prof. C. Lloyd Morgan, 127; the Habits of Limpets, Prof. J. R. Ainsworth Davis, 511; Hermaphroditism in Mollusca, Dr. Paul Felsenker, 213; Oysters and Typhoid, 301, Mrs. Percy Frankland, 415; the Snail Fauna of the Greater Antilles, 522; Mussel Culture and the Bait Supply, W. L. Calderwood, 57
- Monst, Science in the, 381
- Monkeys; a Handbook to the Primates, H. O. Forbes, 242
- Monte Rosa, Italian Scientific Expedition to, Dr. Piero Gaudsca, 57
- Montenore (Arthur), the Samoyed Race, 270
- Moody (G. T.), Studies in Isomerism Change, 620
- Moon, Eclipse of the, 444, 472
- Moon, of Atmospheric Waves, M. Bonquet de la Grye, 510
- Moore (G.), the Artificial Spectrum, T. J. J. M. Finnegan, 292
- Moore (J. F. S.), the Achromatic Spindle in the Spermatozoetes of Fish and Branch Fishes, 143
- Morgan (John William), Meteorology, Practical and Applied, 220
- Morin (Anthony), Manual of Practical, H. D. Rolleston and A. A. Kuthack, 318
- Morphology, the Transmission of Yellow Fever, Dr. Abern, 300
- Murphy, W. M., Slow Changes in Magnetic Permeability of Iron, 529
- Murphy (A. G.), Death of, 538
- Murphy (G.), Absorption of Light by Uniaxial Crystals, 528; Etude industrielle des Gites Metalliferes, 555
- Morgan (Prof. C. Lloyd), the Honing of Limpets, 127; Introduction to Comparative Psychology, 173; Psychology for Teachers, 173; the Examination Curve, 617
- Murby (H. Foster), Watts' Dictionary of Chemistry, M. M. Johnson Mar, 27
- Morphology; Morphologie der Erdoberflache, Dr. Albert Penck, 314; Comparative Morphology of *Gaussia*, H. M. Bernard, 455
- Morrison (D. K.), the Question of Dielectric Hysteresis, 574
- Mosses, a Study in the Direction of Penicillium Line around, General S. G. Charsky, 326
- Moscow, Bulletin of la Societe de Naturalistes de, 334, 357
- Messina (G. C.), the Frost of 1865, 621; Aurora in North-East Sicily, 922
- Moths, an Observation on, Dr. J. C. Jones, 70, 321; Henry Coll, 127; European and Moths (British), W. Turneaux, W. L. Kirby, 330; Moths, the Fauna of British India, including Ceylon and Burma, W. L. Kirby, 605
- Motion, Transmissions, A. B. E. G., F. R. S., 11
- Moon, Dr. F. W., Influence of Senary Nerves on Movement and Nutrition of Limbs, 620
- Moon, Eclipse, Height of, 10
- Mount St. Helens, Height of, 10
- Mountain Sickness, H. Krimmker, 302
- Mountains of California, Dr. John Muir, 125
- Murphy (S.), Absolute Value of Magnetic Forces, January 1, 1865, 287
- Murphy, the Mountains of California, 125
- Murphy (M. M.), Lattinony, Wort, Dictionary of Chemistry, 27; Newell's European Chemistry, 52; Treatise on Chemistry, Sir H. E. Rose, F. R. S., 100; Schellenker, 161; Treatise on the Direction of the Relative Chemical Action of Mercury Compounds, M. M. Johnson, 270; the European and British, 364, 388, 476; Theoretical Chemistry from the Standpoint of Avogadro's Law, Thermodynamics, Prof. W. N. S. G., 330
- Murphy (B. V.), The Molecular Spectrum, 153
- Murphy (A. J.), the Science of the System of Earth, 100; the Moon, 17, 1862, 48
- Murphy (F. M.), the Science of the System of Earth, 100
- Muller (P. T.), Ebullioscopic Study of Colouring Matters from Triphenylmethane, 455
- Munro (Dr.), Lake-Dwelling Research, 621
- Munro (K. D.), Kitchen Boiler Explosions, 107
- Muntz (A.), Fertilising Material required by Aime, 480
- Murphy (Shirley F.), a Treatise on Hygiene and Public Health, 124
- Murray (Dr. John), Chemical Changes between Sea-Water and Oceanic Deposits, 304
- Murray (J.), How to Live in Tropical Africa, 364
- Murrien, Eocene Rock at, Right Hon. Sir John Lubbock, F. R. S., 104; Eocene Fossils at, Right Hon. Sir John Lubbock, F. R. S., 223
- Muscular Contraction, on the Nature of, Prof. Th. W. Engelmann, 510
- Museum of Natural History, American, 120
- Musketoff (Prof.), Catalogue of Earthquakes in Russia, 181
- Mushrooms, Edible and Poisonous, Dr. M. C. Cooke, 8
- Mussel Culture and the Bait Supply, with Reference more especially to Scotland, W. L. Calderwood, 578
- Mycetozoa, a Monograph of the, Arthur Lister, 603
- Mycology; Edible and Poisonous Mushrooms, Dr. M. C. Cooke, 8
- Naber (H. A.), Standard Methods in Physics and Electricity Criticised, 318
- Naber (Mr.), New Gas Voltmeter, 500
- Nagaoka (H.), Changes of Length produced by Magnetisation, 70
- Names, the Cyclopedic of, 434
- Nansouty (Max de), Kiecur's Experiments to overcome Air Resistance to Locomotive at High Speed, 62; Koellin's Wind-Measurements, Experiments at Fattel Tower, 181
- Nansouty (General de), Death of, 488
- Natal Observatory, the, Mr. Nevill, 327
- National Review, Science in, 162, 250
- Natural History; a Naturalist on the Prowl, 8; Sir Victor Brooke, Sportsman and Naturalist, O. L. Stephen, 76; American Museum of Natural History, 129; the Royal Natural History, K. Lydekker, 197; Die Schopfung der Tierwelt, Dr. Wilhelm Haacke, 149; the Horn Expedition to Central Australia, Prof. Baldwin Spencer, 222; a Handbook to the Primates, H. O. Forbes, 242; Birds of the Wave and Woodland, Phil Robinson, 243; Life at the Zoo, C. J. Cornish, 270; Snake Camillabism, H. Tsuagal, 321; Baron C. R. Osten Sacken, 343; J. Schonland, 511; the Natural History of the Solway, G. Stewardson Brady, 322; Bulletin de la Societe de Naturalistes de Moscou, 334, 357; Death and Obituary Notice of Dr. F. B. White, 345; in the Guiana Forest, James Rodway, 387; Orb-Weaving Spiders of the United States, Dr. Henry C. McCook, Rev. O. P. Cambridge, F. R. S., 505; Journal of St. Petersburg Society of Naturalists, 500
- Natural Science, Philosophy and, David Wetterhan, 205
- Naturalist on the Prowl, a, 8
- Nature, the Sun's Place in, J. Norman Lockyer, C. B., F. R. S., 374, 396, 505, 500
- Nature Knowledge, Short Studies in, William Gee, 557
- Nautical Almanac, 1868, the, 472
- Naval Architecture; Bilge-Keels and Steadiness in First-class Battleships, Sir William White, 508; R. L. Froude, 500; Vibration of Steamers, Otto Schlick, 500; W. Mallock, 570; Mark Robinson, and Capt. H. R. Sankley, 570
- Naval Engineering; the Limitations of Screw Propulsion, J. L. Thornycroft, F. R. S., and S. W. Barnaby, 502
- Naval Officers, the Education of, W. L. Clowes, 250
- Navigation; Acoustic Fog Signals, A. B. Johnson, 130; New Method of Correcting Courses at Sea, Dr. George Hay, 215; Ocean Navigation, James Watt and, Dr. Francis Elgar, 475; Corrections of Maximum and Ex-Meridian Altitudes, J. White, 485
- Navigator, Prince Henry the, C. Raymond Beazley, 532
- Nebula of Orion, the Greater, Prof. F. L. Barnard, 253
- Nebula  $\beta$  2241, the Parallax of, Dr. Walsing, 114
- Nebulae, New Stars and, 347
- Nec-Vitalism, Frances A. Welby, 43
- Neptune, a Possible New Satellite of, Prof. Schaeberle, 542
- Neptune, the Diameter of, Prof. Barnard, 617
- Nerist (Prof.), Method of Measuring Specific Inductive Capacity and Resistance of Liquids, 232; Theoretical Chemistry from the Standpoint of Avogadro's Rule and Thermodynamics, 530

- Nerves, the Development of, *Advances in Science*, I.R.S., 119, 213
- Nervous System, Formation Structures of, Prof. Waldyer, 312
- Nests and Eggs of Non-Indigenous British Birds, the, Charles Dixon, 30
- Neuhaus (Dr.), Colour Photography, 503
- Nevill (Mr.), the Natal Observatory, 327
- Newall (H. F.), the Spectrum of Argon, 454
- Newcomb (Prof.), a Possible New Zone of Asteroids, 114; Secular Variations of the Interior Planets, 183
- New Hebrides, Earthquake in, 61
- New Jersey, the Birds of Eastern Pennsylvania of, 458
- New South Wales Linnean Society, 192, 204
- New South Wales Royal Society, 47
- New York Signal Service Office, the, 539
- Newth (G. S.), a Text Book of Inorganic Chemistry, 196; M. M. Pattison Muir, 52, 107
- Newton (Prof. Alfred, F.R.S.), Parrots in the Philippine Islands, 307
- Newton (Sir Charles, K.C.B.), Death of, 420; Obituary Notice of, 259
- Newton and Co., the Artificial Spectrum Top, 493
- Ney (O.), New Phototheodolite, 515
- Niagara, Progress of the Cataract Construction Company's Works at, 109
- Niagara Falls, the Utilisation of, Prof. George Forbes, F.R.S., 295
- Niagara and the Great Lakes, F. B. Taylor, 610
- Nicaragua, the Earthquake of November 1894, in, J. Crawford, 280
- Nicéville (L. de), New Indo-Malayan Butterflies, 500
- Nicolaiew, Strassburg, and Birmingham, on a Remarkable Earthquake Disturbance observed at, on June 3, 1893, C. Davison, Dr. E. von Reuber-Paschwitz, 208
- Nile, the, Sir Colin Scott-Moncrieff, 444
- Nile Reservoir at Assuan, the, 110
- Nitrogen and Chlorine, New Compounds of, Phosphorus, H. N. Stokes, 592
- Nitrogen Compound, a new Series of, Prof. A. Pechman, and Heir Runge, 114
- Nitrogen Fixation in Algae, Rudolf Beer, 392
- Nitrogen Group, a New Element in the, A. F. Tutton, 258
- Nitromethane, the Explosive Nature of the Sodium and Potassium Derivatives of, A. F. Tutton, 328
- Noetling (Dr.), Similarity of Baluchistan and Pyrenean Lichnoids, 280
- Nogues (A. S.), the Chilo-Argentine Earthquake of October, 1894, 393
- Noll (Dr. F.), *Lehrbuch der Botanik*, Drs. E. Strasburger, H. Schenck and A. F. W. Schimper, 339
- North, on Chinese Beliefs about the, Kinnagutsu Minakata, 32
- Norway, Earthquake in, 344; Dr. Hans Reusch, 309
- Nova Aurige, 516
- Numismatics; Death of Dr. Hermann Goebe, 488
- Nuovo Giornale Botanico Italiano, 23
- Nyasaland, the New Cypress of, 85; W. T. Huxelson-Dyer, F.R.S., 175
- Oak Trees in Essex, Remarkable, J. C. Sherrin, in, 280
- Oat-growing Experiments, Prof. Kutsch, 296
- Object-Glass, the New Achromatic, 190
- Observatories; the Lowe Observatory, 21; the Lick Observatory, A. Fowler, 201; the Vatican Observatory, 282; the Natal Observatory, Mr. Nevill, 327; the New Dudley Observatory, 327; Recent Work at Harvard College Observatory, Prof. E. C. Pickering, 329; the Royal Observatory, Edinburgh, 493; the Seismological Observatory Destroyed at Tokio, 585; Prof. J. W. Judd, F.R.S., 533
- Ocean, Critical Revision of Estimate of Average Depth of, Dr. Karstens, 111
- Ocean Currents, the Travels of Large Bottle Papers, H. C. Russell, 35; Ocean Navigation, James Watt, and Dr. Francis Elgar, 475
- Oceanic Deposits, Chemical Changes between Sea Water and, Dr. John Murray and Robert Irvine, 304
- Oceanic Temperatures at Different Depths, Captain W. J. L. Wharton, F.R.S., 342
- Ohm, a New Determination of the, J. Hunsfeldt, 571
- Olbens (Wilhelm), Sein Leben und Seine Werke, 74
- Oldham (Yule), a Pre-Columbian Discovery of America, 81
- O'Leary (J. S.), the Great Seal, 142
- Oliver (Prof. J. E.), the Obituary Notice, 587
- Olzowski (Prof. O.), the Liquefaction of Gases, 107; Claim for Priority, 215
- Olzowski (Dr. K.), the Temperature and Solidification of Argon, 355
- Omon (Gen. the), the Active Series of Earthquakes, 423
- Ommes (Prof. Kamerlingh), Magnetic Rotary Dispersion in Oxygen, 470; the Leyden Kravogine Laboratory, 498
- Optics; Method of Obtaining Light of Different Wave-lengths, use in Volumetric Work, Henri Landolt, 37; Superposition of Optical Effects of Several Asymmetric Carbon Atoms in same Active Molecule, P. A. Guye and M. Guanter, 47; Superposition of Optical Effects of Different Asymmetric Carbon Atoms in same Active Molecule, P. A. Guye and M. Guanter, 168; Kerr's Magneto-Optic Phenomenon, C. H. Wind, 48; Effects of Monochromatic Light on Series of Pigments, Prof. H. W. Vogel, 191; Ottica, Prof. Eugenio Cosenza, 244; Lens-Work for Anamniotes, Henry Orford, 318; Process of Light Emission, G. Jaumann, 334; Yellow Blue Blindness, Dr. W. Fiedler, 335, 621; Influence of Rhythm of Successions of Interruptions on Sensitiveness to Light, Charles Henry, 539; Total Reflection of Light in Dense Crystalline Substances, R. Camerer, 357; Retraction in Polychromatic Aureoles, A. M. Levy, 384; Experiments to see if Light Rays deviated by Magnetic Field, M. Curie, 394; Passage of Light across Thin Plate in Case of Total Reflection, Ch. Fabry, 497; Experiments on Colour Sensation, H. W. Vogel, 490; Magnetic Rotary Dispersion in Oxygen, Kamerlingh Ommes, 470; Optical Resolutions of a *Oxybutyric Acid*, J. A. Guye and Ch. Jordan, 504; Action of Light in Producing Electric Discharge through Vacuum Tube, Elster and Geike, 514; Absorption of Light in Uniaxial Crystals, G. Moreau, 528; Effect of Rhythm on Visibility of Signals, Charles Henry, 588; The Normal Defect of Vision in the Fovea, C. J. Franklin, 615; Polarisation of Oblique Radiation, Dr. W. von Uljanin, 623
- Orb-Weaving Spiders of the United States, Dr. Henry C. M. Cook, Rev. O. P. Cambridge, F.R.S., 595
- Orbits, Elliptical, Mr. H. Lukin, 234
- Oregon, Tornado in, 19
- Organic Chemistry, the Rise and Development of, Carl Schorlemmer, 317
- Organic Chemistry, the Fatty Compounds, R. Lloyd Whiteley, 557
- "Organic Remains of a Former World," James Parkin, the Author of, Spencer George Penney, 31
- Origin of Classes among the "Parasitic" Ants, Herbert Spencer, 125
- Origins of Art, the, Dr. J. Grosse, Prof. A. C. Halden, 241
- Origins of Invention, the, Otis F. Mason, 557
- Orion, the Greater Nebula of, Prof. J. L. Barnard, 253
- Orion Nebula, Spectrum of the, 471
- Orloff (A.), Catalogue of Earthquakes in Russia, 181
- Ormerod (Eleanor A.), Injurious Insects, 471
- Orndoff (Dr. W. R.), a Laboratory Manual, 77
- Ornithology; the Commanchean Collection of Dutch Birds, 18; the Nests and Eggs of Non-Indigenous British Birds, Charles Dixon, 30; Attitudes adopted by Birds for Concealment, J. L. Harting, 181; Birds of the Wave and Woodland, Phil Robinson, 243; the Tongue and Hyoid Apparatus of Birds, Henri Schenking-Prevot, 252; the Starling in Scotland, J. A. Harvie-Brown, 280; British Birds, Claude W. Wyatt, 318; Summer Studies of Birds and Books, W. Waide Fowler, 341; Forest Birds; their Haunts and Habits, Harry F. Witherby, 341; Invasion of North and North-East Coasts by the Little Auk, J. L. Harting, 422; Grouse Exodus in Yorkshire, J. L. Harting, 422; the Birds of Eastern Pennsylvania and New Jersey, 458; Death of G. N. Laurence, 488; Two New Birds of Paradise, Dr. A. B. Meyer, 510; Catalogue of the Birds of Prey (Accipitres and Stinges), J. H. Gurney, 532; Side of Specimen of Great Auk, 613
- Oryzohynchus, the Visceral Anatomy of, F. E. B. Bedford, F.R.S., 191
- Osaka (A.), Asymmetry of Hydrogen Fluoride, 439
- Oscillations, Electric, H. Poincare, Prof. A. Gray, 391
- Oster Sacken (Baron C. K.), the Swallowing of one Snake by another, 12; Snake Cannibalism, 343
- Ostromoff (Dr.), a Flying Copepod, 20
- Oswald (W.), Die Wissenschaftlichen Grundlagen der Analytischen Chemie, J. W. Rodger, 482





European River-Temperature Variations, Dr. A. E. Forster, 83; Berlin Physical Society, 96, 168, 191, 288, 331, 503, 623; Boltzmann's Minimum Theorem, Rev. H. W. Watson, F.R.S., 105; Edward P. Culverwell, 105, 240; the Ratio of the Specific Heats of Gases, S. H. Burbury, F.R.S., 127; the Alleged Absoluteness of Motions of Rotation, A. E. H. Love, F.R.S., 153, 198; Phenomena connected with Mingling of Liquid Masses, F. Kaiser, 158; Prof. Victor Meyer's New Method of Determining High Melting Points, A. I. Tutton, 161; Vapour Tension and Hygroscopic State, Dr. Verschaefelt, 167; Fantastic Forms assumed by Combinations of Alkalis and Oleic Acid in Contact with Water, Dr. Quincke, 182; Measurement of Surface Tension of Water in Capillary Tubes, P. Volkmann, 190; Effects of Monochromatic Light on Series of Pigments, Prof. H. W. Vogel, 191; Phosphorescence at Very Low Temperatures, MM. Pictet and Altschul, 200; Determination of Specific Heat of Water in Electrical Units, Prof. A. Schuster, F.R.S., and W. Cannon, 214; the Constitution of Volatile Liquids, Prof. Lait, 215; Isothermals of Ethylene, Prof. Lait, 215; Method of Identifying Former Level of Water after withdrawal of Solid immersed therein, Sig. Guglielmo, 231; Study of System of Two Pendulums joined by Elastic Thread, Lucien de la Rive, 232; Influence of Force of Gravity on Circulation, Prof. Leonard Hill, 238; Students' Apparatus for Determining Mechanical Equivalent of Heat, Prof. W. E. Ayton and H. C. Haverati, 239; a Text-book of Sound, F. Catchpool, 244; the Liquefaction of Gases, Prof. Charles Olszewski, Prof. James Dewar, F.R.S., 245, 305, 413; M. M. Pattison Muir, 364, 388, 430; Solar Heat intercepted by Volcanic Dust, Prof. A. Bartoli, 270; Inability of Cotton Wool to intercept Low-Temperature Radiation, Raoul Pictet, 280; Use of Critical Temperature for Recognition of Purity of Liquids, Raoul Pictet, 288; the Artificial Spectrum Top, Capt. W. de W. Abney, C.B., F.R.S., 292; J. M. Finnegan, B. Moore, 292; Dr. F. W. Edridge Green, 321; Charles E. Benham, 321; Dr. Dawson Turner, 438; the New Laboratories of University College, 208; Measurement of Latent Heats of Vaporisation of Various Organic Liquids, Prof. Ramsay and Miss Dorothy Marshall, 309; Critical Point of Liquids holding Solids in Solution, Raoul Pictet, 311; the Critical Point, Raoul Pictet, 504; Determination of Thermal Conductivity and Emisivity, Mr. Lumbré-poulous, 310; Influence of Dimensions of Body on Thermal Emissions from Surface, A. W. Porter, 310; Passage of Oscillator Wave-Train through Plate of Conducting Dielectric, G. U. Yule, 310; Standard Methods in Physics and Electricity Criticised, H. A. Nabor, 318; the Physical Society's Abstracts of Physical Papers from Foreign Sources, 321; Anomaly in Direction of Pendulum Line around Moscow, General Stebnitskiy, 320; the Elasticity of Solid Gelatine Solutions, Erard Fraas, 326; Electric Discharge through Gases, Prof. J. J. Thomson, 330; an Anomalous Mercury Vacuum Pump, M. E. Pepin, 334; Graphical Thermo-dynamics, René de Saussure, 334; Solution of Salts in Organic Liquids, C. E. Lamberger, 334; Latent Heats of Evaporation of Water, E. H. Griffiths, 334; Temperature of Maximum Density of Water and its Coefficient of Expansion in neighbourhood of this Temperature, Prof. Anderson and J. A. McClelland, 358; Simplified Process for Silvering Glass, A. and L. Lumière, 371; Simple Apparatus, W. B. Croft, 383; the Tin Chloride Chloride Cell, S. Skinner, 383; Physical Society, Report for 1894, 383; Lehrbuch der Experimental Physik, A. Wullner, 387; Fluorescence of Solutions, O. Knollkauch, 406; Lowering of Freezing-point of Dilute Solutions of Sodium Chloride, A. Ponsot, 407; the Leyden Kryogenic Laboratory, Prof. Kamerlingh Onnes, 408; on Certain Questions of the Theory of Gases, Prof. Ludwig Boltzmann, 413; Accurate Method of Determining Densities of Solids, Earl of Berkeley, 431; Determination of Mineral Densities, Prof. Church, 431; Relation of Gravity to Continental Elevation, F. C. Mendenhall, 430; Behaviour of Boies at Critical Temperature, Dr. Altschul, 431; Atomic Weights, Léon de Bouslaudran, 432; Preparatory Physics, William J. Hopkins, 436; the Weight of a Litre of Air, Prof. Mendeleeff, 452; Ratio of Specific Heats of Compound Gases, Dr. Capstick, 452; Maxwell's Theorem of Equal Partition of Energy not inconsistent with Internal Movements of Gas-Spectra, Prof. G. I. Fitzgerald, F.R.S., 452; Ideality of Measurement of Welling in Iron with Regeneration Ice, T. Wrightson, 453; Mechanical Analogue of Thermal Equilibrium between Bodies in Contact, H. Bryan, 454; Melting

points of Mixtures, H. Crompton and M. A. Whipple, 454; the Laws of Crystal-line Absorption, L. Carvallo, 455; Influence of Stress in Corrosion of Metals, T. Andrews, 470; Physical Work of Hermann von Helmholtz, Prof. A. W. Riedler, F.R.S., 472, 493; Double Decompositions of Vapours, Henry Andrews, 477; Determination of Critical Temperature and Boiling point of Hydrogen, Prof. Olszewski, 488; Experiments on Strength of Canadian Timber, Dr. H. Bovey, 492; Identification of Air and other Gases, Lord Kelvin, F.R.S., Magnus Maclean, and Alexander Galt, 495; Natter's New Gas Voltameter, 500; Stoney's Local Heliosat and Improved Selenostat, 500; a Simple Form of Harmonic Analyser, G. U. Yule, 501; Energy Movements in Medium Separating Electrified or Gravitating Particles, H. N. Allen, 521; Condition for Equilibrium between Co-existent Phases, Mr. Van der Waals, 504; Variation of Hall Effect in Bismuth with Temperature, 504; Observations with Kater's Invariable Pendulum, F. I. J. Lovy, 510; Action of Heat on Ethylene, H. Prof. V. B. Lewes, 520; Cause of Luminosity in Flames of Hydrocarbon Gases, Prof. V. B. Lewes, 520; Determination of Mass of Cubic Decimetre of Distilled Water at 4°, J. M. de Lapinay, 590; Annual Publication of French Physical Society, 613; Disturbances in Position of Plumb-line in Hawaiian Islands, F. D. Preston, 610; Freezing Points of Binary Mixtures of Heteromorphous Substances, Albert Duhm, 610; Critical Temperatures of Mixtures and of Water, F. A. Dwellshauvers Dery, 620; Boiling point of Hydrogen to Palladium at Various Temperatures and Pressures, Bakhuis Roozeboom and Dr. Houtsema, 624

Physiology: Origin of Tic-tocism and Undulations of Systolic Plateau of Arterial Pulsation, Victor Willem, 60; the Present State of Physiological Research, 58; Prof. Francis Gotch, F.R.S., 103; Histological Changes induced in Nerve Cells by Functional Activity, Dr. Gustave Mann, 93; Journal of Anatomy and Physiology, 93; Influence of Sterilisation on Digestibility of Milk, Dr. Bendix, 96; Cardiographic Researches on Mammals, Dr. Cowles, 96; Berlin Physiological Society, 99, 192, 210, 288, 312, 431, 503, 623; Inadequacy of Cell Theory, Adam Sedgwick, F.R.S., 110, 213; the Development of Nerves, Adam Sedgwick, F.R.S., 110, 213; the Cranial Nerves of Vertebrates in Amphibians, M. van Wijhe, 120; the so-called Organic Chloride of the Gastric Juice, H. Lescaur, 144; Effect of Temperature on Secretion of Sweat, Dr. Levy Donat, 162; Physiology for Beginners, Prof. M. Foster, F.R.S., and Lewis J. Shore, H. G. Wills, 195; Measurement of Blood in Circulation and Work done by Heart, Prof. Zuntz, 216; the Mode of Formation of Lymph, Dr. Cohnstein, 210; Influence of Force of Gravity on Circulation, Prof. Leonard Hill, 238; Death of Dr. Studiani, 251; Genesis of Intestinal Epithelium, Etienne de Rouvilly, 288; the Peyot Cactus Alkaloid, Prof. L. Lewin, 288; Effect of Suspension of Head on Circulation, Dr. G. Boncrystal, 288; the Terminations of Motor Nerves in Muscles, M. Sailer, 288; Formative Structures of Nervous System, Prof. Wadleyer, 312; Death of Dr. L. Kulz, 324; Influence of Nervous System on Glycose Formation and Hydrolysis, M. Kautmann, 300; New Method of Staining Cells with Aniline Dyes, Dr. Rawitz, 431; Action of Intravenous Injections of Sodium Chloride on Composition of Lymph and Blood, Dr. Cohnstein, 431; Modifications of Blood by Thermal Treatment with Bourboule Water, Ph. Lafon, 432; Doul-Bian, Action, L. C. Buce, 441; Physiological Action of Blood Damp, Dr. John Haldane, 477; Dr. M. Foster on the Teaching of Physiology in Schools, 487; Glycogen in Blood, M. Kautmann, 503; Relative Signification of Disengagement of Carbonic Acid and Absorption of Oxygen by Muscles, J. Tissot, 503; Effect of Load on Metabolism and Body Functions of Soldiers on the March, Prof. Zuntz, 503; Ureol-Infusoid, M. Franchimont, 504; on the Nature of Muscular Contraction, Prof. F. H. W. Engelmann, 510; Allgemeine Physiologie, Max Verworn, Dr. M. Foster, F.R.S., 520; Electro-physiologie, Prof. W. Biedermann, Prof. J. Burdon Sanderson, F.R.S., 553; Development of Branches of Fifth Cranial Nerve in Man, A. E. Dixon, 500; Influence of Sensory Nerves on Movement and Nutrition of Limbs, Drs. Mot and Sherrington, 620; the Formation of Uric Acid in Man, Dr. Weintraud, 623; Propyl Alcohol as Separator of Chloform, Steam Ears into High and Low Melting Points, Prof. Lieberich, 623; Tuberculous Germs possessors of Locomotive Power, F. Mac Gillyvray, 623; Origin of the Ammon, Prof. Habrecht, 624

- Direct (Kaoul), An anomalous Behaviour of Chloroform at very Low Temperatures, 20; Phosphorescence at very Low Temperatures, 260; Inability of Cotton-Wool to intercept Low Temperature Radiation, 28; Use of Critical Temperature for Recognition of Purity of Liquid, 288; Critical Point of Liquid-holding Solid in Solution, 311; Influence of Low Temperatures on Attractive Power of Artificial Permanent Magnets, 384; the Critical Point, 504
- Dietz (Dr.), Intense Cold as a Therapeutic Application, 588
- Pickering (Prof. E. C.), Stars having Peculiar Spectra, 302; Recent Work at Harvard College Observatory, 320
- Pickering (Prof. W. H.), Schiaparelli on Mars, 87; Lunar River Beds and Variable Spots, 580
- Pirkworth (Charles N.), the Slide Rule, 77
- Pigment, Pigments of, F. G. Hopkins, 142
- Pigeon (Leon), New Method of Preparation of Chloroplatinous Acid, 552
- Pigments of Pierida, F. G. Hopkins, 142
- Pipes, Cleaning Tobacco, Cecil Carns Wilson, 511
- Pisciculture: the Artificial Hatching of Marine Food-Fishes, Prof. McIntosh, 150; Oyster Culture on the West Coast of France, Prof. W. A. Herdman, F.R.S., 102; Death and Obituary Notice of Thomas Andrews, 270
- Pithecanthropus Erectus, eine Menschenaehnliche Uebergangsform aus Java, E. Dubois, 201, 228, 621
- Pizzetti (Prof. P.), I Fondamenti Matematici per la Critica dei Risultati sperimentali, 77
- Planetary Photography, C. T. Whirmell, 511
- Planets: the Transit of Mercury, 40, 85, 100, 253; Recent Observations of Jupiter, Prof. E. F. Barnard, 85; W. E. Denning, 227; Pseudo Satellites of Jupiter in the Seventeenth Century, Charles W. L. Johnson, 285; Observations on Mars, 49; Schiaparelli on Mars, Prof. W. H. Pickering, 87; Mars in 1894, G. Schiaparelli, 305; Seasonal Changes on Mars, Mr. Percival Lowell, 250; the Satellites of Mars, Prof. Campbell, 443; Secular Variations of the Interior Planets, Prof. Newcomb, 183; an Important Asteroid, M. Tisserand, 234; the Planet Earth: an Astronomical Introduction to Geography, R. A. Gregory, 201; Spectroscopic Measures of Planetary Velocities, M. Deslandres, 443; Distribution of Minor Planets, General Parmentier, 493
- Plant Houses, Green Glass in, 514
- Plants: Mechanism of the Respiration of, L. Maquenne, 24; Variation in Animals and Plants, Prof. W. E. R. Weldon, F.R.S., 449; Do Plants Assimilate Argon? F. Blass, 401; Prof. W. Ramsay, F.R.S., 401; a Popular Treatise on the Physiology of Plants, Dr. Paul Sclavovitz, 554; Practical Physiology of, Francis Darwin, F.R.S., and E. Hamilton Aiton, 577
- Playpus Embryo from Intrauterine Egg, J. P. Hill, and C. G. Martin, 204
- Plumpton (R. T.), Use of Barium Thiosulphate in Standardising Iodine Solution, 520
- Phoenician Mosaic, the Burmese Clipped Flute, Dr. W. T. Blanford, F.R.S., 608
- Pion Biological Station, the, 278
- Plumb-line in Hawaiian Islands, Disturbances in Direction of, J. D. Preston, 619
- Plummer (William F.), Chronometer Trials, 153; Storm Statistics at Bolton, 272
- Poock (R. L.), Malaysian Spiders, Phobos and M. F. Workman, 601; some Suggestions on the Origin and Evolution of Web-spinning of Spiders, 417
- Poebner (Frank), Apparitions and Thought Transference, H. G. Wells, 121
- Poincaré (A.), Connection of Earth and Disturbances of Lines of Barometric Maxima with Direction Movements of Moon, 600
- Poirard (H.), Les Oscillations Electriques, 361; the Fluted Star, 300, 500
- Polarization, a Class of Secondary Batteries, 528; a Battery with Liquid Metallic Electrodes, 563
- Polarization of Mars, the, 64
- Polarization Work, Method of obtaining Light of Different Wave-lengths, U. von Helldob, 37
- Primary Rays of Cosmic Radiation, Dr. W. V. de Cham, 623
- Prism, the, H. E. Rowley, 541; Earth, E. C. B., 538
- Prism, A., the Critical Point of Dilute Solutions of Starch, 504, 517
- Prism, F. S., Death, an Obituary Notice of, 370
- Pope (F. G.), Elementary Practical Chemistry, Inorganic and Organic, 304
- Pope (William J.), the Use of the Globe in Crystallography, 223; Melting Points of Racemic Modifications and Optically Active Isomerides, 526
- Porro (Francesco), *Astronomia Sferica*, 53
- Port Erin Marine Biological Station, the, Prof. Herdman, 281
- Porter (A. W.), Influence of the Dimensions of Body on Thermal Emission from Surface, 310; the Question of Dielectric Hysteresis, 574
- Porter (William Townsend), the Growth of St. Louis Children, Prof. Karl Pearson, 145
- Pouchet (Prof.), Bequest to Paris Society of Biology, by, 61
- Poulton (Edward B., F.R.S.), Acquired Characters, 55, 120
- Power, on the Development and Transmission of, Prof. William Cawthorne Unwin, F.R.S., 124
- Prain (Dr.), the Bhang Plant, 143
- Precious Stones, and How to Distinguish them, H. A. Miers, 545
- PreCambrian Rocks, the Barrenness of, Dr. C. Callaway, 462
- Preec's (W. H., F.R.S.), Method of Telegraphy by Induction, 587
- Prehistoric Ceramics from Langenlebern Tumulus, J. Szombathy, 157; Prehistoric Objects in North-east Italian Museum, Dr. Hoernes, 157
- Preller (Dr.), Fluvio-glacial and Interglacial Deposits in Switzerland, 575
- Present, Past and, Right Hon. T. H. Huxley, F.R.S., 1
- Pressures in Gums, the Measurement of, Rev. F. Bashforth, 461
- Prestwich (Joseph, F.R.S.), Collected Papers on some Controversial Questions of Geology, 601
- Primitive Culture, Woman's Share in, O. T. Mason, 244
- Prince Henry the Navigator, C. Raymond Beazley, 532
- Pringsheim (Nathanael), Obituary Notice of, Dr. H. Scott, 300
- Priority, a Claim for, Alex. E. Oosterbridge, 608
- Proceedings of the Chemical Society, the, Prof. William Ramsay, F.R.S., 204
- Propane, the Properties of Liquid Ethane and, A. E. Tutton, 65
- Prothero (Prof.), History as a Science, 162
- Psychology: Psychologie des Grands Calculateurs and Joueurs d'Echecs, Alfred Binet, Francis Galton, F.R.S., 73; Apparitions and Thought Transference, Frank Podmore, H. G. Wells, 121; Peculiarities of Psychical Research, Prof. Karl Pearson, 153, 200, 273; Edvard T. Dixon, 200, 223; Prof. Oliver J. Lodge, F.R.S., 247; H. G. Wells, 274; Lectures on Human and Animal Psychology, Wilhelm Wundt, 173; Grundriss der Psychologie, Oswald Kulpe, 173; Introduction to Comparative Psychology, C. Lloyd Morgan, 173; Psychology for Teachers, 173; Primer of Psychology, George Trumbull Ladd, 173; Dr. Gilbert's Researches on Development of School Children, 232; Dual Brain Action, L. C. Bruce, 441
- Puiseux (M.), Photographic Studies of Lunar Surfaces, 143; Advances in Lunar Photography, 207
- Pupin (M. J.), Resonance Analysis of Alternating Currents, 93, 100; an Automatic Mercury Vacuum Pump, 334
- Purman (Prof. F. W.), Copper Sheathed Objects made by Aboriginal Metallurgists of America, 400
- Pyrometers, the Testing of Platinum, Dr. W. Wien, 623
- Quarrying of Granite in India, the, Dr. H. Warth, 272
- Quarterly Journal of Microscopical Science, 213
- Quaternions: Anwendung der Quaternionen auf die Geometrie, Dr. F. Molenbroek, 70; the Outlines of Quaternions, Lieut.-Colonel H. W. L. Hume, 70, 154; the Elements of, Lieut.-Colonel H. W. L. Hume, 201
- Quincke (Dr.), Fantastic Forms Assumed by Combinations of Alkalies and Oleic Acid in Contact with Water, 182
- Races, Early British, Dr. J. G. Garson, 67, 90
- Racovitz (I. G.), Role of Amoebocytes in Annelids, 455
- Radiotele Catalogue, the, 183
- Radiant Suns, Agnes Gilbert, 174
- Rainbow, a White, Rev. Samuel Barber, 274
- Rainmaking and Sunshine, John Collinson, 7
- Ramage (H.), the Volumetric Determination of Manganese, 454
- Rambaut (Dr.), Atmospheric Dispersion, 300
- Ramsay (A.), the "Bore" Condition of the Atmosphere, 84
- Ramsay (Sir Andrew), Memorial of Sir Archibald Geikie, 385

Kamsay (Prof. William, F.R.S.), the Proceedings of the Chemical Society, 204; Measurement of Latent Heats of Vaporisation of Various Organic Liquids, 300; the New Constituent of the Atmosphere, 347; Do Plants Assimilate Argon? 401; Terrestrial Helium (?), 543  
 Ranyard (A. C.), Obituary Notice of, 170  
 Ratio of the Specific Heats of Gases, the, S. H. Burbury, F.R.S., 127  
 Rawitz (Dr.), New Method of Staining Cells with Aniline Dye, 431  
 Rawlinson (Sir Henry, F.R.S.), Death of, 449; Obituary Notice of, 535  
 Rayleigh (Lord, Sec. R.S.), the New Constituent of the Atmosphere, 347  
 Reddrop (J.), the Volumetric Determination of Manganese, 454  
 Reed (W. Maxwell), Irregularities in Variable Stars, 183  
 Regnaud (Prof. Jules), Death of, 302  
 Reinsch (Dr.), Bacteriological Investigation of Altona Water-Supply, 231  
 Reise nach Sündrien, Émil Schmidt, 101  
 Reliquary, Science in the, 382  
 Renou (E.), Meteorological Conditions of neighbourhood of Paris for February, 1895, 480  
 Research in Education, Dr. H. E. Armstrong, F.R.S., 403  
 Research, Physiological, the Present State of, 58; Prof. Francis Gotch, F.R.S., 103  
 Research and Publication, Endowment for Scientific, Addison Brown, 104, 186  
 Respiration of Plants, Mechanism of, L. Mequenne, 24  
 Retgers (Prof.), a New Method of Preparing Phosphoretted Hydrogen, 23  
 Reusch (Dr. Hans), Earthquakes in Norway, 300

REVIEWS AND OUR BOOK SHELF—

A Dictionary of the Economic Products of India, George Watt, 4  
 Butterflies from China, Japan, and Corea, John Henry Leech, 6  
 Rainmaking and Sunshine, John Collinson, 7  
 The Elements of Graphic Statics; a Text-book for Students of Engineering, L. M. Hoskins, 7  
 A Naturalist on the Prowl, 8  
 From Spring to Fall, 8  
 Edible and Poisonous Mushrooms, Dr. M. C. Cooke, 8  
 Theophrastus of Eresus, on Winds and on Weather Signs, 25  
 Travels amongst American Indians, their Ancient Earthworks and Temples, Vice-Admiral Lindesay Brine, 20  
 Journal of the Academy of Natural Sciences of Philadelphia, 20  
 Watt's Dictionary of Chemistry, 27  
 Text-book of the Diseases of Trees, Prof. R. Hartig, W. K. Fisher, 28  
 Le centre de l'Afrique: Autour du Tchad, P. Brumaucé, 29  
 Helical Gears, 30  
 The Nests and Eggs of Non-Indigenous British Birds, Charles Dixon, 30  
 Commercial Geography, E. C. R. Gomer, 30  
 Dynamometers and the Measurement of Power, John J. Flather, 30  
 Electric Light and Power, Arthur F. Guy, 30  
 The Science of Mechanics; a Critical and Historical Exposition of its Principles, Dr. Ernest Mach, Prof. A. G. Greenhill, F.R.S., 30  
 A Text-book of Inorganic Chemistry, G. S. Newth, M. M. Pattison Muir, 52  
 Astronomia Sierica, Francesco Porro, 53  
 The New Technical Educator, 53  
 Index Kewensis Plantarum Phanerogamarum, 54  
 Alpine Climates for Consumption, H. J. Hardwicke, 54  
 Psychologie des Grands Calculateurs et Joueurs d'Échecs, Alfred Binet, Francis Galton, F.R.S., 73  
 Wilhelm Olters, sein Leben und seine Werke, Dr. C. Schilling, 74  
 Anwendung der Quaternionen auf die Geometrie, Dr. P. Molenbrock, 76  
 The Outlines of Quaternions, Lieut. Colonel H. W. L. Hime, 76  
 Sir Victor Brooke, Sportsman and Naturalist, O. L. Stephen, 76  
 A Text-book of Dynamics, a Text-book of Statics, William Briggs and G. H. Bryan, 76

The Slide Rule, Chas. N. Pickworth, 77  
 I Fondamenti Matematici per la Critica dei Risultati Sperimentali, Prof. F. Pizzetti, 77  
 Teppich-erzeugung im Orient, 77  
 A Laboratory Manual, W. R. Orndorff, 77  
 The Construction of the Modern Locomotive, George Hagnon, N. J. Lockyer, 97  
 Malaysian Spiders, Thos. and M. E. Workman, R. E. Powell, 99  
 The Deserts of Southern France, an Introduction to Limestone and Chalk Plateaux of Ancient Aquitaine, S. Baring Gould, Canon Bouney, F.R.S., 100  
 An Elementary Treatise on Theoretical Mechanics, Alexander Ziwet, 101  
 By Order of the Sun to Chile to see his Total Eclipse, April 19, 1893, J. J. Aubertin, 101  
 Reise nach Sündrien, Émil Schmidt, 101  
 By Vocal Woods and Waters, Edward Step, 102  
 Apparitions and Thought Transference, Frank Johnson, H. G. Wells, 121  
 The Dawn of Civilisation, Egypt and Chabka, G. Maspero, 122  
 On the Development and Transmission of Power, William Cawthorne Unwin, F.R.S., 124  
 A Treatise on Hygiene and Public Health, Thomas Stevenson and Shirley F. Murphy, 124  
 Involution and Evolution according to Philosophy of Cycles, Kalpha, 125  
 The Mountains of California, J. Muir, 125  
 The Growth of St. Louis Children, William Townsend Porter, Prof. Karl Pearson, 145  
 The Principles of Water-works Engineering, J. H. Tadshery Turner and A. W. Brighmore, 149  
 The Water Supply of Towns, W. K. Burton, 149  
 A Text-book of Pathology, Systematic and Practical, D. J. Hamilton, 148  
 The Mechanism of Weaving, E. W. Fox, 149  
 Memorials of Old Whitby, Rev. J. C. Atkinson, 149  
 Die Schöpfung der Tierwelt, Dr. Wilhelm Haacke, 149  
 The Vaccination Question, Arthur Wollaston Hutton, 149  
 Dr. William Smellie and his Contemporaries, John Glaister, 149  
 The Life of Richard Owen, Rev. Richard Owen, 160  
 Electromagnetic Theory, Oliver Heaviside, F.R.S., J. Swinburne, 171  
 Lectures on Human and Animal Psychology, Wilhelm Wundt, 173  
 Grundriss der Psychologie, Oswald Külpe, 173  
 Introduction to Comparative Psychology, C. Lloyd Morgan, 173  
 Psychology for Teachers, C. Lloyd Morgan, 173  
 Primer of Psychology, George Fimmbull Ladd, 173  
 Radiant Suns, Agnes Osborne, 174  
 Album von Japan-Tyoen, A. B. Meyer and R. Parkinson, 174  
 Farm Vermin, Helpful and Harmful, 174  
 A Treatise on Chemistry, Su H. F. Roscoe, F.R.S., and C. Schorlemmer, F.R.S., M. M. Pattison Muir, 193  
 Man, the Primeval Savage, Worthington G. Smith, Prof. W. Boyd Dawkins, F.R.S., 194  
 Physiology for Beginners, Prof. M. Foster, F.R.S., and Lewis F. Shore, H. G. Wells, 195  
 Outlines of Biology, F. Chalmers Mitchell, H. G. Wells, 195  
 Practical Methods in Microscopy, C. H. Clark, H. G. Wells, 195  
 Climbing and Exploration in the Karakoram-Himalayas, William Martin Conway, F.S.A., 196  
 The Royal Natural History, Richard Lydekker, F.R.S., 197  
 Kitchen Boiler Explosions, R. D. Munro, 197  
 The Island of Madeira, for the Invalid and Naturalist, Surgeon-General C. A. Gordon, 197  
 Biological Lectures and Addresses delivered by the late Arthur Milnes Marshall, F.R.S., 217  
 Advanced Agriculture, H. J. Webb, 218  
 The Steam Engine and other Heat Engines, Prof. J. A. Ewing, F.R.S., 219  
 Das Verhältniss der Philosophie zu der empirischen Wissenschaft von der Natur, David Wetterhan, 220  
 Meteorology, Practical and Applied, John William Moore, 220  
 The Province of South Australia, J. D. Wood, 221

- Measurement of Area by Diagrams, Robert H. Smith, 221  
Die Antänge der Kunst, Dr. E. Grosse, Prof. A. C. Haddon, 241  
A Handbook to the Primates, H. O. Forbes, 242  
Birds of the Wave and Woodland, Phil. Robinson, 243  
Studies on the Parasitic Trematodes of Japan, S. Ueda, 244  
Woman's Share in Primitive Culture, O. T. Mason, 244  
A Text-Book of Sound, E. Catehpool, 244  
Oniva, Prof. Eugenio Geleichi, 244  
Zeit- und Streitfragen der Biologie, Prof. Dr. Oscar Hertwig, 244  
C. Bourne, 265  
Coal-Dust an Explosive Agent, as shown by an Examination of the Camerton Explosion, Donald M. P. Stuart, 268  
Die Lebensweise der Meeres-Thiere, Johannes Walther, 269  
Elementary Qualitative Chemical Analysis, Prof. Frank Clowes, and J. B. Coleman, 270  
Tables and Directions for the Qualitative Chemical Analysis of Moderately Complex Mixtures of Salts, M. M. Pattison Muir, 270  
Laboratory Exercise Book for Chemical Students, E. Francis, 270  
Elements of Astronomy, G. W. Parker, 270  
Lehrbuch der Vergleichenden Anatomie, Arnold Lang, Prof. F. Kay Lankester, F.R.S., 280  
Lehrbuch der Petrographie, Dr. Ferdinand Zirkel, 260  
Etheozanthropas, Frensis, eine Menschennähnliche Ueber-gangsform aus Java, E. Dubois, 261  
The Planet Earth, R. A. Gregory, 291  
Lithogenesis der Gegenwart, Johannes Walther, 313  
Geozekonsche Profle von A. Rothpletz, 313  
Morphologie der Erdkratte, Dr. Albert Penck, Dr. J. J. Gregory, 313  
The Rise and Development of Organic Chemistry, Carl S. Schorlemmer, F.R.S., 317  
British Birds, Claude W. Wyatt, 318  
Standard Methods in Physics and Electricity Criticised, and a Test for Electric Meters Proposed, H. A. Naber, 318  
Electrical Engineering, for Electric Light Artisans and Students, W. Shingo and A. Brooker, 318  
Lens Work for Amateurs, Henry Oxford, 318  
Manual of Practical Morbid Anatomy, H. D. Rolleston and A. A. Kauthaek, 318  
Lehrbuch der Botanik, Drs. E. Strasburger, F. Noll, H. Schenck and A. T. W. Schimper, 339  
Butterflies and Moths, British, W. Furzeaux, W. F. Kirby, 339  
Die Resultate der Vetzmethode in der kristallographischen Forschung, an eine Reihe von kristallisirten Korpern dargestellt, Dr. H. Baumhauer, 340  
Summer Studies of Birds and Books, W. Warde Fowler, 341  
Forest Birds, their Habits and Habits, Harry F. Witherby, 341  
Les Oscillations Electriques, H. Poincaré, Prof. A. Gray, 361  
The Book of the River, Rev. A. Foster Melhar, 362  
L'Industrie des Aramnia, Woldemar Wagner, 363  
Elementary Practical Chemistry, Inorganic and Organic, J. T. Heath, 364  
How to Live in Tropical Africa, J. Murray, 364  
Memoir of Sir Andrew Grant, by Ramsay, Sir Archibald Geikie, 385  
Harvard College by an Oxonian, George Birkbeck Hill, 386  
Tableau Métrique de Logarithmes, C. Dumesnil, 386  
In Canada Forest, June Rodway, 387  
Lehrbuch der Experimentalphysik, A. Wallner, 387  
Peru, F. W. Muddendort, 388  
Handbuch der Stereochemie, Dr. C. A. Bischoff, 400  
Les Abimes, les grottes souterraines, les cavernes, les sources, la speleologie, F. A. Martel, 410  
Bulletin of the Botanical Department, Jamaica, W. Laweett, 412  
Die Maschinen der H. Kautschuk-Industrie, A. Bernicki, 412  
W. W. G. and D. M. G. C. M. Aikman, 412  
An Elementary Text-Book of Anatomy, Prof. H. E. Clark, 412  
Anatomy and the Anatomy of the Vertebrates, Arthur Willey, 433  
Die Cycloplegie des Nages, 434  
Cotton and Synthetic Weaving, J. H. Waller, 435  
Herpetologie für Europa, Alfr. E. Reuss, 435  
Preparatory Physics, William I. Hopkins, 430  
The Story of the Stars, George F. Chambers, 430  
Aerial Navigation, 430  
The Life and Correspondence of William Buckland, F.R.S., Mrs. Gordon, 457  
The Birds of Eastern Pennsylvania and New Jersey, 458  
Conspectus Florae Africae, ou Enumeration des Plantes d'Afrique, Th. Durand et Hans Schinz, 459  
Lecons de Chimie, H. Gautier et G. Charpy, 400  
Lehrbuch der Bakteriologischen Untersuchung und Diagnostik, Dr. Ludwig Heim, Mrs. P. Frankland, 481  
Die wissenschaftlichen Grundlagen der analytischen Chemie, W. Ostwald, J. W. Rodger, 482  
An Introductory Account of Certain Modern Ideas and Methods in Plane Analytical Geometry, Charlotte Angus Scott, 483  
Les Aurores Polaires, Alfred Angot, 484  
A Few Chapters in Astronomy, Claudius Kennedy, 484  
Mechanics for Colleges and Schools: Statics, R. T. Glazebrook, F.R.S., 484  
The Telegraphist's Guide, James Bell, 484  
American Spiders and their Spinning Work, Henry C. McCook, Rev. O. P. Cambridge, F.R.S., 505  
Sea and Land, Features of Coasts and Oceans, with Special Reference to the Life of Man, N. S. Shaler, 507  
Cod-liver Oil and Chemistry, F. Peckel-Moller, J. Cameron, 508  
Astronomische Chronologie, W. J. Wislicenus, 509  
Die ältesten Karten der Isogenen, Isoclinen, Isodynamen, Prof. Dr. G. Hellman, 509  
An Elementary Text-Book of Hydrostatics, W. Briggs and G. Bryan, 509  
Allgemeine Physiologie, Max Verworn, Dr. M. Foster, F.R.S., 520  
Theoretical Chemistry, from the Standpoint of Avogadro's Rule, and Thermodynamics, Prof. Walter Nernst, M. M. Pattison Muir, 530  
Bird Notes, Jane Mary Hayward, 532  
Catalogue of Birds of Prey (Accipitres and Strigae), J. H. Gurney, 532  
Prince Henry the Navigator, C. Raymond Beazley, 532  
An Elementary Treatise on Theoretical Mechanics, Alexander Ziwet, 533  
Electrophysiologie, W. Biedermann, Prof. J. Burdon-Sanderson, F.R.S., 553  
A Popular Treatise on the Physiology of Plants, for the Use of Gardeners, or for Students of Horticulture and of Agriculture, Dr. Paul Souner, 554  
Traite des Gites Mineraux et Metalliferes, E. Fuchs and L. de Launay, 555  
Etude industrielle des Gites Metalliferes, George Moreau, 555  
Elementary Text Book of Metallurgy, A. Humboldt Sexton, 559  
Annals of British Geology, J. E. Blake, 557  
The Origins of Invention, Otis T. Mason, 557  
Short Studies in Nature Knowledge, William Gee, 557  
Organic Chemistry, the Fatty Compounds, R. Lloyd Whiteley, 557  
Practical Physiology of Plants, Francis Darwin, 577  
Mussel Culture and Bait Supply, with reference more especially to Scotland, W. L. Calderwood, 578  
A History of Epidemics in Britain, Charles Creighton, 579  
Grundzüge der Mathematischen Chemie, Dr. G. Helm, 580  
Die Bearbeitung des Glases auf dem Blasische, Dr. Djakow and W. Lermantoff, 580  
Problems and Solutions in Elementary Electricity and Magnetism, W. Shingo and A. Brooker, 580  
Qualitative Chemical Analysis of Inorganic Substances, 580  
Collected Papers on some Controversial Questions of Geology, Joseph Prestwich, Prof. J. W. Judd, F.R.S., 601  
My Weather-wise Companion, 602  
A Monograph of the Mycetoza, being a Descriptive Catalogue of the Species in the British Museum, Arthur Lister, 603  
La Pratique du Tentateur, Jules Gargon, J. S. M. Gardiner, 604  
The Fauna of British India, including Ceylon and Burma, W. F. Kirby, 605  
Reynolds (Prof. J. Emerson, F.R.S.), Argon and the Periodic System, 486  
Rev. Dr. Geo. A. Death and Obituary Notice of, 538  
Rhynchonema Terrestrial in England, F. W. Gamble, 33

- Rhynchonella terrestris* in Germany, H. Sauer, 264  
 Rhodologia, J. C. Sawyer, 30  
 Riccio (A.), the Variations in Level of Well-water, 62  
 Riccio (Prof.), the Sicilian Earthquakes of August 1891, 27  
 Richard (Jules), Gases of Swimming Bladder of Fishes, 579  
 Richmond (James G.), the Recent Auroral Phenomena, 381  
 Ricour's Experiments to Overcome Air-Resistance to Locomotive at High Speed, Max de Nansouty, 62  
 Ridley (Mr.), Formica Smagdarina, 65  
 Rippon (H. F.), the Bird-Winged Butterflies of the East, 243  
 Ritter (M.), Anemometry and Vertical Currents of Atmosphere, 469  
 River Temperature, Methods of Determining Influence of Springs on, Dr. H. B. Guppy, 110  
 River-Temperature Variations, Central Europe, Dr. A. E. Forster, 83  
 Roberts (W. R. Westropp), a Foucault Pendulum at Dublin, 510  
 Robertson (K.), Electrical Haulage at Fernock Colliery, 499  
 Robinson (Mark), Vibration of Steamers, 579  
 Robinson (Phil), Birds of the Wave and Woodland, 243  
 Roborovsky (M.), Survey of Lukchun (Tibet) Depression, 401  
 Rocks, the Study of, 296  
 Rodger (J. W.), the Electric Conductivity of Pure Water, 42; Die wissenschaftlichen Grundlagen der Analytischen Chemie, W. Ostwald, 482; the Freezing Point of Dilute Solution, 617  
 Rodway (James), In the Guiana Forest, 387  
 Roger (H.), Action of High Pressure on Bacteria, 198  
 Rolleston (H. D.) and A. A. Kauthack, Manual of Practical Morbid Anatomy, 318  
 Romanes (Dr. G. J.), Longevity and Death, 381  
 Romburgh (Dr. P. van), Volatile Constituents of Coca Leaves, 408; Nitro-Derivatives of Dimethylaniline, 624; Addition Products of Symmetrical Trinitrobenzol, 624  
 Rondelet's Rule for Woods and End-loaded Beams, C. Malczus, 622  
 Roozeboom (Bakhuis), Behaviour of Hydrogen to Palladium at Various Temperatures and Pressures, 624  
 Roscoe (Sir H. E., F.R.S.), a Treatise on Chemistry, M. M. Pattison Muir, 193  
 Rosenstiehl (A.), Moniodammonium Derivatives of Hexamethyltriamidoditriphenylmethane, 384  
 Rose, the Book of the, Rev. A. Foster-Melliar, 362  
 Roses, Sawyer's Rhodologia, 30  
 Roszel (M.), the Mass of the Asteroids, 373  
 Rotation, the Alleged Absoluteness of Motions of, Prof. A. G. Greenhill, F.R.S., 105; A. E. H. Love, F.R.S., 105, 153, 198; A. B. Basset, F.R.S., 271; Prof. Oliver J. Lodge, F.R.S., 272  
 Rotation of Venus, the, M. Flammarion, 21  
 Roth (A. L.), the Meteorological Services of South America, 45  
 Rothert (Dr. W.), Heliotropism, 84  
 Rothpletz (A.), Geotektonische Probleme, 313  
 Rouville (Étienne de), Genesis of Intestinal Epithelium, 288  
 Royal Horticultural Society, 281  
 Royal Meteorological Society, 110, 215, 314, 527, 621  
 Royal Microscopical Society, 95, 191, 335  
 Royal School of Mines, Paleontology at the, Right Hon. T. H. Huxley, F.R.S., 223  
 Royal Society, 35, 93, 142, 214, 238, 334, 452, 477, 520, 550, 573, 599, 620; Anniversary Meeting of the, 132; Address by Lord Kelvin, 133; Medals awarded by the, 136  
 Rubens (Dr.), Distance-Telegraphy without Wires, 100  
 Rucker (Prof. A. W., F.R.S.), the Work of Hermann von Helmholtz, 44, 472, 493; Objective Reality of Combination Tones, 550  
 Ruffer (Dr. M. A.), the Treatment of Diphtheria by Anti-Toxic Serum, 16  
 Runge (Herr), Prof. V. Pechman, and a New Series of Nitrogen Compounds, 114  
 Russell (H. C.), the Travels of Three Bottle Papers, 35  
 Russia, Catalogue of Earthquakes in, Prof. Mushketoff and A. Orloff, 181  
 Russia, Recent Exact Levelling Operations in, General Venukoff, 359  
 Russian Astronomical Observations, 207  
 Russian Chemical and Physical Society, Journal of, 452  
 Ruwenzori, Exploration at, G. F. Scott Elliot, 274  
 Ruwenzori, Mount, the Glaciation of, Scott Elliot, 441  
 Ryder (Prof. J. A.), Death of, 587  
 Ryves (Rev. G. T.), the Recent Drought in the Midlands, 23  
 Sabatier (Paul), A Treatise on Nitrous Oxide on Metals and Metal Oxides, 528  
 Safety Explosives in Mines, 296; Use of, 184  
 St. Louis Children, the Growth of, William Townsend Porter, Prof. Karl Pearson, 145  
 St. Petersburg Academy of Sciences, 270  
 St. Petersburg, Bulletin of L'Académie Royale de, 477  
 St. Petersburg Society of Naturalists, Journal of, 560  
 St. Petersburg University, the New Laboratory at, 392  
 Salts, Tables and Directions for the Qualitative Chemical Analysis of Moderately Complex Mixtures of, M. M. Pattison Muir, 270  
 Samoyed Race, the, Arthur Monchore, 270  
 Sand Blast, Applications of the, J. G. Holtzapfel, 588  
 Sanderson (Prof. J. Burdon, F.R.S.), Electrophysiology, Prof. W. Biedermann, 553  
 Sandwich Islands, Kandail of, Dr. J. Haun, 599  
 Sanitation; Death of Mr. E. Turner, 313  
 Sankey (Captain H. R.), the Metric System, 502; Vibration of Steamers, 579  
 Sap, the Ascent of, H. H. Dixon and Dr. J. Joly, F.R.S., 93  
 Saporta (Marquis de), Death of, 370  
 Sargent (Prof. C. S.), Forest Preservation, 389  
 Saussure (René de), Graphical Thermodynamics, 334  
 Savory (Sir William, F.R.S.), Death of, 449  
 Sawyer (J. C.), Rhodologia, 30  
 Scheibele (Prof.), a Possible New Satellite of Neptune, 542  
 Schenk (Dr. H.), Lehrbuch der Botanik, Drs. L. Strasburger, F. Noll, and A. E. W. Schimper, 339  
 Schenking-Prevot (Herr), the Tongue and Hyoid Apparatus, Bross, 252  
 Schiaparelli (G.), on Mars, Prof. W. H. Pickering, 87; Mars, 1894, 395  
 Schilt (Prof.), Ammonium Thiocetate as Substitute for Sphurified Hydrogen, 373  
 Schimper (Dr. A. E. W.), Lehrbuch der Botanik, Drs. E. Strasburger, F. Noll, and H. Schenk, 339  
 Schinz (Hans), Conspectus Flor. Africae, or Enumeration des Plantes d'Afrique, 450  
 Schläfli (Prof. Ludwig), Death of, 538  
 Schlick (Otto), Vibration of Steamers, 569  
 Schmidt (H.), Speed of Liberation of Ethne in Mixed Solutions, 340  
 Schützenberger (P.), the Atomic Weight of Cerium, 552  
 Schmidt (Emil), Reise nach Südrussien, 104  
 Schmidt (Dr.), a Pure White Disulphide of Tin, 85  
 Schmitz (Dr. E.), Death of, 392  
 Schneider (Prof.), Redetermination of Atomic Weights of Erbium, 131  
 Schonland (J.), Snake Cannibalism, 511  
 Schools, Geometry in, Edward M. Langley, 179  
 Schools, Science Teaching in, W. B. Crump, Grace Heath, 59; O. Henrici, 106; H. G. Wells, 106  
 Schoenheimer (C.), a Treatise on Chemistry, M. M. Pattison Muir, 193; the Rise and Fall of Organic Chemistry, 317  
 Schrotter (Dr. Josef), Death of, 251  
 Schumann's (Dr. Victor) Atomic Spectrograph, 423  
 Schuster (Prof. Arthur, F.R.S.), the Kinetic Theory of Gases, 293  
 Schwabé (Dr.), Endeavors to Utilise for Scientific Purposes the Curves of Temperature obtained from the "Carnus" Pillars, 72  
 Schwarz (Dr. L.), Death of, 111  
 Science; Science in the Magazines, 44, 101, 250, 380, 450, 545; Science Teaching in Schools, W. B. Crump, Grace Heath, 59; O. Henrici, 106; H. G. Wells, 106; Endowment for Scientific Research and Publication, Addison Brown, 104, 186; Science and History, Alfred H. Hath, 176; Scientific Investigation in Canada, Dr. G. M. Dawson, F.R.S., 236; Italian Scientific Expedition to Monte Rosa, Dr. Piero Giacosa, 57  
 Scotland; Scientific Investigation of Scottish Fishery Board, 115; the Starling in, J. H. Harvey-Brown, 280; Mussel Culture and the Bait Supply, with reference more especially to Scotland, W. L. Calderwood, 578; Scottish Meteorological Society, 542, 621  
 Scott (Charlotte) Angström, an Introductory Account of certain Modern Ideas and Methods in Plane Analytical Geometry, 483  
 Scott (Dr. D. H., F.R.S.), Fossil Plants of Coal Measures, H. the Roots of Calamites, 94  
 Scott (D. H.), Obituary Notice of N. Chanael Fringsheim, 399

- S... Monkeys, Sir C. C. ... Nile, 444
- S... Laws, Principles in the Foundations of, J. I. Thomson, 1, 2, 8, 11, 13, W. Barnaby, 502
- S... ner's Magazine, Science, 44, 381
- S... and Land, Features of Coasts and Oceans, with Special Reference to the Life of Man, N. S. Shaler, 307
- S... Water, the Methods for Determining Density of, W. S. Anderson, 64
- S... Water in the Ocean; Deposits, Chemical Changes between, Dr. John Murray and Robert Irvine, 304
- S... and Changes on Mars, Mr. Percival Lowell, 251
- S... Variation of Terrestrial Magnetism, W. de la Roche, 1, 2, 3, 4, 5, 6, 7, 8, 9, 10, 11, 12, 13, 14, 15, 16, 17, 18, 19, 20, 21, 22, 23, 24, 25, 26, 27, 28, 29, 30, 31, 32, 33, 34, 35, 36, 37, 38, 39, 40, 41, 42, 43, 44, 45, 46, 47, 48, 49, 50, 51, 52, 53, 54, 55, 56, 57, 58, 59, 60, 61, 62, 63, 64, 65, 66, 67, 68, 69, 70, 71, 72, 73, 74, 75, 76, 77, 78, 79, 80, 81, 82, 83, 84, 85, 86, 87, 88, 89, 90, 91, 92, 93, 94, 95, 96, 97, 98, 99, 100, 101, 102, 103, 104, 105, 106, 107, 108, 109, 110, 111, 112, 113, 114, 115, 116, 117, 118, 119, 120, 121, 122, 123, 124, 125, 126, 127, 128, 129, 130, 131, 132, 133, 134, 135, 136, 137, 138, 139, 140, 141, 142, 143, 144, 145, 146, 147, 148, 149, 150, 151, 152, 153, 154, 155, 156, 157, 158, 159, 160, 161, 162, 163, 164, 165, 166, 167, 168, 169, 170, 171, 172, 173, 174, 175, 176, 177, 178, 179, 180, 181, 182, 183, 184, 185, 186, 187, 188, 189, 190, 191, 192, 193, 194, 195, 196, 197, 198, 199, 200, 201, 202, 203, 204, 205, 206, 207, 208, 209, 210, 211, 212, 213, 214, 215, 216, 217, 218, 219, 220, 221, 222, 223, 224, 225, 226, 227, 228, 229, 230, 231, 232, 233, 234, 235, 236, 237, 238, 239, 240, 241, 242, 243, 244, 245, 246, 247, 248, 249, 250, 251, 252, 253, 254, 255, 256, 257, 258, 259, 260, 261, 262, 263, 264, 265, 266, 267, 268, 269, 270, 271, 272, 273, 274, 275, 276, 277, 278, 279, 280, 281, 282, 283, 284, 285, 286, 287, 288, 289, 290, 291, 292, 293, 294, 295, 296, 297, 298, 299, 300, 301, 302, 303, 304, 305, 306, 307, 308, 309, 310, 311, 312, 313, 314, 315, 316, 317, 318, 319, 320, 321, 322, 323, 324, 325, 326, 327, 328, 329, 330, 331, 332, 333, 334, 335, 336, 337, 338, 339, 340, 341, 342, 343, 344, 345, 346, 347, 348, 349, 350, 351, 352, 353, 354, 355, 356, 357, 358, 359, 360, 361, 362, 363, 364, 365, 366, 367, 368, 369, 370, 371, 372, 373, 374, 375, 376, 377, 378, 379, 380, 381, 382, 383, 384, 385, 386, 387, 388, 389, 390, 391, 392, 393, 394, 395, 396, 397, 398, 399, 400, 401, 402, 403, 404, 405, 406, 407, 408, 409, 410, 411, 412, 413, 414, 415, 416, 417, 418, 419, 420, 421, 422, 423, 424, 425, 426, 427, 428, 429, 430, 431, 432, 433, 434, 435, 436, 437, 438, 439, 440, 441, 442, 443, 444, 445, 446, 447, 448, 449, 450, 451, 452, 453, 454, 455, 456, 457, 458, 459, 460, 461, 462, 463, 464, 465, 466, 467, 468, 469, 470, 471, 472, 473, 474, 475, 476, 477, 478, 479, 480, 481, 482, 483, 484, 485, 486, 487, 488, 489, 490, 491, 492, 493, 494, 495, 496, 497, 498, 499, 500, 501, 502, 503, 504, 505, 506, 507, 508, 509, 510, 511, 512, 513, 514, 515, 516, 517, 518, 519, 520, 521, 522, 523, 524, 525, 526, 527, 528, 529, 530, 531, 532, 533, 534, 535, 536, 537, 538, 539, 540, 541, 542, 543, 544, 545, 546, 547, 548, 549, 550, 551, 552, 553, 554, 555, 556, 557, 558, 559, 560, 561, 562, 563, 564, 565, 566, 567, 568, 569, 570, 571, 572, 573, 574, 575, 576, 577, 578, 579, 580, 581, 582, 583, 584, 585, 586, 587, 588, 589, 590, 591, 592, 593, 594, 595, 596, 597, 598, 599, 600, 601, 602, 603, 604, 605, 606, 607, 608, 609, 610, 611, 612, 613, 614, 615, 616, 617, 618, 619, 620, 621, 622, 623, 624, 625, 626, 627, 628, 629, 630, 631, 632, 633, 634, 635, 636, 637, 638, 639, 640, 641, 642, 643, 644, 645, 646, 647, 648, 649, 650, 651, 652, 653, 654, 655, 656, 657, 658, 659, 660, 661, 662, 663, 664, 665, 666, 667, 668, 669, 670, 671, 672, 673, 674, 675, 676, 677, 678, 679, 680, 681, 682, 683, 684, 685, 686, 687, 688, 689, 690, 691, 692, 693, 694, 695, 696, 697, 698, 699, 700, 701, 702, 703, 704, 705, 706, 707, 708, 709, 710, 711, 712, 713, 714, 715, 716, 717, 718, 719, 720, 721, 722, 723, 724, 725, 726, 727, 728, 729, 730, 731, 732, 733, 734, 735, 736, 737, 738, 739, 740, 741, 742, 743, 744, 745, 746, 747, 748, 749, 750, 751, 752, 753, 754, 755, 756, 757, 758, 759, 760, 761, 762, 763, 764, 765, 766, 767, 768, 769, 770, 771, 772, 773, 774, 775, 776, 777, 778, 779, 780, 781, 782, 783, 784, 785, 786, 787, 788, 789, 790, 791, 792, 793, 794, 795, 796, 797, 798, 799, 800, 801, 802, 803, 804, 805, 806, 807, 808, 809, 810, 811, 812, 813, 814, 815, 816, 817, 818, 819, 820, 821, 822, 823, 824, 825, 826, 827, 828, 829, 830, 831, 832, 833, 834, 835, 836, 837, 838, 839, 840, 841, 842, 843, 844, 845, 846, 847, 848, 849, 850, 851, 852, 853, 854, 855, 856, 857, 858, 859, 860, 861, 862, 863, 864, 865, 866, 867, 868, 869, 870, 871, 872, 873, 874, 875, 876, 877, 878, 879, 880, 881, 882, 883, 884, 885, 886, 887, 888, 889, 890, 891, 892, 893, 894, 895, 896, 897, 898, 899, 900, 901, 902, 903, 904, 905, 906, 907, 908, 909, 910, 911, 912, 913, 914, 915, 916, 917, 918, 919, 920, 921, 922, 923, 924, 925, 926, 927, 928, 929, 930, 931, 932, 933, 934, 935, 936, 937, 938, 939, 940, 941, 942, 943, 944, 945, 946, 947, 948, 949, 950, 951, 952, 953, 954, 955, 956, 957, 958, 959, 960, 961, 962, 963, 964, 965, 966, 967, 968, 969, 970, 971, 972, 973, 974, 975, 976, 977, 978, 979, 980, 981, 982, 983, 984, 985, 986, 987, 988, 989, 990, 991, 992, 993, 994, 995, 996, 997, 998, 999, 1000
- S... Slings (W.), Electrical Engineering, 318; Problems and Solutions in Elementary Electricity and Magnetism, 580
- S... Smellie (Sir William) and his Contemporaries, John Glaister, 149
- S... Smith (C. S.), the Anglo-German Frontier Survey in East Africa, 10
- S... Smith's (Dr. Donaldson) Expedition to Lake Rudolf, 61
- S... Smith (Prof. E. F.), the Atomic Weight and Specific Heat of Tungsten, 424
- S... Smith (G. Elliott), the Cerebral Commissures of the Mammalia, 102
- S... Smith (Dr. John), a Peculiarity in the Mammalian Tooth, 215
- S... Smith (J. C., P. Inst. C. E., Ireland), Death of, 488
- S... Smith (Robert H.), Measurement Conversion Diagrams, 221
- S... Smith (Worthington G.), Spots over Dog's Eyes, 57; Man—the Primeval Savage, Prof. W. Boyd Dawkins, F.R.S., 194
- S... Smithsonian Institution, Report for 1894, 574
- S... Snail Fauna of the Greater Antilles, the, 524
- S... Snake-Poison, Strychnine no Antidote to, Surgeon-Captain R. H. Elliott, 540
- S... Snakes; the Swallowing of one Snake by another, Baron C. R. Osten Sacken, 12; Snake Cannibalism, H. Tsunagi, 321; Baron C. R. Osten Sacken, 343; J. Schonland, 511; Snakes "Playing Possum," L. C. Jones, 107; G. F. Hadow, 127; Death-feigning in Snakes, Gerard W. Butler, 153; the Feigning of Death, R. Harry Vincent, 223; the Suspended Animation of Snakes, S. Garman, 274; W. Kennedy, 274
- S... Sodium and Potassium Derivatives of Nitro-methane, the Explosive Nature of the, A. I. Tutton, 328
- S... Solar Magnetism in Meteorology, Prof. L. H. Bigelow, 350
- S... Soller (Prof. W. J., F.R.S.), the Age of the Earth, 533, 538
- S... Solowetzki Marine Biological Station, 83
- S... Solute, F. G. Donnan, 200
- S... Solway, the Natural History of the, G. Stewardson Brady, 322
- S... Somerville (Prof. W.), the Aubury Lump Disease, 251
- S... Sorauer (Dr. Paul), a Popular Treatise on the Physiology of Plants, 554
- S... Sound; Singing Water Pipes, W. B. Croft, 107
- S... Sound, a Text Book of, F. Catchpool, 244
- S... Southall (H.), Floods in the West Midlands, 215
- S... Species, New Law of Geographical Distribution of, Chas. Dixon, 545
- S... Specific Heats of Gases, the Ratio of, S. H. Burbury, F.R.S., 127
- S... Specific Stability, Variation and, W. I. Threlson-Dyer, F.R.S., 459
- S... Specific Stability, Questions Bearing on, Dr. Francis Galton, F.R.S., 570
- S... Spectrum Analysis; the Spectrum of  $\delta$  Cephei, M. A. Belopolsky, 21; Studies of Bunsen Flame Spectra of Alkali and Alkaline Earth Metals, Eder and Valenta, 20; on Recent Researches in the Infra-Red Spectrum, Prof. S. P. Langley, 12; an Artificial Spectrum Top, C. E. Benham, 113, 200, 321; Prof. G. D. Laying, F.R.S., 107, 200; Captain W. de W. Abney, C.B., F.R.S., 202; J. M. Finnegan, B. Moore, 202; Dr. E. W. F. Bridge-Green, 321; Dr. Dawson Turner, 438; Newton and Co., 463; a Line Spectrum Top and a Complementary one, Dr. C. Herbert Hurst, 510; the Spectrum of Mars, Prof. W. W. Campbell, 432; the Blue Grotto of Capri Spectroscopically Tested, Dr. H. W. Vogel, 300; Stars having Feuliar Spectra, Prof. L. C. Pickering, 302; Method of Rotating Prism, F. L. O. Wadsworth, 325; New Spectrum Photometer, Arthur König, 331; on the Spectra of Argon, William Crookes, F.R.S., 544; H. I. Newall, 454; the Spectra of Argon and of Aurora Borealis, M. Berthelot, 552; Fluorescence Spectrum of Argon, M. Berthelot, 622; Dr. Schumann's Vacuum Spectrograph, 423; Spectroscopic Measures of Planetary Velocities, M. Deslandres, 443; Observations on Sun Spot Spectra, J. Norman Lockyer, F.R.S., 448; Spectrum of the Orion Nebula, 471; Spectrum of Terrestrial Helium (?), Prof. Ramsay, 543; W. Crookes, F.R.S., 543; Terrestrial Helium (?), Prof. Ramsay, 543; W. Crookes, 543; J. Norman Lockyer, C.B., F.R.S., 580; Possible Explanation of Twofold Spectra of Oxygen and Nitrogen, E. C. C. Baly, 550; the Sun's Place in Nature, J. Norman Lockyer, C.B., F.R.S., 374, 396, 505, 500; Ultra Violet Radiation of Solar Corona during Total Eclipse of April 16, 1893, H. Deslandres, 576; the Ultra Violet Spectrum of the Corona, M. Deslandres, 580; the Fluted Spectrum, H. Poincaré, 500
- S... Spelæologie, Société de, Lomdel, 220
- S... Spelæology, the Society of, Mark Stimp, 492

- Spencer (Mr.), Enargite, 621  
 Spencer (Prof. Baldwin), the Horn Expedition to Central Australia, 222; the Presence of a Stridulating Organ in a Spider, 438  
 Spencer (Herbert), Origin of Classes among the "Parasol" Ants, 125  
 Spheres, Method of Turning True, Herr von Liechtenstein, 461  
 Spiders: Development of Lungs of, O. L. Simmons, 37; Malaysian Spiders, Thos. and M. E. Workman, R. I. P. O. C., 99; Indo-Malayan Spiders, B. A. Muirhead, 453; some Suggestions on the Origin and Evolution of Web-Spinning in Spiders, R. I. P. O. C., 417; the Presence of a Stridulating Organ in a Spider, Prof. Baldwin Spencer, 438; American Spiders and their Spinning Work, Dr. Henry C. McCook, Rev. O. P. Cambridge, F.R.S., 595  
 Sponges, American Fresh-Water, in Ireland, Dr. R. Hamitsch, 511  
 Sportsman and Naturalist, Sir Victor Brooke, O. L. Stephen, 76  
 Spots over Dogs' Eyes, Worthington G. Smith, 57  
 Spots, Tan, over Dogs' Eyes, J. Shaw, 33; S. E. Peal, 533; Dr. Alfred R. Wallace, F.R.S., 533  
 Sprague (Isaac), Death of, 538  
 Spring to Fall, from, 8  
 Spring (W.), Conversion of Black Mercury Sulphide into Red Sulphide, 167  
 Spurr (J. E.), the Iron-bearing Rocks of Mesabi Range in Minnesota, 182  
 Stability, Specific, Variation and, W. T. Thielton-Dyer, F.R.S., 459  
 Stability, Questions bearing on Specific, Dr. Francis Galton, F.R.S., 570  
 Sclacites, Volcanic, E. Goldsmith, 128  
 Standard Time in Australia, 510  
 Standards, New Metric, 420  
 Starling in Scotland, the, J. A. Harvie-Brown, 280  
 Stars: the Mean Parallaxes of Stars, Prof. Hugo Gylden, 21; Two Variable Stars, Rev. T. E. Espin, 40; a New Variable Star of the Algol Type, Dr. E. Hartwig, 64; Irregularities in Variable Stars, W. Maxwell Reed, 183; the Variable Star Z Herculis, 610; a New Short Period Variable, Mr. Vendell, 233; Motion and Magnitude, Prof. Oudemans, 160; a New Star, Rev. T. E. Espin, 161; the Radcliffe Catalogue, 183;  $\delta$  Cephei, Dr. Belopolsky, 282; Stars having Peculiar Spectra, Prof. E. C. Pickering, 302; the Milky Way, C. Easton, 327; the System of Algol, M. Tisserand, 328; New Stars and Nebulae, 347; the Story of the Stars, George E. Chambers, 430; Stellar Photography, 510  
 Statics, a Text-book of William Biggs and G. H. Bryan, 76  
 Statics, Mechanics for Colleges and Schools, R. T. Glazebrook, F.R.S., 484  
 Statistical Account of French Forests, M. Daulacé, Prof. W. R. Fisher, 64  
 Statistical Investigation of Evolution, the, J. T. Cunningham, 510  
 Statistical Science, a New Step in, F. Galton, F.R.S., 310  
 Statistics, Dilettantism and, Prof. Karl Pearson, 145  
 Statistics of Sensibility to Pain, Dr. A. McDonald, 209  
 Statistics: Death of H. H. Hayter, 513  
 Steam Engine and other Heat Engines, the, Prof. J. A. Ewing, F.R.S., 210  
 Stebnitskiy (General), Anomaly in Direction of Pendulum Line around Moscow, 326  
 Steinbach's (Dr.), Observations on the Climate of Jalta, Prof. von Danckelmann, 192; Meteorological Researches at Jabut Island, 233  
 Stellar Parallaxes, T. Lewis, 580  
 Stellar Photography, 510  
 Step (Edward), By Vocal Woods and Waters, 102  
 Stephen (O. L.), Sir Victor Brooke, Sportsman and Naturalist, 76  
 Stereochemistry, Handbuch der, Dr. C. A. Bischoff, 409  
 Stern (A. L.), Cellulose Sulphuric Acid, 643  
 Stevenson (Thomas), a Treatise on Hygiene and Public Health, 124  
 Stieljes (Prof.), Death of, 251  
 Stirling (Dr. E. C.), the Aborigines of Australia, 112  
 Stirrup (Mark), the Society of Speleology, 402  
 Stokes (H. N.), New Compounds of Phosphorus, Nitrogen and Chlorine, 592  
 Stokes, Freezing and How to Distinguish them, H. A. Miles, 545  
 Stoney (Dr. J.), F.R.S., Local Heliosat and Improved Solar-ostat, 500  
 Storm, the Recent, in the United States, Dr. Wm. H. Hall, 417  
 Storm Statistics at Bidston, William F. Plummer, 272  
 Stracanti (Prof. L.), Determinations of Absorption of Solar Radiation by Fog and Cirrus Cloud, 180  
 Strasburger (Dr. E.), Lehrbuch der Botanik, Drs. F. Neff, H. Schenck, and A. L. W. Schimper, 330  
 Strassburg, Nicolaiew, and Birmingham, on a Remarkable Earthquake Disturbance observed at, on June 3, 1893, C. Davison, Dr. E. von Rebeur Paschwitz, 208  
 Streinz (Franz), Thermochemical Process in Secondary Coils, 169  
 Stridulating Organ in a Spider, the Presence of a, Prof. Baldwin Spencer, 438  
 Stromeyer (C. E.), Abnormal Atlantic Waves, 437  
 Struve (Herr), Compound of Grape Sugar with Acid Radicle of Hydrazine, 395  
 Strychnine, no Antidote to Snake-Poison, Surgeon-Captain R. H. Elliott, 540  
 Stuart (Donald, M.D.), Coal-Dust an Explosive Agent, as shown by an Examination of the Camerton Explosion, 268  
 Strahlenberg (Prof.), the Post-Pliocene Mammals of East Russia, 357  
 Studart (Dr. C.), Death of, 251  
 Study (Prof. L.), the Connection between Binary Quartics and Elliptic Functions, 46  
 Subterranean Exploration: Société de Spéléologie, founded, 220  
 Sadimouch, Reise nach, Emil Schmidt, 161  
 Sulphur Fumigation, as Remedy for Marsh Fevers, M. d'Alban, 480  
 Sunata, Mountain System, Dislocation by Earthquakes of May 17, 1892, of, J. J. A. Muller, 468  
 Sun, Partial Eclipse of the, March 26, 493  
 Sun's Place in Nature, the, J. Norman Lockyer, C.B., F.R.S., 374, 390, 595, 596  
 Sun's Radiant, Agnes Gibberne, 174  
 Sun Spots: Eleven-year Sun Spot Weather Period and its Multiples, H. Helm Clayton, 430; Observations on Sun-Spot Spectra, J. Norman Lockyer, F.R.S., 448  
 Sunshine, Rain-Making and, John Collinson, 7  
 Surgery: Death and Obituary Notice of John Whitaker Hulke, F.R.S., 302  
 Sarimanu Water Toads, the, 230  
 Saring (Dr.), Observations on Temperature Humidity near Snow Surface, 623  
 Surveying, the Gradient Telemeter Level, 112  
 Surveying by Aid of Photography, Instrument for, J. B. Lee, 101  
 Surveying: Recent Exact Levelling Operations in Russia, General Vemkoff, 359  
 Suspended Animation of Snakes, the, S. Garman, 274; 375; Kennedy, 274  
 Swainson (F. E.), New Ossiferous Fissure in Creswell Crags, 527  
 Swallow Holes, Caves and, E. A. Martel, Canon T. G. Bonney, F.R.S., 410  
 Sweat, Effect of Temperature on Secretion of, Dr. Levy-Dorn, 102  
 Swift (Edward), a New Comet, 114; Ephemeris for Swift's Comet, 160; Comet of 1894, Swift, 542  
 Swift (Messrs.), New Microtome, 101  
 Swinburne (J.), Electromagnetic Theory, Oliver Heaviside, F.R.S., 471  
 Symons's Monthly Meteorological Magazine, 23; 525  
 Symons (G. J.), Early English Meteorological Literature, 38; Enormous Hailstones, 24; Climatological Table of British Empire for 1893, 24  
 Syonathy (J.), Prehistoric Ceramics from Langenlekan Fenlands, 157  
 T. (Prof.), the South Indian Earthquake of November 16, 1894, 340  
 Tait (Prof.), the Constitution of Volatile Liquids, 215; Isothermals of Ethylene, 215; on the Age of the Earth, 229  
 Tamm (C.), Acetic Ethers from Sugars, 350  
 Tan Spots over Dogs' Eyes, J. Shaw, 33; S. E. Peal, 533; Dr. Alfred Wallace, F.R.S., 533

- T. Sley, A. G., Variations in the Bilateral Symmetry of *Potentilla fruticulosa*, 350
- Larva of Lakeland, the, J. E. Marr, F.R.S., 100
- Largest Drop, Ammonium Thiocyanate a Substitute for Sulphurated Hydrogen, 373
- Laylor, E. B., Nagana and the Great Lakes, 610
- Layton, Bright Meteor at, 587
- Lebel, Oct. Tahiti, Death of, 182
- Leclercq, E. L., (a) Fifth Report of German Imperial Physico-Technical Institute, 201; the New Technical Educator, vol. vi., 531; Major-General Sir John Dannelly, on Technical Education, 116; Science Teaching, H. G. Wells, 182; the Advance of Technical Education, R. A. Gregory, 370
- Leclercq, la Pratique du, Jules Gagnon, Walter M. Gaudner, 6-4
- Telegraphy: Distance Telegraphy, without Wires, Dr. Rubens, 103; the Development of Telegraphy in England, 324; the Telegraphist's Guide, James B.H., 484; Death of J. H. Greener, 501; W. H. Freese, F.R.S., Method of Telegraphy by Induction, 587
- Telephone Communication, and, between Vienna and Berlin, 120
- Telephony, the Early History of, Prof. D. E. Hughes, F.R.S., 521
- Telescope, a New Form of Zenith, M. Louis Labay, 504
- Tellerberg (Dr. F. de), Focussing at Marren (Correction of Sir John Lubbock), p. 91, 182
- Temperature Variations of Rivers of Central Europe, Dr. A. L. Foster, 83
- Temperatures, Oceanic, at Different Depths, Capt. W. J. L. Wharton, F.R.S., 342
- Ternochlozing in Orient, 77
- Terrstral Helium (a), 512; Prof. Ramsay, 513; W. Crookes, F.R.S., 513; J. Norman Lockyer, C.B., F.R.S., 586
- Terrestrial Magnetic Discoveries pertaining to England, some Early, Will Whiston, L. A. Bauer, 205
- Terrestrial Magnetism, Wilde's Theory of the Secular Variation of, L. A. Bauer, 103
- Terrestrial, a Bad Method in, Dr. F. Ray Lankester, F.R.S., 289
- Terrestrial, of Fresco, on Winds and on Weather Signs, translated by Jas. G. Wood, 25
- Therapeutics, the Anti-Toxin Treatment of Diphtheria in France, 53; Statistics of Results of Behring and Roux's Treatment of Diphtheria, 321; Advantage of High Level Residence for Tuberculous Patients, Dr. A. C. Miller, 370; Sulfur Emulsion as Remedy for Marsh-Fever, M. C. Allen, 489; Therapeutic Action of Currents of High Frequency, Apostoli and Berlitz, 528; Intense Cold as a Therapeutic Application, Dr. F. G. 588
- Thermodynamics, the Kinetic Theory of Gases, G. H. Bryan, 361, 362, 176, 310; Edward P. Chilverwell, 78, 58; Dr. J. Thomson, F.R.S., 152; S. H. Bradley, F.R.S., 175; Prof. G. L. FitzGerald, F.R.S., 221; Rev. H. W. Watson, F.R.S., 222; Prof. A. S. Hunter, F.R.S., 203; Prof. Boltzmann, 581; Fundamental Chemistry from the Standpoint of Avogadro's Law and Thermodynamics, Prof. Walter Nernst, M. P., Dublin, 530
- Thermometer, the First Mercury, used by Ismael Boullier, A. S. Meyer, 579
- Thermodynamic, some Veridicals, Prof. S. Carman, 343
- Thielton Dyer (W. L.), F.R.S., Dr. Watt's Dictionary of the Technical Products of India, 150; the New Cypress of Naxos, 175; Variation and Some Stability, 459
- Thomson, G., the Constitution of the Electric Arc, 47
- Thomson, A., Combinations of Nitric Oxide and Iron Chloride, 355
- Thomson, Prof. S. P., Muriatic Magnetism, 142
- Thomson, Prof. T. L., Electric Discharges through Gases, 330; Methods of Determining Conductivities of Gases, 331; Science, 331
- Thomson, Dr. Murray, Death of, 245
- Thomson, Dr. T. L., F.R.S., on the Explosion of a Mixture of Nitrogen and Oxygen, 100
- Thomson, Dr. T. L., F.R.S., M. B. Gordon, 491
- Thomson, Dr. T. L., Strength of Cornelia, Dr. H. Boyce, 342
- Thomson, Dr. T. L., Planting of, A. S. Meyer, 33
- Thomson, Dr. T. L., Australia, 516
- Thomson, Dr. T. L., System of M. P., 328; the Amal-Salt B (Wood's Process), 376; on the Part of, 254
- Tissot (J.), Relative Signification of Disengagement of Carbonic Acid and Absorption of Oxygen by Muscles, 503
- Tobacco-Pipes, Cleaning, Cecil Carus-Wilson, 511
- Todd, Sir C., F.R.S., Meteorological Work in Australia, 309
- Tokio, Earthquake of June 24, 1893, the, 503
- Tokio, the Seismological Observatory Destroyed at, 585; Prof. J. W. Judd, F.R.S., 533
- Toll's (Baron) Siberian Expedition, 327
- Tooth, a Peculiarity in the Mammalian, Dr. John Smith, 215
- Top, an Artificial Spectrum, C. E. Benham, 113, 200, 321; Prof. G. D. Liveing, F.R.S., 107, 200; Capt. W. de W. Abney, F.R.S., 202; J. M. F. B. Moore, 202; Dr. F. W. Edridge Green, 321; Dr. Dawson Turner, 438; Newton and Cav., 403
- Top, a True Spectrum, and a Complementary one, Dr. C. Herbert Hurst, 510
- Topography, American, Prof. Henry Gannett, A. Fowler, 274
- Tornado in Oregon, 10
- Toronto Magnetic Observatory, 337
- Total Eclipse, by Order of the Sun to Chile to see his, April 16, 1893; J. J. Aubertin, 101
- Towns, the Water-Supply of, W. K. Burton, 140
- Toxicology, the Peyotl Cactus Alkaloid, Prof. J. Lewin, 288; Strychnine no Antidote to Snake-Poison, Surg.-Captain R. H. Elliott, 500
- Transit of Mercury, 40; Observations of the, 85, 253
- Trawling Question, the, Prof. McIntosh, 115
- Trees, Contraction of, caused by Cold, J. Clayton, 402
- Trees, the New Cypress of Naxos, 185
- Trees, Text Book of the Diseases of, Prof. R. Hartig, Prof. W. R. Fisher, 28
- Trees, the Planting of Timber, Alfred W. Bennett, 33
- Trematodes of Japan, Studies on the Lepo-parasitic, Seitaro Goto, 244
- Tretakow (M.), Polyembryony, 540
- Trevor-Battye (A.), Return of, 19; Visit to Kolguef Island, 30
- Trinucleus, C. F. Beecher, 610
- Trusdal (H.), Snake Cannibalism, 321
- Tuberculosis, Germs possessed of Locomotive Power, D. Mac-Gillivray, 623
- Tuberculous Patients, Advantage of High-Level Residence for, Dr. A. C. Miller, 370
- Take (Dr. D. H.), Death of, 440
- Tambling Cat, M. Marey's Photographs of a, 80
- Tanas, the Metric System in, 324
- Tanner, Dr. Dawson, the Spectrum Top, 438
- Turner (H.), Death of, 513
- Turner (J. H., Tadbury), the Principles of Waterworks Engineering, A. W. Brightmore, 140
- Turner (Sir W.), Dubois's Pithecanthropoid Remains in Java, 610
- Uranic Disease, the Anbury, Prof. N. Somerville, 251
- Ursian Indians, the "New Fire" Ceremony among the, J. W. Lewkes, 515
- Upton (A. F.), the Properties of Liquid Ethane and Propane, 63; Prof. Victor Meyer's New Method of Determining High Melting-Points, 161; a New Element in the Nitrogen Group, 258; the Explosive Nature of the Sodium and Potassium Derivatives of Nitromethane, 328; an Instrument for Cutting Section-Plates and Prisms of Crystals, 452; New Compounds of Hydrazine with Fatty Acids, 516; Isolation of Free Hydrazine, N. H. M. Lobry de Bruyn, 544; an Improved Method for the Microscopic Investigation of Crystals, 608
- Uyphoni, Oysters and, 301; Mrs. Percy Frankland, 415
- Uyphoni of China Seas, 1893, the, 130
- Uranin (Dr. W. von), Polarisation by Oblique Radiation, 623
- Ultra Violet Spectrum of the Corona, the, M. Deslandres, 580
- Union of Civil and Astronomical Days, the, 282
- United States: the Absorption of the Indian Reservations, 19; Report of United States Weather Bureau for 1893, 30; Biology in the, a Prospect, St.; Fox Tail Grass-Pest in the United States, 301; the Recent Storm in the, Dr. Wm. H. Hale, 417; American Spiders and their Spinning Work, a Natural History of the Orb-Weaving Spiders of the United States, with special regard to their Industry and Habits, Dr. Henry C. McCook, Rev. O. P. Cambridge, F.R.S., 595; United States Units of Electrical Measure, the, 518
- University College, the New Physical Laboratories of, 298
- University Intelligence, 23, 45, 70, 92, 141, 261, 287, 308, 333, 350, 382, 400, 451, 477, 499, 525, 572, 598, 610
- University of London, a True, M. Crackenthorpe, 161



University for London, the Teaching, Dr. W. Palmer Wynne, 297  
 Unwin (Prof. William Cawthorne, F.R.S.), on the Development and Transmission of Power, 124; the Determination of the Dryness of Steam, 377  
 Upham (Warren), Late Glacial or Champlain Subsidence and Relevation of St. Lawrence River Basin, 333  
 Upsala Meeting of the International Meteorological Committee, the, 185  
 Upton (Prof. W.), Cyclonic Precipitation in New England, 142

Vaccination Question, the, Arthur Wollaston Hutton, 149  
 Valency? What does the Chemist Mean by, 409  
 Valenta (E.), Studies of Bunsen Flame Spectra of Alkali and Alkaline Earth Metals, 20  
 Varet (Raoul), Researches on Mercuric Sulphates, 24; Researches on Mercurial Nitrates, 72; Isomeric States of Oxides of Mercury, 528  
 Variable Spots, Lunar River Beds and, Prof. W. H. Pickering, 580  
 Variable Stars: Two Variable Stars, Rev. T. E. Espin, 49; a New Variable Star of the Algol Type, Dr. E. Hartwig, 64; Irregularities in Variable Stars, W. Maxwell Reed, 183; a New Short Period Variable, Mr. Vendell, 233;  $\delta$  Cephei, Dr. Belopolsky, 282; the System of Algol, M. Tisserand, 328; the Variable Star Z Herculis, 616  
 Variation in Animals and Plants, Prof. W. E. R. Weldon, F.R.S., 449  
 Variation, Experimental Inquiry into Causes of, H. M. Vernon, 454  
 Variation of Latitude, the, 373  
 Variation and Specific Stability, W. J. Threlton-Dyer, F.R.S., 459  
 Variation of Terrestrial Magnetism, Wille's Theory of the Secular, L. A. Bauer, 103  
 Varieties of the Human Species, the, Prof. Giuseppe Sergi, 595  
 Vasechy (M.), Electrostatic Capacity of Line Traversed by Current, 240  
 Vatican Observatory, the, 282  
 Vaudin (L.), Calcium Phosphate of Milk, 600  
 Veeder (Dr. M. A.), Twelve-Year Intervals in Rise and Fall of Temperature, 513  
 Veley (W. H.), Action of Hydrogen Chloride on Quicklime, Magnesia, and Baryta, 311  
 Velocity of the Argentine Earthquake Pulsations of October 27, 1894, the, C. Davison, 402  
 Venukoff (General), Recent Exact Levelling Operations in Russia, 359  
 Venus, the Rotation of, M. Flammarion, 21  
 Vermin, Helpful and Harmful Farm, 174  
 Vernon (H. M.), Effect of Environment on Development of Echinoderm Larvæ, 454  
 Verschaffel (Dr.), Vapour Tension and Hygrometric States, 167  
 Vertebrate Segmentation, P. Chalmers Mitchell, 367  
 Vertebrates, Thirst-Endurance in some, Prof. S. Garnan, 343  
 Vertebrates, Amphioxus and the Ancestry of the, Arthur Willey, 433  
 Verworn (Prof. Max), Modern Physiology, 58; Allgemeine Physiologie, Dr. M. Foster, F.R.S., 520  
 Vibrations, the Observation of Earth-Waves and, Prof. John Milne, F.R.S., 548  
 Vicentini's (Prof.) New Seismometograph, 540  
 Vienna, Earthquake at, 110  
 Vienna and Berlin, Telephone Communication opened between, 129  
 Vigouroux (M.), Preparation of Amorphous Silicon, 312; on the Properties of Amorphous Silicon, 432  
 Villemonté (G. G. de), Electric Potentials in Liquid Conductor in Uniform Movement, 240  
 Villiers (A.), Qualitative Separation of Nickel and Cobalt, 288  
 Vincent (H.), the Disinfection of Focal Matter by Copper Sulphate, 168  
 Vincent (R. Harry), the Feigning of Death in Snakes, 223  
 Vicentini (G.), the Transmission of Electricity through Gases, 514  
 Vine, Fertilising Materials required by, A. Muntz, 480  
 Violle (L.), Temperature of Electric Arc, 168  
 Viticulture, Fertilising Materials required by Vine, A. Muntz, 480  
 Vocal Woods and Waters, by, Edward Step, 102  
 Vogel (Prof. H. W.), Effects of Monochromatic Light on Series

of Pigments, 191; the Blue Grotto of Capri Spectroscopically Tested, 309; Experiments on Colour Sensation, 469  
 Volcanic Rocks, Induced Magnetism in, G. Folgerator, 617  
 Volcanic Stalactites, E. Goldsmith, 128  
 Volcanoes: Study of Ejected Blocks from Mount Somma, Prof. Johnston-Lavis and Dr. J. W. Gregory, 251  
 Volkmann (P.), Measurement of Surface Tension of Water in Capillary Tubes, 160  
 Voltmeter, New Gas, Mr. Naber, 500  
 Vuillemin (Paul), Microsporon, 593  
 Waals (M. van der), Condition for Equilibrium between Co-existent Phases, 504  
 Wadsworth (F. L. O.), New Interrupter for Large Induction Coils, 109; Method of Rotating Prism in Spectrum Analysis, 325  
 Wagner (Woldemar), L'Industrie des Arancina, 393  
 Waleott (C. D.), Appalachian Blocks of Folding, 525  
 Waldeyer (Prof.), Formative Structures of Nervous System, 312  
 Wales, Agricultural Field Experiments in, 614  
 Walton (E. A.), Lias Ironstone round Ranthony, 358  
 Walker (J.), Electrolysis of Potassium Allo-ethyllic Camphorate, 621  
 Walker (Louisa), Varied Occupations in Weaving, 435  
 Walker (Miles), Mirrors of Magnetism, 142  
 Wallace (Dr. Alfred R., F.R.S.), Reason of Failure of Bateson's and Galton's Theories of Organic Evolution, 459; Tan Spots over Dogs' Eyes, 533; the Age of the Lurch, 607  
 Walther (Prof. Johannes), Die Lebensweise der Meeresthiere, 269; Lithogenesis der Gegenwart, 313  
 Wable Fly, the, W. E. Kirby, 154  
 Warburg (E.), Conduction and Convection in Feebly Conducting Dilute Solutions, 619  
 Ward (R. de C.), Recent Russian Studies of Thunderstorms, 451  
 Warrington (Prof. R., F.R.S.), Agricultural Art and Science, 372  
 Warth (Dr. H.), the Quarrying of Granite in India, 272  
 Washington (H. S.), Aventurine Glass, 112  
 Watchmaking: Manufacture of Standard Screws for Machine-made Watches, C. J. Hewitt, 22  
 Water: Redetermination of Temperature of Greatest Density of, M. de Coppet, 37; the Electric Conductivity of Pure, J. W. Koolger, 42; Determination in Electrical Units of Specific Heat of Water, Prof. A. Schuster, F.R.S., and W. Gannon, 214; Latent Heat of Evaporation of Water, E. H. Gruthis, 331  
 Water-Filters, Relative Efficiency of, Surgeon Major Johnston, 38  
 Water-Types, Singing, W. B. Croft, 107  
 Water-Works Engineering, the Principles of, J. H. Tudsbury Turner and A. W. Brightmore, 146; the Water Supply of Towns, W. K. Burton, 146  
 Watson (Rev. H. W., F.R.S.), Boltzmann's Minimum Theorem, 105; the Kinetic Theory of Gases, 222  
 Watt (Dr. George), a Dictionary of the Economic Products of India, 4; W. T. Threlton-Dyer, F.R.S., 150; Dr. A. Ball, F.R.S., 150  
 Watt (James) and Ocean Navigation, Dr. Francis Flgar, 475  
 Watts' Dictionary of Chemistry, M. M. Pattison Muir and H. Foster Moyley, 27  
 Waves, Abnormal Atlantic, C. E. Stromeyer, 437  
 Weather: Eleven-Year Sun-Spot Weather Period and its Multiples, H. Helm Clayton, 436  
 Weather Forecasts, the Possibilities of Long Range, Prof. Cleveland Abbe, 212  
 Weather-wise Companion, My, 602  
 Weaving, the Mechanism of, T. W. Fox, 149  
 Weaving, Varied Occupations in, Louisa Walker, 435  
 Web Spinning in Spiders, some Suggestions on the Organ and Evolution of, R. I. Poolek, 417  
 Wedd (H. J.), Advanced Agriculture, 218  
 Weber (Max), Electro-magnet Pull, 320  
 Weights and Measures, English, H. J. Chaney, 422  
 Wenschek (Dr.), Origin of Alpine Serpentes, Gneiss, and Granite, 320  
 Wentland (Dr.), Formation of Uric Acid in Man, 623  
 Welby (Frances A.), Neo-Vitalism, 43  
 Weldon (Prof. W. E. R., F.R.S.), Variation in Animals and Plants, 449  
 Well Water, the Variations in Level of, A. Riccio, S. Arcidiacono, Prof. L. H. King, 62

- Weller (Stuart), Fossil Faunas at Springfield, Missouri, 525  
 Wells (H. G.), Science Teaching in Schools, 100; Science Teaching, 182; Apparitions and Thought Transference, Frank Postmore, 121; Physiology for Beginners, Prof. M. Foster, F.R.S., and Lewis E. Shore, 195; Outlines of Biology, F. Chalmers Mitchell, 195; Practical Methods in Microscopy, C. H. Clark, 195; Peculiarities of Psychical Research, 274  
 Welt (Jdo), Active Amylaseic Acid, 95  
 Wetherell (J. B.), the Formation of Oolite, 357  
 Wetterhan (David), Das Verhältniss der Philosophie zu der Empirischen Wissenschaft von der Natur, 220; Philosophy and Natural Science, 295  
 Weyle (Dr. P. H. van der), Death of, 538  
 Wharton (Captain W. J. L., F.R.S.), Organic Temperatures at Different Depths, 342  
 Whiston (Will), some Early Terrestrial Magnetic Discoveries pertaining to England, L. A. Bauer, 295  
 Whitby, Memorials of Obl. Rev. J. C. Atkinson, 149  
 White Rainbow, a. Rev. Samuel Barber, 274  
 White (Dr. F. B.), Death and Obituary Notice of, 345  
 White (J.), Corrections of Maximum and Ex Meridian Altitudes, 485  
 White (Sir William), Bilge Keels and Steadiness in First-Class Battle-Ships, 568  
 Whiteley (Mr. A.), Melting-Points of Mixtures, 454  
 Whiteley (R. Lloyd), Organic Chemistry, the Fatty Compounds, 557  
 Whitwell (C. T.), Planetary Photography, 511  
 Wiedemann's Annalen, 70, 100, 334, 357, 400, 610  
 Wien (Dr. W.), the Testing of Platinum Pyrometers, 623  
 Wiggins (Captain) wrecked, 83  
 Wijhe (M. van), the Cranial Nerves of Vertebrates in Amphioxus, 120  
 Wilde's Theory of the Secular Variation of Terrestrial Magnetism, L. A. Bauer, 193  
 Wiley (H. W.), Cassava as Food, 515  
 Wilkinson (Mr.), the New Iodine Bases, 349  
 Williamson (W. F.), Geology of Anatolia, 358  
 Willem (Victor), Origin of Diastole and Undulations of Systolic Plateau of Arterial Pulsation, 46  
 Willey (Arthur), Amphioxus and the Ancestry of the Vertebrates, 433  
 Williamson (Dr. W. C., F.R.S.), Fossil Plants of Coal Measures, n., the Roots of Calamities, 94  
 Wilang (Dr.), the Parallax of Nebula  $\delta$  2241, 114  
 Wind (C. H.), Kerr's Magneto-Optic Phenomenon, 48, 62, 168  
 Wind and Birds' Flight, the, Profs. Langley and Curtis, 150  
 Wind-Measurement Experiments at Eiffel Tower, Koechlin's, Max de Nansouty, 181  
 Winds and on Weather Signs, Theophrastus of Eresus, on, translated by Jas. G. Wood, 25  
 Winkler (Prof.), the Atomic Weights of Nickel and Cobalt, 281  
 Wislizenus (Walter F.), Astronomische Chronologie, 509  
 Witherby (Harry L.), Forest Birds, their Haunts and Habits, 341  
 Wolf (Prof. M.), Encke's Comet, 64  
 Wolf (Dr.), the Commercial Extraction of Pure Dextrose from Syrupy Mixtures, 395  
 Wolfenstein (Dr.), Isolation of Anhydrous Hydrogen Peroxide, 182  
 Womack (Mr.), a Modification of Ballistic Galvanometer Method of Determining Electromagnetic Capacity of Condensers, 142  
 Woman's Share in Primitive Culture, O. T. Mason, 244  
 Wood in Shipbuilding, Wanted a Substitute for, 490  
 Wood (Jas. G.), Theophrastus of Eresus, on Winds and on Weather Signs, translated by, 25  
 Wood (W. H.), the Aurora of November 23, 1804, 390  
 Woodhead (D. G. Sims), the Antitoxic Serum Treatment of Diphtheria, 402, 425  
 Woods (J. D.), the Province of South Australia, 221  
 Workman (Thos. and M. E.), Malaysian Spiders, R. I. Pocock, 99  
 Worthington (Prof. A. M., F.R.S.), Gravitation, 79  
 Wright (G. F.), Glacial Phenomena of Newfoundland, Labrador, and South Greenland, 430  
 Wrightson (T.), Identity of Phenomena of Welding in Iron with Regelation in Ice, 453  
 Wullner (A.), Lehrbuch der Experimentalphysik, 387  
 Wundt (Wilhelm), Lectures on Human and Animal Psychology, 173  
 Wyatt (Claude W.), British Birds, 318  
 Wynne (Dr. W. Palmer), the Teaching University for London, 297  
 Yellow Fever, the Transmission of, Dr. Abern, 300  
 Yendell (Mr.), a New Short Period Variable, 233  
 Yule (G. C.), Passage of Oscillator Wave-Train through Plate of Conducting Dielectric, 310; a Simple Form of Harmonic Analysis, 501  
 Zenith Telescope, a New Form of, Louis Fabry, 504  
 Zmamsky (F.), Elastic Behaviour of Zinc at Different Temperatures, 357  
 Zirkel (Dr. Ferdinand), Lehrbuch der Petrographie, 200  
 Ziwet (Alexander), an Elementary Treatise on Theoretical Mechanics, 101, 533  
 Zoheal Light, the, Rear-Admiral J. P. Maclean, 391  
 Zoology: Additions to the Zoological Gardens, 21, 30, 64, 85, 114, 132, 160, 183, 207, 233, 253, 301, 327, 347, 373, 395, 424, 443, 471, 493, 516, 542, 564, 589, 610; Zoological Society, 94, 110, 191, 311, 497, 479, 502, 550, 575; Death of Dr. Kretschmar, 18; the Horse, Prof. N. S. Shaler, 44; the Visceral Anatomy of Ornithorhynchus, F. E. Beddard, F.R.S., 191; the Zoological Record, S. Pace, 223; the Sumnam Water-Toad, 230; a Handbook to the Primates, H. O. Forbes, 242; Platypus Embryo from Intrauterine Egg, J. P. Hill and C. J. Martin, 264; Life at the Zoo, C. J. Cornish, 270; Fouammifera from the Arabian Sea, F. Chapman, 311; Breeding Habits of Brazilian Tree-Frogs, Dr. E. A. Coddli, 497; the Fauna of the Lower Cambrian, Prof. W. K. Brooks, 423; the Arctic Hare in Ireland, 614  
 Zuntz (Prof.), Measurement of Blood in Circulation and Work done by Heart, 216; Effect of Load on Metabolism and Body-Functions of Soldiers on the March, 593

# NATURE:

## FIFTY-FIRST VOLUME.

### L'ENVOI.

THE completion of a period of twenty-five years, and the publication of fifty volumes since NATURE was established, mark an epoch in its history. The Editor is anxious to take advantage of it to tender his best thanks to those who have, from the commencement of the Journal to the present time, not only contributed to its pages, but have so freely permitted him to appeal to them for advice and assistance.

He feels strongly that it is only owing to their aid and their careful pilotage that NATURE has so far escaped that shipwreck which has been the lot of somewhat similar ventures, not only in this country, but in Europe and America.

It would have been appropriate, if it had been possible, to have included in this, the first number of the fifty-first volume, a retrospect of the scientific progress achieved during the last quarter of a century. It was, however, plainly impracticable in such a limited space to give a just idea of the various triumphs which have been accomplished along the many lines of scientific thought and work.

But no elaborate retrospect is needed to prove that since 1869 our scientific progress has been at a rate which has never been surpassed in the world's history. Men and ideas have increased ten-fold; instruments and applications have increased a hundred-fold. The battle of scientific education has been fought and won, and the general interest in matters scientific is greatly increasing. Not only are these things so, but there is every indication that when L'Exvoit to the hundred and first volume comes to be written—by some other hand—a still more rapid progress will have to be indicated.

That the same distinguished man of science who wrote the first article in NATURE in 1869 has been good enough to start the fifty-first volume, will doubtless be as great a source of pleasure to the readers of NATURE as it is a source of pride to

THE EDITOR.

*During the last twenty-five years the following have been among the Contributors to NATURE:—*

- |  |  |                                |
|--|--|--------------------------------|
| Abbe, Prof. Cleveland (Washington).      | Aitken, I., F.R.S.                     | Baker, Sir Benjamin, F.R.S.    |
| Abel, Sir F. A., K.C.B., F.R.S.          | d'Albe, E. E. Pournier.                | Baker, Sir Samuel W., F.R.S.   |
| Abercromby, Hon. Ralph.                  | Allen, Grant.                          | Baker, J. G., F.R.S.           |
| Abney, Captain W. de W., C.B., F.R.S.    | Alliman, Prof. George James, F.R.S.    | Balfour, Prof. Francis, F.R.S. |
| Acland, Right Hon. A. H. D., M.P.        | Alliman, Prof. George Johnston, F.R.S. | Balfour, Henry.                |
| Acland, Sir H. W. D., K.C.B., F.R.S.     | Allardice, Prof. R. E.                 | Balfour, Prof. I. B., F.R.S.   |
| Adami, Dr. J. G.                         | Andrewes, Dr.                          | Ball, John, F.R.S.             |
| Adams, Prof. J. C., F.R.S.               | Archibald, L. D.                       | Ball, Sir R. S., F.R.S.        |
| Adams, Prof. W. G., F.R.S.               | Argyll, Duke of, K.G., F.R.S.          | Ball, Dr. V., F.R.S.           |
| Adamson, Prof. R.                        | Armstrong, Lord, F.R.S.                | Bamber, E. I.                  |
| Agassiz, Prof. Alexander (Camb., Mass.). | Armstrong, Prof. H. L., F.R.S.         | Barlow, W. H., F.R.S.          |
| Airy, Sir G. B., F.R.S.                  | Ayrton, Prof. W. E., F.R.S.            | Barrett, Prof. W. F., F.R.S.   |

- Barus, Dr. Carl.  
 Bashforth, Rev. F.  
 Basset, A. B., F.R.S.  
 Bastian, Dr. H. C., F.R.S.  
 Bate, C. Spence, F.R.S.  
 Bates, H. W., F.R.S.  
 Bather, J. A.  
 Bauerman, Hilary.  
 Beale, Dr. Lionel S., F.R.S.  
 Beard, Dr. J.  
 Beddard, F. E., F.R.S.  
 Beddce, Dr. J., F.R.S.  
 Bedford, Dr. J.  
 Bedson, Prof. Phillips.  
 Beer, Dr. Berthold.  
 Bell, Sir I. Lowthian, F.R.S.  
 Bennett, A. W.  
 Bentham, George, F.R.S.  
 Berkeley, Rev. M. J., F.R.S.  
 Bettany, G. T.  
 Bevan, E. J.  
 Bickerton, Dr. T. H.  
 Bidwell, Shelford, F.R.S.  
 Black, William  
 Blake, Prof. J. F.  
 Blanford, H. F., F.R.S.  
 Blanford, Dr. W. T., F.R.S.  
 Bloxam, G. W.  
 Blyth, Dr. E.  
 Bonney, Prof. T. G., F.R.S.  
 Bondage, Dr. E. (Paris).  
 Bottomley, Dr. J. T., F.R.S.  
 Boulenger, G. A.  
 Bourne, Dr. G. C.  
 Bowditch, Dr. H. P.  
 Bower, Prof. F. O., F.R.S.  
 Boyce, Prof. R.  
 Boys, Prof. C. V., F.R.S.  
 Braithwaite, Dr. R.  
 Branwell, Lord, F.R.S.  
 Bramwell, Sir F. J., F.R.S.  
 Brandis, Sir D., K.C.I.E., F.R.S.  
 Branton, Dr. D. G.  
 Britten, J. M. S.  
 Brock, Dr. H.  
 Brough, B. H.  
 Brown, H. T., F.R.S.  
 Brown, Prof. A. Crum, F.R.S.  
 Browne, Sir J. Crichton, F.R.S.  
 Bruce, Dr. J. Mitchell.  
 Brunton, Dr. T. Lauder, F.R.S.  
 Bryan, G. H.  
 Bryant, K.  
 Buchan, Dr. Alexander.  
 Buchanan, J. Y., F.R.S.  
 Budge, Dr.  
 Bulman, G. W.  
 Burnside, Prof., F.R.S.  
 Bask, George, F.R.S.  
 Butler, G. W.  
 Calderwood, W. L.  
 Capron, J. Rind.  
 Carpenter, Dr. P. H., F.R.S.  
 Carpenter, Dr. W. B., F.R.S.  
 Carruthers, W., F.R.S.  
 Carrus-Wilson, C.  
 Carus-Wilson, Prof. (Montreal).  
 Cayley, Prof. A., F.R.S.  
 Chapman, G. C.  
 Chaney, H. J.  
 Chi-holm, H. W.  
 Christie, W. H. M., F.R.S.  
 Chyral, Prof.  
 Churn, Prof. A. H., F.R.S.  
 Clarke, C. B., F.R.S.  
 Clarke, M. A. M.  
 Clinton, Prof. W. H., F.R.S.  
 Claxson, F. W.  
 Coates, F. J. D. A.  
 Cockle, Sir I., F.R.S.  
 Collins, F. Howard.  
 Cole, Prof. G. A. J.  
 Colomb, Vice-Admiral.  
 Common, Dr. A. A., F.R.S.  
 Cooke, Dr. M. C.  
 Cope, Prof. L. D. (Phila.)  
 Copeland, Dr. Ralph.  
 Core, Prof. T. H.  
 Corfield, Prof.  
 Cornish, Vaughan.  
 Courtenay, W. L.  
 Creak, Captain, R.N., F.R.S.  
 Croll, Dr. I., F.R.S.  
 Crookes, W., F.R.S.  
 Cross, C. J.  
 Cunningham, J. T.  
 Cunningham, Lieut.-Colonel A.  
 D'Abbadie, A.  
 Dallinger, Rev. Dr., F.R.S.  
 Dana, Prof. J. D. (Newhaven, Conn.).  
 Darwin, Charles, F.R.S.  
 Darwin, Francis, F.R.S.  
 Darwin, Prof. G. H., F.R.S.  
 Davison, Charles.  
 Dawkins, Prof. W. Boyd, F.R.S.  
 Dawson, Principal Sir J. W., F.R.S. (Montreal).  
 Day, Dr. F.  
 De Chaumont, Dr.  
 De Fonvielle, W. (Paris).  
 De La Rue, Warren, F.R.S.  
 Denning, W. F.  
 De Rance, C. E.  
 Dewar, Prof. J., F.R.S.  
 Dickins, F. V.  
 Distant, W. L.  
 Dittmar, Prof., F.R.S.  
 Dixon, Prof. H. B., F.R.S.  
 Dodgson, Rev. C. L.  
 Dohm, Dr. A. (Naples).  
 Donnelly, General Sir J. K., C.B.  
 Douglass, Sir J. N., F.R.S.  
 Dreyer, Dr. J. L. E.  
 Du Bois-Reymond, Prof. (Berlin).  
 Duncan, Dr. P. M., F.R.S.  
 Danell, J. R.  
 Dunkin, E., F.R.S.  
 Dunstan, Prof. W. R.  
 Dapre, Dr. A., F.R.S.  
 Dyer, W. T. Thiselton, C.M.G., F.R.S.  
 Ebbels, Arthur.  
 Edgeworth, Prof. F. V.  
 Edwards, Prof. A. Mead (Boston, Mass.).  
 Elgar, Dr. F.  
 Ellis, Wm., F.R.S.  
 Elwes, H. J.  
 Ericsson, Captain J. (New York).  
 Ernst, Dr. A. (Caracas).  
 Espin, Rev. T. E.  
 Etheridge, R., F.R.S.  
 Evans, Sir John, K.C.B., F.R.S.  
 Evans, A. J.  
 Evans, Dr. Sebastian.  
 Everett, Prof. J. D., F.R.S.  
 Ewart, Prof. I. C., F.R.S.  
 Ewing, Prof. J. A., F.R.S.  
 Farmer, Prof. J. B.  
 Farrar, Archdeacon, F.R.S.  
 Fawcett, Mrs. H.  
 Favier, Sir J., K.C.S.I., F.R.S.  
 Ferner, Dr. D., F.R.S.  
 Festing, Major-General, F.R.S.  
 Fisher, Prof. W. R.  
 Fisher, Rev. Osmond.  
 Fitzgerald, Prof. G. E., F.R.S.  
 Fleming, Prof. J. A., F.R.S.  
 Fletcher, L., F.R.S.  
 Flower, Prof. Sir W. H., K.C.B., F.R.S.  
 Forbes, David, F.R.S.  
 Forbes, H. O.  
 Forbes, Prof. G., F.R.S.  
 Forsyth, Dr. A. R., F.R.S.  
 Foster, Dr. C. Le Neve, F.R.S.  
 Foster, Prof. G. Carey, F.R.S.  
 Foster, Dr. M., F.R.S.  
 Fowke, F. R.  
 Fowler, A.  
 Fowler, Principal T.  
 Frankland, Mrs. P.  
 Frankland, Prof. E., F.R.S.  
 Frankland, Prof. P. F., F.R.S.  
 Fream, Dr. W. H.  
 Freeman, Prof. E. A.  
 Friend, Rev. H.  
 Friswell, R. J.  
 Fritsch, Prof. Anton (Prague).  
 Fritsch, Prof. G. (Berlin).  
 Frost, Dr. P., F.R.S.  
 Froude, R. E., F.R.S.  
 Fry, Sir E., F.R.S.  
 Gadow, Dr. Hans, F.R.S.  
 Galloway, W.  
 Galton, Sir Douglas, K.C.B., F.R.S.  
 Galton, Francis, F.R.S.  
 Gamgee, Dr. A., F.R.S.  
 Gardner, H. Dent.  
 Gardner, J. S.  
 Garside, W. H.  
 Garson, Dr. J. G.  
 Garstang, W.  
 Gaskell, Dr. W. H., F.R.S.  
 Geddes, Prof. P.  
 Geikie, Sir Archibald, F.R.S.  
 Geikie, Prof. James, F.R.S.  
 Giacosa, Dr. P. (Rome).  
 Giffen, Dr. R., C.B., F.R.S.  
 Giglioli, Prof. H. H. (Florence).  
 Gilbert, Sir J. H., F.R.S.  
 Gill, Dr. David, F.R.S.  
 Gladstone, Dr. J. H., F.R.S.  
 Glaisher, James, F.R.S.  
 Glaisher, Dr. J. W. L., F.R.S.  
 Glazebrook, R. T., F.R.S.  
 Goldsmid, Sir F.  
 Gore, Dr. G., F.R.S.  
 Gotch, Prof. F., F.R.S.  
 Gray, Prof. Asa, F.R.S. (Harvard).  
 Gray, Prof. Andrew.  
 Green, Prof. A. H., F.R.S.  
 Green, Prof. J. R.  
 Greenhill, Prof. A. G., F.R.S.  
 Gregor-Brodie, Dr. T.  
 Gregory, Dr. J. W.  
 Gregory, R. A.  
 Grove, Sir W. R., F.R.S.  
 Grubb, Sir Howard, F.R.S.  
 Gumbel, Dr. C. W.  
 Gunther, Dr. A., F.R.S.  
 Guppy, Dr. H. B.  
 Haddon, Prof. A. C.  
 Haeckel, Dr. E. (Jena).  
 Haldane, J. S.  
 Hale, Dr. W. H. (Brooklyn).  
 Hall, Maxwell.  
 Haliburton, Prof. W. D., F.R.S.  
 Hammond, J.  
 Hampson, G. F.  
 Harcourt, Dr. A. G. V., F.R.S.  
 Harcourt, L. F. V.  
 Harding, Charles.  
 Harding, J. S.  
 Harker, A.  
 Harkness, Prof. W. (Washington).  
 Harley, Dr. George, F.R.S.  
 Hartley, Prof. W. N., F.R.S.  
 Harting, J. E.  
 Hartog, Prof. M.

- Hartog, P. J.  
Hatch, Dr.  
Haughton, Rev. Prof., F.R.S.  
Haycraft, Dr. J. B.  
Hayward, R. B., F.R.S.  
Hazen, Prof. H. A. (Washington).  
Head, Dr. H.  
Hector, Sir James, K.C.M.G., F.R.S. (Wellington, N.Z.).  
Helmholtz, Prof., F.R.S. (Berlin).  
Hemsley, W. B., F.R.S.  
Henssey, Prof. H. G., F.R.S.  
Henrici, Prof. O. M. F. E., F.R.S.  
Henslow, Rev. G.  
Herdman, Prof. W. A., F.R.S.  
Herman, R. A.  
Herschel, Sir J. F. W., F.R.S.  
Herschel, Prof. A. S., F.R.S.  
Herschel, Colonel J., F.R.S.  
Hicks, Dr. H., F.R.S.  
Hicks, Prof. W. M., F.R.S.  
Hickson, Dr. S. J.  
Hill, Rev. E.  
Hincks, Rev. T., F.R.S.  
Hind, Dr. J. R., F.R.S.  
Hodgkinson, Dr.  
Hodgson, J. E.  
Hoffert, Dr. H. H.  
Hoff, Prof. J. H. van't.  
Hofmann, Prof. A. W., F.R.S. (Berlin).  
Holden, Dr. E. S. (Cal.).  
Holmes, G. C. V.  
Holmes, T. V.  
Hocker, Sir J. D., K.C.S.I., F.R.S.  
Hopkinson, Dr. J., F.R.S.  
Horsley, Prof. V., F.R.S.  
Howard, Dr. J. L.  
Howes, Prof. G. B.  
Howorth, Sir H. H., K.C.I.E., F.R.S.  
Hoyle, W. E.  
Hudleston, W. H., F.R.S.  
Huggins, Dr. W., F.R.S.  
Hughes, Prof. T. McK., F.R.S.  
Hulke, J. W., F.R.S.  
Hull, Prof. E., F.R.S.  
Hummel, Prof.  
Humphry, Prof. Sir G. M., F.R.S.  
Hunt, Dr. H. Sterry (Canada).  
Huntingdon, Prof. T.  
Hurst, Dr. C. H.  
Huxley, Right Hon. T. II., F.R.S.
- Ingleby, Dr.  
Irving, Rev. Dr.  
Ito, T. (Tokio).
- Jack, Prof. W.  
Jackson, J. R.  
Janssen, M. (Paris).  
Japp, Prof. F. R., F.R.S.  
Jastrow, Dr. J. (Madison).  
Jeffry, J. Gwyn, F.R.S.  
Jevons, Prof. W. Stanley, F.R.S.  
Johnston, Dr. Keith.  
Joly, Dr. J., F.R.S.  
Jones, Chapman.  
Jones, Prof. D. E.  
Jones, Prof. T. Rupert, F.R.S.  
Joule, Prof. J. P., F.R.S.  
Judd, Prof. J. W., F.R.S.  
Jukes-Browne, A. J.
- Kanthack, Dr. A. A.  
Kay, J. Taylor.  
Keane, Prof. A. H.  
Keltie, J. Scott.  
Kelvin, Lord, P.R.S.  
Kennedy, Prof. A. B. W., F.R.S.  
Kent, W. Saville.  
Kenwood, Dr.
- Kinch, Prof. E.  
Kingsley, Rev. Charles.  
King, Dr. George, F.R.S.  
Kurby, W. F.  
Klein, Dr. E., F.R.S.  
Klein, Prof. F. (Göttingen).  
Knott, Dr. C. G.  
Kropotkin, Prince.
- Lamb, Prof. H. F.R.S.  
Lang, Andrew.  
Langley, E. M.  
Langley, J. N., F.R.S.  
Langley, Prof. S. P. (Washington).  
Lankester, Dr. Edwin, F.R.S.  
Lankester, Prof. E. Ray, F.R.S.  
Lapparent, Prof. A. de (Paris).  
Lapworth, Prof. C., F.R.S.  
Larlen, W.  
Larmor, Dr. J., F.R.S.  
Lavis, Dr. H. J. Johnston.  
Lawes, Sir J. B., F.R.S.  
Lawrence, Sir J. J. Trevor.  
La Touche, T. D.  
Lea, Dr. W. Sheridan, F.R.S.  
Le Conte, Prof. J.  
Leech, Prof. D. J.  
Lefroy, General Sir J. H., F.R.S.  
Leland, C. G.  
Lendenfeld, Dr. R. von (Zernwisch).  
Levi, Prof. Leone.  
Lewes, Prof. V. B.  
Ley, Rev. W. C.  
Liveing, Prof. G. D., F.R.S.  
Liversidge, Prof. A., F.R.S. (Sydney).  
Lloyd-Bizward, J.  
Lockyer, I. Norman, C.B., F.R.S.  
Lockyer, N. J.  
Lockyer, W. J. S.  
Lodge, Prof. A.  
Lodge, Prof. O. J., F.R.S.  
Loftie, Rev. W. J.  
Love, A. E. H., F.R.S.  
Lowe, E. J., F.R.S.  
Lubbock, Right Hon. Sir John, F.R.S.  
Luigi, L. (Genoa).  
Lupton, Sydney.  
Lydekker, R., F.R.S.  
Lyons, Capt. H. G.  
Lynne, W. T.
- Macalister, Prof. Alex., F.R.S.  
Macalister, Dr. Donald.  
MacDowall, A. B.  
Macfadyen, Dr. A.  
Mackinder, H. J.  
MacLeod, Prof. H., F.R.S.  
MacMahon, Major, F.R.S.  
Maclan, H. G.  
Mignus, Sir Philip.  
Major, Dr. C. J. Forsyth.  
Mallet, Dr. J. W., F.R.S.  
Mallock, A.  
Marcet, Dr. W., F.R.S.  
Markham, Clements, C.B., F.R.S.  
Marriott, W.  
Marr, J. E., F.R.S.  
Marshall, Dr. John, F.R.S.  
Marshall, Prof. Milnes, F.R.S.  
Martin, Prof. H. N., F.R.S. (Baltimore).  
Martin, Dr. S.  
Maskelyne, Prof. N. Stuy, F.R.S.  
Masse, G.  
Masson, Prof. Orme (Melbourne).  
Masters, Dr. M. T., F.R.S.  
Mather, T.  
Maudslay, A. P.  
Maulder, L. W.  
Maxwell, Prof. J. Clerk, F.R.S.  
McIntosh, Prof. W. M., F.R.S.
- McKendrick, Prof. J. G., F.R.S.  
McKonnell, J. C.  
M Lachlan, Robert, F.R.S.  
McNab, Prof. W. R.  
Meldala, Prof. R., F.R.S.  
Meldum, Dr. Charles, F.R.S. (Mauritius).  
Menleleff, Prof. (Moscow).  
Mercier, Dr. C.  
Merriam, Dr. C. Hart (Washington).  
Merrifield, Mrs.  
Meyer, Dr. A. B.  
Miall, Prof. L. C., F.R.S.  
Michelson, Prof. A. A. (Chicago).  
Miers, H. A.  
Mill, Dr. H. R.  
Miller, Dr. A. K.  
Mills, Prof. E. J., F.R.S.  
Milne, Prof. John, F.R.S.  
Minakata, K.  
Munich, Prof.  
Mitchell, P. C.  
Mivart, St. George, F.R.S.  
Monck, W. H. S.  
Moncrieff, W. D. Scott.  
Moore, J. E. S.  
Morgan, Prof. C. Lloyd.  
Morris, Dr. D., C.M.G.  
Moseley, Prof. H. N., F.R.S.  
Mueller, Baron F. von, K.C.M.G., F.R.S. (Melbourne).  
Muir, M. M. Pattison.  
Muir, Dr. T.  
Muller, Dr. Hugo, F.R.S.  
Muller, Prof. Max.  
Murchison, Sir R., F.R.S.  
Murphy, J. J.  
Murray, Dr. G. H.  
Murray, Dr. John.  
Murrell, Dr.  
Myers, Dr. A. T.
- Nathorst, Prof. A. G. (Stockholm).  
Newall, R. S., F.R.S.  
Newcomb, Prof. S. (Washington).  
Newton, E. T., F.R.S.  
Newton, Prof. H. A. (Newhaven, Conn.).  
Newton, Prof. A., F.R.S.  
Nicholson, G.  
Niven, W. D., F.R.S.  
Nordenskiöld, Baron.  
Nordenskiöld, G.  
Notter, Prof.
- Odling, Prof. W., F.R.S.  
Ogilvie, Miss M. M.  
Oliver, Prof. D., F.R.S.  
Oliver, Prof. F. W.  
Ormerod, Miss.  
O'Reilly, Prof.  
Osborn, Prof. H. F. (New York).  
Osten-Sacken, Baron (Heidelberg).  
Otté, Miss.  
Owen, Sir Richard, F.R.S.
- Parker, Prof. T. J., F.R.S.  
Parker, Prof. W. K., F.R.S.  
Parker, Prof. W. N.  
Parkes, Dr. Louis.  
Parry, John.  
Parsons, Dr. H. F.  
Payne, Dr. J. F.  
Pearson, Prof. Karl.  
Peddie, Dr. W.  
Pengelly, W., F.R.S.  
Petrose, F. C., F.R.S.  
Perkin, Dr. W. H., F.R.S.  
Perry, Prof. John, F.R.S.  
Perry, Father, F.R.S.  
Petrie, Prof. W. M. Flinders.  
Pickard Cambridge, Rev. O. F.R.S.

- Pickering, Prof. E. C. (Cambridge, Mass.).  
 Pickering, Prof. S. P. U., F.R.S.  
 Pigott, T. Digby, C.B.  
 Pitt, Dr. G. N.  
 Pitt Rivers, Lieut.-General, F.R.S.  
 Plarr, Dr. G.  
 Playfair, Lord, K.C.B., F.R.S.  
 Plummer, W. E.  
 Pockels, Miss A. (Göttingen).  
 Pocock, R. I.  
 Poey, Prof. (Havana).  
 Pole, Dr. William, F.R.S.  
 Potter, Prof. M. C.  
 Poulton, Prof. E. B., F.R.S.  
 Power, H.  
 Poynting, Prof. J. H., F.R.S.  
 Preece, W. H., C.B., F.R.S.  
 Preston, Dr. S. Tolver.  
 Prestwich, Prof. J., F.R.S.  
 Pritchard, Rev. Prof. C., D.D., F.R.S.  
 Proctor, R. A.  
 Purdie, Prof.  
 Pye-Smith, Dr. H., F.R.S.
- Quincke, Prof. G. H. (Heidelberg).
- Ramsay, Prof. W., F.R.S.  
 Rankin, Angus.  
 Rankine, Prof. W. J. M., F.R.S.  
 Ranyard, A. C.  
 Rayleigh, Lord, F.R.S.  
 Reade, T. Mellard.  
 Reid, Clement.  
 Reinold, Prof., F.R.S.  
 Renard, Abbe F. (Brussels).  
 Reyer, Prof. E. (Vienna).  
 Reynolds, Prof. J. E., F.R.S.  
 Richardson, Sir B. W., F.R.S.  
 Rivers, Dr. W. H. R.  
 Rix, H.  
 Roberts-Austen, Prof. W. C., C.B., F.R.S.  
 Robertson, Prof. G. Croom.  
 Rodger, J. W.  
 Rodwell, G. F.  
 Rolfe, R. A.  
 Rolleston, Prof. G., F.R.S.  
 Romanes, Dr. G. J., F.R.S.  
 Roscoe, Sir H. E., F.R.S.  
 Rosse, Lord, F.R.S.  
 Routh, Dr. L. J., F.R.S.  
 Roy-ton-Pigott, G. W., F.R.S.  
 Rucker, Prof. A. W., F.R.S.  
 Ruller, F. W.  
 Rumer, Dr. M. A.  
 Runge, Prof. C. (Hanover).  
 Ruskin, John.  
 Russell, H. C., C.M.G., F.R.S. (Sydney).  
 Russell, W. H. L., F.R.S.  
 Russell, D. W. J., F.R.S.  
 Russell, Hon. Rollo.  
 Ruthford, Prof. W., F.R.S.
- Salvin, Osbert, F.R.S.  
 Sanderson, Prof. T. Bardou, F.R.S.  
 Sarasin, Dr. F. (Geneva).  
 Sayer, Prof. A. H.  
 Schaler, Prof. E. A., F.R.S.  
 Schlich, Prof.  
 Schorlemmer, Prof. C., F.R.S.  
 Schunck, L., F.R.S.
- Schuster, Prof. A., F.R.S.  
 Schweinfurth, Dr.  
 Selater, Dr. P. L., F.R.S.  
 Scott, Dr. D. H., F.R.S.  
 Scott, R. H., F.R.S.  
 Scudder, S. H.  
 Searle, G. F. C.  
 Sedgwick, Prof., F.R.S.  
 Seebohm, Henry.  
 Seeley, Prof. H. G., F.R.S.  
 Semon, Dr. F.  
 Sharp, Dr. D.  
 Sharpe, Dr. R. Bowdler.  
 Shaw, Dr. John.  
 Shenstone, W. A.  
 Sherrington, Dr. C. S., F.R.S.  
 Shipley, A. E.  
 Shore, Dr. E. A.  
 Sidgreaves, Rev. W.  
 Sidgwick, Alfred.  
 Silvester, F. W.  
 Skeat, Rev. Prof.  
 Sklarek, Dr. W. (Berlin).  
 Smallwood, Dr. (Montreal).  
 Smith, Rev. F. J., F.R.S.  
 Smith, Worthington G.  
 Smith, Prof. W. H. G.  
 Smith, Prof. W. Robertson.  
 Smith, Prof. C. Michie.  
 Smith, Dr. Lorrain.  
 Smith, H. Ll.  
 Smithells, Prof. A.  
 Smyth, Prof. C. Piazzini.  
 Sollas, Prof., F.R.S.  
 Sorby, Dr. H. C., F.R.S.  
 Spencer, Herbert.  
 Spencer, Prof. W. B. (Melbourne).  
 Spottiswoode, W., F.R.S.  
 Starling, Dr. E. H.  
 Stebbing, Rev. T. R. K.  
 Stevenson, C. A.  
 Stewart, Dr. R. W.  
 Stewart, Prof. Balfour, F.R.S.  
 Stirling, Dr. E. C., C.M.G., F.R.S. (Adelaide).  
 Stokes, Sir G. G., F.R.S.  
 Stoney, Dr. Johnstone, F.R.S.  
 Strachey, Lieut.-General R., F.R.S.  
 Stricker, Prof. S.  
 Stroud, Prof.  
 Sully, Prof. James.  
 Sylvester, Prof. J. J., F.R.S.  
 Symons, G. J., F.R.S.
- Tait, Prof. P. G.  
 Taylor, Albert.  
 Taylor, Sedley.  
 Teall, J. J. H., F.R.S.  
 Tegetmeier, W. B.  
 Ten Kate, Dr. H.  
 Tennant, Lieut.-General, F.R.S.  
 Thompson, Dr. C. Symes.  
 Thompson, Prof. D'Arcy W.  
 Thompson, Prof. S. P., F.R.S.  
 Thomson, Sir Wyville, F.R.S.  
 Thomson, Prof. James, F.R.S.  
 Thomson, Prof. J. J., F.R.S.  
 Thorpe, Prof. T. E., F.R.S.  
 Tilden, Prof. W. A., F.R.S.  
 Trichener, Dr. E. B.  
 Tizard, Captain, F.R.S.
- Tomes, Charles C.  
 Tomlinson, C., F.R.S.  
 Tomlinson, H., F.R.S.  
 Topley, W., F.R.S.  
 Trail, Prof. J. W. H., F.R.S.  
 Traquair, Prof. R. H., F.R.S.  
 Trimen, Henry, F.R.S. (Ceylon).  
 Trouton, F. T.  
 Tucker, R.  
 Tuckwell, Rev. W.  
 Take, Dr. Hack.  
 Turner, Prof. Sir William, F.R.S.  
 Turner, Prof. H. H.  
 Tatton, A. E.  
 Tylor, Dr. E. B., F.R.S.  
 Tyndall, Prof. John, F.R.S.
- Unwin, Prof. W. C., F.R.S.
- Varigny, Dr. H. de.  
 Vaughan, W.  
 Veley, V. H., F.R.S.  
 Venn, Dr. J., F.R.S.  
 Vignoles, C. B., F.R.S.  
 Vines, Prof. S. H., F.R.S.
- Walker, Prof. J.  
 Wallace, Dr. A. R., F.R.S.  
 Wallace, Prof. R.  
 Waller, Dr. A. D., F.R.S.  
 Walsingham, Lord, F.R.S.  
 Ward, Prof. H. Marshall, F.R.S.  
 Warrington, R., F.R.S.  
 Watson, W.  
 Watts, W. W.  
 Weismann, Prof. A. (Freiburg).  
 Weiss, Prof.  
 Weldon, Prof. W. F. R., F.R.S.  
 Wells, H. G.  
 Wethered, Dr. F. G.  
 Wharton, Captain W. J. L., F.N., F.R.S.  
 Wheatstone, Sir Charles, F.R.S.  
 Whipple, G. M.  
 Whitaker, W., F.R.S.  
 White, W. H., C.B., F.R.S.  
 Whitehead, C.  
 Wilde, H., F.R.S.  
 Williams, W. M.  
 Williamson, Prof. A. W., F.R.S.  
 Williamson, Prof. W. C., F.R.S.  
 Willis, Dr. A. R.  
 Wilson-Barker, Captain David.  
 Woodhead, Dr. Sims.  
 Woodward, B. B.  
 Woodward, H. B.  
 Woodward, A. Smith.  
 Woodward, Dr. H., F.R.S.  
 Wooldridge, Dr. L. C.  
 Worthington, Prof. A. M., F.R.S.  
 Wright, Dr. C. R. Alder, F.R.S.  
 Wright, Dr. E. P.  
 Wrightson, Prof. J.  
 Wynne, Dr. W. P.
- Yearsley, P. M.  
 Yeo, Dr. J. B.  
 Young, Sir George.  
 Young, Dr. Sydney, F.R.S.  
 Young, Prof. C. A. (Princeton, New Jersey, U.S.A.).



A WEEKLY ILLUSTRATED JOURNAL OF SCIENCE.

"To the solid ground  
Of Nature trusts the mind which builds for aye."—WORDSWORTH.

THURSDAY, NOVEMBER 1, 1894.

PAST AND PRESENT.

JUST five-and-twenty years ago, the Editor of NATURE did me the honour to request that I would write the leading article for his first number. In complying with my friend's wish, I said that I could think of no more appropriate preface to a journal, the aim of which was "to mirror that fashioning by nature of a picture of herself in the mind of man," which is called science, than an English version of the wonderful rhapsody *Die Natur*, which is to be found among Goethe's works,<sup>1</sup> and which had been a source of instruction and delight to me from my youth up.

Whether my estimate of the fitness of these pregnant aphorisms for the place assigned to them was shared by more than half-a-dozen of the readers to whom they were submitted, is very doubtful; indeed, I feel bound to confess that a rumour reached my ears, to the effect that some authorities, apparently of the school of the most noble Festus, in their haste, failing to discriminate between the great poet and his translator, opined that much attempt to learn, if not much learning, had made me mad.

A verdict based on a mistake so flattering to any literary vanity I might possess could be borne with equanimity. Indeed, in view of the general state of opinion among those interested in physical science at the time, I had no right to imagine that a presentation of a theory of the universe based exclusively upon the scientific study of nature—a prose poem, which stands in somewhat the same relation to the

philosophy of Spinoza as the "Essay on Man" to that of Shaftesbury and Bolingbroke—would be intelligible to more than a small minority; or acceptable to more than a fraction of even that fit though few company.

At that time, it was rare for even the most deservedly eminent of the workers in science to look much beyond the limits of the specialty to which they were devoted; rarer still to meet with any one who had calmly and clearly thought out the consequences of the application, in all the regions into which the intellect can penetrate, of that scientific organon, the power and fruitfulness of which, within their particular departments, were so obvious. Though few read, and fewer still tried to comprehend the writings of Francis Bacon, a respectable, almost venerable, tradition bid us glorify him as the guide, philosopher, and friend of science; and more especially held him up as our exemplar in his insistence upon the division of the world of thought into two—an old and a new—but, unlike the corresponding divisions of the terrestrial surface, separated by impassable barriers. In the new, the strict adherence to scientific method was inculcated, and a rich reward of benefits to man's estate promised to the faithful; in the old, on the contrary, scientific method was to be anathematised, while absolute dependence was to be placed on quite other mental processes. Men were called upon to be citizens of two states, in which mutually unintelligible languages were spoken and mutually incompatible laws were enforced; and they were to be equally loyal to both.

People engaged in the ordinary business of life were not much troubled by difficulties which were not forced upon them by their avocations. Nor, among the men of science, did they press hardly on the mathematicians, the physicists, and the chemists.

<sup>1</sup> A better translation than mine and an interesting account of the very curious obscurity which hangs about the parentage of *Die Natur* are to be found in Mr. J. Bailey Saunders' recently published "Goethe's Aphorisms and Reflections."

At one time, the astronomers underwent sundry perturbations, yet these somehow got smoothed over and ignored. But there was serious trouble among the geologists and biologists. However sincerely they might try to shut their eyes, it was impossible to be wholly blind to the fact that for them the two worlds were not separable. On the contrary, it was becoming plainer and plainer that a vast tract, hitherto claimed for the old, was being steadily invaded and annexed by the citizens of the new world.

Fifty years ago the tension was already serious, but matters had not got so far as to seem desperate. It was possible for very eminent and, at the same time, perfectly sincere men, to keep their scientific and their other convictions in two separate logic-tight compartments. At least, it was said that some, perhaps too deeply bent on the search after final causes, found a reason for the duplicity of the cerebral hemispheres, in their adaptation to the purposes of this duplex intellection. Conducive to outward and inward peace as might be the convention, in virtue of which science was to be kept grinding at the mill of utility, and (by way of completing the resemblance to Samson) carefully blinded, or at any rate hoodwinked, rest glimpses of a nobler field of action should end in an outbreak on the Philistines, the difficulty of observing it, as uniformitarian principles obtained the ascendant among the geologists, became insuperable. Outside the narrow circle of the peace-at-any-price "reconcilers," the *pax Baconiana* was plainly coming to an end in the middle of the century. It was finally abolished by the publication of the "Origin of Species."

The essence of this great work may be stated summarily thus: it affirms the mutability of species and the descent of living forms, separated by differences of more than varietal value, from one stock. That is to say, it propounds the doctrine of evolution as far as biology is concerned. So far, there is nothing new in Darwin's enterprise. So far, we have merely a re-statement of a doctrine which, in its most general form, is as old as scientific speculation. So far, we have the two theses which were declared to be scientifically absurd and theologically damnable by the Bishop of Oxford at the meeting of the British Association at Oxford in 1862.

It is also of these two fundamental doctrines that, at the meeting of the British Association in 1893, the Chancellor of the University of Oxford spoke as follows:—

"Another lasting and unquestioned effect has resulted from Darwin's work. He has, as a matter of fact, dispensed of the doctrine of the immutability of species."

And

"Few now are found to doubt that animals separated by differences far exceeding those that distinguish what we know as species have yet descended from common ancestors."

Undoubtedly, every one conversant with the state of biological science is aware that general opinion has long had good reason for making the *volte face* thus indicated. It is also mere justice to Darwin to say that this "lasting and unquestioned" revolution is, in a very real sense, his work. And yet it is also true that, if all the conceptions promulgated in the "Origin of Species" which are peculiarly Darwinian were swept away, the theory of the evolution of animals and plants would not be in the slightest degree shaken.

Ever since I began to think over these matters it has been clear to me that the question whether the forms of life on the globe have come about by evolution, or in some other way, is an historical problem, and must be treated as such. Either there are records of the process, or there are not. If there are not, we are shut up to the devising of more or less probable hypotheses based on indirect evidence. If there are adequate records, our business is to decipher them, and abide by what they tell us. Now, in 1859, there was no doubt about the existence of records; nor any about the fact that they extended over a vast period of time; nor any about the order of succession of the facts they registered. But, there was also no doubt in the mind of any one who looked critically into these records, that, in spite of their seeming copiousness, they were the merest fragments, torn and tattered remnants of the continuous series of documents which once existed. But, very largely in consequence of the stimulus given by Darwin, palæontological research was taken up with new vigour, and with marvellous success. So that, in 1878, I felt justified in writing—

"On the evidence of palæontology, the evolution of many existing forms of animal life from their predecessors is no longer an hypothesis but an historical fact."<sup>2</sup>

And in 1880—

"If the doctrine of evolution had not existed, palæontologists must have invented it, so irresistibly is it forced upon the mind by the study of the remains of the Tertiary Mammalia which have been brought to light since 1859."<sup>3</sup>

I am not aware that these statements have ever been controverted; and, in view of the following deliverances of the author of the most authoritative recent treatise on Palæontology, I think they are not likely to be:

<sup>1</sup> British Association for the Advancement of Science, Oxford, 1894. Address of the Most Hon. the Marquis of Salisbury, President.

<sup>2</sup> "Collected Essays," vol. ii. p. 279. <sup>3</sup> *Ibid.*, p. 241.



"Recent investigations have utterly shattered the belief in cataclysms. The conviction has arisen that the process of the development and metamorphosis of organic beings was gradual and uninterrupted, and that sharp lines of demarcation are to be found only where considerable changes in the conditions of existence, and especially in the distribution of land and water, have brought about great modifications in the world of life or interruptions in the formation of sediment." (Zittel: "Handbuch der Palæontologie." Bd. I. p. 23.)

And, again, in the recently completed final volume of this standard work we read:

"The whole history of the evolution of the mammalia from the Trias to the present day, in spite of all deficiencies in the record, plainly shows that the genetic connection of the several Faunæ, whatever geological disturbances may have taken place, was never completely interrupted; and that each of these associations of animals has arisen by gradual transformation of the constituents of its predecessor, and has furnished the stock of its successor." (Bd. IV. p. 764.)

However often, therefore, thoughtlessness, or polemical dexterity, may confuse issues which are totally distinct, biological evolution rests, in perfect security, on the firm foundation afforded by the study of the remains of the animals and plants, which have successively peopled the world during the untold ages of its past history. The coming into being of the present forms of life has happened so, and in no other way.

And, as I pointed out, sixteen years ago,

"It is only the nature of the physiological factors to which that evolution is due which is still open to discussion."<sup>1</sup>

For me, the claim of the doctrine of evolution to be taken into account in all philosophical and other views of the nature of things turns upon whether it possesses a solid foundation in fact or is a mere speculation. No doubt, whenever astronomers universally accept what is called the Kant-Laplace theory of the heavens, a notable addition will be made to this indispensable objective foundation of the doctrine. Whenever chemists accept the evolution of the so-called elements from a *materia prima*, there will be a further grand addition. But, for the present, I venture to suppose that the palæontological base is surest. And, at any rate, so far as the claims of science to be heard in regard to the problems of human life are concerned, it is, far and away, the most important. If man has come into existence by the same process of evolution as other animals: if his history, hitherto, is that of a gradual progress to a higher thought and a larger power over things; if that history is essentially natural; the frontiers of the new world, within which scientific method is supreme, will receive such a remarkable extension as to leave little but cloudland for its rival.

<sup>1</sup> "Collected Essays," vol. ii. p. 226.

Experience teaches me it is by no means impossible that if I were to stop here, what I have said would be represented, and even believed, to be a repudiation of "Darwinism." Yet no conclusion could be more utterly devoid of foundation.

"The combined investigations of another twenty years may, perhaps, enable naturalists to say whether the modifying causes and the selective power, which Mr. Darwin has satisfactorily shown to exist in nature, are competent to produce all the effects he ascribed to them; or whether, on the other hand, he has been led to over-estimate the value of the principle of natural selection, as greatly as Lamarck over-estimated his *vera causa* of modification by exercise."

... "My sons dig in the vineyard,<sup>1</sup> were the last words of the old man in the fable; and though the sons found no treasure they made their fortune by the grapes."

These two paragraphs occur at the end of the critical notice of the "Origin of Species," which I wrote in 1859. The citations I have already given from Zittel sufficiently show what has come of "digging in the vineyard"; there is another (Bd. I. p. 42) much to the present purpose.

"For the naturalist, evolution (*die Descendenz theorie*) offers the only natural solution of the problem of the development and succession of organic beings. But as to the causes which bring about the modification of species, and especially the change in a given direction, opinions are yet greatly divided. That the principle of natural selection, discovered by Darwin, leaves many phenomena unexplained is no longer denied by even the warmest followers of Darwin."

It will be observed that at any rate one of these "warmest followers" has never thought of denying it. On the contrary, he has over and over again brought the difficulties prominently forward. Nevertheless, I doubt as little, now as heretofore, that the probabilities are greatly in favour of our finding a way to the causes of evolution by pertinacious study of variation and natural selection. There are large fields for inquiry open on all sides. How much has yet been done, for example, towards ascertaining the effect of external conditions on the struggle for existence within the organism and the production of varieties as a consequence of that struggle; or towards an adequate experimental study of variation? The supposition that problems such as these, and others that might easily be mentioned, could be finally solved, even in thirty-five years, is one that would not enter the mind of a competent biologist; and the parade of the mutual contradictions and the intrinsic weaknesses of the hypotheses which, hitherto, have been more or less tentatively propounded, as if they had anything to do with the truth or falsehood of the doctrine of evolution, should not be taken too seriously.

T. H. HUXLEY.

## ECONOMIC PRODUCTS OF INDIA.

*A Dictionary of the Economic Products of India.* By George Watt, M.B., C.M., C.I.E., assisted by numerous contributors. In six volumes (vol. vi. in four parts), 1889-1893. Published under the authority of the Government of India, Department of Revenue and Agriculture. (Calcutta: Superintendent of Government Printing.)

THE completion of this important work adds enormously to the facilities previously existing for acquiring a knowledge of the vegetable, mineral, and animal products of our Indian empire. The object of the dictionary is to give a complete account of all Indian products that have been in any way utilised by man, however small or trivial the use of them may have been. As a large majority of the products are of vegetable origin, the appointment of a botanist as editor and principal author was essential, and the Government of India may be fairly congratulated on the result.

In the preface to the first volume the author states that he has had "to keep in view a two-fold purpose; viz. on the one hand to supply scientific information which may be useful to the administrative officer, and on the other to meet the requirements of the reader in search of definite information regarding Indian economics." Whether another purpose was to produce a large book is not stated, but no feature of the work is more conspicuous than that it consists of nine bulky and rather closely-printed volumes.

In general plan the dictionary consists of long and elaborate accounts of the more important articles of commerce produced in India, such as various grains, dyes, oils, tea, cotton, sugar, indigo, wool, silk, &c., and shorter notices of less valuable products. As a general rule each vegetable product is described under the scientific name of the plant from which it is obtained, cross references being supplied where necessary under English and Indian terms, and also under general headings, such as "Oils and Fats," "Timbers," &c. Animal and mineral products are described under various headings. A general index is promised, and is needed, for many important English and vernacular terms are not found in their places. For instance, silk-cotton, semul, jowari and jurri, bijra, cholam, cumbao, charas, ganju, ngilpi, civet and Viverra may be searched for in vain. Tasar is inserted, but there is no reference to tussar or tussah, the common spelling, in the place where these words would come in alphabetical sequence. The article on isinglass is slightly out of its proper place, and that on sharks' fins and fish maws, to which reference is made under both isinglass and fish, appears to have been omitted.

Each article, in the case of vegetable products, consists of the scientific name of the plant, with references, the English name, if one exists, and a list of vernacular names, followed by full references to the works, scientific or popular, in which the plant or its products have been described. Then follow paragraphs on the habitat, history and useful products, such as dyes, fibres, oils, gums, &c., each under a separate heading. Sometimes a paragraph explains the chemical composition. Under additional headings are related the uses to which the

plant or its products are put in medicine, food, or the arts, and to the paragraph on medicine another is frequently added with "special opinions" by various medical officers. In the case of trees the structure of the wood receives special notice. The last paragraph of each article describes the "domestic and sacred uses." With mineral and animal products the plan is similar, but details are given, as a rule, under general headings, such as horns, skins, wool, iron, &c. In the first volume a botanical diagnosis of each plant is generally added, but not in the later volumes. A number for each separate product or use is inserted in the margin to facilitate reference, the numbers commencing afresh under each letter of the alphabet.

The longer articles contain full descriptions of cultivation, trade, manufactures, and other important subjects.

Whilst the bulk of the work is by Mr. Watt, many articles have been contributed, partly or wholly, by other writers. The list of contributors affixed to the first volume refers only to that volume, or to that and the second, for in the prefaces to the third and subsequent volumes several additional names are mentioned, one of them, Dr. J. Murray, being that of the author of several important articles. All of the principal contributors, except Mr. Watt (and he holds the degree of M.B.), belong to the Indian Medical Service, so that it is not surprising to find a very large space devoted to drugs and therapeutics. In fact, the whole work might fairly be termed a dictionary of economic products and materia medica. Many of the plants catalogued are apparently included solely because of some medicinal or supposed medicinal use, frequently by ignorant people. For example, on the last two pages of the work, *Zornia diphylla* is introduced on account of its use thus quoted under the head of "Medicine": "The root is given, along with that of *Bhatar jhapni*, to induce sleep in children. These plants shutting up their leaves at night have probably suggested the idea to the Ojhas." The quotation is from a report by Mr. Campbell on the "Economic Products of Chutia Nagpur." No reference can be found to *Bhatar jhapni* in its place in the dictionary.

The "special opinions," quoted from various medical writers on therapeutics, are of a miscellaneous nature, and no distinction is drawn between notices of the purposes for which drugs are used by competent physicians, and those of occasions on which they are prescribed by ignorant hakims or superstitious herbalists. All this part of the work might have been omitted with advantage; however useful such opinions might be in a special work on drugs and therapeutics, the details are out of place in a description of economic products. One instance may be quoted. Under the head of "Diamond," the following occurs: "*Medicine.* Diamond dust is known to be a powerful mechanical poison. In Hindu practice it is, however, to some extent used as a drug" (just as gold, silver, pearls, and other precious substances are regarded by unscientific races as possessing great medicinal virtues). The whole extract is too long to quote, but the "special opinion" runs thus: "Employed as a poison, it is administered in the shape of dust, as in the late celebrated case when the Resident of Baroda, Sir Arthur Phayre, nearly lost his life." The Resident of

Baroda was Sir Robert Phayre, not Sir Arthur, the well-known Chief Commissioner of Burma, and the risk to life was due to an important fact which the distinguished surgeon, whose name is appended to the quotation, must have forgotten, the admixture of arsenic with the diamond dust. The latter is simply a mechanical irritant like quartz sand, or powdered glass, and to term any of these a powerful mechanical poison is to use a stronger term than is quite accurate.

The devotion of a large space to therapeutics is not the only instance in which the bulk of the work is increased by the discussion at length of matters that have but slight connection with the main subjects of the dictionary, as specified by the author. Perhaps the utilisation of several pages under *Triticum sativum* (wheat) in the discussion of the depreciation of silver, may be thought essential, but it is not clear why, under *Papaver somniferum*, long extracts should be quoted from various dispatches to illustrate the attitude of the Government of India on the Chinese opium question, nor what bearing on the economic products of India the seven pages can have, under *Vitis vinifera*, that are taken up with the history of the vine and of wine. Amongst the longer articles, 63 pages are given to tea (in addition to 19 on *Camellia theifera*), 77 to tobacco, 87 to indigo, 88 to opium, 123 to sheep, goats, wool and woollen manufactures, 152 to rice, 174 to cotton, 238 to silk and silk manufactures, and 380 to the sugar-cane and sugar. Almost every one of these articles would require a separate notice for adequate discussion. For many purposes a condensed account of the history, production, manufacture, and trade in each case would be more generally useful as well as more interesting; but, on the other hand, it is extremely difficult for the author of a work like the present to select only those data that are useful, and no editor can be expected to possess the special knowledge of every separate subject that will enable him to do justice to it, and to avoid mistakes.

In the preface to the first volume it is stated that economic products which belong to the animal and mineral kingdoms have been but very imperfectly touched upon. This plan, however, appears to have been modified subsequently, since silk and wool, as already noticed, form the subjects of two of the longest articles. The accounts of minerals have, for the most part, been written by officers of the Geological Survey, or copied from the Survey publications. It is questionable, however, if any geologist can have written the following passage under the heading of iron: "*Chy ironstone* exists in large deposits in many coal-measures, and in this situation is known as *black band*." It is, of course, only one variety that is known by this name.

No parts of the dictionary, however, stand more in need of scientific revision than those relating to vertebrate animals. A few instances will show this. A short article on "Pheasants, Jungle-fowl, Partridges, &c.," commences thus: "The pheasant families of birds, *Phasianide*, *Megapodide*, and *Galline* (*sic*) comprise the pea-fowl, pheasant, jungle-fowl, and spur-fowl, while the partridge family, *Tetraonide*, includes the partridge, snow-cock, and certain forms of quail." A list follows in which the genera *Pavo*, *Argusianus*, and *Polyplectron* only are included in the family *Phasianide*, all other

pheasants, amongst them the typical genus *Phasianus*, are placed with *Megapodius nicobariensis* in the family *Megapodide*, and the so-called family *Galline* (which is really a sub-family of *Phasianide*) contains *Gallus* and *Galloperdix*. These mistakes are apparently copied from Murray's "Avifauna of British India." In the article "Oxen," the wild and tame yaks are rightly classed as one species, but the tame buffalo is separated, under the name of *Bubalus bos*, from the wild race, or *B. arni*. No reason is assigned for a distinction that is quite opposed to the views of all modern writers on mammalia, nor is any authority given for the name adopted, which is simply the old Linnæan name *Bos bubalus* reversed.

The omission of any notice of ngápi [in its proper place has already been mentioned. This curious compound of partially decomposed fish with salt is a most important article of food in Burma, where it may be said to replace butter and cheese amongst a people, who, like the Chinese, hold milk and all substances obtained from it in abhorrence. The manufacture of ngápi is on a very large scale, and the trade in the article is extensive, yet apparently the only notice of the mode of preparation that occurs in the dictionary "Fish," vol. iii. p. 367) is apparently erroneous, and certainly does not apply to one of the ordinary processes. Three or four different kinds of ngápi are mentioned in the *Burma Gazetteer*, and their manufacture described; all the processes are radically distinct from that briefly quoted in the dictionary, whilst no information is given in the latter as to the trade in the article or its value, except what may be inferred from the fact that the revenue from Burmese Fisheries in 1883 was twelve to thirteen lakhs of rupees.

In the article on sheep and goats, and in some others, the authorities for scientific names are quoted on the botanical, not on the zoological system, and it is rather strange to find the nilgai called *Bosclaphus tragocamelus*, W. Sclater (instead of Pallas), and the Tibetan gazelle, *Gazella picticaudata*, Brooke instead of Hodgson. The mutton of the dumba, or fat-tailed sheep, is said to be very coarse, whereas it is the best mutton in Asia. The common Indian story, repeated in the dictionary, under "Camel's milk," that the sweetmeat halwa, brought from the Persian Gulf, is composed of camel's milk and honey (vol. ii. p. 64, is a mistake. Errors like the two last (others might be quoted) are liable to occur in a work like the present, but the number of mistakes of various kinds in the articles on animals and animal products appears to be rather large. It is not easy to understand why, in an important Government work like the present, the aid of competent zoologists could not be obtained to revise the proofs.

A serious mistake may be pointed out in an article on the yeast plant, described under the somewhat pedantic heading of *Cerevisia fermentum*. Yeast, it is said, "lives and increases in the fermenting liquor, but appears to abstract nothing from it." This mistake may however have been noticed, for in a later article, on "Malt liquors," a correct account of the growth and nutrition of yeast is quoted.

One presumably Indian economic product, paper, can scarcely be said to be favourably represented by the

material used in the present work, nor are the type and printing, especially in the later volumes, the best ever produced in India. Misprints are numerous. One is amusing: the Tibetan antelope is credited with no less than ten horns. It is to be hoped that commentators on the Apocalypse will not be led to believe that a ten-horned beast really inhabits Tibet.

On the whole, whilst in case a second edition is required, careful revision is desirable, which might in some cases take the form of abridgement and the omission of irrelevant matter, the principal feature of the work is the large amount of energy that has been expended in its preparation, and the great effort that has been made to bring together information from all quarters. To write a complete account of the products of India, and to give a full scientific and economic description, both of the products themselves and of the sources from which they are derived, are tasks far beyond the powers of any single individual, and that could only be thoroughly carried out by a committee of specialists.

W. T. B.

*CHINESE AND JAPANESE BUTTERFLIES.*  
*Butterflies from China, Japan, and Corea.* By John Henry Leech, B.A., F.L.S., F.Z.S., F.E.S., &c. 4to. With forty-three coloured plates. (London: R. H. Porter, 1892-1894.)

UNTIL within the last few years, almost nothing was known of the Palearctic fauna, except that of Europe and the Mediterranean sub-region, and though butterflies are the most attractive and the easiest collected of all insects, those with which we were acquainted from Siberia, the greater part of China, and Japan, might almost have been counted on the fingers.

Since then, however, great progress has been made. In the first place, Russian exploration and consolidation have opened up vast regions of previously almost unknown parts of Asia to science, and the work begun on the Amur and in Turkestan by Schrenck and Fedchenko, has been worthily continued by the Grand Duke Nicholas Mikhailovitch and his coadjutors, among whom the brothers Groun-Grshimailo deserve the place of honour. When shall we see one of our own Royal Princes bringing out a work on the insects of one of our own colonies to compare with Romantoff's "Mémoires sur les Lépidoptères?" In Western Europe, such work is left to private enterprise.

The French Jesuit missionaries, especially the Abbé David, have penetrated to such out-of-the-way parts of China, as Mou-pin, and have brought back large collections of different kinds, including many very remarkable butterflies, which have been illustrated by Oberthür in his "Études d'Entomologie."

Since the time when China and Japan were thrown open to Europeans, English entomologists have not been behindhand in the work of collection and description. The fine collections formed in Japan by Lewis, Pryer, and Maries have been worked out so well by Dr. Butler and others, that the Lepidoptera of Japan are now more thoroughly known than those of any other part of Asia except British India. The late Mr. W. B. Pryer published a work on the butterflies of Japan, in the country itself,

in English and Japanese, with coloured plates of all the species known to him; but as this book is scarce, and the letterpress very meagre, we are glad that Mr. Leech has included Japan in the important work which forms the subject of the present article.

Mr. Leech commenced his entomological career by the publication of a useful little volume on British *Pyralidæ*, and by collecting excursions to the Canary Islands, Brazil, &c. Subsequently he became interested in the fauna of Eastern Asia, and devoted eight years to its study, and to the accumulation of materials for the present work, not only by employing experienced collectors like Pratt and Kricheldorf to explore the interior of China, but by personally visiting and forming large collections in the Himalayas, Corea, and Japan: in Japan, indeed, he succeeded in capturing almost every species of butterfly known to inhabit the country. By this means, he gradually accumulated the fine collections on which he has based his great work, in which he has been able fully to describe 650 species, a large proportion of which are figured in the forty-three excellent coloured plates which accompany it. We have also a map, and five plates of scenery (four of Western China and one of Japan), the second of which exhibits a side-view of the tremendous and almost perpendicular face of the mountain of Omei-Shan, in the neighbourhood of which Mr. Pratt obtained many of the most beautiful and interesting butterflies which he discovered.

The usefulness of the work is increased by an interesting introduction, dealing with the literature of the subject, the countries visited by the author and his collectors, and a table of geographical distribution, divided into the following columns: Japan, China, Corea, Amurland, Himalayas, Thibet, Europe, and "other countries and regions."

The author remarks in his preface: "It is a matter of regret that, owing to an almost complete absence of information respecting habits and life-histories of the majority of the species, the work is unfortunately less complete than the author could have wished." All honour to him for saying so. It is the duty of every entomologist to seek for and record everything of the kind which he can obtain; but entomologists are sometimes too much disposed to care only for the specimens they receive, and it would not occur to them to encourage their collectors, as they easily might do, to record anything more than dates and localities. Mr. Leech, however, seems both to have sought for and utilised such information, so far as it was accessible or obtainable.

On examining Mr. Leech's 650 species of butterflies, which are distributed among rather more than 150 genera, it becomes apparent that they are to a large extent mainly an amplification of the European fauna. About 300 species are found in Europe proper, divided into about 50 genera, of which only about 9 genera, each including but one, or at most two or three, species of very limited range, are not represented in Mr. Leech's work. These are *Triphysa*, *Nemobius*, *Aurotis*, *Thestor*, *Zegris*, *Doritis*, *Spilothyrus*, *Thymelicus*, and *Cyclopidæ*; and there is no reason why some, even of these, should not extend to Western China. In China the European and Indian faunas meet and mingle; thus in the *Satyrinae*, the Mountain Brown butterflies of the genus

*Erebia* are far more sparingly represented in China than in Europe; but *Letha* is far better represented in China than in India, and *Ypthima* at least as well. The tropical subfamilies *Morphina* and *Acraeina* are also represented in China, the first by four species, one of which, *Stichopthalma howqua*, is as large and handsome as a South American *Morpho*, and the other by one of the two Indian species, *Pareba vesta*, which extends its range to several parts of South-Western China. In Japan and the extreme east of China, we find one or two species belonging to peculiarly Nearctic forms, such as *Anthocharis scolymus*, for example.

In certain large genera, such as *Zephyrus*, *Thecla*, and *Papilio*, the number of Chinese species far exceeds those known to occur in Europe; but in the case of *Papilio*, at least, this is mainly due to the large number of properly Indian species which extend their range to China.

It is among the *Papilionida* and *Pierida* that we find some of the most interesting of the Chinese and Central Asian forms, especially those allied to *Parnassius*, *Aporia*, and *Colias*. There are only about thirteen well-marked genera of *Papilionida*, except the heterogeneous genus *Papilio* itself; and eight of these are represented in Mr. Leech's district, the other five being *Hypermnestra* (South-West Asia), *Eurycus* (Australia), *Euryades* (South America), *Thais* (South Europe), and *Bhutanitis* (Bootan). The headquarters of *Parnassius*, however, are perhaps in the mountainous districts rather beyond the range of the present work, as Mr. Leech enumerates only eight species, which seems to us to be rather a small number. Many curious genera allied to *Aporia* are also found in the south-western districts of China bordering on Thibet, such as *Mesapia*, *Davidina*, &c., most of which bear a general resemblance to our Green-veined White (*Pieris napi*). Of these, Oberthur's genus *Davidina* is the most curious, as the wing-cells are divided by longitudinal nervures, a characteristic which we do not meet with in any other butterfly. Only four species of *Colias* are enumerated, the headquarters of this genus also being apparently rather beyond Mr. Leech's limits. He has, however, sunk all the Japanese forms described as distinct by various authors, as varieties of *C. hyale*, Fabr.; but this is one of those questions which will never be disposed of to the satisfaction of entomologists without long and careful breeding of the supposed varieties or species. Some authors, however, have certainly gone too far in regarding mere varieties of butterflies as entitled to specific rank; while others have erred more seriously in the opposite direction, by placing together perfectly distinct species as varieties. It frequently happens that species which subsequently prove to possess very important distinctive characters, have a much greater superficial resemblance to others than obtains between seasonal or otherwise dimorphic forms of insects which belong indubitably to the same species. But if a good species is sunk as a synonym or a variety, the next entomologist who considers it to be distinct will very likely overlook the previous notices, and describe it as new. We are constantly discovering that names which stand as synonyms in our books really belong to insects which have since been described as new under other names.

In taking leave of this extremely interesting book, we must congratulate Mr. Leech on having successfully brought to a conclusion a work which will hold a worthy place among the many valuable local butterfly faunas which have been published in England, of recent years, by Godman and Salvin, Moore, Trimen, Distant, and others.

W. F. K.

#### OUR BOOK SHELF.

*Rainmaking and Sunshine.* By John Collinson. (London: Swan Sonnenschein and Co., 1894.)

THE only object there can possibly be in giving a notice of this book is to warn intending purchasers of its contents, lest they be deceived by the title, and hope to find some account, more or less interesting, of the experiments that were made in America, a short time back, with the view of procuring a rainfall. This book has not even that recommendation. One has not much patience with weather prophets, who base their assertions on conjunctions of the planets, or some equally occult and absurd methods; but Mr. Collinson is in advance of all such vendors of nostrums. Not for him the uncertain, or partial, fulfilment of hazily expressed prophecies, not for him the long and careful study of signs and portents: he, himself, is the rainmaker, he is the dispenser of sunshine and cloud, he is gifted with the divine power that storms and floods and drought obey. Here is his own modest statement: "Thus when suitably placed as to residence, the results of his (the author's) action on magnets are certain to produce changes in the weather, and other effects, as interesting and useful, bearing on meteorological science generally. They are simply marvellous. Storms, floods, drought, &c., can be induced, on the one hand, and the prevalence of sunshine and warmth, in opposition to coldness and gloom, on the other. His action in this direction, judging from experience, could bring any district, and, indeed, the country generally, such favourable weather as would recall the glories of the Golden Age." (p. 18.) Another passage that makes one doubt whether the book is to be taken seriously, relates how a prophet (Query Dr. Falbe, says the author) foretold bad weather for March 28, 1893, sudden fall of the barometer, great conflicts of wind and water, and various other disasters. "About the same time Prof. Jenkins foretold that there would be a cyclone with snow on March 25. I took care that these storms did not happen." (p. 186.)

But there is one form of internal evidence which forbids us concluding that the author has perpetrated an elaborate joke. He claims to have given to a whole nation of holiday-makers ten days of enjoyable weather at Easter, but refused to exercise his godlike gift on behalf of suffering humanity at the following Whitsuntide, because "NO" (in very large capitals) "suitable sign of appreciation had then been received from any of those who largely benefited by the results of the fine Easter weather." (p. 214.) One would like to know what is the force of "then" in this sentence. Have the railway companies rewarded this gentleman since? And what would be a suitable sign of appreciation to a man so endowed? But enough of this nonsense; whoever else the book may amuse or edify, it will scarcely find readers among the subscribers to NATURE.

W. E. P.

*The Elements of Graphic Statics: a Text-Book for Students of Engineering.* By L. M. Hoskins, Professor of Pure and Applied Mechanics in the Leland Stanford Junior University; formerly Professor of Mechanics in the University of Wisconsin. London: Macmillan and Co., 1892.)

ALTHOUGH the fundamental ideas of Graphical Methods in Statics can be traced back to the writings of Stevinus,

of Bruges, 1600, and although they must have been employed by scientific engineers, such as Brunel, the subject of Graphical Statics as known to the mathematician dates only from Maxwell's writings on the subject, and to Culmann's elaborate treatise in German; also to Colonel Sir George Clarke's exhaustive work.

The subject of Statics, which had come to a standstill, was revived by the graphical methods now employed by every engineer and architect.

But as the subject is nothing unless employed practically by the draughtsman on the drawing board, it has not yet conquered the prejudices of the abstract mathematician, although many problems of allied descriptive geometry, required in the construction of inertia ellipses and curves (Part iii.), are well worthy of the attention of the pure geometer.

The present treatise is designed as an elementary textbook for the use of students of engineering; and the illustrations are drawn carefully to scale, representing each some real object.

The method of lettering, attributed to Bow, is now more appropriately assigned to Henrici; the author very rightly insists upon the fundamental importance of this lettering, in emphasising the reciprocity existing in the diagrams.

Incidentally the method of Graphical Statics emphasises the proper treatment of Statical problems, which is always to consider a system of balancing forces; and thus to banish the word Resultant from Statics unless employed to represent the force which if reversed will balance the remaining forces of the system. G.

*A Naturalist on the Prowl.* By Eha. Pp. 257. London: W. Thacker and Co., 1894.

*From Shooting to Fowl.* By "A Son of the Marshes." Edited by J. A. Owen. Pp. 239. London: William Blackwood and Sons, 1894.

THE author of "A Naturalist on the Prowl" knows how to write pleasantly on the natural history of the Indian jungle. There is not a dull page in his book. It is only rarely that we meet with a volume so full of interesting observations, and so free from stodginess. In "Eha's" company we travelled from the first to the last page, here admiring the keenness of his perception, there laughing at his humorous comments, and always made happy by his geniality. He does not "prowl" to kill, neither is he imbued with the spirit that induces many people to collect shells and postage-stamps as specimens; for though he recognises that "without a collection, a man's knowledge of natural history becomes nebulous, and his pursuit of it dettante," he also knows that there is a possibility of a man degenerating into a mere collector, and ceasing to be a naturalist. Mr. R. A. Sterndale enriches the volume with eighty illustrations, mostly sketched from life.

The works of "A Son of the Marshes," on country life and scenery, are renowned for their simple beauty and sympathetic expression. Under the editorship of Mrs. Owen, the volume before us, like other books by the same author, is delightful reading.

*Edible and Poisonous Mushrooms.* By Dr. M. C. Cooke. London: S.P.C.K., 1894.

It may be safely asserted that fewer kinds of fungi are used for food in Great Britain than in any other country in Europe. This is the more remarkable when we take into consideration the indebtedness of the present advanced state of Mycology to the researches of our countrymen, amongst whom may be mentioned Bolton, Sowerby, Bodham, Berkeley, and Broome. The author of the work under consideration has also contributed very materially to a knowledge of edible kinds of fungi by various publications, and more especially in promoting annual fungus fairs in various parts of the country.

Poisonous fungi liable to be confounded with the numerous edible kinds are very few in number, and the majority of casualties, both at home and abroad, are caused by eating *Amanita phalloides*, a fungus very different in appearance from the common mushroom (*Agaricus campestris*), but which, probably from its neat and attractive appearance and size, appears to commend itself to unsuspecting persons, and being usually very abundant and widely distributed, is likely to be a continual source of danger until its characters and general appearance are more generally known.

Dr. Cooke very properly condemns the various rule-of-thumb methods for discriminating between edible and poisonous kinds of fungi, and shows that the essential characters of the various kinds must be thoroughly grasped, as being the only certain means of identification; and this method, with Dr. Cooke's book as a guide, should not prove a difficult task. The written descriptions of the various kinds, without being technical, are very clear and to the point, and the eighteen coloured plates are excellent. Finally, the best methods of cooking are given. The book is well printed, attractive externally, and very cheap.

#### LETTERS TO THE EDITOR.

[The Editor does not hold himself responsible for opinions expressed by his correspondents. Neither can he undertake to return, or to correspond with the writers of, rejected manuscripts intended for this or any other part of NATURE. No notice is taken of anonymous communications.]

#### What are Acquired Characters?

FOR some while past, as we all know, a great contest has been raging as to whether acquired characters of an organism can or cannot be transmitted from one generation to another; and mighty authorities, on the one side, say that they can be; and great authorities, on the other, aver that they cannot be.

As a spectator of this contest, I have tried to understand it; and, in the first place, I have endeavoured to make out what is meant by the phrase "acquired characters"; or, in short, what is meant by the word "acquired," as used, in this connection, by Weismann, his friends, and his antagonists.

It is evident that the word is not used in its primary and natural signification: for, as on the theory of evolution (on which hypothesis the whole discussion proceeds), man has been evolved from an ameba or an ascidian, or some other early form, it follows that every character by which a man differs from this, his first progenitor has been acquired at some time between the two termini of the course of evolution, and, if the word were used in its ordinary sense, it would further follow that none of these characters could be transmitted by man to his offspring. This is manifestly untrue, for the issue of a woman is not simply an ameba. In fact, Weismann himself implies plainly that he does not use the word "acquired" in its ordinary signification, and asserts that its scientific value lies in its restricted use. ("Essays on Heredity," English translation, vol. i., first edition, p. 412.)

It becomes then very important to get at an accurate and workable definition of the word "acquired" for the purpose in hand; and such a definition must, I conceive, satisfy the following conditions:—(1) It must be such as to include all characters that are "acquired" within the restricted meaning of the word, and to exclude all characters that are not within the meaning; (2) it must be stated in physical, and not in metaphysical terms; (3) it must not be stated in terms derived from hereditability or the contrary, or in terms of any hypothesis or theory; (4) in order that it may be of use for scientific purposes, it must be stated in terms that admit of ascertainment and verification.

Of the importance of a clear definition of these words every one must, I think, be conscious; and if authority were required, we have that of Prof. Weismann himself. "I should wish to point out," he says, "that we ought above all to be clear as to what we really mean by the expression 'acquired character.'" ("Essays," vol. i., p. 169.)

Now, I do not profess to have read all that has come from the pen of Prof. Weismann, and still less the whole literature that

has gathered round the controversy; but, after some search, I have hitherto failed to find any definition which has satisfied me; and, furthermore, I do not feel quite sure that all the advocates and opponents of Weismann use the phrase in one and the same meaning; and my object in writing this, is to ask for some assistance in finding the real and true definition of the phrase as used by both sides in this controversy.

Let me, to assist in the discussion, refer to some of the hints for a definition which I have been able to find.

At pp. 98-99 of vol. i. of the "Essays upon Heredity" (English translation, first edition), Prof. Weismann, having referred to "modifications which appear as the direct consequence of some alteration in the surroundings," and to the effect of a strange climate, says: "It is difficult to say whether the changed climate may not have first changed the germ, and if this were the case, the accumulation of effects through the action of heredity would present no difficulty. For instance, it is well known that increased nourishment not only causes a plant to grow more luxuriantly, but it alters the plant in some distinct way, and it would be wonderful indeed if the seeds were not also larger and better furnished with nutritive material. If the increased nourishment be repeated in the next generation, a still further increase in the size of the seed, in the luxuriance of the plant, and in all other changes which ensue, is at any rate conceivable, if it is not a necessity. But this would not be an instance of the transmission of acquired characters, but only the consequence of the direct influence upon the germ cells, and of better nourishment during growth."

This passage hints plainly at a definition of acquired characters to this effect. An acquired character is one produced by an external stimulus acting on the organism but not influencing the germ cells, whilst every character produced by an external stimulus acting on the organism and influencing the germ cells would not be acquired. But how are we to ascertain whether the germ cells—not, be it observed, the embryo, but the germ cells—have been influenced? Is there any chemical or microscopic means of answering this question? Is this influence a physical fact capable of ascertainment, and if so, how? It seems almost as if the presence or absence of an influence on the germ cells respectively, were inferred from the capacity or incapacity of transmission. But if so, I can hardly suppose that any one would suggest that any light can be got from such a definition, for this would be to proceed in a circle, and to reduce the statement that acquired characters cannot be transmitted to the following identical and useless proposition, viz. characters which by experiment are found not to be transmitted, and are therefore said not to affect the germ cells, are not capable of transmission, i.e. characters incapable of transmission are incapable of transmission.

At page 170 of the same volume occurs a passage which seems to suggest a slightly different definition of acquired characters. "I am also compelled to admit," says our author, "that it is conceivable that organisms may exert a modifying influence on their germ cells, and even that such a process is, to a certain extent, inevitable. The nutrition and growth of the individual must exercise some influence upon its germ cells." But a little afterwards, p. 171, there occurs another passage which, if I understand it aright, throws doubt on this conclusion; but this I will for the present neglect. In other passages, e.g. at p. 406, our author refers to direct influence of an external stimulus, such as climate, intending, I conceive, to draw the distinction between direct and indirect influence of an external stimulus on the germ plasma. These passages appear to me to suggest the following propositions with reference to acquired characters, viz.: (1) Every change produced by an influence of the organism on its own germ cells is not an acquired character; (2) an external stimulus may act on the organism, and the organism on the germ cells, and so produce a non-acquired character; (3) every other change produced in an organism by an external stimulus is an acquired character.

But, assuming these propositions to be true, do they limit of ascertainment by any appeal to physical facts? Do we know by any examination—physical, chemical, or experimental—what influence an organism produces on its own germ cells? If we do, then these propositions may be useful, and acquired characters will be a category of changes capable of scientific establishment by the appropriate means of inquiry; but if not, then they seem useless, except for the purpose of propounding an hypothesis or theory.

At p. 169 of the same volume of "Essays upon Heredity," I

find Prof. Weismann saying: "An organism cannot acquire anything, unless it already possesses the predisposition to acquire it; acquired characters are therefore no more than local or sometimes general variations which arise under the stimulus provided by certain external influences"; and then he proceeds to illustrate this by saying that the so-called "exercierknöchen" or bony growth caused by the pressure of a weapon in drilling depends on the capacity of the bone to react on the stimulus. "Every acquired character is simply the reaction of the organism upon a certain stimulus."

It would not, I think, be just to consider that in the sentence last quoted, Prof. Weismann proposes a definition of an acquired character as being the reaction of the organism upon an external stimulus, because many passages in our author's writings, and certain well-known facts, seem to show that there are many reactions upon stimuli which result in heritable characters. Thus, at p. 406, he says: "Every one will agree with him (Delmer) that the periodical change of leaf in temperate climates has been produced in relation to the recurring alternation of summer and winter. This is certainly the case, and it cannot be doubted that this character has been fixed by heredity." Heat and cold are external stimuli, and here, if I understand rightly, they are credited with heritable changes in the organism.

Some passages in Prof. Weismann's Romanes lecture tend in the same direction. At pp. 10, 16, and 50 he deals with the case of geotropism, positive and negative; and, if I rightly follow our author, he alleges (1) that geotropism, or the habit of the plant to respond in some particular way to the force of gravity, was not an original character of plants; (2) that it arose, or, in popular parlance, was acquired when plants became attached to the ground; and (3) that it is inherited. Now if I apply to this what is, as I understand, taught by the Professor, I conclude that the physical characters which produce the habit are due to the concurrence of two things, viz. (1) the original predisposition and (2) an external stimulus, viz. gravity. From this it would seem to follow that if all "acquired characters" are reactions on external stimuli, yet some such reactions are not "acquired characters."

The more I look at the matter, the more I feel it impossible to suppose that all the reactions on external stimuli are "acquired characters." For when I consider the vast part played by air, food, heat, moisture, gravity, and light, all of which are external stimuli on the development of plant life, and as I gather from passages already cited from our author on the production of some qualities, such as size, colour, &c., which are familiarly known to be inherited, I feel it difficult to suppose that it can be thought that all responses to external stimuli are to be considered as incapable of transmission. If I try to arrive at a definition by drawing a distinction between the principal and the minor causes of a change in the organism, or by calling some things conditions and other causes, I succeed no better; for here I should be introducing metaphysical distinctions. There is, so far as I know, no physical or logical distinction between principal and minor causes, or between cause and conditions in the case of two or more constituent parts of a cause, each of which is necessary, and none of which is by itself sufficient.

But this line of thought carries me further. Prof. Weismann ("Essays," vol. i. p. 411) deals with the case of "spontaneous characters, such as extra fingers or toes, patches of grey hair, moles, &c.," which he says may be transmitted. But do we know (i.e. do men of science know) that no external stimulus has had anything to do with the production of, say, a mole? It is one thing not to know affirmatively that this is the case, and another thing to know that it is not the case. Is the distinction between characters which seem to be due to an external stimulus and characters which seem to be spontaneous, one which is the subject of accurate scientific knowledge? Seeing that we only know organisms when subject to stimuli, do we know what they would be or would produce without stimuli? Have we any scientific knowledge of the organic world as developed entirely *à priori* and independently of any external influence, i.e. of what plants and animals would be without light, heat, food, air? If we have not, then the distinction relied on may be perfectly true, but is of no value for scientific reasoning at the present day.

Then it has occurred to me to inquire whether I can make a safe distinction between the two kinds of change by reference to the development of the embryo. If a mole were to be found on the arm of a child at birth, we should be more inclined to

regard it as spontaneous, as due to no external cause, than if it appeared in mature life. The embryo in the case of a child is no doubt protected from many external stimuli; but surely in the case even of the placental mammalia it would not be safe to aver that the embryo is protected from all external stimuli. In the case of an insect, the greater part of its development takes place under an exposure to external influences as complete as that of the adult insect; in the case of reproduction by gemmæ of multicellular animals, the protection must, I suppose, often be small or nothing at all; and in the case of the reproduction of the lower plants from gemmæ or from protonema, or of the higher plants by buds or from suckers, the embryonic condition, if it can be spoken of at all, is, I suppose, hardly distinguished as regards the influence of external stimuli from any other part of the career of the organism; so that I find myself unable to reach clear ground for the distinction between spontaneous and non-spontaneous variations.

But there are passages, to one of which I have already referred, which seem to suggest that the definition should be framed by reference to a distinction between a direct and an indirect influence, and that the definition should run thus: an "acquired character" is a reaction of the organism upon the direct influence of a stimulus, leaving reactions upon indirect influences to be treated as non-acquired characters. If so, what is the precise meaning of the word "direct" as applied to the influence? Does it refer to the repetition of the stimulus—so that a single change of climate would be a direct, and a repeated change of climate an indirect influence? Or does it refer to the supposed difference between influences operating on the somatic part of the organism and those which the organism itself exerts on its germ plasma? If so, I ask how is this ascertainable as a physiological fact?

Another limitation on the proposition that the reactions of the organism on external stimuli are acquired characters, I find in the second volume of Weismann's "Essays on Heredity" (English translation, p. 14), where the author, having referred to the characters, such as shape and size of finger-nails, likenesses of features, bearing, gait, handwriting, which are handed down from parent to child, goes on to add: "Characters only acquired by the operation of external circumstances acting during the life of the individual cannot be transmitted." Now, handwriting must, I suppose, be conceived of as a thing dependent on external circumstances: it is influenced by the material on which, the fluid by which, the pen or style by means of which the act is performed; but here the external circumstances have operated during many generations; so that the passage seems to suggest these propositions, viz. the reactions of the organism on external stimuli operating during the life of a single individual are not hereditary: the reactions of the organism operating during the lives of two or more individuals are hereditary. But such is not, I suspect, really the meaning of the author: it would be inconsistent with what he says at p. 40 of the same volume, where he says that the supposed increase of the musical sense "in the course of generations" by the exercise of the art can only have occurred on the supposition "that these modifications of an organ which are due to the exercise during the individual life can be transmitted to offspring—a supposition which Prof. Weismann says "a close examination does not allow us to admit."

Another limitation on the class of reactions upon external stimuli constituting "acquired characters" is suggested by what I conceive to be Prof. Weismann's latest utterance on the subject, in his work "Das Keimplasma" (Jena, 1892). At p. 514 I find him saying: "By the term acquired characters I understand those which do not exist originally in the germ as tendencies, but first arise through peculiar influences which operate upon the body or particular parts of it. They are the reaction of these parts upon some external influences lying beyond the necessary conditions of development."<sup>1</sup> In the first of these sentences it seems to me that the Professor is not so much offering a definition as announcing a theory; for except by the inquiry whether the character is or is not heritable, I suppose that there is no means of ascertaining whether or not a change in the organism is due to a tendency in the germ.

But the second sentence seems to suggest a definition of "ac-

quired characters" free from many of the difficulties we have hitherto encountered. They do not include all reactions of the organism on external stimuli, but only such as lie beyond the necessary conditions of development. Everything then turns on the meaning of "necessary conditions of development." What are necessary conditions of development? Let us take a tree which has put forth its leaves, its flowers, its seeds, in usual fashion, but which, having lost a limb by the saw of the gardener, and has thrown out around the wound that growth of new wood and bark with which we are familiar. The air, the sun, the soil are all external influences, and all necessary conditions of the development which has actually occurred, and so was the saw of the gardener. If we take the development which has actually occurred, every condition which led up to it was necessary, and each was as necessary as the other. Take the case narrated by Sir James Paget, of a fir tree which for a hundred and fifty years threw out successive annular growths over the part of its trunk from which a large piece of bark had been stripped off. ("Address to the Pathological Section of the British Medical Association," 1880, p. 15.) Were these rings part of its development, or were they not? If they were, the knife or saw was one of its necessary conditions. Most persons will reply that the saw was no necessary condition of the development of the fir tree, and that those only were necessary conditions without which the fir tree could not have lived.

If we consider what are the necessary conditions for the development of the seed of the fir tree, we can probably ascertain them; but the doctrine of evolution and the doctrine of the non-heritability of acquired characters will carry us back further, viz. to the primordial organism, and we must ask what were the necessary conditions for its development.

If this organism were supposed to have in itself a pre-existing law according to which it sought development, a contingent destiny inherent in its nature, then I can well understand how the conditions which satisfy that contingency, the circumstances which allow of that development might be said to be necessary to it. But if the organism have no such law and no such destiny, but instead thereof has only a capacity to vary in every possible direction, and if all the course of its actual variation be due to external circumstances operating by means of natural selection, then it seems to me that no one external thing can be said to be more essential to its development than another. The germ might have found itself in a different soil, in a different climate, exposed to different air, and then the development of the germ would have been different. There was no *a priori* necessity that it should be exposed to the particular conditions to which it was, in fact, exposed, or to any other particular conditions. If, therefore, we start from the actual development of an organism, and look back on the past, all the conditions which have led to its existing state are necessary; if we start from the germ prior to all development, and look to the future, then no given condition can be said to be necessary to its development, but all are contingent.

It is suggested that no influence lying beyond the necessary conditions of development can at any time have produced any heritable character, however long may have been the course of development. It seems, therefore, that in order to ascertain what conditions are necessary to development, we must go back to the amoeba or ascidian or other primordial parent of our race, and we must conclude that those characters only will be transmissible by the human parent, which were reactions on the necessary conditions of the development of the primeval ancestor. Have we any scientific means of ascertaining what these conditions were, and so of ascertaining what characters are now heritable? Nay, if we adopt the evolutionary hypothesis, and believe that at least all existing animal organisms have sprung from a single parent, do not the diversities of the existing forms show that no one set of external circumstances were necessary conditions of development, but that the conditions consistent with development were infinite, or all but infinite, in number?

A further difficulty arises in my mind from a passage on the next page (p. 515), where I find our author mentioning wounds and mutilations as constituting one category of acquired characters. It is difficult to reconcile this with the statement of the Professor, in several passages, that acquired characters are reactions of the organism; for surely a wound is not a reaction of the organism, whilst the growth of the organism consequent on the wound—e.g. the growth of new wood

<sup>1</sup> It may be noted, in regard to the passage in the original, "Entwickelungen haben Eigenart, die nicht durch die Wirkung der äußeren Einwirkungen, sondern durch die Keimbahn bedingt ist." The English translation here is "Entwicklungen, die durch die Keimbahn bedingt sind," which is not quite correct. The original text is "Entwicklungen, die durch die Keimbahn bedingt sind, sind die Reaktionen der Keimbahn auf die äußeren Einwirkungen oder notwendigen Entwicklungsbedingungen." The original text is in German.



and bark round the stump of a branch sawn off, is a reaction of the organism on the action of an external influence. It seems, therefore, fair to suppose that when our author speaks of a mutilation as an acquired character, he means the growth of the organism consequent upon the mutilation. But if so, a difficulty appears to arise; for the tendency to repair a wound is heritable, and therefore it seems difficult to suppose that the Professor would treat of it as not heritable. It may be said that the parent has the actuality of the repair, the child only the possibility of repairing; but this is, I suppose, all that can ever be expected of inheritance as applied to contingent reactions—i.e. reactions which only arise under peculiar circumstances. There can, I suppose, be no more characteristic heritable reaction than that of the pollen on the ovule, and of the ovule on the pollen; these reactions have taken place in the parent plant, but in the offspring they are originally potentialities, tendencies, contingencies, and they are converted into facts in the event, and in the event only, of the meeting of the pollen and the ovule.

Or take, again, the secretion of the gastric juice in response to the presence of food in the stomach. The parent has taken food, and the reaction has taken place; but the infant inherits, I suppose, the capacity to secrete and not the counterpart of the actual secretion of the parent.

It would seem that there is no essential difference between these three cases. The parent transmits the power to repair a wound, but not the actual reparation of a wound; it transmits the power of fertilisation, but not the fertilised ovules; it transmits the power to digest, but not the already secreted gastric juice.

The emphasis which Weismann has laid on the case of wounds and mutilations would suggest that his doctrine might be thus paraphrased: when an organism is endowed with a capacity, or, to use his word, a predisposition, to react in response to given stimuli, and has so reacted—then what the organism transmits to its progeny is the capacity or predisposition, and not the actual result of the reaction.

It is impossible to doubt that some characters of an organism are hereditary; that others are not, and that the ascertainment of the dividing line between the two classes is of the highest moment to the study of biology; and to Weismann we owe a debt of gratitude for having called pointed attention to this matter. I have at times been tempted to wish that men of science had applied themselves to ascertain the two categories of characters, and then by a careful induction had proceeded to learn the law of heredity without regard to any hypothesis or theory—without reference to germ or soma. But this is not the course which in fact has been taken; and therefore it seems highly necessary to inquire what is the precise meaning of the terms of the proposition affirmed by the one side, and denied by the other.

I conclude this, I fear, too lengthy paper with two questions: (1) Are the conditions which I have suggested as essential to a good definition correct ones; if not, in what are they erroneous? (2) What is the true definition of the words "acquired characters" in the present controversy which satisfies these conditions?  
EDW. FRY.

### Discontinuous Motion.

THE old theory of the motion of solid bodies through a frictionless liquid supposed that the liquid flowed according to the electrical law of flow. This theory was found to be unsatisfactory, because it makes the pressure negative when the velocity of the solid exceeds a certain critical value.

The theory of discontinuous motion removes the above objection, but is open to others of a different kind. Assuming for the sake of argument that the two theories give correct results when the velocity of the moving solid is respectively less and greater than the critical value, the theory of discontinuous motion ought to be capable of explaining the transition from one kind of motion to the other, and how and why it is possible for a vortex sheet to be called into existence when the critical value of the velocity is exceeded.

Although vortex sheets and other motions involving molecular rotation cannot be generated in a frictionless liquid by a conservative system of forces or by operations performed on the boundary, yet it is easy enough to produce such motions by ordinary mechanical agencies. If a mixture of ice and water be stirred up and the ice allowed to melt, the liquid will

acquire molecular rotation owing to the presence of the particles of melted ice, even though it is absolutely devoid of viscosity. So also if liquid at rest were separated by an indefinitely thin horizontal plate, and the upper liquid were set in motion with horizontal velocity  $V$  and the plate were removed, the surface of separation would be a vortex sheet. But the production of motions of this kind requires methods of a somewhat artificial character, and it is difficult to see how they could be set up by a solid whose velocity is allowed to increase gradually from zero to some magnitude greater than the critical value. In fact, I entertain very little doubt that the final motion of the liquid would be quite different from what the theory of discontinuous motion would indicate.

There is, however, a further point, for there are strong grounds for believing that vortex sheets are unstable. No general proof of this proposition appears as yet to have been given, but in every case that has been examined the theorem has been found to be true, (i.) when the liquids on either side of the sheet are identical, (ii.) when the densities of the two liquids are different, but no bodily forces such as gravity and the like are in action. If, therefore, steady discontinuous motion existed at any particular instant, the probabilities are that the motion would be unstable, and the region of dead water in the rear of the moving solid would break up and be changed into a region of turbulent motion. The pressure in the rear of the solid due to this turbulent motion would be different from that of the dead water, and it is therefore not surprising that the theory of discontinuous motion should furnish results which do not agree very well with experiment.

We must also recollect that a frictionless liquid is an ideal substance which does not exist in nature. All fluids are more or less viscous; and it is just at the point where the pressure would otherwise tend to vanish and change sign that we should anticipate the effect of viscosity would appear, and prevent this state of things from taking place; and I believe that many of the difficulties which have arisen in connection with this subject are due to the fact that the effect of viscosity has been overlooked. A vortex sheet cannot exist in a viscous liquid; and if by any artificial means one were produced, it would immediately disappear, and molecular rotation would be propagated into the surrounding liquid. On the other hand, in a viscous liquid, molecular rotation requires no artificial means for its production; for a viscous liquid cannot move without molecular rotation, except in the single case in which the liquid moves like a rigid body having a motion of translation alone. In all other cases, if irrotational motion existed at any particular instant, the motion would immediately cease to be so, and molecular rotation would instantaneously be generated.

Unfortunately the equations of motion of a viscous liquid are so intractable that very little progress has been made in applying them to the solution of hydrodynamical problems. By means of Oberbeck's solution (*Borchardt's Journal*, vol. lxxx.) for the steady motion of translation of an ellipsoid in a viscous liquid, it can be shown that the above difficulties do not arise when viscosity is taken into account; but since the integration of the equations of motion proceeds upon the assumption that the squares and products of the velocities may be neglected, the solution is inapplicable except in the case of slow motions like those produced by the small oscillations of pendulums. The solution gives no information as to what will happen when a disc is moving through a liquid with a velocity of several feet per second.  
A. B. BASSET.

Fleborough Hall, Holyport, Berks.

### Capacity for Heat.

IN the course of some writing upon which I am now engaged, I have constantly to refer to the *capacity for heat of certain substances as compared with the capacity for heat of an equal volume of water.*

The phrase given in italics is a most clumsy one, but I know not how (accurately) to convey the same idea in a shorter way. "Capacity for heat of unit volume" has been suggested; but I think that a little reflection will show that it does not express accurately the exact meaning.

*Specific Heat*  $\times$  *Specific Gravity* gives the numerical value required, but cannot be regarded as a definition. There can be no doubt but that a concise expression is wanted. In calorimetry it is often of greater importance to the experimenter to consider the capacity for heat of volumes rather than the capacity

of masses. In the course of a communication which I made to the Physical Society of London, at their last meeting, I appealed to the Fellows present to supply me with the missing phrase. In the discussion which followed the paper, this matter was only incidentally referred to; but, although I think that there was a general agreement as to the want, unfortunately the meeting closed without coming to any conclusion as to the best method of supplying the deficiency.

Will some of your readers help me in this matter?

12 Park Side, Cambridge.

E. H. GRIFITHS.

#### The Swallowing of One Snake by Another.

THE snake incident, described in NATURE, October 25 last, page 620, as having occurred in the reptile-house in the Zoological Society's menagerie, recalls to my mind two similar cases, recorded in the same periodical, vol. XXV. July 3, 1884 ("A Cannibal Snake," by E. H. Evans), and July 31, 1884 ("The Swallowing of One Snake by Another," by C. R. Osten-Sacken). The first case was observed in Java, the other was witnessed by me in Washington, D.C. In the latter case one of the snakes, although three-quarters of its length had already been engulfed in the other, succeeded in getting out, apparently unharmed, as it remained alive and well in the cage a long time afterwards.

In the *Figaro*, July 26, 1894, I found still another instance of the same kind, which happened in the Jardin d'Acclimatation in Paris. A large snake, while attempting to swallow a rabbit, was interfered with by another one, and passed with the rabbit into the body of its comrade of captivity ("L'un des deux passa à la suite du lapin dans le corps de son camarade de captivité"). C. R. OSTEN-SACKEN.

Heidelberg, Germany, October 28.

#### ON RECENT RESEARCHES IN THE INFRARED SPECTRUM.

I PRESENTED to the Association in 1882, at Southampton, an account of some researches made by means of the bolometer, in the infra-red spectrum, formed by a glass prism; but though these labours have continued with occasional intermission during the past twelve years, it is for reasons, which will be explained later, only within the past three years that any notable advance has been made, and only within the past twelve-month that such a measure of success has been attained as justifies the present communication.

This is not the time to give any historical account of discovery in the infra-red, but all those interested in the subject know that the first investigator here was Sir William Herschel, whose observations consisted essentially in finding that there was something which the eye could not see in a region which he proposed to call the "thermometric spectrum." His distinguished son, Sir John, made a curious anticipation of later discovery by indicating, though crudely, that this invisible heat was not uniformly distributed, and a similar conclusion was reached in an entirely different manner, through the thermopile, by the too early lost Melloni. So ignorant, in spite of these investigations, of those of the elder Draper and of the elder Becquerel, were we till lately, that when, quite within my own recollection and that of most of you, Lamansky in 1871 published, from his observations with the thermopile, a crude little illustration showing three inequalities in the energy curve, universal attention was excited by it among those interested in the subject.

Among other minds my own then received a stimulus which turned it in this direction, and having, as it seemed to me, exhausted the capacities of the thermopile, I invented an instrument for continuing the research, which was afterwards called the bolometer, and with which, in 1881, at an altitude of 14,000 feet upon Mount Whitney, I found spectral regions hitherto unreachd, and whose existence had not been suspected.

I returned with a strong impression of the prospective importance of this discovery, and laboured at the Allegheny Observatory in improving all portions of the new method of research, especially of the bolometer and its adjuncts, with the twofold object of obtaining greater sensitiveness to heat, and greater precision in fixing the exact point in the spectrum where the change of heat originated. With the former object such a degree of sensitiveness was at that time reached, that the bolometer indicated a change of temperature of  $\frac{1}{100,000}$  of a degree Centigrade, and with the latter, such precision that it was possible to fix the relative position of a line, not merely with a possible error of a considerable fraction of a degree, such as Lamansky's determination is evidently subject to, but with a certainty that the error would be within a minute of arc. The range of the apparatus in wave-lengths was almost unlimited as compared with any other process, and both its sensitiveness and its possible precision seemed to be at that time notable as compared with previous methods, for a great advance was made on anything done before with the thermopile, when the presence of the well-known "D" line of sodium was rendered sensible (though barely sensible), even as a *single* line, by the change of temperature. The sensitiveness was also, as has been said, accompanied with the possibility of unusual precision. The results of this labour were laid before the British Association in the communication already alluded to, and which exhibited ten or twelve inflections of the curve in the portion till then almost unknown, which extends from a wave-length of  $0.7\mu$  to a wave-length of nearly  $3\mu$ , at which point the glass prism then used became wholly opaque to radiation. The positions of these inflections were fixed with a precision quite impossible to the thermopile, but this exactness was only obtained in practice by a process so slow as to be almost prohibitory; and with this apparatus the writer personally made in those earlier years such a number of observations as he hardly likes to recall, so disproportionate did the labour inherent in this method seem to the final result.

The justification of this labour seemed to lie in the fact that it does not appear that photography has ever rendered anything much below a wave-length of  $1\mu$ —anything, at least, which has been reproduced for publication in a way which gives confidence that we are in touch with the original. The processes which involve the use of phosphorescent substances have given some indications of lines considerably below  $1\mu$ , but it is safe to state that the work which has just been referred to as communicated to this Association in 1882, presents almost the only indications which we have possessed, even up to the present time, about the lower infra-red solar spectrum.

Now the curve which was given, even in the later Allegheny observations made with the rock-salt prism, contained but a dozen inflections below the wave-length of  $1.5\mu$ , and these inflections, with their correct prismatic and wave length positions, represent, I think, most of our present knowledge in these regions even to-day.

To understand the method by which these were attained, but only at this great cost of labour, results till then unreachd, it may be repeated that the bolometer had been rendered more sensitive than the thermopile, but that it was capable of being pointed and its position in the spectrum being measured, only by a tedious process which has been exclusively used till lately (but which that presently to be described advantageously replaces). Whichever process is used, when the bolometer thread touches a cold line in the spectrum (since what is black to the eye is cold to it), a larger current flows through the galvanometer, and the spot of light marking the needle's motion is deflected through a certain number of degrees.

From this point forward, the new process, whose results I am about to have the pleasure of bringing before

Appreciated by Section A of the British Association, at the Oxford Meeting, 1882, and by Section P, Langley.

you, differs widely from the old. In the old, two observers at least are engaged: one, who notes that reading of the micrometer or of the vernier, which fixes in angular measure the exact part of the spectral region whence (though nothing is visible) a thermo-electric disturbance has proceeded; and another, who simultaneously notes through how many divisions of the scale the spot of light from the galvanometer mirror is deflected by the same electric disturbance. The process may be compared to a groping in the dark, and it was only by these means that the considerable inflections of the energy curve much below the region about  $1\mu$  were then fixed by the bolometer, by being gone over again and again, with what seemed almost interminable repetition, and which did in fact call for over a thousand galvanometer readings to obtain the position and amount of each single inflection of the energy curve, with the degree of accuracy which was then obtained, and which was shown in the former memoir.

If it took two years to fix the position of twenty lines by this process, it would take two hundred years to fix two thousand, supposing they existed, and it became evident that if the bolometer continued to be the only means available, new and more effective methods of using it must be found.

#### *New Methods.*

About ten years ago a plan was first studied, which has ever since been maturing, by means of which this work could be carried on, not only with far greater rapidity, but with greater certainty, and by an automatic process. The idea in its original simplicity is very easily understood.

In the old process, just described, the deflection of a spot of light upon a scale was read by one observer, while another read simultaneously the position in the spectrum of the cold band, or line, which caused the thermo-electric disturbance.

Now, in imagination, let us take away both the observer at the circle and the one at the galvanometer, and, in the latter case, remove the scale also, and put in its stead a photographically sensitive plate. As the needle swings to the right or left, the spot of light will trace upon the plate a black horizontal line whose length will show how far the needle moves, and how great the heat is which originated the impulse. If this be all, when (under an impulse originated by the movement of the spectrum over the bolometer thread) the needle swings a second time, it will go over the same place; but if the plate have a uniform vertical movement, proportional to the horizontal movement of the spectrum, the combination of the two motions of the needle and the plate will write upon the latter a sinuous curve which will be, in theory at least, the same as the curve formerly deducible only with such pains from thousands of such galvanometer readings.

If we suppose that the movements of the invisible spectrum over the bolometer thread are controlled by clockwork so that this spectrum is caused to move uniformly, and that three movements are, by accurate mechanism, rendered absolutely synchronous with those of the moving plate, it is clear that we shall be able to readily deduce from the photographic curve traced on the latter, not merely the amount of the heat, but each particular position in the spectrum, of the thread of the bolometer, which alone can correspond with any given inflection of the curve.

Thus simple is the theory; but no one had better occasion to know how difficult the practice would be, than myself.

The researches by the old method, and the early attempts to improve them, were interrupted by my acceptance in 1887 of a position which implies the administrative charge of different branches of the public

scientific service and of duties largely incompatible with original research. What time could be spared from these was, however, partly employed in elaborating the plan of investigation just referred to. An appropriation had been asked of Government for the establishment, on a modest scale, of an astro-physical observatory in Washington, whose first work should be the investigation of the whole infra-red solar spectrum, by some means which would open that great region to knowledge. It had been asked of Government because it seemed that such knowledge, if attained, might teach us facts about the sun and the absorption of its rays by the terrestrial atmosphere, which there was ground to hope would ultimately lead to results of such importance as to justify this national aid.

These observations were resumed in 1890 on the new system, with the aid of the Smithsonian Institution, which provided larger and more efficient apparatus, whose design embodied the results of nearly fifteen years' study of these subjects.

Pending the provision of a suitable observatory building, an inadequate and temporary one was erected in the Smithsonian Park in Washington, to shelter the apparatus, presently to be mentioned, with which it was designed to commence work while making provision for more permanent scientific quarters (which I may add are still lacking).

#### *Apparatus.*

The Foucault siderostat, perhaps the most powerful instrument of the kind existing, was originally made by Sir Howard Grubb, of Dublin, from my indications; but its dispositions have since been considerably modified. A beam from its 20-inch mirror is conveyed through the slit of a horizontal collimating telescope having a rock-salt objective of nearly seventeen centimetres aperture, and of ten metres focal length, to the prism or grating. The prism is of rock salt of corresponding dimensions, worked by Brashear with the precision of, and presenting all the external appearance of, one of flint glass. It is mounted on a massive spectro-bolometer (as the instrument which supports the prism or grating used in producing the spectrum is called). This instrument includes a large azimuth circle, over the centre of which the prism is placed, and it also carries the bolometer, which registers the spectral heat. The focal length of the image-forming lens, or mirror, is in this instrument much greater than in the first one used, and all parts of the apparatus are correspondingly increased in size and stability. The most important and novel feature is, however, the mechanical connection of the large azimuthal circle carrying the prism, with a distant photographic plate, susceptible of vertical motion, and which latter takes the place of the scale formerly in front of the remote galvanometer, both circle and plate being moved by the same clockwork, which is of such steadiness and precision as to make the two movements as far as possible perfectly synchronous.

To fix our ideas, let us suppose that the slow-moving azimuthal circle carrying the prism revolves through one minute of arc in one minute of time; in which case the spectrum will move horizontally across the vertical bolometer thread at a proportional rate. Now, if the same mechanism which causes this circular motion of the prism, and of the spectrum, of one minute of arc in one minute of time, causes the photographic plate to move vertically before the galvanometer mirror at the rate of one centimetre of space in one minute of time; if there be no allowance to make for changes of temperature in the prism or for like corrections, if the mechanic has done his part in such perfection that everything works as it should, it obviously follows that, under such conditions, during every second of this minute a portion of the spectrum represented by the small quantity of one second of arc, will have glided before the bolometer thread, and

that during this same second the plate will have been lifted automatically through one-sixtieth of a centimetre of space.

This is one relationship of time and space in actual use here, though others may be established by the use of the change-wheels with which the apparatus is provided. The essential thing is that the plate shall show with great precision, and even on simple inspection, not only the inflections of the energy-curve there written down, but the exact relative position in the distant spectrum which the bolometer thread occupied at the moment it caused the disturbance. In the case assumed, for instance, if we suppose that the record on the plate commences with the part of the spectrum whose angular value is  $40^\circ$ , then, since 1 millimetre corresponds to 6 seconds of arc, and so on, the existence of an inflection on the plate at 30 centimetres, 3 millimetres and seven-tenths of a millimetre, would show that the disturbances originated at the point in the spectrum corresponding to an angular measure of  $40^\circ 30' 22''$ .

If the arm which carries the bolometer is  $n$  metres long, and if the thread of the bolometer is  $\frac{1}{m}$  metres in diameter, the angular value of the bolometer thread is  $\frac{1}{mn}$ . At present the linear width of the bolometer thread

is not very materially less than formerly, but it is used with a longer arm, and its virtual width is accordingly less. In present actual practice (to use round figures) the optical arm carrying the spectrum across the bolometer, is five metres in length; and if the bolometer thread be one-twentieth of a millimetre in width, its angular value is evidently  $\frac{1}{100,000}$  of the radius of the circle in which it moves, or a little over two seconds of arc. When the heat is distributed over so large an area, that part of it which falls on a thread of given diameter is, of course, proportionately less, so that the greater precision of measurement demands a more sensitive construction of the bolometer, as well as a more accurate mechanism for pointing it. Improvements have accordingly been introduced in the construction of the bolometer, and a need for greater sensitiveness in the galvanometer has necessarily gone with them. This increased sensitiveness has caused increased liability in the latter to both systematic and accidental perturbations, and the elimination of these has been found the most formidable difficulty of the whole process. It has been effected, largely, by placing the whole apparatus under constant temperature conditions.

I take pleasure also in acknowledging the advantage I have found in using both Prof. Boys's quartz threads and the extremely small mirrors which he, I think, first advocated in connection with the well-known form of galvanometer due to Lord Kelvin. These and other collective improvements made in the bolometer and in the galvanometer, have now made the former sensitive to changes of temperature in its strip which are demonstrably less than  $\frac{1}{1,000,000}$  of a degree Centigrade.

These are the principal pieces of apparatus, though I should mention that a method has been found by which the very large salt prisms used can be preserved in perfect polish while exposed to all the usual casualties of observation. The actual prism in most frequent use was made from a block of salt exhibited at the World's Fair by the Russian Government, and presented to the Smithsonian Institution by its Commissioners. It is about eighteen centimetres, or over seven English inches, in height.

Before entering upon a description of the results obtained, I desire permission to speak of the aid I have received from the gentlemen whose assistance I have been fortunate in securing: first, to Dr. Hallock, then to Prof. Hutchins, Mr. Hubbard, and Mr. C. T. Child, and

lately to Mr. F. L. O. Wadsworth and Mr. R. C. Child; the imprint of the labours of the two latter gentlemen being upon almost all the details of the more recent work.

#### Results.

Let us recall that the infra-red spectrum from a rock-salt prism, such as that used here, is extremely contracted as compared with one from flint, and still more contracted as compared with the wave-length scale. The portion of the spectrum presented by photography reaches a little below the band whose wave-length is about  $1\mu$ , and this was asserted by one of the most eminent living authorities on the subject (Dr. John W. Draper), when the writer commenced this work fifteen years ago, to be the absolute end of the heat spectrum. The writer has, however, since carried his investigations by direct measurement to five or six times this wave-length, and by indirect measurement much farther still, though what is here now exhibited does not go beyond a wave-length of about  $4\mu$ . The invisible heat spectrum of a  $60^\circ$  rock-salt prism through this great wave-length, includes only somewhat less than two degrees of arc, and the first of these degrees contains the greater proportion of the energy.

On referring to the illustrations exhibited to the Association in 1882, or even to later publications of results obtained by rock-salt prisms, though with the old method, it will be seen that there are shown in the latter publication about a dozen measured inflections of the energy curve below  $1\mu\cdot5$ , and it may be remembered that this curve was obtained only by two years' assiduous labour.

We have now before us three energy curves obtained by the new method, each exhibiting the whole infra-red spectrum under examination, with about a hundred inflections. These curves are nearly, but not exactly, similar.

The three were obtained in the same day, each from an entirely independent observation, so that each has given, in a fraction of a day, many times the results previously obtained by two years of labour, and, as it will be later shown, has given these results with a notable gain of accuracy.

But this is not all. These three curves have been taken with a rapid movement of the clockwork and a brief swing of the galvanometer, so as intentionally to suppress all minor inflections and to introduce only the leading features of the spectrum, as shown in eighty or a hundred of the leading inflections (lines), or groups.

This new bolometric method has, however, as will be shown later, a capacity of resolving these into nearly twenty times that number, the minor inflections having been thus designedly suppressed here at first, to better show the character and position of the principal ones. All these energy spectra, by the new as by the old method, are, of course, subject to the slight changes due to invisible clouds constantly passing before the sun, which, with the change of the sun's altitude, and of the consequent lengthening path of its rays, prevent any one of them from being exactly like the other; while, at the same time, everyone here may satisfy himself by direct inspection of the results before him, that there is scarcely any single one of their inflections which is not reproduced in the other two, in exactly the same place, though probably not exactly in the same degree; and when we take different spectral traces, made at different hours of the day, and even on different days of the month—traces which are absolutely independent of each other—and superpose them, experience shows that we may expect to see such an agreement as that in the three here chosen at random for illustration, or in the more detailed one, where the relative probable error is less than one second of arc. Three such traces only are here given (to prevent confusion), but if we follow these coincidences through

not three, but ten or more plates, we may well judge (since there seems no possibility here of systematic error, that a result, which all confirm, is reliable, and that, on the other hand, a single inflection on one plate, which the other nine unite in repudiating, is due to some fortuitous cause.

But there is still a higher certainty to be obtained, by a method independent even of comparison or the exercise of judgment. It is founded on the well-known process of composite-photography, where, in photographing the successive members of an assemblage of persons, having similar general characteristics, as of race, character or education, the individual disappears, and the normal type alone remains. In order to apply this method to such results as ours, however, another step in the process must be introduced, and this is an interesting one, for the energy curve itself, however valuable, is a comparatively unfamiliar method of showing variations in the energy, which we are all alike used to seeing in the visible spectrum given by linear representations, and not by a system of inflections.

In describing this new step, which is to give us a linear spectrum in addition to the original curve, it will be desirable to also give evidence of the statement now made, that the present method is capable of recording far finer inflections than those shown in the curves here exhibited, which, as has just been stated, have been taken only for the purpose of illustrating such more important features, as can be seen and verified by the audience, and especially for showing the agreement of independent observations. The evidence of the capacity of the apparatus to show this detail will best be illustrated by applying our purely thermometric method to some well-known lines in the visible spectrum, such as the familiar "D" lines of sodium. I have already stated that ten years ago the bolometer was barely able to distinguish this as a *single* line. At the present time our little thermometer, as you here see, now shows not only the two "D's" as separate lines, but the nickel line between them. First we have the complex energy curve (Fig. 1), where we see successively the inflections due to the motions of the galvanometer caused by the cold in  $D_1$ , then to the smaller chill from the nickel line (aided perhaps by that from some of the close atmospheric lines), then the chill from  $D_2$ .

Immediately below this curve is the more familiar linear representation of the same subject (Fig. 2). Now this linear representation, it is most important to observe, has been obtained, not by drawing, but by the subsequent application to the curve of an automatic process, by means of which its indications are reproduced by photogravure, as separate lines, while by the same automatic process the most complex spectral curves can be rendered into their linear equivalents.

I have no space to enter here on a description of this process, further than to say it is effected by means of a systematically distorted image of the curve, obtained by a special combination of spherical and cylindrical lenses. You will see, on minute inspection, that the inflections of the galvanometer curve have been slightly "loaded," to produce a more effective contrast of light and dark. Except for this, which can in no way affect the position of a line, but only its intensity, the whole process is as absolutely automatic as any photograph of the visible spectrum.

This thermograph of the "D" lines has been chosen to indicate the grasp of this new thermometric method, by applying it to the test of an object in the visible spectrum, with which every physicist here is doubtless familiar. He may then be invited to recall that the distance between the "D's" in a rock-salt 60-degree prism is about eleven seconds of arc, and to observe that two lines about half this distance apart are here shown

as sharply divided by this thermal method, as, for instance, are the components of the double star  $\alpha$  Geminorum by a three-inch achromatic. Obviously, then, our method could indicate the existence of two lines, little, if any, more than one-quarter the distance between the "D's." Lines 3 or less apart can then evidently be indicated by this method, even in its present stage of development.

And now, returning to what has been said about the evidence obtainable as to the perfect coincidence of these inflections in different energy curves obtained at different times, and to the consequent evidence that each inflection so given is real, and not the product of an



FIG. 1.

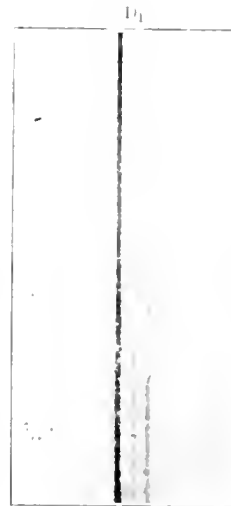

FIG. 2.

accidental variation in the curve, we may conceive that from any number of such independent curves, any number of such linear representations of the spectra have been obtained; for example, that ten such linear representations of the whole spectrum as are here given of the D lines only, have been so found from ten complete energy curves taken on as many different days. From these ten linear representations, by the well-known processes of composite photography, one final photograph of the spectrum is formed, and on this it is evident we may expect to find only what is permanent and not what is accidental, granting that a rare accident may have introduced an occasional abnormal deflection.

Now, considering that the part of the infra-red solar spectrum of rock-salt under review extends through

nearly 1.0 degrees, or 72.0 seconds, and that we have just seen by the illustration of the D lines that lines 3 inches apart can be thus divided; we may see for ourselves that, at any rate, over 2000 lines, if they exist, can be mapped. But these lines do exist, the whole of this new region being apparently as intimately filled by them as the visible spectrum by the Fraunhofer lines. In further evidence of this, here is a portion of the lower spectrum in the comparatively unknown part extending from  $\lambda = 1.4\mu$  to  $\lambda = 2.2\mu$  including the great band  $\Omega$  shown as a single inflection in my first communication to this Association, but here resolved into thirty or more subordinate lines (Fig. 3). This illustration includes a part of the new region discovered on Mount Whitney in 1881; and in the small portion here exhibited, you may see that about 200 lines are discriminated.

I am now trying to bring what may be called the first stage of the long labour, a portion of which is here described, to a close, this first stage consisting

the expense of the invisible, nor even on such a logarithmic one as that proposed by Lord Rayleigh, but on a conventional scale, which I will ask you to tolerate, as it is simply meant to show the actual extent and importance of the region covered here as compared with that known to Newton. In this illustration, with which I close my remarks, the mean dispersion throughout the invisible rock-salt spectrum, as far as  $4\mu$ , is taken as the standard, and both spectra are laid out on that common scale. On the left is the visible spectrum known to Newton; next this, is the region known through photography, now extending a little beyond the band,  $\rho\sigma\tau$ , which marks what at the time these researches were commenced, was considered by the then most distinguished investigator, in the infra-red, the end of the heat spectrum. Beyond, and on the right, is a part of the new regions of the spectrum developed by the bolometer, and of which charts may be shortly expected on the scale of which a specimen in detail has just been shown.

I cannot close this statement without expressing the

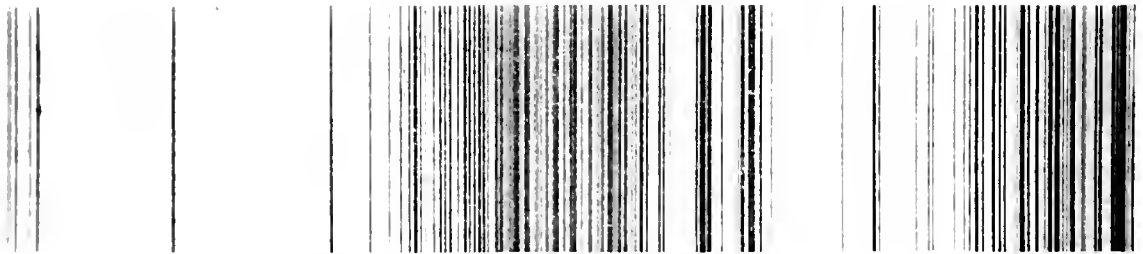

Fig. 3. Photograph of a portion of the infrared solar spectrum lying between wave-lengths  $1.4\mu$  and  $2.2\mu$ .

chiefly in the discovery of, and mapping the relative positions of new spectral lines.

I will only refer to what it seems to me the second part of this work is likely to be, and to the different kind of interest which may not improbably belong to it, from that which belongs to this, the first.

We are thus far in the position of early students of the visible spectrum, who simply drew the lines they saw, without regarding into their meaning. Nevertheless, to have discovered and mapped a great number of these lines is only a beginning, for their real value lies in their interpretation, and this is still chiefly to come. As to the possible importance of this interpretation, it is so enough to remind ourselves that three-quarters of the whole energy of the sun exists here, and not in the upper spectrum. We must remember also that while, as a rule, in the upper and visible spectrum a great proportion of the lines are caused by absorption in the solar atmosphere, and a perhaps smaller portion by telluric absorption, here, on the contrary, we are led, by everything we already know, to expect that the great telluric absorptions on which meteorological predictions and other immediately practical interests depend, may be expected to be found, and it is on the comparison of these energy curves taken at different periods of the year, and at different altitudes of the sun, that those who are engaged in the work see good cause to hope for important results in the future.

Before I conclude, let me present a collective view of the method by which work has been going on in these later years at the Smithsonian Observatory, on the same scale, with the visible spectrum. I say "on the same scale," meaning, not on a wave-length scale, which expands the invisible at the expense of the visible, and not on a prismatic scale alone, which expands the visible at

gratification with which I have laid it before the same body that listened to that made on the same subject twelve years ago, or my sense of my good fortune, in doing so before an audience in which I recognise many of the same eminent men who so kindly received that first presentation of these researches.

#### THE TREATMENT OF DIPHThERIA BY ANTI-TOXIC SERUM.

FOUR years ago Prof. Behring published his remarkable paper "On the mechanism of immunity against experimental diphtheria in animals." In this memoir the author stated that it was possible to immunise animals against the diphtheria bacillus by the injection of cultures attenuated by heat or the addition of 1 in 500 trichloride of iodine to the cultivating medium. The same result could be obtained by the inoculation of the pleural exudation of animals dead of experimental diphtheria, or by the injection of chemical compounds, such as trichloride of iodine, after inoculation of virulent diphtheria bacilli.

Behring's most important discovery, however, was that the serum of animals immune against the bacillus of diphtheria and its poisons had the power of "destroying" *in vitro* and in the animal body the chemical poison secreted by this bacillus; and that animals, after a mortal dose of diphtheria poison had been injected, could be not only immunised, but actually cured, by the introduction into their system of the serum of animals immunised against the specific bacillus and its poisons. In a further series of researches he found that the serum of such animals possessed this power to a most remarkable and

almost incredible degree, and that the therapeutic value of this serum increased up to a certain extent with the amount of diphtheria-toxine which had been introduced into the system; whilst, on the other hand, the same toxine injected in too large quantities might cause the serum to lose its "anti-toxic" property.

Behring afterwards immunised large animals, such as sheep, horses, &c., against diphtheria by the repeated injection of diphtheria-toxine, and he observed that their serum was of great value when injected into human beings suffering from this disease. Before proceeding, however, it may be convenient to discuss these statements at somewhat greater length, and illustrate them by an account of a few experiments.

Let us draw some blood from a horse which has been thoroughly immunised against diphtheria, and decant the serum after its separation. We now take a filtered diphtheria culture, a given quantity of which we know to prove fatal to a guinea-pig of a certain weight in a certain number of hours. Let us divide, for instance, 5 c.c. of this filtered culture into five doses, and inject 1 c.c. into a guinea-pig (A) weighing 500 grammes without the addition of any serum. Four other guinea-pigs of the same weight as the first receive the same amount of toxine and 1 c.c., '01 c.c., '001 c.c., '0001 c.c. of the horse's serum respectively. The first guinea-pig (A) will die in less than twenty-four hours, but of the others, the three first will recover without any symptom of illness; whilst the last, which has received '0001 c.c. only, will probably die after some delay. We know, then, that the dose of serum which will protect a guinea-pig of a given weight against a known amount of toxine injected at the same time as the serum, lies somewhere between '001 c.c. and '0001 c.c., and, by further experiments, the exact dose may be accurately determined. In this way we may form an idea of the strength of the serum, but we must always remember that the data thus obtained are but approximate ones.

The curative serum may be introduced into the animal the day before the toxine is injected, but, in that case, a much larger quantity of serum will be necessary to protect the animal. If the serum be inoculated at the same time as the toxine, and in a different part of the body, the quantity of serum must also be increased if the curative effects are to be apparent. If some time is allowed to elapse between the injection of the toxine and that of the curative serum, the quantity of serum—in order to be effective—must be proportionately greater; but I have seen animals recover when the injection of the curative serum had been delayed *eleven hours* after the introduction of the toxine, which proved fatal to the control animals in 28–48 hours. In this latter case the dose necessary to cure was 5000 times that sufficient to immunise when the serum was injected with the toxine.

Can any opinion be formed as to the mechanism in which this serum exerts its action? The first explanation which suggests itself is that when the curative serum and the toxine are mixed together in the syringe or in the animal's body, the toxine is either destroyed or simply neutralised, just as the acid in a given solution may be neutralised by an alkali.

Yet there are several facts which negative this opinion, or rather which tend to prove that this destruction and neutralisation of the toxine, if destruction or neutralisation there be, is effected through the agency of the cells of the body. In the first place, if the whole were simply a chemical process, we should expect it to take place with mathematical precision. Thus, if '001 c.c. of horse's serum did destroy or neutralise 1 c.c. of toxine, this neutralisation should be apparent whether the mixture be injected into a guinea pig, a rabbit, or a sparrow. But it is not so; on the contrary, it has been found that in certain animals a very small amount of curative serum is sufficient to render harmless a certain amount of toxine

when the same amount of serum utterly fails to do so in animals of another species. Even if the same species of animals be used the curative effect will differ in intensity, according to whether the mixture be injected directly into the blood, or into the subcutaneous tissue. Moreover, if a number of guinea-pigs be injected each with the same amount of toxine and varying doses of curative serum, it is of frequent occurrence that some animals will resist when they have received but a very small quantity of serum; while others, which have received equal or even larger quantities of serum, speedily perish. Had we to deal with a simple chemical neutralisation or destruction of poison, identical results should occur in all animals. The action of the curative serum may also be inhibited by weakening the cells of the animal body by the action of bacterial or other protoplasmic poisons. Hence I consider that the term "anti-toxic," which has been used up to the present to denote this property of the serum, is only approximately correct; and I would prefer to substitute the word "curative," until such time as the mode of action of the serum has been accurately determined.

Before speaking of the application of this method to the cure of diphtheria in the human subject, and to the results which have been obtained in the hands of such experimenters as Behring, Roux, Ehrlich, Kossel, Wassermann, Heubner and others, it must be pointed out how the disease in man differs from and resembles that produced experimentally in animals by the subcutaneous inoculation of the bacillus diphtheriæ, or of its poisons. In both man and animals the symptoms are, to some extent, produced (Roux, Behring, Sidney Martin) by the absorption of the poisons secreted by this specific bacillus. But in man the production of these poisons is facilitated by the fact that the bacillus lives on the surface of the membrane, where it is exposed continually to the action of the air entering and leaving the lungs. Now, it has been shown experimentally that the easiest way of obtaining a large amount of diphtheria toxine from the diphtheria-bacillus growing in an artificial medium, is to expose the surface of this medium to a current of air. In the respiratory passages of man these conditions are exactly fulfilled, and the bacillus is able to produce large quantities of toxine. In the second place, the upper respiratory passages are crowded with all sorts of non-pathogenic and some pathogenic micro-organisms, the chief among the latter being the staphylococcus albus and aureus, and the various kinds of streptococci. These multiply on the soil prepared by the bacillus diphtheriæ, and secrete their toxine, which being absorbed, add their poisoning action to the deleterious action of the specific bacillus. In the preceding paragraph, I have drawn attention to the fact that the toxines of another micro-organism will inhibit the action of the curative serum; and there can be little doubt that the toxines secreted by these micro-organisms in man will have the same effects. The formation of the membrane also, and the mechanical obstruction so produced, may in themselves be the cause of death. It must be added, also, that diphtheria is chiefly a disease of the poor, and that in many cases the diagnosis is delayed, and the treatment is not begun until the patient is almost moribund. It is plain, therefore, that in the diphtheria of man we have all the conditions which are favourable to the production of the poison, and the inhibition of the action of the therapeutic serum. Hence we cannot be astonished that the death-rate at the Hôpital Trousseau in Paris amounted during the last six months to 62 per cent. of all cases admitted for this disease, and not treated with curative serum.

An examination of the statistics lately published by Dr. Roux, the eminent director of the Institut Pasteur, will allow us to form some idea of the value of the curative serum when applied to man. The reason for choosing these statistics is that they contain all the

elements necessary to enable us to form an accurate opinion. The mortality among 3971 children admitted during 1890-1894, and who were treated on ordinary lines, *i.e.* without curative serum, amounted to 51 per cent., the highest mortality being in 1890, when it reached 59 per cent., and the lowest in 1892, when it fell to 47 per cent. On February 1, 1894, Dr. Roux began the inoculations. As soon as a child suffering from diphtheria was admitted into the Hôpital des Enfants Malades, it received 20 c.c. of serum subcutaneously, and if no improvement took place, 10 c.c. or more were again injected next day. 448 children were thus treated from February 1 to July 24, 1894, and 169 died, the mortality being 24.75 per cent. At the Hôpital Trousseau, on the other hand, 520 children were admitted during that period, and treated without the injection of curative serum. Of these 316 died, giving a mortality of 60 per cent. This difference is striking enough; but it is even more marked when we come to analyse the results. In the first place, we must eliminate from Dr. Roux's statistics 128 cases which were shown by bacteriological examination not to be diphtheria. This mistake is perfectly legitimate, as it has been shown that without a bacteriological examination, it is impossible to make an accurate diagnosis. The injection of the serum in a doubtful case is followed by no harm, and as the result of the bacteriological examination cannot be known for twenty-four hours, the injection of the serum will, at any rate, prevent the child catching the disease from his neighbour. The mortality among such cases we know to be very slight, and in the statistics of previous years, as well as in those of the Hôpital Trousseau, these cases are included among the cures, so that the proportion of cures appears to be much higher than it really is. These cases being excluded from Dr. Roux's statistics, there remain 320 children in which the bacteriological examination revealed the presence of the diphtheria-bacillus. Of these 20 died on admission, before any therapeutic measures whatever could be employed. Of the 300 other children 78 died, giving a mortality of 26 per cent. We may further divide these into uncomplicated cases, and those in which tracheotomy had to be performed for laryngeal obstruction. Of the uncomplicated cases, the mortality in Dr. Roux's wards amounted to 12 per cent.; whilst at the Hôpital Trousseau, where no serum was used, the mortality during the same period reached 32 per cent. In the preceding years it was 35 per cent. in the wards in which Dr. Roux carried out his experiments.

Turning now to the cases in which tracheotomy had to be performed, we find that 49 per cent. of Dr. Roux's cases died. At the Hôpital Trousseau in the same period 56 per cent. of the tracheotomised children perished. Similar results have been obtained in Germany, the mortality in some wards falling as low as 14 per cent. Prof. Ehrlich has shown that the question of time is a most important element, and that the chances of obtaining a cure are infinitely greater when the remedy is applied at an early stage of the disease. The following table, reprinted from the *Deutsche Medicinische Wochenschrift*, will explain this:

Time of day when the child was admitted	Number of cases	Number of deaths	Number of cures	Cures, per cent.
1	6	0	100	100
2	66	2	97	97
3	29	4	86	86
4	59	9	77	77
5	25	10	59.5	59.5

It will be noticed that the number of cures diminishes according to the length of time which has elapsed since the onset of the disease.

It appears to me to be difficult to explain away the results obtained in France and Germany by simply saying that the epidemic has been a mild one: for in other hospitals and institutions in which the curative serum has not been used, the mortality has remained the same, or even increased. In fact, it is plain that the serum treatment of diphtheria is now established on a firm basis, and that it is only right that we should at once give the children in this country the benefit of the results of experimental investigation which has been principally carried on abroad. The British Institute of Preventive Medicine is now taking steps to provide the serum at cost price.

Finally, it is right to draw attention to the fact that although the knowledge of the biology of the diphtheria bacillus, and of the effects of its poison, has been based on the investigations of different observers—French, German, and English—yet the discovery of the curative effect of the serum of immunised animals is the merit of one man only—Prof. Behring, of Berlin.

M. A. RUFFER.

NOTES.

THE Paris Academy of Moral and Political Sciences has bestowed the Audiffret prize of twelve thousand francs upon Dr Roux for his treatment of diphtheria.

A STATUE of Claude Bernard, the eminent physiologist, was unveiled at Lyons on Sunday last, in the presence of a distinguished company.

THE *National Zeitung* states that news has reached Berlin from the Kilima-Njaro district that the German botanist, Dr. Lent, and the zoologist, Dr. Kretschmar, have been killed, with several of their black followers.

DALZIEL'S correspondent at New York says that a dispatch received from Buenos Ayres gives particulars of a severe earthquake, attended by great loss of life, which occurred on Saturday, October 27, at the town of San Juan de la Frontera, the capital of the Province of San Juan, in the Argentine Republic. Many of the principal buildings are said to have been destroyed. The shock extended to the towns of La Paz, Cordova, and Rosario. The New York *Herald* of Monday published a telegram from Buenos Ayres stating that two thousand persons have perished in the earthquake at La Rioja, and that twenty thousand are homeless. This alarming report has not, however, been confirmed.

NUMEROUS memoirs have already been based upon the rich collection of Dutch birds brought together by the late Mr. J. P. van Vieckvoort Crommelin, of Harlem, and presented, after his death, by his daughter to the Leyden Museum. Ornithologists will therefore welcome the appearance of a complete catalogue of the collection, which has been compiled by Dr. Jentink, the director of the museum, and forms the fourteenth volume of the catalogues of the Muséum d'histoire naturelle des Pays-bas. Nearly three hundred species are in all enumerated, and the majority of these are represented each by a considerable number of specimens. A separate record is given of every individual, notifying the sex and age, the place and date of capture. An explanation which Dr. Jentink furnishes of the exact locality of all the places mentioned should be of material service to the student of the geographical distribution of these birds.



THE London Mathematical Society, having been on October 23 duly registered as a corporation under Section 23 of the Companies Act, 1867, will hold its first general meeting at its office, 22 Albemarle Street, on Thursday evening, November 8 next, at eight o'clock. The meeting is empowered by the Articles of Association to elect a council and officers, to frame bye-laws and to pass resolutions with regard to the affairs of the Society. The following gentlemen have been recommended by the present council (acting under Article 8) for election as the new council and officers for the ensuing session:—President, Major Macmahon, R.A., F.R.S.; vice-presidents, Messrs. M. J. M. Hill, F.R.S., A. B. Kempe, F.R.S., and A. E. H. Love, F.R.S.; treasurer, Dr. J. Larmor, F.R.S.; hon. secretaries, Messrs. M. Jenkins and R. Tucker; other members, Messrs. A. B. Basset, F.R.S., and G. H. Bryan, Lieut.-Colonel J. R. Campbell, Lieut.-Colonel A. J. C. Cunningham, R.E., Messrs. E. B. Elliott, F.R.S., J. W. L. Glaisher, F.R.S., A. G. Greenhill, F.R.S., E. W. Hobson, F.R.S., and W. H. H. Hudson. At the close of the preceding business, an address will be delivered by the retiring President (A. B. Kempe, F.R.S.), on "Mathematics," after which the meeting will proceed to the ordinary business.

DURING this month, the following lectures will be delivered at the Royal Victoria Hall, Waterloo Bridge Road, S.E.:—November 6, Prof. A. W. Rücker, F.R.S., on "The Electric Spark"; November 13, Mr. H. R. Mill, on "Unexplored England"; November 20, Miss Hope Rea, on "The Grand Canary and its People"; November 27, Miss F. Routledge, on "China."

It is proposed to hold a "Light and Heat Exhibition" at Woodhouse Park next year. The park is situate at Shepherd's Bush, and is, therefore, in direct communication with all parts of London and the suburbs. The exhibits will be classified into eight divisions, viz.:—Gas lighting; electric lighting; various illuminants; heating and cooking apparatus; naval and military; scientific apparatus; photography; historical. The promoters' intention is to hold a series of technical exhibitions on the same site. Further information can be obtained of the Hon. Secretary, Woodhouse, Shepherd's Bush, W.

PROF. W. M. FLINDERS PETRIE will lecture on "Primitive Egypt," at the London Institution, on November 12. The following are among the other lecturers and subjects for the session ending March 4, 1895:—"Wonder-Working Plants," by Dr. David Morris, C.M.G.; "Climbing in the Himalayas," by Mr. W. Martin Conway; "Extinct Monsters," by Rev. W. N. Hutchinson; "The Newtonian Constant of Gravitation," by Prof. C. V. Boys, F.R.S.; "The Fauna of Rivers and Lakes," by Prof. Sydney Hickson; "Twenty Thousand Feet above the Sea," by Mr. Edward Whymper; "The Netherlands," by M. H. J. Mackinder; "Waves of Water and Waves of Light," by Mr. A. P. Laurie; "Nerves and Nerve Centres in Action," by Mr. Henry Power; "Comets," by Sir Robert Ball, F.R.S.; "The Germination of Barley," by Mr. A. Gordon Salomon; "Electric Currents in the Body," by Prof. Victor Horsley, F.R.S.; "The Beautiful as seen in Minute Nature," by the Rev. Dr. Dallinger, F.R.S.; "Theory and Practice of Preventive Inoculation," by Dr. E. E. Klein, F.R.S.

For the last week or so the weather in these islands has been of a very unsettled character generally. Several areas of low barometric pressure have reached us from the Atlantic, and were accompanied by strong gales on nearly all our coasts, and in the Channel very rough weather has been experienced, while thunder and lightning have also occurred in many places. The rainfall has been very heavy, especially in the west of Ireland and south of England, where it amounted to nearly four and a half inches during the week ending October 27, while in the

Midland counties the fall reached about two inches. Since the beginning of the year the rainfall has about reached, or exceeded, the average in all districts except the Midland counties, where the deficiency is three inches, and the west coast of Scotland, where it is two and a half inches.

PROF. CLEVELAND ABLE includes the following among his notes in the *Monthly Weather Review* for July:—On June 3 a tornado passed north-eastward through the counties of Harney, Grant, and Union, in Eastern Oregon. The most novel feature attending the disturbance was the hail. It is stated that the formation was more in the nature of sheets of ice than simple hailstones. The sheets of ice averaged three to four inches square, and from three-fourths of an inch to one and a half inches in thickness. They had a smooth surface, and in falling gave the impression of a vast field or sheet of ice suspended in the atmosphere, and suddenly broken into fragments about the size of the palm of the hand. During the progress of the tornado at Long Creek a piano was taken up and carried about a hundred yards.

MR. A. TREVOR-BATYEE, about whose safety some anxiety has been felt, has reached Archangel from the island of Kolguef, where he had been studying bird-life. The proposed relief expedition, for which subscriptions had been invited, is consequently no longer necessary.

THE German collector, J. Menges, describes, in the last number of *Petermann's Mittheilungen*, his travels in the Habr Auel district of Somaliland, inland from Berbera. He visited the country in 1882, and gives a detailed account of his routes in pursuit of big game.

THE last Washington letter published by the American Geographical Society states that the boundary line between the United States and Mexico has been re-surveyed, and a series of monuments erected along it at intervals for a distance of 700 miles. The field operations for the survey of the Alaskan frontier are also completed, and the height of Mount Logan has been confirmed as 19,500 feet, thus overtopping Mount St. Elias by 1500 feet. Another interesting result of the joint exploration is to show that both these mountains lie within British territory.

THE Indian Reservations of the United States in which the aboriginal inhabitants are secure against aggressive civilisation, are fast diminishing in number and extent. The last number of the *Bulletin* of the American Geographical Society mentions that four million acres of reserved land in the north-east of Utah, containing great mineral wealth, and hitherto the home of the Uncomahgre and Uintah Indians, is about to be opened to settlement, while nearly a million acres in South Dakota are to be withdrawn from the exclusive occupancy of the Indians of South Dakota, Oregon, and Idaho.

CONSUL C. S. SMITH gives an account of the Anglo-German frontier survey in East Africa, in the November number of the *Geographical Journal*. The survey, which was carried from the mouth of the Umba River on the east coast to Kilimanjaro, was effected in 1892, Mr. Smith being assisted by Mr. Imam Saarif, the Indian surveyor, who subsequently accompanied Mr. Bent to Arabia, and Lieut. G. E. Smith, R.E., and the German party with whom they co-operated was under the charge of Dr. Peters. The route by the Umba Valley to Kilimanjaro was found to be a practicable one, and the country traversed was, as a rule, characterised by fertile soil; but the land suffered from the want of settled inhabitants, on account of the raids of the Masai. Consul Smith suggests that immigrants from India be encouraged to colonise parts of the Umba Valley; and if trade is ultimately attracted there, he points out that the seaport of Wasini, although smaller than Mombasa, would be found quite practicable for steamers.

THE current number of *Himmel und Erde* contains a summary of a lecture by the Director of the Statistical Office of Berlin, on the increase of damage by lightning, and on the effect of lightning on the human body. The increase, which is unmistakable, is attributed to various causes, viz. the employment of electricity in various industries, the continual change of the form of the earth's surface by deforestation, drainage, &c., and the impurities introduced into the atmosphere by the growing consumption of coal. Prof. von Bezold has shown, some time since, that for Bavaria the average yearly number of fires caused by lightning amounted to 32 from 1833-43, to 52 from 1844-55, to 103 from 1866-79, and to 132 between 1880 and 1882. While in the year 1855, 134 persons were struck by lightning, and 73 were killed, the numbers thirty years later reached 189 and 161 respectively. It is noteworthy that persons struck by lightning generally perceive neither lightning nor thunder, but have the idea of being suddenly enveloped by fire.

To the facts of fishes out of water and of crabs on dry land we are accustomed, but the recent announcement of the discovery of a flying Copepod is a novelty of which the naturalist has probably never dreamed, though Giesbrecht's beautiful figures of the Naples forms might well have induced the thought of such a possibility. In the current number of the *Zoologischer Anzeiger* (No. 459), Dr. Ostroumoff, of the Sebastopol Biological Station, states that he and his son were coasting along the Kheronese peninsula on a calm clear morning last July, when they noticed numbers of the tiny green Crustacean, *Pontellina mediterranea* Claus, flying just above the level of the water. "Many of these Copepods were resting on the surface-film, took springs into the air, where they described a long curve, and fell down again upon the water surface." Dr. Ostroumoff traces the origin of this very exceptional habit to a peculiarity in the manner of exuviation that *Pontellina* probably shares with certain other pelagic Entomostraca, e.g. *Esthim. Plops*, which cast their skins at the surface of the water "by the help of the air which becomes entangled in and by their rejected coverings." We should like to hear something more upon this interesting phenomenon, which involves a complete change in the life conditions of the species. It is difficult, at any rate, to imagine that so light and hairy a form as *Pontellina* can return at will to the water again after once breaking through the surface film.

THE Bunsen flame spectra of the metals of the alkalis and the alkaline earths have been studied by Herren J. M. Eder and E. Valenta, by means of an apparatus which enabled them to make exposures of extraordinary length. The apparatus, described in a paper communicated to the Vienna Academy, consisted essentially of a circular strip of platinum gauze mounted in a slanting position on a nickel wheel. The lower edge dipped into a solution of the salt to be examined, and the upper edge passed through the Bunsen flame. The wheel was kept slowly rotating by clockwork, and the steady and uniform spectrum obtained was photographed. In the case of sodium and potassium no lines were discovered that were not already known from the spark and arc spectra, although the ultra-violet sodium lines of wave-lengths 3303 and 3553 were well rendered. But with an exposure of some thirty hours a number of new bands appeared in the violet and ultra-violet spectra of the metals of the alkaline earths. They belonged chiefly to the oxides, and consisted partly of double bands arranged pretty regularly on a continuous background. The spectrum of boracic acid, obtained by burning a mixture of coal gas and  $B_2O_3$  in a Lantemann burner, showed six new violet and ultra-violet bands, which by their general character and their regular distribution correspond to those previously observed in the visible spectrum.

A REMARKABLE instance of the anomalous behaviour of bodies at very low temperatures is given by M. Raoul Pictet in the *Revue Scientifique*. For the preparation of pure chloroform by crystallisation at  $-60^\circ C$ . he used two copper refrigerators, of capacities of  $2\frac{1}{2}$  and 32 litres respectively. The former being more convenient, it was used for the first series of experiments. About 2 kgr. of commercial chloroform were put into a glass test-tube, placed in the refrigerator, and surrounded by a temperature of about  $-120^\circ$ , as indicated by a sulphuric ether thermometer. The chloroform appeared turbid at  $-40^\circ$  or  $-50^\circ$ , and was filtered and further cooled. At  $-68\frac{1}{2}^\circ$  the cooling ceased, and very transparent crystals of chloroform appeared on the walls of the test-tube. The chemically pure chloroform thus obtained was used with great success in the Berlin hospitals, and larger quantities had to be obtained. M. Pictet noticed with great surprise that chloroform, refrigerated in the larger vessel, was cooled to  $-81^\circ$  without a trace of crystallisation. To test for experimental errors the small refrigerator was exposed to the same cooling process, and the chloroform crystals plunged into the larger one. But the crystals dissolved at once, though the same thermometer, successively plunged in the two refrigerators, fell from  $-68\frac{1}{2}^\circ$  to  $-81^\circ$ , where no crystallisation was going on. Finally, the whole test-tube, with crystals at the walls, liquid chloroform in the centre, and thermometer standing at  $-68\frac{1}{2}^\circ$ , was immersed bodily in the liquid chloroform at  $-81^\circ$ . The thermometer gradually fell from  $-68\frac{1}{2}^\circ$  to  $-81^\circ$ , while the crystals dissolved before the observer's eyes. M. Pictet works out an explanation of this striking phenomena on the basis of the theory of radiation and his own theory of the molecular constitution of solids and liquids, which leads him to the conclusion that heat oscillations corresponding to low temperatures traverse bad heat conductors with greater facility than they do compact and heavy substances such as metals.

THE fifth report upon the activity of the German Imperial Physico-Technical Institute appears in the *Zeitschrift für Instrumentenkunde*. Besides the electrical work, which chiefly dealt with resistances, the principal subjects of investigation were connected with thermometers, manometers, barometers, pyrometers, standard Hefner lamps and photometry, and the physical properties of various kinds of glass. The branch establishment at Ilmenau, in the Grand Duchy of Saxony, has been extended by the addition of a technical school for workers in glass instruments. Among the barometers tested were the aneroids employed by Dr. von Drygalski on his Greenland expedition. It appeared that low temperatures are capable of creating a temporary disturbance in the indications of these instruments. The chief optical work was connected with photometry. As regards the introduction of the Hefner lamp as a standard of illumination, the report points out that Germany is ahead of other countries in possessing a well-authenticated standard of light which answers all technical requirements. Recently the Institute has endeavoured to construct simple and portable photometers for technical purposes. Two such instruments have been constructed and found to work well. The photometry of the arc lamps illuminating "Unter den Linden" at Berlin, was also taken in hand by the Institute. The examination of different glasses related mainly to their solubility in water, which was found to give an indication of various other properties. The electrolytic precipitation of zinc and other metals from dilute solutions was investigated with a view to their preparation in a pure state. The examination of specimens of steel, of chronometer oils, and of coloured thermometer liquids, was among the many tasks allotted to this most useful and many-sided National Physical Laboratory.

IN the Pitt Press Mathematical Series there is no more useful volume than "Arithmetic for Schools," by Mr. Charles Smith.

The Cambridge University Press has published a second edition, in two parts, of Mr. Smith's work. Evidently the book has met with the reception it deserves.

THE importance of experimental work is fully recognised in the agricultural department of the Glasgow and West of Scotland Technical College. We have before us the reports on experiments on the manuring of hay, oats, and turnips, conducted in 1893 on the Home Farm of Cleghorn Estate, near Lanark, and on about fifty other farms scattered all over the south-western counties of Scotland. Prof. R. P. Wright, who directed the experiments, must derive satisfaction from the useful conclusions to which they have led.

THE first part of Mr. J. W. Taylor's "Monograph of the Land and Fresh-water Molluscs of the British Isles," published by Messrs. Taylor Bros., Sovereign Street, Leeds, has just appeared. It would be difficult to speak too highly of the fine coloured plate which forms the frontispiece to the part, or of the 138 well-drawn illustrations in the text. These figures will be recognised by all conchologists as faithful representations of the species they personify. The work is readable, concise, and accurate, so far as it has been published, and the scientific naturalist, as well as the systematic student, will find it useful and interesting.

MR. R. L. JACK, the Government Geologist of Queensland, has issued his report of the progress of the geological survey for last year. We learn from it that the most important work of the year was the production of a geological map of the Charters Towers gold field. The first edition of this map was issued early in the present year, and Mr. Jack does not claim too much when he says that no important centre of mining industry in Australia has been so thoroughly mapped. The underground work has now been completed, and it is expected that a second edition, embodying this work, will shortly be published. With Mr. Jack's report we received a report, by Mr. W. H. Rands, on the Towalla and Marceba gold fields.

WITHIN the past few years the number of students and workers in glacial geology has greatly increased. The third edition of Prof. James Geikie's "Great Ice Age," just published by Mr. Edward Stanford, appeals therefore to a much larger class than when the previous issue appeared seventeen years ago. The work has been enlarged, and most of it has been rewritten. The mass of glacial literature that has accumulated during the last fifteen years or so, has rendered it possible for the author to treat the glacial, and interglacial, deposits of the continent much more fully than in the second edition. The phenomena of existing glacial action in Alpine and Arctic regions, and the glaciation of Scotland, have been revised in the light of recent work, and several rearrangements of matter have been made. An important addition consists of two chapters on the glacial phenomena of North America, by Prof. T. C. Chamberlin. All glacialists will welcome this authoritative account of the glacial accumulations of Canada and the United States. It increases the value of what has always been a valuable treatise.

THE additions to the Zoological Society's Gardens during the past week include a Barbary Ape (*Macacus munit*), a Turtle Dove (*Turtur communis*), four Barbary Turtle Doves (*Turtur risorius*), four Barbary Partridges (*Caccalis petrosa*), a Crested Lark (*Alauda cristata*) from Morocco, presented by Mr. Alfred J. Gosling; a Caracal (*Felis caracal*), from South Africa, presented by Mr. J. E. Matcham; a Brown Capuchin (*Cebus fulvifus*) from Guiana, presented by Mr. T. A. Jenkins; a Common Buzzard (*Buteo vulgaris*) from Aden, presented by Captain R. Workman; a Lanner Falcon (*Falco lanarius*), captured at sea, presented by Mr. Arthur J. Elliott; a Hawks-billed Turtle (*Ciccone imbricata*) from the East

Indies, presented by Captain E. F. Tyacke; two Long-nosed Crocodiles (*Crocodilus cataphractus*) from West Africa, presented by Mr. J. Banks Elliott, three Rusa Deer (*Cervus hippelaphus*, ♂ ♀ ♀) from Mauritius, presented by Rear-Admiral Kennedy; two Somali Ostriches (*Struthio molybdophanes*) from Somaliland, purchased; four Plumed Ground Doves (*Geopelia plumifera*) from Australia, received in exchange.

OUR ASTRONOMICAL COLUMN.

THE SPECTRUM OF δ CEPHEI.—M. A. Belopolsky has taken a number of photographs of the spectrum of δ Cephei—a variable of short period—and determined from them the velocity of the star in the line of sight. The results obtained showed a periodic variation, and M. Belopolsky used them to find the elements of the star's orbit, in the manner described by Dr. Lehmann-Filhés in the *Astronomische Nachrichten*, No. 3242 (see NATURE, August 2, p. 327). He finds that the eccentricity of the orbit is 0.46; and the apparent semi-major axis 180,000 geographical miles (207,000 English miles). The period of the star is 5d. 9h. The maximum velocity of approach is about 2.8 statute miles per second, and of recession 3.2 miles per second. The system, as a whole, is therefore moving away from our own system. It is found that the light-minimum occurs one day before the time of periastron passage given by the computed elements of the orbit.

THE ROTATION OF VENUS.—For eight years M. Flammarion has carried on observations of the polar caps of Venus, and, in the current *Comptes-rendus*, he discusses the bearing of his results upon the question of the planet's period of rotation. It will be remembered that Schiaparelli concluded in 1890 that the rotation and revolution periods of Venus were of the same length, viz. 225 days; but later observations by Trouvelot and others have led many astronomers to doubt this interpretation, and to believe that the rotation period of the planet is not very different from that of the earth. M. Flammarion remarks that if it is conceded that the polar caps are really due to snow or ice, their very existence is against Schiaparelli's view. As the two caps are often visible at the same time, it appears that the axis of Venus is but slightly inclined to the orbit. M. Flammarion's observations of markings on the planet are not sufficient to determine the period of rotation, but they appear to indicate that it is not far removed from twenty-four hours.

THE LOWE OBSERVATORY.—A few particulars with regard to the new astronomical observatory, which has lately been erected in Southern California by Prof. T. S. C. Lowe, are given in Saturday's *Times*. The observatory is seven miles by rail north of Pasadena, and sixteen miles north-east of Los Angeles. Its altitude is about 3600 feet above the sea, and 2000 feet above the hill at the base of the mountains, which are very steep at this point. While the crest of the range rises high above the observatory and shelters it on the north, leaving, however, the North Star visible, the entire southern horizon is unobstructed, extending to the rim of a large segment of the Pacific Ocean, about 100 miles distant, on the south and west. Astronomically, it is nearly at the intersection of the 34th parallel of north latitude with the 118th meridian of longitude west of Greenwich. The new observatory is well equipped with the great 16 inch Clark reflector and other instruments which have done no able work in the Warner Observatory at Rochester under the directorship of Dr. Lewis Swift, who will now superintend the Lowe Observatory.

THE LUNAR PARALLAX OF STARS.—In the *Astronomische Nachrichten*, No. 3258, Prof. Hugo Gylden gives the results of his attempts to discover a formula connecting the parallax of a star with its magnitude and its apparent motion. The fifty-six stars which have had their parallaxes determined with a satisfactory degree of accuracy were arranged in groups according to their magnitude and according to their apparent motion. After a lengthy series of tentative formulæ, the observed values were connected within about ten per cent. by the following formula,

$$P = 0.204 e^{-0.154 + \Psi_0}$$

where  $\Psi_0 = 2 - \left(\frac{v}{e}\right)^m$ ,  $m$  is the magnitude, and  $P$  the parallax of stars exhibiting no proper motion. For stars with

proper motion a term  $\Delta$  has to be added to  $P$ , the value of which tends to 0.48 as the magnitude, and the proper motion increases. So long ago as 1872, Prof. Galden showed that it is justifiable to deduce the distance of a group of stars from their apparent mean brightness in all cases where the probability of a certain intensity of illuminating power is a function of this intensity alone, without depending upon position in space. And since the photometric law has been proved to be at least approximately valid in this case, it may be concluded that the brightnesses of stars reduced to the same distance are the same, on an average, for all distances which can enter into our consideration. But the most important result of the present investigation is the determination of the mean parallax of first magnitude stars reduced to the zero of apparent motion. The value for this, which is 0.204, may be considered as identical with Peters's value of 0.209, especially when it is borne in mind that the latter value is not reduced to zero apparent motion.

### THE INSTITUTION OF MECHANICAL ENGINEERS.

ON Wednesday and Thursday evenings of last week, October 24 and 25, a general meeting of the Institution of Mechanical Engineers was held at 25 Great George Street; the President, Prof. Alexander B. W. Kennedy, occupying the chair. The two following papers were read and discussed:

"The Manufacture of Standard Screws for Machine-made Watches," by Mr. Charles J. Hewitt, of Prescott.

"Drilling Machines for Cylindrical Boiler Shells," by Mr. Samuel Dixon, of Manchester.

Mr. Hewitt's paper was of an interesting nature. He is the works manager and chief mechanic of the Lancashire Watch Factory, an establishment recently started at Prescott for the manufacture of watches on a large scale in one works. The factory system of watch production has been, as is well known, carried to a very successful issue in the United States, where the Elgin and Waltham Watch Companies annually make large numbers of excellent time-pieces wholly by machinery. As, in all cases, where highly skilled hand labour, performing intricate operations, is superseded by mechanical appliances, the machines used are of a highly organised and costly nature. In the case of the minute parts required in watch-making, this feature is very strikingly emphasised. Perhaps some of our readers may remember the exquisite little machine tools exhibited by the Waltham Watch Company, at the Inventions Exhibition, in the year 1885. These were a revelation to most English watchmakers, accustomed to the small factories and perfectly rude appliances of the British industry, in which the highest skill of the operators, due to special training from earliest youth, compensated for the lack of ingenuity displayed in the construction of the tools used. In the case of watches, as with so many other mechanical productions, the brain capital expended in the employment of construction of machines bears fruitful interest in the shape of less skilled labour required in their use. The same thing may be observed throughout the whole range of mechanical industry. The file, the hammer, and chisel are the primitive tools of the engineer, requiring simple inventive power in their inception, but great skill in their use. The planing machine, by which the same end is obtained mechanically, of producing a flat surface, as was got originally by chipping and filing, required knowledge and skill for its production, but a comparatively small amount of those qualities for its operation. The same thing is true, even to a greater extent, in the case of the still more modern machine tool, the milling machine, which is often attended by boys, possessing no mechanical knowledge whatever, during its production of finished forms such as would have required a highly skilled workman in former days.

The beautiful machines referred to by the author in his paper, examples of which were shown at the meetings, carry the same principle many steps farther. As was remarked, the machine shown for making watch-stems may be said to stand in the same relation to ordinary engineers' machine tools as a finely grained common building stone.

Mr. Hewitt commenced his description by dwelling upon the difficulties experienced by watchmakers in old times, when there was no general standard for dimensions and pitch of screws, or form of thread. Such was necessarily the case with hand-work, but a machine can be depended upon to turn out

many thousands of parts exactly similar, so that a screw could be put into a watch made years previously. The advantage, naturally, is most apparent in the case of repairs and renewals. The standard of screws adopted by the Lancashire Watch Company at their Prescott Works, is that recommended by the committee of the British Association, and described in the report of 1882. It is a V-thread of  $47\frac{1}{2}$  degrees, rounded top and bottom through  $\frac{1}{4}$  of the height, and the pitch is directly related to the diameter of the formula  $D = 6P$ . In arranging the standard the first business was to make master taps, which were produced on a small screw-cutting lathe specially designed for the work, and having a corrected screw, accurate within very close limits. Taps being thus produced, screw-dies were made to the exact standard. When cut the thread requires hardening, and this causes some amount of distortion, which is corrected by grinding the threads with a soft steel lap charged with diamond dust, the operation being performed in the same lathe that cuts the thread. The die used is simply a tapped hole in the centre of a small thin disc of steel, it being an object to have as little metal as possible surrounding the hole, so as to reduce the distortion produced by hardening. Although the die is not split, the pressure exerted by the die-holder is sufficient to produce a slight modification in the diameter of the screw, and in this way the alteration caused by hardening is corrected. During the discussion this fact was questioned, but Mr. Hewitt says that the statement is absolutely correct. The machine itself is of an intricate design, as may be imagined when it is stated that perfect screws are turned out automatically from the plain rod or wire. There are four hollow spindles through which this wire is fed forward to the operating tools, which are four in number, and are carried on a revolving turret. There is also a further tool for making the slit in the screw-head for the turn-screw. It would be useless to attempt to describe the mechanism of this very ingenious lathe without the aid of elaborate drawings. Indeed, during the discussion several engineers, well skilled in mechanical appliances, confessed themselves unable to follow the train of mechanism, even with the aid of working drawings displayed on the walls of the theatre. It is enough to say that the machine will go on without any attention so long as the wire to form the screw lasts, when it stops of itself.

A short discussion followed the reading of the paper, but no fresh points were raised; the speakers, for the most part, contenting themselves with complimenting the author on the ingenuity of his design.

On the second evening of the meeting, Mr. Dixon's paper, on drilling machines for boiler shells, was read and discussed. The introduction of steel as a material for steam-boiler construction opened up a new era in that branch of industry. When iron plates only were used, a first-class boiler-ship possessed, as the chief part of its plant, simply a punching machine and a pair of rolls for bending the plates; the rest was done by handwork, and that of a highly skilled man. Now that machinery has superseded the handicraftsman, rivetting is done by most costly and beautifully designed hydraulic apparatus, necessitating in its invention a knowledge of applied science of a high order. Flanging of the immense boiler-plates of the present day is also effected by heavy hydraulic presses. The rolls now used for bending plates have to be designed on true mechanical principles, whilst great advance has been made in drilling machinery. Thus both in the enormous boilers of our large steamships and in the minute mechanism of watches, we see the skilled handicraftsman being displaced by automatic machinery. It was soon found impossible to make steel boilers with the same plant that was used for the old type of iron boilers; the difference in the physical properties of the material alone demanded a change in treatment. The softer and less homogeneous non-cased rivet-holes to be punched, but it was found that this work done upon steel plates caused a deterioration of the metal; drilling, therefore, had to be substituted for punching. Iron plates were punched in the flat; but it was found that with steel when the holes were made in that way, they often would not go together accurately so as to take the rivets to the greatest advantage, the result being a weak joint. This did not matter so much when steam pressures were low, but with the greater demands made by the marine engineer in producing motive power economically, higher pressures had to be used, and there was no margin for loss in the line of rivetting. It therefore became customary to bend the plates and put them into shape to form the shell of the

boiler before making the holes, which were then drilled in position, and were necessarily true. This procedure involved the use of special drilling machines, whilst economy demanded that several drills should work at once in one machine so as to save time and be under the care of only one attendant. The chief object of Mr. Dixon's paper was to describe the most recent of these machines. The drill spindles are carried on supports which bring them to the work, and are adjustable to the varying pitches and angles required. There is a cross-slide which can be raised or lowered for carrying the drills for the circular seams, and this is adjustable so as to suit the varying threads required. There are five drills for this purpose, whilst six more are arranged upon a vertical column upon the opposite side of the boiler shell for operating upon the butt seams. One of the chief difficulties in drilling holes in a built-up shell is the flexibility of the work, which causes it to give way and buckle when the pressure of the drills is brought upon it. So great has been this drawback that it has been found more advisable in many cases to use only one drill at a time, although there may have been four spindles on the machine. Mr. Dixon has overcome this objection in an ingenious manner by an internal support which gives great rigidity to the shell, and enables the larger number of drills to be brought into play at once without their accumulated pressure causing deflection. During the discussion an interesting point arose in connection with this feature. It was said that twist drills which, when properly ground, gave very clean holes and great accuracy of work, could not be used on boiler shells, as they so frequently broke in work. The author said this was perfectly true in ordinary cases, but it was due to the springing of the shell referred to. The statement is corroborated by the fact that twist drills can be advantageously employed on work firmly held on the drilling machine-table, whereas the older form of flat drill would have to be used where rigidity could not be obtained.

#### A NEW METHOD OF PREPARING PHOSPHORETTED HYDROGEN.

A NEW and extremely simple mode of preparing phosphoretted hydrogen is described by Prof. Retgers in the current *Zeitschrift für Anorganische Chemie*. After reviewing the usual mode of preparing the gas for demonstration purposes, by heating yellow phosphorus in an aqueous solution of potassium hydrate, and the other more rarely employed methods of preparation—such as by the interaction of calcium phosphide and hydrochloric acid, copper phosphide and potassium cyanide, and phosphonium iodide and water—the question of the direct combination of hydrogen and phosphorus is discussed. It appears that the currently accepted idea that ordinary molecular hydrogen does not combine with phosphorus is founded upon some old experiments of the French chemists Fourcroy and Vauquelin, who state that when phosphorus is melted in hydrogen gas, vapour of phosphorus becomes diffused in the hydrogen, and confers upon it the power of ignition in contact with oxygen without any combination between the phosphorus and hydrogen occurring. In view of the great readiness which, as Prof. Retgers has recently shown, warm hydrogen exhibits to unite with free arsenic, it was considered possible that the reason for the non-combination of hydrogen and melted phosphorus might be found in the low melting-point (44°) of the latter. Experiments were therefore made with red phosphorus, which, of course, is capable of being raised to a much higher temperature. When dry hydrogen is led through a glass tube containing red phosphorus, and afterwards through a wash-bottle containing water, practically pure hydrogen is found to escape. Immediately, however, a gas flame is brought under the part of the tube containing the phosphorus, combination occurs, and the gas issuing from the wash-bottle at once inflames in the air. The non-spontaneously inflammable gaseous hydride of phosphorus is also therefore accompanied by a smaller quantity of the spontaneously inflammable liquid hydride, and a sufficient quantity of the latter for demonstration may be isolated by leading the vapours through a U-tube immersed in a freezing mixture. Moreover, the solid hydride is likewise produced as a yellow deposit near the heated portion of the tube. Upon removing the flame from beneath the tube, the bubbles of escaping gas cease to take fire as they emerge into the air, and are found to consist of almost pure hydrogen. The production of phosphoretted hydrogen is consequently entirely

dependent upon the elevation of the temperature considerably above the melting point of ordinary yellow phosphorus. The new mode of preparation is recommended by Prof. Retgers as being more convenient and elegant than the old established method of boiling phosphorus in caustic potash, as forming an excellent example of the direct combination of two elements, and as furnishing ample demonstration of all three hydrides of phosphorus, the gaseous, liquid, and solid.

#### UNIVERSITY AND EDUCATIONAL INTELLIGENCE.

OXFORD.—The Rolleston Memorial Prize has been awarded to M. S. Pembrey, of Christ Church, and E. S. Goodrich, of Merton College, the papers sent in by these two candidates having been judged to be equal. Mr. Pembrey was placed in the first class in the Honour School of Natural Science in 1889, and is demonstrator in the Physiological Department. Mr. Goodrich is still an undergraduate, and is assistant to the Linacre Professor. At a meeting of the Junior Scientific Club, held on Friday, October 26, Mr. W. J. Waterhouse, of Christ Church, exhibited some telephone cables, and Mr. W. P. Pycraft exhibited some Natterjack toads. Papers were read by Mr. W. Garstang, of Lincoln College, on some modifications of the Tunicate pharynx induced by the violent ejection of water, and by Mr. C. T. Blanshard, of Queen's College, on the genesis of the elements.

Sir Henry W. Acland, K.C.B., has announced his resignation of the Regius Professor of Medicine, the resignation to take effect at the end of the present year. Sir Henry is now in his eightieth year, and has long been a leading figure in scientific and medical matters in the University. His resignation will sever the link of many old associations. He has consistently and bravely supported the cause of science in Oxford, and that, too, at a time when scientific studies were regarded in anything but a favourable light by the rest of the University. It was largely due to his influence and energy that the University Museum was built, and he has never failed to support any movements for its further extension and for the improvement of the teaching which is carried on there. One of his latest efforts secured the building of the new Department of Human Anatomy, and he has had the satisfaction of seeing the medical school for which he worked so hard rise from almost nothingness into considerable dimensions, with every prospect of steady and healthy increase. He will carry with him on his retirement the affection and good wishes of all sections of the University.

#### SCIENTIFIC SERIALS

In the *Nuovo Giornale Botanico Italiano* for October, Sigg. G. Del Guercio and E. Baroni describe the disease of Italian vines caused by a Schizomycete, and known as *gommo i bacillare o feltura*.—Sig. C. Massalunga describes a large number of abnormal growths in different plants.—All the other papers concern the local Italian flora.

In the *Journal of Botany* for August, September, and October, Mr. F. J. Hanbury adds seven more to the interminable list of new species of *Hieracium*.—Rev. E. S. Marshall describes and figures an apparently new species of *Cochlearia*, *C. maritima*, from Ben Laxers.—Messrs. J. G. and E. G. Baker discuss the botany of an interesting corner of Westmoreland, High-cap Nick.—The Ericaceae and the Asclepiadaceae of South Africa are treated of, respectively, by Mr. H. Bolus and Mr. R. Schlechter.—Students of the local distribution of plants in Great Britain will find other papers to interest them.

*Symon's Monthly Meteorological Magazine*, October.—Protection from lightning, by A. McAule. This is a summary of one of the Circulars of Information issued by the Weather Bureau, Washington. In addition to a number of rules for erecting lightning rods, the pamphlet contains statistical tables of injury to life and property by lightning in the United States. Full recognition is given by the author of the Report of the Lightning Rod Conference published in 1882, and of the experiments made by Prof. Oliver Lodge.—The recent drought in the Midlands, by the Rev. G. T. Ryves. During 25 days ending September 21, only 0.06 inch of rain fell at Tean Vicarage. Mr. Symon shows that at Barkby, Leicestershire, 1.10 inch of rain fell. The same record shows that the first nine months of

1894 have been dry, but not nearly so dry as in some previous years.—Enormous hailstones, by G. J. Symons. This contains some cuttings from various papers of a severe thunderstorm which occurred over a large part of the continent on August 26 and 27 last. At Beaumont hailstones are said to have been picked up weighing nearly two pounds; at many places they weighed seven ounces and upwards, and many birds and some sheep were killed.—Climatological table for the British Empire for the year 1893, by G. J. Symons. The table contains data referring to temperature, rainfall, &c., at eighteen places. The highest temperature in the shade was 108° at Adelaide, on February 2, and the lowest 48° at Winnipeg, on February 1. The highest temperature in the sun was 171° at Trinidad, which also had the greatest rainfall, viz. 92.5 inches; the least fall was in London 19.8 inches.

SOCIETIES AND ACADEMIES.

PARIS.

Academy of Sciences, October 22.—M. Lévy in the chair.—Experimental verifications of the theory of weirs, with liquid sheets submerged below or adherent, relative to the delivery and the contraction in the lower part of the liquid sheet, by M. J. Bussinesq.—M. A. Trillat claims priority in regard to processes of disinfection by formaldehyde.—On the rotation poles of Venus, by M. C. Flammarion (see p. 21). Variations of the level of water in a basin communicating with a tidal port, by M. A. de Saint-Germain. A mathematical paper.—Force acting at the surface of separation of two dielectrics, by M. H. Pellat. In the general case, the force is normal to the surface of separation and in the sense that the specific inductive capacity diminishes. Its value per unit of surface is given by the formula

$$f = \frac{K_1 \phi_1^2 \cos 2\alpha_1}{8\pi} - \frac{K_2 \phi_2^2 \cos 2\alpha_2}{8\pi}$$

$\alpha_1$  and  $\alpha_2$  being the angles between the normal and the direction of the field,  $\phi_1$  and  $\phi_2$  the intensities of the field, on either side of the surface of separation.—Experimental researches on the freezing-point with different mixtures of alcohol and water, by M. Raoul Pictet. A table of the temperatures of crystallisation of definite mixtures is given, and the results are plotted in curves discussed in the paper.—A study of the combinations of hydrogen fluoride with water, by M. K. Metzner. The author has succeeded in obtaining only one hydrate possessing definite properties. It has the composition HF.H<sub>2</sub>O and contains 52.3 per cent of HF. The crystals of this composition melt at 35 C.; they fume in the air, and have a specific gravity greater than 1.15. They are very soluble in the cold concentrated acid.—Researches on the mercuric sulphates, by M. Raoul Varet. The thermal data for the normal sulphate and for the basic salt HgSO<sub>4</sub>.2HgO are given in detail. Whereas sulphuric acid completely displaces HCN from its combination with potassium liberating 254 Cal., hydrocyanic acid, even in dilute solution, replaces sulphuric acid in HgSO<sub>4</sub> with disengagement of 235 Cal. Similarly hydrochloric acid displaces sulphuric acid in HgSO<sub>4</sub>. Antimony vermilion is not an oxy-sulphide, by M. H. Baubigny. Analysis of the colouring matter of antimony vermilion, precipitated by sodium thiosulphate, shows that it simply a form of Sb<sub>2</sub>S<sub>3</sub>. Bismuth nitrosulphates, by M. H. Causse.—Salivary glands of the *Aquila*, *Hirundo*, &c., and *...*, by M. Borda. On an unexplained caterpillar ravaging the leaves and fruits of the fig-tree, in the neighbourhood of Puget-Thouvenin, by M. Decaux. On the mechanism of vegetable respiration, by M. L. Maquenne. The author shows that the ratio of CO<sub>2</sub> produced to O absorbed is sensibly altered by momentarily subjecting leaves to a vacuum, and the respiration is at the same time rendered unresponsive. The conclusion is given. The respiration of plants appears to be the result of the slow combustion of a very active compound, which the living cell constantly renews, each in the light, and which may accumulate when there is a deficiency of oxygen in the surrounding atmosphere. The mechanism of the water bird, by M. Naudin. Three geological maps of the French Congo, by M. Maurice Barrat. Late glacial phenomena in the Altai, by M. Venkoll.—Fossiliferous muds observed in an arctic lake, by M. V. Agassiz.

DIARY OF SOCIETIES.

LONDON.

THURSDAY, NOVEMBER 1.

LINEAN SOCIETY, at 8.—Contributions to the Knowledge of Monocotyledonous Saprophytes: Percy Groom.—On an Error in the Descriptions of the Effect of a Centrifugal Force upon Growth: Rev. G. Henslow.—On Mediterranean and New Zealand Ketepora, and a Fenestrate Bryozoa: A. W. Waters.  
 CHEMICAL SOCIETY, at 8.—The Electromotive Force of Alloys in a Voltaic Cell: A. P. Laurie.—The Action of Nitric Oxide on Sodium Ethylate: G. W. Macdonald and Orme Masson.—On Ethylic Butanetetra-carboxylate: Dr. B. Leach.

MONDAY, NOVEMBER 5.

SOCIETY OF CHEMICAL INDUSTRY (Burlington House), at 7.—The Composition and Constitution of certain Alloys, by the late Dr. C. R. Alder Wright, F.R.S.; Mr. Watson Smith.—Note on Oxidised Linseed Oil: Mr. W. F. Reid.

ARISTOTELIAN SOCIETY (22 Albemarle Street), at 8.—An Essential Distinction in Theories of Experience: Mr. Bernard Bosanquet.

TUESDAY, NOVEMBER 6.

ZOOLOGICAL SOCIETY, at 8.30.—Descriptions of New Species of Flebotomyids and Allied Genera of Coleoptera: Mr. Martin Jacoby.—On the Hybrid Arch of *Ceratodus*: Mr. W. G. Ridewood.—Third Report on Additions to the Batrachian Collection in the Natural History Museum: Mr. G. A. Boulenger, F.R.S.  
 ROYAL VICTORIA HALL, at 8.—The Electric Spark: Prof. A. W. Rücker, F.R.S.

WEDNESDAY, NOVEMBER 7.

GEOLOGICAL SOCIETY, at 8.—Notes on some Recent Sections in the Malvern Hills: Prof. A. H. Green, F.R.S.—The Denbighshire Series of South Denbighshire: Mr. Philip Lake.—On some Points in the Geology of the Harlech Area: Rev. J. F. Blake

ENTOMOLOGICAL SOCIETY (11 Chandos Street, Cavendish Square), at 8.

THURSDAY, NOVEMBER 8.

MATHEMATICAL SOCIETY, at 8.—Mathematics, President's Address: A Generalised Form of the Hypergeometric Series, and the Differential Equation which is satisfied by the Series: F. H. Jackson.—Third (and concluding) Memoir on certain Infinite Products: Prof. I. J. Rogers.—On the Kinematics of Non-Euclidean Space: Prof. W. Burnside, F.R.S.  
 INSTITUTION OF ELECTRICAL ENGINEERS, at 8.—Notes on Electric Tramsways in the United States and Canada (Supplementary Paper): H. D. Wilkinson.—Electric Traction, with Special Reference to the Installation of Elevated Conductors: R. W. Blackwell and Philip Dawson.

FRIDAY, NOVEMBER 9.

PHYSICAL SOCIETY, at 5.—The Photographic Action of Stationary Light Waves: J. Larmor, F.R.S.—On Vapour Pressure: Prof. S. Young, F.R.S.—On the Luminescence of Glass: John Burke.  
 ROYAL ASTRONOMICAL SOCIETY, at 8.

SATURDAY, NOVEMBER 10.

ROYAL BOTANIC SOCIETY, at 3.45.

CONTENTS.

PAGE

Past and Present. By Right Hon. T. H. Huxley, F.R.S.	1
Economic Products of India. By W. T. B.	4
Chinese and Japanese Butterflies. By W. E. K.	6
Our Book Shelf:—	
Collinson: "Rainmaking and Sun-shine."—W. E. P.	7
Hoskins: "The Elements of Graphic Statics: a Text-Book for Students of Engineering."—G.	7
Eha: "A Naturalist on the Prowl"	8
"A Son of the Marshes": "From Spring to Fall".	8
Cooke: "Edible and Poisonous Mushrooms"	8
Letters to the Editor:—	
What are Acquired Characters?—Right Hon. Sir Edw. Fry, F.R.S.	11
Discontinuous Motion.—A. B. Basset, F.R.S.	11
Capacity for Heat.—E. H. Griffiths	11
The Swallowing of One Snake by Another.—Baron C. R. Osten-Sacken	12
On Recent Researches in the Infra-Red Spectrum. <i>Illustrated.</i> By Prof. S. P. Langley	12
The Treatment of Diphtheria by Anti-toxic Serum. By Dr. M. A. Ruffer	16
Notes	18
Our Astronomical Column:—	
The Spectrum of $\delta$ Cephei	21
The Rotation of Venus	21
The Lowell Observatory	21
The Mean Parallax of Stars	21
The Institution of Mechanical Engineers	22
A New Method of Preparing Phosphoretted Hydrogen	23
University and Educational Intelligence	23
Scientific Serials	23
Societies and Academies	24
Diary of Societies	24

THURSDAY, NOVEMBER 8, 1894.

## ANCIENT METEOROLOGY.

*Theophrastus of Eresus, on Winds and on Weather Signs.* Translated, with an Introduction, and an Appendix, by Jas. G. Wood, M.A., LL.B., F.G.S., and edited by G. J. Symons, F.R.S. London: Stanford, 1894.

THIS book owes its appearance in an English dress to the action of Mr. G. J. Symons, who believed its contents to be of such value and interest, that he offered to defray the expenses of publication provided a competent authority would prepare a translation of his neglected author. An able and willing translator was found in Mr. J. G. Wood, sometime Fellow of Emmanuel College, Cambridge, and we are thus put in easy possession of the thoughts and the science of Theophrastus, or it may be the wisdom of Aristotle, filtered through the mind of his favourite pupil. It need scarcely be said that the book possesses a greater interest for the archæologist than for the pupil of modern science, whose habit of thought is so different from that of the old Greek author, that he will have a difficulty in attempting to follow him.

A main object that Mr. Symons had in his generous proposal was to offer the means for the study of the gradual growth of our knowledge of meteorology, as exhibited in the literature of past ages. He has, therefore, begun at the fountain-head, or as near as was possible or desirable. Mr. Wood seems to have been animated by a somewhat similar ambition. He is afraid that in the study of meteorology, as at present existing, the student may be tempted to forget "the far-off and small but necessary beginnings which have conduced to such an end." In this sentence there are several words to which one might, if in a captious mood, take exception. For instance, can meteorology, in any sense, be said to have its beginning in the school of Aristotle or Theophrastus? Certainly not in the same sense in which astronomy could be said to have its rise in the work of Hipparchus or Ptolemy, for whatever errors may have vitiated their reasoning and impaired their results, they were in an advanced position compared with those who taught or who studied meteorology before they had an adequate conception of the existence of an atmosphere. Again, is it necessary that science should have its origin in error? Hasty generalisations, imperfect judgment from insufficient facts, one must expect, but there will always be a central thought which successive students will develop and render fruitful, and in Theophrastus this germ seems to be absolutely wanting. It is rare, if not impossible, to find any paragraph which is scientifically correct, or in which any train of reasoning is sound, so that we fail to see how the efforts of Theophrastus and his predecessor have in any way conduced to the position, imperfect as it is, in which meteorology now stands. Mr. Symons has told us that he hoped to capture some new thought from the study of this author. We venture to say he has been disappointed, for whatever interest the book may have for the curious

and the literary student, it has little or none for the scientific.

We have in this little book two treatises, or (as Mr. Wood says we should now call them) "papers," of Theophrastus, one on "The Winds," the other on "Weather Signs." Both are marked by traces of haste in their original compilation, and assume a better acquaintance with the writings of Aristotle than most people at the present day possess. But even with this knowledge, the author is difficult enough to follow; accordingly Mr. Wood in his introduction has endeavoured to give the English reader a notion of Aristotle's views on Wind. This it will be admitted is no easy task, within the small limits permitted to the translator; and if the explanation is not everywhere so clear nor so full as could be wished, the fault lies not with Mr. Wood, but in the intricacy of the subject, and in the difficulty the reader finds in endeavouring to follow the subtleties of Aristotle, and of accommodating modern thought and knowledge to the ancient methods of expression. It is a treat, after wandering through the mazes of "dry sublimation" and "moist sublimation," to come to Mr. Wood's summing up of the whole matter, in which he endeavours to concentrate his intimate knowledge of this subject, as it presented itself to the Greek mind. "The winds"—and Mr. Wood draws a necessary and picturesque distinction between *πνοή*, *ἀνεμος*, and *πνεῦμα*—are separate and distinct entities, flowing in definite courses, and not mere movements of the same air hither and thither: that to produce wind matter has to be formed, and the more matter the greater the wind; and this matter is derived from the earth, and is distinct from vapour.

With these misconceptions influencing the Greek mind, and giving rise to infinite confusion, it would be tedious to point out all the errors into which Theophrastus fell. He was apparently not the kind of man to substitute patient and exact observation for the assertion and teaching of authority, or we might have had to hail him as the founder of exact meteorology. One example will suffice to illustrate his success as an original investigator. We select the subject of annual or periodic winds *ἐτήσια*, which Mr. Wood renders not very happily by "monsoons." The origin of these winds our author teaches us is to be traced in the melting of the snow. As the sun breaks up the frost, it sets the air in motion, giving rise to the "monsoons," and inasmuch as the thaw does not proceed with perfect regularity, so the wind varies in constancy. At night, when the action of the sun is less powerful and the thaw does not proceed, the wind ceases to blow, but under exceptional circumstances the thaw may be so rapid that the wind is perceived at night. Did none of his pupils seek to verify these statements?

The attempts at weather forecasting are naturally not more happy than those dealing with meteorological science, as now generally understood, but possibly quite as accurate as many of the predictions quoted in our days, having for their object the determination of the weather for a considerable period in advance. Certainly they rest on a foundation quite as sound, and doubtless assume an equal ignorance in the public, that circulate them from mouth to mouth, or it may be from newspaper

to newspaper. "Whatever," says Theophrastus, "be the condition of the air at the setting of the Pleiades, such it continues for the most part, until the winter solstice." This would cover practically nine months of the year, if by the setting of the Pleiades is meant the setting with the sun. The moon, too, is either the cause of a change or the prognostication of it. "The change takes place for the most part on the fourth day, and if not then on the first quarter, and if not then at the full." A weather prophet of to-day would be discredited if he hedged in this way. A clear crisp statement is now necessary to secure credence, and attach disciples to the school of the modern weather prophet. As one turns over the pages that give the signs of fair or foul weather, signs all more or less puerile, one is reminded of the saying that Plato has preserved for us, Ἐλλήνες αἰεὶ πῦρές ἐστε.

We can have no hesitation in asserting that the appendix is the most valuable part of the book. Herein, Mr. Wood has given an excellent account of the gradual changes introduced in the nomenclature and in the subdivision of the winds from the time of Homer and Hesiod, through the Middle Ages, down to the present time. Such an account is not only of great assistance to the correct apprehension of old authors, but gives a great deal of information on the introduction of fresh terms in the description of the winds. Mr. Wood seems distressed as to the exact localisation of a wind that is defined by reference to the azimuth of the sun, at rising or setting at the summer and winter solstice. Of course the azimuth varies with the latitude of the place of observation, but Aristotle, writing for Greeks, described positions as they were seen in Greece. Mr. Wood might as well have taken into account the effect of refraction at the horizon, or the alteration in the obliquity of the ecliptic. In these days, we rarely attempt to determine the direction of the wind within 20°, and it is scarcely likely that greater accuracy was attempted in Greece. But whether Aristotle spoke of the equator or Athens, the whole difference is only about 6°, so that the question of accuracy hardly enters. We congratulate Mr. Wood upon the amount of well-digested information he has been able to give in this chapter. W. E. P.

#### TWO BOOKS ON AMERICAN ANTIQUITIES.

*Tales amongst the Indians, their Ancient Earthworks, and Temples; including a Journey in Georgia, Mexico, and Yucatan, and a visit to the Ruins of Palenque, Tutun, Pucucque, and Uxmal.* By Vice-Admiral Lindley Brine. London: Sampson Low, 1893.

*Journal of the Academy of Natural Sciences of Philadelphia.* Second series, vol. 3, part 1. Philadelphia: Academy of Natural Sciences, 1894.

ADMIRAL BRINE'S pleasantly written book is the record of a journey made through the United States, Guatemala, and Yucatan in the years 1869-70. It is to be regretted that his notes were not published at once on his return home, as in those days Guatemala and Yucatan were still almost unknown lands, and since that date half a dozen books—few of them, it must be

admitted, of great value—have made the country more familiar to us.

The particular object of Admiral Brine's journey was the examination of the earthworks and temples of the American Indians, and the first portion of the book is devoted to the red man and his works. Several months were occupied in examining the mounds and earthworks in Ohio.

On the difficult question of age, the author favours the view that the circular and octagon enclosures are of comparatively late date.

"But the figure which would have been absolutely impracticable to construct without proper surveying appliances for making accurate measurements, and fixing the true angles, is that of the octagon. Even under the most favourable circumstances, with the help of suitable instruments, it would have required much skill and calculation to trace a true octagon, whose embankments contained within them an area exceeding forty acres. It is difficult to suppose that an accurately designed work of this shape and magnitude could have been planned by Indians, or that the construction of a figure so essentially scientific and unusual, could have been originated by them. It is therefore possible to conclude that the geometrical earthworks in Ohio may have been raised by native tribes, acting under the direction of European surveyors, or men who had received a mathematical education."

Concerning the Indian tribes who actually did the work of raising the embankments, the author adds in a note that—

"Nothing has been found amongst the ornaments or weapons that were placed in their burial mounds, which supports the hypothesis that they were different in race or intelligence from the tribes that surround them."

From San Francisco, Admiral Brine sailed down the Pacific Coast to Guatemala. He tells a story of Carrera, that remarkable Indian of pure blood, who was for so long the President of the Republic, and of whom mention is often made in "Stephens' Incidents of Travel in Central America."

"Colonel Garcia told us that Carrera always had on his writing-table a toy representing Louis Philippe with his hat in his hand. This toy had a rounded base, and was so weighted that, when it was touched, it rolled backwards and forwards, and would thus represent Louis Philippe constantly bowing, hat in hand. Carrera when engaged in official work would frequently make the toy move, and then would say to those who stood near him, 'It seems in that way, by too much bowing, that Louis Philippe lost his throne. I shall take care that I do not make the same mistake.'"

A journey in Guatemala in 1870 was by no means as free from risk as it is at the present day. "pronunciamientos" and Indian risings were not of uncommon occurrence, and Admiral Brine was fortunate in escaping any serious danger; but he, no doubt, principally owed his immunity from trouble to tact and good temper in his dealings with the Indians. He was usually indebted to the "padres" for hospitality on the road, and learnt from the priests themselves how independent the Indians had become in matters of religion.

"'The Indians come and go as they please,' said Father Hernandez, 'light their own candles, hold their own services before the altar, and frequently take one of the saints out of the church, and carry it away to



some hut, where for several days they will perform musical ceremonies before it, and then the saint will be brought back to its proper altar—and again, ‘they come from afar to make offerings of blossoms and leaves, light candles before the altars of those saints they wish to honour, and then silently return to their huts.’”

There can be little doubt that in pre-Christian times they were accustomed to an elaborate ritual, and it was partly for this reason that they took so readily to the ceremonies of the Roman Church, but they never quite abandoned their old beliefs. The twenty-four years that have elapsed since Admiral Brine's journey have not made much difference in this respect; and little rough altars may any day be found on the tops of abandoned temple mounds with the scent of incense still hanging about them.

Admiral Brine camped for a few days in the ruined temples at Palenque, and then travelled northwards to Yucatan and visited the ruins of Uxmal. The last two chapters give an interesting summary of the author's notes and the conclusions to which he has come. With these conclusions it is not always possible to agree; but that is not much to be wondered at, when dealing with a subject which is so closely enveloped in mystery as the civilisation and migrations of the races of America.

Happily we can feel assured that a distinct advance in our knowledge of the subject is being made, and that there is a fair prospect that, within the next few years, some at least of the mystery will be rolled away.

A good example of the very careful work which is being done by numerous scientific societies in America, in collecting and examining prehistoric remains, can be seen in Mr. Clarence B. Moore's account of his excavations in the sand mounds of the St. John's River in Florida, and Mr. W. H. Holmes's notes on the pottery from these mounds, which was submitted to him for examination, both published in the *Journal* of the Philadelphia Academy of Sciences.

The sand burial mounds occur frequently in the neighbourhood of large shell deposits. They are usually stratified, the layers consisting of different coloured sand, with sometimes a slight admixture of shell, and the human bones and other objects are most frequently found in a layer of sand of a pinkish colour, due to the presence of powdered hematite.

It is not unusual to find in Indian burial mounds pottery which has been purposely broken before burial, as though in observance of some ceremonial rite, but in these sand mounds Mr. Moore found mortuary pottery in which the breakage or perforation had been made before the pottery was fired.

With some of the surface and intrusive burials were associated iron and brass objects, showing them to have been post-Columbian; but nothing indicating contact with Europeans was found associated with the deeper interments, and many of the mounds were entirely free from evidence of contact with white men.

At Thursby Mound a number of very curious rough pottery figures were found, representing squirrels, turkeys, fish, turtles, &c., as well as some vegetal forms, which are extremely rare in the normal art of the United States. The illustrations which accompany these notes are numerous and excellent.

As we hear that Mr. W. H. Holmes, whose admirable work is so well known, is leaving the Bureau of Ethnology at Washington, in order to take charge of the new and liberally endowed museum at Chicago, which is the outcome of the great World's Fair, we may look for steady and increasing contributions to our knowledge of the Indian races and their arts, which will not be limited to the result of investigations in the territory of the United States, but will include the whole American continent.

The Peabody Institute of Massachusetts (principally owing to the liberal support afforded it by Mr. C. Bowditch, of Boston) has been able to set a good example in commencing systematic work on the central civilisations, by the investigations now being carried on at the ruins of Copan, the site of which has been acquired on lease from the Government of Honduras for a period of ten years. The Peabody Museum at Cambridge, with its fine collections of pottery, original sculpture and casts, is fast becoming a centre for the study of American antiquities.

#### WATTS' DICTIONARY OF CHEMISTRY.

*Watts' Dictionary of Chemistry.* Revised and entirely re-written. By M. M. Pattison Muir, M.A., and H. Forster Morley, M.A., D.Sc. Assisted by eminent contributors. Vol. IV. With Addenda. 8vo. Pp. 922. (London and New York: Longmans, Green, and Co., 1894.)

THE completion of the grand work before us renders it possible to form a fair estimate of its features and its general character. No candid reader can fail to appreciate the industry displayed by the editors and contributors, in bringing together and sifting out the vast mass of existing matter, in a science which is experiencing so rapid a growth. Perhaps a greater difficulty has been encountered in compressing within reasonable limits the facts which must claim insertion. This end has been reached by a style laudably laconic, but at the same time free from obscurity, and by an ingenious system of abbreviations, the editors—or we might better say the authors, since the entire work has been re-written—have confined themselves to the pure science, leaving its thousand and one applications in manufactures, metallurgy, and agriculture, to be dealt with in the “*Dictionary of Applied Chemistry*,” issued by the same publishers. Without this limitation, the cost of producing the work would have been simply prohibitive.

Many of the articles included in this volume are, in their value and extent, almost worthy to rank as independent works. As instances we may mention the section on the Proteids; that on the Ptomaines—which might have been a little more extensive—the article on Phosphorus; and, above all, that on the Physical Methods used in Chemistry. This article, which extends to 100 pages, treats separately of methods based on capillarity, of crystallographic methods, of dialysis and diffusion, of dynamical methods, of electrical methods, of procedures based on the freezing-points of solutions, of optical methods, of methods based on osmotic pressure, of photographic methods, of methods turning on the specific

means of solids, of thermal methods, of those based on the vapour-pressures of solutions, of the viscosity of liquids, and of methods based on volume-changes.

The chapter on electrical methods is supplied by Prof. Dr. Ostwald, of the University of Leipzig. The author gives an account of the rise of electro-chemistry and of its development by Berzelius and Hisinger, and of its dominance down to 1840. It is remarked that, after his first investigations, Berzelius did not undertake any experimental work on the action of electricity upon chemical compounds. After 1840 this theory was found incapable of explaining facts which were being brought to light in the region of organic chemistry, whilst its physical foundations were shaken by the researches of Faraday. More recently, Hittorf, Arrhenius, Helmholtz and others have founded a new electro-chemical theory. Mention is made of the discussion—not yet decided—as to the origin of the current in the pile. The conception of ions as the material conveyance of the current has been gradually introduced since the researches of Clausius, and is taken into account in our views of decomposition. Not less interesting is the account of optical methods. The first part, from the pen of Mr. G. Gladstone, discusses refraction and dispersion; the second, on spectroscopic methods, is contributed by Prof. W. N. Hartley, F.R.S.; and the third part, on the rotation of the plane of polarisation of light, is by Prof. Pattison Muir. In the part treating of the spectroscopic methods we find studies of the infra-red and ultra-violet absorption spectra, with notices of the researches of V. Schumann, Waterhouse, Crookes and Gladstone. In connection with the absorption spectra—a subject by no means fully explored—we have a notice of Witt's views on the cause of colour in organic compounds.

Among the elements admitted or supposed, we find in this volume, notices of phosphorus, platinum, potassium, rhodium, rubidium, ruthenium, samarium, scandium, selenium, silicon, silver, sodium, strontium, sulphur, tantalum, tellurium, terbium, thallium, thorium, tin, titanium, tungsten, uranium, vanadium, yttrium, ytterbium, zinc and zirconium, with compounds or derivatives.

The authors and contributors are noticeable for a sobriety of statement; they do not indulge in premature conclusions and in speculations for which evidence is lacking.

As regards the elements, the Mendelejeff classification is adhered to, and in the accounts of their preparation the recent results of Moissan have not been overlooked.

The addenda comprise facts in mineral chemistry which have been observed since the appearance of Vols. I., II., and III. and the printing off the final proofs of the present volume. The addenda include nothing on organic chemistry; since to have noticed the recent discoveries in that department would, in the opinion of Mr. Pattison Muir, have required the addition of many hundred pages.

On comparing the present work with former dictionaries of chemistry, whether in English or in any other language, its superiority will appear beyond all question. It will be the obvious duty of all universities, colleges, &c., at once to add this new edition of "Watts" to their libraries.

### DISEASES OF TREES.

*Text-Book of the Diseases of Trees.* By Prof. R. Hartig, of Munich University. Translated by W. Somerville, Professor of Agriculture and Forestry, Durham College of Science, Newcastle. Revised and edited by Prof. H. Marshall Ward, F.R.S. (London and New York: Macmillan and Co., 1894.)

DER Lehrbuch der Baumkrankheiten von R. Hartig" has now appeared in English with all the admirable illustrative plates of the second edition, except the coloured plates at the end of the book, which represent spruce and oak wood decomposing under the influence of different fungi, and are therefore somewhat exterior to the proposed scope of the work, "the diseases of trees." The original, as Marshall Ward states in the preface to the present version, owes its great charm "to the simple method of exposition of the facts and principles conveyed, as well as to the astounding richness of the information it contains. This is unquestionably owing to Hartig's prominence as the leading investigator and authority on the fungoid diseases of forest trees."

The great superiority of Hartig's work in this subject has been acknowledged in France, by the publication there, in 1891, of a French translation by Profs. Gerschel and Henry, of the Nancy Forest School, which was entirely revised by the author.

Prof. Somerville, the translator of the present English edition, has followed a complete course of forestry at a German forest school, and has been for some time engaged in forestry instruction at Edinburgh and Newcastle. He has already written a valuable little book on the structure of European timbers. The translation of Hartig's book follows the original closely, and is smooth and free from Germanisms.

The editor, Prof. H. Marshall Ward, whose qualifications for the work need no comment, has written an excellent preface, besides revising the translation and supplying short foot-notes in explanation of all scientific terms, which might puzzle readers who have not studied vegetable physiology very deeply, and in a few cases giving his own opinion where he does not coincide with the authors.

In the preface, the bold but thoroughly justifiable statement is made that students of agricultural chemistry, or of the physics and chemistry of soils, must thoroughly master the facts of the structure and essential phenomena of life by experimental investigation, and that the chemistry of the soil taken alone is of less practical importance. The fact is, that although the want of sufficient suitable chemicals in a soil may render certain tree-growth stunted and unproductive, yet the physical nature of the soil, *i.e.* its degree of division and hygroscopicity, and the climate of the locality, are more important than the former to ensure a healthy and vigorous tree-growth; whilst a good coating of decomposing dead leaves will render a soil, which is chemically and physically poor, capable of producing a fair crop of timber. The influence of earthworms on soils has been dealt with by Darwin, whilst that of bacteria and other low organisms in decomposing organic debris to form

humus, and otherwise assisting in the nutrition of plants, has yet to be dealt with in a special treatise. Considering the exhaustive and expensive investigations which are carried out in the research of animal pathology, a large expenditure by the State on the influence of bacteria on soil and water would be justifiable, and would lead to highly important improvements in agriculture and gardening.

The editor meets possible objections from botanical critics to Hartig's classification of fungi, by remarking that it is not fungi which are being studied here, but their action on trees, and that students may obtain a thorough knowledge of fungi elsewhere; he refers the forester who may be anxious to know the remedies against disease to special works,<sup>1</sup> although Hartig has given many practical hints as to treatment in certain cases.

The book's great value lies in the way it teaches students how to investigate disease, and a wide field is still open to discovery in this respect.

The author's introduction chiefly deals with the causes of disease and the procedure for investigating them; and it is reassuring to read that the transmission by inheritance of disease is unknown in the vegetable kingdom, and that we may use without hesitation the seed of plants suffering from any conceivable disease, and that with them the law of inheritance is only involved in the case of marked peculiarities, such as twisted fibre, dwarfed habit, and other undesirable peculiarities. Superior individual growth, however, is recognisable in the size of the fruit, and large acorns produce vigorous oak saplings.

As regards the distribution of matter in the work, the first forty pages after the introduction deal with diseases caused by plants other than fungi. Hartig states that he has not noticed any appreciable damage done to forest plants by *Cuscutæ* or dodders, but Hess states that osier willows are greatly damaged by *Cuscuta Gronovii*, Willd., an American species which has established itself in Germany. The places where the *haustoria*, or sucker-like roots of the parasite, pierce the cortex of the plants, are rendered brittle, and the osiers so attacked become useless for basket-making. The only remedy appears to be to cut down the affected shoots in June and July, when the dodder blossoms, and burn them. Bacteria which cause such terrible diseases in animals rarely harm plants, owing to the closed nature of their tissue elements as compared with the anastomosing veins and lengthy digestive apparatus of animals.

The main portion of the book—pages 40-224—deals with damage done by fungi; and after a general description of their mode of life, a very clear account is given of the life-history of each destructive fungus, and of its effects on its host. Fortunately, whilst several of these species may destroy a few hundred trees here and there, the only fungus which can be compared for its ravages on whole woods with certain destructive forest insects is *Peziza Willkommii*, which causes the widespread larch disease, and has rendered the cultivation of larch almost impossible in certain districts in Great Britain and the north of Germany, though it is said not yet to have occurred in

Ireland. The best preventive measure is to plant larch only on suitable soils and in open airy situations, and to mix it with other trees, and especially with beech.

Besides dealing with fungi which infest living trees, there is a most interesting account of those which attack timber, and thoroughly practical suggestions are given for dealing with dry-rot caused by *Merulius lacrimans*.

Section ii. (pages 226-269) deals with wounds, and the mode nature adopts for healing them, and also with the dangers they afford by the admission of the spores of fungi to the interior of a tree. It is pointed out how branches should be pruned or shortened so as to avoid, as much as possible, the chances of future decay. Hartig states that he has never known an instance of coal-tar, when used for dressing wounds in trees, having proved hurtful to them, although some foresters have asserted the contrary.

Section iii. (pages 270-281) deals with diseases due to certain conditions of soil, the chief predisposing factor being the want of free circulation of air in the soil, which may cause root-rot in conifers, though, according to Hartig, never in broad-leaved species. This latter statement may not, however, be quite correct, as Spanish chestnut appears sometimes to suffer from root-rot, owing to this cause.

Section iv. (pages 281-304) deals with diseases caused by atmospheric influences, frost, insolation, want of light, hail, fire, coal-smoke, and lightning, and the book terminates with a classified list of diseases arranged according to the species of tree attacked, and the respective organs which suffer.

W. R. FISHER.

#### OUR BOOK SHELF.

*Le Centre de l'Afrique. Autour du Tchad.* Par P. Brunache. (Paris: Felix Alcan, 1894.)

THIS record of travel in a previously unknown region of north tropical Africa is published as volume 79 of *Bibliothèque Scientifique Internationale*, although there is nothing scientific about it, and the standpoint of the author, so far from being international, is exclusively and almost obtrusively French. The words "Autour du Tchad," which are repeated as the running title of the book, are entirely misleading, for the writer never came into the vicinity of Lake Chad at all, but passed more than 200 miles to the south of it. These are all the adverse criticisms we have to offer. For the rest, the book is lively reading, and has the merits of brevity and point. M. Brunache went out in 1891, as second in command to M. Dybowski, in an expedition for the relief of M. Paul Crampel, who had set out a year before, with small resources, from French Congo, to try to reach Lake Chad. Landing at Loango, the Dybowski expedition went to Brazzaville, on the Congo, and thence up the Mobangi and through a blank area of the map, peopled by Dakoas and N'Gapus, across the watershed between the Congo and Shari systems to nearly 8° N. The place of Crampel's murder was found, and a good deal of punitive fighting was carried on with the Mohammedan negroes; but here, at Crampel Peak, Dybowski found that it was impossible to go farther, and the expedition returned to the French outposts on the Mobangi. M. Brunache is careful to show how much better qualified he was for the command than the appointed leader, of whose wishes he seems not to have been too considerate. On his way to the coast our author met the expedition of

<sup>1</sup> For instance, a translation of Hess's "Forest Protection" is now in the press, and deals with these questions in detail.

M. Maistre, to which he transferred himself, and again crossed the Congo-Shari watershed, made friends of many of the native tribes, obtained treaties in the usual way, and, pushing onwards, in spite of considerable hardships, descended one of the tributaries of the Shari, struck westwards to the Benue, and so returned by the Niger. The expeditions, which were two of the most important of the last few years, did much valuable work in geography and natural history; indeed, M. Brunache insinuates that Dybowski was too much devoted to collecting specimens to make an ideal commander.

The book contains many interesting but unsystematic notes on a number of tribes which were visited for the first time by Europeans. Except the Bonjos on the lower Mobang, and the Mohammedanised natives of the Sadin, they were all cannibals, eating their enemies killed in battle, and occasionally their slaves. Amongst all the tribes, women were well treated and consulted on affairs of importance. The costume and habits of the Saras, a particularly tall tribe, who inhabit the Shari basin between 8 and 9° N., are described, we believe, for the first time, and with such fulness and tact as only a Frenchman can employ. In their country the surveys of the expedition touched those of Nachtigal, who had penetrated so far southward across the Sahara, and thus completed the chain of modern European itineraries in West Africa from the Mediterranean to the Cape of Good Hope.

A number of reproductions of sketches exhibit types of the natives encountered, and specimens of their art and manufactures.

*Helical Gears.* By a Foreman Pattern Maker. (London: Whittaker and Co., 1893.)

THIS little book belongs to "The Specialists Series": it is entirely of a practical nature, and deals with a subject little understood by engineers who do not happen to be machine-tool makers. As there is probably no other text-book on this subject, the work will fill a useful purpose. The author observes that a large proportion of so-called helical gears are incorrectly made, and are therefore far worse than common gears. With this observation we certainly heartily agree. Cases are known where an otherwise good machine has been spoiled by the use of badly designed helical gearing.

The arrangement of the information is good. Illustrations and diagrams are freely used, so that what would otherwise be difficult to understand becomes clear and apparent. Patterns are clearly dealt with, and their manufacture fully described. It is here the hand of the practical man becomes evident. Many hints are given, and instructions formulated, which favour strongly of the "works." The author does not pretend to deal with the purely theoretical side of his subject, excepting in so far as the fundamental relationships of the helical gears to the true screw or helix is concerned. Beyond this the book is entirely of a practical character, being eminently fitted to fulfil the requirements of the draughtsman and the works. N. J. L.

*The Nest and Egg of Non-Breeding British Birds.* By Charles Dixon. Pp. 74. (London: Chapman and Hall, 1894.)

"The present work," remarks Mr. Dixon in his preface, "forms the complementary to 'The Nests and Eggs of British Birds,' and covers the subject of British Birds completely, so far as our knowledge now extends. It deals progressively with the incubation of the birds that do not breed in the British Archipelago, but visit our islands irregularly, winter, pass our coasts on passage, or pay their annual or less irregular visits to us, whether from their normal mode of dispersal. Very few of our birds possess incubation belonging to any one of the four or a half, incubation periods, as to

the breeding area, breeding habits, range of egg colouration and measurement, and the diagnostic characters of the eggs. In an appendix, the author states his reasons for believing that the nests and eggs of the following species are at present unknown to science:—Rustic bunting, Pallas's grey shrike, Siberian ground thrush, needle-tailed swift, solitary sandpiper, Siberian pectoral sandpiper, curlew sandpiper, knot, Ross's gull, great shearwater, collared petrel, capped petrel, Cape petrel, and white-billed diver. A list of forty species, individuals of which have been said to occur within the limits of the British Isles, but which Mr. Dixon regards as doubtful British species, is also appended to the volume. It remains for the scientific naturalist to collect some definite information on the species enumerated in these lists.

*Commercial Geography.* By E. C. K. Gonner, M.A. Pp. 200. (London: Macmillan and Co., 1894.)

COMMERCIAL geography, dealing as it does with the facts that affect manufactures, commerce, and agriculture, ought to be widely studied in a nation having such pronounced shopkeeping proclivities as the English. It is right and proper that those who are to be the custodians of our trade in future should know something about the manner in which physical and political surroundings affect industry and commerce, and about the conditions of success in the various industrial branches. Prof. Gonner treats these matters in a way likely to impress students. His manual is divided into three parts, the respective subjects of which are: 1) commercial geography and its principles; 2) the geography of the chief products and others; (3) countries, their agriculture, industries, and commerce. Trustworthy statistics are plentifully distributed throughout the book, and they serve to give an idea of the relative importance of different countries as regards different commodities, as well as being useful for reference. Of course, no student would be expected to commit these tabular statements to memory. If the main facts contained in this volume are grasped by students intended for commercial careers, British commerce will undoubtedly be benefited.

*Dynamometers and the Measurement of Power.* By John J. Flather, Professor of Mechanical Engineering, Purdue University. (New York: John Wiley and Sons, 1892.)

A USEFUL practical treatise on this subject, in a convenient form for Technical Students, containing also the mechanical theory required in the calculations.

The author has himself carried out a notable experiment in the measurement of the power of a full-sized American locomotive, which was jacked up, and the power taken off by heavy supporting wheels; a valuable object-lesson for the pupils of his Experimental Laboratory of Purdue University. The long-continued measurement of the power, coal and water consumption, &c., of a large engine in full work—for instance of a steamer, the *Meteor* and others—is one of the most interesting and instructive that can be provided for a class of enthusiastic students of mechanical engineering. G.

*Electric Light and Power.* By Arthur F. Guy, A.M.I.E.E. Pp. 346. (London: Biggs and Co., 1894.)

SOME books, like the pedlar's razors, are made to sell rather than for use. Mr. Guy's volume is not one of these. It has been issued "for the purpose of placing on record useful practical knowledge obtained by the author during several years' experience of central-station work, together with brief explanations of the laws which govern the action of electrical apparatus in general use for electric lighting." This brief description shows clearly the ground covered. There are many similar works in the market, but we do not know of one better suited to give the manipulator of electric dynamos an intelligent knowledge of the forces with which he has to deal.

## LETTERS TO THE EDITOR.

[The Editor does not hold himself responsible for opinions expressed by his correspondents. Neither can he undertake to return, or to correspond with the writers of, rejected manuscripts intended for this or any other part of NATURE. No notice is taken of anonymous communications.]

## Prof. Boltzmann and the Kinetic Theory of Gases.

IN the discussion which followed the communication of my Report on Thermodynamics to the British Association at Oxford this year, Prof. Boltzmann made some remarks which appear to have been interpreted in a different light to what he doubtless intended. In the absence of any shorthand writer's verbatim report of the discussion, it is of course impossible to recall his exact words, but I feel sure that Prof. Boltzmann will be much astonished to learn that his statements are now widely circulated and quoted as being an authoritative admission that the Kinetic Theory of Gases is nothing more than a purely mathematical investigation, the results of which are not in accord with physical phenomena; in short, a mere useless mathematical plaything.

Is it likely that such an able physicist would have devoted so many years to the development of the theory, and would continue to work at it now if he regarded it in that light? Having had several conversations with him, both during and after the British Association meeting, I gather that his views are not nearly so pessimistic as the opponents of the kinetic theory would wish to maintain.

The statements were made in reply to a question as to how far the ratios of the specific heats of gases as given by theory accorded with the results of experiment. What I understood Prof. Boltzmann to imply was that his investigations treated the matter purely from a mathematical standpoint, but that the values he obtained by regarding the molecules of a gas as rigid bodies, viz. 1.6 for smooth spheres, 1.4 for smooth solids of revolution, and 1.3 for solids of any other form, accorded on the whole *very fairly* with the results of experiment. In that respect the kinetic theory stands on exactly the same footing as any other theory of mathematical physics. The evidence in favour of the fundamental assumptions of *any* theory necessarily rests on the agreement or want of agreement of the deductions with experience after due allowance is made for the fact that the conditions imposed by the mathematical difficulties of the investigation necessarily differ from those occurring in nature. I need only refer to Prof. Boltzmann's paper, "Ueber die Natur der Gasmoleküle" (*Sitzungsberichte der Wiener Akademie*, lxxiv. ii. 1876), for a more detailed account of his views on the question of the specific heats.

The objection which has been regarded by some as most antagonistic to the kinetic theory is that it does not afford an explanation of the spectra of gases. But is this duty required of it? If the luminosity of gases were due to vibrations of the atoms in the molecules, certainly there *would* be a difficulty about regarding the molecules as rigid bodies; but then such a hypothesis would preclude a gas whose molecules were monatomic from having any optical properties whatever. To my mind, the electromagnetic theory of light entirely relieves the kinetic theory from the burden which has been imposed on it by its opponents, since it (for example) we regard the molecules of a gas as perfectly conducting hard spheres, spheroids, or other bodies moving about in a dielectric "vacuum" (*i.e.* space devoid of ordinary matter), we shall be able to account for the spectra by means of electromagnetic oscillations determined by surface-harmonics of different orders without interfering with the assumptions required for explaining the specific heats of gases. There are, however, other questions on which I should be glad to see a continuation of the brilliant discussion which had to be curtailed from want of time at Oxford.

G. H. BRYAN.

Peterhouse, Cambridge, October 23,

## Instinctive Attitudes.

MY attention has been called to Mr. H. M. Stanley's remarks on instinctive attitudes in NATURE of Oct. 18. I have been for some years studying children's attitudes and expressions from the evolution point of view; and have from time to time taken photographs as opportunity presented itself. I have now a considerable number which I hope to publish in that connection.

One of the series accompanies this, and bears on Mr. Stanley's remarks. It was taken in May last, representing my youngest child, then ten months old. She never crawled, but always progressed on all-fours; and this photograph, taken instantaneously, shows her mode of travel to and fro on the garden path. The interesting thing about it is this: that the gait is front and back legs on opposite sides, like a dog or a cat, not on the same side, like a camel—a result which the evolutionist would have predicted; though of course we show a relic of the same habit in walking, by swinging the arm on the opposite, and not on the same, side as the leg. In this photograph, too, the heel and toe action of the hind limbs is instructive.

One of my children, in addition to the ordinary crawl, used to progress in a sort of three-legged fashion—it used the left hand



and the right foot for the forward step, rested itself on the shank of the left leg tucked under its body, and this it used as a foot to bring forward its body for the next step. Sometimes this developed into a three-step mode of progression.

The bandaging, swaddling, carrying and wheeling about, which the civilised infant has suffered for many generations, no doubt partly accounts for the rarity of the quadrupedal mode of progression, by having hindered development of muscularity. The quadrupedal mode of progression indicates greater strength than the ordinary knee-crawl.

S. S. BUCKMAN.

Cheltenham, October 24.

## James Parkinson, the Author of "Organic Remains of a Former World."

IN a paper on the subject of museums, which was read in 1891 before the meeting of an association, James Parkinson is thus spoken of without any subsequent qualification of the statement made:—

"Finally, a private lottery was arranged for its disposal (the Leverian Museum), and in 1785 the prize was drawn by James Parkinson, a dentist, who took not the least interest in natural history or in museums."

As the scientific world seems profoundly ignorant as to what were the scientific qualifications and professional position of James Parkinson, the following facts may be worth publishing in NATURE:—

James Parkinson, who resided at No. 1 Hoxton Square, was not a dentist, but a surgeon. In Johnston's Directory for 1817 his address is thus given:—"Parkinson and Son, Surgeons, No. 1 Hoxton Square." He had also an address in the Kingsland Road. His death is thus recorded in the *Gentleman's Magazine* of December 1824:—"December 21st, in Kingsland Road, James Parkinson, surgeon, late of Hoxton Square." There *was* a firm of dentists in London, whose address in Johnston's Directory was as follows:—"Parkinson and Kidman, surgeon-dentists, 1 Racquet Court, Fleet Street"; but they had evidently no professional connection with James Parkinson.

The following list of works, &c., by James Parkinson, published by H. D. Symonds, Paternoster Row, is given at the end of a little book by him, of which the title is "Dangerous Sports; a Tale addressed to Children," printed for H. D.

Symonds, Paternoster Row, 1858. Their titles, which I briefly give, will amply prove his professional position:—

- 1 "Medical Almonitions to Families," 5th edition
- 2 "Observations on the Excessive Indulgence of Children."
- 3 "The Village Friend and Physician," 2nd edition.
- 4 "The Way to Health."
- 5 "The Chemical Pocket-Book."
- 6 "Hints for the Improvement of Trusses"
- 7 "The Hospital Pupil."
- 8 "Observations on the Nature and Cure of Gout."
- 9 "Remarks on Mr. Whitbread's Plan for the Education of the Poor."
- 10 "Organic Remains of a Former World." Volume the First.

In addition to his "Organic Remains," Parkinson produced "Elements of Oryctology, an Introduction to the Study of Fossil Organic Remains," which appeared in 1822. A third edition was published in 1840.

Whatever may have been Parkinson's lack of interest in natural history when he acquired the museum, he certainly showed no deficiency in that respect when he produced his "Organic Remains of a Former World," one of the most valuable and interesting works of the kind that I know. For further information with regard to Parkinson, see the Introduction to Manell's "Atlas of Fossil Remains," published by H. G. Bohn in 1850, in which Parkinson's splendid plates are reproduced. See also Allibone's "Dictionary of British and American Authors"; London, 1870.

SPENCER GEORGE PERCEVAL.

Henbury, Bristol, October 29.

#### On Chinese Beliefs about the North.

FROM a review in NATURE for the 27th ult. (p. 522) I have been led to conclude that the "Theory of the Northern Origin of the Chinese" enjoys the confidence of scientific men. Should this conclusion really be correct, the theory will give strong support to the view which occurred to me while reading the review.

By See-ma Kwang, a Chinese Prime Minister of great classic knowledge (died 1086), the Rite of "Fuh" (*i.e.* bringing back), anciently observed before changing the clothes of deceased parents, is detailed as follows:—"Take a clean suit of clothes prepared for the corpse up to the ridge of the roof; then *search the north east three times, pray, return*"; then fold up and bring down the suit to clothe the corpse; *to detain the soul*, thus brought back, fasten the suit with silk (silkens band); before the burial offer to it vials and utensils with as much reverence as is due to the parents alive" (1). In this ritual I notice three primitive beliefs unitedly preserved: firstly, that the soul of the deceased could return if called, the belief current among the Hoss, the Bank's Islanders, and the Fijians of modern times (2); secondly, that one could detain the soul from departing by fastening a garment while addressing to the deceased, as is meant by an old Japanese usage on occasion of meeting the *fu-in*, *sub*, *v.c.*, *ipin-fatuu* (3). In the third place, as is the case with the Kookies (4), this ritual in licates the primitive Chinese belief in the *existence of their other world in the north*.

The early Chinese system of cosmogony, which is now fragmentally but uniformly preserved in the books of two antagonistic religions, *viz.* Confucianism and Taoism, has its God of the North named "Hsueh-Ming," *i.e.* "Entering Outer World" (5).

Chang Hsi, a Prime Minister of encyclopaedic erudition (died 320 A.D.), mentions in his work a Taoist belief in the other world as extensive as 200,000 *li* square, situated underground in the north (6). Another Taoist Eschatology, written in the 9th century A.D., relates that "the Emperor Yen-teh, who was created the Grand Imperial Master of the North, governs all spiritual beings" (7). Most probably connected with these beliefs is a book-plate of the "South Dipper," the life-register, and the "North Dipper," the death-register (8), from which is derived a popular notion of Chia Yen's bribery to the latter star-god in order to have his destined longevity increased from nineteen years to ninety-nine (9).

The Yoga-charya mystics of China define the north as "the point where all the works are doomed to finish," and hence "the point of entering Nirvāna" (10). A dispute about whether Chinese Buddhism in this case is entirely free from the stain of Celestial gloss, I am not qualified to decide.

Now let us return to Confucian literature. Confucius's own opinion regarding the other world appears of quite agnostic character, as is implied in his answer to Tze-lu (who inquired about the state of death)—"While you do not know life, what can you know about death?" (11); as well as in his answer to Tze-kung (whose question was about whether the deceased had consciousness)—"If you die, you will know; even then it will not be too late to know" (12). But it is in those ancient sages' tenets, which the great master preserved in his doctrine, that the early Chinese belief in the northern spirit-land had been so predominant, though tacitly implied, as to have caused an all-reaching association of *the North with everything related to Death*. So, early they styled the rooms containing ancestral tablets the "North Temples" (13), and by the name "North Hill" the graveyard has always been understood.

According to the "Tang-kung" (a portion of the *Book of Rites*), Confucius was buried in the northern part of the capital of Lu, and "the burial in the northern sides of towns was the persistent custom of the three 'classic dynasties,' *i.e.* Hsia, Ying, and Chau" (14). Forcefully this statement reminds us of the Damaras, who place the corpse with the face towards the north, to remind them whence they originally came; and also of the Yncas, who, expecting to go to the east whence they came, turned the face of the corpse to the east; while the aboriginal Peruvians did not follow the same usage (15). In fact, we find in Chinese records certain abnormal examples, which indicate the stocks distinct from original Chinese; thus, two corpses of different sexes discovered from the mound of Prince Tsuku, a Hsiung-nu by descent, are said to have had their heads turned eastwards (16).

Mr. Herbert Spencer, after reasoning from materials extensively collected, remarks: "Immigrant races have for their other-worlds the abodes of their fathers, to which they journey after death" (17); and unless they are an exception to this general rule, the Chinese, whose old customs and traditions have been shown to tend so much towards evincing their early belief in the northern spirit-land, *must have originally entered their present domain from the North*.

Also, in early Chinese speculations the north had been fixed on as the store and source of the originating principle "Yin" (or *Negativity*), and it has ever since been associated with everything of "negative" characters—*e.g.* reposing, obscuring, destroying, &c. Thus, in the symbolism of "Wu-hang" (the *Five Elements*), water and winter are posted at the north (18); of the nine divisions of the heavens the northern and the north-western are named respectively "Dark Heaven" and "Dusky Heaven" (19); of the five mountains worshiped by emperors the northernmost one is called "Eternal Mountain" (*Han Shan*), because all beings are doomed to eternal repose in the north (20); and referring to the then admitted axiom—"the north is the realm of slaughters and assaults"—Confucius once reproved Tze-lu for playing on a stringed instrument in the "northern tones" (21).

As there should be nothing other than Death that might combine in itself all conceivable characters of Negativity, it would seem quite reasonable to trace the origin of these associations of North and Negativity of Chinese speculations into the old custom of burying in grounds lying towards the north, which custom in its turn is easily traced to the early Chinese entrance from the north.

*Bibliography.*—(1) Kumazawa, "Sesai Benron," Tokio, 1890, p. 4. (2) Spencer, "Principles of Sociology," 3rd edition, vol. i. § 83. (3) Terashima, "Wakan Sansai-zu," 1713, tom. lviii. sub. "Hitotama." (4) Spencer, § 112. (5) Pan Ku, *Peh-hu-tung*, 79 A.D. tom. ii. chap. i. (6) "Peh-wuh-chi," tom. i. chap. ii. (7) Twan Ching-shih, "Yü-yang Tsah-tze," tom. ii. (8) Sie Tsai-kang, "Wu tsah-tsu," *ana* 1610, tom. i. (9) "Yen-i San kwon-chi," Kin's edition 1644, tom. xxxv. pp. 4-5. (10) In-yü, "Mandara Shishes," 1491, tom. i. (11) "Confucian Analects," chap. xi. (12) "Encyclopædia Britannica," 9th edition, vol. vi. p. 265. (13) Ying Chau, "Fung-shu-tung," 2nd cent. A.D., tom. ix. chap. ix. (14) "Sian-tze," *ana* 255 *v.c.* xxviii. (15) "Peh-hu-tung," tom. iv. chap. x. (16) Spencer, § 112. (17) Li Shih, "Suh Poh-wuh-chü," 13th cent. A.D. tom. viii. (18) Spencer, § 115. (19) "Peh-hu-tung," tom. ii. chap. i. (20) "Lu-shih Chun-tsu," *ana* 239 *v.c.* tom. xiii. chap. i. (21) "Fung-shu-tung," tom. x. chap. i. (22) Liu Hsiang, "Shwuh-yuen," 1st cent. *v.c.* tom. xix.

KUMAGUSU MINAKATA.

15 Blithfield Street, Kensington, W., October 16.

The Planting of Timber Trees.

IN Traill's sketch of the life of Shaftesbury (the first Earl), the following passage occurs in a letter from the Earl to the steward of his estates in Dorsetshire :—

"The best planting of timber trees is with nuts, acorns, seeds, and footsets, and not with young trees removed . . . In setting of chesnuts, acorns, and seeds [it is desirable] to steep them twenty-four hours in milk, which gives them a great advantage. . . . If siccamores [are planted] near my gardens, they will spoil all my fruit with the flies they breed. Therefore pray pluck up all the siccamores that are in the dry meadow behind my kitchen-garden, and in the room of every one of them plant a chesnut, a walnut, or a honey-broke oak."

Can any of your readers inform me whether the soaking of seeds in milk is now, or ever has been, extensively practised, also what is meant by a "honey-broke oak"?

ALFRED W. BENNETT.

Rhynchodemus Terrestris in England.

THE credit of the first discovery of this land-planarian in England lies not with Sir John Lubbock, as Dr. Scharff stated, but with the late Rev. L. Jenyns (Blomefield), who, in his "Observations in Natural History," 1846 (p. 315), makes some interesting remarks on the "Ground Fluke" (*Fasciola terrestris*) and its occurrence in the woods at Bottisham Hall, a locality searched with success by Mr. Harmer.

*Rhynchodemus terrestris* is widely distributed in England, and I have found it in Derbyshire, North Lancashire, and Westmoreland, under moist conditions and on a limestone substratum.

Any additions to the limited number of land-planarians in Europe are of considerable interest, and mention may therefore be made of Prof. v. Graff's description (*Bull. Soc. Zool. France*, xviii, 1893, pp. 122-3), of *Rhynchodemus pyrenaicus*, n. sp., from St. Jean de Luz, which is not alluded to by Dr. Scharff.

F. W. GAMELE.

Owens College, Manchester, October 25.

Tan-Spots over Dogs' Eyes.

THE shepherds in some of the east counties of Scotland used to call their black-and-tan collies four-eyed dogs, which agrees so far with Mr. Peal's observations. These collies, twenty years ago, were much in demand. Now they are hardly allowed prizes at shows, and are becoming scarce; black and white, pure white, and, more commonly, brown dogs being greater favourites.

J. SHAW.

A CRITICISM OF THE ASTRONOMICAL THEORY OF THE ICE AGE.

IN a communication to the British Association at Oxford, I gave an outline of a method of obtaining a limit to the direct effect on terrestrial temperature of the diminished winter sun-heat during epochs of great eccentricity, the conclusion being that that effect had been enormously exaggerated, and that the astronomical theory of the Ice Age was really but a vague hypothesis, having no sound physical foundation.

It will be remembered that Dr. Croll's theory is shortly this: In the long northern winters in the time of great eccentricity, far less sun-heat is received than at present; the direct effect of this decrease in sun-heat is a proportionate decrease in terrestrial temperatures, or, more properly, a proportionate decrease in the excess of terrestrial temperature over the temperature to which the earth would fall in the absence of all sun-heat. So far Croll and Sir Robert Ball, the later expounder of the theory, agree. But now they part company. Croll affirms that the lowering of temperature thus calculated would be quite insufficient, and that it is the indirect effect of this fall of temperature (chiefly the effect in disturbing oceanic circulation) which gives rise to the additional lowering of temperature necessary for the production of an Ice Age. Ball, on the other hand, affirms that the direct lowering of temperature due to

diminished sun-heat is amply sufficient to cause an Ice Age. I use the word *affirms* advisedly, because neither writer assigns any reason. Apparently Croll's reason was that he thought he could see additional causes, which if they existed must have contributed to the effect, and also that previous writers had said that the direct effect of the change in sun-heat would not be sufficient; while Ball seems to have considered that he had strengthened Croll's argument so much that the new form of the theory was as strong without the ocean currents, as Croll's was with ocean currents. It does not seem to have occurred to either writer to ask what change in temperature would be necessary in order to produce an Ice Age, so that they might see if the cause they assigned would be sufficient; yet one would have thought this was the first step towards formulating a theory.

The point in reference to which the two authors employ numerical calculation is in obtaining the fall of terrestrial temperature due to a reduction of sun-heat. The problem is, of course, very complicated, and one would expect that the most approved principles of physics would be employed. Not at all. The physics is founded on an incidental remark of the astronomer Herschel in his "Outlines of Astronomy" (edition of 1869), where he assumes that the radiation of a body in space is proportional to its absolute temperature. Yet it has for many years been known to physicists that the radiation increases faster than the temperature, and in 1880 or 1881 what is now known as Stefan's law was published, namely, that the radiation increases as the fourth power of the absolute temperature. This would make an enormous reduction in the calculated fall of temperature due to a diminished supply of heat—it would reduce it to one-fourth of the amount obtained on the erroneous assumption employed by Croll and Ball alike. For if temperature be solely due to sun-heat, the heat radiated, say  $A\theta^4$ , where  $\theta$  is the absolute temperature, must be equal to that received, say  $S$ , or

$$A\theta^4 = S,$$

hence

$$\frac{d\theta}{dS} = \frac{1}{4} \frac{\theta}{S},$$

whereas the law of direct proportionality assumed by Herschel, and adopted by Croll and Ball, gives

$$\frac{d\theta}{dS} = \frac{\theta}{S},$$

a result four times as great as that obtained above—

Turning now to Croll's form of the argument, we find one very remarkable inconsistency, which I think is no bad illustration of the special pleading which characterises that ingenious writer. When, in the first place, he desires to show how great may be the midwinter fall in temperature due to diminished sun-heat, he thus employs the argument I have criticised above :—

Let  $T_p$  be the present excess of midwinter temperature at the latitude of the British Isles above the temperature of space, *i.e.* above the temperature to which the earth would fall if all sun-heat were to cease, and  $S_p$  the quantity of sun-heat at present received on that latitude on Midwinter Day, and let  $T_g$  and  $S_g$  be the corresponding quantities for the supposed glacial winter. Then, on Herschel's hypothesis,  $T_g$  is to  $T_p$  as  $S_g$  is to  $S_p$ . Having in that way got an enormous fall of temperature, Dr. Croll goes on to say that a vast proportion of our midwinter temperature in these isles is due, not to sun-heat received by us, but to heat carried to us by ocean currents. These ocean currents, he argues, will be diverted in the supposed glacial period, and thus there will be a further great fall in temperature. The argument for this double diminution of temperature is, of course, utterly invalid. If a great proportion of our winter-heat be not due to sun-heat, then a considerable

loss of sun-heat would not affect our winter temperature very much, and the first argument is wrong; if it be all due to sun-heat, then the first argument is right, and the second wrong.

Nor do we find much greater accuracy in Sir R. Ball's exposition of the theory. He is, indeed, much fairer than Croll in taking the winter temperature as proportional to the *mean* daily supply of winter sun-heat, instead of the Midwinter Day sun-heat, for it is evident that the adjustment of temperature to sun-heat could not take place instantaneously. But in another particular he seems greatly to *understate* the case for the theory. His method of calculating the average daily sun-heat is to take the winter heat over the *whole northern hemisphere*, and divide it by the number of days in winter, and similarly for the daily summer sun-heat. He applies the average thus obtained to calculate variations in temperature in the latitude of the British Islands. But when we remember that the theory of the Ice Age is the theory of the temperature of the latitudes from about 45° N. to lat. 70° N. or, if you like, to the pole, it appears quite misleading to use numbers obtained from the sun-heat received by the *whole hemisphere*. For the proportion which the total winter sun-heat we receive in these Isles bears to the total summer-heat is expressed, not by Ball's numbers 37 and 63, but by the very different numbers 25 and 75. The great disparity between these numbers, contrasted with the temperate character of our climate, enables us to see how futile it is to appeal to our imagination, as Ball does, to conceive what vast differences of climate must be produced by differences in the daily receipt of sun-heat.

"If," he says, "a double supply of heat [63 measures] be poured in like a torrent during the short season [the 166 days of the short summer] while the single supply [37 measures] is constrained to do duty over the long season [the 199 days of the long winter], then an intolerable climate is the result. The total quantity of heat received on the hemisphere in the course of a year is no doubt the same in each case, but its unsuitable distribution bespeaks a climate of appalling severity—an Ice Age, in fact."

How untrustworthy this style of argument is, will appear when it is pointed out that in order to get a latitude in which as large a proportion as 37 per cent. of the annual sun-heat is received in the coldest 199 days, we have to go as far south as Madrid, Naples, Constantinople, New York, or Peking! Yet we are asked to believe that this distributor, approximately two measures in 166 days, and one in 199 days, will produce "a climate of appalling severity—an Ice Age, in fact." ("Cause of an Ice Age," p. 135.)

There is another form in which the numerical method is applied by Ball, the result of which, so far from supporting the astronomical theory, would, if true, appear to me to be conclusive against it. The present mean annual range of temperature in Great Britain is about 29° F., and this, according to Ball, is caused by the disparity in the daily receipt of winter and summer sun-heat, acting against the mitigating causes. In the epoch of great eccentricity the disparity will be much greater, and instead of the range of 29° F. we shall have a range of 27° F. ("Cause of an Ice Age," p. 131.) Ball then goes on to say that such proportionate changes "are quite large enough to imply profound differences in the climatic condition. It is to be observed that, generally speaking, the coldest places are those of the greatest mean annual range. We are therefore entitled to infer that the effect of such a change in the eccentricity as we have supposed, would be to increase the range, lower the temperature of the hemisphere, and thus induce the glacial period."

One would not consider such a statement out of place in a popular treatise if it embodied the result of an inquiry too complicated to be explained except in technical

language; but that is not the case here, nor can the conclusion be admitted as in the slightest degree probable. In fact, so far from our being entitled to infer that such an increase in the mean annual range would induce a glacial period, it appears to me that the mere fact that in all continental climates north of Lat. 40°, the present range is greater than 28° F., entitles us to infer that such a range would have no power whatever to induce an Ice Age.

The problem of ascertaining the effect of different astronomical conditions upon terrestrial temperatures is too complicated for accurate solution. How far the temperature at any place depends on the sun-heat falling on the outer layers of the atmosphere at the place (which is all that we can find by calculation), and how far on the transference of heat by ocean or air currents, must always remain to some degree uncertain, but that the latter exert a preponderating influence seems evident for two reasons—first, that while the sun-heat in each season remains the same from year to year, the seasons themselves vary enormously (we have cold summers and hot summers, warm winters and cold winters, all with unchanged conditions of sun-heat); and second, the difference between summer and winter temperatures is, in northern latitudes, but slight when compared with the difference between the quantities of winter and summer sun-heat received. Hence it appeared to me that no modification of Croll's method of calculating differences of temperature due to differences of sun-heat could be relied on, for our knowledge of the transference of heat from one region to another is too slight to enable us to allow for its effect in our equations. But there is another method which seems very reliable, especially when applied to the British Isles, or any region where warm ocean currents flow from the south. Not, indeed, that the method enables us to calculate the lowering, if any, of temperature in the epoch of great eccentricity, but it appears to enable us to fix, with some degree of certainty, a limit to the direct effect of the diminished winter sun-heat.

The method depends on comparing those regions which now receive given allowances of summer and winter sun-heat with the regions which, in the epoch of great eccentricity, received the same allowances. If, following Croll, we suppose the temperature on Midwinter Day to depend on the sun-heat received on that day, we find that latitudes 90°, 80°, 70°, 61°, 52°, and 43° now receive the same sun-heat on Midwinter Day as latitudes 90°, 80°, 70°, 60°, 50°, and 40° received on the Midwinter Day of the most extreme eccentricity. In other words, instead of Dr. Croll's fall of 45° F. (I omit his decimal point), the midwinter temperature of London would, in the supposed glacial epoch, be lowered to that of Manchester at present, for Manchester is about 2° north of London. If, following Ball, we take the average daily heat in winter as the basis of comparison, we should find that latitudes 90°, 81°, 74°, 67°, 52°, 4, and 43° 3 receive in the present winter the same daily average of sun-heat as latitudes 90°, 80°, 70°, 60°, 50°, and 40° received in the long winters of greatest eccentricity. Or, finally, if we adopt the hypothesis, too favourable to the astronomical theory, that the midwinter temperature depends on the daily average through the 109 coldest days of the year, we find that latitudes 84° 5, 74°, 63° 5, 54°, and 44° 2 ought now, so far as direct sun-heat is concerned, to have the same midwinter temperature as 80°, 70°, 60°, 50°, and 40° had in the supposed glacial epoch; and when it is observed that the summers in these latitudes were then considerably hotter than the summers in the former latitudes, 84° 5, 74°, 63° 5, 54°, and 44° 2 now are, the utter inadequacy of the astronomical theory to explain the vast differences in temperature must surely be admitted by any reasonable mind.

But when we take account of the ocean currents, it



seems probable that instead of being lowered the winter temperature in the British Isles would be raised in the long winter of the supposed glacial epoch. For the Gulf Stream flows at about four miles per day between the Azores and Norway—that is, about ten degrees of the earth's surface in six months, so that we may fairly suppose the midwinter heating of these countries to be dependent on the summer heating at about Lat. 40–45. Now during the 166 days of the short summer in the epoch of great eccentricity, these latitudes received a greater daily average of heat than any latitude, even the equator, now receives in an equal time. Hence it is likely that the midwinter receipt of ocean heat in that epoch was much greater than at present. This seems to harmonise with the present condition of Mars. So far, indeed, as the evidence from the condition of Mars is admissible, it seems to be quite inconsistent with Croll's view.

A paper dealing more fully with the mathematical portion of the subject will shortly appear in the *Philosophical Magazine*, and a more exhaustive criticism of Croll's and Ball's works will be found in the January number of the *Geological Magazine* for 1895.

It is satisfactory to know that although the astronomical theory of the Ice Age has been steadily gaining an assured position among the semi-scientific public—one sees it referred to as the most generally accepted explanation in such diverse works as Nansen's "Journey across Greenland," and Laing's "Human Origins," the rising school of geologists are strongly opposed to it, as contradicting the geological evidence.

EDWARD P. CULVERWELL.

#### NOTES.

THE President and Council of the Royal Society have this year awarded the medals as follows:—The Copley Medal to Dr. Edward Frankland, for his eminent services to theoretical and applied chemistry; the Rumford Medal to Prof. James Dewar, for his researches on the properties of matter at extremely low temperatures; the Davy Medal to Prof. Cleve, of Upsala, for his researches on the chemistry of the rare earths; and the Darwin Medal to Prof. Huxley, for his researches in comparative anatomy, and especially for his intimate association with Mr. Darwin in relation to the Origin of Species. The Royal Medals have been awarded to Prof. J. J. Thomson in recognition of his contributions to mathematical and experimental physics, especially to electrical theory; and to Prof. Victor Horsley for his important investigations relating to the physiology of the nervous system and of the thyroid gland, and to their applications to the treatment of disease. We learn as we go to press that the Queen has signified her approval of these awards.

THE following is a list of those who have been recommended by the President and Council of the Royal Society, for election into the Council for the year 1894–5, at the anniversary meeting on November 30:—President: Lord Kelvin. Treasurer: Sir John Evans, K.C.B. Secretaries: Prof. Michael Foster, Lord Rayleigh. Foreign Secretary: Sir Joseph Lister, Bart. Other members of the Council: Dr. Andrew Ainslie Common, William Crookes, Francis Darwin, Dr. Andrew Russell Forsyth, Sir Douglas Galton, K.C.B., Prof. Alexander Henry Green, Sir John Kirk, K.C.B., Prof. Horace Lamb, Prof. Edwin Ray Lankester, Prof. Alexander Macalister, Prof. John Henry Poynting, Prof. Arthur William Rücker, Osbert Salvin, Prof. J. S. Burdon Sanderson, Dr. Thomas Edward Thorpe, William Henry White, C.B.

WE regret to note the death of Prof. M. Duchartre, the eminent French botanist. He was in his eighty-fourth year.

THE Société nationale d'Horticulture de France is organising an international exhibition of horticultural products and industries, to be held in May 1895.

THE death is announced of Dr. Francesco Gasco, Professor of Comparative Anatomy and Embryology in the University of Rome.

SIR D. A. LANGE, who was appointed in 1858 the constructor of the Suez Canal, has just died, and was for some years director in England of that work. He was a Fellow of the Royal Geographical Society, the Society of Antiquaries, and of other learned societies, and the author of several important books connected with the Suez Canal.

A BLUE-BOOK has been issued containing Commissioner H. H. Johnston's report of the first three years' administration of the eastern portion of British Central Africa. The report deals with the physical geography of the country, its meteorology, agricultural conditions and resources, minerals, and fauna, with the characteristics of the native races, and is altogether of considerable scientific value.

AFTER the great earthquake shocks in Greece, last spring, a committee was appointed to make an examination of the Parthenon, in order to ascertain what damage the temple had sustained. The committee reported that the building had been seriously injured, and that there was great risk in allowing it to remain in its present dangerous condition. They recommended, therefore, that immediate steps be taken to strengthen it. Reuter's correspondent at Athens now reports that the Archaeological Society, at a meeting called to consider the question, have voted an unlimited credit for the purpose of effecting the necessary repairs.

MR. H. C. RUSSELL, has sent us an account of the travels of three bottle-papers used for determining ocean currents. One was thrown into the sea near the Crozet Islands in March 1893, and was found in September 1894 between Cape Banks and Cape Northumberland. The mean daily rate of this appears to have been nearly eight miles. Two other papers travelled over much the same course on the south coast of Australia, at mean rates of six and nine miles a day. The interesting point is that three current papers should pass over more or less the same track, and agree so well as to the rate of the current. The paper that made only six miles a day was hampered with a heavy frame of wood, which had been put round it as a protection when it should reach the coast.

THE arrangements for the new session of the Society of Arts are now announced. The session commences on November 21 with an address from the Chairman of the Council, Major-General Sir John Donnelly. The first regular paper will be by Mr. Hiram Maxim, on his "Experiments in Aeronautics," and this will be followed the succeeding week by one by M. Hermite, on "The Electrical Treatment of Sewage." Two other papers—one by Mr. Thomas Ward on "Salt," and one by Gen. Michael on "Forestry"—will be read before Christmas. A number of papers for meetings after Christmas are also announced. Six courses of Cantor Lectures are promised, of which the first is by Prof. Vivian Lewes on "Explosives." There will be, as usual, a course of Juvenile Lectures after Christmas; the lecture this year is by Prof. C. V. Boys, F.R.S., his subject being "Waves and Ripples."

M. A. DELEBECQUE, of Thonon, sends us a small pamphlet on the lakes of Dauphiné. These lakes are very numerous, many of them being mere tarns or lagoons, and some, although figuring as sheets of water on the large-scale maps, are frequently dry. He gives an account of his soundings in the lakes of Bourget, Agaebelette, Palalieu, and the smaller lakes of the

plateau and mountain regions. As to the origin of these basins, M. Delebecque believes that many of the smaller are due to glacial action, either erosion or the irregular accumulation of moraine stuff. He does not confirm Forel's theory of the origin of the lake of Bourget by the barring of a lateral valley by the alluvium of the Rhone, but is inclined rather to look upon it as a result of movements in the crust. The origin of the other lakes is more obscure, but some appear to be probably due to movements of the strata, while others arose from the barring of lateral valleys by detrusus. Particulars of temperature observations and analyses of the water of various lakes are given, and M. Delebecque concludes with an appeal to the local scientific societies of Dauphiné to initiate systematic observations on the lakes of the district.

MONSIEUR FAYE, the celebrated French astronomer, who lives in Paris, has recently received a Fards me token of the admiration of his colleagues. All the members of the Bureau des Longitudes, together with their president,



Monsieur de la Groye, assembled in his house, and presented him with a silver enamelled tablet, on which Astronomy and History are represented offering a medallion to the mortal of careers. It bears the following inscription: "To Hervé Faye, President of the Bureau des Longitudes, 1874-1893. The homage of his colleagues." The two allegorical figures are sitting in the clouds, and Astronomy is pointing the comet which was discovered by the illustrious astronomer. This interview greatly affected Monsieur Faye, who had only retired on account of the new law, opposing the perpetuity of the presidency.

MR. J. THEODORE BENT AND MR. BENT leave London to-morrow, November 9, for an exploring journey in Arabia. They go first to Karachi, and thence by steamer to Muskat on the Gulf of Oman, where the land journey commences. It is

Mr. Bent's intention to cross Arabia from east to west, and, in doing so, to revisit the Hadramut Valley, and continue his archaeological researches there.

MR. TREVOR-BATTYE, to whose arrival at Archangel we referred last week, has telegraphed to the *Times* a detailed account of his experiences on his visit to Kolguef Island. He landed on the north-west coast of the island on June 21, at the mouth of the river Gosina, accompanied by Thomas Hyland (a bird-skinner) and a spaniel. A few days later they started to cross the island, and found the journey very difficult on account of the bogs and snow-filled ravines, and the severity of the weather, which was either cold and foggy or intensely hot, calling out swarms of mosquitoes. Birds were abundant, but the only mammal seen was a fox. At length, after a week's travelling, a party of Samoyedes and many reindeer were found near Chum. Mr. Trevor-Battye made this his headquarters until August 20, gaining much information as to the language and customs of his hosts, and assisting them in their hunting. He records the capture of 300 Brant geese in one net, and on another occasion the slaughtering of 300 reindeer. A Russian trader arrived who had visited the island for thirty-five successive years, and he remained a month transacting business with the Samoyedes. On September 18 Mr. Trevor-Battye sailed with the Russians for the mainland, and experienced bad weather on the way, and much difficulty in navigating the shallow water near shore. His orthodox companions attributed this difficulty to the presence of a Samoyede idol which was very displeasing to St. Nicholas; but Mr. Battye clung to his trophy, though at some personal risk. After landing, there was a four days' journey in sledges to Oksina, and a three days' boat trip up the Pechora to Ust Tsilma. It was the worst time of the year for travelling, as the land was marshy, and the rivers, unnavigable on account of floating ice, were not yet frozen over. However, Mr. Trevor-Battye and his companion struggled on in sledges or carts, and, after adventures with wolves and all manner of delays, ultimately reached Archangel in excellent health. Kolguef Island appeared to be of alluvial formation with no trace of massive rock, being possibly a remnant of the delta of a great river. The coast-line is quite different from that shown on the chart. Extensive zoological and botanical collections were secured.

At the annual meeting of the Royal Cornwall Geological Society, held at Penzance, on November 2, Mr. Howard Fox, the President, reviewed the progress made during the past twelve months towards the elucidation of the many unsolved problems of Cornish rocks. Mr. F. J. Stephens had found radiolarian cherts in the Metage conglomerate, and on the mainland near Mullion. Mr. Ussher, of the Geological Survey, had traced Upper Devonian strata in the St. Germans district, west of the Tamar. The President himself had found similar strata west of Padstow, and a peculiar rock at Dinas Head in the same district, which contained nearly ten per cent. of soda. In its compact form it might easily be mistaken for a chert, but it passed into a nodular variety showing spherulitic structure. Whether it were a soda felsite (keratophyre) or a sedimentary rock altered by contact metamorphism, such as the Adinole of the Hartz, was a question on which petrologists were not as yet in absolute agreement. The evidence from sedimentary rocks in contact with greenstone on Cataclens and Round-hole Points indicated a sedimentary origin, as did General McMahon's notes on the sections he had examined. Crinoidal remains had been found in black shales of the Ordovician district of Veryan, interbedded with radiolarian cherts, but these shales had as yet yielded no typical zonal fauna. He (Mr. Fox) had sent some sections of the carboniferous cherts of East Cornwall

to Dr. Hinde, who found those from Carzantic Quarry, near Launceston, full of radiolarian casts, with one instance of structure. Further investigations were being made in this direction by Mr. Ussher and himself. In conclusion, he drew attention to the unwise practice of taking away shingle from beaches faster than it was being reproduced by nature.

IN connection with the controversy over preformation and epigenesis which at present agitates the biological world, we may draw the attention of our readers to a series of articles contributed by Wilhelm Haacke to the *Naturwissenschaftliche Wochenschrift* (Bd. ix. Nos. 32-38, Aug. and Sept. 1894), under the title "Schöpfung und Wesen der Organismenform." The writer passes under review the various theories of the origin and development of organisms which are associated with the names of Albrecht von Haller, Wolff, Blumenbach, Goethe, Lamarck, St. Hilaire, Darwin, Weismann, Roux and other biologists, and criticises them from a standpoint not far removed from that of Oscar Hertwig. The synthetic views of the author do not give one the impression of finality, but, as a historical *résumé* of the oscillations and tendencies of thought upon some fundamental problems in biology, Dr. Haacke's essay is distinctly interesting.

THE importance, both from economic and from scientific points of view, of a thorough knowledge of the floating fauna and flora round our coasts is so generally recognised, that our readers will be interested in a recent article which, in concise form, furnishes a number of valuable data upon this subject, and must considerably facilitate the further prosecution of similar researches. The article forms part of a report contributed by Mr. W. Garstang to the current number of the *Journal of the Marine Biological Association*, in which the author gives a record of his observations upon the fauna during 1893-94, and upon the breeding seasons of marine animals at Plymouth, and also submits an attempt to construct a calendar of the changes observable in the floating fauna from month to month in the same locality. *Der Anfang ist das Schwer*, and marine biologists familiar with the seeming fickleness of marine phenomena know well the powers of discrimination and the experience necessary for the production of accurately generalised information under this head. It is most satisfactory, therefore, that the valuable work upon our north-eastern fauna, which Prof. McIntosh has conducted for many years past at St. Andrews, should be now supplemented by the observations of another competent naturalist on our south-western shores. If, as we hope, arrangements can be made for carrying on continuous observations at the young, but promising, station at Port Erin, and on the west coasts of Ireland and Scotland, we shall in good time be equipped with data of the most valuable kind for determining many problems connected with the natural history of our migratory and other fishes.

THE second of the *Tufts College Studies* embodies the results of an investigation of the development of the lungs of Spiders (*Aiglela novia* and *Theridium tepidariorum*) by Orville L. Simmons. The author's interpretations differ entirely from those of Jaworowski, already noticed in our columns (October 25, p. 621). He finds that the lungs arise as infoldings of the posterior surface of the appendages of the second abdominal somite, the lung cavity being essentially a pit in the body-wall at the base of, and behind, the appendages in question. The development of the lamellæ agrees strikingly with Kingsley's observations on the origin of the gills of *Limulus*, and lends considerable support to Prof. Lankester's well-known theory. The tracheæ develop behind the next pair of limbs at the apex of a similar depression of the body-wall. In their earlier stages these appendages show on their posterior surfaces certain feeble undulations, which the author regards as aborted

lung- or gill-lamellæ. The tracheal twigs arise as simple ingrowths comparable, in the author's opinion, with the infoldings which produce the lamellæ. Mr. Simmons concludes that the lung-book condition is primitive, the tracheæ of Arachnids being derived from it. How far he is right in this conclusion, and how far (if at all) Jaworowski has gone wrong, are questions that we hope will not long remain undecided.

A REDETERMINATION of the temperature of greatest density of water has recently been carried out by M. de Coppet, who gives an account of his results in the *Annales de Chimie et de Physique*. On account of the very slow change of density about that temperature it is difficult to determine it within a hundredth of a degree Centigrade. The method adopted was a modification of that of Despretz. A number of thermometers were mounted in the lid of a cylindrical water vessel with their bulbs at various distances from the bottom, and symmetrically disposed about the axis. On immersing the vessel in a cold water bath, a current was set up, passing down along the sides and ascending in the centre. After a while the current stopped, and then was reversed. The course of the current could be followed by the readings of the thermometers. The water having the greatest density would sink to the bottom, and the temperature of the lowest bulb would be approximately that of greatest density. But the temperature at which the lowest thermometer stopped for a time was higher on cooling than on heating. The curves exhibiting the two series of changes are, however, symmetrical, and give the temperature of maximum density as  $3^{\circ}982$  by the hydrogen thermometer under a pressure of one atmosphere.

A SIMPLE method of obtaining light of different wave-lengths for use in polarimetric work is described by Landolt in the *Sitzungsberichte* of the Berlin Academy, No. 38. White light from an Auer's glow-lamp is passed through different absorption cells containing coloured solutions which can be readily procured. Details are given of the preparation of five such cells, by means of which red, yellow, green, light blue, and dark blue light may be obtained. Examined spectroscopically, the light is in each case found to consist of a band, and is not by any means monochromatic; if, however, the rotation be less than  $20^{\circ}$ , or, with one or two of the cells, even if it be considerably greater, the field of the polarimeter remains apparently uniform in tint. The wave-lengths with which the bands may be taken to correspond, were determined by using the cells in a set of observations on the rotation of quartz, and comparing the results with those obtained for the rotation of quartz by Broch's method. The wave-lengths were thus ascertained to be not far removed from those of the Fraunhofer lines C, D, E, F, G. The instrument employed was a Laurent half-shadow polarimeter fitted with a Lippich's polariser. A simple method of this kind has long been required for the speedy investigation of rotatory dispersion. It is also of importance to have a ready means of obtaining light of short wave-length, which is of especial service when determining the rotatory power of feebly active substances.

IN a paper communicated to *L'Electricien* (Paris), M. G. Darriens gives an account of some recent experiments he has made on the chemical reactions which take place in the ordinary lead accumulator. To get an idea of the chemical state of the negative plate of an accumulator, the author treated a given weight of the negative plate of a fully-charged accumulator with hydrochloric acid, and measured the volume of hydrogen evolved. He then measured the volume of hydrogen evolved when an equal weight of ordinary sheet-lead was dissolved in hydrochloric acid, and obtained practically the same number as before. This experiment seemed to indicate that the negative plate of a charged accumulator consists of metallic

lead, in a very finely-divided state, and that a charged accumulator simply represents an ordinary voltaic cell in which lead is the negative element. In order to test this point, the author has examined the behaviour of several forms of primary battery in which finely-divided lead is used as the negative metal. In the case of a Daniell cell consisting of a copper plate in a saturated solution of copper sulphate and a plate of spongy lead in dilute sulphuric acid, the liquids being separated by an ordinary porous pot, the mean of several experiments gave the value 0.64 volt as the electromotive force. A calculation of the electromotive force of this cell, based on the heats of formation of the different substances, gives 0.3 volt, so that it would appear as if lead in this very finely-divided state evolved more heat when it entered into combination than under ordinary conditions. If this supposition is true, it is necessary to add 0.34 to the figures calculated for ordinary sheet-lead, to allow for this "allotropic" modification of the metal. If we apply this correction to the observed electromotive force (1.6 volts) of an element consisting of  $PbO_2$  and pure lead, we get the quantity 1.94 volts, which represents the electromotive force of the element  $PbO_2$  and spongy lead. The above values can be utilised to calculate the quantity of heat necessary to convert ordinary lead into spongy lead, the value obtained being 7.4 calories. With a Daniell cell, as described above, in which the spongy lead had a surface of one square decimetre, and weighed 4.40 grams, the mean electromotive force was 0.57 volts and the capacity 13.75 ampere-hours, the internal resistance being about 0.12 ohms. This form of cell is subject to the same objection as the ordinary form of Daniell, namely, that after a time the copper-sulphate solution diffuses through the porous pot, and the copper is deposited on the negative metal.

THE filtration of water on a large as well as on a small scale has acquired quite a different significance since the bacteriology of water has sprang into existence; and it is as a useful, because impartial contribution to this subject, that we welcome Surgeon-Major Johnston's short treatise on "the relative efficiency of certain filters for removing micro organisms from water." The investigations here recorded were made as qualifying work for the degree of D.Sc. at Edinburgh University, and the experiments were carried out in the Public Health Laboratory of the University. The filters examined were those known as the Atkins patent water filter, Maignen's table "Filtre Rapide," the Norlimeyer-Berkefeld filter, and the Pasteur-Chamberland filter. The first two filters are described as useless for sterilising water, both of them not only allowing "micro-organisms to pass through the pores," but affording "a suitable nidus for the growth and multiplication of micro-organisms, which are found in much greater numbers in the filtered water than in the unfiltered." The "Berkefeld" and "Chamberland" filters were more elaborately examined. The "Chamberland" cylinder selected was one intended for slow filtration, and in comparing the results obtained with it and the "Berkefeld" cylinder respectively, it must be borne in mind that the rate of filtration through the latter was 5½ times greater than through the former, although after twenty-four hours' continuous filtration, the rate was only 1½ times greater. Major Johnston's opinion, based on his examination of these particular cylinders, is that "the Pasteur-Chamberland filter is the best and only one on which reliance can be placed for permanently sterilising water." An important point, and one which has been overlooked by the author, is the temperature of the room in which the filters were kept whilst under examination. The Clench found that a higher or lower temperature had a marked effect on the efficiency of the Chamberland filter. It is to be regretted that in a treatise of this kind, purporting to have a bibliography, the author has allowed himself to neglect to mention or refer to any

way, a large number of important investigations on these particular filters published during the last few years in various foreign journals.

MR. G. J. SYMONS has contributed to part ii. of the Report of the Chicago Meteorological Congress, an interesting summary of early English meteorological literature, embracing the years 1337-1699. He only deals with some fifty books and pamphlets contained in his own library, but his special knowledge of meteorological bibliography enables him to give some useful particulars about these old works. We can only briefly refer to a few of them here. In the Bodleian Library at Oxford there is (as far as is known) the earliest continuous weather record in the world, containing observations by the Rev. W. Merle from January 1337 to January 1344. A few copies of a translation of this work were printed in 1891. These observations show that the weather at that time was very similar to what it is now. In 1670, "The Shepherds' Legacy" was printed. This work is excessively scarce, and is the earliest edition of what has since been reprinted many times as "The Shepherd of Banbury's Rules for judging the weather." In 1571 appeared "A discourse concerning the Origine and Properties of Wind," &c. This treatise is noteworthy as being probably the first in which the theories of the winds are compared with details of the trade winds, monsoons, &c. In 1696 a work entitled "New Observations on the Natural History of the World of Matter," &c., by the Rev. T. Robinson, was published. It gives the earliest description yet known of the strong local wind known in Cumberland as the *As'm wind*. The subject of this wind has been brought before the Royal Meteorological Society on several recent occasions, and that Society appointed a committee to collect information upon it.

THE November number of the *Journal* of the Chemical Society has been published. It is almost entirely taken up with abstracts of papers published in other journals.

MESSRS. R. FRIEDLANDER AND SON have sent us their *Nature Novitates*, Nos. 14-19, 1894, and No. XXX. of the quarterly list of their new publications. The lists are invaluable to those who wish to keep in touch with recent scientific literature.

THE *Quarterly Journal* (No. 201) of the Geological Society contains several papers on the geology of Africa. Dr. J. W. Gregory describes the glacial geology of Mount Kenya; Captain H. G. Lyons, the stratigraphy and physiography of the Libyan Desert; and Mr. H. Draper, the principal physical and geological features of South-eastern Africa, and the occurrence of dolomite in South Africa. There are seven other papers in the *Journal*, and sixteen plates.

WE have received parts iv. to vii. of the third volume of the *Transactions* of the Leicester Literary and Philosophical Society, extending from July 1893 to July 1894. The Society holds general meetings, at which lectures of a more or less popular character are given, and sectional meetings for the reading and discussion of technical papers. Its object is to cultivate literature, science and art, and, judging from the reports, good work is being done in each of these directions.

IT is well known that Dr. A. Bernihsen's "Text-book of Organic Chemistry" is an excellent elementary account of the principles of organic chemistry. Dr. George McGowan's translation of the work, published by Messrs. Blackie and Son, was reviewed in these columns in December 1885 (vol. xli. p. 172). A second English edition, revised and extended by the author and the translator, has now appeared. It is virtually a translation of the fourth German edition, published last year, and therefore various chapters have been recast in order to include new developments of their subjects.

MESSRS. R. AND J. BECK have just issued an illustrated catalogue of microscopes, object-glasses, and other apparatus for which they are famed. In it we find descriptions of microscopes, from the large binoculars (which some investigators declare to be almost indispensable for certain researches) to the smaller instruments suitable for bacteriological and clinical work, and the useful petrological microscopes. The microscope, like the telescope of the present day, bristles with innumerable accessories, and Messrs. Beck's catalogue appears to contain most of these adjuncts. A copy of the catalogue will be sent, post free, on application.

THE Report of the Weather Bureau of the United States for the year 1893, which has just reached this country, shows that a general reorganisation has been effected, and that the work has been carried on successfully. A very important publication of the results of observations during 1891 and 1892, from upwards of 2000 stations, has been recently issued. Every means is taken to popularise the science; the daily weather map is now issued at seventy-two stations of the Weather Bureau outside of Washington, the number distributed annually being over two and a half millions. The circulation of the weekly weather crop bulletins of the State services has also greatly increased; and continues to be the most valuable feature of State weather service work. A large number of railway companies co-operate with the Bureau in distributing the daily weather forecasts by telegraph over their lines, and whistle-signals are used to a considerable extent in some States. The subject of seasonal forecasts is receiving the careful attention of the Bureau, since the meteorological service of India has indicated a path by which useful results can perhaps be reached. The report also states that Prof. Bigelow continues his studies of magnetism with sufficient prospect of success to justify the time and labour expended. The library of the Bureau now consists of nearly 20,000 books and pamphlets, and the bibliography of meteorology comprises more than 65,000 titles.

CULTIVATORS and admirers of roses will be interested in "Rhodologia"—a discourse on roses and the odour of rose—by Mr. J. C. Sawyer, published by W. J. Smith, North Street, Brighton. Too much attention is generally given to the development of colour, form, and size of the flower, little heed being paid to the great variety of perfumes generated in the beautiful petals. Mr. Sawyer says that there are experienced gardeners who can discriminate many varieties of roses in the dark, recognising them by their perfumes. The pure odour of rose is best represented by *Rosa Damascena*, Miller, and *R. centifolia*, Lin. The art of distilling roses appears to have originated in Persia, and dates from about 1612. In 1684 it is certain that otto of rose was manufactured on a large scale at Shiraz. Otto of rose was known in Europe, however, about forty years sooner than in the East, where its manufacture was first practised. We learn that at the present day the odorous products of the rose are extracted in Bulgaria, France, Germany, and to some extent in India, Persia, Tunis, Algeria, Morocco, and Egypt. The rose cultivated in Bulgaria for the otto is a variety of *R. Damascena*—the red damask rose. *R. centifolia*, which in English gardens is grown as the cabbage rose or Provence rose, is cultivated commercially in the south of France. Mr. Sawyer brings together in his pamphlet a mass of details of interest to students, as well as to manufacturing chemists and buyers of rose-products. Rose growers (both amateur and professional) should certainly read "Rhodologia."

Two remarkable substances, carbazide or carbonyl nitride,  $\text{CON}_6$ , the nitrogen analogue of phosgene gas  $\text{COCl}_2$ , and di-urea,  $\text{CO}(\text{NH} \cdot \text{NH}_2)_2\text{CO}$ , the carbonyl derivative of di-

hydrazine, are described by Prof. Curtius and Herr Heidenreich in the current *Berichte*. The former compound, which is constitutionally formulated  $\text{CO}(\text{N}_3)_2$ , is found to be readily produced when the recently described hydrochloride of carbonylhydrazide,  $\text{CO}(\text{NH} \cdot \text{NH}_2\text{HCl})_2$ , is treated with a cold aqueous solution of sodium nitrite. The reaction is a relatively simple one, proceeding according to the equation:—

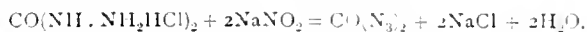

Carbazide as thus produced is a colourless oil of most explosive character. It explodes with great violence when merely touched. When the oil is dissolved in ether, and the solution is allowed to evaporate over calcium chloride, the pure substance  $\text{CON}_6$  is left in long brittle crystals, which usually explode spontaneously in a bright light, but may occasionally be preserved for some little time before disruption. The substance is extremely volatile, and the vapour possesses a most penetrating and stupefying odour, reminding one simultaneously of phosgene gas and azoimide,  $\text{N}_3\text{H}$ . Its composition is readily proved by saponification with alkalis, which convert it into salts of azoimide, which can be precipitated by silver nitrite. It also reacts with aniline in alcoholic solution to produce carbanilide and free azoimide. The second compound described in the

communication, di-urea,  $\text{CO} \begin{matrix} \text{NH} \cdot \text{NH} \\ \text{NH} \cdot \text{NH} \end{matrix} \text{CO}$ , is produced when

the compound  $\begin{matrix} \text{NH} \cdot \text{COOC}_2\text{H}_5 \\ \text{NH} \cdot \text{COOC}_2\text{H}_5 \end{matrix}$ , also recently described by

Prof. Curtius, is heated to  $100^\circ$  in a tube with hydrazine hydrate. Di-urea crystallises readily from water in monoclinic prisms melting at  $270^\circ$ . It behaves as a strong monobasic acid which is capable of expelling carbonic acid from carbonates. The ammonium salt,  $\text{C}_2\text{H}_3\text{N}_4\text{O}_2 \cdot \text{NH}_4 + \text{H}_2\text{O}$ ; barium salt,  $(\text{C}_2\text{H}_3\text{N}_4\text{O}_2)_2\text{Ba} + 3\text{H}_2\text{O}$ ; silver salt,  $\text{C}_2\text{H}_3\text{N}_4\text{O}_2\text{Ag}$ ; and diammonium (hydrazine) salt,  $\text{C}_2\text{H}_3\text{N}_4\text{O}_2 \cdot \text{N}_2\text{H}_5$ , have been prepared and analysed. It is a very stable substance, quite different in this respect from the explosive carbazide above described. When heated, however, with concentrated hydrochloric acid in a sealed tube to  $150^\circ$  it is decomposed into carbonic acid and hydrazine.

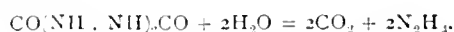

The hydrazine remains combined with the hydrochloric acid in the form of a chloride, presumably diammonium chloride  $\text{N}_2\text{H}_5\text{Cl}$ .

THE additions to the Zoological Society's Gardens during the past week include a Brown Capuchin (*Cebus fatuellus*) from Guana, presented by Mr. Graham S. Pownall; two Common Marmosets (*Leopoldus jacchus*) from South-east Brazil, presented by Mr. D. B. Macdougall; two Black-backed Jackals (*Canis mesomelas*) from South Africa, presented by Mr. Claude Southey; three Crossbills (*Loxia curvirostra*), two Parrot Crossbills (*Loxia pityopsittacus*), an European White-winged Crossbill (*Loxia bifasciatus*), a Yellow Bunting (*Emberiza aureola*), two Northern Marsh Tits (*Parus borealis*) from Russia, presented by Captain A. Newnham; a Double-ringed Dove (*Turtur bitorquatus*) from Java, presented by the Hon. Rose Hubbard; a Black Salamander (*Salamandra atra*), European, presented by Mr. Maurice Suckling; a Bonnet Monkey (*Macacus sinicus*) from India, two Lions (*Felis leo*, 3 ♂) from Africa, deposited; a Golden Plover (*Charadrius fluvialis*), three Dunlins (*Tringa alpina*), European, purchased; a Spotted Pigeon (*Columba maculosa*), a Triangular-spotted Pigeon (*Columba guinea*), two Vinaceous Turtle Doves (*Turtur vinaceus*), bred in the Gardens.

OUR ASTRONOMICAL COLUMN.

OBSERVATIONS OF MARS.

A COMET ON THE ECLIPSE PHOTOGRAPHS OF 1893.—A year ago Prof. Schaeberle announced that the eclipse photographs taken by him at Chile in April 1893, showed a comet-like structure in the corona near the sun's south pole. The photographs taken by the British observers in Brazil and Africa were examined in order to see if they showed the cometary object, but nothing could then be made out. It is well known, however, that faint objects can be easily found when the observer knows what can be seen, and where to look for it. Prof. Schaeberle and Prof. Holden were confident that a comet was photographed upon the corona of the 1893 eclipse, and, with the idea of obtaining confirmation of the discovery, the latter sent Mr. W. H. Wesley copies from negatives obtained at Chile and Brazil, having marks upon them showing the exact position of the object in question. These guides have fulfilled their purpose, for Mr. Wesley says, in the *Observer*, that they clearly point out a cometary structure in the corona. The object is extremely faint, and, unless particular attention is drawn to it, appears like a forked coronal ray. Evidently the only way to prove that the object was really a comet was to measure its angular distance from the moon's limb on the photographs taken at the different eclipse stations. Mr. Wesley has done this, and he finds that the distances are: Chile, 29'; Brazil, 36'; Africa,  $\pm 47'$ . Therefore, it is concluded "the evidence of motion relatively to the sun, given by the comparison of the plates taken at the three stations, seems to place the nature of Prof. Schaeberle's interesting discovery beyond a doubt."

THE TRANSIT OF MERCURY.—The transit of Mercury across the sun on Saturday, November 10, is a matter of more interest to American than to European astronomers. The planet will enter upon the sun's disc at 98' from the North point, counting towards the East, and will leave at a point 50' from the North, counting towards the West. It will reach the sun's limb at five minutes to four in the afternoon; but as the sun sets at Greenwich about twenty minutes later, there will not be much opportunity for observation in London. In America, however, if the weather is favourable, the planet will be observed during the whole of the five hours it will take in transiting. The following are the Greenwich Mean Times of the phases of the transit:—

	Nov. 10	h. m. s.
Ingress, exterior contact		3 55 31.2
Ingress, interior contact	"	3 57 15.4
Least distances of centres 4 26 50	"	6 33 48.5
Egress, interior contact	"	9 10 26.4
Egress, exterior contact	"	9 12 10.4

MERCURY CELL.—Mr. Fowler writes from South Kensington to draw attention to the fact that this remarkable variable will be suitably placed for observations during its progress to the next maximum. According to the *Companion to the Observatory*, the date of maximum was September 24, and the maximum may be expected about February next. It will be of great interest to obtain a spectroscopic record during the rise to maximum, with special reference to the time of appearance of the bright lines of hydrogen, which have been seen near the time of maximum.

Mr. Fowler observed the spectrum on October 24, with the three-foot reflector, and it did not then differ from the spectrum of such a star as a Hercules, in which the hydrogen lines are not known to appear bright. The bright part of the spectrum which is coincident with the carbon band near  $\lambda 5105$  was relatively less bright, however, than when it was observed near the last maximum.

RETURN OF ENGLISH COMETS.—It is reported that Encke's comet was observed at Rome by Prof. Cerulli, near the predicted place, on November 4. According to a search phenomenon given in the *Astronomische Nachrichten*, No. 3260, for Berlin midnight, the comet's place for November 8 is R. A. 22h 50m 30s, Decl.  $-12^{\circ} 32' 15''$ . The comet passes perihelion next February.

THE VARIABLE STAR.—In a *Washburn Observatory Circular*, No. 49, dated October 30, the Rev. T. L. Espin says: "The variability of two red stars, R. A.  $ch. 49.0m$ , Decl.  $+5^{\circ} 1'$  and R. A.  $th. 4.8m$ , Decl.  $+5^{\circ} 46'$  has been definitely ascertained."

A LARGE proportion of the October number of *Astronomy and Astro-Physics* is devoted to articles on Mars, illustrated by several coloured plates. Schiaparelli's map of Mars forms the frontispiece; Prof. Schaeberle contributes nine drawings of the planet; and there are three plates containing drawings made at the Lowell Observatory, Flagstaff, Arizona, by Mr. Percival Lowell, Prof. W. H. Pickering, and Mr. A. E. Douglass. The following statement, from an article by Prof. Pickering, is a chronological summary of the more important facts and discoveries relating to Mars. It is chiefly compiled from Flammarion's monograph on Mars, and should be of special interest at the present time:—

272 B.C. The first known observation of Mars is recorded in Ptolemy's Almagest.

1610. The phases of Mars were discovered by Galileo.

1659. The first sketch showing surface detail was made by Huyghens. He also suggested a rotation in 24 hours.

1666. Cassini determined the rotation of Mars to take place in 24 hours 40 minutes. He also observed the polar caps, and "he distinguished on the disc of Mars, near the terminator, a white spot advancing into the dark portion, and representing without doubt, like those of the moon, a roughness or irregularity of the surface." This latter statement is curious, but the effect was undoubtedly due to irradiation, since his telescope was entirely inadequate to enable him to observe such a delicate phenomenon.

1777. With the exception of Huyghens, Hooke, and possibly Maraldi, no one succeeded in making recognisable sketches of the surface detail upon Mars for over a century, until Sir William Herschel took the matter up in this year.

1783. Sir William Herschel detected the variation of the size of the polar snow caps with the seasons, measured the polar compression, and determined the inclination of the axis of the planet to its orbit.

1785-1802. Schroeter made an extended study of the planet. His drawings are upon the whole rather better than those of Herschel. He discovered among other things the very dark spots to which Prof. Pickering has referred in his publications as the Northern and Equatorial Seas. He, however, supposed them to be clouds.

1840. Beer and Maedler published the first map of the planet, assigning latitudes and longitudes to the various markings. On this map are indicated the first canals, and the first of the small lakes, so many of which have been discovered during the last few years. The canals are Nectar and Agathodaemon and portions of Haed and Tartarus. The lake is Lacus Phoenicis. Their map is the first satisfactory representation of the entire surface of the planet. The only region which previous observers had clearly distinguished was that in the vicinity of the Syrtis Major.

1858. Secchi made a careful study of the colours exhibited by the planet.

1862. Lockyer made the first series of really good sketches of the planet, showing all the characteristic forms with which we are now so familiar. His drawings, and also those of some of the other observers, give the first indications of the appearance of the central branch in the V, so called by Secchi.

1864. Dawes detected eight or ten of the canals.

1867. Huggins detected lines due to the presence of water vapour in the spectrum of Mars.

1867. Proctor determined the period of rotation of Mars within 0.1 second.

1877. Hall discovered the two satellites of Mars.

1877. Green made a very excellent series of drawings of the planet, superior to anything which had preceded them.

1877. Schiaparelli made the first extensive triangulation of the surface of the planet, and added very largely to the number of known canals.

1879. Schiaparelli detected the gemination of Nilus, the first known double canal.

1882. Schiaparelli discovered numerous double canals, and announced that the appearance formed one of the characteristic phenomena of the planet.

Mr. Percival Lowell reports the observations of Mars made at the Lowell Observatory, in continuation of those recorded in our issue of September 13. The subjoined abstract of the paper raises some interesting points. The suitability of the site of the observatory may be judged from the fact that the planet has

been observed at Flagstaff every night, with but few exceptions, since the beginning of June. British astronomers would like to be blessed with similar favourable opportunities.

A noteworthy feature of Mr. Lowell's previous paper was the large area occupied by the dark regions on Mars, while those singular, tilted peninsulas that are so generally represented connecting the continents with the islands to the south were conspicuous by their absence. At that time one continuous belt of bluish-green stretched unbroken from the Hour-glass Sea to the columns of Hercules, or rather to where this pass should have been, for it was not visible. Now (September) the continuity is cut. Hesperia has reappeared, and it has done this in just the way we should expect it to show were it land drying off by a sinking of the general water level. Simultaneously, the region formerly occupied by the polar sea and the region to the north of it from having been blue, has now become for the most part reddish yellow. This reappearance of Hesperia and change of colour of the regions farther south is not due to increasing distinctness of vision consequent upon the nearer approach of the two planets. Had Hesperia been then of anything like the brightness it is now it could not have been invisible. Furthermore, Erikania is at present one of the brightest parts of the disc, not only as it comes round into view, but in mid-career across. Last, and not least in significance, the polar sea has shrunk to a thin line in keeping with the diminished size of the polar cap itself. All this water has gone somewhere.

What may be the condition of these seemingly amphibious lands, whether they be marsh chiefly water at one time and dry land at another; or whether their dark colour be due to vegetation which sprouted under the action of the water, and then died when it withdrew, is a moot point. Mr. Lowell's opinion is that it is half and half; that the transference of the water is chiefly a surface one, and that the layer of water is almost everywhere so shallow as to be soon drained off. His reasons for believing the aqueous circulation to be a surface one are many. In the first place, with the exception of certain peculiar appearances near the south pole, there is no evidence of anything like clouds or mist observable upon the planet, nor has there been since the observations began. On the contrary, all parts of the surface seem to be revealed unveiled. For an aerial circulation the only supposition at all feasible is thought to be that of a heavy, nightly dew, advanced by Prof. Pickering. There are strong reasons in the probable constitution of the Martian atmosphere for believing this possible. But in view of certain facts connected with the canals, and referred to later, the dew theory seems to be improbable.

As to how much of the dark areas are water, and how much vegetation, there is as yet no evidence to decide. Prof. Pickering has made some ingenious polariscope observations to this end, but the difficulties inherent in the process are such as to preclude definite answer as yet. At first the polar sea seemed to show evidence of polarisation, confirming what we knew before of its watery character. Later the lakes, polar sea, and dark areas alike revealed no trace of it. Inasmuch, then, as there is every reason to suspect the polar sea, at least, to be water, we are left in doubt as to the adequacy of the instrumental means to detect at present such minute phenomena.

Since Mr. Lowell's last paper, irregularities have been detected at Flagstaff in the Martian terminator. These fall for the most part under two heads, of which one is practically new. It consists of certain polygonal flattenings first observed on June 30 by Mr. Douglass. Since then these irregularities have become so conspicuous that it is now difficult not to see one of them in the course of an hour's observation. Sometimes they show as simple slices shaved off the terminator, a paring of the planet's surface; sometimes they appear bordered by enclosing projections. They range from twenty to forty degrees wide. But the suggestive thing about them is that they show almost invariably upon that part of the terminator where the darker of the dark regions is then passing out of sight.

At first sight it might seem as if the observed appearance were directly due to the darker areas lying at a lower level than the rest of the surface. But the connection is not so simply direct. For Mr. Lowell points out that were it due to a zone of low-level lying between zones of higher altitude, it could be observed only as a limb effect in this case still further diminished by the cosine of the phase angle, a quantity far too small to be observable.

Nor will variations in slope explain the phenomenon. For

to have an area show as a depression on account of its slope, either the areas on both sides of it must be rising in altitude, or the area itself must be falling in height, and this state of affairs could not go on for ever unless the surface were an impossible spiral. So that the persistency of this flattening is thus unaccounted for.

Prof. Story has suggested that these dark areas have smooth surfaces such as water would have. In this case, remarks Mr. Lowell, the reflection from them, by which alone they would be perceptible, would diminish much more rapidly from the centre to the side than would be the case with regions having rough surfaces, such as deserts. It may be added that though a rough surface, properly constructed, might obliterate itself by its own shallows, this could not happen to either a desert or a forest or a grass-grown plain.

The second kind of irregularities are projections, or small notches, such as are visible upon the lunar terminator; only that the Martian ones are much less pronounced. They are probably due to mountains which seem to be of no great height. The first of these was observed by Mr. Douglass on June 30. An especially prominent one he noted on August 19. It consisted of a projection flanked by a long shadow cutting into the planet obliquely. He measured the shadow's length at 35°. Taking the obliquity into account, this seems to imply a range the length of whose projection would be about 2". It is difficult to say how much of this is due to irradiation; especially as each observer differs. The best tests Mr. Lowell has been able to make give a probable average of about five-sevenths of a tenth of an arc with the power then applied, about 640. Calling the terminal projection of this range therefore 13", its height appears to be about 3700 feet. But the smallness of the quantity measured and the uncertainty of the factor of irradiation renders the result largely indefinite.

A consequence of the slope on the effect of these mountains is interesting. For an elevation need not appear as such. What would show as a projection on the nether side of the terminator would appear as a depression on the hither one.

Interesting plateaus were observed on two occasions by Prof. Pickering. One of these lies in Phœtonis not far from the columns of Hercules, which thus seem to have been most appositely named. Both plateaus rise abruptly, are surprisingly level on top, and stand at about the same height, a height which from the reduced measurements does not probably exceed 2600 feet.

On Mars the second kind of irregularity is less common than the first, and the elevations indicated are apparently never what we should call high. We may therefore conclude that the Martian surface is, as compared with our terrestrial one, relatively flat.

Certain whitish patches have been observed on the planet, first by Prof. Pickering on August 16, and subsequently several times by both Prof. Pickering, Mr. Douglass, and Mr. Lowell. Prof. Pickering calls them clouds. To Mr. Lowell, appearances thus designated are of two kinds. The one, certain whitish, floccular patches not far from the pole, may possibly be cloud; for they present a peculiar aspect, not like snow, nor yet like *terra firma*. No motion, however, has been seen in them. The others are merely certain bright spots on the general surface of the planet. These are not whitish, but yellowish, and will probably do very well for the more arid, dried-up tops of the land. They likewise do not move, and, furthermore, show always the same appearance day after day as regularly as their regions come round. Many of them were equally conspicuous at previous oppositions, and have been chronicled by various observers. Their contours are neither shifty nor indistinct, but as sharp-cut as those of any other region.

Most suggestive of all Martian phenomena are the canals. Were they more generally observable, the world would have been spared much scepticism and more theory. They may, of course, not be artificial, but observations made at the Lowell Observatory indicate that they are. For it is one thing to see two or three canals, and quite another to have the planet's surface mapped with them upon a most elaborate system of triangulation.

In the first place, they were, at the season of writing, bluish-green, of the same colour as the seas into which the longer ones all eventually debouch. In the next place, they are almost without exception geodetically straight, supernaturally so, and this in spite of their leading in every possible direction. The

they are of a generally nearly uniform width throughout their length. What they are is another matter. Mr. Lowell thinks, however, that the mere aspect is enough to cause all theories about glacial fissures or surface cracks to die an instant and natural death.

But it is the singular arrangement that is most suggestively impressive. They have every appearance of having been laid out on a definite and highly economic plan. They cut up the surface of the planet into a network of triangles instantly suggestive of design. What is more, at each of the junctions there is apparently a dark spot. This feature seems to be invariable, as, on closer approach, junction after junction turns out to have one. The larger of these appear on Schiaparelli's chart as lakes. But there would seem to be a small infinity of smaller ones. A short half-hundred of them were seen at Arequipa in 1872, and others have recently been detected at Flagstaff. For example, an important new canal, which runs from the western end of the sea of the Sirens to Ceramias, and which in view of its point of departure Mr. Lowell is induced to call the *Ulysses*, passes through three of these small dark spots on the way, one at each junction. One of these was seen at Arequipa and elsewhere in 1892; the other two are new discoveries. The region of the Lake of the Sun is especially fertile in canals. In one of the drawings which accompanies the paper here summarised, thirty-one canals are to be seen, counting each line between junctions as a separate canal. Of these seventeen are among those in Schiaparelli's chart, while fourteen are not. Of the twelve lakes in the figure, five are not down on his chart. This is thought not, in general, to be the result of change, though changes there apparently have been after proper discount has been made for difference of observations and of drawing. First and foremost, the Golden Chersonese has vanished; the land of Ophir now forms the continental coast-line. Secondly, Icaria has entirely altered in contour, resembling now an open fan about the Phoenix lake for pivot. Phœtonis has shrunk to one-third of its former width—as represented in Schiaparelli's chart. Esphoros no longer enters Phoenix lake at the point opposite Pyriphlegethon, but farther to the west. But the strangest transformation of all is that of the Phasis, which has apparently obliquely become two (not geminated in the technical sense) to suit both the old and the new state of things. There is now a canal running in the same direction as the old Phasis, but not to the southern end of Phœtonis; and there is another one running to the southern end of Phœtonis, but not in the same direction as heretofore. This attempt to carry out two apparently important ends by self-multiplication is not a common characteristic of inanimate nature—a point which Mr. Lowell holds is worth consideration.

Mr. A. Stanley Williams contributes to the November 20, 1894, an account of his observations of Mars up to October 20. With regard to the canals Mr. Williams says:—"By taking advantage of every favourable opportunity, fifty-one canals have been observed up to the present time [October 20]. These include most of those shown in Prof. Schiaparelli's latest map that could be properly observed at present, and in addition three others not marked in the map. Generally speaking there is no difficulty in certainly identifying the canals, with the exception of a few which are situated far north, and consequently are too close to the limb to be distinctly observed. The general accuracy of the map is very striking, and I have often been strongly impressed by the very thorough manner in which Prof. Schiaparelli's work has been done. It is most rare to come across the trace of a canal not marked in his map, and the positions of objects are usually very reliable."

In the number of canals of our contemporary, Mr. Williams stated that Erion was probably double. Later observations, however, have shown it to be only single, the apparent gemination being probably due by the existence of a feeble, unobserved one running parallel to it, and about midway between it and the coast bordering the Fœne Sea. Agathocleion and Avaros were seen entirely double on three or four nights in September. Chryorthos was also seen double, but this was not apparent as an independent object compared with Archelocleion and Arave. In September, Mr. Williams saw Anathos as a narrow moon-pass, and apparently single canal. At the beginning of October, however, the object appeared as a very broad, dark, double canal. Canals as marked by gemination are doubtless the majority of which, according to Mr. Williams, are observations to be apparent in any ordinary way in which observations are possible.

Referring to the small dark spots designated lakes, Mr. Williams says:—"Several more of these curious dark spots have been seen. Lacus Phœnicis on a good night appears as a small, nearly round, almost black spot, resembling the shadow of a satellite of Jupiter when in transit. On one night a feeble companion spot was seen just preceding it. Lacus Tithonius is a similar definite and nearly black spot, with a feeble companion following it. In a fine drawing of Mars, dated September 5, Mr. Cammell shows Lacus Moeris as a minute dark spot, with Nepenthes as a narrow definite line, and so I have seen them on several nights lately. Lacus Tritonis is a similar spot. At the junction of the canals Amenthes (following component), Thoos, and Astapus, there is also a little dark spot. The dark spot at the north end of the Ganges, known as Lacus Lunæ, has been rather perplexing. On several nights there was an evident appearance of duplicity about it, though it was impossible to say with certainty in which direction it was double. At length, however, the mystery was cleared up, the lake having been seen distinctly double on September 29 at right angles to the direction of the Hydraotes. The streak or bridge dividing the lake into two was bright yellow."

The varying appearances presented during October by the Mare Cimmerium, and the extensive region lying to the north of it, leads Mr. Williams to think that a great development of cloud or mist has lately taken place on Mars. His observations suggest "that cloud and mist formations are much more extensive and common on Mars than is generally considered to be the case."

#### THE ELECTRIC CONDUCTIVITY OF PURE WATER.

THE difficulties besetting the preparation of water free from the last traces of dissolved impurity cannot be better illustrated than by the attempts which have been made to ascertain the electric conductivity of the pure liquid. At the outset it has to be remembered that the conductivity of water is exceedingly small. As the result of the most recent observations it has been found that one millimetre of water has at 0° almost the same resistance as 40,000,000 kilometres of copper of the same cross-section; consequently a copper wire having the same resistance and sectional area as one millimetre of water would be long enough to encircle the earth one thousand times. From the difficulty of preventing the introduction of small quantities of dissolved material into the water, and from the large diminution which such impurities exercise upon the resistance, there is probably no physical constant for which such widely varying values have been given as for the electric conductivity of water.

If the conductivity of mercury be taken as  $10^{10}$ , prior to 1875, the following values had been ascribed to water by the observers named:—So, Pouillet; 70, Becquerel; 15, Oberbeck; 4.5, Rosetti; 2.16, Quincke; and 1.33, Magnus. In 1875, Kohlrausch succeeded in reducing the observed conductivity to 0.74, or a value only 1/120th of that given by Pouillet. The large diminution thus brought about was no doubt due, for the most part, to the improved methods employed in obtaining purer samples of water. In Kohlrausch's experiments pains were taken not only to remove organic matter and any volatile alkaline or acid impurities from the water, but also to ensure that in its subsequent treatment contact with glass was avoided, the purified water being distilled through a platinum condenser into a platinum resistance-cell. The next important modification in the treatment of the water was again introduced by Kohlrausch in 1884. The whole of the above measurements had been made upon water distilled under ordinary conditions, and thus in presence of air; he therefore proceeded to ascertain what alteration in conductivity took place when the water was rendered air-free. For this end he employed a glass apparatus resembling in construction the so-called "water-hammer." A glass bulb of some 150 c.c. capacity, which served as a retort, was connected by a glass tube with a small glass receiver fitted with platinum electrodes. In this receiver the resistance of the water was measured by the use of a galvanometer and a continuous current, as the latter was so feeble that no appreciable effect was produced by polarisation. The glass connecting-tube was provided with a vertical branch, through which water, or liquids to clean the apparatus, could be introduced. The vessel admitted a quantity of purified water into the bulb, the vertical tube was then connected with a mercury air-pump, the pump



set in action, and the water repeatedly shaken. A flask of cooled sulphuric acid was also put into communication with the evacuated enclosure to absorb water vapour, and thus promote partial distillation of the water. When dissolved gases had been removed, the vertical tube was sealed, and water was then distilled from the bulb into the receiver, the former being immersed in a bath at a temperature of  $30^{\circ}$  to  $40^{\circ}$ , and the latter in a cooling mixture at from  $0^{\circ}$  to  $-8^{\circ}$ ; the temperature being kept as low as possible in order to diminish the solvent action of water on the glass. The value obtained in this way for the conductivity at  $18^{\circ}$  was 0.25, or a number which is practically only one-third of that given by water distilled in air.

Small as this number was, it was not supposed to represent the actual conductivity of water, because experiment showed that the conductivity altered rapidly with the time, owing to the dissolution by the water of material from the glass receiver, and from the electrodes. The correctness of this supposition is strikingly verified in a communication recently made by Kohlrausch and Heydweiller to the Berlin Academy of Sciences (*Sitzungsberichte*, March 1894). One of the pieces of apparatus used in 1884, and described above, had been allowed to stand filled with water for some ten years, and, apparently from long contact with the water, the glass has become much less soluble than it is under ordinary circumstances. Indeed, during the time necessary for an observation the conductivity does not alter appreciably, and only rises by 0.01 in a day. The method of experiment employed is similar to that just described, the main modifications consisting in additional precautions to obtain the water air-free, and in freezing the purified water prior to its introduction into the apparatus. This method of freezing, suggested first by Nernst, is of value in eliminating volatile impurities which might distil over with the steam. The smallest value now found for the conductivity is 0.04 at  $18^{\circ}$ , or a number which is only 1/2000th of the original value given by Pouillet, and only one-sixth of that obtained in the same apparatus in 1884.

Since with each improvement the value for the conductivity has been largely reduced, the question which naturally arises in connection with this last result is, how closely can it be supposed to approximate to the truth? Indeed, seeing that the conductivity is so very small, it might fairly be suspected that absolutely pure water is itself a non-conductor, and that the observed conductivity is merely due to the presence of a slight trace of impurity. As it seems almost impossible to answer this question by purely experimental methods, theoretical aids have to be employed, and by means of the hypotheses involved in the new theory of solutions, Kohlrausch and Heydweiller proceed to show that pure water is actually a conductor, and that its conductivity can be ascertained from their observations. The method they employ is briefly as follows:—According to Arrhenius, if water is a conductor, the reason for this is that certain of its molecules exist dissociated into the ions H and OH. Moreover, the magnitude of the conductivity depends upon two factors: firstly, on the number of dissociated molecules; and secondly, on the velocities with which the ions travel. The conductivity varies with the temperature because the number of dissociated molecules, as well as the ionic velocities, increases with the temperature. From these theoretical views, although it is not possible to estimate the actual value of the conductivity, yet the rate at which it should vary with the temperature may be ascertained. For, in the first place, according to van't Hoff, the extent of the dissociation should vary with the temperature just as it does in a dissociating gaseous system; and in the second place, the velocities of the ions H and OH may readily be obtained at different temperatures from measurements on dilute aqueous solutions, such as those of KOH, HCl, and KCl.

Now, Kohlrausch and Heydweiller measured at  $18^{\circ}$  the temperature-rate of change for a series of samples of water of different degrees of purity, and also the conductivity of two samples of very pure water at temperatures between  $2^{\circ}$  and  $50^{\circ}$ . They then assumed that the observed conductivity was really a sum, being composed of the conductivities of pure water and a dissolved impurity. They were thus enabled to show how it is possible, by making use of the rate of change as deduced by theory for the single temperature of  $18^{\circ}$ , to obtain from their observations the conductivity of pure water at different temperatures.

The first result arrived at, is that the temperature function of the conductivity over the entire range from  $-2^{\circ}$  to  $50^{\circ}$  agrees

within the limits of the experimental errors with the function predicted by theory. This, as the authors remark, is one of the most remarkable confirmations yet adduced of the validity of the hypothesis of the new theory of solutions. The second and the most important conclusion for the question under discussion is, that at  $18^{\circ}$  the conductivity of pure water has in all probability the value 0.0351. The smallest value actually observed, it will be remembered, was 0.0404. The impurity present in the sample affected the conductivity, therefore, by 0.0043, or by some 10 per cent. If this impurity were of the nature of a salt, as in all likelihood it is, the amount which would exert this effect would not require to be more than a few thousandths of a milligram per litre. We have here, therefore, the remarkable result that an impurity of this nature, if present to the extent of only a few parts per thousand million, is capable of influencing the conductivity by as much as 10 per cent. of its value. This, together with what has already been said, leaves little question that of all the physical constants of water, there is none which is so sensitive to small traces of dissolved impurity as its electric conductivity. J. W. RODGER.

### NEO-VITALISM.

A QUARTER of a century ago, du Bois-Reymond headed the revolt of Mechanicalist Biology against the Vitalism of Johannes Müller. From Bichat to Magenlie, from Johannes Müller to Schwann, the pendulum swung backwards and forwards; but it was reserved for du Bois-Reymond, in his now famous Berlin addresses, together with Ludwig and Helmholtz, to expose the fallacies of vitalism, and establish physiology on a mechanical basis.

In the present address he takes up arms against the "new vitalism," which since the discoveries of Heidenhain *re* activity of cell in secretion *versus* mere mechanical diffusion, has made a new departure, based on a partial misconception of these secretory activities. The position of the debate as it now stands will be best shown by an abstract of Prof. du Bois-Reymond's recent manifesto.

From Descartes and Leibnitz, until they encountered their first opponent in Magendie, vitalistic theories were paramount. During this period "vital force" was conceived as the attribute of the soul in distinction to the body, or confused with the so-called "nervous principle," with animal heat or electricity.

Johannes Müller and Schwann again fought out the question; even the discovery by Schwann of independent cell-life in the organism failing to convince Müller that his views were erroneous. The overthrow of vitalism was reserved for Ludwig, whose autographic methods strengthened the physical side of experimental physiology. He came forward as the champion of anti-vitalism, and the same position was taken up by many of Müller's immediate pupils. The fundamental difference between this and all previous criticism lay in the physico-mathematical training of the antagonists, which enabled them to detect the *πρωτον ζεύδος* of vitalism. This prime error is the misconception of "force." Force is not an entity existing apart from matter; it is ultimately a mathematical concept, standing for the physical changes which alone can be known to us. The atoms are not a truck to which the forces can be harnessed; their attributes are eternal, integral, inalienable. Helmholtz said that without a rational conception of nature, scientific research would have no meaning; vital force, however, is unthinkable.

The fundamental distinction between organic and inorganic bodies has not been adequately recognised. In crystals, and dead bodies generally, matter is in static equilibrium, stable, indifferent, or labile; in living organisms, the equilibrium is dynamic. As in heat, and electrical diffusion, the rise and fall of element is balanced; there is constant metabolism. And metabolism, as well as the conservation of energy, present insuperable difficulties to the vitalist. Heat and muscular work, ciliary and amoeboid movements, not least electricity, cannot be generated in animals otherwise than by conversion of potential into kinetic energy, by oxidation of carbon and hydrogen. For this nutritive matters—air, warmth, moisture, and for plants light (the "integrating stimuli" of J. Müller) are indispensable.

"Ueber Neo-Vitalismus." Von du Bois-Reymond. Sitzung-Berichte der Akademie der Wissenschaften zu Berlin. Öffentliche Sitzung zu Faveur des Laborschen Jahrestages vom 23. Juni, 1894.

canon law. And we must further compare the speed of organic processes with those of the crystal—quiescent to all eternity, unless disturbed by external forces. One of the finest conceptions of modern science is that the dynamic equilibrium in the life of the individual corresponds to the cycle of living matter in all nature.

Table equilibrium is, however, preponderant in the organism. And here is the simplest explanation of the reaction which makes peculiar to living beings,—excitability. The specific energies yielded up by living things in response to stimulus, amount to nothing more than the mechanical reaction of a red-hot iron which we find, *e.g.*, in a chronometer. A repeating clock, in its specific reaction to stress or strain, heat or cold, moisture or dryness, electrical or chemical influences, presents a close analogy to the living muscle.

A final blow, it seemed, was dealt to vitalism by Darwin's "Origin of Species," which, through natural selection and the survival of the fittest, accounted rationally for existing variations. Thus the controversy was to all appearance ended. Of late, however, on anatomical rather than on physiological grounds, a new school of vitalism has arisen. By a somewhat strained conclusion from the labours of Schwann and Heidenhain, it is asserted that the processes deriving from elemental organisms are too vast in relation to the latter to be accounted for on mechanical principles. A more satisfactory *rationale* for heredity is also demanded.

Prof. du Bois-Reymond dismisses in a few words the arguments of Driesch and Kundfleisch (1888-93). In regard to Pange's "Lehrbuch der physiol. Chemie," 1887, he points out that the "anxiety behind which lies the mystery of life" is only static equilibrium of the organism, dependent on integrating stimuli, and reducible to a physical equation. In fact, it is metabolism, maintained by chemical processes, which convert potential into kinetic energy. We have here the *παρρησία* of the older vitalism, for it matters little whether we deal with the comparatively simple problem of fifty years back, or with Driesch and Bunge, search into the cell and its atoms, or their yet unknown final particles. Impassable, indeed, are the limits of our knowledge, but let us confine our *ignorantia* to its proper frontier.

To the first contention of Neo-vitalism, du Bois-Reymond opposes the molecular theory with its infinitesimal particles of matter; for the last, he refers us to the current controversy between Weismann and Herbert Spencer. There is, doubtless, room for criticism of the Darwinian theory. For instance, natural selection fails to account for the appearance of organs, such as the poison-fangs of snakes or the electric organs of fishes, which are useless in the struggle for existence until fully developed. But if Darwinism were fore-doomed, and exposed, in the words of Herr Driesch, as "a cheap and specious deception," it is improbable that Neo-Vitalism would reap any benefit. There may be still another solution to the problem.

Now, as before, we stand in face of the unsolved riddle, Origin of Being, with all the wondrous chain and intricacies of development. Yet as an alternative to supernaturalism, we can conceive one primordial act of creation whereby the germ of life inherent in matter could develop by its intrinsic laws into the brain of a Newton. Thus, with no day of creation, the whole order of nature would evolve mechanically, without intervention of God or New Vitalism.

And so we return upon the ideas of Leibnitz, save that Materialism replaces Supernaturalism, inasmuch as we may conceive that infinite matter, with its qualities as we know them, has been ending in infinite space from all eternity.

FRANCIS A. WELBY.

#### SCIENCE IN THE MAGAZINES.

PROF. A. W. RECHER contributes to the *Fortnightly* a brief and sketch of the work of von Helmholtz. Our readers are familiar with the investigation carried out by this eminent physicist; nevertheless, the two concluding paragraphs of Prof. Recher's article sum up the chief of them so admirably as to be worth quoting here.

"He was one of the first to grasp the principle of the Conservation of Energy. He struck, independently, and a century before, the same power, in his own system. He penetrated far below the surface of the mechanism of every living organism,

which connects us with external nature through the eye and the ear. He discovered the fundamental properties of vortex motion in a perfect liquid, which have since not only been applied in the explanation of all sorts of physical phenomena, of ripple marks in the sand, and of cirrus clouds in the air, but have been the bases of some of the most advanced and pregnant speculations as to the constitution of matter and of the luminiferous ether itself.

"These scientific achievements are not, perhaps, of the type which most easily commands general attention. They have not been utilised in theological warfare; they have not revolutionised the daily business of the world. It will, however, be universally admitted that such tests do not supply a real measure of the greatness of a student of nature. That must finally be appraised by his power of detecting beneath the complication of things as they seem, something of the order which rules things as they are. Judged by this standard, few names will take a higher place than that of Hermann von Helmholtz."

In the same magazine Sir Robert Ball discusses the possibility of life in other worlds—a subject that has a curious fascination for the un-scientific, but upon which the author throws the light of modern scientific knowledge. "No reasonable person will," he thinks, "doubt that the tendency of modern research has been in favour of the supposition that there may be life on some of the other globes. But the character of each organism has to be fitted so exactly to its environment that it seems in the highest degree unlikely that any organism we know here could live on any other globe elsewhere. We cannot conjecture what the organism must be which would be adapted for residence in Venus or Mars, nor does any line of research at present known to us hold out the hope of more definite knowledge." The verdict thus appears to be "possible, but not probable," and the subject therefore stands where it did.

Mr. R. S. Gundry contributes to the same magazine an article on Corea, China, and Japan; and Mr. A. H. Savage-Landor one on Japanese people and customs; while Mr. G. Lindsay describes his rambles in Norsk Finmarken.

Prof. N. S. Shaler contributes to *Scribner* an interesting paper on "The Horse," the text being illustrated with pictures by Delort. He does not speak very highly of the animal's intelligence. In his words: "The mental peculiarities of the horse are much less characteristic than its physical. It is, indeed, the common opinion, among those who do not know the animal well, that it is endowed with much sagacity, but no experienced and careful observer is likely to maintain this opinion. All such students find the intelligence of the horse to be very limited. Although some part of this mental defect in the horse, causing its actions to be widely contrasted with those of the dog, may be due to a lack of deliberate training and to breeding with reference to intellectual accomplishment, we see by comparing the creature with the elephant, which practically has never been bred in captivity, that the equine mind is, from the point of view of rationality, very feeble." It is worth remark, however, that a good deal of misapprehension exists as to the intelligence of the elephant. According to the best authorities, though elephants are docile and obedient, their intellectual capacity is below that of most other Ungulates. Colonel H. G. Front contributes his second article on "English Railroad Methods," giving a number of interesting facts respecting passenger and freight traffic, cost of construction, &c., in England and America.

Colonel A. G. Durand shows, in a paper in the *Contemporary*, that the southern region of the Eastern Hindu Kush is one full of interest. In the *Humantarian*, St. George Mivart writes on "Heredity." A portrait of the author forms the frontispiece of the number. Mr. Grant Allen continues his moorland idylls in the *English Illustrated*, his subject this month being house-martins.

*Chambers's Journal* contains its usual complement of chatty articles, among which may be mentioned "Feathered Architects," "The Infinity of Space," and "The Vanishing Eland," *Longman's Magazine* reprints an address, "How to Make the Most of Life," delivered by Sir B. W. Richardson before the Literary and Scientific Section of the Grindelwald Conference this year. The Rev. E. G. Johns writes on "The Injuries and Benefits of Insects" in the *Sunday Magazine*, and the Rev. T. R. K. Stebbing contributes an instructive article on certain crustacea to *Good Words*. The latter magazine also contains an article on tea, by Mrs. A. H. Green, and a well-written explanation of the laws of motion, by Emma Marie Caillard.

## UNIVERSITY AND EDUCATIONAL INTELLIGENCE.

OXFORD.—The examiners for the Burdett-Coutts Scholarship have reported that no candidate of sufficient merit has presented himself for examination. The Scholarship, therefore, has not been awarded this year.

There will be an election to a Geographical Studentship of the value of £100 at the end of Hilary Term, 1895. Candidates should send in their names to the Reader in Geography, 1 Bradmore Road, Oxford, before Wednesday, February 27, 1895.

The Savilian Professor of Astronomy, Prof. H. H. Turner, will lecture in the Schools on Thursday, November 8, on the subject of the Transit of Mercury on Saturday, November 10.

In a Convocation held on Tuesday, November 6, the degree of Master of Arts, by decree of the House, was conferred on Robert Warington, F.R.S., Sibthorpean Professor of Rural Economy.

CAMBRIDGE.—The Cavendish Laboratory Syndicate have presented a report on the pressing needs of the department of experimental physics. It appears that a large laboratory for elementary classes and an additional lecture room, together with certain accessory rooms, are urgently required. To erect and furnish these on a suitable scale would require some £10,000. As the University is unable to meet any such expense at present, it is proposed to put up part of the building at an expense of £4000, of which half can be provided from the accumulated fees of students working in the laboratory. The Financial Board think that £2000 more can be obtained from the Common University Fund. Mr. Fawcett, the architect, has prepared plans for the work, which are to be seen at the Cavendish Laboratory.

The Sedgwick Memorial Museum Syndicate state that the tenders for the building designed by Mr. T. G. Jackson, A.R.A., have been some £4500 in excess of the estimate based on the architect's calculations. They are reluctantly forced to the conclusion that the University cannot afford to supplement the Memorial Fund to the required extent, and they accordingly ask powers to reconsider the plan, or to substitute a new one for it.

At the annual election to Fellowships at St. John's College, on November 5, Mr. H. C. Pocklington was one of the successful candidates. He was bracketed Fourth Wrangler 1892, was placed in the first division of the first class with Mr. Cowell, the Senior Wrangler, in Part II. of the Tripos of 1893, and this year gained one of the Smith's Prizes, the other falling to Mr. Hough, also a scholar of St. John's. Mr. Pocklington presented a dissertation on the periods of the vibrations of a vortex-ring constituted by fluid circulating round a hollow core, in which the periods of the unsymmetrical vibrations are for the first time determined. The analysis also included a determination of the effect which an electric charge would produce on the vibrations and the stability of a vortex atom in a rotational ether. In a minor investigation, which will appear in the next number of the *Proceedings* of the Cambridge Philosophical Society, the forms assumed by two parallel cylindrical hollow vortices moving steadily through fluid, and the character of the surrounding motion, are investigated in detail.

Mr. S. Sanders has bequeathed to the University £2000 for the endowment of a Reader in "Bibliography, palæography, typography, bookbinding, book-illustration, and the science of books and manuscripts."

As the result of the prolonged discussion on post-graduate study in the University, the Council of the Senate have sanctioned a grace for the appointment of a syndicate to consider (1) the best means of giving further help and encouragement to persons who desire to pursue courses of advanced study or research within the University; (2) what classes of students should be admitted to such courses; and (3) what academic recognition, whether by degrees or otherwise, should be given to such students, and on what conditions.

Mr. Herman, of Trinity College, has been appointed Chairman of Examiners for the Mathematical Tripos, Part I.

Dr. Forsyth, F.R.S., Sir R. S. Ball, F.R.S., R. T. Glazebrook, F.R.S., and Prof. G. B. Mathews, have been appointed Examiners for Part. II. of the Mathematical Tripos.

Prof. Ewing, F.R.S., Prof. Osborne Reynolds, F.R.S., and W. N. Shaw, F.R.S., have been appointed Examiners for the Mechanical Sciences Tripos.

DUBLIN.—The medals in Natural Science, given at Moderation, have been awarded as follows:—Gold medals to R. A. Rossiter and T. B. Jobson; silver medal to C. W. Orpen. The Professor of Botany's prizes for practical work on the Gymnosperms, to be accompanied by sections and drawings, have been given to T. B. Jobson, for work on the anatomy of the young stem of *Quercus biloba* and on the reproductive organs of *Taxus baccata*; and to R. A. Rossiter, for work on the floral development of *Tilia phytata* and *Lonicera Europea*.

Lectures on the Experimental and Natural Sciences for Michaelmas Term commenced on November 2. Prof. Reynolds lectures on Inorganic Chemistry, Prof. Fitzgerald on Heat, Prof. Sollas on Mineralogy and Physical Geology. Prof. Mackintosh lectures on Zoology, and gives demonstrations on Comparative Anatomy. Prof. Wright lectures on Algae and Fungi, and gives a series of demonstrations on the Vascular Cryptogams. The assistant to the Professor of Botany, Mr. H. Dixon, gives a course of Laboratory instruction on vegetable cells and tissues.

The special courses in Natural Science for 1895 are in Geology, the Cambrian Period; in Zoology, the Invertebrate Heart; in Botany, the Natural Orders, Cruciferae and Papilionaceae.

The Anthropological Laboratory has reopened for the session 1894-95. Dr. C. R. Browne will, under the direction of Prof. D. Cunningham, give, on three days in each week during Term, demonstrations on Anthropological Methods. These will be open to all students.

Assisted by a grant from the Royal Irish Academy, Dr. C. R. Browne visited, during the long vacation, the district of North Erris, in the county of Mayo, believed to be one of the most primitive regions in Ireland. The anthropological results of this visit will in due course be laid before the Irish Academy.

The Dublin University Experimental Science Association held its first meeting for its eighteenth session on the 6th inst. Prof. Sollas delivered the opening address, in which he treated of "Geological Time."

FROM a Return made to the Department of Science and Art, and published last week, it appears that the total amount spent on technical education during the year 1892-93, in England, Wales, and Scotland, was £529,718, and that the estimated total amount allocated to technical education for the year 1893-94 was £696,328. Forty-one out of the forty-nine county councils in England are applying the whole of the residue received under the Local Taxation (Customs and Excise) Act to technical education, and eight a part of it to the same purpose. Of the councils of the sixty-one county boroughs, fifty-three are devoting the whole of the residue to technical education, and seven a part of it. The thirteen county councils and the three county boroughs in Wales and Monmouth are not only devoting the whole of the residue to intermediate and technical education, but six of them are also levying a rate, or making grants out of the rates, for the same purpose. In the case of Scotland, twenty-three out of the thirty-three county councils are applying the available funds to technical education, and seven a part. Of the 194 burghs and police burghs, however, 122 are applying the whole to the relief of rates.

THE Technical School Committee of the Birmingham Corporation have appointed Dr. W. E. Sampner, of the Battersea Polytechnic School, from among seventy-five candidates, as Principal of the new local Technical School. The salary is £500 per annum.

THE extensive buildings that have been lately erected as an addition to the medical school at the Owens College, Manchester, were formally opened by the Duke of Devonshire, the President of the institution, on Tuesday.

## SCIENTIFIC SERIALS

*American Meteorological Journal*, October.—The meteorological services of South America, by A. L. Rotch. In the Argentine Republic there are now five stations of the first order, forty of the second order, and one hundred rain stations. The first of the *Annales* was published in 1878, and dealt with the climate of Buenos Ayres from observations since 1801. In Uruguay there is one observatory of the first order, at Villa Colon, near Montevideo, and in 1890 a Meteorological Society was established, and publishes a

monthly review. In Paris, observations were made at Rio de Janeiro, since 1825, but no record of them is to be found until 1844; from this time summaries have been regularly published. A Central Meteorological Department was established in 1858 in connection with the bureau of the Navy, but the climatological service has not yet been organised.—The forecasting of ocean storms, &c., by W. Ailingham. This paper was presented at the International Meteorological Congress held at Chicago in August last. It deals more particularly with the storms of the North Atlantic, and the author shows that at present any attempt to forecast them from America is not very successful. Nevertheless, the Meteorological Office of Paris continues to receive and publish daily reports from the United States and Canada, as well as from steamers arriving at American ports from the Atlantic.—Sun-spots and Auroras, by Prof. H. A. Hazen. The author has laid down curves of all the sun-spots measured on the Greenwich and India photographs from 1881 to 1888, and also the auroral numbers recorded in the United States, and shows that auroras and sun-spots are not concomitant or coincident phenomena. For the purpose of including into the annual range, the auroras and sun-spots for twenty-three years have been summed for months. There is a remarkable correspondence in these results; both phenomena show a maximum in April, and the second maximum occurs in September for auroras, and in October for sun-spots. Prof. Hazen considers that the investigation of sun-spots and auroras is the most promising line that can be taken in a study of the possible effects from some cosmical force upon our atmosphere.

*Bulletin of the American Mathematical Society*, second series, vol. 1, No. 1, October 1894.—This is a continuation of the *Bulletin* of the New York Society. The title of the Society having been changed, as previously announced, of necessity the title of the *Bulletin* is also changed. An article on the "Summer meeting of the American Mathematical Society" gives an account of the doings, and abstracts of the papers read, at the August meeting in Brooklyn, N.Y., of the American Association for the Advancement of Science. The co-operation of the two Associations resulted in a successful gathering for the younger body. Other articles in this number are on the connection between binary quatics and elliptic functions, by Prof. E. Study. This is an abstract of a paper which will appear in the *American Journal of Mathematics*. It shows how a certain group of rational and irrational co-variants of a binary quartic can be expressed as one-valued functions of one or two parameters, thus filling up a number of lacunæ contained in former presentations of the subject.—Reduction of the resultant of a binary quartic and cubic by virtue of its semi-invariant property, by Prof. H. S. White. The author discusses the partial problem solved by Clebsch, viz. to write in symbolic form the resultant of a binary quartic and a binary quadratic of arbitrary order. The method employed is novel, and illustrates the utility of the theory of conjugate forms.—Next a list of a number of papers read at the American Association meeting (see page 37), is given, and short abstracts supplied. Notes and new publications complete this number.

*American Journal of Mathematics*, vol. xvi, No. 4 (Baltimore, October 1894).—"Sur la transformation des courbes algébriques," by E. Goursat (pp. 291-298), discusses two generalisations of a theorem demonstrated by Lacroix (*Math. Anal.*, t. iv, p. 165). The rest of the number (pp. 291-396) is taken up by a masterly memoir on isotropic elastic solids of nearly spherical form, by G. Choussé. It is preceded by a full table of contents, and has 320 equations. The author remarks that the investigation of a solution of the elastic solid equations for the equilibrium or motion of homogeneous isotropic material enclosed by the simplest of all surfaces, the spherical, presents no small difficulties. For even a slight departure from the spherical form the increase of difficulty is so considerable that, as far as I know, the only problem of the class successfully treated hitherto is that of a nearly spherical solid exposed to gravitational force, but free of all surface force. In the case considered by Mr. Choussé, various forces appear, as well as bodily forces, so that the problem is much more general than that previously treated. His method is new, and, in my opinion, classes with the most important in the history of the science on the earth.

*American Journal of Science and Technology*, No. 8. Notes on the "Application of recent communications from M. Ch. Lagrange," by M. J. F. J. The author claims to have been

the first to announce that the theoretical period of initial nutation would be found too short owing to the internal fluidity of the globe, and that the best method for observing this nutation would be that of observations at intervals of twelve hours. He also states that the variations of latitude would be equal and of opposite sign on two opposite meridians in the same hemisphere, which was borne out by observations in Europe and Honolulu. His hypothesis explaining the annual variations is capable of explaining and estimating the systematic differences between the catalogues of Greenwich and the Cape, given by Downing, and by the diurnal nutation, and the differences between Paris, Pulkowa, and Washington, and between Melbourne and the Cape.—On the origin of the diastole and the undulations of the systolic plateau of arterial pulsation, by Victor Willem. This work was undertaken in order to decide whether any of the pulsations shown by the sphygmograph and the recorders of arterial pressure have a peripheral origin, or whether they all start from the heart and its neighbourhood. Experiments upon the carotid and crural arteries of dogs show that the latter alternative is true. The author further studied the influence of various injections upon the pulsation.

## SOCIETIES AND ACADEMIES.

### LONDON.

Entomological Society, October 17.—Henry John Elwes, President, in the chair.—Dr. H. G. Breyer, of Pretoria, Transvaal, South Africa, was elected a Fellow of the Society. Mr. G. C. Champion read a letter, dated August 15 last, from Mr. J. Y. Johnson, of Funchal, Madeira, on the subject of a recent visitation of locusts to the island, and exhibited specimens. Mr. Johnson mentioned that Darwin, in his "Origin of Species," recorded that in November 1844, dense swarms of locusts visited Madeira. He said that since then, until August last, these insects had not visited the island. Mr. Champion remarked that the species was *Delicatus albifrons*, Fabr., not a true migratory locust. Mr. Champion also exhibited specimens of *Anthaxia nitidula*, *Velleius dilatatus* and *Athous ruficornis*, taken by himself in the New Forest during the past summer.—Mr. H. Goss read a letter received from Captain Montgomery, J.P., of Mid Ilovo, Natal, reporting vast flights of locusts there, extending over three miles in length, on August 31 last, and exhibited a specimen of the locust, a species of *Acridium*. Captain Montgomery stated that, as a rule, his district, like most of Natal, was free from the pest, but that an exceptional invasion had occurred in 1850. Mr. J. W. Tutt exhibited four typical specimens of *Eumylia cribrum* from the New Forest, and, for comparison, four specimens of the variety, *caudata*, of the same species, taken at an elevation of 4000 feet, near Courmayeur, on the Italian side of Mont Blanc. He stated that he had also met with this form in the Cogne Valley, at an elevation of from 6000 to 8000 feet.—Mr. R. Adkin exhibited a specimen of *Erebia abasps*, in which the left fore wing was much bleached, taken in August last, near Carnforth. Mr. Adkin also exhibited a series of *Aeropycta ruficornis* from Co. Cork, Ireland, including light and black forms, with examples from the Scilly Isles, Isle of Man, and North of Scotland for comparison.—Mr. Elwes exhibited a series of *Chionosha Alberta* ♀♀, *Chionosha ulteri*, var. *varona*, and *Erebia discoloris*, from Calgary, Alberta, N.W. Canada, which had been collected in May last, by Mr. Woodley-Dod. He said that the validity of *C. Alberta*, which had been questioned by Mr. W. H. Edwards, was fully established by these specimens.—Prof. E. B. Poulton, F.R.S., gave an account of the changes which he had recently made at Oxford in the arrangement of the Hope Collections in the Department of Zoology, and as to the rooms now available for students working at these collections.—Mr. G. T. Bethune-Baker commented a paper, entitled "Descriptions of the Pyralidae, Graminide, and Phycide, collected by the late T. Vernon-Wollaston in Madeira."

### PARIS.

Academy of Sciences, October 23.—M. Lévy in the chair. Experimental verifications of the theory of weirs, with either a liquid or partly submerged water-sheet, with regard to the pressures, by M. J. Bismespe.—On the existence in plants of pines capable of condensation with production of carbonic acid, by MM. Berthelot and G. Andrieu. Plant-leaves were

dried at 110°, reduced to powder, and then heated on an oil-bath, at 120°-130°, with 12 per cent. hydrochloric acid. The work was carried out in an atmosphere of hydrogen. It resulted in a slow evolution of carbon dioxide. This may be accounted for on the hypothesis that the contained carbohydrates have a ketonic constitution. Experiments on the simple carbohydrates are in progress.—On the movements which certain animals make in order to fall on their feet, when precipitated from a height, by M. Marey. Successive instantaneous photographs, taken in two planes, are given of a cat in the act of falling. The necessary movements are accomplished by the animal rotating the forepart of its body when drawn in, so that its moment of inertia is small as compared with that of the extended hind-quarters, and by this movement being repeated by the latter when drawn in and the fore-part extended.—A note concerning the above communication, by M. Guyon. It is shown that the rotation of the animal is not contrary to received laws.—Observations on the principle of areas, by M. Maurice Lévy.—Reduction of the equation of continuity in hydraulics to the form  $\frac{dp}{dt} + v_1 \frac{dp}{ds} + \rho \frac{dv_1}{ds} - 2\rho v_1 \frac{v_1^2}{ds} = 0$ . An abstract of a memoir

by M. P. E. Touche.—The first volume of a work by M. G. Hinrichs, "On the Mechanics of Atoms," gives a discussion of atomic weights and methods used in their determination, and treats of the question of the unity of matter.—On the problems of dynamics of which the differential equations admit a continuous group, by M. P. Staeckel.—On the differentiation of trigonometric series, by M. Matyas Lerch.—On the constitution of the electric arc, by M. L. Thomas. The arc between two carbons containing metallic salts consists of a nucleus surrounded by an envelope; in the former are found the substances giving band spectra, hydrocarbons or carbon vapour and cyanogen, in the envelope metallic vapours from the dissociated salts pass from the positive to the negative pole, and there burn in the oxygen of the air, producing the metallic line spectra characteristic of this region.—Relation between the maximum vapour pressures of water, ice, and a saline solution at the freezing-point of this solution, by M. A. Ponsot.—On the gaseous products given off by wood charcoal when heated to a high temperature out of contact of air, by M. Dosmond.—On the transformation temperatures of irons and steels, by M. Georges Charpy.—Kermésite, by M. H. Baubigny.—On the superposition of optical effects of several asymmetric carbon atoms in the same active molecule, by MM. Ph. A. Guye and M. Gautier. In a molecule containing several asymmetric carbon atoms, each of them acts as if all the remainder of the molecule were inactive. The optical effects of several asymmetric carbon atoms in the same molecule are algebraically added to give the optical activity of the molecule.—On the saturated hydrocarbons with active amyl radicals, by Mlle. Ida Welt.—On the estimation of alcohol in essential oils, by MM. Charles Fabre, Garrigou, and Surre.—On the existence of *cellules en paniers* in the *acinus* and excretory conduits of the mammary gland, by M. E. Lacroix.—Observations on a bacille by MM. Prillieux and Delacroix.—On the *gommeuse hillaire* of vines, by M. L. Daille.—Culture of a fungus (*Collybia velutipes*) growing on wool, by MM. Costantin and Matruchot.—On the disease "Rouge" in the Paris nurseries and plantations, by M. Louis Mangin.—On the relations of the basalt and phonolite of the Sac d'Arnales (Haute-Loire), by M. Ferdinand Gonnard.—On the geology of French Congo, by M. Maurice Barat.—On several quaternary grottos of the Dordogne, and on some megalithic monuments of Orne and La Manche, by M. Lmile Rivière.

NEW SOUTH WALES.

Royal Society, June 6.—C. Moore in the chair.—The following papers were read:—Notes on some minerals and mineral localities in the northern districts of New South Wales, by D. A. Porter.—On the magnetic susceptibilities of specimens of Australian basalts, by Prof. A. W. Rucker, F.R.S.—On boleite, nantokite, kerargyrite, and cuprite, from Broken Hill, by Prof. Liversidge, F.R.S.—From number to quaternon, by C. Fleuri.—New orbit of the double star  $\beta$  416 = Scorpius 185, by Prof. S. Glasenapp.—On the value of gravity at the Sydney Observatory, by E. F. J. Love.—Preliminary notes on the pharmacology of *carissa ovata*, var. *stolonifera*, Bail, by Dr. T. L. Bancroft.—On the almandine garnets from the Hawkesbury sandstone at Sydney, by H. G. Smith.—On a natural mineral spring at Bungonia, by Rev. J. Milne Curran.

July 4.—Prof. Threlfall, President, in the chair.—The fol-

lowing papers were read:—On a transparent star-chart: a convenience for observers, by H. C. Russell, F.R.S.—Aboriginal Bora held at Gundabloui in 1894, by R. H. Mathews.—Observations and orbit elements of comet Gale 1894, by John Tebbutt.—On the structure and composition of some Australian basalts, by Rev. J. Milne Curran.

August 1.—Prof. Threlfall, President, in the chair.—The following papers were read:—On garbage destructors, by Prof. Warren and Dr. Ashburn Thompson.—The geology of limekilns, Bathurst district, by W. J. C. Koss.—The territorial divisions of New South Wales into counties, by W. D. Campbell.—On the timbers of New South Wales, by J. V. De Coque.—On the Aboriginal rock carvings and paintings in New South Wales, by R. H. Mathews.—The Society's bronze medal and money prize of £25 were presented to each of the two last-named gentlemen for their papers.

September 5.—Prof. Threlfall, President in the chair.—The following papers were read:—Some stone implements used by the Aborigines of New South Wales, by R. H. Mathews.—Recent researches in the testing of cement, by W. S. de Lisle Roberts.—A comparison of the languages of Ponape and Hawaii, by the late Rev. E. T. Doane, with additional notes and illustrations by Sidney H. Ray.—Preliminary note on the structure of gold nuggets, by Prof. Liversidge, F.R.S. Gold nuggets on being cut through or sliced and polished, and then etched by chlorine water, were found to exhibit well-marked crystalline structure closely resembling the Widmanstätt figures shown by most metallic meteorites, except that in the nuggets the crystals are more or less square in section and show faces which evidently belong to the octahedron and cube. On heating the nuggets in a bunsen burner, blebs or blisters form, on both the polished and unpolished surfaces, and on still more strongly heating, these, in some cases, burst with sharp reports, and pieces of gold are projected with considerable violence. As no explosions have been observed on dissolving or eating away the crusts of these blisters by chlorine water, it would appear that the blebs are probably due to the vaporisation of some liquid or solid substance. As soon as a fresh supply of nuggets is obtained, experiments will be proceeded with to ascertain definitely whether gold nuggets contain occluded gases, or liquids or solids which are vaporisable. In slicing some nuggets, scattered granules of quartz were met with inside, although quite invisible outside, and at first it was thought that the explosions might be due to the quartz; but the gas, in some cases, continued to issue from the burst bleb (where the aperture formed was small) and forced the bunsen flame out into lateral jets, just as if urged by a blow-pipe.

Linnean Society, September 26.—Prof. David, President, in the chair.—On the correct habitat of *Patella hermanni*, Pilsbry (= *P. Pilsbryi*, Braz.), by John Brazier. The author expressed the opinion that this is the species referred to in Mr. Percy Smith's pamphlet, "The Keradec Islands: their Capabilities and Extent" (Wellington, 1887), which states that on Macauley Island there occur "large limpets (as big as small saucers, and good eating)."—On a *Trochus* from Port Jackson, and new varieties of *Tridacna mitchellii*, Reeve, from the Solomon Islands, by John Brazier. Under the name of *T. obscurus*, n. sp., was re-described a Port Jackson mollusc, the original specific name of which, *T. cupus*, A. A. B. is preoccupied for a species named by Philipp. D. Fischer also combined *T. conglus*, A. A. B., with the New Caledonian *T. Bourneii*, Montr., which is a distinct species. Three new varieties of *Tridacna mitchellii*, Reeve, were also described.—Observations on *Dendroica tenuitarsis*, De Vis, by Edgar K. Waite. The author described the species from material recently obtained from the Bloomfield River, Queensland. He was of opinion that in respect of both external and anatomical characters it is a well-marked species.

AMSTERDAM.

Royal Academy of Sciences, September 29.—I. Hof. Vande Sandt Bakhuizen in the chair.—Mr. Beyerinck discussed the reduction of sulphates by a specific sulphide ferment. This subject bears on two questions of general bacteriology, i.e. (1) the production of sulphuretted hydrogen, and (2) the power of reduction. Bacteria may produce H<sub>2</sub>S in four different ways: Firstly, from sulphur, this being dissolved, by the excretion of ammonia, amines or alkaloids forming sulphides, which are decomposed by carbonic acid; secondly, from proteids containing sulphur, well known in cases of putrefaction; thirdly,

... sulphates and sulphur. The latter of these substances being decomposed into sulphuric acid and sulphur, and the sulphites acted on as in the first case:—fourthly, by the reduction of sulphates. From the common reducing bacteria which turn nitrates into nitrites, and those into ammonia salts, which produce from limas, indigo, litmus, methylen-blue, &c., the corresponding leucides, none has the power to attack sulphates. This is done by a specific ferment, a very small spirillum, which is perfectly anaerobic, and which is common in the black mud of polluted waters, as also in these waters themselves. It grows with very small quantities of organic nutriment, as malates, peptone, sugar, and phosphates added to common water, rendered alkaline by sodium carbonate. Temperatures from 25 to 50° are the best for its action. For the determination of the H<sub>2</sub>S the iodometric method can be used. Common water with the addition of 2 per cent. sodium malate, 1 per cent. a-paragin, 1 per cent. potassium phosphate, and 1 per cent. sodium carbonate, infected with mud containing the ferment, and secluded from the air, and with forty-five milligrammes SO<sub>2</sub> per litre, was in three days quite free from this substance, containing nearly 10·2 milligr. H<sub>2</sub>S, the cause of the deficit twenty-one milligr. SO<sub>2</sub> not transformed into H<sub>2</sub>S being not yet quite clear. Mohr's salt (ferrous ammonium sulphate) is very well adapted for reduction experiments, the smallest trace of reduction being indicated by the formation of black FeS. The spirillum has been named *Spirillum d'indigo*. It seems to be of geological importance, inasmuch as the deep ground water of the province of South Holland is quite free from sulphuric acid, which, being abundant on the surface, is apparently reduced by the sulphite ferment, and rendered insoluble as FeS and FeS<sub>2</sub>. — On Kerr's magneto-optic phenomenon, by C. H. Wind. The author supposes that, in a metal placed in a magnetic field, both the conduction and the displacement current give rise to a Zeeman effect, the intensity coefficient being different in the two cases. In this way the discrepancy, which exists between the experimental results, and the theory of Lorentz and Van Loeghem, may be removed. — Prof. Kamerlingh Onnes read a memoir, in which Dr. Kaenen gave a graphical representation of the condensation of a mixture of two substances with  $\pi$  and  $\tau$  taken as co-ordinates. His conclusions are contradictory to those of Duhem, but in accordance with the theory of Van der Waals and his own experiments. All mixtures of two substances must show retrograde condensation. — Prof. Onnes also communicated the results of an investigation, by Dr. Bogesius, on the molecular refraction and dispersion of some salts in solution, made with an inferential refractometer especially constructed for this purpose, and giving the small differences of refraction of two fluids by a single reading of verniers and counting of stric.

BOOKS, PAMPHLETS, and SERIALS RECEIVED.

...  
The first volume of the 'Annals of the Entomological Society of America' has been published. It is edited by W. H. Cresson and W. J. Rehn. The volume contains a list of members of the society for 1894, and a list of names of members who have died since the publication of the last volume. It also contains a list of names of members who have been elected to the society since the publication of the last volume. The volume is published by the American Entomological Society, and is sold by the publishers, W. H. Cresson and W. J. Rehn, at the price of \$1.00 per volume. The volume is a valuable addition to the literature of entomology, and is highly recommended to all those who are interested in the study of insects.

...  
The first volume of the 'Annals of the Entomological Society of America' has been published. It is edited by W. H. Cresson and W. J. Rehn. The volume contains a list of members of the society for 1894, and a list of names of members who have died since the publication of the last volume. It also contains a list of names of members who have been elected to the society since the publication of the last volume. The volume is published by the American Entomological Society, and is sold by the publishers, W. H. Cresson and W. J. Rehn, at the price of \$1.00 per volume. The volume is a valuable addition to the literature of entomology, and is highly recommended to all those who are interested in the study of insects.

CONTENTS.

PAGE

Ancient Meteorology. By W. E. P. . . . .	25
Two Books on American Antiquities . . . . .	26
Watts' Dictionary of Chemistry . . . . .	27
Diseases of Trees. By Prof. W. R. Fisher . . . . .	28
Our Book Shelf:—	
Brunache: "Le Centre de l'Afrique. Autour du Tchad" . . . . .	29
A Foreman Pattern Maker: "Helical Gears." N. J. L. . . . .	30
Dixon: "The Nests and Eggs of Non-Indigenous British Birds" . . . . .	30
Gonner: "Commercial Geography" . . . . .	30
Fletcher: "Dynamometers and the Measurement of Power."—G. . . . .	30
Gay: "Electric Light and Power" . . . . .	30
Letters to the Editor:—	
Prof. Boltzmann and the Kinetic Theory of Gases.— G. H. Bryan . . . . .	31
Instinctive Attitudes. ( <i>Illustrated</i> ).— S. S. Buckman James Parkinson, the Author of "Organic Remains of a Former World."—Spencer George Percival . . . . .	31
On Chinese Beliefs about the North.—Kumagusu Minakata . . . . .	32
The Planting of Timber Trees.—Alfred W. Bennett <i>Synchodema terrestri</i> in England.—F. W. Gamble . . . . .	33
Tan-Spots over Dogs' Eyes.—J. Shaw . . . . .	33
A Criticism of the Astronomical Theory of the Ice Age. By Edward P. Culverwell . . . . .	33
Notes ( <i>Illustrated</i> ). . . . .	35
Our Astronomical Column:—	
A Comet on the Eclipse Photographs of 1893 . . . . .	40
The Transit of Mercury . . . . .	40
Mira Ceti . . . . .	40
Return of Encke's Comet . . . . .	40
Two Variable Stars . . . . .	40
Observations of Mars	
The Electric Conductivity of Pure Water. By J. W. Rodger . . . . .	42
Neo-Vitalism. By Frances A. Welby . . . . .	43
Science in the Magazines . . . . .	44
University and Educational Intelligence . . . . .	45
Scientific Serials . . . . .	45
Societies and Academies . . . . .	46
Books, Pamphlets, and Serials Received . . . . .	48

THURSDAY, NOVEMBER 15, 1894.

## HISTORICAL EXPOSITION OF MECHANICS.

*The Science of Mechanics: a Critical and Historical Exposition of its Principles.* By Dr. Ernst Mach, Professor of Physics in the University of Prague. Translated from the second German edition by Thomas J. McCormack. (Chicago: The Open Court Publishing Co. London: Watts and Co., 1893.)

THE appearance of a translation into English of this remarkable book should serve to revivify in this country the somewhat stagnating treatment of its subject, and should call up the thoughts which puzzle us when we think of them, and that is not sufficiently often.

Prof. Mach is a striking instance of the combination of great mathematical knowledge with experimental skill, as exemplified not only by the elegant illustrations of mechanical principles which abound in this treatise, but also from his brilliant experiments on the photography of bullets, which have been recently elaborated and simplified by Mr. C. V. Boys.

The appearance of the first edition, in 1883, is stated in the preface of the second edition, to have stimulated the production of treatises by Wohlwill, Streintz, Lang e, Epstein, Müller, Popper, Helm, Planck, Poske, and others, discussing theories of cognition in connection with Mechanics; but it is curious that Maxwell's little tract on "Matter and Motion," of 1879, a veritable master-piece on this subject, should appear to be unknown to the author, although mentioned in the translator's foot-notes.

The present volume is not a treatise upon the application of the principles of mechanics, to quote from the preface. Its aim is to clear up ideas, expose the real significance of the matter, and get rid of metaphysical obscurities. Mechanics is treated not as a branch of mathematics, but as one of the physical sciences; and the reader's interest is invited to know how the principles of mechanics have been ascertained, from what sources they take their origin, and to what extent they may be regarded as permanent acquisitions. All this, the positive and physical essence of mechanics, which makes its chief and high interest for a student of nature, is in existing treatises completely buried and concealed beneath a mass of technical considerations.

The gist and kernel of mechanical ideas has in almost every case grown up in the investigation of very simple and special cases of mechanical processes; and the analysis of the history of the discussions concerning these cases must ever remain the method at once the most effective and the most natural for laying this gist and kernel bare. Indeed, it is not too much to say that it is the only way in which a real comprehension of the general upshot of mechanics is to be attained.

Acting upon the plan laid down in the citations above, the author treats his subject from the historical order of development, and begins with an Introduction of general remarks, illustrated by an Egyptian representation of the mechanical arts, and by a quotation from Vitruvius.

Chapter i., on the Development of the Principles of Statics and Hydrostatics, follows closely the historical

subject-matter given by Lagrange in the first section of his "Mécanique analytique"; but Prof. Mach's treatment has the very great superiority of being profusely illustrated by elegant diagrams, while Lagrange made a point of banishing figures entirely from the "Mécanique analytique."

Lagrange thus appears as a supporter of the ancient tradition that Rational and Practical Mechanics were to be considered as in a measure opposed to each other, as Newton observes in his preface of the "Principia"; the latter being an inferior branch of study, to be cultivated only for the sake of gain or some other material advantage.

To quote from Rankine's Preliminary Dissertation, prefixed to his "Applied Mechanics":—

"Archytas of Tarentum might illustrate the truths of Geometry by mechanical contrivances; his methods were regarded by his pupil Plato as a lowering of the dignity of science. Archimedes, to the character of the first geometer and arithmetician of his day, might add that of the first mechanician and physicist—he might, by his unaided strength acting through suitable machinery, move a loaded ship on dry land—he might contrive and execute deadly engines of war, of which even the Roman soldiers stood in dread—he might, with an art afterwards regarded as fabulous till it was revived by Buffon, burn fleets with the concentrated sunbeams; but that mechanical knowledge and that practical skill, which in our eyes render that great man so illustrious, were by men of learning, his contemporaries and successors, regarded as accomplishments of an inferior order, to which the philosopher, from the height of geometrical abstraction, condescended with a view to the service of the State."

We have only to study the progress of the essentially modern science of Electricity to recognise the eloquent truth of Rankine's words, in inveighing against the mediæval and ancient fallacy that there is a *double system of natural laws*, one theoretical, geometrical, rational, discoverable by contemplation, applicable to celestial, æthereal, indestructible bodies, and being an object of the noble and liberal arts; the other practical, mechanical, empirical, discoverable by experience, applicable to terrestrial, gross, destructible bodies, and being an object of what were once called the vulgar and sordid arts.

Possessed with these prejudices, the scholar of ancient and mediæval times, and even of the present day, was occupied in developing and magnifying the numerous errors, and in perverting and obscuring the much more numerous truths which are to be found in the writings of Aristotle; so that it is not surprising that the notion arose of scientific men being unfit for the business of life, and that various facetious anecdotes were contrived illustrative of this notion, anecdotes which have been handed down from age to age, and applied with little variation to the eminent philosophers of every time.

Returning to chapter i. of Prof. Mach's treatise, we find that the Principle of the Lever, employed in the writings of Archimedes, is the real foundation of the Science of Statics, and not the Parallelogram of Forces, as is generally taught; this theorem, although sketched out by Stevinus of Bruges, was first fully enunciated by Varignon and Newton, about 1687. In fact, the modern treatment of Statics is almost entirely due to Varignon.

Prof. Mach examines with the acumen of a meta-

physician the weak points of a demonstration: it is a pity then that he seems unacquainted with Duchayla's proof of the Parallelogram of Forces, which is unfortunately so popular with writers on mechanics in this country, as he would have revelled in pointing out the weakness of a logic which prides itself above all things on its rigour.

The Principle of Virtual Velocities, employed as fundamental by Lagrange in his "Mécanique analytique" in preference to the principle of the Parallelogram of Forces, was enunciated very clearly by Stevinus in its application to systems of pulleys; and here we are compelled to call attention to a flaw in Fig. 39, c, the only one that we have met in the course of the work; the system cannot possibly be in equilibrium with the central portion of the thread askew, as drawn in the diagram.

The Principle of Virtual Velocities is important in the historical development of Mechanics as the first sketch and shadowing forth of the modern Principle of the Conservation of Energy; but it is unfortunate that the name should still survive, as it is confusing and meaningless. Prof. Mittag Leffler was eloquent at the meeting of the British Association at Oxford in his denunciation of the habit of attaching to theorems certain names of individuals, real or quasi discoverers; and he might have quoted the Principle of Virtual Velocities as an instance of the disadvantage of inventing a descriptive title of too great generality to a newly discovered theorem.

Lagrange has attempted an experimental verification of the Principle of Virtual Velocities, and it is a tradition that an apparatus was constructed on these indications by a former professor of mathematics at Cambridge. It is probable that the description of this demonstration and of the apparatus to be found in Todhunter's *Analytical Statics* was purposely ironical; and that, in popular language, Todhunter wrote this with his tongue in his cheek, knowing the story of the sceptical student who had tried the experiment himself.

The demonstration amounts to proving that a certain weight is no more likely to rise than to fall, and therefore there Todhunter says he follows Lagrange's words very closely, the weight should remain stationary. The student, however, found that the weight did not remain stationary, and wanted to know why; the professor told him in confidence that it was prudent to make use of an invisible pin to keep the weight in order.

This is not the only case in which it is desirable for the professor to keep a card up his sleeve, as the saying is: in the Foucault experiment of the pendulum which shows the rotation of the Earth, the slightest current of air will destroy and reverse the desired motion; so that it is advisable in showing the experiment to have an elastic ball concealed in the palm of the hand, which can send a slight current of air on the bob of the pendulum, and thus accelerate the initial precession of the plane of the vibration so as to gratify the eyes of the audience and diminish their impatience at the slowness of the motion; afterwards the motion can be checked so that the total advance is made to agree with the theoretical result. Very indignant and dishonest, some will say; but the experiment is otherwise bound to fail from its delicacy when shown to a large audience, except under the most favourable conditions.

While Statics, both as a Science and an Art, can be traced back through Archimedes and the existing monuments of the Egyptians, Greeks, Romans, and of mediæval architects, the Principles of Dynamics, discussed in chapter ii., were first laid down clearly by Galileo; and the great fallacy to be destroyed before any real advance could be made was that of the Aristotelians, who maintained that heavy bodies fall faster than light ones, because the upper parts weigh down on the under parts and accelerate their descent. But in that case, retorted Galileo, a small body tied to a larger body, must, if it possesses *in se* the property of less rapid descent, retard the larger; *ergo* a larger body falls more slowly than a smaller body.

The entire fundamental assumption is wrong, as Galileo says, because one portion of a falling body cannot by its weight under any circumstances press another portion; although, according to Wöhlwill (Appendix I.), even Galileo himself only very gradually abandoned the Aristotelian conceptions.

But discarding all metaphysical argument, the Aristotelian fallacy was demolished once for all by the *experimentum crucis* carried out by Galileo, of letting bodies of different weight fall from the Leaning Tower of Pisa, when all were found to take the same time of descent; any slight discrepancies were afterwards accounted for by the resistance of the air.

A still more delicate experimental verification is to be found in the pendulum, as pointed out by Galileo; a plummet at the end of a thread has the same period of oscillation whatever be the weight or the material of the plummet.

The theory of the pendulum, when composed of a body of finite size, as required in a clock, was completed by Huygens in his *Horologium oscillatorium*, 1673, in which the mutual controlling influence of a number of separate plummets is investigated when the plummets are rigidly attached together; and thus for the first time the idea of a moment of inertia and of a centre of oscillation was introduced into Mechanics. In his further researches into the theory of the clock, Huygens was led to the discovery that isochronism for all amplitudes can be secured by making the plummet oscillate in a cycloid; and to do this practically he found that the thread must wrap and unwrap on an equal cycloid, and thereby he made the first step in the doctrine of evolutes and the theory of the circle of curvature.

Having demolished the Aristotelian fallacies on falling bodies, Galileo had still to determine the true laws; his first conjecture that the velocity grew uniformly with the distance, or that  $v = gt$ , having proved untenable, Galileo stumbled upon the true law that the velocity grows at a constant rate, or that  $v = g\sqrt{t}$ .

The next step in the theory, to prove that in consequence  $s = \frac{1}{2}gt^2$ , was not an easy matter for Galileo, who sought in general an experimental proof of his theorems (as, for instance, his attempted quadrature of the cycloid by weighing it made in sheet lead); once this was established, however, it was comparatively an easy matter to demonstrate that the path of an unresisted projectile is a parabola, and to prove it experimentally by rolling a ball obliquely on an inclined table.

Galileo's difficulty was to measure lapse of time with



exactitude, accurate clocks and watches not being in existence in his day; but he overcame this difficulty by a modification of his own invention of the ancient Clepsydra.

The laws of circular motion were next investigated by Huygens; and a combination of these laws with Kepler's Third Law, on the assumption that the planetary orbits round the Sun are circles, leads at once to the Law of Attraction varying inversely as the square of the distance.

This law, generalised into the Law of Universal Gravitation, became in Newton's powerful hands the foundation of his system of Natural Philosophy, in explaining not only the elliptic orbits of the planets in accordance with Kepler's first two Laws, but also the perturbations of these orbits as exemplified in the Lunar Theory, and the Theory of the Tides.

Prof. Mach suggests in Fig. 139 a very ingenious experimental illustration of the tides on a body in free space, like the Earth, as distinguished from the tides which would be produced if the Earth was fixed, by means of a small iron sphere covered with a solution of magnetic sulphate of iron; this can either revolve as the bob of a conical pendulum in true planetary style round the pole of a fixed magnet, representing the disturbing Sun or Moon; or it can hang suspended at rest at a small distance from the pole, and thus illustrate high water under the disturbing Sun or Moon, and low water at the antipodes when the Earth is supposed fixed. The discrimination of the two cases must be considered one of the most brilliant parts of the "Principia."

It is curious that Prof. Mach does not accept Newton's distinction between the relativity of motion of translation and the absoluteness of motion of rotation, illustrated experimentally by Newton by means of a revolving bucket of water suspended by a twisted rope ("Principia," Definition VIII. *Scholium*); and here we think he would have been interested in Maxwell's arguments on Rotation in § 104, *Matter and Motion*.

Maxwell proceeds to explain that it is possible, by means of observation and experiment on or inside the Earth alone (by Foucault's pendulum, for instance), to disprove Milton's assumption, that it is evidently all the same

"Whether the sun, predominant in heaven,  
Rise on the earth, or earth rise on the sun;  
He from the east his flaming road begin,  
Or she from west her silent course advance;"

&c., although the geometrical configuration of the earth and the heavenly bodies, so far as is discoverable by astronomical observation, is the same on either assumption.

In the Translator's Preface we are told that "Mr. C. S. Pierce has rewritten § 8 in the chapter on Units and Measures, where the original was inapplicable in this country (America) and slightly out of date."

As might be anticipated, this means that we are now to change the name of the quantity formerly designated by the word *weight*, *poids*, *gewicht*, *poundus*, and to use the word *mass* instead.

But if a continental mathematician, Prof. Mach included, is asked to give a numerical definition of the

mass of a body, he replies, if in French, "poids divisé par *g*"; so that if a body weighs *p* kilogrammes, its mass is  $\frac{p}{g}$ , and the unit of mass is thus *g* kilogrammes.

When the gravitation unit of force was in universal use, it was considered an abbreviation to write *m* for  $\frac{p}{g}$ , and to replace the gravitation measures of momentum and energy,  $\frac{pv}{g}$  and  $\frac{pv^2}{2g}$ , by *mv* and  $\frac{1}{2}mv^2$ .

But when Gauss's absolute unit of force is employed, the absolute measures of momentum and energy are *pv* and  $\frac{1}{2}pv^2$ , and the abbreviation of *m* for  $\frac{p}{g}$  is no longer required; or if the letter *m* is employed, then *p* = *m* and not *mg*, as Mr. Pierce asserts; if the mass of a body is 10 kilogrammes, its weight in kg cannot be anything except 10 kilogrammes.

But if with absolute measures we retain the equation *p* = *mg*, and measure *m* in kilogrammes, then *p*, the *weight* or *poids*, is measured in one-gth parts of a kilogramme; this is contrary to all practice, and is absolutely forbidden by the laws on *Weights and Measures*.

With gravitation units the *weight* of a body is at once the numerical measure of the quantity of matter in the body (Newton's *quantitas materiae*) and of its gravitation, or the force with which it tends to the Earth; if a body weighs *p* kilogrammes, it is attracted by the Earth with a force of *p* kilogrammes. The loose definition usually given that "the weight of a body is the force with which it is attracted by the Earth," is really no definition at all, but a mere description; it should at least be amended to "the weight of a body is the *number of units of force* with which the body is attracted by the Earth"; and it will be found that this definition is never employed except with the gravitation unit of force; so that this definition merely asserts in a roundabout way that the weight of a body is a measure of the quantity of matter, as measured out by weighing against pound or kilogramme weights.

It is incorrect to say that there are two systems of *measurement*, the *absolute* and the *gravitational* (p. 284). There is no practical method for the measurement of forces in absolute measure with any pretence to accuracy; the absolute system is merely a system for recording numerically the results of experiment; the measurements themselves are always made in gravitation measure, and afterwards converted into absolute measure by multiplying by the local value of *g*. There is thus no need for absolute units with our insular British F.P.S. (foot-pound-second) system; and Prof. James Thomson's *poundal*, although a convenient name, is of no practical or theoretical use.

In experiments at Washington, the Paris gravitation unit would not be employed, so that the statements on p. 286 do not tend to clear up the subject. What appears to be meant is that if a perfect spring balance could be constructed such that a kilogramme deflected it at Paris through 981 divisions, then when carried to Washington the deflection would fall to 980.1 divisions, and if carried to the Moon to about 164 divisions, but if carried to the surface of the Sun the deflection would rise to about 30,000 divisions, provided Newton's "Law of Universal

Gravitation" is correct; but the kilogramme weight remains the same throughout the universe.

But if a balance could be constructed with its fulcrum somewhere in the Azores, and the scale pans hanging over Paris and Washington, then 1 kilogramme at Paris would equilibrate 1.00092 kilogramme at Washington (p. 286).

It is sometimes asserted in our school-books on Mechanics that a pound weight, if carried to the surface of the Sun, would weigh about 30 pounds; but if a balance could be made to stretch between the surfaces of the Earth and of the Sun, then a pound weight at the Sun's end would be equilibrated by 30 pounds at our end; so that it is equally true to say that a pound weight on the Sun will weigh 30 pounds on the Earth.

Prof. Mach would perform a great service if he would extend his criticisms on the usage of the word *pondus* by Huygens, Leibnitz, Wallis, &c., to modern times, as great mystifications exist at the present day.

The C.G.S. system of units is explained by Mr. Pierce on p. 285. These units are much too minute except for recording delicate physical measurement. If Prof. Johnstone Stoney's amendment of the M.K.S. (metre-kilogramme-second) system had been adopted, we should have a system incorporating the joule, watt, volt, ohm, and ampere as units; it is not too late to make the change: the disadvantage that the density of water is 1000 in this system is more apparent than real.

Although the double system of natural laws mentioned by Rankine is now exploded, we still have a double system of instruction in mechanical text-books, one theoretical, geometrical, rational; the other practical, mechanical, empirical, discoverable by experience. It should be the object of modern science to break down the barriers between these two systems, and to treat the subject of mechanics from one point of view. Instead of this, the gap between the two systems seems to be an increasing one, inasmuch that Prof. A. B. W. Kennedy, in his inaugural address to Section G of the British Association at Oxford, demanded for young engineers a course of instruction in mathematics entirely different to that imparted at present in our schools and colleges.

Some remarks at the end of Prof. Klein's Sixth "Evanston Colloquium" may be consulted as bearing on this question.

A careful study of Prof. Mach's work, and a treatment with more experimental illustration, on the lines laid down in the interesting diagrams of his *Science of Mechanics*, will do much to revivify theoretical Mechanical Science, as developed from the elements by rigorous logical treatment.

A. G. GREENHILL.

#### NEWTON'S INORGANIC CHEMISTRY.

*A Text-book of Inorganic Chemistry.* By G. S. Newton, F.R.S., F.C.S. Pp. xiii, 697. London: Longmans, Green, and Co., 1894.

THE author states in the preface, that the arrangement of the course of elementary instruction in chemistry, which is given in this book, is based on the periodic classification of the elements. The properties of four elements, *hydrogen, oxygen, nitrogen, and carbon*, and the properties of many compounds of these elements,

are considered before the systematic study is entered on, of the groups into which the elements are divided by the application of the periodic law. Then follow chapters wherein the members of the various groups of elements, and the chief compounds of these elements, are described. To this descriptive part of the book are prefixed fifteen chapters of "introductory outlines," constituting "a brief sketch of the fundamental principles and theories upon which the science of modern chemistry is built." In his directions to students using the book, the author says that a start should be made by reading carefully the chapters dealing with chemical change, elements and compounds, nomenclature, and symbols; that the four typical elements—hydrogen, oxygen, nitrogen, and carbon—should then be studied; and that, as this study is proceeding, the remaining chapters of the "introductory outlines" should be mastered.

It seems to me that the method of the author is radically wrong. Descriptive statements of facts ought, surely, neither to precede, nor to follow, but to accompany, the reasoning on these facts whereby general principles are gained.

The author's treatment of chemistry implies that "the science of modern chemistry is built" on the foundation of such generalisations as those stated in his "introductory outlines," and that detailed descriptions of the properties of certain kinds of matter called elements and compounds constitute the science that is raised on this foundation. Would it not be more advisable so to treat the subject as to show that chemistry rests on certain definite natural facts, but that only when these facts are compared, contrasted, and classified, does a scientific knowledge of them begin?

The descriptions in this book of the members of each group of elements seem to me to be exceedingly well done; many portions of the chapters treating of principles and theories, notably the pages which deal with the laws of chemical combination, are admirable; nevertheless the book, as a whole, gives the impression of being unscientific. The method of the book tends, in my opinion, to perpetuate the vicious and unreal distinction between chemistry and chemical philosophy, a distinction that has probably been as potent as any other cause in stopping the progress of the science.

The purely descriptive portions of this work are often extremely good, as far as they go. The facts, or rather half-facts, are stated in a clear and orderly way; care is taken to notice recent work of importance; the woodcuts are well executed; but, all this is only the material out of which chemistry is constructed.

About 130 pages are devoted to statements of the properties of four typical elements—hydrogen, oxygen, nitrogen, and carbon—and of the properties of many compounds of these elements. But hydrogen, oxygen, nitrogen, and carbon are not treated as typical elements—they are not compared and contrasted with other elements. After reading the descriptions of these elements and their compounds, and studying the properties of the elements in each of the eight groups of the periodic classification, one still feels unsatisfied. Something is lacking. Surely some fair and fittingly fashioned building ought to rise on this broad superstructure. If chemistry is to be treated as a recitation of disconnected, or arti-

cially connected, facts, it ceases to be a subject worthy the serious attention of educated men. One turns to a new book on elementary chemistry, hoping to find at least an attempt to rescue chemistry from the overwhelming burden of so-called facts, beneath which the science is in danger of being buried. In this case I confess to disappointment. It may be replied that the chemistry which is not clearly apparent in the purely descriptive parts of the book is to be found in the "introductory outlines" wherein the "fundamental principles and theories" of the science are stated. I admit at once that there is much excellent matter in these earlier chapters; but I do not find there a connected setting forth of elementary principles, as arising from facts, and binding facts into some kind of harmonious whole. There is not much either exact or imaginative treatment; and these two I take to be the notes of genuine science.

The perusal of this book produces in one's mind a strange feeling of inversion; many things seem to be standing on their heads. The reader feels that a rapid mental rotation, to right or left, is demanded. Change is very properly said to be the feature of all chemical occurrences; but at a very early stage (p. 5), after two pages have been occupied in lightly touching the subject of the constitution of matter, the student is told that "Any change which arises from an alteration in the structure of the molecule is a chemical change." This is an example of the topsy-turviness of parts of the book. The statement quoted has a meaning when the meaning of such a very symbolical expression as "structure of the molecule" has been adequately grasped. At this stage of progress the student cannot have any clear image called up in his mind by the words I have quoted; they must be merely words to him. But he might have grasped the prominent and characteristic features of chemical change had these been put before him by well-chosen experiments. Another instance, to my thinking a glaring instance, of putting theory where facts should come, and facts where theory, is found in chapter ii., which deals with elements and compounds. The distinction between these classes of substances is stated at once, and is stated only, in the language of atoms and molecules.

"In the substance sulphur, all the atoms composing the molecules are alike; while in water . . . there are two distinct kinds of atoms in the molecule. Matter, therefore, is divided into two classes, according as to whether its molecules are composed of similar or of dissimilar atoms. Molecules consisting of atoms of the same kind are termed *elementary molecules*, and substances whose molecules are so constituted are known as elements."

The chapter which deals, and deals in a clear and most praiseworthy style, with the laws of chemical combination, is headed "The Atomic Theory." I think the author must have taken his own words too literally (p. 29):

"Dalton embraced the ancient doctrine of atoms, and extended it into the scientific theory which is to-day known as Dalton's atomic theory, and is accepted as a *fundamental creed* by modern chemists." (The italics are mine.)

A "scientific theory" and a "fundamental creed" are very different things.

For his descriptive treatment of the materials from which chemistry is built up, I think the author is to be praised; but I do not think he has succeeded in setting forth the principles of the science of chemistry clearly, adequately, or in fitting order.

M. M. PATTISON MUIR.

#### OUR BOOK SHELF.

*Astronomia Sferica. An Elementary Treatise.* By Francesco Porro. (Roma: Società Editrice Dante Alighieri, 1894.)

IN these 160 pages, the author has endeavoured with success to bring before his readers, in as simple a way as is consistent with the subject, the elements of spherical astronomy. With the exception of a small knowledge of the rudiments of the differential calculus, the mathematical ability is by no means taxed. The order in which the subject-matter has been arranged, and the field which is covered, can be gathered from the following short summary. After dealing first with the sphere generally, and the form and daily motion of the earth, the annual motion round the sun, and the methods of the transformation of coordinates, the measurement of time is next explained, in which Kepler's equation, the equation of time, and the transformation of mean into sidereal time, and *vice versa*, are discussed. Then follows a chapter in which the movements of the moon are clearly expounded.

Diurnal parallax and refraction, the variations of the fundamental planes, aberration and annual parallax, form the subjects for the next three chapters; while the remaining ones are devoted to the determination of the positions of stars and their proper motion, and to the solar system in general. In the last-named, the apparent movements of the planets, the theories of Copernicus and Kepler, the necessary data for the determination of planets' orbits, &c., are touched upon.

From the above it will be seen that the most necessary points for the student have been dealt with, but they have not been treated at too great a length. As an introduction to higher works, this book will be found most useful; but its use in this country will be to a great extent restricted, owing to it being printed in Italian.

*The New Technical Educator.* Vol. iv. (London, Paris, and Melbourne: Cassell and Co., 1894.)

THE previous volumes of this work have been duly noted in our pages. Volume iv. is in every way up to their standard of excellence.

The subject of the manufacture of iron and steel occupies the first part of the volume. The author of this seems to be well acquainted with the practical details. We note that he appears to consider that the presence of but 0.05 per cent. of sulphur in steel is more or less harmful, producing a metal sensibly red-short. This may be the case; but it is generally considered that the percentages of phosphorus, sulphur, or silicon must not each exceed 0.06 per cent., and then their effects may be overlooked in axles, tyres, plates, &c. Engine-tyres are said to give a tensile test of 46 tons per square inch, with a minimum elongation of 20 per cent. in a 3-inch length. These results are rather extreme, with a sectional area of  $\frac{1}{2}$  square inch of test-piece. If the extension exceeds 16 per cent. the result may be considered good with this tonnage.

As in previous volumes, we find much interesting information on cutting tools, from the pen of Prof. R. H. Smith, dealing principally with lathes, drills, and punching and shearing machinery. Different metal shavings are illustrated from photographs, and clearly show the nature of the different metals. The steel shavings shown,

however, are not sufficiently described. Cases are known where shavings from a 2½-inch drill working on cast steel have been obtained many feet in length, the material, of course, being of very excellent quality.

The illustrations of drilling machines are good, but all appear to have the ordinary power feed; in many cases it is found advantageous to have, besides the power feed, a quick hand feed in addition, in conjunction with a power attachment, the quick hand gear being used to withdraw the tool in all cases. These motions are very handy in boiler shops, where the same machine may have to drill rivet-holes out of the solid, rhymer or enlarge punched holes, and finally countersink holes, all requiring different feeds.

The continuation of the steam engine in this volume includes boiler fittings and details, efficiency of the engine and engine and boiler trials, concluding with a chapter on compound engines. The latter parts of these chapters are well written and interesting. The classical work of the late Mr. Willans is largely drawn upon, as well as the trials carried out by the Institution of Mechanical Engineers, besides careful descriptions of other steam-engine trials. The combination of indicator diagrams of compound or triple expansion engines is well explained.

A series of articles on engineering workshop practice is commenced, and they are very good so far as they go, but it may be suggested that engineers' shop appliances as generally used should be described, and not the "elegant amateur tools," such as are illustrated in Figs. 29 and 77. N. J. L.

*Index Kewensis Plantarum Phanerogamarum.* Sumptibus Beati Caroli Roberti Darwin ductu et consilio Josephi D. Hooker, confecti B. Daydon Jackson. Fasciculus iii. Oxoni: E. prelo Clarendoniano, 1894.

THE third fasciculus of the Kew Index, which the Clarendon Press has just issued, brings us within sight of the completion of this monumental work. This part brings the Index down to near the end of the letter P, and we may look forward then to seeing in course of the coming year the concluding fasciculus. Since we noticed the earlier fasciculi there has been no new development in the nomenclature controversy, upon which, we believe, the Kew Index will exercise an important influence; the effect of this will likely be only apparent after the whole is published. Meanwhile the sterling value of the Index is increasingly evident, and every botanist will congratulate the preparers and the publishers upon the appearance of this third fasciculus, in which the same careful and conscientious workmanship is noticeable as characterised the portions of the work previously issued.

*Alpine Climate and Consumption.* By H. J. Hardwicke, M.D. Pp. 65. London: J. and A. Churchill, 1894.

THE high-altitude cure for acquired and hereditary consumption has gained ground in the medical world during recent years, with the result that numerous winter health stations have sprung into existence in Switzerland. Dr. Hardwicke's little brochure has been written for the purpose of providing trustworthy and unbiased information with regard to some of these resorts. It is pointed out that the principal requirements of an Alpine winter climate in the treatment of phthisis are (1) high altitude, (2) low temperature, (3) dry atmosphere, (4) large amount of sunshine and ozone, (5) low atmospheric pressure, (6) freedom from wind, (7) freedom from organic and inorganic particles in the air, (8) absence of fogs, (9) good water supply, (10) good drainage. The author believes that stations possessing all these properties are extremely beneficial to consumptive patients. His book will help sufferers from lung disease to the selection of a suitable winter residence.

## LETTERS TO THE EDITOR.

The Editor does not hold himself responsible for opinions expressed by his correspondents. Neither can he undertake to return, or to correspond with the writers of, rejected manuscripts intended for this or any other part of NATURE. No notice is taken of anonymous communications.]

## "Acquired Characters."

It may be at once conceded that persons who discuss whether "acquired characters" are inherited or not, ought to know and to be able to state clearly what is meant by the term "acquired characters."

I am surprised that Sir Edward Fry should find any difficulty in ascertaining what should be meant by this term when used in the case to which he refers, viz. the theories of Lamarck and of Darwin with regard to the origin of the species of plants and animals. Sir Edward Fry seems to assume that the matter under discussion is contained in certain writings by Prof. Weismann as though those writings were a sort of "affidavit," binding and limiting the discussion. The fact is that Prof. Weismann is a witness—and an advocate too—in a case which is of more ancient date than his connection with it.

Sir Edward Fry has found some satisfaction, as have many other writers, in pointing out inconsistencies and ambiguities in Prof. Weismann's statements; but it is to me somewhat astonishing that one should be invited to a textual criticism of Weismann's words in order to ascertain the significance of the term "acquired characters." The term and the discussion about the inheritance or non-inheritance of acquired characters were not invented by Weismann! They have been familiar ever since the discussion of Mr. Darwin's book on the "Origin of Species," commenced thirty-five years ago. The term has been explained and amplified over and over again. It really dates back to Lamarck; and I should propose, when anxious to know the meaning of a term associated with Lamarck's doctrine, to investigate Lamarck's writings rather than Weismann's.

Lamarck's "Philosophie Zoologique" was published in 1809. On p. 235 of vol. i. of the reprint of this work, issued in 1873 under the direction of Prof. Charles Marten, Lamarck states his two "laws" of organic development. They run:—

*Première Loi.*—"Dans tout animal qui n'a point dépassé le terme de ses développements, l'emploi plus fréquent et soutenu d'un organe quelconque fortifie peu à peu cet organe, le développe, l'agrandit, et lui donne une puissance proportionnée à la durée de cet emploi; tandis que le défaut constant d'usage de tel organe l'affaiblit insensiblement, le dégrade, diminue progressivement ses facultés, et finit par le faire disparaître."

*Deuxième Loi.*—"Tout ce que la nature a fait acquies ou perdre aux individus par l'influence des circonstances ou leur race se trouve depuis longtemps exposée, et par conséquent, par l'influence de l'emploi prédominant de tel organe, ou par celle d'un défaut constant d'usage de telle partie; elle se conserve par la génération aux nouveaux individus qui en proviennent, pourvu que les changements acquis soient communs aux deux sexes, ou à ceux qui ont produit ces nouveaux individus."

I have italicised two words in this quotation. It is to this doctrine of Lamarck that the short term "doctrine of acquired characters" has been and is applied.

In the report of a lecture given by me, at the London Institution, in February 1889 (published in NATURE of that date), on "Darwin *versus* Lamarck," the two laws of Lamarck were quoted in full. In lectures given some three years earlier I had pointed out that there is no satisfactory evidence that animals or plants transmit by generation the characters acquired by the individual in the way supposed by Lamarck.

It is, I admit, a very difficult matter to determine whether a particular character which makes its appearance in the course of the life of an organism has been "inherited" (i.e. is congenital) or "acquired." But that has nothing to do with the question as to what we should mean when we say "acquired characters." The answer to that seems to be certain and simple. It is given by Lamarck, and the term directly refers to Lamarck's doctrine.

On the other hand, it is the fact, as Sir Edward Fry points out, that Weismann and others have employed the term "acquired characters" in an extended and modified sense. To this extension I will refer in another letter.

E. RAY LANKESTER.

WE must all agree with Sir Edward Fry's desire to obtain a clear and exact definition of an "acquired character," as this term has been used in the discussions upon hereditary transmissibility. I do not think, however, that those who have taken part in the various controversies and discussions which have raged intermittently during the last seven years, have been misled by the lack of a sufficiently exact definition or the multiplicity of inexact ones. I believe that both sides have known well enough the kind of character which was called acquired, even though no sufficiently clear definition was forthcoming. And it may be that this mutual understanding has tended to obscure the demand for a definition.

An acquired character has generally been briefly defined as "the result of the operation of some external force upon an organism," and I still think that this is as satisfactory as any definition of equal brevity can be. But some want of clearness follows from the elasticity of the word "result." Everything that follows the operation of some external force may be called its "result"; but the definition interpreted in this way would include much that is not within the meaning of the word "acquired." Some increased precision may be added by using the words "direct result"; but a perfectly satisfactory definition should, I think, imply the admission that the result (in its wide sense) of an external force on an organism must always contain elements which are not due to the force—which are not acquired—as well as those which are due to the force and which are acquired. I think that the following definition will meet the case: "Whenever an organism reacts under an external force, that part of the reaction which is directly due to the force is an acquired character."

In many cases the external force acts only as a shock, with the starting of reaction as its only direct result. In such a case the occurrence of the reaction, as contrasted with the sequence of events which make up the reaction itself, is the acquired character. In examples such as these, those who maintain the transmission of acquired characters would be required to prove that the reaction which could only be started by an external force in the parent, started without this stimulus in the offspring.

I believe the definition suggested above meets all Sir Edward Fry's conditions—viz., that it includes all "acquired" characters, and excludes all that are not acquired; that it is physical and not metaphysical; that it is not "stated in terms derived from heritability or the contrary, or in terms of any hypothesis or theory"; and that it admits of ascertainment and verification.

That a reaction under an external force is compounded of two parts, due respectively to the body which reacts, and to the force which causes the reaction, is a fact and not a theory or hypothesis. It may be urged, however, that the separation of the two constituents does not admit of "ascertainment and verification." This may be true, in the present state of our knowledge, for certain cases; and if so, these cases would be unsuitable for the purposes of an inquiry into the transmissibility of acquired characters. But I do not admit that it is proved that the two constituents of the reaction cannot be separated in every case by a sufficiently careful investigation. For the purposes of this inquiry it is sufficient, however, if we can prove beyond doubt that some part of a reaction is the direct result of an external force, even if we have not thereby exhausted the whole of the direct results contained in the reaction. For if this can be done in a vast number of cases, an immense body of evidence will be provided, and we may expect that, if acquired characters are transmissible, some proof will be forthcoming.

I propose to test the efficiency of the definition given above, by showing how it can be applied to some of the examples given in Sir Edward Fry's letter.

In the case of the "exercierknochen" it is clear that the occurrence of the reaction—the existence of the bony growth—is the direct result of the external force. Here then is an acquired character which will be admitted by everyone, which can be witnessed in a vast number of examples, and which can be conveniently applied to test the transmissibility of such characters. There may, or may not, be other direct results contained in the reaction: some of the processes of osseous growth may have followed directly from continuous or intermittent pressure. But in the first place the verification is much more difficult, although not, I believe, beyond the reach of scientific inquiry, and, in the second place, such proof, if

obtained, would yield evidence which would be far more difficult to obtain in very large quantity.

It is clear that when Prof. Weismann admits that "the periodical change of leaf in temperate climates has been produced *in relation to* the recurring alternation of summer and winter," he is referring to the selection of inherent characters, and not the production of acquired characters. The sentences which follow the one quoted (p. 406), leave no doubt upon this point. Sir Edward Fry may feel assured that when any direct results of heat, cold, air, food, moisture, gravity, or light upon the organism are proved to be heritable, the controversy is at an end.

The case of geotropism logically resembles that of the "exercierknochen." The occurrence of the reaction is certainly a direct result of the external force—an acquired character; and here too we have an immense body of evidence to which to appeal, and which points only in one direction. In spite of the innumerable generations during which plants have assumed certain relative proportions under the influence of gravity, this influence is just as necessary to-day as it has ever been, and the youngest generation starts unbiassed by the direct result of external forces upon its ancestors.

As regards the "extra fingers or toes, patches of grey hair, moles, &c.," the question is raised as to whether external forces are not involved as direct causes. If this can be proved the question at issue is settled, for such characters are known to be transmissible. If not, the observation merely shows us that certain characters, not proved to be acquired, are transmissible. But if the non-transmissibility of those proved to be acquired has been established on a sufficiently large scale, then the observation in question, accompanied by the continued absence of proof that the characters in question are acquired, may be fairly held to indicate the existence of two contrasted classes of characters, which we may call spontaneous or inherent, and acquired.

We are asked if we have any scientific knowledge of the organic world independently of any external influence. This method of eliciting an answer must not be allowed to disguise, as it appears to do, the very positive knowledge we possess of the separate effects of the several external influences. This is a legitimate province of scientific investigation, and a large amount of research at the present day is devoted to such questions.

In handwriting the two constituents of the reaction are somewhat difficult, but by no means impossible, to distinguish. The external influence of training operates upon the most complex part of the organism, the nervous system, which again directs the muscular system. Is the style of handwriting due to the external force, or the organism which reacts? We can eliminate pen, ink, and paper as influences by only considering the cases in which these have been identical. There remains the influence of the teacher, and in order to prove that this has been the direct cause of style, it must be shown that the teacher had produced the same style in many pupils. If a style so produced became hereditary, evidence of transmissibility of an acquired character would be provided. Conversely, variety of style under the same conditions of teaching, &c., would favour the view that we are not dealing with an acquired character in this part of the reaction.

It is unnecessary to consider further the cases of mutilation and wounds, for I imagine that Prof. Weismann, and all who agree with him on this subject, will be willing to accept the clear statements of Sir Edward Fry's letter. "What the organism transmits is the capacity or predisposition, and not the actual result of the reaction." The latter in these cases is an acquired character, while no one has ever shown that there is any probability that the former is acquired.

I have, in this letter, avoided reference to many points raised by Sir Edward Fry, not from want of interest or inclination, but in order to keep to the main issue—the attempt to furnish a clear definition of the class of characters in question.

If acquired characters are transmissible, we must expect that sooner or later among the vast body of characters which are or will be admitted on all hands to be acquired, some valid instances of hereditary transmission will be forthcoming.

Such cases as that mentioned by Dr. Hill in NATURE of October 25, when on a sufficient scale and adequately sifted, would supply the requisite evidence. But up to the present such satisfactory evidence has not been forthcoming, although it has been sought for by many observers.

EDWARD B. POULTON.

Oxford, November 4.

THE following seems a passable definition, such as Sir Edward Fry asks for in his letter of November 1. But, in offering it, I only speak of the sense in which I myself use the expression.

Characters are said to be acquired, when they are regularly found in those individuals only, who have been subjected to certain special and abnormal conditions.

FRANCIS GALTON.

### Science Teaching in Schools.

TWO articles have recently appeared in NATURE which call for some comment, if the columns of your journal are to be opened once more to a discussion of this question. Educational reformers will agree heartily with the general position taken up by Mr. H. G. Wells, in "Science, in School and after School" (vol. I. p. 525), and by Prof. Armstrong in "Scientific Method in Board Schools" p. 631. But they either ignore or give very little credit for the honest science teaching that is actually being done at the present time. I realise, only too personally, the great difference between training in scientific method and mere instruction in science; and how few are the attempts to make use of the former in all grades of schools. But I hold that the old-fashioned instruction in science has, under favourable conditions, a considerable educational value. To have enabled a boy to realise the composition of the air and water is to have introduced him to the world of nature, and has widened his ideas and conceptions to an extent which justifies the means. Was not this one of the original pleas for the introduction of science into the school course? But having entered my protest, I will pass on.

Mr. Wells admirably distinguishes between the two styles of science teaching, and points out the original function of the Science and Art Department in encouraging and examining only the one of them. But he admits that the field of operation of the Department has been very much widened in recent years, and that its examinations "seriously affect the teaching of middle-class, and even of the higher standards of elementary schools." Yet his only suggestion is that the Department should withdraw from this work; for that would be the effect of an age limit, and is intended to be the effect of the recent alteration in the regulations in the elementary stage.

But circumstances are such that the Department cannot and ought not to withdraw from its present control of science teaching in *day-schools*, for its influence is greater than that of any other examining body; not simply financially, but from the magnitude of its operations. It is a historical quibble to say that the Department is concerned primarily with continuation and adult classes, when it specially encourages the formation of organised science day-schools, and yet rigidly confines the teaching in them to the schedules devised for adult instruction.

Last session there were 94 organised science day-schools, containing about 10,000 pupils taught on the lines laid down by the Department. As is well known, the majority of these are what are otherwise known as Higher Grade Board Schools, which are absolutely dependent for their existence on the grants obtained from the Department. I take it as indisputable that this is the very class of schools where the science ought to have an educational basis; where its function is "to develop and train the hand, eye and mind together, enlarge the scope of the observation, and stimulate the development of the reasoning power." I also believe that many of the teachers are anxious to make it so, judging from their liberal denunciations of the present "pernicious system." Equally axiomatic is it that, under the Science and Art Department, it is impossible to indulge in such teaching. Time will not permit. The pressure is so great that oxygen and water are almost always written and spoken of as  $O_2$  and  $H_2O$ .

Mr. Wells considers other examining bodies, whose work is exclusively directed to school needs, are far more than worthy. This I absolutely deny. In the first place, the South Kensington examinations are the only ones which are entirely controlled by scientific men. The sole cause for the existence of the Department is the encouragement of science and art, whereas the other bodies referred to provide for the examination of secondary education generally; and the examining board may not have a single representative of science upon it. But further, assuming that the South Kensington examinations are neither better nor worse than others, there are two causes which make them an educational abomination.

(1) In one year the pupils have to be rushed through such an excessive amount of work that the teaching degenerates into the merest cram. The Department distinctly states that students in the first year are to be prepared for the first stage, and in the second year for the second stage. Putting aside entirely the consideration as to whether the scheme is any particular subject, as chemistry, will any practical teacher deny that the requirements for either the first or second stage are far beyond what it is possible to accomplish with satisfaction within the given time? It must be kept in mind that the time-table has to provide not only for the seven or eight subjects of which the Department takes cognisance, but "for instruction in those literary subjects which are essential for a good general education." Do not these latter often suffer in favour of the former, especially at the approach of May?

(2) The consequence of this restriction is that boys scarcely in their teens enter by thousands for an examination beyond their normal capacities. It is in this that the South Kensington examinations differ so entirely from those of the Universities. The difference in standard between the Department's examination in chemistry and the Cambridge Junior Locals or London Matriculation is not great; but in practice, the average age of candidates in the latter is higher by two or three years. Time is allowed for the awakening and development of the powers of observation and reasoning. A boy is then able to describe intelligently what he has become thoroughly familiar with, instead of reproducing mechanically his notes or text-book.

In still another particular have the University Boards a decided advantage. Either they dispense altogether with an examination in practical chemistry, or they make something more of it than an analytical drill. Not much, it is true, but it must be remembered that practical chemistry is the most perverted subject in the whole range of knowledge at the hands of both teachers and examiners. But the greatest mockery is that which passes under the name at South Kensington. Of the written part of the examination it is needless to say anything; no boy would regard it as a test of what he has done in the laboratory, but what he has seen in the lecture-room. As to the analysis of salts, what bearing has it on the chemistry he is being taught elsewhere? Though at a certain stage it has a considerable educational value, the amount of time wasted upon it is appalling. It is useless to reiterate how easily it lends itself to being converted into a mechanical grind.

Mr. Wells is of the opinion that the recent abolition of the second class pass in the May examinations has had a beneficial effect. So it may, in extinguishing what might be termed "bogus" classes. But it has only intensified the evils in organised science schools, and put a higher premium on the cleverest cramming. The change did not deter such schools from sending in their pupils as before, but now they had to obtain 60 per cent. of the possible marks, or fail—and most of them failed. This year there were fewer failures, because the teaching has answered to the whip. Financially the result is satisfactory to them, but educationally it is disastrous. At that age the average boy is not capable of obtaining more than forty or forty-five per cent. of the marks in such a subject as chemistry. Very often he does not understand the full meaning of the question; and when he does, he is unable to write down more than a moiety of what he knows, or what could be drawn from him by a series of oral questions. There is no consideration shown for the immaturity of the candidates, but the standard is pitched higher than that of any other public examination in the country.

So far from agreeing with Prof. Armstrong that science must be admitted to equal rights with the *three R's*, I hold that it is taught too extensively as long as the present system of examination prevails, and that the first battle to be fought ought to be against the South Kensington examinations, until they truly perform their double function.

W. B. CRUMP.

Heath Grammar School, Halifax.

Will you allow me to take the opportunity afforded by the publication, in NATURE, vol. I. p. 631, of Prof. Armstrong's address at the Berners Street Board School, to offer my testimony to the value of teaching, based on the principles which he advocates so eloquently? The practical difficulty of teaching what Prof. Armstrong has called scientific method in an ordinary school, is often the ground of the objection made to it, so that it may interest your readers to hear of any experiments in this direction.

My work has been amongst girls, and the attempts made thus far in teaching scientific method in girls' schools show that such a method will inevitably lead to the development desired by Prof. Armstrong.

Doubtless one of the drawbacks is the difficulty of giving to each member of a large class the opportunity of individual work. I am not sorry, however, to have sometimes laboured under this difficulty myself, as it has brought about the discovery of how much could still be done on the right lines. When necessary I have replaced individual work by a demonstration class, in which the pupils, three or four at a time, have taken it in turns to work in front of the others, the work consisting in the solution of problems such as those suggested in the British Association's report on chemical teaching. The principal results are these: the children take a growing interest in the work, and those who are doubtful how far girls may desire to work with their hands, instead of always sitting still, may be glad to hear that no greater incentive to invention can be given in a demonstration class than the reward of becoming the experimenter for the time being. There is never any lack of suggestion for the next step in the work, and the rapidity with which such work trains the girls to consider the value or defects of any new proposal for the solution of their problem, is sometimes astonishing. In these classes the teacher plays a very small part—at least, apparently—only from time to time directing the suggestions, and giving permission for new work to be started; invention, experiment, meaning of results, and criticism are all undertaken by the children, and the final "discovery" is their own triumph.

I have often been asked by teachers about the discipline of such a class, since experimental work goes so slowly that they think it would be impossible to keep those who are not actually at work attentive. I can only say that the class consists of a group of people genuinely interested in a common object, and it behaves in the way such groups generally do. If at times a girl's enthusiasm so far carries her away that she rushes from her seat to the experimenting table, the class, with a laugh, excuses her, sympathises with her feelings, and is not disturbed thereby.

It seems unquestionable that the result of such work should have a wider-reaching effect than the mere knowledge of certain facts in nature, though such knowledge is also obtained. Where children, through their own work, have been led to observe and then to think, the result may fairly claim to be truly educative, and one is often at a loss to understand what support can be found for the still largely-existing method of teaching not science but "useful information."

Another objection often made to teaching scientific method instead of facts, that it takes too much time, I have already answered in this journal. I may perhaps be permitted to repeat that experiment shows the result of elementary training, of the kind described, to have a lasting influence on the rapidity and comprehension with which new subjects are grasped later on. Books, too, which are never put into the hands of beginners, are used with more than ordinary sense at this later stage. I may say that, even from the examination test (which, however, is not always going to be our standard), the results are very favourable. One thing, however, cannot be done by the teaching of scientific method, and that is to prepare for the London Matriculation examination in chemistry in three months—but then, is that altogether to be regretted?

GRACE HEATH.

North London Collegiate School for Girls, November 5.

#### Italian Scientific Expedition to Monte Rosa.

In the summer of this year, my assistant Dr. L. Scofone and I stayed a month at the Alp of Lavez in the valley of Gressoney, near the foot of the Indren glacier, at an altitude of 2450 m., not far from the place where the brothers Schlagintweit spent some days in 1851 while engaged in their well-known scientific observations on Monte Rosa.

We purposed to examine, both chemically and bacteriologically, the composition of the waters of that region (inclusive of snow and ice); some of the analyses (ammonia, nitrites, nitrates and organic matter) were made directly on the spot, where we had a small laboratory. To be able to carry the waters to Turin, for further analysis, we had only to evaporate them, and seal the residues in little glass bottles by means of a blow-pipe. The detection of germs was made by using agar and

gelatine plates enclosed in the well known Petri's glass-boxes; gelatine, agar, pipettes, and other instruments being duly sterilised first in Turin, and then at Lavez, with a good hot air oven. The development of germs was secured by putting the plates in an incubating oven.

We also collected the water of the Indren torrents issuing from the glacier, and measured the amount of suspended matter in the water, which can give an idea of the process of erosion that takes place in the bed of the ice stream.

The results of the various observations will be published in the scientific papers of Turin as soon as the study of the collected material has been completed. It will perhaps interest your readers to know that while the water of the springs, streams and lakes was constantly free from ammonia, there was found a tolerable quantity of it in the snow collected on the summit of the Punta Guiffetti or Signal Kuppe, one of the loftiest peaks in the Monte Rosa range, measuring 4539 m. The ice of the Lys Glacier, dug out from the depths of a huge crevasse, also contained ammonia; nitrites and nitrates being absent in every case. Accordingly we found that the water of the Indren stream, during a very hot day, when the melting of the ice was considerable, contained traces of ammonia.

We also found that the ice and snow collected on the various peaks, passes, and snow-fields of the Monte Rosa range, contained a few germs. The number of the species whose germs can thrive at those heights is certainly not large: the usual forms, living in decayed matter and in the intestines, cannot probably endure the condition of temperature, pressure and light of the place.

Turin, October 28.

PIERO GIACOSA.

#### Chinese Beliefs about Caves.

MR. HERBERT SPENCER, in his "Principles of Sociology" (3rd edition, New York, vol. i. p. 207), relates the beliefs in the creation of mankind under the ground or in caverns, current among the Todas in Asia, the Basutos in Africa, and at least one-half of the American tribes. A similar belief I have lately found in a Chinese record. In Li Shih's *Su's P'ih-wai-chi* (written in the 13th cent. A. D., Japanese edition, 1683, tom. ii. p. 3) a quotation from the *Ming-kuo-h-lun* runs as follows:—"Primitively there was no Lián-K'ien in Shuh (now Sze Chuen); this tribe emanated from red clay in a cave of Teh-yang mountain, whence bits of the soil had began to roll out, each roll enlarging them, so that at last thereby was created a couple, who gave birth to many."

In another paragraph Mr. Spencer remarks:—"Stationary descendants of troglodytes think that they return into a subterranean other-world whence they emerged (*ibid.* p. 213). According to this, I would suggest that the same belief, entertained by some aborigines in China, has revived itself among the Taoists, who used to call their paradise the "Cave-Heaven" (Tung-Tien)—e.g. Twan Cbung-Shih describes the "Cave-Heaven" 10,000 *lis* in circumference and 2600 *lis* in height (his "Miscellanies," Japanese edition, 1697, tom. ii. p. 1), and Li Shih enumerates thirty-six caves in the empire, all entitled "Heavens" (*ibid.* tom. i, p. 8).

KUMAGUSU MINAKATA.

15 Blithfield Street, Kensington, W., November 2.

#### Spots over Dogs' Eyes.

I WOULD have written a note on this subject long ago, had I not failed to see similar spots general amongst wild animals allied to the dog. The spots may, however, be more general than I am aware. The spots are by no means always tan; a black dog will sometimes have them white, and a white dog black. I have a white-and-tan fox-terrier, in which the spots are very eye-like and jet black; in a brown bull-pug of mine, the spots are also black. These spots are so eye-like, that when the dogs are asleep they seem at first sight to be wide awake.

Has not the human eyebrow, highly developed in some crude races, as in Australians and Ainos, a similar meaning? The eyebrow gives many sleeping persons the appearance of being awake.

WORTHINGTON G. SMITH.

Dunstable.

#### Gravitation.

IN his interesting paper upon the "Mechanical Stretching of Liquids" (*Phil. Trans.* 1892, A, p. 370), Prof. Worthington describes a phenomenon of attraction between bodies immersed

in a stretched liquid. His explanation is ingenious: that the close contact of the bodies liberates from a denser surface layer, liquid which will go to supply the prevailing demand, and so lower the energy of the stretched liquid.

Whether this be a quite correct explanation or not, does not the experiment suggest the possibility of an analogous phenomenon occurring in a tensile ether in which matter is immersed; giving rise to the effects which we appreciate as gravitational attraction?

J. JOLY.

Trinity College, Dublin, November 6.

#### Homogeneity of Structure the Source of Crystal Symmetry.

To the lucid notice of my paper, "Ueber die geometrischen Eigenschaften homogener starrer Strukturen und ihre Anwendung auf Krystalle," contained in your issue of October 18, it is perhaps desirable to add a remark.

The paper referred to is purely geometrical: it starts with a definition, and not with a supposition. Consequently the various new theories advanced by the writers referred to in the notice receive no support from it.

Homogeneity of structure pure and simple, unaided by any theory as to the nature of matter, leads inevitably to all the varieties of symmetry presented by crystals. It is useless, therefore, to look to the facts as to this symmetry for any light upon the vexed question whether the seat of the symmetry is in the arrangement or in the configuration of the molecules, or, indeed, for any proof of the existence of molecules or separable units.

WM. BARLOW.

Muswell Hill.

#### THE PRESENT STATE OF PHYSIOLOGICAL RESEARCH.

THE following extracts from an article by Prof. Max Verworn, of Jena, on "Modern Physiology," published in the *Monist* for April 1894, seem to be well worth the attention of English biologists. It would be interesting to obtain in the pages of NATURE an expression of opinion from our physiologists as to how far the reproach is true, that "in treading the beaten paths we are making no progress in physiology, and have stood still for years on the same spot." How far is it true that physiologists must revert to the point of view of comparative physiology, or the physiology of the endless variety of lower and simpler forms of life which was that which formerly so fruitfully shaped the research of the great master Johannes Muller? Is it, or is it not, time that the methods of horological physiology were less dominant and gave place to a determined and persistent study of living structure in many of its varied manifestations other than the frog and the rabbit?

Psychologically, it is a highly interesting phenomenon, and one of moment in the history of science, that now, almost immediately after the final suppression of the old vitalism by the new development of the natural sciences, we have again arrived at a point which corresponds in the minutest details to the reversion to mystical vitalism which took place after the clear and successful research of the preceding century. As a fact, the parallel between the conditions of the eighteenth century and those of to-day is unmistakable. Now, as then, the physico-chemical method of explaining phenomena of life looks back on a brilliant, almost dazzling sequence of successes; now, as then, the tracing of vital processes to physical and chemical laws has reached a point at which, for many years, with the methods now at our command, no essential progress has been made, where, on the paths hitherto trodden, a boundary line is everywhere distinctly marked; and now, as then, on the horizon of science the ghost of a vital force looms up. It has already taken possession of the minds of serious thinkers in Germany, with the dire prospect of more extensive conquests, and in France, too, it would seem, science is slowly opening its door to this invasion of genuine mysticism.

To understand this phenomenon psychologically, and to acquaint ourselves with the means of saving off a general reaction into vitalism, it is desirable to examine more carefully

the present state of physiology. A review of the productions which appear in our different physiological journals, which will best exhibit the present state and tendency of the science, furnishes an extremely remarkable spectacle. Leaving aside the science of physiological chemistry, which is independently developing with great success, we find, with the exception of a few good contributions to the physiology of the central nervous system, as a rule, only extremely special performances of very limited scope and import, wholly without significance for the greater problems of physiology, whether practical or theoretical, and exhibiting no connection whatever with any well-defined general problem of physiology. In fact, what is called physiology is beginning here and there to degenerate into mere technical child's play. With every new number of our physiological magazines, the unprejudiced observer is gradually gaining the conviction that general problems of physiology no longer exist, but that inquirers, driven to desperation in the struggle for material, have no choice but to hunt up the old dry bones of science, on which they fall with the nervous rapacity of hungry dogs. And in the case of most of the productions, this impression is strengthened by the fact that the results, when once found, are wholly disproportionate to the tremendous expenditure of labour and time which it might be seen beforehand they would require. And yet all the time the great problems of physiology everywhere stare us in the face and seek solution. For, if we regard the problem of physiology as the investigation of the phenomena of life, we are certainly yet very far from the solution of even its most important and most general problems. We need not go to the extreme that Bunge does in his excellent text-book of physiological chemistry, of maintaining that the phenomena of our organism which we have explained mechanically are not genuine vital processes at all, no more than is 'the motion of the leaves and branches of a tree shaken by a storm, or the motion of the pollen which the wind wafts from the male to the female poplar.' But it is certainly no exaggeration to say that what the splendidly conceived methods of the great masters of physiology since Johannes Muller have explained, are not elementary processes of life, but almost exclusively the crude physical and chemical actions of the human body.

"For what have we attained? We have measured and registered the motions of respiration, the mechanics of the gaseous exchange in the lungs in their minutest details. We know the motions of the heart, the circulation of the blood in the vascular system, nay, even the slightest variations of the pressure of the blood, as produced by the most diverse causes, as accurately as we do the phenomena of hydrodynamics in physics. We know that respiration and the motion of the heart are conditioned by the automatic activity of nervous centres in the brain. But no spirometer, no kymograph, no measuring or registering apparatus can give us the slightest idea of what takes place in the nerve-cells of the brain that condition the beating of the heart and respiration.

"Further, we have investigated the motions of the muscles, their dependence on the most diverse factors, their mechanical powers, their production of heat and electricity, as exhaustively as only the phenomena of the special departments of mechanical physics have hitherto been treated. But of what goes forward in the minute muscle-cells during simple muscular contraction, no myograph, no galvanometer has as yet given us the slightest hint.

"We know also the laws of the excitability of the nervous fibres, of the propagation of irritations, of the direction and velocity of nervous transmission, thanks to the ingenious methods of recent physiology, in all their details. But of what is enacted during these processes in the nerve-fibres and in the ganglion cell from which it ramifies, no induction-apparatus or multiplier can give us the least information.

"We know besides, that the heat and electricity produced by the body, and the mechanical energy of muscular work, are the consequence of the transformation of the chemical energy which we have taken into our bodies with our food. But by means of what chemical processes the cells of the individual structures take part in these achievements, the most sensitive thermometer or calorimeter will not disclose, and no thermal pile or graphical apparatus will indicate.

"We might give any number of examples of this kind, but those adduced exhibit distinctly enough the point to be signalled. What we have hitherto attained is this: we have measured, weighed, described, and registered the gross



mechanical actions of the human body, for the most part with a degree of precision that would excite the astonishment of the uninitiated; we have also acquired a considerable knowledge of the rough mechanical interactions of the individual organs of the body, the mode of operation, so to speak, of the machinery of organisms. But all that has been done, has been done only up to a certain point; and this point, at which we are brought to a halt, is the *cell*. We have traced all phenomena of change in matter, form, and force back to the point where they disappear in the cell. But of what takes place in the muscle-cell, the ganglion-cell, the lymph-cell, the gland-cell, the egg-cell, the sense-cell, and so forth, we have not the slightest conception. Moreover, we discover here, that even the minutest cell exhibits all the elementary phenomena of life; that it breathes and takes nourishment; that it grows and propagates itself; that it moves and reacts against stimuli. The *elementary* riddles of life, accordingly, have so far defied all research.

"A balance thus cast of the results of past physiological research does not, it must be admitted, exhibit a very encouraging outlook.

"But the resignation of physiology has been strengthened by another prominent factor. This is the attitude of physiological research to psychical phenomena. This attitude is at the present moment a varying one. On the one hand, we still find secretly cherished the vain hope of a chemical and physical explanation of psychical processes, that is to say, of a reduction of them to the motions of atoms, even though Du Bois-Reymond, in his famous address on 'The Limits of Our Knowledge of Nature,' characterised such an understanding as utterly futile; while on the other hand we meet with an absolute resignation in the face of this question—an attitude which is simply a frank acceptance of the conclusion of Du Bois-Reymond's address. Owing to the authority of its author, the 'Ignorabimus' of Du Bois-Reymond has influenced great numbers of inquirers, and produced in physiology a real paralysis of research, so that the abandonment thus effected of the solution of the old problem of explaining psychical phenomena mechanically has caused physiology for the most part anxiously and reverently to avoid any intrusion whatever of psychological questions. On the one side, then, is the idle hope of solving a problem which, despite its being as old as human thought itself, research has not yet even touched; and on the other, an absolute renunciation of any treatment of the problem whatsoever.

#### CELLULAR PHYSIOLOGY.

"If on the one hand we can justly cherish the hope that the increasing extension of the monistic world-view in natural science will ward off the dangers of a reaction to the old vitalism, the fact nevertheless remains that in treading the beaten paths we are making no progress whatever in physiology, and that we have stood still for years on the same spot, and not approached a single step nearer our goal of explaining the elementary phenomena of life.

"We have reached a turning-point in physiological research which could scarcely be made more prominent. The reappearance of vital force is a token of it. As before all great crises of history portentous spirits appear to clairvoyant people, so in our days the ghost of the old vital force has loomed up in the minds of some of our natural inquirers.

"But striking and obvious as the fact is that we can no longer approach by the old paths of research an explanation of the elementary phenomena of life, still, it is exactly as obvious and striking in what direction there is the only chance or hope of our approaching our goal.

"We have traced the vital processes of man in physiology back to the point where they are lost in the cell. Now, what is more reasonable than that we should seek them out in the cell? In the muscle-cell is hidden the riddle of muscle-movement, in the lymph-cell is hidden the causes of secretion, in the epithelial cell is buried the problem of resorption, and so on. The theory of the cell has long since disclosed that the cell is the elementary foundation-stone of the living body, the 'elementary organism' itself, that in which the processes of life have their seat; anatomy and evolution, zoology and botany, have long since realised the significance of this fact, and the wonderful development of these sciences has furnished a brilliant proof of the fruitfulness of this branch of inquiry. Only

<sup>1</sup> *Ueber die Grenzen des Naturerkenntens. Reden. Erste Folge.* Leipzig, 1886.

in physiology was the simple, obvious, and logical consequence overlooked, and until very recently not practically applied, that if physiology regards it at all as her task to inquire into the phenomena of life, she must seek these phenomena at the spot where they have their origin, at the focus of life-processes, in the *cell*. If physiology, therefore, is not simply content with confirming the knowledge which is already gained of the crude mechanical actions of the human body, but makes it its object to explain clearly elementary and general phenomena of life, it can accomplish this object only as cellular physiology.

"It may appear paradoxical, that although nearly half a century has elapsed since Rudolf Virchow first enunciated in several classical works the cellular principle as a basis of all organic inquiry, a basis on which to-day, indeed, all our ideas in pathology are constructed, physiology still is only just beginning to develop out of a physiology of organs into a physiology of cells. Yet this is the true and normal course of development of science which always advances from the crude to the delicate. And it would therefore be im pardonable ingratitude, and a mistaking of the mode of development of human knowledge, if we should seek in the least to underrate the high importance of the physiological research of the past epoch, on whose shoulders in fact we stand, and with whose results we more or less consciously continue our work. Further, in our judgment of the course of development of physiological research, a factor must not be overlooked which controls the development of every science, namely the psychological factor of fashion. The development of every science depends on the stupendous influence of great discoveries. Wherever we cast our eye in the history of inquiry, we find that great discoveries such as, to take the case of physiology, are represented in the works of Ludwig, Claude Bernard, Du Bois-Reymond, and Liebig, deflect interest from other fields and induce a great multitude of inquirers to pursue research in the same direction, with the same methods, especially when these methods have proved themselves so wonderfully fruitful as in the cases adduced. Thus, certain departments of inquiry become, in connection with epoch-making performances, fashionable, and the interest of thinkers in others subsides. But an equalisation in the course of time is always re-effected, for every field of inquiry, every method of inquiry is finite and exhausts itself in time. We have now reached just such a point in physiology: the physiology of organs is in its period of exhaustion. Also the method of cellular physiology will exhaust itself in the course of time, and its place will be taken by other methods which the present state of the problem do not yet require.

But for the present the future belongs to cellular physiology. There are, it is true, inquirers who, although they are convinced of the present necessity of a cellular physiology, and see perfectly well that the cell as the focus of the processes of life must now constitute the real object of research, yet doubt for technical reasons whether it is possible to get at the riddles of life as they exist in the cell. It may, therefore, be justly demanded that some way, some methods be shown with which a cellular physiology can be founded. The doubt of the feasibility of this undertaking is in great part the outcome of a phenomenon, which, unfortunately we must say, has characterised physiology ever since the death of Johannes Muller, namely, the total lack of a comparative physiology. Physiology has not yet entered on this rich inheritance of the great master. How many among the physiologists of the day are acquainted with other objects of experiment than the dog, the rabbit, the guinea pig, the frog, and a few other higher animals! To how many are the numerous and beautiful objects of experiment known which the wonderful luxuriance of the lower animal world offers! And yet, just among these objects are to be found the forms which are best adapted to a cellular-physiological solution of physiological problems.

"Naturally, if we believe we are limited, in our cellular-physiological treatment of the riddles of motion, digestion, and resorption, solely to man and the higher animals, we shall encounter in our investigation of the living muscle-cell, lymph-cell, epithelial cell, and so forth, more or less insuperable technical difficulties. And yet the splendid researches of Heidenhain on secretion, digestion, lymph formation, and so forth, have shown what good results the cellular-physiological method can achieve even here. Well-planned histological experiments, such as those which put the living cell in its intact connection with the remaining woof of the body under given conditions, and then investigate the results

in the suddenly slaughtered animal, to get from such experiments light on the processes peculiar to the condition of life, undoubtedly furnish the germ of much valuable knowledge. But it is of the very nature of these experiments that they must always remain difficult and restricted, for the living object, the tissue-cell, is accessible to microscopic investigation only with the greatest difficulty. Comparatively small difficulties in this respect are offered only by the free-living cells of the organism, as, for example, by the leucocytes or blood-corpuscles. And as a fact, by the researches of Metschnikoff, Massart, Buchner, Gabritchewsky, and many others, we have recently acquired some important and wide-reaching experimental knowledge concerning the vital phenomena of these very objects.

But if we place ourselves at the point of view of comparative physiology which Johannes Muller represented throughout his whole life with such success and energy, an infinitely broad perspective opens itself up for cellular investigations. A comparative view shows one fact of fundamental importance, namely, that elementary life-phenomena are inherent in every cell, whether it be a cell from the tissues of higher animals or from the tissues of lower animals, whether it be a cell of a plant, or, lastly, a free cell, an independent unicellular organism. Every one of these cells shows the general phenomena of life, as they lie at the basis of all life, in their individual form. With this knowledge, all that it is necessary for the inquirer to do is to select for every special object of experiment the fittest objects from the wealth of forms presented, and with a little knowledge of the animal and plant world, such forms really obtrude themselves on the attention of the experimenter. Accordingly, it is no longer necessary to cleave so timorously to the tissue-cells of the higher vertebrate animals, which, while alive and in normal environment, we can only use for microscopic experiments in the rarest and most exceptional cases; which further, the moment they are isolated from their tissues, are no longer in normal conditions, and quickly die or give reactions that may easily lead to wrong conclusions and to errors. Much more favourable are the tissue-cells of many invertebrate, cold-blooded animals or plants which can be more easily investigated in approximately normal conditions of life; yet even these, as a rule, will not outlast protracted experiments. But here appear as the fittest imaginable objects, for cellular-physiological purposes, free-living unicellular organisms—namely, protists. They seem to be created by nature expressly for the physiologist, for they possess, besides great powers of resistance, the incalculable advantage of existing in a limitless variety of form, and of exhibiting, as the lowest organisms that exist, all phenomena of life in their simplest conditions, such as are not to be found among cells which are united to form tissues, on account of their one-sided adaptation to the common life of the cellular colony.

Concerning the application of experimental physiological methods to the cell, we need be in no perplexity as to which we shall choose. In the luxuriant multiplicity of form which this world presents, there can always be found for every purpose a great number of suitable objects to which the most different special methods can be capably applied.

We can, to begin with the simplest method, apply in the easiest manner imaginable to the free-living cell the method of simple microscopic observation of vital processes. In this manner mere observation has furnished us knowledge of the individual life-phenomena of cells in many details, and also of their mutual connection. Among the most recent achievements of this simple method may be mentioned only the extremely valuable knowledge concerning the more delicate and extremely minute circumstances of fecundation and propagation which Flemming, Van Beneden, the Hertwigs, Strasburger, Boveri, and many others have gained in recent years, partly from living cells and partly from cells fixed in definite conditions of life.

Moreover, we can also conduct under the microscope vivisectional operations on unicellular organisms in exactly the same scope and with greater methodical precision than can be done on the higher animals. Several inquirers, as Gruber, Balbiani, and Hofer, have already trodden this path with great success, and a considerable group of researches has shown distinctly enough the fruitfulness which this cellular vivisectional method of operation promises for the treatment of general physiological problems. With this vivisectional method also Roux, the Hertwigs, and others conducted their splendid investigations on the "mechanics of animal evolution," by showing

what functions in the development of animals fall to the lot of the different parts of the egg-cell, or to the first filial cells that proceed from their division.

"We can also apply here, in its whole extent, that powerful physiological method known as the method of irritation, and investigate the effects of different kinds of irritation on the life-phenomena of the cell or of different cell-forms. The vegetable physiologists have already collected a great mass of material in this field. But also in the department of animal physiology a great number of recent works have endeavoured to prove that the phenomenon of irritation which takes place on the application of chemical, mechanical, thermal, galvanic, and luminous stimuli to unicellular organisms are of the greatest importance for the phenomena of life generally.

Finally, we can approach the life-phenomena of the cell chemically, although in this direction only the very first beginnings have been made, seeing that the microchemical methods have been hitherto little developed. Nevertheless, the labours of Miescher, Kossel, Altmann, Zacharias, Lowit, and others have already shown that the microchemical investigation of the cell has a future of great promise."

### INK-CRYSTALS.

THE pictorial representations of the forms taken by ice-crystals are familiar to everyone; and many young observers have been grievously disappointed with the difference between nature's handiwork and artistic fancy, as exemplified by the ice-crystals really seen and those which embellish scientific works. These "ice-

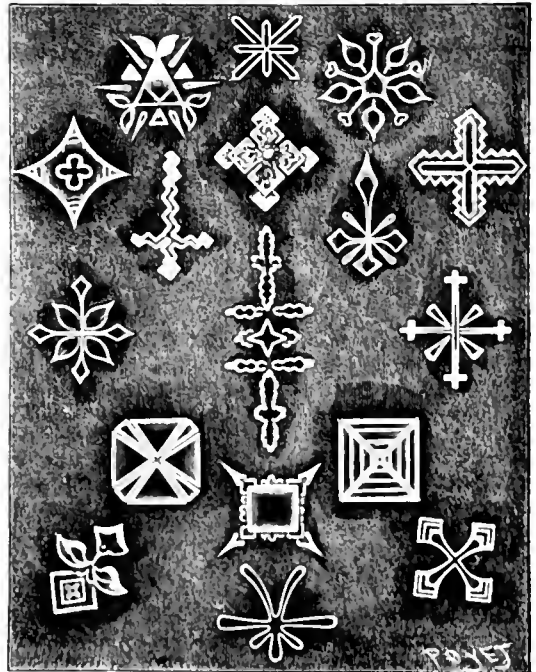

FIG. 1.—Crystal form of Ink by the Evaporation of Ink.

flowers," as Tyndall called them, cannot always be conveniently produced, so a substitute for them, in the form of "ink-flowers," should be interesting to students of crystallography. Dr. E. Trouessart describes in *La Nature* how "fleurs de l'encre" can be procured, and the accompanying illustration reproduces some of the forms observed by him. The method employed is very simple. A drop of ink is allowed to dry on a slip of glass, and observed under a microscope with powers of

50, 100, or 200 diameters. The inks of commerce vary somewhat in composition, hence the facility with which certain crystalline forms are obtained differs. All inks, however, having a base of solution of gall-nuts and sulphate of iron, give analogous results.

Dr. Trouessart hesitates to express an opinion as to the nature of the salt which crystallises in the forms illustrated. The crystals chiefly belong to the cubical system, and this suggests that they are magnetic oxide of iron. On the other hand, their white colour, and the peculiar shapes of some of the groups of crystals, indicate that iron disulphide or marcasite is the substance in question. Perhaps some worker in chemical crystallography will determine the point.

### NOTES.

WE learn from the *Lancet* that the late Prof. Pouchet, of the Muséum d'Histoire Naturelle, has bequeathed his entire fortune to the Paris Society of Biology. The bequest is made in the following terms: "N'ayant pas de famille, je legue tout ce que je possède à la Société de Biologie, où j'ai toujours trouvé bon accueil et sympathie depuis le jour où j'en ai été membre. Je crois fermement que c'est le meilleur usage social à faire du peu de bien que je laisse environ 2000 francs de rente." (£50 a year).

DR. WALTER DICKSON, R.N., the author of "The Antarctic Voyage of H.M.S. *Pagoda*," and several works on naval hygiene, died on the 9th inst. at the age of seventy-three.

BY the recent death of Lieut.-Colonel Garrick Mallery, in his sixty-fourth year, the U. S. Bureau of Ethnology has lost one of its chief ornaments. The results of his important researches into the sign and gesture language of American aborigines occur in the current annual report of the Bureau.

THE *Times* reports a severe earthquake and volcanic eruption at Ambrym, an island in the New Hebrides group. The disturbance is said to have occurred on October 15, when several severe shocks were felt throughout the whole island. Immediately afterwards the volcano, which is 2500 feet high, was observed to be in active eruption. The lava destroyed the native villages on one side of the island, and a large number of natives sought refuge on board H.M.S. *Dart*, which was cruising off the coast. Considerable damage appears to have been done in a large portion of the island.

THE Christmas course of lectures, adapted to children, at the Royal Institution, will be delivered by Prof. J. A. Fleming, F.R.S. The subject will be "The Work of an Electric Current," and the first lecture will be delivered on Thursday, December 27, at three o'clock.

FOR several weeks the weather over the British Isles has been very unsettled, but no gales of serious importance had been generally experienced until Sunday night, when a deep barometric depression reached our south-west coasts from the Atlantic, accompanied with very heavy rainfall in the south and west; the amount measured at Scilly during twenty-four hours ending 8 a.m. on the 12th instant amounted to over three inches, or nearly the average fall for the month, while at Hurst Castle, on the Hampshire coast, the fall exceeded two inches. The central area of the storm passed the whole length of the English Channel, and crossed the North Sea during Monday night, strong northerly gales being experienced in the rear of the disturbance, accompanied with thunderstorms, hail, and more

heavy rain, the amount measured in London on the 13th instant being about 0.75 inch. A very rough sea was experienced in the English Channel and in the Irish Sea. This disturbance was followed by another which approached our extreme north-west coasts on Tuesday night, causing strong gales over all parts of the country, and very heavy rain in the west. The temperature has been from 4° to 6° above the mean; during the week ended the 11th instant the highest maxima recorded were 61° in the Channel Islands, and 60° in the south of England, and the lowest minima fell to 29° in the south-west of England, and to 32° in the Midland Counties.

PROF. GUIDO CORA, of Turin, will, on his approaching birthday, December 20, be presented by his former students with "a special mark of esteem and affection" in the form of a memorial in recognition of the twenty-fifth anniversary of his first published paper. It is well known that he founded and has maintained the geographical journal, *Cosmos*, at his own expense. In order to give his many scientific friends an opportunity of sharing in the general recognition of Prof. Cora's labours, Prof. Paul Revelli, 12 Via Gallinari, Turin, is prepared to receive any written "sentiment," portrait, drawing, or signature for the memorial volume. The date up to which such tokens of respect may be sent is extended to March 31, 1895.

DR. DONALDSON SMITH, who left London early this summer to attempt to reach Lake Rudolf from the north-east, has been able to send letters home from a position in 7° 11' N., and 42° 11' E., dated early in September. He had formed a caravan at Berbera, started with more than a hundred camels, and travelled south-westward through an unmapped country, of which he has made a running survey. At Turfa he reached a great river, which he believes to be the Erer, and to be continuous with the Webi Shebeli. Being unable to cross, he spent a week in following the course of this river, thirty miles of which he has mapped; and on his return he succeeded in finding a ford, where the caravan crossed with much difficulty. The country was very thinly peopled, on account of wars between the Gallas and Ogadams, but some natives were found to carry letters to the coast, a task which they must have performed very expeditiously. Dr. Smith has made large collections of the fauna and flora of the region traversed, and has had some thrilling adventures with big game. His men were doing well, and he was confident of success in his journey, although the time necessary to complete it appeared likely to be rather longer than was originally expected.

THE death is announced of Colonel R. V. Armstrong, C.B., F.R.S., late of the Royal Engineers. He was born in 1839, and was the son of the late Rev. W. Armstrong, of Cairy, County Sligo.

IN the last number of the *Scottish Geographical Magazine* Mr. W. S. Anderson, of the Scottish Marine Station, discusses the relative merits of the methods for determining the density of sea-water by means of hydrometers and by direct weighing. He shows that if the temperatures of water, instrument, and air are in equilibrium, and the observations made on land, the *Challenger*-type hydrometer yields results of equal value with those of Sprengel tubes, provided the mean of a large number of observations is taken. At sea the hydrometer is less satisfactory. Mr. Anderson throws discredit on previous work in this direction, and assumes that the work of some earlier observers showed large discrepancies on account of the scale of the hydrometer being read from the wrong end. Unfortunately, he does not make any reference to the place where this work is published. By the use of a very large hydrometer admitting of

he detection of extremely delicate differences in density, Mr. Anderson satisfied himself that capillarity has no perceptible effect upon the accuracy of the readings. By a series of observations at different temperatures he has been able to construct new tables for the reduction of observed densities to standard temperature, and for the calculation of the function  $D$ , which is the difference of density between the sample and pure water divided by the number of grammes of chlorine per litre, a function to which considerable importance is now attached in the discussion of the relative differences between samples of sea-water.

OUR excellent contemporary, *The Engineering Magazine*, commenced a "Review of the Industrial Press" in the October number, and an index of current technical literature. The object of this review and index is to give concisely-written notices of the most important articles of the month; and to supply a carefully classified index to all the articles published currently in the scientific and industrial press of the United States and Great Britain. An entirely new feature is the establishment of a department to supply all or any portion of any article reviewed or indexed. That technical journalism has grown to proportions and importance which warrant such a development, is a fact at which we can all rejoice.

OBSERVATIONS on the variations in level of well-water have been made for the last three years at the Observatory of Catania in Sicily, and the first results are described in a paper by A. Ricco and S. Arcidiacono (*Boll. mens. dell'Acc. Catania di Sci. Nat. in Catania*, fasc. 37, June 10, 1894.) They classify the movements into progressive, annual and accidental, subdividing the latter into meteoric and geodynamic. The accidental variations of geodynamic origin consist of small abrupt changes of level, generally downwards, which frequently correspond to movements of the ground. Shortly before the eruption of Etna in 1892, and for several months after, the changes in level of the water-surface were extremely irregular. From June 1, to December 31, 1892, corresponding to thirty-nine groups of earthquakes, there were abrupt changes of level within twenty-four hours in twenty-one cases; there were also fifty small but marked changes coinciding with strong oscillations of the tromometer. Somewhat similar observations have been made in Wisconsin, by Prof. F. H. King (U. S. Dep. of Agri. Weather Bureau, *Bull.* No. 5). Here the shock was imparted by heavily-laden trains passing less than fifty yards from the well; but the surface of the water invariably rose, sometimes as much as one tenth of an inch, returning to its former level after a few seconds.

At a recent meeting of the Academy of Science of Amsterdam, Herr C. H. Wind read a note on the Kerr phenomenon. The author breaks up the electric current into two parts—a current of conduction and a displacement current—and to these attributes, as Lorentz has done, the Hall effect. He supposes, however, that the electromotive force which constitutes the Hall effect is different for the two constituents, while Lorentz supposes them to be equal. The introduction of this hypothesis into the calculations of Van Loghem does not alter the general form of the results, but has the effect of giving expressions for the phase and the amplitude of the magneto-optic component which differ by a constant quantity and a constant angle from the old values. In this way the difference of phase discovered by S. Singh is explained; and from the observed value of this difference of phase the ratio between the intensity of the Hall effect for the displacement and conduction currents can be calculated, and then from observations of the amplitude the value of each of these can be found. From the calculations made by the author, it appears that the values thus obtained are of

the same order as those got by direct observation of the Hall effect, if we suppose that the specific resistance of metals for periodic currents of extreme rapidity is greater than for continuous currents. This view is further supported by other calculations which have been made by the author. The paper concludes with a comparison between the above theory and the theories propounded by Thomson, Goldhammer, and Drude.

IN No. 38 of the *Sitzungsberichte* of the Berlin Academy, Prof. Goldstein gives an account of a curious effect which the cathode rays exert on the colour of certain salts. If potassium chloride be made to phosphoresce in a radiation-tube, it quickly assumes a strong heliotrope shade, and eventually becomes bright violet. On heating, the colour changes to blue, and at high temperatures the salt becomes white. The same series of colour-changes may be obtained with this decolourised salt, and also with naturally occurring potassium chloride or sylvine. Several haloid salts of the alkali metals were examined, and with the exception of cesium and rubidium chlorides all gave after-colours. The chlorides of barium and strontium gave no after-colours. In ordinary air the colour disappears the more quickly the more soluble the salt. The colour of lithium chloride fades almost immediately; the blue colour of sodium chloride lasts about a day. In contact with water the salts at once lose their colour. In a vacuum or in dry air the deep blue colour of lithium chloride has now lasted for two months without apparent change. The colour of potassium chloride gradually fades and completely disappears in about a week; the behaviour of most of the salts is like that of potassium chloride. The cause of these phenomena is unknown. The salts were as pure as could be obtained. Electrodes of different materials gave the same results. The radiation-tubes contained, of course, a little mercury vapour, but none of the known compounds of mercury with the constituents of the salts have the colours above described. Chemical decomposition is unlikely, since the coloured salt gradually changes into its original condition. The author inclines to the view that during phosphorescence the particles of the salt have been made to take up positions and motions differing from those of the unaltered substance, and that a physical modification of the salt has thus been brought about.

SOME efforts have again been made in France to overcome the air resistance which a locomotive encounters when running at a high rate of speed. *La Nature*, for October 27, contains a very interesting article by M. Max de Nansouty, descriptive of the experiments of M. Ricour, originally made in 1887. In these, inclined planes were placed in front of the engine, and by adopting this means, making the slanting planes four in three, and filling up the spokes of the wheels, the resistance was diminished by one half. This resulted in a notable increase of useful work, and an economy of ten per cent. on the coal consumption. The results are so satisfactory that M. Ricour has fitted his apparatus on forty engines belonging to the Paris-Lyon-Mediterranée Railway, for general traffic. Similar experiments were carried out in 1890 by M. Driesdout, chief engineer to the State railways, and they were of more prolonged character. The engines in this case were ran 300,000 kilometres, and by means of this apparatus they saved six to eight per cent. in coal consumption, and sometimes as high as twelve per cent. M. Max de Nansouty tells us, however, "il est vrai que le chauffeur et le mécanicien étaient excellents." A few other experiments were tried with seemingly the same satisfactory results. The main point, however, that, on an average, a benefit of four to five per cent. is obtained by the use of these inclined planes, and it is asserted that this is more than the saving obtained from locomotives with compound and other systems. If the statement be true, our locomotive superintendents had

better take heed, as nothing has yet been done in this direction. We are not told, however, how the apparatus behaves with a side wind.

WE have received a catalogue of hotanical works offered for sale by Messrs. Dulau and Co. The books refer to the anatomy, morphology, and physiology of plants.

THE *Journal* of the Sanitary Institute, vol. xv. part iii., contains the addresses delivered at the Congress held at Liverpool in September. Dr. J. F. J. Sykes contributes a report of the proceedings of the International Congress of Hygiene, Budapest.

MESSRS. BLACKIE AND SON have published the seventh part of Kerner and Oliver's "Natural History of Plants." The new part, which is just as admirable as the previous ones, concludes the section on climbing plants; and deals with erect foliage stems; the resistance of foliage stems to strain, pressure, and bending; the floral stem. It also contains the beginning of the section on the forms of roots.

"ELECTRIC Lighting and Power Distribution," by Mr. W. Perren Maycock, published by Messrs. Whittaker and Co., has reached a second edition. The book is described as "an elementary manual for students preparing for the preliminary and ordinary grade examinations of the City and Guilds of London Institute." It is profusely illustrated and clearly written, and is altogether a good introductory text-book of technical electricity.

DR. OSCAR GRULICH has prepared a history of the foundation and growth of the K. Leopoldinisch-Carolinischen Akademie der Naturforscher at Halle. The volume is dedicated to Halle University, which celebrated its bi-centenary this year. The first president of the Academy was J. J. Baier, who held the office from 1731 to 1735. Many eminent investigators have occupied the president's chair since then, and Prof. Dr. Knoblauch has held it since 1878. Dr. Grulich's book chiefly deals with the famous library and scientific collections of the Academy.

THE third volume of Sir David Salomons' "Electric Light Installations," dealing with the applications of electric energy, has been published by Messrs. Whittaker and Co. It will be remembered that the original work, "Electric Light Installations and the Management of Accumulators," was in one volume, and it was not until a seventh edition was demanded that the division into three volumes took place. The present volume is mainly concerned with the mechanical details which interest the electrical engineer, and the workmen engaged in electric installations, and to such we cordially recommend it.

*Science Progress* for November contains five articles of technical interest and importance. Dr. A. D. Waller, F.R.S., describes the state of knowledge of inhibitory phenomena; Mr. J. W. Rodger contributes the third of a series of articles on the new theory of solutions. Recent researches in thermal metamorphism are described by Mr. Alfred Harker. Mr. S. H. Burbury, F.R.S., discusses Dr. H. W. Watson's "Treatise on the Kinetic Theory of Gases" and a communication made by Prof. Tait to the Royal Society of Edinburgh, "On the Foundation of the Kinetic Theory of Gases." Finally, Prof. A. C. Haddon gives a bibliography of the ethnography of British New Guinea.

THE "Division of Microscopy" of the United States Department of Agriculture is publishing a very useful series of small manuals under the title "Food Products." The first three numbers deal almost entirely with edible and poisonous fungi, with directions for their identification, and for the culture

and preparation for the table of the edible species. They are illustrated by excellent coloured and uncoloured plates. It is a significant illustration of the wide distribution of the lower as compared with the higher forms of vegetable life, that every one of the twenty-four edible and twelve poisonous species of fungus here described is a familiar European species. The letterpress is written by Dr. Thomas Taylor, chief of the Division of Microscopy.

THE Meteorological Council have just issued a volume containing the meteorological observations made at stations of the Second Order, for the year 1890. Such observations have been published in a more or less complete form since 1865, and the present volume contains returns from sixty-eight stations, part of the information being obtained from the English and Scottish Meteorological Societies. A map shows the distribution of the stations, which are well distributed over the United Kingdom, although in some districts, especially in the West of Ireland, there appears to be difficulty in obtaining good observers. In addition to daily observations at many stations, the work contains carefully prepared monthly and yearly summaries, and a table showing the number of hours of bright sunshine for each month at those stations which are provided with sunshine recorders.

IN 1815 there was published in Philadelphia the second edition of a "Geographical, Historical, and Commercial Grammar," by William Guthrie. This edition contained an account of North American Zoology, by George Ord, which was by far the most complete and accurate that had appeared. Prof. Baird, in his work on the mammals of North America, refers frequently to this contribution to Guthrie's Geography, and his citations have helped to establish its importance. The Academy of Natural Sciences, Philadelphia, being desirous of rescuing Ord's work from extinction, determined to reprint it. After considerable difficulty, a copy of Guthrie's Geography was found, containing marginal pencil notes by Ord, on the zoological portion. This section of the book has now been reprinted, with the notes, and to it Mr. S. N. Rhoads has added an appendix on the more important scientific and historic questions involved. The reprint will be heartily welcomed by students of the systematic zoology of America.

HELMHOLTZ remarked, in the autobiographical address delivered on the occasion of his jubilee: "Many a time when the class was reading Cicero or Virgil, both of which I found very tedious, I was calculating under the desk the path of rays in a telescope, and I discovered, even at that time, some optical theorems, not ordinarily met with in text-books, but which I afterwards found useful in the construction of the ophthalmoscope." The enquiring student of the present time has no difficulty in finding optical theorems not referred to in the text-books in common use, for in most elementary manuals on optics, the sections appertaining to lenses and mirrors are treated inadequately. It ought to be recognised, however, that a thorough knowledge of lenses and mirrors is the all-important point of optics. To supply the deficiency of text-books in this respect, Prof. R. C. Bodkin has prepared a little pamphlet—"On Lenses and Mirrors, and the Automatic Image-Finder" (John J. Griffin and Sons)—in which he simplifies the study of lenses and mirrors, and deduces the construction of microscopes, telescopes, &c., from first principles. The image-finder referred to in the title is an ingenious piece of apparatus for illustrating the directions of the rays forming the image of an object.

WE do not often receive a catalogue of educational books, scientific and technical treatises, and works of general knowledge prepared for use in Chinese schools. Therefore we have

locked with unusual interest through such a catalogue received from "the well-known Chinese Scientific Book Depot, 407 Hankow Road, Shanghai." According to the title-page of the catalogue, the works described have been translated or written by Dr. John Fryer; and as there are nearly two hundred of them, covering the whole fields of natural and physical sciences, we confess to a reverential feeling for Dr. Fryer's marvellous industry and encyclopaedic knowledge. The translations are mostly based upon standard English or American educational books, and are arranged into five series. There is the "outline" series, for general reading and elementary instruction; the "handbook" series, for more advanced students; the "temperance physiology" series, the "magazine" series, adapted for school reading books; and the "Imperial Government" series, consisting of treatises, which together form a valuable encyclopaedia. As the avowed object in publishing the works is the higher education and intellectual enlightenment of the Chinese nation, we echo the hope that the use of the translations will continue to extend wherever instruction in scientific subjects is given in the Chinese language.

THE ADDITIONS to the Zoological Society's Gardens during the past week include two White-shafted Francolins (*Francolinus leucogenu*) from North-east Africa, presented by Lord Lilford; two Nilotic Crocodiles (*Crocodilus niloticus*) from West Africa, presented by Mr. J. A. McDiarmid; four Hispid Lizards (*A. ama hispidus*) from South Africa, presented by Mr. J. E. Matcham; an Australian Fruit Bat (*Pteropus poliocephalus*) from Australia; a White-fronted Amazon (*Chrysotis leucocephala*) from Cuba, purchased.

OUR ASTRONOMICAL COLUMN.

A NEW VARIABLE STAR OF THE ALGOL TYPE.—Dr. E. Hartwig announced in the middle of September that the star B. D. + 15 3311 (R. A. 17h. 53m. 36s., Decl. + 15° 8' 47" 2. 1900, was a variable of the Algol type. He afterwards determined the period to be 3d. 23h. 49m. 32s. 7. (*A. tro. Nach.* 3260). It appears, however, that Dr. S. C. Chandler discovered the character of the star's variability at the end of July, and communicated his discovery to several other observers, who confirmed it. The star was assigned the notation 6442 Z. Hercules about the middle of August, the period having previously been determined as 3d. 23h. 50m. Prof. Dunér has found that the minima follow each other at unequal intervals of forty-seven and forty-nine hours. There appears to be a secondary minimum which occurs a few hours previous to the time midway between two successive primary minima.

THE POLAR CAPS OF MARS.—Several sketches of Mars, made at the Juvisy Observatory, by M. Antoniadi, accompany a paper by M. Flammarion in the current *Comptes-rendus*. The figures show clearly the slow diminution of the snow-caps of Mars during the summer of the planet's southern hemisphere. The summer solstice occurred on August 31, and the planet was kept under observation from June 1 to November 1. The following are the results of the measures of the diameters of the cap at the south pole of Mars, on different dates:—

Date	Area in square miles	Diameter in kilometres
June 1	65	3900
" 15	50	3500
July 1	42	2520
" 15	35	2100
August 1	32	1800
" 23	15	900
September 27	11	600
November 1	5	300

THE GREAT COMET.—Prof. M. Wolff found Encke's comet upon a photograph taken on October 31, that is, a day before Dr. Cerulli's observation, noted last week (*A. S. N.* 3262). The comet has been observed by M. Perrotin, and is visible at the extreme limit of visibility of the twenty-eight-inch refractor of the Nice Observatory.

STATISTICAL ACCOUNT OF FRENCH FORESTS.<sup>1</sup>

M. DAUBREE, the Director of the French Forest Department, has recently published a statistical account, up to the end of 1892, of the French forests which are managed by that department; and as these forests, especially in the northern and central parts of France, greatly resemble those which might be grown in the United Kingdom, and of which some badly-managed examples are still to be found, a short notice of this work will be interesting to those who wish to know what are the possibilities of economic forestry at home.

The areas of the forests in question are as follows:—

	Acres.
Belonging to the State	2,691,165
" communes and public establishments (hospitals, colleges, &c.)	4,738,637
Total	7,429,802

Or 11,609 square miles, one-eighteenth of the total area of France, which is about 207,100 square miles.

No account is here taken of the private forests in France, which contain about 20,813 square miles, so that the area of all the forests in France is 32,422 square miles, or 15½ per cent. of the area of the country.

Of the 7½ million acres of forest managed by the State, 18 per cent. of the State forests and 30 per cent. of the communal forests are classed as unproductive or not stocked with trees.

A larger proportion of the State forests is unproductive because the State is constantly acquiring waste lands in order to prevent denudation of mountains by torrents, or the encroachment of sandy dunes; whilst land belonging to the communes, &c., which is not fit for reforestation, is not generally handed over to be managed by the State Forest Department.

Twenty excellent maps are attached to the report, and are differently shaded so as to show the distribution of the forest area among the different *départements*, according to ownership; mode of management (coppice, coppice-with-standards, high-forest); annual degrees of productiveness—in material (cubic metres per hectare); in money (francs per hectare)—and also in oak and coniferous timber.

From these maps and the statement which precedes them, it may be readily seen that the State forests are most extensive north of Lyons, and especially in Lorraine, Bourgogne, Isle de France, Normandy, le Bourbonnais, and that in these provinces there are scarcely any unproductive areas, which chiefly occur in the south of France. The communal forests are also chiefly in the east of France, or bordering on the Pyrenees and in Corsica; this distribution depends on political and not on natural causes, for the climate of the west of France is very favourable to forest growth, and this region contains some magnificent State forests and large areas of forests in private hands. As regards the mode of treatment, the State forests are distributed as follows:—

	Percentage of total area.
Simple coppice	25
Coppice-with-standards	29.2
" under conversion to high forest	16.8
High-forests	51.5

The simple coppice belonging to the State is chiefly situated in the south, where the State shares in the produce with certain communes, or the inhabitants have rights to fuel, which prevent any improvement in their treatment, and they are generally composed of *Quercus-Ilex*, which yields tanning bark, and firewood rather than timber.

Coppice-with-standards is applied to large forest areas bordering on Belgium, and to another series of State forests stretching from the Jura towards Paris. These forests are generally situated near large towns or the northern coal mines, and find a ready sale for their somewhat branchy timber and underwood, as building material, pit-props, firewood, &c., provided their rotations are long enough to exclude a large supply of charcoal wood, for which the demands are being gradually restricted.

A large area of coppice with standards, which is remote from large towns and the coal mines, is being converted into high forest, to increase the supply of timber as compared with firewood.

<sup>1</sup> Statistique des Forêts soumises au régime forestier. Année 1892. Extrait du Bulletin du Ministère de l'Agriculture. Paris. Imprimerie Nationale, 1893.

More than half the area of the State forests is already under the high-forest treatment, and consists chiefly of highly-productive silver-fir and beech forest in the Vosges; forests of *Pinus Laricio* and *Pinus Pinaster* in Corsica, which only yield poor returns on account of the frequency of forest fires; beech forests in Normandy with a small proportion of oak, and extensive oak forests on the Loire and its tributaries, where beech is kept subservient to the principal species. The maritime pine forests of the Landes and Gironde yield large quantities of resin and turpentine, as well as inferior timber, pit-props, &c.

The communal forests are distributed as follows:—

	Percentage of area.
Simple coppice ... ..	14.7
Coppice-with-standards ... ..	53.2
"    under conversion to high-forest ... ..	1.0
High-forests ... ..	31.1

The communal simple coppice areas chiefly supply fuel to villagers, and consist mainly of *Quercus Ilex* in the south, and of common oak and other species in the Ardennes and lower slopes of the Alps, near the villages and below the coniferous forests of the higher zones.

Coppice-with-standards is the commonest mode of management of communal forests, and is distributed chiefly in the temperate regions of hills and plains of the north-east of France, and little of this area is being converted to high-forest, as the people do not care sufficiently for the benefit of futurity to sacrifice a considerable part of their present revenues.

The high forests belonging to communes, &c., are chiefly situated in the Vosges, Jura, Alps, Pyrenees, and in Corsica, consisting chiefly of conifers mixed with beech.

Detailed tables are given regarding the yield of the forests in material and money.

Thus the production of the forests during the year 1892 was as follows:—

	State forests.	Communal forests, &c.
Wood ... ..	c. feet. 96,051,592	c. feet. 169,275,133
Cork ... ..	2,300	6,100
Bark for tanning ... ..	283,000	463,000
Crude resin ... ..	37,800	16,300
Total value	£846,144 at 25 fr. = £1	£1,321,804

The average annual production per acre of the wooded area of the forests is as follows:—

	c. feet.	s. d.
State forests ... ..	43½	9 5
Communal and other forests ... ..	37	5 10

It is evident that the State forests yield more wood, and of a better quality, than the communal forests.

Leaving out the Departments of the Seine and Corrèze, where the production in quantity of material and money is abnormally high, the areas of State forests in these Departments being inconsiderable, the forests of the Vosges head the list with an annual yield of 7.136 c. m. per hectare, equivalent to 101 c. feet per acre, and worth £1 3s. 4d.

This return is exceeded in value, though not in quantity, by the forests of the Doubs, where there is much oak grown as well as silver-fir, and the yield is 5.867 c. metres per hectare = 84 c. feet per acre, and worth £1 7s. 5d. an acre.

The productiveness in different classes of material of the different forests are as follows:—

STATE FORESTS.  
*Broad-leaved Species.*

	Percentage of yield.
Timber { Oak 20 in. in diameter and above ... ..	5
{ Do. less diameter ... ..	5
{ Other broad-leaved species ... ..	6.1
Poles ... ..	3.8
Firewood ... ..	57.1

*Conifers.*

Timber { Exceeding 20 in. in diameter ... ..	9.4
{ Less than " ... ..	5.3
Poles ... ..	0.6
Firewood ... ..	7.7

The proportions of the yield of broad-leaved and coniferous timber is as follows:—

	Percentage.
Broad-leaved... ..	77
Coniferous ... ..	23

It is noted that the broad-leaved species yield 74 per cent. of firewood, while the conifers only yield 33 per cent.

In the communal and other forests the production is as follows:—

	Percentage.
Broad-leaved ... ..	81.3
Coniferous ... ..	18.7

And the percentage of firewood in the former case is 86 per cent., whilst for the coniferous forests it is 25 per cent. These forests are less productive in timber, and especially in timber exceeding 20 inches in diameter, than the State forests, which accounts for their reduced money return.

If we omit the large sum of £99,300 spent in 1892 on planting-up dangerous mountain sides and regulating the beds of mountain torrents, and £8,400 spent on fixing shifting sands, the cost of maintenance of the whole of the productive forests referred to in 1892 was £397,080, or about 1. 2d. per acre, which must therefore be deducted from the yield of the forests to determine their net revenues per acre.

The following is a complete statement of the French forest charges for 1892:—

Establishment ... ..	£231,800
Forest schools ... ..	6,880
Works of improvement in the forests ... ..	58,000
Mountain <i>reboisement</i> ... ..	99,300
Fixing shifting sands ... ..	8,400
Working plans and fellings ... ..	16,000
Management of <i>châsses</i> which are not leased ... ..	2,000
Taxes ... ..	72,400
Law and other charges ... ..	10,000
	£504,780

Of this amount £41,268, or about 2d. an acre, is refunded to the State by the communes and public establishments for the management of their property.

W. R. FISHER.

THE PROPERTIES OF LIQUID ETHANE AND PROPANE.

A COMPREHENSIVE study of the properties of these primary hydrocarbons in the liquefied condition has been made by Dr. Hainlen in the laboratory of Prof. Lothar Meyer at Tübingen, and an account of his work will be found in the current issue of *Liebig's Annalen*. Owing to the greater ease with which it undergoes liquefaction, propane was first investigated. The hydrocarbon was obtained in a state of purity by means of the admirable method of preparation discovered in the same laboratory in the year 1883 by Kolbeinlein, which consists in heating propyl iodide with aluminium chloride in a sealed tube to 130°. After subjection to this temperature for twenty hours the tube was allowed to cool, and subsequently placed in a freezing mixture; while immersed in the latter it was found practicable to open it without danger or loss, the accumulated gas being readily transferred to a gas holder over water.

In order to determine the boiling-point of propane, the purified gas was first condensed to the liquid state in a U-tube surrounded by solid carbon-dioxide. It was then transferred to the special boiling-point apparatus by evaporation and recondensation, the last traces of impurities being eliminated by this process of repeated distillation. The special apparatus consisted of a glass tube closed at the lower end, furnished with a side tube for the entrance of the gas, and with a stopper at the open end perforated for the passage of an exit-tube and a thermometer. The upper half of the cylinder was surrounded by solid carbon-dioxide, and the lower portion was protected by a mantle of badly-conducting felt. Upon the entrance of

the gas the air was expelled by the exit-tube, and the gas which condensed in the upper portion of the cylinder collected in the lower portion. When the protecting mantle was removed the relatively warm air soon promoted ebullition, and the escaping vapour was as rapidly recondensed in the cooled upper portion of the cylinder, and fell back into the lower. If the hand were brought into the proximity of the cylinder, the boiling became most vigorous. At first propane usually boils irregularly, quiescent intervals being succeeded by almost explosive ebullition; but after a short time the formation of vapour becomes perfectly regular, and a mercury thermometer dipping in the liquid registers a temperature of  $-38^{\circ}$ . After comparison of the latter with an air thermometer, the correct temperature of the boiling-point of propane is found to be  $-37^{\circ}$  at 760 m.m. pressure.

Propane may safely be sealed in strong glass tubes after condensation by means of solid carbon dioxide, and thus preserved in the liquid state. It is a perfectly colourless liquid, but much more viscous than liquid carbon dioxide. The critical temperature was determined by use of such a tube half filled with the liquid. The tube was immersed alongside a thermometer in a bath of liquid paraffin, furnished with a suitable stirrer. Upon heating the apparatus to rot the liquid meniscus commenced to become hazy, and the distinction between gas and liquid became less and less pronounced until at  $110^{\circ}$  all trace of it had disappeared. Upon cooling, the well-known nebulosity was observed at  $102^{\circ}$ , and this temperature is considered to be a close approximation to the critical temperature of propane.

The vapour pressures of propane for different temperatures up to  $12.5^{\circ}$  were determined by enclosing a quantity of the liquefied hydrocarbon in one limb of a U-tube and dried air in the other limb, the two being separated by means of a short column of mercury. The closed apparatus was then cooled to various temperatures in suitable baths, and the vapour pressures calculated from the amount of compression of the air column. The vapour pressures for temperatures superior to the ordinary were determined by use of the Caillélet apparatus and spring manometer. The following table represents a summary of the results:

Temperature	Pressure in atmospheres	Temperature	Pressure in atmospheres
$-33$	1.8	$+1$	5.1
19	2.7	$+5.5$	5.9
15	3.1	$+12.5$	7.1
11	3.9	$+22^{\circ}$	9.0
5	4.1	$+53^{\circ}$	17.0
2	4.8	$+85^{\circ}$	35.0
		$+102^{\circ}$	48.5

The critical pressure of propane corresponding to the critical temperature of  $102^{\circ}$  is consequently 48.5 atmospheres.

Dr. Hamlen has also determined the density of liquid propane at several temperatures. It is 0.536 at  $0^{\circ}$ , 0.524 at  $6^{\circ}$ , 0.520 at  $11.5^{\circ}$ , and 0.515 at  $15^{\circ}$ , compared with water at  $4^{\circ}$ .

An investigation of the properties of liquid ethane upon similar lines naturally presented greater difficulties, on account of the further removal of its boiling-point from the ordinary temperature. The pure gas cannot be so conveniently prepared by the method of Hamlen, as the sealed tubes frequently explode with great force. It was therefore obtained by the well-known method of Gladstone and Tribe from ethyl iodide and the zinc copper couple. A mixture of ether and solid carbon dioxide is insufficient to effect liquefaction of the gas, but liquid ethylene was found to bring about the necessary reduction of temperature, which latter was measured by means of a copper-ether thermometer. Liquid ethane in the pure state is perfectly colourless.

The boiling-point of ethane was determined as in the case of propane, the upper part of the apparatus, however, being surrounded by the liquid ethylene instead of solid carbon dioxide. The ethylene was prevented from vaporising rapidly by allowing the extremely cold vapour produced by the evaporation to pass through an outer cylinder, and thus to act as a protective cold bath. The ethane was first cooled by means of ether and solid carbon dioxide before admission into the boiling-point apparatus, after which it was found to be rapidly condensed by the liquid ethylene. One end of the thermometer was immersed in the accumulated liquid instead of a thermometer. The temperature of the liquid when in regular ebullition, pro-

duced by removing the cap protecting the lower half of the cylinder, was found to be  $-89.5^{\circ}$  at 735 m.m. pressure.

Liquid ethane cannot be sealed in a glass tube without considerable danger. Hence the determinations of vapour pressure and density were effected by the use of a modified Caillélet compressing apparatus and spring manometer. The various temperatures were obtained by surrounding the narrow thick-walled glass tube in which the liquid was produced by suitable baths. The critical temperature at which the curious cloudy appearance was observed, just before the complete disappearance of the liquid meniscus, was found to be  $34.5^{\circ}$ , and the corresponding critical pressure 50 atmospheres. The meniscus becomes hazy at  $32^{\circ}$  and only disappears completely at  $40^{\circ}$ , so that the critical temperature, as in the case of propane, does not appear to be so sharp as with many other liquids of low boiling-point. The following table represents the vapour pressures for a few intervals of temperature.

Temperature	Pressure in atmospheres	Temperature	Pressure in atmospheres
$-31$	11	0	23.3
$-20^{\circ}$	14.5	$+15^{\circ}$	32.3
$-11^{\circ}$	18.3	$+34.5^{\circ}$	50

Prof. Dewar in 1884 determined the critical temperature and pressure of ethane, and gave them as  $35^{\circ}$  and 45.2 atmospheres. M. Caillélet had previously stated that at  $+4^{\circ}$  the gas exerted a pressure of 46 atmospheres. Prof. Dewar's numbers are now found to be in close accordance with Dr. Hamlen's results, and the older statement of M. Caillélet must therefore be taken as founded upon an error.

The density of liquid ethane was found to be 0.446 at  $0^{\circ}$  and 0.396 at  $+10.5^{\circ}$ .

It may be interesting to compare the facts now established with reference to ethane and propane, with those previously well ascertained for marsh gas and for normal butane.

	Boiling point.	Critical temperature.	Critical pressure.	Density in liquid state.
Methane $\text{CH}_4$	$-164$ (Olszewski)	$-81.6^{\circ}$ (Olszewski)	54.9	0.415 at $-164$
	$-161$ (Wroblewski)	$-95.9^{\circ}$ (Dewar)	50	
Ethane $\text{C}_2\text{H}_6$	$-89.5$ at 735 m.m.	$+34.5$	50	0.446 at 0
Propane $\text{C}_3\text{H}_8$	$-42.7$ at 760 m.m.	$+102$	48.5	0.536 at 0
n-Butane $\text{C}_4\text{H}_{10}$	$+0$	—	—	0.700 at 0 (Ronalds 1865)

If the above boiling-points are represented graphically along with those of the higher normal paraffins, molecular weight or the number of carbon atoms being taken as abscissa and boiling-point as ordinates, a perfectly regular curve is obtained, slightly concave towards the axis of abscissa, which very clearly indicates the dependence of the boiling-point upon the molecular weight.

A. E. TUTTON.

### THE BRITISH CENTRAL AFRICA PROTECTORATE.

MR. H. H. JOHNSTONE opened the session of the Royal Geographical Society on Monday evening with a paper on British Central Africa, of which he is administrator. He contrasted the condition of the country ten years ago with what it is now, explaining how the Mission schools, the Scottish planters, and the Sikh police had produced changes in the manners, productions, and means of transport of the whole region, and had succeeded in effectually repressing the slave trade. A survey of the Protectorate has been in progress for the last three years, and the map is beginning to acquire some firmness of outline. The great advantage of the Protectorate over the surrounding districts lies in the greater proportion of high land over low swampy country. Roughly speaking, about four-fifths of its land-surface is 3000 feet and upwards above the level of the sea, and about one-fifth is between 5000 and 10,000 feet. The immediate result of this elevation of the land is the prevalence of a much cooler climate, than is usually found in Central Africa so near the equator. There are portions of British Central Africa where the heat is never oppressive, even



in the hot season, and where in the cold season bitter frosts prevail. Unfortunately, it is impossible to reach this delectable land from the coast without traversing the hot and unhealthy valleys of the Zambezi and Shire.

There is an average rainfall of 55 inches throughout the Protectorate, but it is not altogether uniform in character, some districts receiving about 75 inches, and others not more than 35 inches. Still, it is decidedly a well-watered country, endowed with many perennial streams, only a small number of which dry up in the height of the dry season. Consequently, it is a land which can almost everywhere be irrigated during the dry season, and can thus grow a continual succession of crops. The water is almost everywhere wholesome to drink.

The great attraction of the country lies in its beautiful scenery, in its magnificent blue lakes, its tumultuous cascades and cataracts, its grand mountains, its golden plains and dark green forests. A pleasant and peculiar feature also of the western portion of the Protectorate is the rolling grassy downs, almost denuded of trees, covered with short turf, quite healthy, and free from the Tsetse fly; these no doubt will in the future become actual sites of European colonies, districts in which Europeans can rear their children under healthful conditions.

The lofty plateau of Mlanje is a little world in itself, with the exhilarating climate of Northern Europe. These plains and valleys are gay with blue ground-orchids, with a purple iris, and with yellow everlasting flowers. Here and there great rocky boulders stand up in stern relief against the velvet turf, and out of these elevated plains again rise other mountains, gloomy in aspect and remarkably grand in outline. The forests, on closer inspection, turn out to be mainly composed of the handsome conifer *Widdringtonia Whytei*.

No one has succeeded in reaching the highest summit of Mlanje. Mr. Johnston ascended about as far as 9300 feet, and, estimating that there were fully 700 feet more of ascent, approximately fixed the highest point at 10,000 feet. The ascent of this high peak is rendered very difficult by the enormous size of the boulders with which it is strewn. The whole mountain mass of Mlanje probably occupies, with its outlying peaks connected by saddles, an area of 1600 square miles, of which 200 square miles consist of these level or gently undulating plateaux, admirably suited for European settlements. Many of the salient features of Mlanje are repeated in the striking mountains of Nyasaland, with the exception of the cedars, which, however, are reported to exist on one or two of the highest peaks of Zomba, but have never been seen elsewhere.

The low plains surrounding Lake Nyasa and bordering the rivers offer a sharp contrast to the plateaux. Zebras, hartebeests, water-buck, pallah, roan antelopes, and reed-buck may be found in numbers, often dwelling gregariously together on these hot plains; and a few vultures, eagles, kites, and Marabout storks wheel and float overhead in the dazzling bluish-white sky, on the look-out for offal. The sable antelope, the eland, the kudu, and the bush-buck seem to prefer the sparsely forested hill-slopes to the flat plain, where there is usually much less cover. The rhinoceros still ranges over these plains, and wallows in the stagnant pools of the half-dried rivers. The heat prevailing on the plains in the summer-time is very great—almost overpowering—but in the winter and spring the air is exhilarating.

The British settlements have now a settled and comfortable appearance, with uniformed native policemen and trained natives from the Mission schools working as printers and even as telegraph operators at Blantyre. The most interesting feature in the neighbourhood of these settlements at the present time is the coffee-plantation, which, to a great extent, is the cause and support of their prosperity. The variety which is cultivated in the Shire highlands was actually introduced from Scotland, having been derived from a small plant sent from the Edinburgh Botanical Gardens to Blantyre about sixteen years ago. From this plant the greater part of the five million coffee-trees now growing in this part of Africa are descended, while the original mother tree is still alive in the Mission grounds at Blantyre. The climate and soil of Nyasaland would seem to suit the coffee-tree to perfection, and the crops given are unusually large. As yet Nyasaland has been free from the coffee disease, which, as in Brazil and India, does not appear to be able to penetrate far inland from the coast, though it has already committed ravages in German East Africa and in Natal.

#### EARLY BRITISH RACES.<sup>1</sup>

BEFORE proceeding to trace the early history of man in Britain, it is necessary to refer briefly to the physical changes which geologists tell us have occurred since the close of the Tertiary period in the configuration and temperature of the north-western portion of Europe.

At the beginning of the Pleistocene period, the temperature of Northern Europe became colder, and an ice-cap, like that which now covers Greenland, gradually extended itself probably as far south as Middlesex, and covered the greater part of Wales and the northern half of Ireland. This epoch is known as the Great Ice Age. At that time also the land was more elevated than now, so that Great Britain and Ireland formed part of the continent of Europe, and the western coast-line extended some three or four hundred miles further into the Atlantic Ocean than it does at present. This period of cold was succeeded by a more genial one, during which, but before the ice had disappeared, a great submergence of land and of the glaciers still upon it took place, varying at different parts of the country from 600 ft. to over 3000 ft. The climate again became colder, and on the higher parts of Wales, the North of England, and Scotland, glaciers were formed once more, but not to the same extent as formerly. Then followed, in late Pleistocene times, a re-elevation of the land to at least 600 feet above the present level, Great Britain and Ireland once more became joined to the continent, and the climate became temperate. In all probability the geographical conditions of Britain, or rather the British corner of Europe, in early and late Pleistocene times, were almost identical. Finally the land connection with the continent became severed by submergence, which went on till almost the present coast-line was reached; the sea once more rolled in over the beds of the German Ocean and the English Channel. These changes in the geographical conformation of the north-western part of Europe took place slowly, and were consequently spread over an immense interval of time.

According to some eminent geologists, man first took up his abode in the British portion of Europe, either during the early glacial or pre-glacial period. The evidence of his existence here at that early period rests upon the discovery of many flint implements of peculiar and special type on certain high chalk plateaux in Kent in drift resting on Pleistocene beds, in drift deposits of Norfolk and Suffolk, and in certain caves in which glacial drift is believed to be deposited over the flints. All these implements are of the rudest make, more or less stained, like the drift flints with which they are associated, of a deep brown colour. They show a considerable amount of wear, as though they had been rubbed and knocked about a good deal, so that the worked edges are commonly rounded off and blunt. In few instances have the implements been wrought out of larger flints, and the amount of trimming they have received is very slight, and has been generally made on the edges of rude natural flints picked up from old flint drift; indeed, sometimes the work is so slight as to be scarcely apparent; in other specimens it is sufficient to show design and object. These implements indicate the very infancy of art, and are probably the earliest efforts of man to fabricate tools and weapons from other substances than wood or bone. They give us some slight insight into the occupations and surroundings of the race who used them, as they appear to have been employed for breaking bones to extract the marrow, scraping skins, and rounding sticks and bones for use as tools or poles. From the absence of large massive implements, it would seem as though offensive and defensive weapons had not been much needed, either from the absence of large mammals, or from the habits and character of these early people. Many archaeologists are not satisfied with the evidence yet adduced as to the age of these flints, consequently of man's existence in Britain at this early date, and the question cannot be considered settled one way or other.

Whatever may be the ultimate decision as to the existence of pre-glacial man in Britain, all geologists and others are agreed that after the glacial period had passed away, and Britain had once more become a part of the continent of Europe after its submergence, a race of men known to us as Paleolithic man migrated into the country from the continent, across the valley of the English Channel, in late Pleistocene times. Man of this period is known to us from remains found in the river-drifts of

<sup>1</sup> A lecture delivered at the Royal Institution by Dr. J. G. Garson. We are indebted to Prof. E. J. Dawkins for permission to use the accompanying illustrations.

post-glacial age, and in the lower deposits of certain caves. As some evidence has been brought forward to show that the river-drift people, as they are called, are earlier than the cave-dwellers, we will consider the river-drift people first.

Remains of man from the river-drifts have only been found in the south of England from Chard, Axminster, and the Bristol Channel, in the west to the Straits of Dover, the lower Thames,

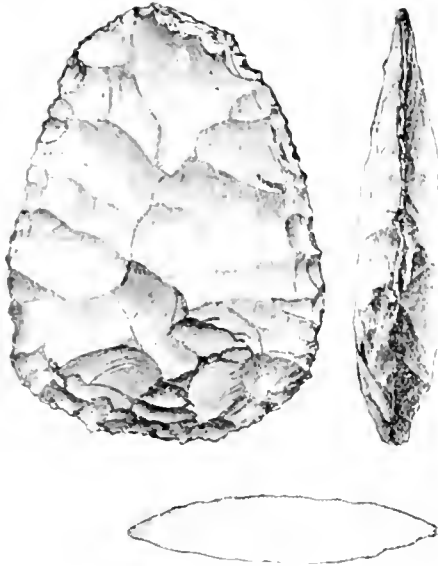

FIG. 1.

Suffolk, and Norfolk on the east, and as far north as Cambridge. They are conspicuous by their absence north-west of a line passing from Bristol to the Wash. The remains consist of a small portion of a skull, reputed to be of this period, implements of flint, quartzite, and chert, antlers of deer, and of certain fossil shells, probably used as ornaments.

The portion of skull was found by the late Mr. Henry Prigg,



FIG. 2.

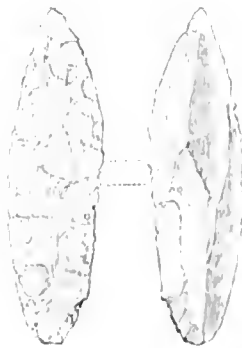

FIG. 3.

in 1882. In Westley, in Suffolk, seven and a half feet from the surface in a pocket of black earth eroded in the chalk, and in an adjoining pocket two molar teeth of mammoth and four Palaeolithic flint implements were found. The fragment of skull was part of the vertex, and included the upper portions of the frontal and parietal bones, with part of the coronal and sagittal sutures. It was examined by Mr. Worthington Smith,

and in transit to the finder of it was unfortunately smashed. As it was not a characteristic part of the skull, it shed little light on the cranial characters of its owner. With this exception, no human bones have been found in fluviatile deposits in Britain.

The implements from the river-drift consist principally of oval-pointed flints which have been fashioned by chipping, and were used without handles, oval or rounded flints with a cutting edge all round, scrapers for preparing skins, pointed flints used for boring, flakes struck off from blocks or cores by means of large hammer-stones, often of quartzite, and choppers of pebbles chipped to an edge on one side. The tools with which these implements were manufactured consisted of anvil stones of large blocks of flint, pointed flints or punches, and carefully



FIG. 4.

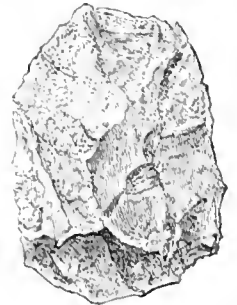

FIG. 5.

made fabricators. All the implements, though simple and rude, show signs of manufacture, the more finely finished specimens having been prepared by delicate chipping. Their manufacture seems to have been carried on at certain spots, on the banks of rivers and other places, where there was plenty of material to make them from. It will be observed that at this time there were no flint arrow-heads, and that man was but poorly equipped for the chase, although it was undoubtedly by that means he gained his livelihood. Besides these flints, man doubtless used wood and bone implements; indeed, pieces of pointed stakes of wood have been found on the Palaeolithic floors where he worked, by Mr. Worthington Smith. Reed-like fossil shells



FIG. 6.

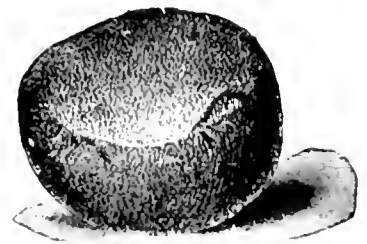

FIG. 7.

of *Coccyzina* have been found by Mr. Smith, with artificial enlargement of their natural orifices, which would indicate that they had been used for necklaces or amulets, so that primitive man seems not to have been without his personal adornments even at this time.

It is of importance to consider for a moment the animals which lived with man at this period. There are found in the same strata with him remains of the hippopotamus, two species of elephants and of rhinoceros, the cave bear and lion, the wild cat, hyæna, mus, bison, the wild horse and boar, stag, roe, reindeer, and other animals, many of which are now extinct. Man at that time had no domestic animals. The only clothing he had, if he wore any, was made from the skins of the animals he

killed in the chase and used for food. Being far from the sea, if he used fish as food, they would be such as he was able to catch in the rivers.

Let us now trace man of this period on the continent. In the fluvial deposits of the Somme and the Garonne, stone



FIG. 8.

implements have been found and recognised by such competent authorities as Sir John Evans, Mr. Franks, Prof. Boyd Dawkins, and others, as identical with the drift Palæolithic implements found in England. Similar ones have been

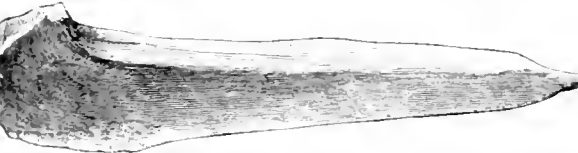

FIG. 9.

found in Spain, near Madrid, in Italy, Greece, Germany, and other places in Europe; also in Northern Africa, Palestine, and India. From these finds we learn that man has lived in a similar state of civilisation to what he did in Britain,



FIG. 10.

over a very wide area; they also show that he must have existed in this stage of culture for a very long time.

As regards his skeletal remains on the continent, a few have been found. At Canstadt, near Stuttgart, it has been stated that

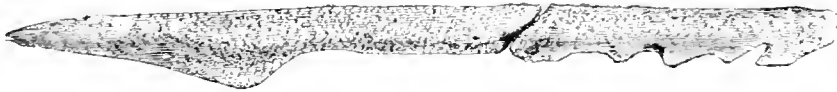

FIG. 11.

portion of a skull was discovered, in 1700, in loess deposits, with bones of the cave bear, hyæna, and mammoth. At Eguisheim, near Colmar, Schaffhausen, portion of another cranium was found with mammoth and other animal remains of this period. At



FIG. 12.

Clichy, in the valley of the Seine, a skull and some bones were found at depths varying from 4 to 5.4 metres from the surface in undisturbed strata, with mammoth, woolly rhinoceros, horse, and stag. The skull in these instances is long and narrow in



FIG. 13.

shape, with very prominent supraorbital ridges and glabella; the thigh and leg bones of the Clichy skeleton are laterally compressed, the former having a greatly developed *linea aspera*, the latter being markedly platycnemic. Further reference will

be made to these specimens when we deal with the cave skeletons.

Caverns and rock shelters are well known to have been used not only by man, but also by animals, from remote times down to the present day. The strata which have been deposited in them at different times by their successive occupants, and the vicissitudes

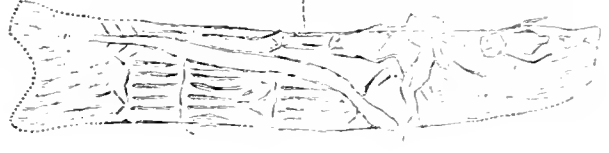

FIG. 14.

of climate, are often well marked, and give much valuable and reliable information, but great care is required in discriminating the different periods which their contents represent. The remains of Palæolithic man deposited in caves are much more

widely distributed over England than those from the river-drifts, having been found as far north as Yorkshire and Derbyshire, in North and South Wales, Gloucestershire, Monmouthshire, Somersetshire, and Devonshire, also in Ireland, although these

latter have not been much worked. The Palæolithic cave strata shows three sub-strata; in the two lower ones the flint implements are precisely similar to those of the river-drifts, but flat pebble implements of quartzite are also found with part of the

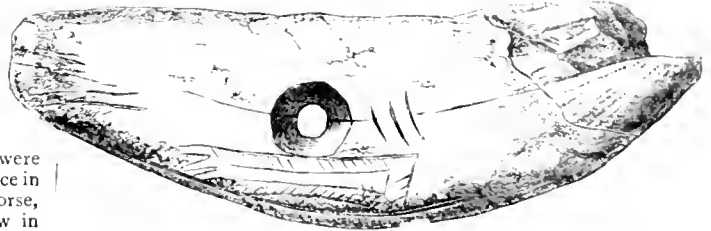

FIG. 15.

natural smooth surface retained, while the rest is chipped and fashioned into an implement.

In the upper substratum more highly finished articles, which would point to a higher and probably a different social condition, later in time, are obtained. We have in this higher substratum flints of oval and lanceolate form, trimmed flakes, borers, and rounded hammer-stones (Figs. 1, 2, 3, 4, 5, 6, and 7). These are of smaller size than the earlier implements, and some of them had evidently been let into handles of wood. Bone needles, with an eye bored at one end (Fig. 8), bone awls (Fig. 9), scoops (Fig. 10), and harpoons (Figs. 11 and 12, barbed on one or both sides of deer's antler, are also met with. Of great importance are the representations of animals which have been found incised on bone, as, for example, the

portion of it, with the incised figure of a horse upon it, found in this layer in R. in Hood Cave in Derbyshire (Fig. 13).

Specimens of the human skeleton have been found in the Palæolithic stratum of British caves, except a single tooth.

On the continent many caves have been discovered in France, Belgium, Germany, and Switzerland, with similar deposits and implements to those found in England, and showing also the same two stages of culture. More numerous examples of figure carving of the same type as that found in the Derbyshire cave have been obtained in French caves (Fig. 14), and the teeth of carnivorous animals and shells, both artificially bored for ornaments (Fig. 15).

By associating British and continental evidence we can form a good idea of the mode of life of the cave-dwellers of Palæolithic times. The caves gave him shelter in cold weather, from which he further protected himself by fires, and clothing made from the skins of animals he secured in the chase, sewn together by means of bone needles and tendons of reindeer for thread. Armed with flint-tipped spears and daggers of bone ornamented with carved handles representing the chase, he lived by hunting the reindeer, the wild horse, and the bison; he also lived on birds and fish, which he speared with barbed harpoons. The game he brought home was cut up with flint knives, and cooked; the long bones were broken with heavy flints for the marrow they contained, which was evidently considered a delicacy. When not engaged in the chase, the manufacture of flint implements must have formed an important part of his home work. He must also have spent much time in carving ornaments on bone. These, it may be remarked, show that he was an artist of no mean order in depicting animals, but give us little information regarding his own form, as he seldom represented himself, and when he did he figured himself in miniatures and naked (Fig. 14); they also show that he was in the habit of wearing long gloves to cover his hands and arms (Fig. 15). Besides ornamenting himself with perforated shells, pieces of bone, ivory, and teeth, he probably painted his body of a red colour. He, like the river-drift people, possessed no domestic animals, and had no dog to assist him in hunting.

(To be continued.)

### UNIVERSITY AND EDUCATIONAL INTELLIGENCE.

COMMUNICATED. Dr. J. Lorrain-Smith has been appointed Lecturer on Pathology, in the place of Mr. L. Cobbett, who has been elected to the John Lucas Walker Research Studentship.

An Extra Newton Studentship in Astronomy, worth £200 a year for three years, will be vacant in the Lent Term. Candidates for the B.A.'s under the age of 25 on January 1, 1895. Names of candidates are to be sent to the Vice-Chancellor by January 1, 1895, with a statement of the course of study or research proposed.

At the biennial election to the Council of the Senate, held on November 7, Dr. Peck, Mr. C. Smith, Dr. Matland, Dr. Selwyn, Dr. D. Macdowell, Dr. Forsyth, Mr. Whitting, and Mr. E. L. Wright were returned for a period of four years.

Dr. Donald Macdowell was, on November 9, elected without opposition to represent the University on the General Medical Council for a second term of five years.

This year has been memorable as the twenty-first anniversary of the establishment of the University Extension Lectures, the system having been founded by the University of Cambridge in the year 1873. The twenty-first annual report of the Cambridge Syndicate has just appeared. During the past session seventy-five seven courses have been delivered at various centres. The number is less than those of the last two or three years, the distribution being distributed almost entirely to the centre in the temporary work undertaken by the Syndicate during the present year. The technical instruction in traction consisted of various University Councils. Whereas in some places the assistance of the local authorities has enabled local lecturers to arrange more easily courses of University Local Lectures, in other places, with the cheap technical instruction provided by the local authorities, have not been able to do so. The influence of the local lecture movement is, therefore, not so general as it is in some of the County Councils.

Councils are just beginning to feel their feet, but it seems ungenerous of them to forget that they were helped over their initial difficulties by University Extension Lectures. The Technical and University Extension College at Exeter, which is under the joint management of the local authorities and the Cambridge Syndicate, has now completed its first session's work, and about six hundred regular students have already joined the College. Its success affords a striking illustration of the method by which under the Local Lectures system permanent educational institutions can be established. It should not be forgotten that the Cambridge University Extension movement was similarly largely instrumental in the foundation, a few years ago, of University College, Nottingham, Firth College, Sheffield, and other local colleges.

THE *London Technical Education Gazette*, the first number of which has just been published, is intended to contain the official announcements of the Technical Education Board of the London County Council; notices of important steps in technical education taken by the various institutions in London; and useful information bearing upon the work. In the list of the conditions which have to be fulfilled by evening classes in science, in order to obtain grants from the Board, we are glad to note the following:—"That as a condition of aid being granted by the Board for the teaching of chemistry, metallurgy, physics, mechanics, and botany, it will be regarded as indispensable that provision should be made, to the satisfaction of the Board, not only for the experimental illustration of the lectures or class teaching, but for experimental work by the students themselves, either in laboratories belonging to the institution, or, where this cannot be arranged, in the laboratories of some neighbouring institution with which the class should be associated; and every lecture must be followed by at least one hour's practical work on the same evening, or some other evening in the same week."

### SCIENTIFIC SERIALS

*Wiedemann's Annalen der Physik und Chemie*, No. 11.—Experimental researches on the origin of frictional electricity, by C. Christiansen. Friction by itself does not generate electricity. The appearance of the latter is due to chemical decompositions which are initiated by contact and completed on separation. These results are those of experiments with a tube coated on the inside with various insulators, arranged so that mercury could be brought into contact with them and withdrawn, after which a charge was indicated by a galvanometer.—On thermocouples of metals and saline solutions, by August Hagenbach. In the case of couples consisting of metals and their salts, the E.M.F. increases with the dilution, and more rapidly than the difference of temperature. In combinations of platinum with hot and cold saline solutions the same acids give about the same forces, and differences of concentration have a very marked influence. The highest E.M.F. obtained was that of a platinum-cupric-chloride couple, which, with a 5.6 per cent. solution, and with the two communicating portions of the liquid at 25° and 80° respectively, gave an E.M.F. of 0.1541 volts.—Changes of length produced by magnetisation in iron, nickel, and cobalt ellipsoids, by H. Nagaoka. The optical lever method was employed. As the field intensity increases, iron first expands and then contracts, going through the opposite stages on reversing, and showing a decided hysteresis. Nickel simply contracts. Cobalt contracts first and then expands, the expansion increasing to a limiting value as the field intensity increases.—On elliptically-polarised rays of electric force, and on electric resonance, by L. Zehnder. The author shows how to produce circularly and elliptically polarised electric rays by two wire gratings placed one behind the other, with the directions of wires crossed.—On refraction and dispersion of rays of electric force, by A. Garbasso and E. Aschkinass. To produce a prism capable of affecting ether waves of the length of those due to Hertzian oscillations, a prism was constructed of a series of parallel glass plates, upon which were stuck "resonators" made of strips of tinfoil. This was placed between an exciter and a suitable resonator. It was found that the rays were refracted by angles differing according to the wave-length. The deviations for three different resonators were 9° 6', 7° 18', and 5° 24' respectively.

SOCIETIES AND ACADEMIES.

LONDON.

Physical Society, October 26.—Prof. A. W. Rucker, F. R. S., President, in the chair.—The meeting was held in the rooms of the Chemical Society, Burlington House.—In opening the proceedings the President said the occasion might be regarded as another sign that the boundary between Chemistry and Physics was breaking down. On behalf of the Council he tendered the thanks of the Physical Society to the Chemical Society for the use of the rooms.—Prof. H. E. Armstrong, President of the Chemical Society, said his Council offered a cordial welcome to the Physical Society. The change, he thought would prove of much greater importance than a mere removal. Now that the childhood of the Physical Society was passed, its manhood involved new responsibilities, and great opportunities for good presented themselves. The Physical Society of London ought now to become the head-centre of physics in the United Kingdom. He (Dr. Armstrong) was pleased to learn that the Society had undertaken the preparation and publication of abstracts of physical papers appearing in foreign periodicals, and said the matter was of such great importance that it should be done thoroughly. In a work of such a magnitude, he regarded the co-operation of other societies, such as the Institution of Electrical Engineers, as absolutely necessary.—The President, in acknowledging the welcome, said the Physical Society was extremely obliged to the President and Council of the Chemical Society for the great benefits conferred. Dr. Armstrong's advice to go ahead would not be forgotten. He then announced that at future meetings tea would be provided for members at 4.30.—The exhibition of a voltmeter by Mr. Naber was postponed.—Mr. E. H. Griffiths read a paper on the influence of temperature on the specific heat of aniline. After pointing out that most observations of specific heat depend on water, whose capacity for heat varies considerably with temperature, the author said large differences existed between the values obtained by different observers as the latent heats of evaporation of water and other liquids, and these differences were probably due to the variability of the water standard, which had been erroneously assumed constant. Precise measurements in calorimetry were of such great importance that the exact relation between the capacity for heat of water and its temperature should be completely determined. With apparatus such as he had used with aniline, this could be done in six months, provided someone could be found who could devote his whole time to the subject. The results of his own experiments were expressed in terms of the capacity for heat of water at 15° C. (at which  $J = 4.198 \times 10^7$  ergs.), and hence were referred to a definite standard. A great desideratum in calorimetric work was a calorimeter whose surroundings could be kept at a very constant temperature. This he had obtained by using a tank holding about 20 gallons of water, in which a steel vessel, shaped like a hat-box with hollow sides and bottom, was immersed. The cavity was filled with about 70 pounds of mercury, and served as the bulb of a thermometer; a tube communicating with this bulb acted as a regulator to control the gas supply which heated the water in the tank. The tank water was circulated rapidly by a screw-propeller. Under ordinary conditions the temperature of the outside of the steel chamber could be kept constant within 1/100° C. The calorimeter itself was of brass, and suspended by glass tubes from the lid of the steel chamber. A stirrer worked by an electromotor kept the contents in rapid motion. In the experiments on aniline, heat was supplied to the liquid in the interior by maintaining known potential differences (equal to some multiple of the E.M.F. of a Clark's cell) between the ends of a coil of German silver wire placed inside. The rate of rise of temperature of the inside over the outside was measured by platinum thermometers, one of which was placed in the calorimeter, and the other embedded in the walls of the steel vessel surrounding the calorimeter. By this means differences in temperature of 1/1000 of 1° C. could be detected with certainty. A special method of adjusting the potential difference between the ends of the German silver wire was employed, by which the constancy could be maintained within 1 part in 10,000. To minimise corrections arising from heat generated by stirring the liquid, and that lost by radiation, &c., from the calorimeter, the experiments were made at temperatures at which these corrections balanced each other; the rise of temperature was then due to the electric supply alone. The

specific heat,  $S_1$  of the liquid at temperature  $\theta_1$  could then be determined from the formula

$$\frac{d\theta_1}{dt} = \frac{E^2}{JR_1 \overline{S_1 M} + w_1}$$

where  $\frac{d\theta_1}{dt}$  = rate of rise of temperature at temperature  $\theta_1$

- J = mechanical equivalent of heat,
- E = potential difference between the ends of the coil,
- $R_1$  = resistance of the coil,
- M = mass of liquid,
- and  $w_1$  = water equivalent of calorimeter at temperature  $\theta_1$ .

Experiments were made with different values of E, and two widely different masses of liquid were used. The author was thus enabled to find  $S_1$  without knowing  $w_1$ . Having found  $S_1$ , the water equivalent of the calorimeter could then be determined. Many important details of construction and manipulation of the apparatus, as well as the method employed in reducing the results, are given in the paper. The final values for  $S_1$  and  $w_1$  at several temperatures are given below.

Temperature.	Specific heat of aniline.	Water equivalent of calorimeter.
15° C. ... ..	0.5137 ... ..	79.82
20 ... ..	0.5155 ... ..	80.11
30 ... ..	0.5198 ... ..	80.90
40 ... ..	0.5244 ... ..	82.19
50 ... ..	0.5294 ... ..	83.39

The aniline employed was supplied by Messrs. Harrington Bros. as "pure colourless," but had initially a light brown tinge. After being in use some time, the colour had darkened considerably, but its specific heat had not sensibly changed. Recently he had tried a hydrocarbon liquid which promised to be still more satisfactory as a standard liquid in calorimetry. In the course of his remarks the author said a name for "capacity of heat per unit volume" was greatly needed, and invited suggestions. Dr. Armstrong thought the author had made a particularly happy selection in aniline, for it could now be obtained in any quantity absolutely pure. When pure it did not discolour on exposure, and would probably be very satisfactory as a standard liquid. He doubted whether any hydrocarbon could be better. Prof. Ayrton congratulated the author on the extreme accuracy obtained. Recently he had arranged an experiment for determining the mechanical equivalent of heat by the electrical method, which gave very accurate results without any corrections whatever being necessary. Prof. S. P. Thompson thought the whole phraseology of specific heat required revising. Prof. Perry agreed with Mr. Griffiths that a name for "capacity for heat per unit volume" was greatly needed, and Mr. Lucas suggested "heat density," but this was not satisfactory. Dr. Sumpner said most text-books on physics attributed the advantage of the mercury thermometer to the low specific heat of mercury, whereas the capacity for heat per unit volume was the important factor. Mr. Watson inquired to what temperature the alloy which the author had used to connect glass to metal had been tested? The President said the paper was of great importance because it dwelt with the application of electrical methods to thermometry. The mercury thermometer had been quite superseded for work such as had just been described. Mr. Griffiths, in reply to Mr. Watson, said the alloy had been used successfully between 10° and 62° C. It gave way at 71° C. He was glad to learn from Dr. Armstrong that aniline could now be got pure. Prof. Ramsay had written to say he did not think the slight impurities in ordinary aniline would have much effect on its specific heat. Mr. Blakesley asked if aniline could be taken as pure if it did not change colour on exposure. Dr. Armstrong, in reply, said yes, if the boiling point was also constant.

PARIS.

Academy of Sciences, November 5.—M. Lœwy in the chair.—On an apparatus serving to demonstrate certain consequences of the theorem of areas, by M. Marcel Deprez. This is an apparatus designed to show that a body passing freely through space may rotate on its own axis without suffering the application of any exterior force, such rotation being produced by interior movements of parts of its system.—On the theorem of areas, by M. P. Appell.—On the theory of flow for a weir with depressed or partly submerged liquid sheet, in the case where a horizontal armature gives the inferior maximum contraction, by M. J. Boussinesq.—On the vaporisation of carbon, by M. Henri Moissan. The heat of the electric furnace enables

carbon is always deposited under the form of graphite at ordinary pressures, and there is no evidence whatever of the liquefaction of the carbon, for instance the lid of a carbon crucible did not adhere when the whole mass had been converted into graphite, and a carbon needle heated in a carbon tube did not in any case become attached to the latter. Previous experiments have, however, shown that under great pressures carbon may be fused, and diamonds then formed.—New observations on the menhirs of the Mendon woods, by M. Berthelot.—Note by M. Maurice Levy accompanying the presentation of his "Study of the mechanical and electrical methods of traction of boats." The author gives a short account of the contents of the first volume of his work dealing with cable traction only.—M. Bonquet de la Goye, in the name of the Bureau des Longitudes, presented the "Connaissance des Temps" for the year 1897. This volume contains, on the maps of solar eclipses, the curves passing through the points on the earth at which the commencement and end of the eclipse are simultaneous. The ecliptic elements of the great planets and their satellites, including their elongations and the elements of Saturn's ring, are also given.—Observations of the new planet BE, made at Paris Observatory, by M. G. Bigourdan.—The polar snows of Mars, by M. C. Flammarion (see "Our Astronomical Column").—Relations between the vapour pressures of a body in the solid and in the liquid state; influence of pressure on the temperature of fusion, by M. A. Ponsot.—Influence of form on the sensitiveness to light and aberration of the eye, by M. Charles Henry. Researches on mercuric nitrates, by M. Raoul Varet. The heats of formation are determined. In the dissociation of mercuric nitrate by water the least endothermic of the possible reactions is the one that takes place. Nitric acid, like sulphuric, picric, acetic, and oxalic acids, is displaced completely from mercuric combinations by hydrochloric and by hydrocyanic acids.—On the campholenic acids and the campholenamides, by M. A. Behal.—On the presence of methyl salicylate in some native plants, by M. Em. Bouquet.—On the formation of new colonies by *Termes lactarii*, by M. J. Perez.—The defence of the organism against parasites among insects, by M. I. Cucnot.—External characteristics of chydroids of the vine, by M. A. Prunet.—On a mycobacterial disease of *Tricholoma terreum*, by M. Paul Vuillemin.—Inference of "Salarien" as a name for the last geological period, by M. Mayer Eymar.—On the presence and distribution of glycogen in tumours, by M. A. Brault.

BERLIN.

Meteorological Society, October 9.—Prof. Hellmann, President, in the chair.—After the President had dwelt on the loss sustained by meteorology owing to the death of von Helmholtz, Dr. Schwalbe spoke of his own endeavours to utilise for scientific purposes the curves of temperature obtained from the "Mannheim" pillars. He found among the many meteorological pillars in Berlin which had given continuous records during the years 1852 and 1893, very few whose readings corresponded with those of control instruments. Taking the month of July for each year, he had endeavoured to arrive at the mean daily temperature by taking the mean of the temperatures registered every hour of each day in the month. He found this mean temperature to be between the values of the expression  $\frac{6+2+10}{3}$

and  $\frac{7+2+10}{4}$ .—Dr. Kassner had instituted observations during the year on cloud waves, to which, since Helmholtz's researches on the formation of waves when two layers of air of different density and travelling with different velocity move past each other, meteorologists have devoted very special attention. From these it appears that the above form of cloud, consisting mostly of cirrus and cirro-stratus, usually causes depression. The speaker expressed the wish that thorough and continuous observation of this phenomenon might be made in order to test it.

BOOKS, PAMPHLETS, and SERIALS RECEIVED.

1. *Lehrbuch der Physik*, von J. F. F. Müller. 2. *A Treatise on the Theory of Heat*, by H. P. G. and J. P. G. 3. *Electric Light*, new edition (Whittaker).—*Electric Light Installations*, by Sir D. Salmons, Vol. 2. Application, 2nd edition (Whittaker).—*Forest Birds, their Haunts and Habits*: H. F. Witherby (K. Paul).—*By Order of the Sun to Chile to see his Total Eclipse*, April 17, 1893: J. J. Aubertin (K. Paul).—*The Vaccination Question*: A. W. Hutton (Methuen).—*Reports from the Laboratory of the Royal College of Physicians*, Edinburgh, Vol. 5 (Edinburgh, Clay).—*Dr. William Smellie and his Contemporaries*: Dr. J. Glaister (Glasgow, MacLehose).—*The Dawn of Civilisation*: G. Maspero, translated by M. L. McClure (S. P. C. K.).—*Preparatory Physics*: Prof. W. J. Hopkins (Longmans).

4. *PAMPHLETS*—*The Maya Year*: C. Thomas (Washington).—*Tableau Métrique de Logarithmes*: C. Dumesnil (Paris, Hachette).—*On Pedal and Antipedal Triangles*: A. S. Ghosh (Calcutta, Patrick Press).—*Weismannism once more*: H. Spencer (Williams and Norgate).—*On the Use of Detached Coefficients in Elementary Algebra*: J. D. Paul (Bell).—*Pearl and Shank Fisheries of the Gulf of Manaar*: E. Thurston (Madras).—*Die Temperatur*: Dr. A. E. Forster (Wien, H. Holz).—*Mean Density of the Earth*: E. D. Preston (Washington).—*Analytische Theorie der organischen Entwicklung*: H. Driesch (Leipzig, Engelmann).—*Das Verhältnis der Philosophie, &c.*: D. Wetterhan (Leipzig, Engelmann).—*Gedächtnisrede auf Hermann von Helmholtz*: Th. W. Engelmann (Leipzig, Engelmann).—*Grundzüge der Mathematischen Chemie*: Dr. G. Heim (Leipzig, Engelmann).—*Verhandlungen der Deutschen Zoologischen Gesellschaft auf der vierten Jahresversammlung zu München, den 9, bis 11, April 1894* (Leipzig, Engelmann).

5. *SERIALS*.—*Science Progress*, November (Scientific Press, Ltd.).—*Scientific Koll—Climate: Baric Condition*, No. 6 (Castle Printing and Publishing Company).—*Medical Magazine*, November (Southwood).—*Zeitschrift für Physikalische Chemie*, xv. Band 2. Heft (Leipzig, Engelmann).—*Imperial University, College of Agriculture, Bulletin* Vol. 2, No. 2 (Tokyo).—*Memoirs and Proceedings of the Manchester Literary and Philosophical Society*, Vol. 8, No. 3 (Manchester).—*Himmel und Erde*, November (Berlin).—*American Journal of Science*, November (New Haven).—*Engineering Magazine*, November (Tucker).—*Journal of the Sanitary Institute*, October (Stanford).—*Portfolios of Photographs: Beautiful Britain*, Art Series, No. 1. (Werner Co.).—*Journal of the Asiatic Society of Bengal*, Vol. lxvii. Part 2, No. 2 (Calcutta).

CONTENTS.

PAGE

Historical Exposition of Mechanics. By Prof. A. G. Greenhill, F.R.S. . . . . 49

Newth's Inorganic Chemistry. By M. M. Pattison Muir . . . . . 52

Our Book Shelf:—

Porro: "Astronomia Sferica. An Elementary Treatise" . . . . . 53

"The New Technical Educator."—N. J. L. . . . . 53

Hooker: "Index Kewensis Plantarum Phanerogamarum" . . . . . 54

Hardwicke: "Alpine Climates for Consumption" . . . . . 54

Letters to the Editor:—

"Acquired Characters."—Prof. E. Ray Lankester, F.R.S.; Prof. Edward B. Poulton, F.R.S.; Francis Galton, F.R.S. . . . . 54

Science Teaching in Schools.—W. B. Crump; Grace Heath . . . . . 56

Italian Scientific Expedition to Monte Rosa.—Dr. Piero Giacosa . . . . . 57

Chinese Beliefs about Caves.—Kumagusu Minakata . . . . . 57

Spots over Dogs' Eyes.—Worthington G. Smith . . . . . 57

Gravitation. Dr. J. Joly, F.R.S. . . . . 58

Homogeneity of Structure the Source of Crystal Symmetry. Wm. Barlow . . . . . 58

The Present State of Physiological Research . . . . . 60

Ink Crystals. (Illustrated.) . . . . 60

Notes . . . . . 61

Our Astronomical Column:—

A New Variable Star of the Algol Type . . . . . 64

The Polar Caps of Mars . . . . . 64

Lincke's Comet . . . . . 64

Statistical Account of French Forests. By Prof. W. R. Fisher . . . . . 64

The Properties of Liquid Ethane and Propane. By A. E. Tutton . . . . . 65

The British Central Africa Protectorate . . . . . 66

Early British Races. (Illustrated.) By Dr. J. G. Garson . . . . . 67

University and Educational Intelligence . . . . . 70

Scientific Serials . . . . . 70

Societies and Academies . . . . . 71

Books, Pamphlets, and Serials Received . . . . . 72

THURSDAY, NOVEMBER 22, 1894.

PSYCHOLOGY OF MENTAL ARITHMETICIANS AND BLINDFOLD CHESS-PLAYERS.

*Psychologie des Grands Calculateurs et Joueurs d'Échecs.*

Par Alfred Binet. (Paris: Hachette and Cie., 1894.)

WHOEVER may hereafter write about mental imagery will be imperfectly equipped for his task unless he has mastered the contents of this curious and instructive volume. It analyses the mental processes of two groups of remarkable men—those who possess extraordinary powers of mental arithmetic, and those who are capable of playing eight or more games of chess, blindfold and simultaneously. The idea of making the inquiry is due to the late Prof. Charcot; its prosecution has been conducted almost wholly by M. Binet, and principally at his laboratory in the Sorbonne. The prosecution of such an inquiry with the accuracy needed by modern psychology is exceedingly difficult, and it is also very difficult to express such results as may be obtained from it, in unambiguous language. The author has, however, succeeded in the latter as well as in the former, and he has framed many happy turns of expression which will contribute to the much desired evolution of psychological language.

The book begins by quoting the series of historical cases of mental arithmeticians, that was published by Scripture in 1881, in the *American Journal of Psychology*. They suffice for making useful generalisations, though few of the cases were tested with much precision. Then the original work commences. It refers to two remarkable calculators, who are now living, both of about the age of twenty-six, but whose mental processes entirely differ in their most obvious characteristics. The one is Inaudi, a Piedmontese, who performs his mental sums wholly, or almost wholly, by imagined sounds, *one, two, three, &c.*: the other is Diamandi, a Greek, who attains the same end almost wholly by imagined figures, as 1, 2, 3, &c. The careful testing of these two men, and the analyses and comparisons of the results, show the strange unlikeness of human minds in the above well-marked features, accompanied, it may be, with a nearer likeness in those deeper and more obscure qualities, which are exceedingly difficult to grasp. I, myself, had the pleasure of testing Inaudi at my own house, in company with a few scientific friends. Even the small number of experiments that there was then time to make, rendered it clear to my own mind that the conclusions which had been arrived at, after prolonged and careful experiments in France, were quite justified, namely, that he performs his long sums almost wholly by his auditive imagination, supplemented possibly by the motive, or gesture sense, but that the visual form of imagination was practically absent during the calculations. His case is an extremely rare one, and proportionately valuable for study. On the other hand, Diamandi is an excellent example of the common type of mental calculators, who work almost wholly by the visual imagination. A comparison between the achievements of Inaudi and

Diamandi under similar tests, is the main feature of the first half of Binet's volume. He succeeds in distinctly negating the assertion that the visual memory, even of a man who is so exceptionally gifted in that way as Diamandi, resembles actual vision either in its accuracy or in its completeness. Thus if a small square table of twenty-five figures, five figures in breadth and five in height, is shown to and learnt by Diamandi, he takes only nine seconds to repeat them in successive lines, but if he is asked to repeat them in the order of the columns, he is just four times as long in doing so, whether the columns are mentally read from their tops downwards, or from their bottoms upwards. He does not therefore read the figures as if they were written on a mental blackboard, which could be done as easily in any one direction as in any other, but he has, in some obscure way, to puzzle the figures out. When another table of twenty-five figures is taken, in which the figures are variously coloured, Diamandi's power of re-presenting colours being about as strong as that of re-presenting form, he has no difficulty in learning them, but he does it by two successive operations, first learning the figures and then the colours, and he is consequently twice as long over his task. This could hardly be the case if the visualised schedule had the completeness of an "after-image" or of a photographic plate.

A great difficulty in the way of testing the power of the memory of professional calculators is caused by their habit of accumulating large stores of mnemonic helps, which produce results that simulate those of a direct memory. It is indeed difficult for any one to free himself wholly from the use of such helps, which arise unbidden, more or less consciously, certain runs of figures, or accidents of position in the page, being more readily fixed in the memory than others. Binet's chapter on this subject is very instructive.

The most famous calculating boys had their calculating faculties developed very early in life. Many began to calculate of their own accord before they could read or write, and for the most part they were born in humble circumstances. It is found, so far as present information goes, that they did not inherit their gifts, except in a few cases, of which the Bidder family is a conspicuous instance. For my own part, I hesitate for awhile to accept the above negative result as a fact, and on the following grounds. Two mental peculiarities have to concur in the making of a calculating boy: the one is a special capacity for mental calculation, and the other is a passion to exercise it. Both of these peculiarities are rare, and they are not necessarily coordinated, therefore the chance of their concurrence in full force may be very small indeed. I have, however, reason to suppose that the capacity for mental calculation is more common than is usually believed, but that it does not commonly interest its possessor, and may even be unknown and consequently neglected by him. Trustworthy evidence for or against its hereditary transmission could hardly be obtained under these conditions. I may quote the case of a deceased lady of remarkable ability, which I indirectly verified to my own satisfaction at the time. She told me, and her husband confirms my recollection, that one night, while travelling to the south of France, she could not sleep; so she

amused herself, as is common on such occasions, with various idle trains of thought. Then it occurred to her to try mental sums, and finding, much to her surprise, that she had great facility in doing them, she became interested and exerted herself to the utmost. Before her train had reached Lyons, she had successfully multiplied one series of eleven figures into another series also of eleven figures. She subsequently trained herself to multiply fifteen figures into another fifteen. I am informed that her first attempt at the latter had one error, and, on being told that it was not correct, she went over it again mentally and gave the correct result. Another case comes to my memory. It appears that there was a craze for mental arithmetic in the period 1820-30, or thereabouts. My father was interested in the subject and made experiments on many friends and on all his servants, with the result, as I used to hear, that the best performer of all, and a really remarkable one, was a somewhat obtuse and uninteresting servant girl. She took no especial pleasure in calculation, and on that account would never have made a study of its processes by herself; nevertheless, she had the capacity for using them. An innate passion for arithmetic, such as all the great calculators possessed, is certainly uncommon. If only a moderate passion for it should exist, it is likely to become repressed by circumstances, because it is nearly useless to the possessor. It is difficult to imagine that anyone who was not fascinated by figures would devote the best part of his time and energy to them. Professional calculators are said to be usually (by no means always, narrow-minded, and to have their heads filled with mnemonic contrivances.

I may be permitted to allude to an inquiry analogous to that which has here been made into the visual and auditive imaginations, which I made on myself, on a small scale, in respect to the olfactive imagination. I tried to perform mental arithmetic, not by imaginary visual symbols, or by imaginary sounds, but by imaginary smells. As sums are set in the two former cases, either in really visible symbols or in really audible sounds, while the results are reached through imaginary ones, so in my experiment the sums were set in real odours, and were worked out through imaginary odours. I described the result briefly, not many months ago, in the *America in Psychological Review*, and think the inquiry worth repetition, especially by experimenters, who may possess the power of re-presenting odours to themselves more vividly than I have. It would enable them to perceive the processes gone through in mental arithmetic from a new point of view. My apparatus consisted of glass tubes, each drawn to a nozzle at one end like a short syringe. One end of a piece of india-rubber tube, six or eight inches long, was pushed tightly over the other end of the glass. A different odorous substance, camphor, carbolic acid, gasolin, &c., was inserted and packed lightly with cotton wool in the several tubes, whose ends were afterwards tied up. On grasping one of these tubes tightly, at the moment when its nozzle was brought to the nostril, a whiff of its peculiar odour was ejected and simultaneously sniffed up. This could be rapidly repeated three or four times without much diminution of the odour of the whiff. (An arrangement with valves would

have much improved its action, by ensuring that no air should be ejected that had not passed through the scent.) I thus possessed a set of tubes that could be used *smellingly*, in the same way as the symbols 1, 2, 3, &c., are used visually, or the words *one, two, three, &c.*, are used audibly. This is not the place to enter into further details. I only desire to emphasise one fact which the experiment taught me, namely, the existence of a large substratum of mental work that my power of introspection failed to penetrate. I progressed far enough to be able to add or subtract small sums, so that a 1 followed by a 2, both in smell language, associated themselves at once with the imaginary sniff of a 3, whenever I was engaged in addition, or with that of a 1 when I was engaged in subtraction. But the two associations of 3 and 1 never clashed; they were mutually exclusive. I could not ascertain through introspection what was the nature of the *attitude of mind* which determined whether the association was to be the one needed for addition or for subtraction, for division or for multiplication. Another point that strongly impressed me was the enormous amount of labour that must have been gone through by all of us in thoroughly learning the multiplication table. I made a very few similar experiments with the gustatile or taste-imagination, but they were troublesome, and I did not follow them up.

There is little room now left to speak of the latter half of Binet's volume, which refers to the great chess-players, who play eight or more games blindfold and simultaneously. The evidence is overwhelming that the faculty of visualising is not exercised by them in the same sharp and distinct way that it is commonly supposed to be. They do *not* see the chessmen and the complete board all at once and with clear definition, but they commonly see all besides the portion they are considering, more or less vaguely, and they appreciate the positions of the men as hidden centres of forces. Two letters, which close the volume, by the distinguished chess-players Goetz and Tarrasch, seem to me models of exact introspection and of clear description.

FRANCIS GALTON.

#### THE COLLECTED WORKS OF OLBERS.

*Wilhelm Olbers, sein Leben und seine Werke.* Im Auftrage der Nachkommen herausgegeben von Dr. C. Schilling. Erster Band, Gesammelte Werke. xix. + 707 pp. 8vo., with portrait. (Berlin, 1894.)

GERMANY has not produced as many amateur astronomers as England has, but among them the man whose complete writings have now been published occupies a most remarkable place. Olbers was an amateur, but his work was that of a professional astronomer. Though occupied all day in the extensive practice of a physician, he devoted his nights to searching for comets, making micrometric observations of these bodies, whether found by himself or others, with the annular micrometer, an instrument the immense value of which he was the first to perceive, and computing their orbits by the simple method devised by him, which he is said first to have applied practically while watching at the bedside of a patient. At the top of his house in the Sandstrasse in Bremen he had his exceedingly



modest observatory, at the equipment of which, consisting only of small and portable instruments, any modern amateur would turn up his nose. For years he was obliged to correct his clock by tedious observations of equal altitudes with a sextant and artificial horizon, until he devised the simpler and quicker method of watching the disappearance of stars behind a distant tower. But his labours brought him a plentiful reward, not only in the discovery of the planets Pallas and Vesta and various comets, and in the renown which these and his important publications procured him, but also in the friendship of Schröter, Zach, Gauss, Bessel, Schumacher, Encke and others, who always in their letters and published writings mention him with the greatest veneration.

The publications of Olbers are scattered through many volumes of the various periodicals of his time, some of which are not readily accessible now-a-days. But most of them are still of the highest importance, not only those describing the method which is practically the only one used for computing cometary orbits, but also those in which Olbers has deposited the results of his deep study of the literature of comets, ancient and modern, as well as the many articles which bear witness to his having possessed mathematical abilities of no mean order. The appearance of the complete edition of his works now before us will therefore be hailed with pleasure by astronomers. It is to be followed by two other volumes, containing the correspondence of Olbers with Gauss, and a biography by the editor.

The celebrated and epoch-making memoir on the most convenient method of computing the orbit of a comet was printed separately (in 1797), and it naturally opens the volume now published. After it (and the appendix published in the *Jahrbuch* for 1833) the editor has placed twelve other papers under the common heading "Abhandlungen." It is not easy to see why these particular papers have been distinguished in this manner. It is not because they are the longest, for some of them occupy only a few pages, so it must be because the editor considers them specially important. But if so, why are others, fully as important, not put along with them, as, for instance, the classical paper on the tail of the great comet of 1811? The arrangement of the other papers in six groups also frequently challenges criticism. Under the heading "Comets" are given no less than 110 papers, but half a dozen notes on comets are relegated to the group of "Miscellanea from letters," near the end of the book, apparently simply because they were written in the form of letters to the editors of various journals. The useful index at the end of the volume will, however, enable the reader to read these notes in connection with the other papers on comets. On the other hand, the papers on the comets of 1802 and 1811 (pp. 293 and 315) are made up of pieces detached from two editorial articles in the *Monatliche Correspondenz*, omitting all the observations not made by Olbers; and this patchwork might, perhaps, better have been put among the miscellaneous notes. It would have been much simpler, and apparently more satisfactory, if all the papers (except the separately published book of 1797) had been printed in chronological order, as the index would even then have made it easy to pick out

papers on any special matter. It is, however, more to be regretted that the editor has not seen fit to add some explanatory notes, which would greatly have increased the value of the book to young students of astronomy, who cannot be supposed to be thoroughly acquainted with its literature. We shall only point out a few cases where such notes would have been particularly useful. The first is Olbers' letter to Encke about the mysterious comet alleged to have been observed by D'Angos at Malta in 1784, reprinted here from Encke's well known paper with the startling title, "Imposture astronomique grossière du Chevalier D'Angos." We certainly think that the editor might in a short note have given references to the more recent investigations on this matter by d'Arrest and Gylden, which render it at least very possible that D'Angos really found and on two nights observed a comet. At any rate we cannot be certain that the whole matter was nothing but a fraud, and a different heading to the article might have been chosen. On page 226 it should have been pointed out that the orbit of the comet of 1558 has also been computed by Illoek (from observations by Paul Fabricius), whose results differ considerably from those of Olbers. On p. 228, Olbers suggests that the manuscripts of Father Schall in the Vatican might contain comet observations from 1618. It would have been useful to have added a note to the effect that these manuscripts have afterwards been found not to contain any such observations (*Corresp. Astron.* v. p. 143). Similarly the article on Cacciatori's supposed planet of 1835 (p. 526) should have been accompanied by a note referring the reader to the calculations of Valz and Luther, as well as to NATURE, vol. xviii. p. 260, which might prevent some rash student from wasting his time on this object.

The papers have been reprinted from the originals without any alterations, so that even errors pointed out in subsequent papers have been allowed to stand (e.g. pp. 523 and 538, compare pp. 649 and 542). Some papers will be quite new to most readers, as they were published in journals of limited circulation, such as Harding's *Kleine Ephemeriden*, *Göttingische Anzeigen*, and Gruithuisen's *Analekten* and his *Jahrbuch*. The charming character of Olbers is seen in his notes to Gruithuisen, in which he frequently gently corrects mistakes in the writings of this enthusiastic but somewhat erratic observer. In an appendix are given two papers of 1787 and 1788 on mesmerism. Olbers' dissertation for the degree of M.D. (*De oculi mutationibus internis*, Göttingen 1780) is not reprinted.

The book is well printed, and has as frontispiece an excellent portrait of Olbers. In addition to a table of contents and an index, it contains a list of all the papers, arranged according to the journals in which they first appeared. No mention is here made of the catalogue of cometary orbits (published in Schumacher's *Abhandlungen*); but this has not been reprinted, and is of course long ago superseded.

In laying aside this splendid volume, we cannot refrain from making one more remark. We have now the collected works of Laplace, Gauss, Bessel, Encke, Olbers; how long are we to wait for a complete edition of the works of William Herschel?

J. L. E. D.

## QUATERNIONS.

*Anwendung der Quaternionen auf die Geometrie.* Von Dr. P. Molenbroek. Leyden: E. J. Brill, 1893.  
*The Quaternions of Quaternions.* By Lieut.-Colonel H. W. L. Hime. (London: Longmans, Green, and Co., 1894.)

IN these books we have evidence of the growing demand for quaternion literature. Dr. Molenbroek's work is the promised sequel to his first volume on the Theory of Quaternions, and contains many admirable examples of the application of the method to geometry. All who are familiar with Hamilton's and Tait's classics on the subject will recognise many of these examples as old friends, taken almost verbatim from their original sources. In not a few of the applications, however, Dr. Molenbroek ventures into fresh fields, and shows that he can use quaternions with ease and power. It is interesting to notice the occasional effective use of the conjugate quaternion, an invention of the great master which is apt to be lost sight of after the foundations of the calculus have been laid. The treatment throughout is on the familiar Hamiltonian lines, the author's aim being development and not fancied improvements. The book consists of six chapters, in which are taken up—to name a few of the most important applications—spherical trigonometry, the plane and sphere, quadric surfaces, surfaces in general, curves in space, and the theory of rectilinear rays. The elementary properties of the remarkable operator  $\nabla$ , and the integration of partial differential equations of the first and second orders, are discussed as part of the general theory of surfaces. In the same chapter, Dr. Molenbroek, by means of two new differentiating operators, obtains a simple symbolic representation for the first, second, and higher polars of a point with regard to a given surface. These remarks will indicate sufficiently the scope of a work which, though not altogether above criticism in minor details, is a distinct addition to quaternion literature, and deserves a wide circulation.

Colonel Hime's work is a much more modest production, being intended for the mere beginner. In general scope it might be compared to the first nine chapters of Kelland and Tait's "Introduction to Quaternions." The book contains many good examples in the simpler applications of quaternions to the geometry of triangle, plane, sphere, conic section, cone, &c., but it is less satisfactory in the exposition of the fundamental principles of the calculus. For example, the identification of unit vector and right versor is stated, but the reason for this identification is nowhere distinctly given. Again, the truth that the familiar Hamiltonian symbols  $i, j, k$  may be regarded as a sense *imaginary*, because  $i^2 = j^2 = k^2 = -1$ , is supposed to lead to the equation

$$i + j + k = \sqrt{-1} \quad (i, j, k \text{ Eq. 3, p. 49}).$$

This seems to be playing sad havoc with one's very definitions. Then on page 76 we find what is virtually the equation  $i + j + k = \gamma$  transformed into  $i^2 = j^2$ , the non-commutative principle being wholly ignored, and in consequence a quaternion and a scalar equated! These errors, especially the latter, are very surprising in a book whose author is a true disciple of Hamilton. Of minor omission we might refer to the appeal to Cartesian

expansions in order to demonstrate (?) the associative principle in multiplication. Nor do we quite understand Colonel Hime's system of referring to authorities. For example, why should Prof. Hardy be quoted as the authority for the statement that every versor may be represented by a power of a unit vector; for is it not all in Hamilton (see "Elements," § 309)? Again, Dr. Odstrčil is credited with a proof that the three angles of a plane triangle are together equal to two right angles, the proof being an obvious particular case of Hamilton's remarkable expression for the product of the versor arcs of a spherical triangle. But surely the theorem regarding the angles of a plane triangle *underlies* the fundamental properties of quaternions and versors; so that the supposed proof is really reasoning in a circle. Dr. Odstrčil is worthy of higher praise than this. These blemishes apart, however, and leaving out of account the two errors already noted, we find in Colonel Hime's book a serviceable exposition of the elementary applications of quaternions. A careful study of its pages will go far to fit the reader for the arduous task of grappling with the higher and more characteristic developments to be found in the writings of the masters of the quaternion calculus.

## OUR BOOK SHELF.

*Sir Victor Brooke, Sportsman and Naturalist.* By O. L. Stephen. London: John Murray, 1894.)

THE late Sir Victor Brooke was an excellent example of a combination of sportsman and naturalist. In this book his life as a sportsman predominates; but a chapter on his researches in natural history, by Sir William Flower, shows that he possessed the keenness of observation required in a man of science. His most important contribution to science was an exhaustive paper, published in the *Proceedings* of the Zoological Society, the subject being the classification of the *Cervidae*. At one time he was an enthusiastic student of natural history, but the state of Lady Brooke's health having compelled him to live out of England for the greater part of the year, he could not conveniently carry on his researches. From about 1880 his life was chiefly devoted to foreign travel and sport. The extracts from his letters and journals are full of stirring adventures, and contain some interesting observations on animal life and habits. Mr. Stephen prefaces these extracts with a memoir of his dead friend. The book is beautifully printed, and is illustrated by ten fine plates. It appeals particularly to those who were acquainted with Sir Victor Brooke, and who admired his character; nevertheless, such of the public as read it will find the contents interesting.

*A Text-book of Dynamics. A Text-book of Statics.* By William Briggs and G. H. Bryan. (The University Tutorial Series.) (London: W. B. Clive, 1894.)

THESE books belong to the elementary class, and a perusal of them shows that they will prove excellent additions to this series of useful text-books.

In both the authors have assumed little or no knowledge of trigonometry, and they have been written so that either may be read first. The treatment is conspicuous for its clearness and conciseness, and is all that a student about to enter a course could desire. The figures are neatly drawn, and many new ones are noticeable in the latter book.

Notwithstanding the fact that these text-books are published to meet the requirements of candidates for certain examinations, they may still be used by others, who are making themselves acquainted with these sub-

jects. Besides several excellent series of examples, a very useful summary is added to each chapter, which will be serviceable for revision purposes. The adoption of different sizes and kinds of type, when it is, as here, carefully done, is also a very great boon to beginners.

*The Slide-Rule. A Practical Manual.* By Charles N. Pickworth, Wh.Sc. (London: Emmott and Co., Ltd., 1894.)

THE most modern form of slide-rule is of the Mannheim or Tavernier-Gravet type, and undoubtedly surpasses its predecessors in many ways. At the present time this instrument is in general use on the continent, principally in France and Germany, and it is now becoming more popular in England.

The slide-rule may be defined as an instrument for mechanically effecting calculations by logarithmic computation. By its aid arithmetical, algebraical, and trigonometrical processes may be performed much more quickly and with greater ease than by the ordinary methods, while the accuracy of the results are quite within the limits of error for all practical purposes. There is no doubt that when the instrument is better known, and its labour-saving property recognised, it will be more commonly seen in the laboratory and workshop than it is now. So many manipulations can be done with it that, without some guide, its full value cannot be appreciated. In the present little manual the author brings these all together, and in such a form that the reader can, by paying attention to the mechanical and mathematical principles, obtain an intelligent interest in the manipulations, and have confidence in the results.

W. J. L.

*I Fondamenti Matematici per la Critica dei Risultati Sperimentali.* Del Prof. P. Pizzetti. (Genova, 1892.)

AN elaborate memoir, of the nature of a complete treatise on the Method of Least Squares, in its application to the reduction to order of a long-continued series of experiments and of their numerical results.

It contains a valuable bibliography of writings on the subject, arranged alphabetically according to authors' names.

Hitherto the astronomer has made most use of this theory; but the artillerist is now finding it important for his purposes, in calculating from the number of hits to effect a desired amount of destruction the amount of ammunition required.

G.

*Teppich-erzeugung im Orient.* By various Contributors. Pp. 204. (Wien: K. K. Oesterr. Handels-Museum, 1895.)

THIS work consists of a series of monographs on important antique tapestries contained in European museums and private collections, contributed by Sir George Birdwood, Mr. C. Purdon-Clarke, Mr. Vincent J. Robinson, Mr. S. J. A. Churchill, Dr. W. Bode, M. Gerspach, and M. O. M. Stoeckel. In addition to the history of antique tapestries, the work contains descriptions of a number of the more important types of modern tapestries of the Levant, Persia, and India. The illustrations are numerous and of high quality.

*A Laboratory Manual.* By W. R. Orndorff, A.B., Ph.D. (Boston: D. C. Heath. London: Isbiser and Co., 1894.)

A COURSE of experiments in organic chemistry, systematically arranged as an adjunct to Prof. Ira Reimsen's work on the "Compounds of Carbon." As Dr. Orndorff has had a large experience in the laboratory work to which the book refers, the conditions of the experiments described can be depended upon, which is the highest recommendation that can be given to a manual of this kind.

## LETTERS TO THE EDITOR.

*The Editor does not hold himself responsible for opinions expressed by his correspondents. Neither can he undertake to return, or to correspond with the writers of, rejected manuscripts intended for this or any other part of NATURE. No notice is taken of anonymous communications.]*

### Finger-Prints.

I HAVE been quite unable, since I saw Mr. Faulds' letter in your issue of October 4, to take the matter of it in hand hitherto; and I do so now only because I think Mr. Faulds is entitled to raise the question if he pleases. To the best of my knowledge, Mr. Faulds' letter of 1880 was, what he says it was, the first notice in the public papers, in your columns, of the value of finger-prints for the purpose of identification. His statement that he came upon it independently in 1879 (? 1878) commands acceptance as a matter of course. At the same time I scarcely think that such short experience as that justified his announcing that the finger-furrows were "for-ever unchanging."

How I chanced upon the thing myself in 1858, and followed it up afterwards, has been very kindly stated on my authority by Mr. Galton, at whose disposal I gladly placed all my materials on his request. Those published by him are only a part of what were available. (See his "Finger-Prints," page 27, and his "Blurred Finger-Prints.") To what is there stated I need now only add, at Mr. Faulds' request, a copy of the demi-official letter which I addressed in 1877 to the then Inspector-General of Jails in Bengal. That the reply I received appeared to me altogether discouraging was simply the result of my very depressed state of health at the time. The position into which the subject has now been lifted is therefore wholly due to Mr. Galton through his large development of the study, and his exquisite and costly methods of demonstrating in print the many new and important conclusions he has reached.

I take the opportunity, in reference to a late article on Anthropometry (in the *Nineteenth Century* of September 1894 p. 365), to deprecate, as being to the best of my knowledge wholly unproved, the assertion that the use of finger-marks in this way was "originally invented by the Chinese." I have met no evidence which goes anywhere near substantiating this. As a matter of fact, I exhibited the system to many passengers and officers of the P. and O. steamship *Mongolia* in the Indian Ocean, during her outward voyage in February 1877; and I have the finger-prints of her captain, and of all those persons, with their names. It is likely enough that the idea, which caught on rapidly among the passengers, may have found a settlement in some Chinese port by this route, and have there taken a practical form; but whether that be so or not, I must protest against the vague claim made on behalf of the Chinese, until satisfactory evidence of antiquity is produced.

Littlemore, November 7.

W. J. HERSCHEL.

(TRUE COPY OF OFFICE COPY.)

*Hooghly, August 15, 1877.*

MY DEAR B—.—I enclose a paper which looks unusual, but which I hope has some value. It exhibits a method of identification of persons, which, with ordinary care in execution, and with judicial care in the scrutiny, is, I can now say, for all practical purposes far more infallible than photography. It consists in taking a seal-like impression, in common seal ink, of the markings on the skin of the two forefingers of the right hand (these two being taken for convenience only).

I am able to say that these marks do not (bar accidents) change in the course of ten or fifteen years so much as to affect the utility of the test.

The process of taking the impression is hardly more difficult than that of making a fair stamp of an office seal. I have been trying it in the Jail and in the Registering Office and among pensioners here for some months past. I have purposely taken no particular pains in explaining the process, beyond once showing how it is done, and once or twice visiting the office, inspecting the signatures, and asking the *omlah*<sup>1</sup> to be a little more careful. The articles necessary are such as the *daftari*<sup>2</sup> can prepare on a mere verbal explanation.

Every person who now registers a document at Hooghly has to sign his "sign-manual." None has offered the smallest objection, and I believe that the practice, if generally adopted, will put an end to all attempts at personation.

<sup>1</sup> Clerks.

<sup>2</sup> Man in charge of stationery.

The cogency of the evidence is admitted by every one who takes the trouble to compare a few signatures together, and to try making a few himself. I have taken thousands now in the course of the last twenty years, and (bar smudges and accidents, which are rarely bad enough to be fatal) I am prepared to answer for the identity of every person whose "sign-manual" I can now produce if I am confronted with him.

As an instance of the value of the thing, I might suggest that if Roger Tichborne had given his "sign-manual" on entering the Army on any register, the whole Orton case would have been knocked on the head in ten minutes by requiring Orton to make his sign-manual alongside it for comparison.

I send this specimen to you because I believe that identification is by no means the unnecessary thing in jails which one might presume it should be. I don't think I need dilate on that point. Here is the means of verifying the identity of every man in jail with the man sentenced by the court, at any moment, day or night. Call the number up and make him sign. If it is he, it is he; if not, he is exposed on the spot. Is No. 1302 really dead, and is that his corpse or a sham one? The corpse has two fingers that will answer the question at once. Is this man brought into jail the real Simon Pure sentenced by the magistrate? The sign-manual on the back of the magistrate's warrant is there to testify, &c.

For uses in other departments and transactions, especially among illiterate people, it is available with such ease that I quite think its general use would be a substantial contribution towards public morality. Now that it is pretty well known here, I do not believe the man lives who would dare to attempt perjury before the registrar here. The *mukhtears*! all know the potency of the evidence too well.

Will you kindly give the matter a little patient attention, and then let me ask whether you would let me try it in other jails?

The impressions will, I doubt not, explain themselves to you without more words. I will say that perhaps in a small proportion of the cases that might come to question the study of the seals by an expert might be advisable, but that in most cases any man of judgment giving his attention to it cannot fail to pronounce right. I have never seen any two signatures about which I remained in doubt after sufficient care.

Kindly keep the specimens carefully.

Yours sincerely,

W. HERSHEL.

**Boltzmann's Minimum Function.**

MR. CULVERWELL, in his letter to NATURE of October 25, questions the existence of Boltzmann's minimum function, and asks will somebody tell us what the H-theorem really proves?

As I have made use of the theorem on several occasions, I may be permitted to say a word in its defence. I will endeavour to answer Mr. Culverwell's question what the theorem proves for the simple case of equal elastic spheres. If I can do that, it will probably not be difficult to generalise the result.

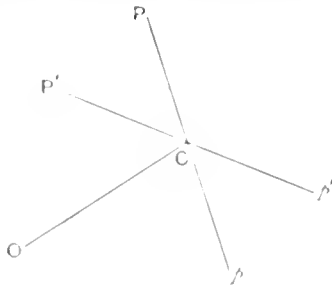

Let then V, or O, in the figure, denote the velocity of the common centre of gravity of two elastic spheres, each having diameter  $\alpha$ . Let R be their half relative velocity. If we describe a spherical surface with radius R about centre C, and if P' be any diameter of it, the actual velocities of two spheres are OP and OQ.

Let the number per unit of volume of spheres whose velocities are represented by lines drawn from O to points within the element of surface  $\delta S$  at P be denoted by  $f/dS$ . Let  $f'/\delta S$  denote the corresponding number for the element  $\delta S$  at P'. Then  $f/dS$  is the number of pairs whose relative velocity R falls within the cone

described with solid angle  $d\Omega$  about PC as axis. Let P'CP'' be any other diameter, and let  $f'/dS'$ ,  $f''/dS''$  be the corresponding number of spheres with velocities OP' and OQ'.

If a pair of spheres collide the relative velocity assumes, as the result of collision, a new position only, and that which position shall be depends on the coordinates of the collision, i.e. the point in which a line parallel to the relative velocity through the centre of one sphere cuts a circular area of radius  $\alpha$ , drawn through the centre of the other sphere at right angles to that line. If the collision coordinates be taken at random, then the following condition holds, viz. :—For any given direction of R before collision, all directions after collision are equally probable. Call that condition A.

Now assume condition A to be fulfilled, and consider all collisions which take place between pairs of the V R spheres.

The number which after the collisions belong to the class  $f/dS$  will be on the above assumption  $\frac{d\Omega}{4\pi} \int \int f'f''dS'$ .

But before the collisions it is  $f/dS$ . Therefore, as the result of collisions it is increased by  $dS \left( \frac{\int \int f'f''dS'}{4\pi} - f \right)$ . That is

by  $\frac{dS}{4\pi} \int \int (f'f'' - f^2)dS'$ ,  $f, f'$  being treated in the integration as constant.

Therefore

$$\frac{df}{dt} = \frac{df'}{dt} = \frac{\pi^2 R}{4\pi} \int \int (f'f'' - f^2)dS'$$

and if

$$H = \int \int f \log f - 1) dS,$$

$$\begin{aligned} \frac{dH}{dt} &= \frac{\pi^2 R}{4\pi} \int \int \int dS dS' \int (f'f'' - f^2) \log (f) dS' \\ &= \frac{\pi^2 R}{4\pi} \int \int \int \int dS dS' (f'f'' - f^2) \log (f) \\ &= \frac{\pi^2 R}{4\pi} \int \int \int \int dS dS' (f'f'' - f^2) \log f'' \text{ by symmetry} \\ &= \frac{1}{2} \frac{\pi^2 R}{4\pi} \int \int (f'f'' - f^2) \log \frac{f'f''}{f^2} dS dS', \end{aligned}$$

which is necessarily negative if not zero. The above is true for all values of V and R, and therefore for the whole system.

Thus we have proved that if condition A be satisfied, then if all directions of the relative velocity for given V are not now equally likely, the effect of collisions is to make H diminish.

The objection that I understand to be made is that if you reverse all the velocities after collisions, the system will retrace its course with H increasing—which is supposed to be contrary to the thing proved.

The objection is wrong because in your reverse motion condition A is not fulfilled. The proof (is not wrong but) ceases to be applicable by failure of the condition on which it is based.

Somebody may perhaps say that by this explanation I save the mathematics only by sacrificing the importance of the theorem, because I must (it will be said) admit that there are, after all, as many cases in which H increases as in which it diminishes. I think the answer to this would be that any actual material system receives disturbances from without, the effect of which, coming at haphazard, is to produce that very distribution of coordinates which is required to make H diminish. So there is a general tendency for H to diminish, although it may conceivably increase in particular cases. Just as in matters political, change for the better is possible, but the tendency is for all change to be from bad to worse. S. H. BURBURY.

1 New Square, Lincoln's Inn, November 12.

**The Kinetic Theory of Gases.**

I CANNOT quite agree in Mr. Bryan's remembrance of what took place in the discussion of the Thermodynamics Report at Oxford. As far as I recollect, Prof. Boltzmann's reply was not in special reference to such a point as the specific heats of gases, but was in answer to a very vigorous, if somewhat general, onslaught of Prof. Fitzgerald, who simply stated that it appeared evident from the spectra of gases and other considerations, that the energy could not be equally divided among all the degrees of freedom of the coordinates, and said what he wanted to know from Prof. Boltzmann was *when the theory*

became inapplicable, what assumptions became invalid?—why, if Dr. Watson's method of generalised coordinates were valid, the ether, the solar system and the universe generally were not subject to the Maxwell-Boltzmann law, so that the mean kinetic energy of every coordinate in the universe should be the same and so on, insisting that what he wanted to know was *why the theory failed, what assumptions were invalid.*

After the other speakers had concluded, Prof. Boltzmann arose to reply, and he took up a perfectly logical position. He said that the theory as it left his hands was a mathematical theorem, a piece of pure mathematics, and that it was for *physicists* to say how far it applied to gases—that the reason of any disagreement between the theory and the facts was “a mystery, as Lord Salisbury had said.”

That appears an unassailable position, and the only misapprehension which, so far as I can see, could arise, would be that Boltzmann had admitted not only that his work was a piece of pure mathematics, but that it was *nothing more*, a bare theorem without the promise that future adaptations would lead to an even closer accord between the theory and the facts. If such an impression as that has got abroad, Mr. Bryan has done good service in calling attention to the matter.

There seem many difficulties about the suggestion (made by Dr. Larmor at Oxford, and referred to by Mr. Bryan in his letter) that the spectra of gases need not be explained by the Boltzmann law, as they arise not from molecular but from ethereal vibrations set up by the molecules. Surely if so, the molecules cannot be regarded as an independent system, and Dr. Watson's generalised coordinates must include ethereal coordinates also, and the Maxwell-Boltzmann law must be supposed to hold for matter and ether alike, which does not seem to get over the difficulty.

November 10.

EDWD. P. CULVERWELL.

#### Homogeneity of Structure the Source of Crystal Symmetry.

MR. BARLOW'S letter on this subject (p. 58) raises a problem of considerable interest, which may be stated in simple words.

He has inquired in the most general manner possible how anything can be uniformly distributed in space so as to constitute a homogeneous system; the word homogeneous may be taken to signify that round any one member of the system the distribution of the remainder is the same as round any other. It is not necessary to say that the units of which the system consists are figures or solids, but merely that, whatever the unit may be, it is homogeneously repeated.

Now repetition may conceivably take place by sliding the unit from one position to another, by rotating it about an axis, by reflecting it across a plane, or by a combination of these processes; in other words, by translation, rotation, and inversion. If the last process be excluded, we cannot arrive at all the types of symmetry presented by crystals; if it be included, we obtain all those types and no others. Therefore the crystal structure is one in which this process is operative. Mr. Barlow himself does not include inversion as a mode of homogeneity, but regards it as an additional property possessed by some crystal structures. Earlier writers have specialised the problem by taking a particular unit. Bravais and Sohncke, for example, to whom the modern treatment of the subject is entirely due, have investigated systems of points. Now the reflection of a point is an identical point, so that it is useless to introduce the principle of reflection or inversion as distinct from translation in order to derive any *one* point of such a regular system from another. The same is true of spheres and many symmetrical figures, and unfortunately molecules have usually in such investigations been treated as points or spheres or symmetrical figures.

Mr. Barlow does not consider that his solution of the geometrical problem supplies a theory of crystal structure or settles the question whether the seat of the symmetry is in the arrangement or in the configuration of the molecules.

But it appears to me that a step of very great importance has been made, for, surely, these investigations prove that the symmetry of such a structure *can* be entirely explained by the arrangement of the units. I would go farther, and ask whether the result does not suggest that the units which determine the symmetry of a crystal are units capable of repetition by the processes of translation, rotation, and inversion. If this be so, we are not justified in treating them generally as points or as symmetrical figures.

Many things besides unsymmetrical figures can be conceived which are capable of such repetitions; for example, a solenoid, a vortex motion, a system of forces in statical equilibrium.

I would add that Mr. Barlow's investigation cannot be said either to support or to contradict the theories of Fedorow and Schonflies; it is, as he remarks, purely geometrical, and in this respect is identical with their researches, and leads to the same results. It is true that Fedorow has proposed a theory of crystal structure, but this is only an application of the geometrical principles which he had previously established.

H. A. MIERS.

British Museum (Natural History), November 19.

#### Gravitation.

I REGRET that I cannot agree with Dr. Joly's suggestion (*vide* p. 57 *supra*) that the curious adhesion which I observed between solids immersed in a stretched liquid, lends itself to any explanation of gravitation on the lines that he indicates. The phenomenon is, and was described by me as, one of *adhesion*, and not, as Dr. Joly puts it, of *attraction*, for there was no evidence of any approach of bodies separated by a measurable thickness of liquid, and there is, further, no reason to suppose that the phenomenon would occur unless the medium were already modified in the neighbourhood of the solid surfaces, *i.e.* unless a condition which we may provisionally ascribe to gravitation already existed. For this reason Dr. Joly's suggestion appears to me to be an invitation to argue in a circle.

If there were evidence, which there is not, that the ether round celestial bodies was modified to a great distance, the suggestion would, I think, be legitimate, but it would then be necessary to explain the modification.

Devonport, November 18.

A. M. WORTHINGTON.

#### The Foucault Pendulum Experiment.

PROF. GREENHILL gives currency to quite an erroneous idea in last week's NATURE (p. 50). He says “in the Foucault experiment of the pendulum which shows the rotation of the earth, the slightest current of air will destroy and reverse the desired motion; so that it is advisable in showing the experiment to have an elastic ball concealed in the palm of the hand, which can send a slight current of air on the bob of the pendulum, and thus accelerate the initial precession of the plane of the vibration so as to gratify the eyes of the audience and diminish their impatience at the slowness of the motion.” If Prof. Greenhill will go to the Western Galleries of the South Kensington Museum any day, he will be able to see a Foucault pendulum fulfilling its purpose without being particularly protected from draughts, and without the accessory puffs to which he refers. The pendulum is suspended in a place where people are continually passing to and fro, yet its plane of vibration always rotates in the same direction as watch-hands, or rather the table under the pendulum turns in the opposite direction. I have watched the pendulum dozens of times without seeing it fail.

November 19.

G. A. R.

#### An Observation on Moths.

AN experiment was tried in 1894, on a number of pupæ of *Samia promethes* and *Samia cecropia*, which brought out a point of which I have seen no mention. When the moth is almost ready to burst through the thin shell which encloses it, this outer skin becomes dark-coloured and friable, and the insect can often be seen moving within.

If the enclosing envelope is then removed with a scalpel and forceps, the moth struggles out, apparently as lively as when legitimately hatched.

The only hitch in the proceedings seems to be in the non-expansion of the wings, the development of which usually takes place at once. The moth crawls about, like a forlorn penguin, for a period varying from one to three days, when the wings seem to realise the absurd state of affairs, and make a brave effort to fulfil their part of the contract. The effort, however, is only partially successful, for owing to their dry condition the expansion is irregular and incomplete, and the poor moth remains a helpless cripple.

This would seem to demonstrate that the wings do not mature as rapidly as the rest of the body, and that until complete maturity is reached, no effort towards expansion is made.

L. C. JONES.

PHOTOGRAPHS OF A TUMBLING CAT.

M. MAREY'S recent photographs of a falling cat, taken with the view of determining the mechanical conditions which enable the animal to alight on its feet.

The former gives a side view of pussy, and the latter a back view. The cat was held by its feet, and was let go in that position. In each of the pairs of figures, the series of images runs from right to left, and the lower is a continuation of the upper. The expression of offended

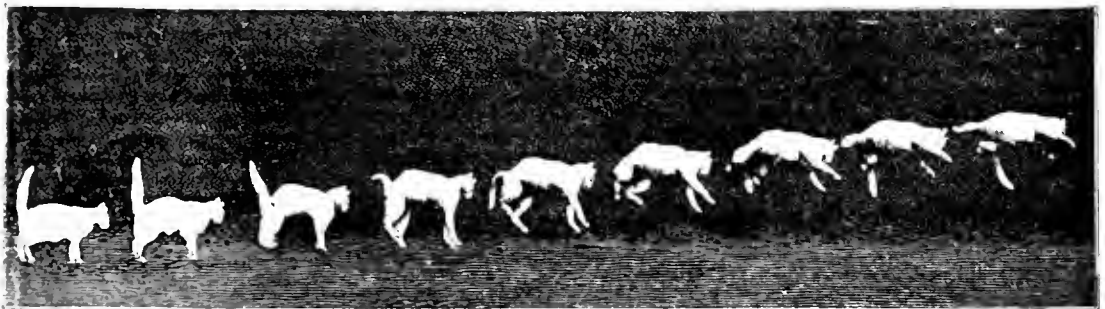
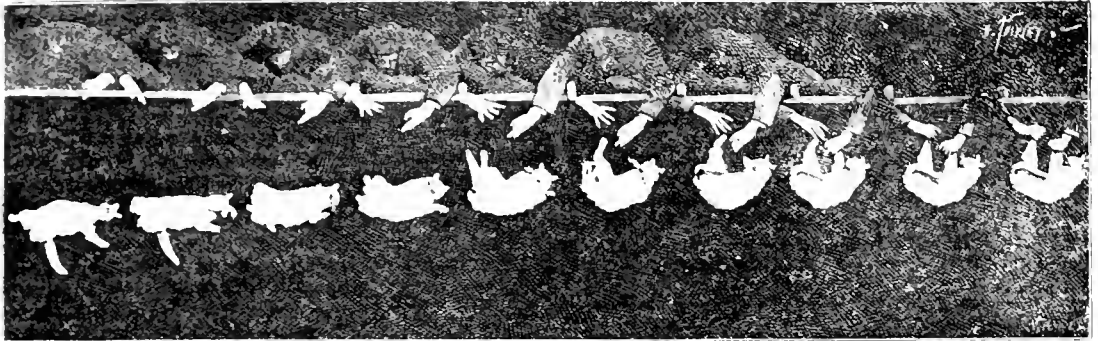

FIG. 1.—Side view of a falling cat. (The series runs from right to left)

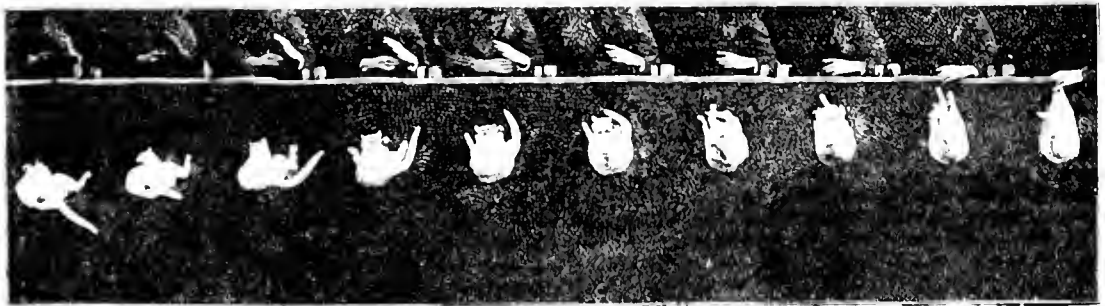

FIG. 2.—Back view of a falling cat. (The series runs from right to left)

has excited considerable interest. The illustrations accompanying this paper on the tumbling of cats, presented to the Paris Academy, and are reproduced in *Nature*, NO. 1308, VOL. 51]

disunity shown by the cat at the end of the first series indicates a want of interest in scientific investigation.

The rotation of the fore and hind parts of the cat's

body takes place at different stages. At first the twist is almost exclusively confined to the fore part, but when this amounts to about 180 degrees the rear part of the animal turns. M. Marey is of the opinion that an inspection of the figures altogether excludes the idea that the animal uses the hands that let it go as a fulcrum by means of which a movement of rotation is obtained. The first few images in each of the two series show that at the beginning of the fall the cat exhibits no tendency to turn either one side or the other.

As to the hypothesis that the resistance of the air affords a means of turning, this also appears to be inadmissible; because, on account of the tumbling motion of the animal, if this resistance had an appreciable effect, it would produce a rotation in the opposite direction to that observed.

M. Marey thinks that it is the inertia of its own mass that the cat uses to right itself. The torsion couple which produces the action of the muscles of the vertebra acts at first on the forelegs, which have a very small motion of inertia on account of the front feet being foreshortened and pressed against the neck. The hind legs, however, being stretched out and almost perpendicular to the axis of the body, possesses a moment of inertia which opposes motion in the opposite direction to that which the torsion couple tends to produce. In the second phase of the action, the attitude of the feet is reversed, and it is the inertia of the forepart that furnishes a fulcrum for the rotation of the rear.

#### BIOLOGY IN THE UNITED STATES—A PROSPECT.<sup>1</sup>

THIS volume is slightly larger than its predecessor published in 1891, and is an advance upon it in the number and class of its illustrations. During the interval of publication of the two volumes, much of the work announced in the first one has appeared in full; and the present one shows that although, perhaps, more might be made of the resources of the Wood's Holl Laboratory and its rich surroundings by a better appreciation on the part of the scientific public, there is no falling off in either the energy or enthusiasm of its founders and chief supporters. The ten lectures reported in this volume are chiefly special ones, given by investigators who undertake to review their chosen field of labour, and to set forth the results of their own inquiry—it being an avowed object to bring forward unsettled problems of the day, and discuss them freely. The lectures are published for the first time, with the exception of that which is the most striking of the series and one of the most remarkable contributions to recent biological literature, viz. Prof. C. O. Whitman's thesis on "The Inadequacy of the Cell-theory of Development," originally read before the Zoological Congress of the World's Columbian Exposition, and already reprinted in the *Journal of Morphology*. Prof. Whitman's work in this department dates from his inaugural dissertation for the degree of Doctor of Philosophy in the University of Leipzig, dealing with the embryology of *Clepsine*, in which he laid the foundation of his now famous teloblast theory. The researches which this essay has provoked rank foremost in interest among all those recently devoted to the study of the germinal blastemata.

No one has more assiduously followed up Prof. Whitman's suggestive lines than Prof. E. B. Wilson, whose lecture on "The Mosaic Theory of Development" ranks first in order in the present volume. His recent work on the cell-lineage of *Nereis* is second only to that of Whitman in interest and importance. His present treatise

is a review of the embryological work of the last decade in its bearing upon the biogenetic law. Prof. Whitman would seek the secret of organisation in ultimate elements of living matter "for which *idiosomes* seems an appropriate name"; Prof. Wilson, that of differentiation during development in the interaction of the embryo-cells. There next follows a lecture by Dr. E. G. Conklin, on "The Fertilisation of the Ovum," *afropos* of the author's researches into the development of the marine gastropod *Crepidula plana*.

Lecture iii. is by Prof. Jacques Loeb, "On some Facts and Principles of Physiological Morphology." He first considers the question of "heteromorphosis" or substitution of organs, as illustrated (under the maltreatment of *Antennularia*) by the development of new roots and apices in relation to gravitation, and by root formation at points of contact with solid bodies, in *Margeliss* and other hydroids. He shows that it is possible to obtain roots and polyps at will over various and interchangeable areas, in direct response to modified conditions of growth. There follows this a lecture by Prof. Ryder on "Dynamics in Evolution," which is suggestive but imaginary. New terms and statements of probabilities it does contain, but new facts it does not. Its most interesting portions are those relating to surface tension in its probable bearings on protoplasmic activity; but it appears to us rather more sensational than sound. The comparison of the behaviour of a contracted smoke-ring to an *amœba* in motion is suggestive, perhaps in a sense not intended by the author. Dr. Watasê follows with a dissertation "On the Nature of Cell Organisation."

Lecture vii. is a very welcome one, by Dr. Howard Ayers, on *Bdellostoma Dombeyi*, *afropos* of its author's work upon the comparative morphology and physiology of the vertebrate ear. He deals at some length with the habits of the animal, and adduces additional evidence for the belief in the primitive, as distinguished from the alleged "by parasitism degenerate" nature of the cyclostomi which has been so generally accepted. He records the fact that the gills vary in number from eleven to thirteen on either side, in individuals from different localities; he regards this variation as indicative of suppression, and the numerically highest as the most primitive type, instituting comparisons with the larval *Amphioxus* which appear to us unsound. We welcome his conclusion that the numerical variation of the gills has nothing to do with the formation of the ductors œsophago-cutaneous. He provisionally argues that *Bdellostoma* is unique in the fact that geographical distribution has had little or no effect upon its anatomical structure; and proposes to recognise but a single genus and species of this form, in a manner curiously mindful of his notorious attempt to similarly unite *Protopterus* and *Lepidosiren*. Not even allowing for the possibility that the hitherto accepted species of *Bdellostomas* may be distinct in their habits as well as taxonomically, this proposal appears to us premature, and systematic ichthyologists will certainly not acquiesce to it. In common with most subsequent investigators, he finds himself unable to confirm Beard's alleged discovery of calcified teeth in these creatures. He regards Beard's "bone" as "much hardened horn, produced by the methods used in preparation." This we cannot accept. The cells of Beard's "calcified teeth," although uncalcified, are mesoblastic, and the structure described by him as an "enamel cap" (whatever it may be) certainly does appear in individual sections. He finds that hermaphrodites occur even among old individuals; but while examples possessed of ripe ova and spermatozoa may be forthcoming, he finds them to be rare, and concludes that preponderance of *males* is the ordinary condition. His observations upon the olfactory organ

<sup>1</sup> "Biological Lectures delivered at the Marine Biological Laboratory of Wood's Holl." Vol. II. (Boston: Ginn and Co., 1894.)

have led him to the belief in the paired nature of the cyclostome nose, but they are curiously at variance with those of Von Kupfer that have lately led to the opposite conclusion. His remarks upon the functions of the thread-forming type of cutaneous gland are particularly welcome, in correlation with Weymouth Reid's work upon the origin and constitution of the thread substance. Concerning the ear, he records the striking result that while removal of one labyrinth leads to marked disturbances in the equilibrative function, on the removal of both ears all trace of such disturbance disappears. Morphologists and physiologists will await with interest the full edition of this important communication.

Lectures viii. and ix. are botanical, and as unequal in merit as any two in the whole work. One of them, by Prof. Muirhead Macfarlane, on "Irrito-contractility in Plants," is a record of some beautiful and striking experiments, a very charming one being that with a block of ice, from which he has drawn the conclusion that displacement of the *Oxalis* leaf under its action is the effect of cold and not of weight. The author reverts to his earlier observation, no less beautiful and striking, that in order to induce the closure of the *Dionaea* leaf the application of two successive stimuli within proper intervals is necessary. He deduces two leading principles—1) that plants, like animals, being in a condition of protoplasmic continuity, are, by virtue of it, possessed of a power of general contractility; and (2) that the positions taken up by the *Oxalis* and other leaves under the action of the tropical sun are due to heat and not light effects. The other lecture, by Prof. W. P. Wilson, on "The Influence of External Conditions on Plant Life," contains little new, and is in part vague and unintelligible.

The volume closes with an illustrated report on "The Marine Biological Stations of Europe," by Dr. Bashford Dean, and an appendix on "The Work and the Aims of the Marine Biological Laboratory" at Wood's Hole, by Prof. Whitman, giving a list of close upon 100 papers produced under its auspices.

It cannot have escaped the reader's notice that the contents of the book are largely reports upon experimental work which bears directly upon the recent theories of Weismann, so popular in our own land. Contemporaneously with the labours of Wilson and Loeb, of which an account is given in its pages, the work of Driesch, Herbst, and others, which carries us back through that of Vejdovsky, Chun, and Chabry, to the classical observation of Haeckel, now twenty-five years old, that detached portions of the fully segmented ovum (of the Siphonophoran *Crystallodes*) may give rise to young animals, have materially modified our conception of certain fundamentals of embryology. The observation that variation in development, "twinning," and other kindred phenomena, may bear a definite relationship to variation in temperature, chemical composition, and osmotic pressure of the surrounding medium, is now well established. The discovery that after the removal of either the micromeres or macromeres, the segmenting embryonic mass may still form a gastrula that the differentiation of outer layer cells to form certain larval organs may be directly a question of location—and that certain blastomeres if separated at the two-celled stage may each give rise to an embryo one-half size, and if isolated at the four-celled stage to one of one-fourth size, is very extraordinary; and, viewing the situation generally, one is prone to ask where now are the "old theories." Concerning them, Prof. Wilson replies, "the fine spun thread . . . leads us little by little into an unknown region, so remote from the *terra firma* of observed fact that verification and disproof are alike impossible." The theories of Weismann were originally framed with the laudable desire of stimulating inquiry. They do not seek to explain the

actual *modus operandi* of the hereditary process so much as to localise the seat of hereditary tendency and influence. The implication that neither proof nor disproof are possible, applies, for the matter of that, to even the theory of descent with modification *versus* that of special creation. The educated mind has, however, upon purely logical grounds, chosen between the alternatives in this instance, and it may be safely relied upon to do so in the other.

G. B. H.

#### NOTES.

THE anniversary meeting of the Royal Society will be held on Friday, November 30.

AT the first monthly meeting of the Royal Statistical Society for the present session, held on Tuesday afternoon, a gold Guy Medal was presented to Dr. Robert Giffen, C.B., F.R.S., in recognition of his long and exceptional services to statistical science.

M. LOUIS FIGUIER, who died on November 8, was an eminent populariser of the results of scientific research. He was born at Montpellier in 1819, where he took his degree of Doctor of Medicine in 1841. A few years later he became Professor of Pharmacy in the Paris École de Pharmacie. In 1850 he took his degree as Doctor of Science at Toulouse. He published some important memoirs on chemical subjects, but will be remembered chiefly for his numerous works on popular science. Since 1856, he issued every year the *Année Scientifique*, in which he summarised the most interesting and important scientific discoveries of the year.

THE Manchester correspondent of the *Lancet* says that the sum of £783 10s. 3d. has been raised for the fund in memory of the late Prof. Milnes Marshall, and after expenses £760 2s. 3d. will be left. Of this sum £650 have been invested in Manchester Corporation Stock to provide for the maintenance of the Marshall Biological Library given to the Owens College by the relatives of Prof. Marshall, while £102 8s. 6d. have been similarly invested to provide a "Marshall Gold Medal" to be annually competed for at the Owens College athletic sports.

DR. J. SCHEINER, of the Potsdam Astro-Physical Observatory, has been appointed Extraordinary Professor in Berlin University.

A SEVERE earthquake occurred on Friday last in Sicily and Southern Italy. The shocks were felt not only in the city and district of Messina, and several other places in Sicily, but also throughout the province of Reggio di Calabria, in Southern Italy. The disturbance was also recorded upon the seismic instruments at Rome and Ischia. Shocks of more or less violence were felt at Palmi, Seminara, Santa Eufemia, and San Procopio, in the province of Reggio di Calabria. The centre of the disturbance in this province appears to have been in the west, round the towns of Palmi and Bagnara. San Procopio, a town near Palmi, has been almost entirely destroyed, and it is estimated that at least two hundred persons have perished at that place alone. Since Friday the district of Reggio di Calabria has been slightly disturbed, but these tremors have not caused any further damage.

THE Drapers' Company have contributed £20 to the funds of the Ippang Forest Museum, now being formed in Queen Elizabeth's Lodge, Chingford, by the Essex Field Club, under the sanction of the Ippang Forest Committee of the Corporation of London. The museum is intended to illustrate the natural history, antiquities, and scenery of this beautiful district.

THE *Weekly Weather Report* of the 17th instant shows that in many districts the rainfall greatly exceeded the mean; over all the southern counties of England the amount was nearly four times as much as the average. The largest amounts recorded at



individual stations during the week were 6.25 inches at Godmanstone (near Dorchester), 5.51 inches at Scilly, 5.13 inches at Killarney, and 4.70 inches at Falmouth, while 4.60 inches fell at Crowborough, Sussex, in six days. The rainfall since the beginning of the year has now exceeded the average in all districts, except the Midland Counties and the west coast of Scotland. The excess in the south of England and south of Ireland amounts to over five inches.

REPORTS in the medical papers show that the enthusiasm roused in France by the results of the anti-toxin treatment of diphtheria has by no means abated. We learn from the *British Medical Journal* that the administrative Society of the *Sauveteurs de la Seine* have presented M. Roux with the Grand Diplôme d'Honneur. The Var General Council has voted an equivalent of £40 for the Pasteur Institute, and £80 towards creating a similar institute at Marseilles. The Lille Municipal Council has declared for the erection of a diphtheria laboratory, and has opened a subscription in order to collect the necessary funds. The city of Lille has subscribed £1000. The Council has undertaken to furnish from £1400 to £1600 for a municipal bacteriological laboratory. The Havre municipality has voted £200 towards the cost of establishing a laboratory for the preparation of anti-diphtheric serum. The Paris correspondent of the *Lancet* reports that the Municipal Council of Paris has voted a subvention of fifteen thousand francs to the Pasteur Institute in aid of the preparation and distribution of anti-toxin. A sum of seven thousand six hundred francs has also been voted for the erection of accommodation for immune horses, and an allowance of fifteen hundred francs has been made to enable the institute to prepare and distribute anti-diphtheric serum during the present month and the month of December. In our own country, Sir Joseph Lister's appeal for funds has resulted in the sum of £850 being raised. It is estimated that at least £2000 will be required by the British Institute of Preventive Medicine in order to establish an installation for the manufacture of a sufficient quantity of the fluid to supply the demand.

A MARINE laboratory founded and maintained by a religious corporation, is probably unique of its kind; but such is the case with the Russian station on the island of Solowetzki, in the White Sea, as an interesting article in *Die Natur* informs us. From the early part of the fifteenth century Solowetzki or Holy Island has been the seat of an important monastery, but the foundation, in 1881, of a marine laboratory in connection with it was principally due to the efforts of Prof. R. Wagner, of St. Petersburg, and to the friendly offices of the late Archimandrite Mileti. The laboratory results from the conversion of a herring factory already existing there on a favourable site. It is now a convenient two-storied building, furnished with tank-room, museum, and six work-rooms with large windows, fully provided with all necessary utensils and reagents. Perpetual day is enjoyed from the middle of May to the middle of July, and during that period the energetic naturalist can work continuously with his microscope night and day, if he so pleases. A little fleet of sailing-boats is at the disposal of the station, but, owing to the uncertainty of the winds, a steam-launch is found to be a great desideratum. The attendants are selected from the peasants serving longer or shorter periods in the monastery, and the laboratory naturally suffers a good deal of inconvenience from the frequent changes which ensue. The director for some three years past has been M. Knipowitsch, whose local knowledge has considerably facilitated the researches of visiting naturalists. A long deep lagoon on the east of the island presents features of unusual interest to the biologist. Owing to its physical conformation the lower layers of water remain throughout the year at a constant low temperature, enabling such Arctic forms as *Yoldia arctica* to survive through the

summer heat; while the warming of the tidal surface waters in summer favours the development of such forms as *Cyprina islandica*, and markedly hastens the development of medusæ such as *Cyanea* and *Aurelia*. Solowetzki may be reached from St. Petersburg either *via* Jaroslaw and Archangel, or, more directly, *via* the lakes, Poyjonetz and Szumski.

CAPTAIN WIGGINS, who had left the *Yenesei* in the *Stjernen*, late in the season for England, has been wrecked in Yugor Strait, but a telegram from Archangel states that all on board are well. Particulars have not yet been received, but the fact points to a serious condition of the ice in the Kara Sea.

THE Christmas Lectures to Young People, arranged by the Royal Geographical Society, will this year be delivered by Dr. H. R. Mill. The course, entitled "Holiday Geography," will include four lectures, dealing respectively with maps as holiday companions; geographical pictures, with special reference to amateur photography; a neglected corner—the English lakes; and a geographical holiday on the edge of the Alps. The lectures will take place in the map-room of the Royal Geographical Society, and will be profusely illustrated by the lantern.

THE Royal Geographical Society initiated the new technical meetings for geographers on Monday afternoon, by the discussion of a paper on a pre-Columbian discovery of America, by Mr. Yule Oldham. The claim for the discovery of Brazil by a Portuguese navigator in 1447 was based on a map of Andrea Bianco prepared in 1448, on which an "authentic island 1500 miles west of Cape Verde" was shown. This evidence was supported by various additional arguments, including the St. Brandan's Island of Martin Behaim's globe of 1492. A very lively discussion ensued, in which Mr. E. G. Ravenstein, Mr. Payne, Mr. Beazeley, Dr. Schlichter, Mr. Delmar Morgan, and others took part. The general conclusion of the meeting was unfavourable to the view of the early discovery of Brazil, but all speakers united in expressing their admiration of the manner in which Mr. Oldham marshalled the facts and expounded his theory.

DR. ADOLF E. FORSTER, of Vienna, has made a very careful study of the temperature variations in the rivers of Central Europe, which has just been published in Prof. Penck's *Geographische Abhandlungen*. He has collected a great number of isolated sets of observations, in several cases extending over many years, which have been made by different observers on the main rivers and tributaries of the Vistula, Oder, Elbe, Weser, Rhine, Danube, Adige, Po, Rhone, Loire, Seine, and Thames. These are discussed in order to bring out the amount of diurnal range, the effect on the mean result of different methods of observations (including the effect of depth), the relation between the temperature of water and air in different classes of rivers, the annual march of river-temperature, the variability of water-temperature from the long-period means, the influence of ice, and various other factors, such as the effect of dynamical heating on account of fall from higher to lower levels. Dr. Forster recognises the necessity of farther observations of a strictly comparable kind in order to obtain sure results, especially with regard to the bearing of river-temperature on meteorology; but the results he has obtained are of great interest. He shows how the relation of air- and water-temperature depends on the character of the water-surface considered. In glacier-fed rivers the air is colder than the water only for four months in winter and early spring; in summer the maximum temperature of air and water coincides with the greatest excess of air-temperature. A similar though less marked relation holds good for mountain streams which are not fed by glaciers. In lakes and the outlets of lakes the air-temperature is higher than that of the water only during the four months during which heat is being stored, the curves crossing close to the maximum. In rivers flowing

over plains, such as the Oder at Breslau, and the Marne at its junction with the Seine, the water-temperature remains throughout the year from one to three degrees Centigrade warmer than

HERR E. LE HER, in the *Wiener Berichte*, gives an account of an experiment he has performed to test whether when a magnet turns about its magnetic axis the lines of force remain at rest or turn with the magnet. A magnet is divided by an equatorial plane into two parts, which can turn independently. Under these circumstances it is possible, by means of suitable contact brushes, to obtain from the two extremities of the magnet an induced current of such a magnitude as cannot be explained by the cutting of the rotating lines of force by the extremely short brushes employed. These currents can be explained if we suppose, as did Faraday at one time, that a rotating magnet cuts its own lines of force which remain fixed in space.

MRS. CARL BARRIS, in the current number of the *American Journal of Science*, describes a simple chronograph pendulum which is likely to be very useful to those who have no break-circuit chronometer or seconds clock at their disposal. It is a simple mechanism by which an ordinary seconds pendulum is both kept in motion and made to record its oscillations on one or more chronographs sharply. The heavy metallic bob of the pendulum is electrically connected with the knife-edge, and its top is surmounted by a soft iron armature, which is attracted during part of the swing by an electromagnet, and thus kept in motion. A longer and very much lighter pendulum, consisting of a flat bob suspended by two wires, is suspended by the side of the first, and swings in the same plane, but with a longer period. As the heavy pendulum approaches it, it touches a platinum spring projecting from the other bob, makes current for a moment, and works the chronograph, and at the same time sends the current through the electromagnet. The contact is quite momentary, as the spring causes the wire pendulum to be hurled off ballistically. On its return it is brought to rest, without rebounding, by a stop, against which it leans till the seconds pendulum returns. The bob of the light pendulum is made up of two small square parallel plates, between which the wires and the platinum strip are clutched by a single central screw. A band of platinum foil is wrapped round the heavy bob, in order to ensure reliable electric contact. The chronographs and the electromagnet are connected in parallel. The records show that the time of contact does not reach 0.1 sec. It is desirable to use electromagnets of high resistance to prevent exhausting the battery.

PART I. of vol. vii. of *Cohn's Beiträge* is taken up with a long paper, by Dr. W. Rother, on Heliotropism. He finds that the heliotropic stimulus received on one part may be transmitted to another part of the same organ, or even to a different organ, and there give rise to heliotropic curvature. The transmission can only take place in a basipetal direction, and its rate is always small: in favourable cases 2 cm. per hour. Contrary to Darwin's views, he believes that the whole region which is capable of heliotropic curvature, is also heliotropically sensitive, although this sensitiveness is often unequally distributed in the same region. In all cases of this unequal distribution, it is a small region at the apex of the organ which is distinguished by a greater sensitiveness, whilst the rest exhibits this sensitiveness often in a far less degree. Further, the author investigated the effects of cutting off the apex of the cotyledon of seedlings of grasses, and found that this gives rise to two independent phenomena: a diminution in the rate of growth of the base, and a complete suspension of its heliotropic and geotropic sensitiveness. Both these effects are, however, only temporary. It was also unexpectedly found that these effects are not consequent on every injury done to the cotyledon,

but that large cuts made either into the apex, or even two semi-sections made below the apex from opposite sides of the organ, and only 2 mm. apart, do not cause the diminution in the rate of growth, nor the suspension of heliotropic and geotropic sensitiveness, but that this is only effected by the complete section of the cotyledon.

MESSRS. W. WESLEY AND SON'S "Natural History and Scientific Book Circular," No. 122, contains a full classified list of important works on botany.

THE thirteenth monthly part of "The Royal Natural History" (Frederick Warne and Co.), being the first part of the third volume of the work, has been published.

THE Royal College of Physicians, Edinburgh, has just issued the fifth volume of Reports from their Laboratory, edited by Drs. J. Batty Tuke and D. Noel Paton. The volume presents the results of investigations carried out during the past two years.

THE ninth number of the handy and useful *Alemic Club Reprint* (Edinburgh: W. F. Clay) is devoted to Davy's papers on the property and nature of "muriatic acid" and "oxymuriatic acid," published in the *Philosophical Transactions* between 1809 and 1818. Our readers need hardly be reminded that though Gay-Lussac and Thenard were inclined to believe in the elementary nature of the latter, it was Davy who established the correctness of this view. This reprint of the eight communications to the Royal Society, on his experiments to demonstrate the elementary nature of chlorine, will be valued by students of historical chemistry.

WE have received No. 6 of *The Scientific Koll*, conducted by A. Ramsay, and dealing with the baric condition of the atmosphere. This publication is intended to be a summary of what is known of this subject from the works of various writers, so that anyone may make himself acquainted with what has been written without obtaining and reading the original books, some of which are now difficult of access. The present number contains notes taken from Prof. Kamtz' *Vorlesungen über Meteorologie*, published in 1840, and translated into English by Mr. C. V. Walker in 1845. In addition to retaining the original scales, the author reduces all values to what he terms the "baric unit," which is taken as equivalent to one million pounds weight on the square mile. Thus one inch of mercury at 60° F., and under the ordinary pressure of sea-level, corresponds to 2000 such baric units, and a millimetre under the same conditions to 78.74 baric units.

PROF. LOTHAR MEYER communicates to the *Berichte* a warning note concerning the dangerous nature of explosive mixtures of acetylene and oxygen. It is a well-known fact, frequently demonstrated upon chemical lecture-tables, that detonating mixtures of hydrogen and oxygen, or of marsh gas, ethylene, or carbon monoxide and oxygen, may be ignited in an open glass cylinder without danger provided the vessel is not narrowed at the neck, which would be likely to cause undue pressure. Prof. Meyer states that he has frequently performed the experiment with the above gaseous mixtures, employing a strong straight glass cylinder four centimetres wide and with very thick base, without ever having experienced an accident. Upon performing the experiment recently, however, with a mixture of acetylene and two and a half to three times its volume of oxygen, igniting the gas by approaching the mouth of the cylinder to a flame, the cylinder was blown to innumerable fragments in his hand, happily and almost miraculously without injuring him, although unprotected by a cloth, and the report of the explosion was so loud as to deafen for a time those in the neighbourhood. It has long been known that acetylene explodes with oxygen in closed vessels with great violence, frequently destroying an endiometer, but this remarkable destruc-

tion of an open cylinder is a new evidence of its disruptive force. In the year 1884 Prof. Meyer, in conjunction with Prof. Seubert, showed that the detonating mixture of acetylene and oxygen ignites at a lower pressure than all other combustible gases, a pressure equal to thirty-two millimetres of mercury being sufficient to enable it to explode, while hydrogen and oxygen require a pressure of at least one hundred millimetres, and carbon monoxide and oxygen over two hundred millimetres. This, however, is not sufficient to account for the enormous pressure developed in an open cylinder. Moreover, it cannot be due to the more rapid rate of propagation of the explosion, for M. Berthelot and Prof. Dixon have independently found that the rapidity in the case of the acetylene detonating mixture is but slightly greater than in the mixtures of oxygen with ethylene or marsh gas, and much less than in the case of a mixture of hydrogen and oxygen. Prof. Meyer suggests that the smaller amount of hydrogen contained in acetylene than the other hydrocarbons, resulting in the production of less water vapour and relatively more carbon dioxide, together with the fact that the theoretical temperature of the combustion calculated from existing thermal data, is extremely high in the case of acetylene, may afford some explanation of the extraordinary energy developed during the explosion of the latter.

A PURE white di-sulphide of tin has been obtained by Dr. Schmidt in the laboratory of the Berlin University, which is further distinguished by the property of being readily soluble in ammonium carbonate. It may easily be prepared as follows: Metallic tin is first dissolved in hydrochloric acid, and the stannous chloride oxidised by digestion with nitric acid to stannic chloride, and the excess of acid largely removed by evaporation. After dilution with water the tin is precipitated as the ordinary yellow sulphide by sulphuretted hydrogen. The washed precipitate is next freed from traces of arsenic by solution in concentrated hydrochloric acid and reprecipitating the diluted and filtered solution with sulphuretted hydrogen. The well-washed yellow precipitate is then digested with a large excess of ammonium hydrate for some days at the ordinary temperature, when the whole of it eventually dissolves except small traces of the black sulphides of lead and bismuth. Upon diluting the clear ammoniacal solution and neutralising it with dilute sulphuric acid, an almost perfectly white precipitate is obtained. This precipitate dissolves at once almost completely in ammonium carbonate, and upon again neutralising with dilute sulphuric acid the disulphide precipitated is pure white. This new form of stannic sulphide is very voluminous, and it apparently owes its absence of colour and greater bulk to the fact that stannic sulphide here exists either in a different state of molecular aggregation or of hydration. It is significant that upon drying it becomes amber-yellow and loses its property of dissolving in ammonium carbonate.

THE additions to the Zoological Society's Gardens during the past week include a Lesser White-nosed Monkey (*Cercopithecus pelaurista*), a Pel's Owl (*Scotopelia peli*), an Angolan Vulture (*Gypohierax angolensis*), a Black Kite (*Milvus migrans*), a Buzzard (*Buteo*, sp. inc.) from West Africa, presented by Mr. C. B. Mitford; two — Baboons (*Cynocephalus*, sp. inc.) from East Africa, presented by Mr. Charles Palmer; a Chilean Sea Eagle (*Geranoctetus melanoleucus*) from South America, presented by the Rev. Fred L. Curne; two Bronze-winged Pigeons (*Phaps chalcoptera*) from Australia, presented by Mrs. Amy Jones; ten Surinam Toads (*Pipa americana*) from Surinam, presented by Mr. F. E. Blaauw; five Three-streaked Euprepes (*Euprepes trivittatus*) from South Africa, presented by Mr. J. E. Matcham; a Muscat Gazelle (*Gazella muscatensis*) from Muscat, an Echinida (*Echinida hystrix*) from New South Wales, deposited; four Lapwings (*Vanellus cristatus*), British, purchased.

OUR ASTRONOMICAL COLUMN.

OBSERVATIONS OF THE TRANSIT OF MERCURY.—Several French astronomers made preparations for observing the recent transit of Mercury across the sun, but the weather conditions on the other side of the Channel were just as unfavourable as they were here. The current *Comptes rendus* contains a brief note on the transit, by M. Trouvelot. This observer saw Mercury projected upon the sun at 4h. 12m. The planet was sharply defined, and appeared as a circular, intensely black, spot on the luminous background of the sun. In spite of careful observation, M. Trouvelot was unable to detect any trace of a luminous ring such as he observed round the planet during the transit of 1878. The unfavourable conditions of observation, however, are sufficient to explain the absence of the phenomenon.

Dr. Janssen also contributes a note on the transit of Mercury to *Comptes rendus*. He intended to look particularly for the "black-drop" observed during the transit of Venus in 1874, but clouds prevented the observation.

EPHEMERIS OF ENCKE'S COMET.—The following positions for Encke's Comet during this year are from an ephemeris given by Dr. O. Backlund in the *Astronomische Nachrichten*, No. 3263. The comet will pass perihelion on February 4, 1895. In the year 1862, its perihelion passage occurred on February 6.

Ephemeris for oh. Berlin Mean Time.

1894.	R.A. app. h. m. s.	Decl. app.
Nov. 22 ...	22 35 54.79	+ 9 6 51.0
" 24 ...	33 25 02	8 40 53.6
" 26 ...	31 7 93	8 15 59.1
" 28 ...	29 3'11	7 52 9.1
" 30 ...	27 9'98	7 29 24.0
Dec. 2 ...	25 28'18	7 7 43.2
" 4 ...	23 57'09	6 47 5.3
" 6 ...	22 36 02	6 27 27.9
" 8 ...	21 24'29	6 8 48.5
" 10 ...	20 21'19	5 51 3.6
" 12 ...	19 25'94	5 34 8.3
" 14 ...	18 37'75	5 17 57.7
" 16 ...	17 55'77	5 2 25.7
" 18 ...	17 19'11	4 47 25.7
" 20 ...	16 46'82	4 32 50.6
" 22 ...	16 17'82	4 18 32.0
" 24 ...	15 50'85	4 4 19.0
" 26 ...	15 24'59	3 49 59.2
" 28 ...	14 57'30	3 35 18.2
" 30 ...	22 14 27.09	+ 3 19 58.3

RECENT OBSERVATIONS OF JUPITER.—Prof. E. E. Barnard communicates to this month's *Astronomy and Astro-Physics* an account of his recent observations of the great red spot and other markings on Jupiter. The following points with regard to these features are of interest to observers: "The surface of Jupiter is very strongly marked, during this opposition, by two broad reddish belts, one on each side of the equator, and a broad white belt between them at the equator. The great red spot is fairly distinct in outline, though quite pale—a feeble red. The great bay in the south equatorial belt north of the red spot is still persistent and well marked." Prof. Barnard has observed a number of small black and white spots in Jupiter's northern hemisphere. Two of these objects, a black and a white spot, can easily be seen opposite the great red spot on the planet's disc. Prof. Barnard's measures indicate that the white spot will be in conjunction with the dark one about the middle of January next year, but as the two objects are not exactly on the same parallel, they will only graze in passing one another. The black spot appears to have about the same rotation period of the great red spot. Numerous white spots have been observed in Jupiter's southern hemisphere. A few dusky markings have also been seen on the great white equatorial belt.

THE NEW CYPRESS OF NYASALAND.

IN the most easterly corner of the British Protectorate of Nyasaland, immediately south of Lake Shirwa (between 35° and 36° E. lat. and a little north of 16° S. lat.), lies the large isolated mountain-mass of Milanji. From the plains which surround it the land rises gradually to a height of about 3000 feet, and for 7/8s the lower spurs of the mountain. Above these outlier the mountain is carried up another 3000 feet in abrupt elevation only broken in places where the larger streams flow down.

rampart of cliffs borders the upper plateau of Milanji, which is elevated about 6000 feet above the sea-level, and is of considerable extent, though split up into various portions by ravines and precipices. In the centre of the plateau peaks rise to a further height of 3500 feet, thus giving Milanji a total elevation of nearly 10,000 feet above the sea-level.<sup>1</sup>

Mr. Alexander Whyte, the naturalist attached to the staff of Mr. H. H. Johnston, C.B., H.B.M. Commissioner and Consul-General, who usually resides at Zomba, made a botanical excursion to Milanji in 1892, and obtained a good series of the mountain-plants. An account of this collection, prepared by the officers of the Botanical Department in the British Museum, is given in a recently issued part of the *Botanical Transactions* of the Linnean Society.

photograph, and kindly lent to us by the Linnean Society. The timber is of a pale reddish colour, of excellent quality, and easily worked. The bark on the old trees is of great thickness, consisting of layers which are annually shed and renewed. The foliage recalls that of the juniper, while the fruits or cones, which are crowded from four to six together on short lateral shoots, are about three-quarters of an inch long, and from that to one inch wide when open. They consist of four thick woody scales, united below, spreading above, and bearing at their bases on the internal surface a number of small winged seeds.

Examination of the specimens sent home has shown that we are here dealing with a new species of *Widdringtonia*, a small genus of conifers allied to the cypress and juniper. Mr. Whyte's discovery has considerable scientific interest, from the fact that



The Milanji Cypress (*Widdringtonia zombaensis*).

Among the many plants new to science discovered by Mr. Whyte, and described in this memoir, one is of special interest, owing to its importance from an economic point of view.

In his exploration of the mountain, Mr. Whyte was much impressed with "a large cypress," which formed the most striking feature of the upper plateau. One prostrate trunk, and that by no means the largest seen, measured 140 feet in length, with a diameter of 5½ feet at six feet from the base, and had a clean, straight stem of ninety feet. In other cases long straggling branches are given off nearer the base, as shown in the accompanying figure, prepared by Mr. Worthington Smith from a

it extends the geographical range of the genus, hitherto known only from South Africa, Madagascar and Mauritius, into tropical Africa; and his name has been fittingly associated with the plant, which will henceforth be known as *Widdringtonia whytei*.

Its nearest ally, *W. juniperoides*, is found in the Cederberg Mountains, Cape Colony, where, according to a note by Parlature in De Coudolle's *Prohemus* (vol. xvi. part 2, p. 442), it once formed large forests, but is now rare. The Milanji species is also threatened with extinction; in this case by the bush-fires, the devastating effects of which, Mr. Whyte says, it is deplorable to witness, and which reach even the lofty and almost inaccessible plateau. These fires, originating during the

<sup>1</sup> *Explorations and Discoveries in Southern Nyasaland*, by F. H. Johnston, C.B., H.B.M. Commissioner and Consul-General, London, 1894, p. 102.

dry months of August and September in the villages on the lower slopes of the mountain, gradually creep up the precipitous cliffs from tuft to tuft of dried herbage till they gain the grassy table-lands, and raging over the plain eat their way along the edges of the remaining belts of forest; annually scorching, if not burning, the bark and timber of the outside trees, and killing outright the young seedlings. In exceptionally dry seasons even the damper gorges are invaded, and Mr. Whyte describes hundreds of giant trees lying prostrate and piled on each other in all stages of destruction. We are glad to learn that Mr. Johnston, under whose directions Mr. Whyte's exploration was made, has taken steps to prevent a recurrence of such disasters.

*Widdringtonia whytei* promises to be of great economic value from the excellent quality of its timber for building purposes and furniture. It is easily worked, and is moreover a tree of rapid growth, for Mr. Whyte tells us that in a plantation which he has formed near the residency at Zomba, three-year-old seedlings have already reached a height of ten feet.

Seeds of the new conifer, forwarded by Mr. Whyte, reached this country in 1893, and healthy seedlings have been raised in the Royal Gardens, Kew; in the Botanical Gardens, Edinburgh; in Messrs. Veitch's Nurseries; and in the Zoological Society's Gardens; so that we may hope to see this fine tree ultimately established in Europe.

The existence of a large cedar-like tree on Milanji was first discovered by the Rev. Robert Acland, of the Blantyre Mission, who visited the mountain in 1889 for the purpose of founding a Mission Station. In Mr. Buchanan's narrative of his journey along the southern frontier of Nyasaland (*Proc. R. Geogr. Soc.* 1891, p. 271) it will be found alluded to as "a species of pine-tree" existing in the ravines on the north-eastern slope. In the latter part of 1891, Dr. W. A. Scott and Mr. Henry Brown made the first ascent of Milanji, going up the southern face, and ascertained the existence of large forests of the so-called "pine" at an altitude of 6000 feet above sea-level. A month later Mr. Whyte succeeded in ascending to the trees, and, as already stated, obtained the first specimens which reached this country, and enabled the tree to be classified and described.

When Fort Lister was founded in 1893, the cedar forests were found to come down to a much lower altitude on the north-east slopes of Mt. Milanji, and advantage was at once taken of this to procure a supply of the timber. It was cut up on the spot, and the planks carried to Zomba, where they have been employed for many purposes. When the residency at Zomba was re-roofed with iron this timber was used for the woodwork. There can be, therefore, no question about the value of this discovery.

#### SCHIAPARELLI ON MARS.

THE following extracts from a translation communicated to *Astronomy and Astro-Physics*, by Prof. W. H. Pickering, are of special interest at the present time, for they set forth Schiaparelli's observations of the planet Mars, and show his views on various Martian phenomena. The original article was contributed by this keen observer to *Natura et Arte*.

##### THE POLAR CAPS.

Many of the first astronomers who studied Mars with the telescope, noted on the outline of its disc two brilliant white spots of rounded form and of variable size. In process of time it was observed that whilst the ordinary spots upon Mars were displaced rapidly in consequence of the planet's daily rotation, changing in a few hours both their position and their perspective, that the two white spots remained sensibly motionless at their posts. It was concluded rightly from this, that they must occupy the poles of rotation of the planet, or at least must be found very near to them. Consequently they were given the name of polar caps or spots. And not without reason is it conjectured, that these represent upon Mars an immense mass of snow and ice, similar to that which to-day prevents navigators from reaching the poles of the Earth. We are led to this conclusion not only by the analogy of aspect and of place, but also by another important observation.

As things stand, it is manifest, that if the white polar spots of Mars represent snow and ice, they should continue to decrease in size with the approach of summer in those places, and increase during the winter. Now this very fact is observed in the most evident manner. In the second half of the year 1892 the southern polar cap was in full view; during that interval, and especially in the months of July and August, its rapid diminu-

tion from week to week was very evident, even to those observing with common telescopes. This snow (for we may well call it so), which in the beginning reached as far as latitude 70°, and formed a cap of over 2000 kilometres (1200 miles) in diameter, progressively diminished, so that two or three months later little more of it remained than an area of perhaps 300 kilometres (180 miles), at the most, and still less was seen later in the last days of 1892.<sup>1</sup> In the months the southern hemisphere of Mars had its summer; the summer solstice occurring upon October 13. Correspondingly the mass of snow surrounding the northern pole should have increased; but this fact was not observable, since that pole was situated in the hemisphere of Mars which was opposite to that facing the Earth. The melting of the northern snow was seen in its turn in the years 1882, 1884, and 1886.

The southern snow, however, presents this peculiarity, that the centre of its irregularly rounded figure does not coincide exactly with the pole, but is situated at another point, which is nearly always the same, and is distant from the pole about 300 kilometres (180 miles) in the direction of the Mare Erythræum. From this we conclude that when the area of the snow is reduced to its smallest extent, that the south pole of Mars is uncovered; and therefore, perhaps, the problem of reaching it upon this planet is easier than upon the Earth. The southern snow is in the midst of a huge dark spot, which with its branches occupies nearly one-third of the whole surface of Mars, and is supposed to represent its principal ocean. Hence the analogy with our arctic and antarctic snows may be said to be complete, and especially so with the antarctic one.

The mass of the northern snow-cap of Mars is on the other hand centred almost exactly upon its pole. It is located in a region of yellow colour, which we are accustomed to consider as representing the continent of the planet. From this arises a singular phenomenon which has no analogy upon the Earth. At the melting of the snows, accumulated at that pole during the long night of ten months and more, the liquid mass produced in that operation is diffused around the circumference of the snowy region, converting a large zone of surrounding land into a temporary sea, and filling all the lower regions. This produces a gigantic inundation, which has led some observers to suppose the existence of another ocean in those parts, but which does not really exist in that place, at least as a permanent sea. We see then (the last opportunity was in 1884) the white spot of the snow surrounded by a dark zone, which follows its perimeter in its progressive diminution, upon a constantly diminishing circumference. The outer part of this zone branches out into dark lines, which occupy all the surrounding region, and seem to be distributory canals, by which the liquid mass may return to its natural position. This produces in these regions very extensive lakes, such as that designated upon the map by the name of *Lacus Hyperboreus*; the neighbouring interior sea called *Mare Acidaliæ* becomes more black, and more conspicuous. And it is to be remembered as a very probable thing, that the flowing of this melted snow is the cause which determines principally the hydrographic state of the planet, and the variations that are periodically observed in its aspect. Something similar would be seen upon the Earth, if one of our poles came to be located suddenly in the centre of Asia or of Africa. As things stand at present, we may find a miniature image of these conditions in the flooding that is observed in our streams at the melting of the Alpine snows.

Other white spots of a transitory character, and of a less regular arrangement, are formed in the southern hemisphere, upon the islands near the pole, and also in the opposite hemisphere, whitish regions appear at times surrounding the north pole, and reaching to 50° and 55° of latitude. They are perhaps transitory snows, similar to those which are observed in our latitudes. But also in the torrid zone of Mars are seen some very small white spots more or less persistent. Perhaps we may be permitted to account for these by the existence of a mountain capable of supporting extensive ice-fields. The existence of such a mountain has been supposed also by some recent observers, founded upon other facts.

##### MARTIAN METEOROLOGY.

As has been stated, the polar snows of Mars prove, in an incontrovertible manner, that this planet, like the Earth, is surrounded by an atmosphere capable of transporting vapour from one place to another. These snows are in fact precipitations of

<sup>1</sup> A note on the melting of the southern snow-cap this year appears in the last number of NATURE (p. 61).

vapour, condensed by the cold, and carried with it successively. How carried with it, if not by atmospheric movement? The existence of an atmosphere charged with vapour has been confirmed also by spectroscopic observations, principally those of Vogel; according to which this atmosphere must be of a composition differing little from our own, and above all *very rich in a new vapour*. This is a fact of the highest importance, because from it we can rightly affirm with much probability, that to water, and to no other liquid is due the seas of Mars and its polar snows. When this conclusion is assured beyond all doubt, another one may be derived from it, of not less importance—that the temperature of the Arcean climate, notwithstanding the greater distance of that planet from the Sun, is of the same order as the temperature of the terrestrial one. Because, if it were true, as has been supposed by some investigators, that the temperature of Mars was on the average very low (from 50° to 60° below zero!), it would not be possible for water vapour to be an important element in the atmosphere of that planet, nor could water be an important factor in its physical changes; but would give place to carbonic acid, or to some other liquid whose freezing point was much lower.

The elements of the meteorology of Mars seem then to have a close analogy to those of the Earth. But there are not lacking, as might be expected, causes of dissimilarity. From circumstances of the smallest moment, nature brings forth an infinite variety in its operations. Of the greatest influence must be the different arrangement of the seas and the continents upon Mars, and upon the Earth. We have already emphasised the fact of the extraordinary periodical flood, which at every revolution of Mars inundates the northern polar region at the melting of the snow. Let us now add that this inundation is spread out to a great distance by means of a network of canals, perhaps constituting the principal mechanism of not the only one by which water (and with its organic life) may be diffused over the arid surface of the planet. Because on Mars it rains very rarely, or perhaps even, it does not rain at all.

The atmosphere of Mars is nearly perpetually clear, and sufficiently transparent to permit one to recognise, at any moment whatever, the contours of the seas and continents, and more than that, even the minor configurations. Not indeed that vapours of a certain degree of opacity are lacking, but they offer very little impediment to the study of the topography of the planet. Here and there we see appear from time to time a few whitish spots, changing their position and their form, rarely extending over a very wide area. They frequent by preference a few regions, such as the islands of the *Mare Australe*, and on the continents, the regions designated on the map with the names of *Elysium* and *Tempe*. Their brilliancy generally diminishes and disappears at the meridian hour of the place, and is reinforced in the morning and evening, with very marked variations. It is possible that they may be layers of cloud, because the upper portions of terrestrial clouds, where they are illuminated by the Sun, appear white. But various observations lead us to think that we are dealing rather with a thin veil of fog, instead of a true nimbus cloud, carrying storms and rain. Indeed it may be merely a temporary condensation of vapour, under the form of dew or hoar-frost.

Accordingly, as far as we may be permitted to argue from the observed facts, the climate of Mars must resemble that of a clear day upon a high mountain. By day a very strong solar radiation hardly mitigated at all by mist or vapour, by night a copious radiation from the soil towards celestial space, and because of that a very marked refrigeration. Hence a climate of extremes, and great changes of temperature from day to night, and from one season to another. And as on the Earth at altitudes of 5000 and 6000 metres (17,000 to 20,000 feet), the vapour of the atmosphere is condensed only into the solid form, producing those whitish masses of suspended crystals, which we call cirrus clouds, so in the atmosphere of Mars, it would be rarely possible (or would even be impossible) to find collections of cloud capable of producing rain of any consequence. The variation of the temperature from one season to another would be notably increased by their long duration, and thus we can understand the great freezing and melting of the snow, which is renewed in turn at the poles at each complete revolution of the planet around the Sun.

#### TOPOGRAPHICAL TINTS.

In its general topography Mars does not present any analogy with the Earth. A third of its surface is occupied by the great *Mare Australe*, which is strown with many islands, and the

continents are cut up by gulfs and ramifications of various forms. To the general water system belongs an entire series of small internal seas, of which the Hadriacum and the Tyrrhenum communicate with it by wide mouths, whilst the Cimmerium, the Sirenum, and the Solis Lacus are connected with it only by means of narrow canals. We shall notice in the first four a parallel arrangement, which certainly is not accidental, as also not without reason is the corresponding position of the peninsulas of Ausonia, Hesperia, and Atlantis. The colour of the seas of Mars is generally brown, mixed with grey, but not always of equal intensity in all places, nor is it the same in the same place at all times. From an absolute black it may descend to a light grey, or to an ash colour. Such a diversity of colours may have its origin in various causes, and is not without analogy also upon the Earth, where it is noted that the seas of the warm zone are usually much darker than those nearer the pole. The water of the Baltic, for example, has a light, muddy colour, that is not observed in the Mediterranean. And thus in the seas of Mars we see the colour become darker when the sun approaches their zenith, and summer begins to rule in that region.

All of the remainder of the planet, as far as the north pole, is occupied by the mass of the continents, in which, save in a few areas of relatively small extent, an orange colour predominates, which sometimes reaches a dark red tint, and in others descends to yellow and white. The variety in this colouring is in part of meteorological origin, in part it may depend on the diverse nature of the soil, but upon its real cause it is not as yet possible to frame any very well-grounded hypothesis. Some have thought to attribute this colouring to the atmosphere of Mars, through which the surface of the planet might be seen coloured, as any terrestrial object becomes red, when seen through red glass. But many facts are opposed to this idea, among others, that the polar snows appear always of the purest white, although the rays of light derived from them traverse twice the atmosphere of Mars under great obliquity. We must then conclude that the Arcean continents appear red and yellow, because they are so in fact.

Besides these dark and light regions, which we have described as seas and continents, and of the nature of which there is at present scarcely left any room for doubt, some others exist, truly of small extent, of an amphibious nature, which sometimes appear yellowish like the continents, and are sometimes clothed in brown (even black in certain cases), and assume the appearance of seas, whilst in other cases their colour is intermediate in tint, and leaves us in doubt to which class of regions they may belong. Thus, all the islands scattered through the *Mare Australe* and the *Mare Erythraum* belong to this category, so too the long peninsula called Deucalionis Regio and Pyrrhæ Regio, and in the vicinity of the *Mare Acidalium* the regions designated by the names of *Baltia* and *Nerigos*. The most natural idea, and the one to which we should be led by analogy, is to suppose these regions to represent huge swamps, in which the variation in depth of the water produces the diversity of colours.

Not without reason, then, have we hitherto attributed to the dark spots of Mars, the part of seas, and that of continents to the reddish areas which occupy nearly two-thirds of all the planet, and we shall find later other reasons which confirm this method of reasoning. The continents form in the northern hemisphere a nearly continuous mass, the only important exception being the great lake called the *Mare Acidalium*, of which the extent may vary according to the time, and which is connected in some way with the inundations which we have said were produced by the melting of the snow surrounding the north pole. To the system of the *Mare Acidalium* undoubtedly belong the temporary lake called *Lacus Hyperboreus* and the *Lacus Niliacus*. This last is ordinarily separated from the *Mare Acidalium* by means of an isthmus or regular dam, of which the continuity was only seen to be broken once for a short time in 1888. Other smaller dark spots are found here and there in the continental area, which we may designate as lakes, but they are certainly not permanent lakes like ours, but are variable in appearance and size according to the seasons, to the point of wholly disappearing under certain circumstances. *Isenius Lacus*, *Lunæ Lacus*, *Trivium Charontis* and *Propontis* are the most conspicuous and durable ones. There are also smaller ones, such as *Lacus Mæris* and *Fons Juventæ*, which at their maximum size do not exceed 100 to 150 kilometres (60 to 90 miles) in diameter, and are among the most difficult objects upon the planet.

## THE CANALS OR CHANNLS.

All the vast extent of the continents is furrowed upon every side by a network of numerous lines or fine stripes of a more or less pronounced dark colour, whose aspect is very variable. These traverse the planet for long distances in regular lines, that do not at all resemble the winding courses of our streams. Some of the shorter ones do not reach 500 kilometres (300 miles), others on the other hand extend for many thousands, occupying a quarter or sometimes even a third of a circumference of the planet. Some of these are very easy to see, especially that one which is near the extreme left-hand limit of our map, and is designated by the name of Nilosyrtris. Others in turn are extremely difficult, and resemble the finest thread of spider's web drawn across the disc. They are subject also to great variations in their breadth, which may reach 200 or even 300 kilometres (120 to 180 miles) for the Nilosyrtris, whilst some are scarcely 30 kilometres (18 miles) broad.

These lines or stripes are the famous canals of Mars, of which so much has been said. As far as we have been able to observe them hitherto, they are certainly fixed configurations upon the planet. The Nilosyrtris has been seen in that place for nearly one hundred years, and some of the others for at least thirty years. Their length and arrangement are constant, or vary only between very narrow limits. Each of them always begins and ends between the same regions. But their appearance and their degree of visibility vary greatly, for all of them, from one position to another, and even from one week to another, and these variations do not take place simultaneously and according to the same laws for all, but in most cases happen apparently capriciously, or at least according to laws not sufficiently simple for us to be able to unravel. Often one or more become indistinct, or even wholly invisible, whilst others in their vicinity increase to the point of becoming conspicuous even in telescopes of moderate power.

Every canal<sup>1</sup> (for now we shall so call them) opens at its ends, either into a sea, or into a lake, or into another canal, or else into the intersection of several other canals. None of them have yet been seen cut off in the middle of the continent, remaining without beginning or without end. This fact is of the highest importance. The canals may intersect among themselves at all possible angles, but by preference they converge towards the small spots to which we have given the name of lakes. For example, seven are seen to converge in Lacus Phœnicis, eight in Trivium Charontis, six in Lunæ Lacus, and six in Ismenius Lacus.

The normal appearance of a canal is that of a nearly uniform stripe, black, or at least of a dark colour, similar to that of the seas, in which the regularity of its general course does not exclude small variations in its breadth, and small sinuities in its two sides. Often it happens that such a dark line opening out upon the sea is enlarged into the form of a trumpet, forming a huge bay, similar to the estuaries of certain terrestrial streams. The Margaritifer Sinus, the Aonijs Sinus, the Auroræ Sinus, and the two horns of the Sabæus Sinus are thus formed, at the mouths of one or more canals, opening into the Mare Erythræum or into the Mare Australe. The largest example of such a gulf is the Syrtis Major, formed by the vast mouth of the Nilosyrtris, so called. This gulf is not less than 1800 kilometres (1100 miles) in breadth, and attains nearly the same depth in a longitudinal direction. Its surface is little less than that of the Bay of Bengal. In this case we see clearly the dark surface of the sea continued without apparent interruption into that of the canal. Inasmuch as the surfaces called seas are truly a liquid expanse, we cannot doubt that the canals are a simple prolongation of them, crossing the yellow areas or continents.

Of the remainder, that the lines called canals are truly great furrows or depressions in the surface of the planet, destined for the passage of the liquid mass, and constituting for it a true hydrographic system, is demonstrated by the phenomena which are observed during the melting of the northern snows. We have already remarked that at the time of melting they appeared surrounded by a dark zone, forming a species of temporary sea. At that time the canals of the surrounding region become blacker and wider, increasing to the point of converting, at a certain time, all of the yellow region comprised between the edge of the snow and the parallel of 60° north latitude, into numerous islands of small extent. Such a state of things does not cease, until the snow, reduced to its minimum area, ceases

<sup>1</sup> The correct translation of the Italian word *canale*, used with reference to the streaks on Mars, is channel or strait, and not canal.

to melt. Then the breadth of the canals diminishes, the temporary sea disappears, and the yellow region again returns to its former area. The different phases of these vast phenomena are renewed at each return of the seasons, and we have been able to observe them in all their particulars very easily during the oppositions of 1882, 1884, and 1886, when the planet presented its northern pole to terrestrial spectators. The most natural and the most simple interpretation is that to which we have referred, of a great inundation produced by the melting of the snows—it is entirely logical, and is sustained by evident analogy with terrestrial phenomena. We conclude, therefore, that the canals are such in fact, and not only in name. The network formed by these was probably determined in its origin in the geological state of the planet, and has come to be slowly elaborated in the course of centuries. It is not necessary to suppose them the work of intelligent beings, and notwithstanding the almost geometrical appearance of all of their system, we are now inclined to believe them to be produced by the evolution of the planet, just as on the Earth we have the English Channel and the Channel of Mozambique.

## THE GEMINATION OF THE CANALS.

The most surprising phenomenon pertaining to the canals of Mars is their gemination, which seems to be produced principally in the months which precede, and in those which follow the great northern inundation, at about the times of the equinoxes. In consequence of a rapid process, which certainly lasts at most a few days, or even perhaps only a few hours, and of which it has not yet been possible to determine the particulars with certainty, a given canal changes its appearance, and is found transformed through all its length, into two lines or uniform stripes, more or less parallel to one another, and which run straight and equal with the exact geometrical precision of the two rails of a railroad. But this exact course is the only point of resemblance with the rails, because in dimensions there is no comparison possible, as it is easy to imagine. The two lines follow very nearly the direction of the original canal, and end in the place where it ended. One of these is often superposed as exactly as possible upon the former line, the other being drawn anew, but in this case the original line loses all the small irregularities and curvature that it may have originally possessed. But it also happens that both the lines may occupy opposite sides of the former canal, and be located upon entirely new ground. The distance between the two lines differs in different geminations, and varies from 600 kilometres (360 miles) and more, down to the smallest limit at which two lines may appear separated in large visual telescopes—less than an interval of 50 kilometres (30 miles). The breadth of the stripes themselves may range from the limit of visibility, which we may suppose to be 30 kilometres (18 miles), up to more than 100 kilometres (60 miles). The colour of the two lines varies from black to a light red, which can hardly be distinguished from the general yellow background of the continental surface. The space between is for the most part yellow, but in many cases appears whitish. The gemination is not necessarily confined only to the canals, but tends to be produced also in the lakes. Often one of these is seen transformed into two short, broad, dark lines parallel to one another, and traversed by a yellow line. In these cases the gemination is naturally short, and does not exceed the limits of the original lake.

The gemination is not shown by all at the same time, but when the season is at hand, it begins to be produced here and there, in an isolated, irregular manner, or at least without any easily recognisable order. In many canals (such as the Nilosyrtris for example) the gemination is lacking entirely, or is scarcely visible. After having lasted for some months, the markings fade out gradually and disappear until another season equally favourable for their formation. Thus it happens that in certain other seasons (especially near the southern solstice of the planet) that few are seen, or even none at all. In different oppositions the gemination of the same canal may present different appearances as to width, intensity and arrangement of the two stripes, also in some cases the direction of the lines may vary, although by the smallest quantity, but still deviating by a small amount from the canal with which they are directly associated. From this important fact it is immediately understood that the gemination cannot be a fixed formation upon the surface of Mars, and of a geographical character like the canals.

The observation of the geminations is one of the greatest difficulty, and can only be made by an eye well practised in

...w... of free education and of... it is that it was not seen before 1882. It is... have transpired since that time, it has been... at eight or ten observatories. Nevertheless... that these phenomena are real, and... even imposture, those who declare that...

LAWS OF THE GEMINATION OF CANALS.

Having then to the principle that in the explanation of natural phenomena, it is universally agreed to begin with the simplest suppositions, the first hypotheses on the nature and cause of the geminations have for the most part put in operation only the laws of inorganic nature. Thus the gemination is supposed to be due either to the effects of light in the atmosphere of Mars, or to ideal effusions produced by vapours in various manners, or to glacial phenomena of a perpetual water, to which it is known all the planets will be condensed, or to diurnal cracks in its surface, or to single cracks of which the images are founded by the effect of smoke existing in long lines and blown laterally by the wind. The examination of these numerous suppositions leads us to conclude that none of them seem to correspond entirely with the observations, either in whole or in part. Some of these hypotheses, however, have been proposed had their authors been able to see the geminations with their own eyes.

It is far easier to explain the gemination if we are willing to intrude in the field pertaining to organic nature. Here the field of plausible suppositions is immense, being capable of making an infinite number of combinations capable of satisfying the appearance even of the most and simplest means. Changes of vegetation, a very small area, or the production of animals, also a very small number of animals, may well be rendered visible at a distance of 1000 miles. An observer placed in the moon would be able to see the appearance at the times in which agricultural operations are carried out upon one vast plain—the seed time and the harvesting of the harvest. In such a manner also would the work of the plough on the great steppes of Europe and Asia be rendered visible at the distance of Mars—by a variety of changes. A similar system of operations produced in that planet may therefore be rendered visible to us. But how difficult for the Lullurians and Arcans to be able to imagine the possibility of such changes of appearance, without having first obtained some practical knowledge of terrestrial nature! So difficult, when we know little of the physical state of Mars, and nothing of its organic world, the great liberty of possible supposition renders at least all explanations of this sort, and especially the guesses, of little to the acquisition of well-founded notions. All that we may hope, then, with true uncertainty of the result, will gradually diminish, demonstrating, if not with the geminations, at least what they cannot be. We trust that the nobleman who Galileo called "the courtesy of rain," that is, snow, came from an unexpected source, may wish to follow in the investigation at first believed in by the astronomers, and of which we have a knowledge of the most advanced chemistry. Let us therefore hope to see...

EARLY BRITISH RACES.

II.

[N]umerous... skeletons of this period have been found... the best known is the famous Neanderthal skeleton, discovered near Dusseldorf. Upon this specimen... have been prudent to have based the character of the early cave men, because the circumstances under which it was found have given rise to some doubts... it is by some considered to be of the same type and which we have to deal with. Where the characters of the bones with others presenting similar characters, and where there is no doubt as to the age, when they are found, the evidence it affords is considerably better. The fact of two skeletons at Spy in Belgium in 1868, is of most important, both in our knowledge and in determining the characters of the early man from the bones of the specimens. The fragment of the Neanderthal skeleton, though very imperfect, long and prominent only in the jaw, having a cephalic index of 72.70, the glabella low, and the orbital pro-

cesses are enormously developed, the forehead is remarkably flattened, the occiput is prominent, and the elevation of the whole vault is extremely low. The skulls of both the Spy skeletons are also long and narrow, one having a cephalic index of 70, and the other of 74.6; the superciliary ridges and also the glabella are very prominent; the frontal sinuses are large, the external orbital processes are thick and projecting, the ridges on the frontal, parietal, and temporal bones for muscular attachments are strongly developed; the occiput is prominent with a well-marked "torus" at the junction of the curved muscular ridges, which are also large; the cranial vault is low and flattened from above downwards, and presents an antero-posterior curve very similar to the outline of the side of an ellipse. The malar bones have thick and broad orbital processes, the orbital cavities are deep, and the orbital breadth is but slightly inferior to the width; the zygomatic arches are large. The size of the lower molar teeth increases from before backwards, the first molar being the smallest, and the wisdom or last molar the largest. The lower jaw shows no prominence of the chin; indeed, it recedes somewhat from the alveolar border downwards, and has a symphyseal angle of 111°. It is thus a counterpart of the Naulette mandible, which presents similar characters, both as regards the molars and symphyseal angle. The stature of the Neanderthal skeleton, estimated from the length of the femur, is 1.604 metres (5 ft. 3 in.), and from the humerus 2 cm. less; that of the Spy skeleton (there being only one of these in which the long bones could be measured), estimated from the femur and tibia, is 1.504 metres (4 ft. 11½ in.), and from the femur alone, 1.540 metres (5 ft. 0½ in.). The stature of the Naulette skeleton, that of a woman, estimated from the ulna, is 1.433 metres (4 ft. 4½ in.), and shows that she also was very short.

The long bones of both upper and lower limbs of the Neanderthal skeleton are characterised by their unusual thickness, and the great development of the elevations and depressions for the attachment of muscles, the articular ends of the femur are also of larger size than usual. The femur of the Spy skeleton is more arched forward than usual, it is somewhat flattened from side to side in section, and the articular ends are of large size, especially the lower, in which there is enormous antero-posterior development of the articular surface of the condyles. The tibia is actually and proportionately very short, flattened laterally, and therefore platymeric. The bones generally are remarkable for their stoutness, and indicate that the muscles attached to them were large and powerful, especially those of the lower limb. In respect to the platymericism of the tibia, the Spy skeleton corresponds to the Langerie Basse and Madelaine bones from the Perigord Caves, and confirms in a very positive manner the evidence of their surroundings and reliefs that Paleolithic people were sons of the chase, as it is connected with the development of the tibialis posticus muscle, and not a race character.

Portions of skulls and skeletons found in various parts of the continent, associated with Paleolithic implements and animal remains of late Pleistocene times, support the peculiar race characters of the specimens just described. The osteological remains of Paleolithic age now in hand from different parts of the continent seem to me to afford sufficient evidence of the existence, both in drift and in cave deposits, of a race of men possessing physical characters quite distinct from those of the Neolithic period, which we will next consider. The assertions which have been made at various times with respect to individual specimens being more or less pathological, will, to my mind, not hold good when we find specimen after specimen from the same deposits showing similar characters. It may not be possible, in some cases, to establish the fact that the specimen cannot have been deposited at a later period in the stratum in which it is found, but a careful examination of each specimen, such, for example, as Prof. Topinard has made of the mandible from Naulette, shows anatomical conditions which, not in one respect but in several, indicate as distinctly as his implements the progress of man's evolution, and preclude the idea of this type being a variety of the Neolithic people. The specimens of Paleolithic man seem to me to show identity of race, whether they have been found in the river drift or in the Paleolithic stratum of caves. The idea of Prof. Boyd Dawkins, that the implements found in the river drifts and later Paleolithic deposits of caves, give evidence of there being two Paleolithic races, is not supported by the osteological remains yet to hand. From extensive examination of ancient British skeletons,



I do not consider that there is any evidence of the existence of the direct descendants of Palæolithic man among the osteological remains of Neolithic or subsequent date in Britain. Here he seems to be extinct as many of his contemporary animals of the late Pleistocene period; this may not be the case with respect to his existence in other parts of Europe. Whether he has still representatives in America, as surmised by Prof. Boyd Dawkins and some American anthropologists, is outside the scope of the present lecture.

The next period at which we find remains of man in Britain is separated from the previous one by a space of time measurable only by the changes occurring in the interval. Great Britain and Ireland had once more become islands almost of the same dimensions as at the present day, with a moister and more continental climate—hotter in summer and colder in winter—abundant forests extending as far as the extreme north of Scotland, and numerous morasses and peat bogs. Not less signi-

From these camps have been obtained spindle whorls and bone combs toothed at one end, showing that they were acquainted with the arts of spinning and weaving, bone needles, fragments of coarse pottery, made by hand and not turned on the wheel, either plain or ornamented with simple lines or dots, bones of the roe, red deer, dog, goat, short-horned ox, horse, pig, &c., and fish, but no trace of metal is found. Of all their implements the stone axe is perhaps the most important. Flints used for implement-making were now often quarried from below the soil, with antlers of deer as picks. The implements were distributed over districts far removed from where they were made, probably by barter, Jadeite or Nephrite implements having been found in Britain, which Mr. Rudler has shown may have been obtained from Switzerland, Silesia, or Styria. They possessed canoes formed out of the trunks of trees, in which they probably reached this country from the continent.

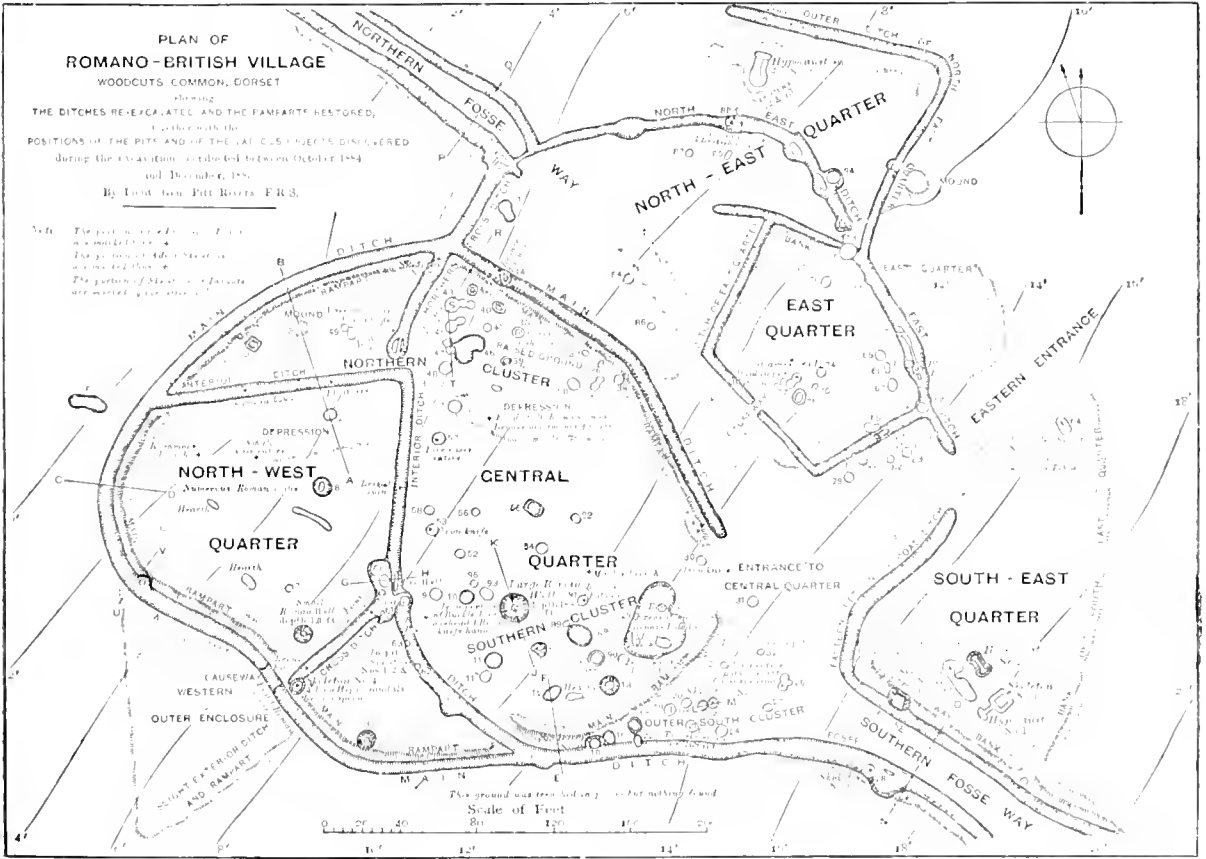

FIG. 16.

ficant was the advance in civilisation man had made since Palæolithic times, as we now find him dwelling in fixed habitations, with a knowledge of the arts and agriculture, with domestic animals, and with stone implements of a much more developed character, as he had now learned to smooth them by grinding and polishing.

These Neolithic people, as they are called, lived in camps, surrounded by ditches and ramparts, on the tops or sides of hills, or in suitable valleys. The camps were intersected with numerous drains or ditches, which would show that the climate was moist. Inside the camps they hollowed out pits, in or round which they dwelt. Excellent examples of the encampments or villages of the same Neolithic people, but of a much later date, have been discovered and described by General Pitt-Rivers in his excavations near Rushmore, from the main outlines of which some idea may be formed of what their earlier dwelling-places were probably like (Fig. 16).

They buried their dead in caves, which had been used a dwellings, in their camps, and in chambered and unchambered barrows. The most characteristic British barrows of this period are of long oval shape, and often of large size, but Neolithic interments are also found in circular barrows. The dead were buried in a contracted or crouched position, and with them, stone and bone implements of various kinds, and pottery, which would seem to show that these articles were intended for the use of the dead or their spirits. Relics of art in the form of carvings are seldom found, and are very inferior to those of late Palæolithic times.

Osteological remains of the Neolithic people are distributed all over Britain, from the south of England to the extreme north of Scotland. They are most numerous in the south-west of England, especially in Wilts and Gloucestershire, the part of the country occupied by the Drobuni, or Silures, at the beginning of the historic period. They have been found in considerable

numbers in Yorkshire, Derbyshire, and Stafford. Huxley and Wilson have described the same race from horned cairns in Caithness, and from other places of Scotland. I have described them from Wiltshire, Yorkshire, Middlesex, and from Orkney.

There is some doubt of their having been found yet at an early period in Ireland, as Prof. Macalister informs me that he has not recognised them in Ireland, where there are no long barrows. Sir William Wild, on the other hand, recognised Neolithic skulls from Somersetshire as identical with certain ancient Irish skulls. Any skulls from Ireland I have seen, which have shown characters similar to the Neolithic skulls from England, are of later date, but Huxley describes them from chambered tombs, peat mosses, and river deposits of Ireland. I think we may conclude, as regards Ireland, that although it is doubtful whether the Neolithic people were there at as early a date as in Britain, they were certainly there later.

The characters of the skeletons are well marked. The skull is large and well formed, the calvaria is long and proportionally narrow, having a cephalic index of about 70, and of oval shape. The superciliary ridges and glabella are moderately or even feebly developed, the forehead is well formed, narrow, and curves gracefully to the occiput, which is full and rounded. The upper margins of the orbits are thin, and the malar bones are never prominent; the profile of the face is vertical, and there is no tendency to prognathism; the chin is prominent, the symphyseal angle is from 70 to 80; the length of the face from the root of the nose is comparatively short, but as a whole the face is oval in form; the jaws are small and fine, the teeth are of medium size, and generally in a good state of preservation, not much worn down. The last molar is always the smallest tooth of that series. The facial characters are mild, and without exaggerated development in any one direction; the same may be said of the calvaria generally. The age of the persons to whom they belong averages, according to Thurnam, fifty-five years, which would seem to indicate that the duration of life was rather short at that time.

The stature of the Neolithic people is short. From Dr. Thurnam's measurements of the femora of twenty-five skeletons, it averages 1.674 m. (5ft. 6in.) by Rollet's formula; but from my own observations of other specimens which have passed through my hands, I am inclined to consider this as too high an average. In their general characters the bones are slender, often with a well-marked *limbus aspera* on the femur and platycnemial tibia, which would show that the Neolithic people led an active life, probably as hunters. Dr. Thurnam has noted that sometimes two or more of the cervical or dorsal vertebrae have a tendency to ankylosis, but I cannot say I have ever seen this.

On the continent of Europe remains of the Neolithic people are found chiefly in caves, and show much the same state of culture and physical features as just described, for instance the well-known Cro-Magnon race; but the sequence of their existence there is not so well defined as in Britain, where they held apparently undisputed possession of the country for a considerable period. Indeed, it is only lately that continental anthropologists have limited their priority to that of people presenting the character of the next race we will have to deal with.

From the evidence at hand, it seems probable that the Neolithic people occupied the whole of the west of Europe at one time; and I agree with several observers in considering that they are to be identified with the old Iberian race, of which the Basque may be considered a remnant. There is certainly a strong similarity between Basque skulls and those of the Neolithic people of Britain.

Unlike Palaeolithic man the Neolithic people have never become extinct in Britain, and their descendants exist to the present time. It is true that subsequent invaders drove them, in many instances, to particular parts of the country, as early history and the excavations of General Pitt-Rivers and others show; but skeletons from ancient tombs indicate that they also mixed with their conquerors.

The next people to appear upon the scene, previous to the dawn of history, are those who were in possession of the greater part of Britain at the time of the Roman invasion. They came into Britain from France and Belgium at a considerably earlier period, and subjugated or displaced the Neolithic race. These are the so-called Celts. Their advent is marked by the introduction of the use of metals into Britain, and they are associated with the Bronze age. From the custom they had

of interring their dead, whom they chiefly cremated, in barrows of a circular shape, they are often known as the Round Barrow people. They show a marked advance in civilisation beyond that of Neolithic times, as they were agriculturists, and lived by tilling the soil; they manufactured weapons and ornaments of bronze, and richly decorated pottery; their flint implements also were of better make, as evidenced by their beautiful barbed arrow-heads. To this period belong many of the curious lake dwellings found all over Great Britain and Ireland, Picts houses of Scotland, and bee-hive houses of Ireland.

Their osteological remains show that the skull was large with strongly-developed superciliary ridges and glabella, the brow well formed and broad, the upper occipital region not projecting, the tuberosity being the most prominent. In general form the brain-case is broader and rounder than in the Neolithic race, the cephalic index centring round 81; they were, therefore, a distinctly brachycephalic people. The upper border of the orbit is thick, the malar bones are prominent and large. The jawbones are large, *maxillaries*, and likewise the teeth, which are often much ground down; the profile of the upper jaw is somewhat prominent, which gives a prognathous look to the skull; the chin is well formed. The face as a whole is of an angular lozenge form. The ridges for muscular attachments, both on the cranium and face, are well developed, and the expression is very rugged and savage-like. From the skull Thurnam estimated the average age of the persons interred in the round barrows was fifty-five years, while that of the long barrows was ten years less.

The stature of the Round Barrow race averages 1.747 metres (5 feet 9 inches), which is more than the mean stature of the population of the British Isles at the present day. The limb bones are large, with strongly-developed ridges and depressions for muscular attachments.

This race is everywhere to be found over Great Britain and Ireland, and although conquered by the Romans and subsequent invaders, forms a very important element of the population of the country down to the present day.

[I have to thank Prof. Boyd Dawkins for his kind permission to use woodcuts from his work on "Early Man in Britain," for the purpose of illustrating this publication of my lecture, and to General Pitt-Rivers for permitting the reproduction of a block from his plate in "Excavations near Rushmore," vol. ii. The lecture, as delivered at the Royal Institution, was illustrated by numerous lantern slides, which were not suitable for reproduction.]

#### UNIVERSITY AND EDUCATIONAL INTELLIGENCE.

OXFORD.—The Statute relating to Research Degrees has been promulgated, and has given rise to some dissatisfaction among many of those who have hitherto warmly supported the scheme. The supervision of those who wish to qualify for a Research Degree is to be placed, according to the proposed Statute, in the hands of a Delegacy composed of the Vice-Chancellor and Proctors and twelve other members, to be nominated by the Vice-Chancellor and Proctors, the Hebdomadal Council, and the Members of Congregation. This amounts to the creation of a new Delegacy similar in constitution and in powers to the existing Delegacy of non-collegiate students, and it is felt that it is a most unsuitable mode of supervising the work of men none of whom may be less than twenty-one years of age. It was thought that the supervision of the researchers should be vested in the Professorial body, and it is much to be hoped that the proposed Statute will be thrown out in Congregation, for it is nearly certain that no persons qualified for research would submit themselves to the supervision of such a heterogeneous body as the proposed Delegacy, and the scheme, of which so much is expected, would become a dead letter.

In a meeting of the Junior Scientific Club, held on Friday, November 16, Mr. P. Eford, of St. John's, exhibited a specimen of shale oil, and papers were read by Mr. F. Druce, of Magdalen College, on anticyclones and other types of atmospheric pressure, and by Mr. W. W. Fisher, of Corpus Christi College, on the Oxford water supply.

Mr. P. L. Selater, F.R.S., has been elected an honorary Fellow of Corpus Christi College.

CAMBRIDGE.—Dr. Forsyth, F.R.S., has been appointed Chairman of the Examiners for Part II. of the Mathematical Tripos.

Mr. E. H. Hankin, Fellow of St. John's College, and Professor of Bacteriology at Agra, has been appointed to represent the University at the Indian Medical Congress to be held at Calcutta in December.

The following is the Syndicate appointed to consider a report on the question of special encouragement, by new degrees or otherwise, for post-graduate study and research in the University: The Vice-Chancellor, Dr. Mansland, Dr. D. Macalister, Dr. Jebb, Dr. Forsyth, F.R.S., Prof. Marshall, Prof. Gwatkin, Prof. Foster, F.R.S., Prof. Thomson, F.R.S., Mr. A. W. W. Dale, of Trinity Hall, and Mr. W. Bateson, F.R.S., of St. John's College.

A Grace authorising the Cavendish Laboratory Syndicate to obtain specifications and tenders for the proposed extension of the Laboratory, was offered to the Senate on November 22.

### SCIENTIFIC SERIALS

*American Journal of Science*, November.—On variations and mutations, by W. B. Scott. The author discusses the problem of animal morphology in its various aspects, and the different lines along which a solution has been sought for. These are that of comparative anatomy, embryology, and palæontology, to which, since Bateson's work on the study of variation, a fourth has been joined. The author criticises in detail Bateson's method and its results, and comes to the conclusion that we can no longer assume as a fundamental and self-evident truth that individual variations are the material from which new species are constructed.—Resonance analysis of alternating currents, by M. J. Pupin. This analysis is performed by means of a "resonator circuit" consisting of an inertia coil, a rheostat and a condenser in shunt with an electrostatic voltmeter. The capacity of the condenser is gradually increased from zero upwards. Whenever a capacity has been reached, which with the self-induction of the resonator circuit produces resonance with one of the harmonics in the main circuit, then the resonant rise of potential produces a large deflection in the voltmeter. In this manner all the harmonics which are present in the current of the main circuit can be detected in a few minutes.—On some new methods of obtaining platinumchlorides, and on the probable existence of a platinum subchloride, by M. Carey Lea. One of the new methods employs potassium acid sulphite, with a solution of which potassium platonic chloride is moderately heated. The reduction takes about ten to twelve hours, and is known to be complete when the solution has a pure red colour free from yellow. The second method is that with alkaline hypophosphites. If in obtaining potassium platinumchloride with the aid of a hypophosphite in excess, the heat is continued after complete conversion to the red salt, the solution in a few minutes changes from red to dark brown. The substance which gives the solution this dark brown colour is very deliquescent, and cannot be crystallised. It cannot be completely separated from the other substances in solution. The author is led by its reactions to suspect that it is a subchloride of platinum, analogous to that of silver.

*Journal of Anatomy and Physiology*, October.—Dr. Gustav Mann, in a paper entitled "Histological Changes induced in Sympathetic, Motor and Sensory Nerve Cells by Functional Activity (preliminary note)," gives an account of experiments made by him to test the observations of Hodge and F. Vas. Dr. Mann's observations relate to the cervical sympathetic ganglia (which also formed the subject of F. Vas's investigations), the motor area of the cerebrum, and to the retina and optic centres of the brain. His results in part agree with those of Hodge, in part with those of Vas, but they also in other particulars go beyond both. He considers that he has placed beyond doubt, that: (1) During rest, several chromatic materials are stored up in the nerve cell, and that these materials are used up by it during the performance of its function. (2) Activity is accompanied by an increase in size of the cells, the nuclei, and the nucleoli of sympathetic, ordinary motor and sensory ganglionic cells. (3) Fatigue of the nerve cell is accompanied by shrivelling of the nucleus, and probably also of the cell, and by the formation of a diffuse chromatic material in the nucleus.

### SOCIETIES AND ACADEMIES

LONDON.

Royal Society, November 15.—"On the Ascent of Sap," by Henry H. Dixon, Assistant to the Professor of Botany, Trinity College, Dublin, and Dr. J. Joly, F.R.S.

Strasburger's experiments have eliminated the direct action of living protoplasm from the problem of the ascent of sap, and have left only the tracheal tissue, as an organised structure, and the transpiration-activity of the leaf wherein to seek an explanation of the phenomenon. The authors investigate the capability of the leaf to transpire against excessive atmospheric pressures. In these experiments the leaf was found able to bring forward its water meniscuses against the highest pressures attained and freely transpire. Whether the draught upon the sap established at the leaf during transpiration be regarded as purely capillary or not, these experiments lead the authors to believe that it alone is quite inadequate to effect the elevation by direct tension of the sap in tall trees. Explanations of the lifting of the sap from other causes prove inadequate.

A reconsideration of the principal experiments of previous observers and some new experiments of the authors lead to the view that the ascent is principally in the lumen and not in the wall.

The explanation of how the tensile stress is transmitted in the ascending sap without rupture of the column of liquid is found in the stable condition of this liquid. The state of stability arises from two circumstances: the internal stability of a liquid when mechanically stretched, whether containing dissolved gases or not, and the additional stability conferred by the minutely subdivided structure of the conducting tissue, which renders the stressed liquid stable even in the presence of free gas.

By direct experiments upon water containing large quantities of dissolved air, the state of internal stability is investigated. And, further, by sealing up in the vessels, in which the water to be put under tension is contained, chips of the wood of *Taxus baccata*, the authors find that their presence in no case gives rise to rupture of the stressed liquid, but that this occurs preferably anywhere else, and usually on the glass walls. The establishment of tensile stress is effected in the usual way, by cooling the completely filled vessel. A measurement possessing considerable accuracy afforded 7½ atmospheres as being attained in some of the experiments.

The second condition of stability arises directly from the property of the pit-membranes to oppose the passage of free gas, while they are freely permeable to the motion of a liquid. Hence a chance development of free gas is confined in effect to the minute dimensions of the compartment in which it is evolved, and this one lumen alone is rendered for the time being non-conducting. On the other hand, in the water-filled portion of the tracheal tissue, the closing membranes, occupying the median and least obstructive position, the motion of the stress sap is freely allowed. The structure of the conducting tissue is, in fact, a configuration conferring stability on a stressed liquid in the presence (from various causes) of free gas. As neither free gas nor unwetted dust particles can ascend with the sap, the authors contend that the state of tensile stress necessary to their hypothesis is inevitably induced.

The energy relations of the leaf with its surroundings, on the assumption that evaporation at capillary water-surfaces is mainly responsible for the elevation of sap, may be illustrated by the well-known power of the water-filled porous pot to draw up mercury in a tube to which it is sealed. The authors describe an engine in which the energy entering in the form of heat at the capillary surfaces may be in part utilised to do mechanical work: a battery of twelve small porous pots, freely exposed to the air, keeping up the continuous rotation of a fly-wheel. Replacing the porous pots by a transpiring branch, this too maintains the wheel in rotation. This is, in fact, a vegetable engine. In short, the transpiration effects going on at the leaf are, in so far as they are the result of spontaneous evaporation and uninfluenced by other physiological phenomena, of the "sorting demon" class, in which the evaporating surface plays the part of a sink of thermal energy.

If the tensile stress in the sap is transmitted to the root, the authors suggest that this will establish in the capillaries of the root surface meniscuses competent to condense water rapidly from the surrounding soil. They show by experiment the power possessed even by a root injured by lifting from the soil, of condensing water vapour from a damp atmosphere. Such a state

of things may be illustrated by a system (which the authors realised) consisting of two porous pots connected by a tube and all filled with water: one, the "leaf," exposed to the air gives out vapour, the other, the "root," buried in damp earth supplies the demand of the "leaf," and an upward current in the connecting tube is established.

"Further Observations on the Organisation of the Fossil Plants of the Coal-Measures. Part II. The Roots of *Calamites*." By Dr. W. C. Williamson, F.R.S., and Dr. D. H. Scott, F.R.S.

The conclusions at which the authors arrive are the following:—

(1) The fossils hitherto described under the name of *A. Williamsonii* Williams are the adventitious roots of *Calamites*.

(2) Their structure is in all respects that characteristic of roots, as is proved by the centripetal primary wood, the alternating strands of primary wood and phloem, the endogenous mode of branching, and the absence of nodes.

(3) The smallest specimens, with little or no medulla, represent the finest branches of the same roots, of which the large medullate forms are the relatively main axes.

**Linnean Society, November 1.**—Mr. C. B. Clarke, F.R.S., President, in the chair.—Mr. Alexander Whyte was admitted.—Messrs. H. and J. Graves exhibited an undescribed *Chara* from Wexmouth, and made remarks upon its peculiar mode of growth.—Mr. J. O. Tepper exhibited photographs of a new and remarkable fungus from South Australia, *Laccosporium basidioides*, which explained the formation of the peculiar stone-like nodules occasionally found when clearing scrub-land. They were found to be due to the agglutinating nature of the mycelium of this fungus, the grains being permanently cemented by lime and ferruginous oxides.—The Rev. G. Henstow made some remarks on a peculiar mode of propagation of *Oxalis* *stricta*, observed in Malta, and exhibited some views taken during his journey here.—Mr. Miller Christy exhibited a long piece of leaden pipe which had been gnawed through its entire length by rats, in a manner which showed that the object was not, as generally supposed, to get access to water.—Mr. H. M. Benard exhibited some photographs of corals taken with the "Kodak" camera.—A series of that remarkable beetle *Golanthus* *luteiventris*, from West Africa, was shown by Dr. Heath, and Mr. E. M. Holmes exhibited some plants from Japan.—On behalf of Mr. A. W. Waters, a paper was then read on Mediterranean and New Zealand Retipira and on a fenestrate Retipira, and on behalf of Dr. J. Müller, a paper on certain nemata in the Kew Herbarium.

**Zoological Society, November 6.**—Sir W. H. Flower, K.C.B., F.R.S., President, in the chair.—The President read a letter addressed to him by the late Emin Pasha, containing a series of zoological observations made during the last part of his journey towards the Congo. This letter and journal had been sent on from the Arabs in the Upper Congo by the officers of the Congo Free State, and forwarded to the President.—A communication from Mr. F. E. Blauw, contained some remarks on the culture of the bill in a living specimen of *Cyrus* *aurantius*.—A communication was read from Mr. K. Trimen, containing a reply to some remarks of Dr. A. G. Butler on his paper on the Maudslayi butterflies collected by Mr. Selous.—A communication was read from Dr. R. W. Shufeldt, containing a correction to his paper on the anatomy of the *Steganofoles*, recently published in the Society's *Proceedings*.—Mr. O. Salvin, F.R.S., exhibited a pair of the newly described butterfly *Colletes* *parviflora*, from the Eumare Mountains, German New Guinea.—Mr. C. Taylor Sherbon exhibited a copy of an unpublished manuscript of the recently issued reprint of George Ord's "American Zoology."—Mr. G. A. Boulenger, F.R.S., exhibited a *Coccyz*, *Lawsoni*, obtained by Mr. R. T. Lewis, which had been captured in water (Italy), fully active, on the now upon the highest portion of the Draonsberg Range, Natal. It belonged to a group believed until 1888 to be characteristic of the *A. melanotos*, and differed from its nearest ally, *Q. lawsoni*, in the smaller and convex granules covering the back, and in the pointed hind toe.—The bird, Mr. Boulenger proposed for it the name *Trochiloides*.—Mr. Martin Jacoby made descriptions of some new species of the genus *Ptilinopus*, and allied genera of the *Colaptes*.—Mr. W. G. Innes read a paper on the hyoid apparatus of *Coelocentrus*. The author in this paper compares on between

the ventral elements of the hyoid arch of *Ceratodus* and the basi- and hypo-hyal cartilages of the Elasmobranchii. The relations of the hyomandibular cartilage were dealt with in detail, and attention was called to the wide range of variation which this vestigial cartilage exhibits. Arguments were also adduced to show that there is no connection between the reduction of the hyomandibular in the Dipnoi and its adaptation as a secondary suspensorium in the hystylic fishes.—Mr. G. A. Boulenger, F.R.S., read a third report on additions to the Batrachian Collection in the Natural History Museum, containing a list of the species, new or previously unrepresented, of which specimens had been added to the collection since 1890, and descriptions of some new species.—A communication was read from Mr. R. J. Lechmere Guppy, containing an account of some Foraminifera from the microzoic deposits of Trinidad.—A communication was read from Sir Walter L. Buller, containing remarks on a petrel lately described as new by Captain Hutton, under the name of *Diastrelata leucophrys*.

**Geological Society, November 7.**—Dr. Henry Woodward, F.R.S., President, in the chair.—Sir John Lubbock exhibited some interesting specimens from the valley of Lauterbrunnen at Murren. The rock forms part of the calcareous strata which stretch to the south-west to Leuk, and to the north-east to the celebrated gorges of the Aar. It has also a great thickness, and is coloured in the geological map of Switzerland as Malm, though some Swiss geologists have recently attributed it to the Trias. Notwithstanding the careful researches of the Swiss geologists no fossils, however, had yet been found in it. During one of the recent excursions of the International Geological Congress, Sir John Lubbock found a layer which is rich in fossils—amongst others *Nannulites Ramonii*, *Orbitoides dispersus*, and *Orbitoides papyraceus*. The rock therefore is not Malm, but Eocene. The species have been verified by Prof. Rupert Jones. Sir John Lubbock showed the spot to Prof. Etheridge, who also exhibited some fossils from the same layer. The find will necessitate a substantial correction of the geological map, and is perhaps the more interesting because the specimens were found in a quarry by the roadside in the village of Murren, and actually between the two principal hotels.—Notes on some recent sections in the Malvern Hills, by Prof. A. H. Green, F.R.S. The sections described occur on the east side of the Herefordshire Beacon, and for convenience are named the Warren House Rocks. They are bedded, and have a general north and south strike. The great bulk of the rocks are hard, close-grained, and splintery, and are largely altered, and in many cases thickly veined with calcite. Details of their structure were given; and the author stated that he is inclined to regard them as a group of bedded acid lavas and tuffs, crossed by three bands of dolerite. What little balance of evidence there is seems to be in favour of the intrusive character of the dolerites. No true limestones have been found, and the only very calcareous rock seen is regarded as a rock belonging to the volcanic group which has been largely calcified. A discussion followed, in which Mr. Watts, Dr. Hicks, Mr. Kutley, and Mr. Harker took part.—The Denbighshire series of South Denbighshire, by Philip Lake. The area to which this paper chiefly referred is the south-western quarter of the Hlangollen basin of Silurian rocks. The beds are there very little disturbed, and the sequence was readily made out. On comparison with other areas it was found that the succession is almost identical with that in the Long Mountain, in North Denbighshire, and in the Lake district. Prof. Hughes, Mr. Hopkinson, Dr. Hicks, Mr. Marr, and Mr. Watts made a few remarks upon the subject of the paper.—On some points in the geology of the Harlech area, by the Rev. J. F. Blake.

**Entomological Society, November 7.**—Colonel Charles Swinhoe, Vice-President, in the chair.—Colonel Swinhoe exhibited a female of *Papilio telearchus*, Hewitson, which he had received by the last mail from Cherra Punji. He said that this was the only known specimen of the female of this species, with the exception of one in Mr. L. de Nicéville's collection, which he had described in the *Journal* of the Bombay Natural History Society in 1893. He also exhibited a male of the same species for comparison.—Mr. C. G. Barrett exhibited abnormal forms of *Pararge megera*, *P. ageris*, *Melitæ aethalia*, *Chrysophanus phlox*, *Charaxes grammis*, *Lophopteryx camelina*, *Plusia gamma*, *Cinulia chamomilla*, *Bombyx repandata*, var. *conversaria*, and other species, all collected by Major J. N. Still on Dartmoor,

Devon. He also exhibited for Mr. Sydney Webb, of Dover, a long series of most remarkable varieties of *Arctia caia*, and *Arctia villica*.—Mr. Gervase F. Mathew, R.N., exhibited seven beautiful and striking varieties of *Arctia villica*, bred from larvæ obtained on the Essex coast, near Dovercourt, in March and April 1893 and 1894.—Herr Jacoby exhibited two specimens of *Blaps mucronatu*, with soft elytra, taken on a wall at Hampstead. The Rev. Canon Fowler and Mr. G. C. Champion made some remarks on the subject of the elytra of immature beetles.—Mr. H. Goss exhibited a specimen of *Periplaneta australasia*, received from Mr. C. E. Morris, of Preston, near Brighton. Mr. McLachlan said the species had been introduced into this country, but was now considered a British insect.—Mr. B. G. Rye exhibited specimens of the following rare or local species of Coleoptera, and gave the names of the localities in which they had been taken: *Cicindela germanica*, *Eumieris rufus*, *Triarthron markeli*, *Mezium affine*, *Homaloptia ruficollis*, *Anomala frischi*, var. *julii*, *Synaptus filiformis*, *Lixus paraplecticus*, *Bilaminus cerasorum*, *Asemum striatum*, and *Zeuzyphora flavicollis*.—Mr. McLachlan exhibited for Mr. G. C. Bignell two new species of Ichneumonidae, from Devonshire, viz. *Pimpla britmani*, Bign., a parasite on a spider, *Drausus lapidicollis*, Walck., and *Praon absinthii*, Bign., a parasite on *Siphonophora absinthii*, Linné.—Mr. C. O. Waterhouse stated that the Acridium received from Captain Montgomery, and exhibited by Mr. Goss at the last meeting, was *Acridium septemfasciatum*, and he exhibited the species with the wings extended.—Mr. Ridley exhibited a species of a scale insect (? *Lecanium*) found on a nutmeg tree in Malacca, and made some remarks on *Formica smaragdina*, which makes its nest on the trees, joining the leaves together by a thin thread of silk at the ends. The first step in making the nest is for several ants to bend the leaves together and hold on with their hind legs, and one of their number after some time runs up with a larva, and irritating it with its antennæ, makes it produce a thread with which the leaves are joined; when one larva is exhausted a second is fetched, and the process is repeated.—Mr. Waterhouse read a paper entitled "Some remarks on the Antennæ of Insects." A discussion followed, in which Messrs. Champion, Jacoby, McLachlan, and Gahan took part.

**Mathematical Society**, November 8.—Mr. A. B. Kempe, F.R.S., President, in the chair.—At this meeting, which was the first held since the incorporation of the Society, the by-laws, which had been drawn up by the council, were passed unanimously. The ballot was then taken, and the gentlemen whose names were published in NATURE (November 1, No. 1305, p. 19) were declared duly elected to form the new council and officers. The new President (Major MacMahon, F.R.S.) having taken the chair, Mr. Kempe read his address, the title of which was "Mathematics." Other communications made were—a generalised form of the hypergeometric series, and the differential equation which is satisfied by the series, F. H. Jackson; third (and concluding), memoir on certain infinite products, Prof. L. I. Rogers; on the kinematics of non-Euclidean space, Prof. W. Burnside, F.R.S.

**Royal Microscopical Society**, October 17.—The Rev. Edmund Carr in the chair.—Dr. W. H. Dallinger, F.R.S., described a new model microscope which had been made by Messrs. Watson.—Messrs. Ross exhibited examples of their "Eclipse" microscopes.—Mr. R. T. Lewis exhibited some parasites which had been found upon a penguin from Isipingo, Durban.—Dr. H. Stolterfoth's paper on the genus *Corethron* was read by Prof. Jeffrey Bell.—Mr. E. B. Green read a paper on some parasitic-growths on the root-hairs of plants. Mr. A. W. Bennett made some remarks on Mr. Green's paper.—Prof. Bell called attention to the loss the Society had suffered by the death of Dr. G. E. Blenkins, a former secretary.—Mr. F. Chapman gave a résumé of part of his paper on the Foraminifera of the Gault of Folkestone. The chairman and Prof. Bell made a few remarks on Mr. Chapman's contribution.—Owing to the absence of the author, Mr. Nelson's paper, on the measuring of the refractive indices of various media, was deferred to the next meeting on November 21.

## CAMBRIDGE.

**Philosophical Society**, October 29.—Prof. T. McKenny Hughes, President, in the chair.—The officers for the ensuing session were elected as follows:—President: Prof. J. J. Thomson. Vice-Presidents: Prof. Sir G. G. Stokes, Prof. Hughes,

Mr. F. Darwin. Treasurer: Mr. Glaisher. Secretaries: Mr. Iarmor, Mr. Newall, Mr. Bateson. New Members of Council: Dr. Glaisher, Prof. Lwing, Mr. F. H. Neville, Mr. E. H. Griffiths, Mr. W. B. Hardy, Mr. H. F. Baker. The retiring President, Prof. Hughes, before vacating the chair, addressed the Society. The President-elect, Prof. Thomson, on taking the chair, referred to the loss sustained by science in the death of Prof. von Helmholtz.—Note on geometrical mechanics, by Prof. Sir Robert S. Ball.—On a model of the twenty-seven lines on a cubic surface, by Mr. W. H. Blythe. Mr. Blythe exhibited a model of the twenty-seven straight lines on a cubic surface, together with the drawings from which it was constructed. He stated that the 135 points of intersection of these lines can, in a special case, be determined by a simple geometrical construction without reference to any equation. Seven points taken at pleasure on the edges of a tetrahedron are sufficient to give values to all necessary constants, and these points acting as poles in pairs, fix the position of eleven other points; these eighteen points being used to determine others, and so on. This method is also applicable to the general case, but determines fifteen lines only; when however the sixteenth line or one point on it is fixed by a process of adjustment the remaining points can be found in the same way.—Exhibition of some photographs showing the marks made by stars on photographic plates exposed near the focus of a visual telescope, by Mr. H. F. Newall.

## PARIS.

**Academy of Sciences**, November 12.—M. Loewy in the chair.—The President announced the death of M. Duchartre, and an account of this botanist's life and works was delivered by M. Bornet.—On the transit of Mercury, by M. J. Janssen. Owing to unfavorable weather, only a part of the transit was observed at Paris.—Researches on the condensation of electrolytic gases by porous bodies, particularly by metals of the platinum group; applications to the gas battery; electric accumulators under pressure, by MM. L. Cailletet and E. Collardeau. Platinum and palladium in the spongy condition, and ruthenium, iridium, and gold in the finely divided state form poles which condense electrolytic gases, and hence produce a gas battery, on subsequent connection of the poles, capable of giving up the stored energy during a short time. The storage capacity may be vastly increased by subjecting the poles to great pressure during charging. With spongy platinum and iridium a storage capacity may be attained greater than the practical capacity of lead accumulators per unit weight. Silver, tin, nickel, cobalt, and carbon do not form accumulators under these conditions with capacity increasing with the pressure.—New details concerning the Nymphæinae of the Lower Cretaceous system, by M. G. de Saporta.—A study of the causes of saline digestion, by M. A. Dastre. Saline digestion is not due to the action of soluble ferments, and is not caused by microbes.—On the disappearance of the southern polar spot of Mars, by M. G. Bigourdan.—The transit of Mercury, by M. E. L. Trouvelot. (See our Astronomical Column.)—On an error detected in the "theory of numbers" of Legendre, by M. Dujardin. On the representation of left-handed algebraical curves and on a formula by Halphen, by M. Léon Autonne.—On an empirical formula, by M. Pervouchine, by M. Ernest Cesàro.—Direct experimental determination of the specific heat of saturated vapour and of the heat of internal vaporisation, by M. E. Mathias. The general method given permits, by means of a double series of calorimetric experiments with an apparatus charged once for all, of the complete resolution of the problem of the calorimetric study of a substance, and shows that the specific heat of saturated vapour is susceptible of direct experimental determination.—Determination of the molecular weight of liquids, by M. Ph. A. Guye. The author gives methods of determining molecular weights of substances from a knowledge of their critical coefficients and molecular refractions and from their critical coefficients only. The relationships for a number of hydrocarbons are given, and the deduction is drawn that these hydrocarbons have the same molecular weights in the gaseous state, in the critical state, and in the liquid state.—On active amylacetic acid and some of its derivatives, by Mlle. Ida Welt. The rotatory powers of a number of these derivatives are given. Methyl amylacetate has a rotatory power  $[\alpha]_D = +6.71$ ; for the corresponding ethyl salt  $[\alpha]_D = +6.66$ . The products of asymmetry calculated for the same compounds bear the ratio 375:

321.—On the can... and on the constitution of camphor, by M. A. P... on the oxidation of alcohols by Fehling's solution, by M. Fernand Gaad. Methyl, ethyl, and propyl alcohols yield the corresponding aldehydes and salts of the corresponding acids when the alcohol is in excess; when the reagent is in excess and the heating is prolonged at a higher temperature, salts of the corresponding acids are obtained, but not aldehyde. Biological observations made on *Stilbonotus* ... Olivier, during the invasions of 1891, 1892, and 1893 in Algeria, by M. J. K... d'Herculeais. On the swarming of Termites, by M. J. Perret.—On the assimilation of nitrates by plants, by M. Demoussy.

BERLIN.

Physical Society, October 19.—Prof. du Bois Reymond, President, in the chair.—The President referred to the loss the Society had sustained by the death of von Helmholtz.—Prof. Bernstein demonstrated an experiment of Messrs. Elster and Geitel on the influence of polarisation on the outflow of negative electricity which may be brought about by light. The most suitable metals for the experiment are sodium or potassium or their alloys. A liquid alloy of potassium was charged with negative electricity so that the leaves of an electroscope connected with it were widely divergent. As soon as the rays of an incandescent lamp were allowed to fall on the surface of the alloy, the leaves being previously darkened, the leaves of the electroscope approached each other as due to an outflow of electricity. When the light was polarised by a Nicol prism it resulted in discharge only when the plane of its vibrations coincided with that of its incidence; in the plane at right-angles to the plane of vibration the light was reduced to a minimum.—Prof. Koenig reported the results of his researches on the significance of visual purple. Previously communicated to the Physiological Society on July 20. See NATURE, No. 1298, p. 472. A discussion followed, in which the President, Prof. von Bechold, Prof. Neesen, and Dr. Rubens took part. The last-named supported Prof. Koenig's view that the fovea centralis is colour-blind for blue, by pointing out that fine blue lines in the spectrum cannot be seen by absolutely direct vision, but only by indirect vision.

Physiological Society, October 20.—Prof. du Bois Reymond, President, in the chair.—The President dwelt on the recent deaths of their honorary President, von Helmholtz, and Prof. Pringheim, and drew attention to the more important medico-physiological researches of the latter.—Dr. Bendix spoke on the influence of sterilising milk on its digestibility. Milk is sterilised by prolonged boiling or the passage of steam through it, and changes take place. The sugar is turned into caramel, and the sweet taste changes correspondingly, and, further, on cooling the fat tends to form lumps, and thus destroy the emulsion. Three experiments had been made on children between the ages of one and two years, each experiment consisting of two series. In the first, the children received either fresh milk, or milk which had only been once boiled-up, together with some white bread; in the second, the same amounts of sterilised milk and bread. A comparison of the nitrogen and fat in the two milk samples showed that the sterilised milk was just as completely digested as the unsterilised.—Dr. Cowles spoke on his comparative researches carried out on mammals. In his earlier experiments he had found the frog's heart to be the most suitable for studying firmly as it does in a depression of the liver. Working with this, he had observed that as long as the heart is supplied with blood the apex remains at rest on the surface of the liver during systole, whereas when deprived of blood it raises at each systole. Among mammals he had not as yet found a heart so suitable for the experiment. In the dog, rabbit, and cat, the heart lies on the lung-tissue, is hence easily pushed to the side, and is thus readily displaced by any levers or other apparatus brought to bear upon it. In monkeys, also, there is a fall of the lungs lying between the diaphragm and the heart, but up to the present he had not been able to obtain any reliable cardiographic tracings by placing levers on the outside of the mammalian heart.

G. THINLEY.

Royal Society of Sciences.—The *Årsmöte* (Annual Meeting) 1894, was held on 11th and 12th inst. of great interest. The first paper was on the relation of the various series of H<sub>2</sub>O<sub>2</sub> to the series of the various cyclic ketones

(III). J. Hermes.—On the division of the circle into 65,537 equal parts. A. von Koenen.—On the geological survey of Southern Hanover.

June 23.—P. Drude: Studies on the electric resonator. July 7.—David Hilbert: Outlines of a theory of Galois' *Zähloper*. K. Sehering and C. Zeissig: New photographic method of registering the time and the position of the magnets in magnetometers and galvanometers. Ludwig Aschoff: Contribution to the subject of atypical epithelial proliferation and the origin of pathological glandular growths.

BOOKS, PAMPHLETS, and SERIALS RECEIVED.

Books.—Nuellenkende: Prof. H. I. Haas (Leipzig, Weber).—A Laboratory Manual of Organic Chemistry. Dr. W. K. Orndorff (Boston, Heath).—Practical Methods in Microscopy C. H. Clark (Boston, Heath).—Life at the Zoo: C. J. Cornish (Seeley).—Aembi Club Reprints, No. 9: The Elementary Nature of Chlorine. Humphry Davy (Edinburgh, W. F. Clay).—(Outline of Biology: P. C. Mitchell (Methuen).—Radiant Suns: A. Giberne (Seeley).—By Vernal Woods and Waters. F. Steg (Bliss).—Rhythmic Heredity. H. C. Hiler (Williams and Norgate).—Report of the Fifth Meeting of the Australasian Association, September 11-15 (Sydney).—Practical Inorganic Chemistry. E. J. C. 3rd edition (Rivington).—Australia, Vol. 2: Malaysia and the Pacific Archipelagoes: Dr. F. H. H. Guillemard (Stanford).—Candian: Rev. W. C. Ley (Stanford).—Primer of Psychology: Prof. J. T. Lund (Longmans).—Psychology for Teachers: C. Lloyd Morgan (Arnold).  
PAMPHLETS.—Notes on Tours along the Malabar Coast: E. Thurston (Madras).—L. Deleage of Pasteurism: Dr. M. B. Colah (Bombay).—Mittellungen des Vereins für Lärkunde 24 Halle a.S. 1894 (Halle a.S.).  
SERIALS.—Psychological Review, November (Macmillan).—American Meteorological Journal, November (Ginn).—Journal of the Franklin Institute, November (Philadelphia).—Journal of the Anthropological Institute, November (K. Paul).—Royal Natural History, Part 13 (Warne).—Proceedings and Transactions of the Queensland Branch of the Royal Geographical Society of Australasia, 1893-94 (Brisbane).—Astronomy and Astrophysics, November (Wesley).—American Naturalist, November (Wesley).—Le Monde des Plantes: P. Constant, fasc. 1 (Paris, Baillière).—English Illustrated Magazine, Christmas 17, Strand.

CONTENTS. PAGE

Psychology of Mental Arithmeticians and Blind-fold Chess-players. By Francis Galton, F.R.S. . . . .	73
The Collected Works of Olbers. By J. L. E. D. . . . .	74
Quaternions . . . . .	79
Our Book Shelf:—	
Stephen: "Sir Victor Brooke, Sportsman and Naturalist" . . . . .	76
Briggs and Bryan: "A Text-book of Dynamics. A Text-book of Statics" . . . . .	76
Pickworth: "The Slide-Rule."—W. J. L. . . . .	77
Pizzetti: "I Fondamenti Matematici per la Critica dei Risultati Sperimentali." G. . . . .	77
"Teppich erzeugung im Orient" . . . . .	77
Orndorff: "A Laboratory Manual" . . . . .	77
Letters to the Editor:—	
Finger-Prints.—Sir W. J. Herschel, Bart. . . . .	77
Boltzmann's Minimum Function. (With Diagram.) S. H. Burbury, F.R.S. . . . .	78
The Kinetic Theory of Gases.—Edwd. P. Culverwell . . . . .	78
Homogeneity of Structure the Source of Crystal Symmetry. H. A. Miers . . . . .	79
Gravitation. Prof. A. M. Worthington, F.R.S. . . . .	79
The Foucault Pendulum Experiment. G. A. R. . . . .	79
An Observation on Moths.—Dr. L. C. Jones . . . . .	79
Photographs of a Tumbling Cat. (Illustrated.) . . . .	80
Biology in the United States—A Prospect. By G. B. H. . . . .	81
Notes . . . . .	82
Our Astronomical Column:—	
Observations of the Transit of Mercury . . . . .	85
Ephemeris of Encke's Comet . . . . .	85
Recent Observations of Jupiter . . . . .	85
The New Cypress of Nyasaland. (Illustrated.) . . . .	85
Schiaparelli on Mars . . . . .	87
Early British Races. II. (Illustrated.) By Dr. J. G. Garson . . . . .	90
University and Educational Intelligence . . . . .	92
Scientific Serials . . . . .	93
Societies and Academies . . . . .	93
Books, Pamphlets, and Serials Received . . . . .	96

THURSDAY, NOVEMBER 29, 1894.

## LOCOMOTIVE CONSTRUCTION.

*The Construction of the Modern Locomotive.* By George Hughes. Pp. 260. (London: E. and F. N. Spon, 1894.)

OF all the many branches of engineering, that of locomotive engineering has been generally overlooked by the writers of text-books, and until quite recently the only works on this important subject were the classical works of Z. Colburn and D. K. Clerk, "Locomotive Engineering and the Mechanism of Railways," and "Railway Machinery." These works are more than twenty years old, and do not now represent modern practice, although the rules and formulæ given are largely made use of to this day, besides which the experimental data obtained by D. K. Clerk on the old Edinburgh and Glasgow Railway, some time before the year 1855, may still be regarded as of great value.

Locomotive engineers in this country owe more to the late Mr. William Stroudley than they care to admit. To Mr. Stroudley is due the thoughtful and careful designing of every part of the locomotive, from the valve motion to the damper on the ash-pan, and, thanks to his example, locomotive design has become as near a science as it is possible to be, always bearing in mind that abstract calculations are nearly useless for this purpose. A very important point in the design of a locomotive is that of facility of repairs in the running-shed. It is possible to point to more than one type of British engine where the draughtsman appears to have had entirely his own way in the design, and consequently an ordinary repair, such as changing a spring, entails the partial stripping of the engine in order to lift it high enough to effect this: whereas it should be possible to do it with a couple of jacks, just to ease the weight off the spring, take the pins out, and then replace the spring. Another similar case may be quoted. Some heavy main line passenger tank engines have recently been constructed; and should a copper stay leak badly on the side of the fire-box, the side tanks cannot be removed to get at the leak without cutting out rivets and removing the angle-iron supporting the side platform; whereas had the draughtsman been an engineer, he would have foreseen such an emergency, and provided for it. These examples are sufficient to show that when designing an engine, the position of every pin and bolt should be carefully considered, so that their removal, if necessary, will be an easy matter in the running-shed.

The volume before us, unfortunately, does not deal with design, but treats only with the manufacture of a locomotive in the works of the Lancashire and Yorkshire Railway Company at Horwich. As these works are comparatively new, it is only fair to expect to find the practice thoroughly up to date, and as the author is an assistant in the chief mechanical engineers' department, the information given may be considered to be authentic. The title chosen for the book is a little misleading, because only one type of engine is discussed; moreover, this engine is fitted with the Joy valve gear, a type of motion certainly not generally adopted by locomotive engineers.

The work is divided into six sections, and these are again subdivided when necessary. Each section describes the actual progress of the work done in that section. Taken as a whole, this book is unique; it is the only one we know of that appeals to the locomotive engineer in the language and phraseology of the works, and without the cant usually found in text-books of to-day dealing with mechanical subjects. The book being of a thoroughly practical nature, it may be as well to follow its contents in order.

Section i. deals with the boiler, the materials used in its construction, and the methods of manufacture. Steel is the material used for the shell in most cases. The author observes that if a plate is buckled, this buckling is got out of the plate by planishing, or by a multiple roller straightening machine. The former method cannot be recommended for boiler-plates, but for tank side, cab, or splasher-plates it is the common practice. The question of locomotive boiler drilling is thoroughly well gone into, but the methods described are not those of most recent practice, which may be concisely stated to be—the edges of all plates must be machined, rivet and other holes to be bored after rolling the plates to shape, and drilling all holes out of the solid. Many complicated multiple drilling machines have been constructed to meet these requirements, but it is questionable whether such complicated tools are necessary, especially when the self-pitching attachment is used, because the holes in each seam must be set out in order to find the position of the holes for the "holding together" bolts, which are usually placed 12 to 14 inches pitch, and which are usually drilled through a template in bunches before the plates are rolled. Further on the author describes a plate-bending machine capable of rolling a plate to the very edge. As such a machine is certainly very badly wanted it may be here questioned whether the one described is really capable of doing this. The old method of setting the last 4 or 5 inches with a "former" has long been condemned, but with vertical rolls the ends of the plates may be rolled to the true radius by means of a curved packing piece which holds the plate up to the movable roll, resting against the smaller live rolls behind.

We are told that the inside and outside butt strips are sheared to size, and not machined on edge; unless they are afterwards annealed, this practice cannot be commended. One cannot help being astonished at the free use of cast-steel in the boilers. This is very much up to date; but what gain there can be in using a cast-steel tee-bar in place of a rolled one for the longitudinal and sling stay attachments, cannot be seen. The crown of the fire-box is stayed with cast-steel girder-stays or roof-bars, and ferrules are used to preserve the proper distances. Surely these ferrules might be replaced by bosses cast on the stay-bar, into which the bolts would be screwed, thus strengthening the bar, and being less complicated. The foundation rings are also of cast-steel; these castings evidently require much setting and "paening." Surely they are machined inside and out, as required by good practice?

The paragraphs dealing with flanging plates and the tools used, leave nothing to be desired; they are concise and to the point. Reasons might have been given for the adoption of the "Webb" fire-hole; it seems to

entail very severe treatment of the plates for no obvious purpose. There are many ways of placing the copper stays in position, and the author evidently cuts off the ends after screwing them home. Here he is behind the times: "modern practice" requires them to be cut to length in the lathe, afterwards being screwed home by a sort of stud-driver. This does away with any chance of injuring the threads by cutting them in position by eccentric portable shears, or the more barbaric hammer and chisel.

The quadruple tapping machine illustrated no doubt does its work very well, but it must be moved from boiler to boiler, and this entails much labour and loss of time; a far simpler tool is generally used, namely, a light radial jib carrying a movable carriage, over which the ropes run to the tool-holders, all the compensating gear being on the wall. Taken as a whole, Section i. is extremely well written, and covers a large field of detail; it concludes with the testing of the completed boiler. The hydraulic test of 200 pounds per square inch is much below the usual test-pressure in water, viz. one and a half times the working pressure, for new boilers.

Section ii., occupying eighty-seven pages, is divided into three parts. The first part deals with the iron foundry, the second on the use of steel castings, and the third describes the brass foundry. It is evident, after careful perusal, that much attention has been given to this particular branch of the works, especially the careful manner in which the mixings of the different metals is carried out, and the valuable illustrative tests showing the necessity for annealing steel castings. As an example of foundry practice, we find a full description of the moulding of a pair of twin cylinders, probably the most difficult and important piece of work occurring in a railway foundry; a few other examples are also given. In part two of this section the author wisely suggests that engineers should formulate a standard specification for the grade of material for steel castings for locomotive work, and recognise a standard size for both tensile and bending test bars. With this we cordially agree; specified tests vary far too much, and in some cases tend to make the specifying engineer a laughing-stock for contractors.

Section iii., dealing with forgings, is divided into two parts. The manufacture of tyres, axles, coupling rods, and smaller details, is well described, the usual tests being given. The method of work is illustrative of modern practice, particularly the stamping of detail work under the drop hammer. Engine tyres for India usually are required to have a minimum tenacity of from 42 to 44 tons, and with a sectional area of test piece of  $\frac{1}{2}$  square inch. The extension, measured over a length of 3 inches, must not be less than 20 per cent. The second part of this section deals with the manufacture of springs, among other things. Page 164 illustrates the means taken to weld a lever on to a shaft; figures C and E may make a "job," but it is preferable to fit the lever end half through the shaft before welding; that is, for a brake or a reversing shaft; for a damper shaft, a dab weld may be good enough.

In Section iv. we find a description of general upper-mill's work; and in passing we may observe that the hemi-spherical top for steam dome casings are in

some works made from mild steel plates in dies under the hydraulic press, as well as the upper parts of safety-valve casings and corner mouldings for fire-boxes. This reduces the cost of these items considerably.

The machine department of a locomotive works is always interesting. The machinery is in many cases of a special nature; and in railway works, where duplication is said to exist, the machines may be still more of a special type, because only one class of locomotive is made. The Horwich Works appear to be largely fitted with milling machinery, to judge by the amount of care the author takes in his descriptions. Whether milling in its competition with planing, slotting and shaping machines, will ultimately prove the cheaper process, remains to be seen. On page 204 we find the statement that all frame-plates are put on the levelling table and straightened (levelled?) by the aid of two hydraulic jacks; further on we read that the frame template has been given up, owing to its liability to become distorted, and that a man can draw in a frame in two hours; again, it is stated that a batch of eight frames is slotted, firstly by roughing out, and secondly by a finishing cut. Surely this cannot be called modern practice? To thoroughly and truly level a frame-plate it is necessary to heat it to a cherry-red heat, and level it on a plain surface; for this reason it is usual to punch the frame-plate roughly to shape before being levelled. This punching to shape allows the frame-slottting machine to commence at once roughing out the bunch of plates. Moreover, the plate is more or less annealed by the furnacing.

The frame template generally used is made in three pieces dovetailed together, and the angle-iron bracing is conspicuous by its absence: very little trouble is caused by such a template. Surely the author has made some mistake in stating that a man can "mark out one frame, which is a two hours' job." To mark out a frame from a drawing, without a template for slotting and drilling, will take one man two days or more. Moreover, the frame-plates are not said to be planed on one side. If this is the case, much time is lost in erection and fitting the horn-blocks, assuming of course this fitting is properly done. Such a frame-plate can be planed in from three to four hours.

Case-hardened wrought-iron axle-boxes are said to be things of the past! The Midland Railway Company use nothing else, and many new engines for other railways are being fitted with them; in fact, such boxes working in chilled cast-iron or cast-steel guides are hard to beat.

The last section of this interesting book deals with the final erection of the engine, and we are glad to see that Horwich does not go in for throwing an engine together in ten hours or more, to be afterwards re-erected when the "wonder" has ceased to be talked about.

It appears that the practice of fitting the horn-blocks to the frames when in a vertical position is followed. This cannot be commended; it is far easier for the men to do it before they reach the erecting-shop, when laying on trestles; the holes can then be opened out, and the bolts or cold rivets driven in comfortably. Pianoforte wire has long been abandoned for squaring over cylinder centre-lines by contractors, for the reason that it can be bent between the fingers, and



thrown one way or another by the men. The three-inch tube for setting the slide-bars cannot be trusted for accurate work, owing mainly to the end drooping by its own weight, and slackness in the glands and temporary front cylinder cover. Squaring over the frames is now done by a long square, one arm being placed through the driving horns, and held against them. The distance is then measured from the leading and trailing horns to the other arm of the square when held in the four positions. If the frames are square, these measurements should agree, if the horns are similar throughout. A woven silk cord is best for lining up the frames and cylinders.

The volume concludes with a lengthy description of the Joy valve gear, a gear not generally used in locomotive work. It is a pity the author does not treat the so-called Stephenson link motion in a similar exhaustive manner. In conclusion, we must congratulate the author on having written the first readable and accurate book on the construction of the locomotive engine. He has treated his subject in a masterly way; he describes, as a rule, the most recent practice in a thoroughly professional manner. The work is well and copiously illustrated, and will be of great use to those who take an interest, either professionally or in an amateur way, in the construction of the locomotive.

N. J. LOCKYER.

#### INDO-MALAYAN SPIDERS.

*Malaysian Spiders.* By Thos. and M. E. Workman. Parts 1, 2, and 3. (Belfast: Published by the Authors, 1894.)

THE material upon which this work is based was obtained by the authors during a recent visit to the East Indies; and since the entire collection has been submitted for examination and description to Dr. Thorell, who has made a special study of the Arachnida of this quarter of the globe, it may be taken for granted that the species have been as satisfactorily identified as is possible. Most of them, whether old or new, have been already described in detail by this specialist. But his systematic zoological work, although in its way of unrivalled excellence, is open to two objections. We have, in fact, heard it alleged, firstly, that the span of human life is too short, and the number of existing spiders too great, to admit of deserving attention being paid to his exhaustive descriptions; and, secondly, that a deal of vexatious trouble and valuable time might be saved by the addition of a few figures to the overwhelming amount of text. It is evident that Mr. and Mrs. Workman have realised the full force of these two objections; for this book of theirs may be briefly described as a supplement designed to make good the defects in Dr. Thorell's report upon their collection.

The work is being issued at intervals in shilling parts, of which three, comprising in all twenty-nine plates, have up to the present time appeared. Every species is illustrated by a hand-coloured figure, together with outline sketches of structural details; and accompanying each set of figures is an explanatory page of text, giving the name and synonymy, the affinities and distribution of the species, and some measurements of the type-specimen. Moreover, in some instances interesting items of news respecting habits, &c., are added; and in the case of the orb-weavers, a figure of the web charac-

teristic of the species is engraved on a separate plate. It is this part of the work, we feel sure, that will prove of the greatest interest to the student of spider-life. Even the pure systematist may learn from it valuable facts bearing upon his aspect of the subject. For the figures and descriptions of the webs afford indisputable evidence that remotely allied genera may construct snares of substantially the same kind, as may be seen by a comparison of the nests of *Callinethis*, *Gea*, *Argyropeira*, *Epeira*, and *Gastracantha*, represented in parts 1 and 3; and that within the limits of the same genus, species may be found that spin webs differing widely in important points of structure, as a glance at the figures of the webs of *Epeira calyptrata*, *unicolor*, and *beccarii*, in parts 1 and 3, will show. Clearly the importance of these facts must be steadily kept in view by those who base their classification of spiders on the structure of the webs.

The discovery of the snare of *Uloborus quadri-tuberculatus* has given rise to a curious problem. This web is always spun on the pine-apple, and is of a peculiar basket-shape, the peculiarity consisting in the remarkable adjustment that is exhibited between the structure of the web and that of the plant. But the pine-apple is a native of South America, and has only of late years been introduced into Singapore; so that if the spider is truly a native of the latter place, it has evidently rapidly modified its spinning instincts in response to the slight change in its environment brought about by the introduction of the pine-apple. Before such a conclusion, however, can be looked upon as an established fact, evidence must be produced that the spider and the plant were not concomitantly brought from the Neotropical to the Oriental region.

Another very interesting fact is noticed in connection with *Argyropeira striata*. We are told that this spider, which is normally of a bright golden tint, "has the power of darkening down its brilliant colouring when frightened." (part 3, p. 19.) The importance of this observation is greatly enhanced by the independent discovery made by Mr. H. H. J. Bell, and published in NATURE (vol. xlvii. p. 558), to the effect that a West African species of *Argiope* possesses the same faculty of rapidly varying its colour under the stimulus of changing surroundings.

From what has now been said, it may be judged that the value of this book, as an addition to the literature of spiders, is both great and unquestionable. But it is impossible to shut one's eyes to the fact that its general excellence is slightly marred by a few blemishes, which, at the risk of appearing ungrateful, we think it our duty to point out; not, be it understood, with the object of fault-finding, but in the hope that none of them may be copied by other authors, and that some, at least, may not reappear in succeeding parts of the work.

In the first place, respecting the method of publication, it is a pity that both preface and introduction have been altogether omitted, and that species belonging to such widely different families as *Oxyopidae*, *Atidae*, *Thomisidae*, and *Epeiridae*, should be indiscriminately mixed, as they have been in part 1. With regard to the preface, we hope that the authors will see the application of the maxim, "Better late than never"; and although the adage, "What is done cannot be undone,"

holds good in the case of the parts already issued, we should like, nevertheless, to see a little more method displayed in the grouping of the species contained in the forthcoming parts.

In the second place, since more than one species is now for the first time made public property, it may prove as serious an oversight as it is an irreparable one, that the exact date of the issue of the several parts has not been permanently recorded on the title-pages. Moreover, these new species, instead of being rendered conspicuous as such by the familiar symbol *n. sp.*, are ascribed to Dr. Thorell, with the simple addition of the words "Thorell MS." No doubt the considerations of courtesy expressed by this ascription are worthy of all praise; but it will be as well to bear in mind that the species are for the first time described and figured in a work, not by Dr. Thorell, but by Mr. and Mrs. Workman. It is, consequently, within the bounds of probability that some of us may feel inclined to question the right of the latter two authors thus to constitute the former the founder of these species; seeing that his sole claim to the title rests upon an unpublished suggestion respecting their names, coupled with a privately expressed opinion that they were new forms.

We should also like to suggest that a little more precision in the printing of the figures would greatly add to the value of the plates, without much increasing the cost of their publication. If this and the other alterations we have ventured to propose are adopted for the remaining parts, it is certain that the work, when complete, will rank as one of the most important contributions to the natural history of spiders that has appeared in the last quarter of this century.

R. I. POCKOCK.

#### THE PLATEAU REGION OF SOUTHERN FRANCE.

*The Deserts of Southern France: an Introduction to the Limestone and Chalk Plateaux of Ancient Aquitaine.*  
By S. Baring-Gould, M.A. With illustrations. In two volumes. London: Methuen and Co., 1894.)

THE region described by Mr. Baring-Gould, lies, roughly speaking, to the south and south-west of Auvergne, forming a kind of border-land to that country and the Cevennes. Most of it goes by the name of Les Causses. This is a limestone region, furrowed deep by gorges, and pierced by caves. On the eastern side it rises, in three steps, from the neighbourhood of the Gulf of Lyons to the central *massif* of ancient granite and gneiss and of comparatively modern volcanic-rock; on the western side it falls, in like manner, to the sandy lowlands on either bank of the Garonne.

The scenery of these gorges is always striking and often grand: the finest cañons being those traversed by the Lot and the Tarn. Mr. Baring-Gould's first mention of the former river may serve as an example of the characteristic scenery.

"Near its cradle it passes under the frowning Causses of Sauveterre, then it cleaves the limestone of the Bouergne, and afterwards winds and writhes like a serpent through the Causses of Quercy. Everywhere, at every stage, it affords surprises; the scenery is sublime and quaint. On both sides the cliffs are encrusted with

castles and domestic habitations, built half into the crags. Churches and towns stand on the tops of the cliffs, and look down on the boats that glance by. In its sinuities it washes overhanging scars, without leaving soil at their feet on which to plant a foot, whereas an alluvial meadow, rich and rank, is on the farther bank; then, suddenly, the capricious river turns to the opposite side and treats it as the first. Consequently a road was only to be carried up the Lot valley by means of tunnels and bridges."

Among the natural wonders of this region, its caves and swallow-holes are not the least. These Mr. Baring-Gould seldom ventured to examine in person, but he quotes extensively from M. E. A. Martel, one of their most adventurous explorers, and gives some excellent illustrations. The latter remind us of similar features in the Carinthian Alps to the north of Trieste, and in the Carboniferous Limestone districts of our own country, with which Prof. Boyd Dawkins has made us familiar in his book on "Cave Hunting." In exploring these underground regions a human interest is not always wanting; for the investigator may come across the skeleton of a suicide or the remains of prehistoric man, while the stalactites are sometimes remarkably fine.

It is unfortunate that Mr. Baring-Gould did not get some friend, more expert in geology, to look over the proofs of his book. His references to that subject are often wanting in clearness and precision, and thus are sometimes rather perplexing. This is perceptible even on the title-page, where he speaks of the "limestone and chalk plateaux." But "chalk" is a "limestone," so we conclude that the author uses the term in a limited sense, whether it be the descriptive or the geological. But if the former, then, so far as we are aware, the soft white limestone which we call chalk does not occur in the Cretaceous system of Southern France; and if the latter, some distinctive epithet, such as "Jurassic," should have been inserted before "limestone." Such a statement as this also is puzzling: "The lowest stage (of the Causses) . . . is of chalk with a layer of lias above it in places." This is incomprehensible, unless Mr. Baring-Gould uses chalk merely as a synonym for light-coloured limestone (which he often does, unless we misunderstand him), or some strange faulting has occurred which seems highly improbable. The following passage, also, will hardly satisfy either a zoologist or a geologist:

"The Dolomitic limestone is held to be coral rock built up under water by the industrious insect that is at present forming reefs and islands in the Pacific. At the time when these tremendous masses were composed, the lias lay at the bottom of a warm shallow sea, and on its banks the coral worm worked. Gradually the bottom of the sea sank, and as it sank, so did the insects build upwards towards the light and warmth. After a lapse of ages the whole was upheaved. . . . As the construction is vertical, the structure is vertical, and as the coral insects twisted and turned about sponges, masses of seaweed, and avoided cold currents, the whole mass of rock abounds in hollows in which water accumulates, and in passages through which rivers run."

These, however, are trifling blemishes, which can be readily put right in a second edition. The book is delightful reading, and is full of interesting information, at which we have only time to glance. Mr. Baring-Gould, among other things, gives a good account of the curious fire-hills of Cransac, produced by spontaneous com-

bustion, in the coal basin of Decazeville and Aubin. His description also of the irreparable mischief wrought by the reckless destruction of forests, is well worth reading, for it must be remembered that the weird desolation of the limestone plateaux is a thing of comparatively recent date, and an indirect consequence of the French Revolution. Of the rock shelters of the "reindeer age" in the valley of the Dordogne and of other rivers, he has much to say, and of the dwellers in "holes of the rock" down to the present day: for these caves have been enlarged, or faced with masonry, or actually excavated, at various dates, and in some cases are still inhabited. Of the dolmens and other megalithic remains which are common on the plateaux region, Mr. Baring-Gould writes as one who has made a study of the subject. Perhaps some of his ethnological speculations may not meet with universal acceptance, but they are, at any rate, worth considering. The book contains many curious bits of folk-lore, as we might expect, and narrates sundry remarkable historical episodes in the mediæval struggle between France and England, and in the sanguinary conflicts of Huguenots and Romanists. A chapter is also devoted to the romantic, though often discreditable, story of Joachim Murat, who was born at a dirty little "bastide" of the same name on the Causse de Gramat, near the source of a tributary of the Lot. The book, in short, while it indicates the author's cultivated tastes and wide range of reading, directs the attention of travellers to a region of singular and varied interest, which hitherto has received but little notice even from the French themselves. It is only inadequately described in Reclus' great work, "Géographie Universelle." It has not, however, escaped the indefatigable emissaries of Baedekker, who gives, in the volume on Southern France, a succinct account of the district, evidently founded on personal knowledge. Armed with the little red book, and Mr. Baring-Gould's more bulky volumes, a rich reward undoubtedly awaits the visitor. The guide-book will direct his steps aright; Mr. Baring-Gould's pleasantly written and admirably illustrated volumes will give him abundant information about the chief points of interest, whether physical, archæological, or historical, and will be an unerring resource during those hours of enforced leisure, which, on a journey, are apt to become tedious.

T. G. BONNEY.

#### OUR BOOK SHELF.

*An Elementary Treatise on Theoretical Mechanics.* Part I. Kinematics. Part II. Statics. By Alexander Ziwet, Assistant Professor of Mathematics in the University of Michigan. (London and New York: Macmillan and Co., 1893.)

AMERICAN mathematicians have always followed the system of the French and continental school, so that the progress of the American student in analytical development has not been arrested and stunted by the excessive reverence of the Newtonian methods prevalent in this country.

According to the continental system a student is introduced at the earliest possible stage to the Cartesian methods of geometry and to Leibnitz's extensions in the domain of the Differential and Integral Calculus; and then, even with a comparatively small equipment of analytical knowledge, hardly extending beyond an

acquaintance with the notation, he is prepared to study and appreciate a work like the present; while the English student is kept back by clumsy antiquated methods, on the pretext of developing his geometrical and general reasoning powers.

This work is intended as an introduction to the science of theoretical mechanics, adapted to the particular wants of engineering students who, with the characteristic practical energy of their race and age, will not desire to be kept marking time over the rudiments.

The general treatment of the subject is elegant and complete, and valuable collections of illustrative examples are introduced at the different stages. One of these, however (ex. 6, § 276), caught the eye, as requiring amendment; as also the Fig. 29 of the catenary.

An old friend, the problem of the beam in a bowl—in other words, of a spoon in a teacup—given as ex. 20, § 151, deserves separate discussion, and a complete solution in the text.

The present opportunity is favourable for expressing to Prof. Ziwet the thanks of mathematicians in this country for his valuable Report of Prof. Klein's Lectures on Mathematics, called the "Evanston Colloquium," held before members of the Congress of Mathematics in connection with the World's Fair at Chicago, at Northwestern University, Evanston, Ill. G.

*By Order of the Sun to Chile to see his Total Eclipse.*

April 16, 1893. By J. J. Aubertin. Pp. 152. (London: Kegan Paul, Trench, Trubner, and Co., 1894.)

TWO years ago Mr. J. J. Aubertin, having seen a copy of NATURE for October 13, 1892, containing a letter on the then coming solar eclipse, went home and dreamed a dream. In his vision the Sun visited him and ordered him to gird up his loins, and go to the desert of Atacama and watch the eclipse. This brief explanation is necessary in order to account for the rather clumsy title of the book before us. Mr. Aubertin, regardless of the belief that dreams should be reversed, and that he was seventy-five years of age, travelled to Chile, and, meeting Prof. Schaeberle there, became one of the eclipse party. He was, however, more an interested layman than a scientific observer, and therefore his book is of very little value to astronomers. In fact, the book is chiefly taken up with tittle-tattle of interest to very few beyond the parties concerned. A picture of the corona, as seen by the author, is very pretty, and compares favourably with the impressions recorded by observers of the phenomena before photography monopolised the field as a coronal artist. But at the present time, the results of visual observations of the corona are regarded with suspicion, and rightly, for they never afford any very definite information as to the true form and structure of the sun's surroundings. However, Mr. Aubertin faithfully records what he saw, so his observation must be accepted. The book contains Prof. Schaeberle's photograph as a frontispiece.

*Reise nach Südtindien.* Von Emil Schmidt. Mit 39 Abbildungen im Text. (Leipzig: Wilhelm Engelmann, 1894.)

HERR SCHMIDT'S book is a plain, straightforward narrative of a tour through Southern India, in the course of which he visited Madras, Travancore, made an excursion to Cape Comorin, proceeded by Trivandrum to Cochin, and thence by Coimbatore to the Anamalay Hills, going afterwards to the Nilgiris, and finishing at Calicut. The object of the journey was mainly to study the native peoples, and numerous ethnological photographs give a certain value to the book. There is, however, nothing new in the way of an important contribution to science in the work, which is most interesting as showing the impressions produced on an intelligent and observant German by a visit to Southern India. The style is lively, but perfectly serious, and cannot fail to be of much value in Germany, where it appears few books have been pub-

lished dealing with the lighter aspects of Indian life. It is pleasant to note that Herr Schmidt found the English officials and planters everywhere very hospitable and cordial, ready to assist him in his inquiries as to the people, and able to give him much valuable information on the subjects which he was studying.

*By the Woods and Waters.* By Edward Step. Pp. 254. London: Bliss, Sands, and Foster, 1894.)

A RECREATION book, made up of papers originally contributed to *Good Words*, *Leisure Hour*, *Sunday Magazine*, *Silver Link*, and other periodicals. The author is well known as a close observer of nature, and he has the amount of poetry in his composition essential in a writer on popular natural history. The book is nicely printed and illustrated.

### LETTERS TO THE EDITOR.

[The Editor does not hold himself responsible for opinions expressed by his correspondents. Neither can he undertake to return, or to correspond with the writers of, rejected manuscripts intended for this or any other part of NATURE. No notice is taken of anonymous communications.]

#### Acquired Characters.

IN reference to the question as to how far the signification of the term "acquired characters" may usefully be extended beyond the precise limit given in Lamarck's two laws (quoted in my letter of November 15), or what phenomena may be brought into close relationship with those indicated by Lamarck, the following considerations, will, I think, be found useful.

Let us consider a relatively stable local "race" of some species of organism. The race is found to present a certain range of variation, but has an average character; and cases approximating to the average are so far more numerous than departures from it, that for our immediate purpose we may leave the aberrant individuals out of account. The average specific character is a matter which may be determined by measurement and weighing. It can be stated in numerical form as to length of such and such parts, breadth and depth of other parts, weight, amount of pigment or other chemical product here or there. We know by experiment that these quantities can be altered in immature individuals *within limits*, by changing the physical conditions in which the individual is placed. These physical conditions are (roughly speaking) such measurable quantities as those relating to temperature, light, mechanical strains, moisture, and varying amounts of chemical compounds or elements operating on the organism through its absorbing surfaces (respiratory organs, digestive organs, integument).

From such experiments we are led to conclude that without destroying the life of an individual many characters can be increased in quantity, but that there is a limit beyond which they cannot be so increased; and that many characters can be reduced in quantity in the same way in an individual without destroying its life, but that here also there is a limit. Hence it seems that we are justified in distinguishing the "potential" from the "actual" characters of an organism.

This *potentiality* of the individual is something inborn or congenital. On the other hand, the *actual* quantitative condition of the average character of a naturally occurring assemblage of individuals is necessarily to some extent the result of the operation of the measurable physical agencies which constitute the normal environment of the species or race. (The range of difference, it may here be noted, between the potential and the actual characters of a species as thus indicated, is found to differ very greatly in different species and in regard to different parts of the organism.) Thus then every individual exhibits certain quantitative characters, the amount of which are *determined* by the operation on the individual of given and related quantities of external agencies. To a character thus quantitatively determined, some writers have extended the term "acquired character," inasmuch as it is not the congenital potential character in its purity (if such a thing were possible) which we thus contemplate, but the congenital character as moulded, increased, or restrained by surrounding conditions. But whilst I am very decidedly of opinion that a consideration of this moulding, expanding, or restraining influence of the normal environment is likely to throw

important light upon the implications of Lamarck's doctrine, I agree most emphatically with Mr. Francis Galton in thinking that the use of the term "acquired characters" must be limited, as indicated by Lamarck's own statement, to characters, "which are regularly found in those individuals only which have been subjected to certain special and abnormal conditions" (to quote Mr. Galton's words). The word "acquired" was used by Lamarck, and should continue to be used as pointing to an acquisition, under *new* conditions, of *new* character or characters, distinct from the normal characters which form, as it were, the starting-point, however determined or brought into existence.

It is, however, true that the difference between the actual characters of an individual organism as compared with its potential characters—a difference the origin of which may be expressed by calling the former "responsive characters"—is of the same order whether the actual characters are determined in their amount by the normal environment of the race, or by abnormal quantitative changes of that environment.

And it seems to me, that in considering this we are led to the conclusion that the second law of Lamarck is a contradiction of the first. Normal conditions of environment have for many thousands of generations moulded the individuals of a given species of organism, and determined as each individual developed and grew "responsive" quantities in its parts (characters); yet, as Lamarck tells us, and as we know, there is in every individual born a potentiality which has *not* been extinguished. Change the normal conditions of the species in the case of a young individual taken to-day from the site where for thousands of generations its ancestors have responded in a perfectly defined way to the normal and defined conditions of environment; reduce the daily or the seasonal amount of solar radiation to which the individual is exposed; or remove the aqueous vapour from the atmosphere; or alter the chemical composition of the pabulum accessible; or force the individual to previously unaccustomed muscular effort or to new pressures and strains; and (as Lamarck bids us observe), in spite of all the long-continued response to the earlier normal specific conditions, the innate congenital potentiality shows itself. The individual under the new quantities of enviroing agencies, shows *new* responsive quantities in those parts of its structure concerned, new or "acquired" characters.

So far so good. What Lamarck next asks us to accept, as his "second law," seems not only to lack the support of experimental proof, but to be inconsistent with what has just preceded it. The new character, which is *ex hypothesi*, as was the old character (length, breadth, weight of a part) which it has replaced—a response to environment, a particular moulding or manipulation by incident forces of the potential congenital quality of the race—is, according to Lamarck, all of a sudden raised to extraordinary powers. The new or freshly-acquired character is declared by Lamarck and his adherents to be capable of transmission by generation; that is to say, it alters the potential character of the species. It is no longer a merely responsive or reactive character, determined quantitatively by quantitative conditions of the environment, but becomes fixed and incorporated in the potential of the race, so as to persist when other quantitative external conditions are substituted for those which originally determined it. In opposition to Lamarck, one must urge, in the first place, that this thing has never been shown experimentally to occur; and in the second place, there is no ground for holding its occurrence to be probable, but, on the contrary, strong reason for holding it to be improbable. Since the old character (length, breadth, weight) had not become fixed and congenital after many thousands of successive generations of individuals had developed it in response to environment, but gave place to a new character when new conditions operated on an individual (Lamarck's first law), why should we suppose that the new character is likely to become fixed after a much shorter time of responsive existence, or to escape the operation of the first law? (Clearly there is no reason (so far as Lamarck's statement goes) for any such supposition, and the two so-called laws of Lamarck are at variance with one another. To push the matter further—in those cases in which experiment has been made, it has been found that a character acquired by an individual removed from the operation of a related condition normal to the race of which that individual is an example, is replaced by the old character when the old condition is restored in the environment of the offspring of that individual. No doubt I shall be challenged to

produce evidence confirming this last statement. I admit that carefully studied and conclusive instances are not very numerous, but I refer to such cases as the non-transmission (a) of plus or minus variation in pigment produced in individuals by greater or less exposure to sun-light; (b) the effects of dry or moist climate on individual plants; (c) the effects of change of diet on individual animals; (d) the effects of increased use of muscles in men and animals.

It seems that we are driven to the conclusion that the causes which have been active in producing changes the accumulation of which amounts to specific, generic and larger differences, must be causes which are able to act upon the potential congenital quality of the individual, and that there is no reason for associating the somewhat superficial and late responses or reactions of the parts of a growing individual to normal or abnormal forces of its environment with that more subtle and profound disturbance, which is permanent and affects the potential character of the germ, and more or less of all the germs derived from it.

At any rate this is the absolutely unanimous testimony of all those observers, in all countries and in all ages, who have been practically concerned (often with vast pecuniary interests at stake) in the production of relatively permanent new races of animals and plants. Breeders of horses, cattle, sheep and dogs, pigeon and poultry-fanciers, crop growers, nurserymen, tulipomaniacs, and the like, have never in any single instance put the Lamarckian principle into practice. On the contrary, they laugh it to scorn. Not one of them ever produced a new race by moulding the parents. But, on the other hand, they do subject the selected parents to novel and disturbing conditions, to which the changed characters of the offspring (not of the parents) have no "responsive" relation; they cross-breed here and cross-breed there, until the "specific potential" is broken-down, and strange unlooked for varieties are born and grow up irrespective of normal or abnormal environment. From these congenital variations they select desired forms, and perpetuate them with perfect assurance and security.

For the present I see no evidence of a production of new races on the face of the earth, excepting by the method adopted by these men, viz. by the selection of congenital variations; such congenital variations being produced as the result of (but without any direct adaptational relation to) a disturbance of the material of the reproductive particles of both sexes; that disturbance being increased, if not determined, by changed environment of the parental organisms or the coupling of remote strains.

E. RAY LANKESTER.

Oxford, November 17.

### The Present State of Physiological Research.

THE extracts given in NATURE of November 15, from an article by Prof. Max Verworn, of Jena, on "Modern Physiology," will serve to draw the attention of biologists to the reawakening of interest which is now evinced by many physiologists in regard to the fundamental phenomena exhibited by living things. As the opinion of physiologists is expressly invited in reference to the questions raised in this article, I venture to express my own as being in the main the same as that of Prof. Verworn.

It seems to me an obvious truism to say that the methods which can ensure a real advance in general biological knowledge must be those in which comparative physiology takes the lead. In my recent presidential address to the Liverpool Biological Society I urged the establishment of laboratories for the systematic study of the comparative physiology of the simpler organisms, the end in view not being the elucidation of the functions of organs with an *arrière pensée* as to their relation to man, but the examination of the activities for their own sake, since this inquiry forms the only means of approaching the mystery which enshrouds the essence of living existence.

The determination of the reactions of simple organisms to physical changes (stimuli), and the grouping of such resultant effects carried out systematically, form a line of physiological inquiry of transcendent importance, both because of its large scope and fundamental character, and because it opens the way towards the partial elucidation of the physiologist's real problem. This problem is the one involved in the question, to what extent all living phenomena are to be regarded as reaction phenomena? Are we, on the other hand, compelled to postulate the existence in every living thing of a *deus ex machina*

which can, if it will, act independently of every physical stimulus, a so-called "vital force"?

Prof. Verworn is right in forcing upon the attention of physiologists the paramount necessity for work of this kind. I venture, however, to point out that he has not done justice to the judgment of his contemporary physiologists if, as I imagine, he has been led to infer from the character of the mass of current physiological work, that they do not realise the importance of such comparative physiology. But to realise the importance of an inquiry and to be able to carry that inquiry into effect, are unfortunately by no means identical positions.

There are undoubted obstacles to the latter, however ardently we may desire its fulfilment.

In the first place physiology is, in this country, more or less shackled by its position. It owes everything to medicine. Its laboratories are adjuncts to medical schools, its professors must take their share in the teaching in such schools, and this teaching is essentially connected with human physiology.

The debt, which as physiologists we owe to medicine, is one which we gratefully acknowledge, but even with the thanks on our lips we may be supremely conscious of the chains which still hang on and impede the debtor. It is this close relationship which, in my opinion, has served to accentuate the separation between physiology and the science of which it properly forms part, biology; a separation which is now almost a judicial one, and if unchecked may become an actual divorce. It is rare to find a physiologist who has been highly trained in zoological investigation, and rarer still to find a zoologist who has attempted to perfect himself in the methods used in physiological laboratories. Yet the appropriate blend is essential for the advent of those comparative physiologists who alone can do full justice to the systematic inquiry now advocated.

Another difficulty in this country is undoubtedly due to the scanty pecuniary help afforded to scientific work which is neither technical nor directly concerned with what is regarded as the public good. Physiology, to-day, is maintained in Great Britain solely because it forms an essential part of a specialised technical education, that of the medical student; it is not maintained in order to inquire into the mystery of living things as such.

In order to adequately develop such an inquiry as this, it would be necessary to have a new department furnished with the equipment of both a zoological and a physiological laboratory, and with skilled workers who have leisure to prosecute their investigations. Since this means money, its full establishment may have to be postponed until that pious benefactor appears whose dawn even a Bodleian librarian has now anxiously to await.

Finally, I do not think the outlook is so discouraging as Prof. Verworn seems to believe, nor that "we are making no progress in physiology."

He admits that during the last twenty years we have attained to a precision in our experimental methods such as excites the astonishment of the uninitiated; and surely the mastery of method is the first step, and that an invaluable one, towards its future more fruitful employment. I do not imagine that even the systematic physiological investigation which he advocates, will involve the employment of new methods to the exclusion of old ones; it is the material which will be novel, not the entire experimental technique. Isolated instances of the application to simple excitable organisms, of such physiological methods as have been employed in elaborate detail for the investigation of muscle, nerve, &c., are well known to us all, and to no one better than Prof. Verworn; the real desideratum is surely that the instances should be no longer isolated, but form part of a broad systematic inquiry.

FRANCIS GOTCH.

University College, Liverpool,

November 17.

### Wilde's Theory of the Secular Variation of Terrestrial Magnetism.

MR. WILDE'S reply in NATURE of October 11 to my letter of criticism in the same of August 9, with respect to his communication to the Royal Society, contained in the *Proceedings* for March 1894, has just come to my attention.

As the letter consists entirely in an attempt to show the inaccuracy and unreliability of my statements with respect to the inclination-observations made at St. Helena,

shoves me to confine my own remarks to this matter. In order that my explanations may be understood, the table previously given is here reproduced.

No.	Date.	Observer.	Observed inclination.	Wilde's inclination.	Observation - Theory.
1	1700	Hansteen Chart	2 S.	3.9 N.	+ 5.9
2	1754.3	La Caille	9.00	0.5 S.	- 8.5
3	1771.4	Ekeberg	13.00	3.5	- 9.5
4	1775.4	Cook	11.42	4.0	- 7.4
5	1780	Hansteen Chart	10.5	5.1	- 5.4
6	1825.0	Duperrey	14.93	14.7	- 0.2
7	1840.1	Ross	18.27	18.5	+ 0.2
8	1842.3	Belcher	17.00	19.0	+ 2.0
9	1846.8	Smyth	19.39	20.5	+ 1.1
10	1890.1	U.S.C. & G.S.	20.05	33.8	+ 13.8
11	1890.1	"	31.18 S.	33.8	+ 2.6

This table is in every respect the same as originally given with the exception of the value for 1700, the erroneous value of 11.5 S. having been given instead of 2 S. Owing to my sojourn in Europe being but a temporary one, I have not with me all my data, and so cannot ascertain definitely how this error crept into my table. My original scaling was probably 1.5 S., which by a copying blunder may have been converted into 11.5. This, however, I cannot control now. It would have been a most natural inference on Mr. Wilde's part if he had ascribed this to the "printer's devil," all the more so as no use whatever was made in the text of my communication with this value. On account of so apparent an error he casts a slur upon my trustworthiness in general in regard to terrestrial magnetic matters. Such a poor method of argument reveals the weakness of his position.

Furthermore, with reference to this table, Mr. Wilde says: "I regret to observe that L. A. Bauer, in his intolerance of the magnetarium results, has inserted in his table guesses of his own for observations, which are very wide of the truth." I can find no excuse whatever for this statement. Mr. Wilde has acknowledged that he possesses a copy of Hansteen's "Magnetismus der Erde." Let him turn to Tafel II.: "Neigung der Magnetnadel," p. 36, and he will find the following observations given for St. Helena:—

Observer.	Date	Inclination.
De la Caille . . .	April 10, 1754	9.0 S.
Ekeberg . . . . .	May 19, 1771	13.0 S.
Cook . . . . .	May 17, 1775	11.25 S.

Position assigned by Hansteen: latitude 15° 55' S., longitude 11° 52' E. of Ferro, or 354° 12' E. of Greenwich. By inspecting the table given above it will be seen that these form observations Nos. 2, 3, and 4. No. 5, as stated, is taken from Hansteen's Chart for 1780. Mr. Wilde does not appear to question this value, nor the remaining ones, which can be easily found in Sabine's "Contributions to Terrestrial Magnetism." He will, furthermore, find that Hansteen had so much faith in the early observations, which Mr. Wilde insinuates are untrustworthy, that in 1857 he made use of all the observations known up to that time, viz. Nos. 2, 3, 4, 6, 7, 8, and 9, for the establishment of a periodic formula representing the secular variation of the inclination during this epoch. These investigations of Hansteen's can be found in "Den magnetiske Inclinationer Forandringen den nordlige og sydlige Halvkugle af Christopher Hansteen," Copenhagen, 1857, p. 4. Hansteen, by a least square adjustment of the observations named, derived the following interpolation formula:—

$$i = 13.55 - 455 + 5.44495 t - 1800 + 0.001913 (t - 1800)^2.$$

$i$  denotes the inclination at the time  $t$ , south inclination being reckoned as minus. This formula at the utmost should not be used more than ten years prior to 1754, nor ten years after than 1846. The following table shows how the values compared with this formula agree with observation.

Date.	Observed inclination.	Computed inclination.	O. - C.
1754.28	- 9.00	- 0.85	+ 0.85
1771.38	- 13.00	- 11.38	- 1.62
1775.38	- 11.42	- 11.77	+ 0.35
1824.96	- 14.03	- 10.26	+ 1.33
1840.10	- 18.27	- 17.66	- 0.61
1842.35	- 17.00	- 17.87	+ 0.87
1846.70	- 19.39	- 18.28	- 1.11

From this comparison it will be seen that the formula represents the observations fairly well. Let us compute then with it what the inclination would be in 1747. We obtain - 9° 2'. Now Mr. Wilde's magnetarium has given us for this date the value 0. Hence there is an outstanding difference of about 9°, which he has made no attempt to explain otherwise than by insinuating that I have put "guesses" in my table, or that the observations are untrustworthy. The burden of the proof that the observations are not trustworthy, rests with Mr. Wilde. Anyone, who has made any endeavour to familiarise himself with the literature of the subject of terrestrial magnetism, will know that it is an old story for theorists to characterise observations as doubtful if they do not happen to agree with their theory. I am willing to admit that the early inclinations in such a locally disturbed region as St. Helena, perhaps, cannot be depended upon nearer than to 2 or 3°; but, if Mr. Wilde will pardon my scepticism, I do not believe that it is possible for him to reproduce any inclination with his magnetarium that can be relied upon even to this extent. Hence, it is fair for me to compare the magnetarium results with that of observations (so long as the latter have not been overthrown) without consideration of the probable error of either result.

Mr. Wilde appears to have thought his position proven when he found that I made an error with respect to my first value. But even with the value as given by him, the outstanding difference is 5°-6°, with which he appears perfectly satisfied. If he will permit me a probable error as large as he permits himself in the establishment of his theory with his magnetarium, I can supply him with a dozen periods that will satisfy observations as well as his magnetarium. I would like to refer him to a recent attempt by Dr. Felgentraeger, who endeavours to prove the universality of the secular period by establishing periodic formulae upon the basis of most carefully collected material. He deduces a period of 477 years—instead of Mr. Wilde's 960—upon the basis of the declination observations made at London 1580-1882, and Paris 1541-1890. Adopting this period he found that he could represent exceedingly well the observations made at London, Paris, Rome, Clausthal, Chambersburg (U.S.A.), Rio de Janeiro, Cape of Good Hope, and Cape Comorin. Here we have a more extensive comparison than Mr. Wilde has given us, and we find a better agreement with observations with a period one-half of his! In this brief communication I cannot set forth my own position with respect to the secular-variation period. I hope to present Mr. Wilde with a copy of my investigations some time in December.

With respect to my opinion of the magnetarium in particular, I may say that my criticisms made thus far have applied solely to the theory as evolved from the magnetarium results, and do not touch the magnetarium as a valuable instrument of research. Indeed, I think much good can be accomplished with it. Mr. Wilde has made a most laudable attempt to reproduce mechanically the complex phenomena of terrestrial magnetism, and if the achievements with his ingenious mechanism had not received the publicity they did, or had been properly interpreted, my criticisms would never have been made. That he has not succeeded in giving us a better representation is no fault of his, but owing to the complexity of the phenomena.

The fact that Mr. Wilde has succeeded, by an arbitrary distribution of magnetic matter in his magnetarium, in representing the distribution of terrestrial magnetism for the year 1880 apparently so well, is no proof of his secular variation theory or his period, which plays no part in determining the distribution. Nor is the fact that with his distribution of magnetic matter he gets a good representation a proof that that is the actual distribu-

Dr. W. Felgentraeger. Die Linde auf der weissen See. Sechste. Sonntags. Ausgabe der Erdmagnetischen Elemente. Teil 1. D. Kilmann. Inaug. Diss. Universität zu Göttingen, Göttingen, 1892. Buchh. von J. Neumann, Neudamm.

bution prevailing in the earth. It can be demonstrated as a mathematical fact that in the absence of terrestrial magnetic observations within and without the earth's surface, an infinite number of different distributions is possible that will satisfy the effects observed on the surface alone.

In conclusion, it is my duty to make one more explanation. Mr. Wilde understood from my first letter that I am still in the employ of the U.S. Coast and Geodetic Survey. In view of the fact stated by him, that he sent, at considerable trouble and expense to himself, a duplicate of his magnetarium to the "Survey," and, hence, it might appear that it was somewhat discourteous in a member of the "Survey" to thus criticise him publicly, I may say that I severed my connection with the Survey two years ago, and that my criticisms have been made without any knowledge whatsoever of what has been accomplished with it by the "Survey."

Friedenau bei Berlin, October 31. L. A. BAUER.

**Boltzmann's Minimum Theorem.**

MR. CULVERWELL'S letter of October 25 ought to have received a much earlier answer. That it did not do so was owing to purely accidental circumstances which I very much regret.

In that letter Mr. Culverwell criticises my treatment of Boltzmann's familiar proposition concerning the properties of the II function on the following grounds:—

(1) The choice of the generalised coordinates. In investigating the circumstances of a collision or an encounter between two systems of molecules of  $m$  and  $n$  degrees of freedom respectively, he sees a difficulty in my choice of the coordinates as  $Q_1, Q_2, \dots, Q_m, q_1, q_2, \dots, q_n$ , where ( $q_n = a$ ) determines a collision, or encounter. But supposing the requisite number of degrees of freedom to be secured, the choice of the independent variables is surely quite optional. I had myself assumed this as self-evident, perhaps too hastily, but at any rate Mr. G. H. Bryan has placed this proposition beyond doubt, in the exhaustive report submitted by him to the British Association last August. Take for example sets of plane circular disks moving amongst each other in their own plane; here each pair of disks constitutes a material system, whose position is completely determined (assuming the orientation of each separate disk to be indifferent) by the following four variables, viz. the two coordinates of the centre of one disk of the pair, the distance  $\rho$  between their centres, and the inclination of that distance to a line fixed in the plane; this third variable  $\rho$  is the  $q_n$  of my proposition.

(2) Mr. Culverwell objects that the general Boltzmann proposition ( $\frac{dII}{dt}$ , always negative unless  $Ff = F'f'$ ), or II a minimum for one, and one distribution only, cannot be true, because if a system were started from any initial configuration (P, Q), and after the time  $t$  arrived at the configuration ( $f, q$ ) and the definite integral II were evaluated in these two configurations, the proposition asserts that the second II must be less than the first II, or  $II_t < II_0$ , whence it would follow by the same proposition that if at the end of the time  $t$  each velocity component were reversed, the  $II_{2t}$  must be less than  $II_0$ , and this, doubtless, I do assert. But Mr. Culverwell maintains that such an assertion is obviously untrue because at the end of the second interval  $t$  the system has returned to its original condition, and therefore  $II_{2t}$  must be the same as  $II_0$ , and to this proposition I demur.

Doubtless when a material system in a field of any conservative forces is started from any initial position and velocities, arrives after a time  $t$  at another position and with other velocities, and here has each velocity reversed, it is true that at the end of the next interval  $t$  it will be in its initial position, with each velocity component reversed; but it remains to be proved, and cannot be asserted *a priori*, that the  $II_{2t}$  is equal to  $II_0$ , and the only proposition available for the investigation is this very proposition of Boltzmann's, which proves that  $II_{2t}$  will be less than  $II_0$ , and therefore less than  $II_0$ .

Finally, Mr. Culverwell inquires, somewhat despondently, if anyone will point out the use of the II function, and what is proved by it.

I have already said in my second edition, that the proposition is not of my invention, and therefore that I have no claim to answer this question with any authority, but to my own mind the proposition appears certainly to clear away one

obvious difficulty. Without the aid of this proposition we are enabled to assert that if  $F(f, q)$  were a function of the co-ordinates and momenta of a molecule such that in the absence of encounters with other molecules,  $F$  remains constant for all time, then the form of  $F$  satisfying the condition  $Ff = F'f'$  must render  $F(f, q)$  *a priori* a permanent law of distribution, and therefore if we can assert that  $F(f, q)$  must of necessity be of the form  $F(E)$  ( $E$  sum of potential and kinetic energy), then the  $e^{-E}$  law of distribution is certainly a permanent law (neglecting, *i.e.*, all but binary encounters); but in the absence of this proposition, we cannot assert that the  $Ff = F'f'$  is necessary as well as sufficient, because we cannot insist upon the necessity of an exact compensation in the passage from the  $p, q$  to the  $p', q'$  state, and conversely, taking place at each separate encounter. The II proposition, therefore, removes this element of uncertainty, and reduces the question to that of the  $F(E)$  restriction, because it proves that unless  $Ff = F'f'$  for each pair of encountering molecules, II and therefore  $F$  and  $f$  must be a function of the time. As I have already asked for a disproportionate share of your space, I will not enter upon the question of the  $F(E)$  restriction now.

II. W. WATSON.

I DID not exactly, as Mr. Burbury suggests, question Boltzmann's minimum theorem, but only the pages thereon in Dr. Watson's "Kinetic Theory of Gases." Indeed, I said that though I had not seen Boltzmann's proof, I supposed it to be all right.

It appears from Mr. Burbury's letter that in order to prove the theorem, even for the simple case of perfectly hard and elastic spheres, some amount of assumption as to an average state having been already attained must first be made, and of course the *a priori* reasoning in my letter is not applicable to such a theorem. Mr. Burbury's letter is exactly the kind of letter I hoped to elicit, and if he can say what assumption in a generalised system will replace the assumption of equal distribution of velocities in different direction in a system of hard spheres, he will clear up the whole difficulty. Unfortunately, the case with which he deals is one in which the error-law is known from other considerations to be the only permanent state.

I observe that Mr. Bryan, in his British Association Report, quotes the oversight I pointed out in Dr. Watson's proof, without making any criticism on it.

EDWD. P. CULVERWELL.

Trinity College, Dublin, November 24.

**The Alleged Absoluteness of Motions of Rotation.**

PROF. GREENHILL, in his review of Mach's "Science of Mechanics" (NATURE, November 15), writes as if he disapproved of that author's not accepting "Newton's distinction between the relativity of motion of translation and the absoluteness of motion of rotation." He appears to think that Mach would have obtained more insight into this distinction from a study of Maxwell's "Matter and Motion." It might more truly be said that Maxwell would have profited by a perusal of Mach's book. The latter finally refutes the paradox contained in Newton's statement, and supported by Maxwell, and by so doing renders a great service to Mechanical Science. He has disposed once and for all of "absolute rotation." It is high time that writers on Mechanics should revise the preliminaries of their science so as to state their results in terms of relative motion, whether of translation or rotation. This has been partially done by Maxwell, and a further step has now been taken by Mach. It is unfortunate that the reviewer in drawing attention to this part of the book should have preferred to stand by the prejudice he owes to Newton and Maxwell when he might have done something to hasten its abandonment.

A. E. H. LOVE.

St. John's College, Cambridge, November 20.

MACH says truly (p. 237) "that precisely the apparently simplest mechanical principles are of a very complicated character; that these principles are founded on uncompleted experiences, which can never be fully completed," &c.

The modern student of theoretical mechanics is in a dilemma;

either he must accept the complete idea of the relativity of all motion, of rotation as well as of translation, as professed by Milton, Mach, and Mr. Love; or else he must follow Newton, Maxwell, and the German writers Sirentz and Lange attacked by Mach in Appendix iv.), and distinguish between the relativity of the motion of translation and the absoluteness of rotation. Euler, it appears, was a waverer, and according to Lange never arrived at any settled and intelligible opinion upon the subject. The first theory appears more analogically complete, but introduces unnecessary complication at an early stage; and stronger arguments than those of Mach, and others that I have yet met with, will be required to convert me to their side of the question.

A. G. GREENHILL.

November 26.

### Science Teaching in Schools.

IN the discussion on the teaching of science, and in the schemes put forward for reorganising this teaching, mathematics has so far been left out of consideration.

At present mathematics is taught for its own educational value, which has been traditional since the time of Plato; only in modern times has its great practical value been recognised. The teaching in schools takes little account, however, of the applications of mathematics, and whatever Prof. Greenhill may say (in his review of Prof. Mach's excellent book), there is still wanting complete harmony between those two points of view; not perhaps in the higher branches of the subject and its applications, but certainly in school teaching.

Boys, and girls too, in public schools are taught the elements of mathematics as if all were expected to become mathematicians, and the practical side is kept out of view. In the modern or science side, which has been introduced at many schools, one finds too often chiefly those boys who show no talent either for classics or mathematics. Many of these have made little or no progress in Euclid; they cannot grasp the altogether abstract notions and symbols of algebra, and they therefore never come near trigonometry. But they are expected to understand the elements of chemistry, mechanics and physics; and it is instructive to find that they very often do understand a good deal of what is taught under these headings.

Now none of these subjects can be accurately taught—and inaccurate teaching is worse than waste of time—without the introduction of mathematical reasoning. Here we are in a vicious circle: the boys are considered incapable of learning mathematics, and therefore mechanics and physics have to be taught without any more than the most elementary notions of geometry and algebra; hence not much progress can be made.

In my opinion the order of procedure might be reversed. Mathematics might be taught through experimental science. If the boys themselves make, as they should do, experiments where they perform actual measurements, they will learn there are certain laws connecting various quantities; they will see that such laws can be expressed in simple symbols, and they will thus grasp in the concrete form the meaning of a formula or an equation which in the abstract form of pure mathematics remained a mystery to them.

Mathematics could in this manner be made very much easier and more interesting to the majority of boys. Geometry can be treated to a very great extent experimentally by aid of geometrical drawing and a development of the Kindergarten methods; the abstract logic of Euclid can then follow, or it can be treated at the same time.

Trigonometry need not be at once as fully gone into as is generally done, but the definitions of sine, cosine, &c., as names for certain ratios, can be easily and early introduced and made use of at once in mechanics or physics. Here also special experiments may easily be devised where measurements of angles or lines are made, and lines and angles calculated.

To explain fully what I mean I should require a great deal of space; in fact it would be almost necessary to draw up a distinct syllabus for a course on the above lines, or to give at least a great number of examples.

At present I wish only to urge that, while many attempts are being made to improve science teaching, and with it technical education, mathematics should be included, and to express my opinion that this science also allows of experimental treatment.

November 17

O. HERRICK

MR. CRUMP (*vide p. 50*) though adopting a critical form and tone, really endorses the grounds of my suggestion that the Science and Art Department should dis sever itself by an age limit from school science. He is inclined to be especially severe upon the defects of the Government examinations because they are controlled by scientific men, and to excuse the proper school examining boards because they have—according to Mr. Crump—attempted to examine in science without any qualification to do so. But I fail to see why eminent scientific men should be expected to be experts in elementary science teaching, any more than distinguished *littérateurs*, in the art of teaching to read, and it seems to me—in spite of Mr. Crump's "absolute" denial—that examining boards, neither professedly literary nor scientific but professedly educational, are more to blame in following and abetting the Department's premium upon text-book cramming. The fact remains that the London Matriculate ignores practical teaching of any kind, and that the "practical chemistry" of the Locals and College of Preceptors is essentially the same test-tube analysis as the South Kensington examination. Any one who knows the London Matriculation examination—witness Miss Heath's concluding remark—will appreciate the quiet humour of Mr. Crump's allusion to it as "awakening and developing the powers of observation and reasoning."

H. G. WELLS.

### The Explosion of a Mixture of Acetylene and Oxygen.

WITH reference to your note in last week's NATURE, I may say that, whilst the thanks of chemists, and particularly of those whose duty it is to perform lecture-experiments, are due to Prof. Lothar Meyer for once more drawing attention to the dangerously explosive nature of mixtures of acetylene and oxygen, it may be assumed that the facts already known concerning acetylene account sufficiently well for the great violence of the explosion, and hence for the circumstance that the mixture will shatter even the open cylinder in which it is detonated. What M. Berthelot terms the molecular rapidity of the reaction, as distinguished from the rapidity of propagation, in the case of mixtures of acetylene and oxygen is very high. The heat of the reaction, too, is nearly five times as much as in the cases of electrolytic gas and of carbonic oxide, and more than twice as much as that of methane. It is slightly exceeded by that of ethylene, but, on the other hand, the theoretical temperature of the change with acetylene is enormously greater than in the case of any other explosive mixture of gases. The temperature, too, required to initiate the change is, as Prof. Lothar Meyer showed indirectly some ten years ago, much lower in the case of acetylene than in that of the other gaseous mixtures of which he speaks. All the conditions tend to make the duration of the reaction so nearly instantaneous that the initial pressure cannot be far removed from the theoretical pressure, and this is sufficient to smash a much stronger envelope than a glass cylinder, even if the "tamping" be nothing more than the air. Everything we know about acetylene combines to show that it is extremely "sensitive" as an explosive, and that in this respect, as in its destructive action, it resembles mercuric fulminate.

T. E. THORPE.

### "Newth's Inorganic Chemistry."

THERE are one or two points in Mr. Pattison Muir's review, upon which I should like to be allowed to say a few words.

Criticising the general plan of the book he says:

"It seems to me that the method of the author is radically wrong. Descriptive statements of facts ought surely, neither to precede, nor to follow, but to accompany the reasoning on these facts whereby general principles are gained."

It is not easy to see how the *descriptive statements of facts*, and the *reasoning on these facts* are to be printed in a book at all, unless one either precedes or follows the other. I can only suppose that my reviewer means, that such theoretical and other considerations as I have included in part i., and have called "introductory outlines," should in his opinion not be collected together either at the beginning or at the end of the book, but should be sprinkled among the descriptive chapters. It seems to me that the plan I have adopted, besides being a



more orderly arrangement, and one more convenient for reference, is also the one that best enables the student to study the subject in the way advocated by my reviewer; and in order to impress upon the student that the study of descriptive facts should accompany the study of the reasoning on these facts, he is directed to "slowly and carefully" read part i. *while he is studying the descriptive chapters.* I venture to think also, that this method tends far less to "perpetuate the vicious and unreal distinction between chemistry and chemical philosophy" than that of obliging the student to gain his information of facts from one book, and his knowledge of theory from another.

Commenting upon the fact that part ii. is devoted to the study of four typical elements, Mr. Muir says:

"But hydrogen, oxygen, nitrogen, and carbon are not treated as typical elements; they are not compared and contrasted with other elements."

This criticism is not true. Chapter ii. of part iii. is prefaced with a short general account of the elements oxygen, sulphur, selenium, tellurium, in which the typical element oxygen is compared and contrasted with its *confreres*. Chapter iii. is prefaced with a similar brief sketch of the elements nitrogen, phosphorus, arsenic, antimony, bismuth, wherein the typical element nitrogen is compared and contrasted with the others of the group; and similarly at the beginning of chapter ix. the typical element carbon is compared and contrasted with silicon, germanium, tin and lead.

My reviewer is good enough to say: "The descriptions in this book of the members of each group of elements seem to me to be exceedingly well done; many portions of the chapters treating of principles and theories . . . are admirable." And again, a few lines further on: "The purely descriptive portions of the work are often extremely good, as far as they go. The facts, or rather half-facts, are stated in a clear and orderly way."

I am a little curious to know what *half-facts* are; and whether if such things can be, it would be possible to state them "in a clear and orderly way." If my reviewer merely means that there are so many more facts known than I have stated, that roughly speaking it may be said that I have only described one half of the known facts, I can only reply that I have endeavoured to select "from the overwhelming burden of so-called facts" such as seemed to me to be most important for the student, and which could be conveniently included within the limits of a small text-book.

Mr. Muir finds fault with my book because he does not discover in it "some fair and fitly fashioned building," which he says "ought to rise on this broad superstructure." I regret that this objection has not been stated in rather more explicit terms; I have tried to understand it, but cannot—perhaps it is poetical. In ordinary language one does not speak of a building as rising upon a superstructure. In no text-book of chemistry with which I am acquainted, is any trace of such a phantom edifice to be found, and it is sincerely to be hoped, that when the Joshua appears, who by raising such a "fitly fashioned building" shall "rescue chemistry from the overwhelming burden of so-called facts beneath which the science is in danger of being buried," he will choose some more suitable vehicle for making his views known to the scientific world than that of an elementary text-book on inorganic chemistry.

G. S. NEWTH.

I STILL hold that Mr. Newth's method is radically wrong. I admit it is not easy to make the descriptive statements of chemical facts accompany the reasoning on these facts; but although not easy it can be done.

As regards Mr. Newth's treatment of the four typical elements, hydrogen, oxygen, nitrogen, and carbon, I can only repeat that the comparisons and contrasts made between these elements and those of which they are representative are, in my opinion, worth very little.

I cannot enter into a discussion of the meaning of the term "half-fact"; but I can assure Mr. Newth that in saying he had stated "half-facts in a clear and orderly way," I did not mean to say he had stated about half of the known facts and omitted the rest. It is characteristic of half-facts that they are very amenable to clear and orderly arrangement.

When I spoke of "some fair and fitly fashioned building" rising "on this broad superstructure," of course I should have written "broad substructure." I am much obliged to Mr. Newth for pointing out this stupid slip.

NO 1309, VOL. 51]

I thought Joshua was more concerned with demolishing towns than with raising buildings; but my Hebrew history is a little rusty.

M. M. PATFISON MUIR.

Cambridge, Nov. 21.

#### Singing Water-Pipes.

AT Oxford, Prof. Osborne Reynolds showed an interesting case of sound in water. There is another familiar effect, of which he has probably given the reason, but it does not seem to be commonly known.

A little while back there was a clear steady note carried through my house by the water-pipes, a note of the middle octave of the quality of an organ diapason pipe. When the source was found, it was easy to change the note through the octave. The music arose as often as the scullery tap was turned on, and lasted so long as the water was running. The tap was worn, and the flow of water kept up a rapid tapping of the loose part, just as in Trevelyan's Rocker.

The singing is sometimes heard after a tap is turned off. This happens because the ball-tap of a cistern has thus been left running.

W. B. CROFT.

Winchester College, November 26.

#### An Aurora on November 23.

STEPPING out of doors to-night, November 23, at 7.30, I was surprised to see the whole northern sky filled with luminous mist, so clear that our shadows were dimly observed on the shining surface of the wet highway. There were few tremulous motions, but the light clouds advanced southwards in great patches. For a while the planet Jupiter shone to the east of the luminous haze. Then the mist passed over Jupiter, who shone, however, with nearly its wonted splendour until a great detached belt hung between Jupiter and Pleiades, over to the south-west horizon.

The Milky Way became obscured as the haze passed right over our heads. By eight o'clock the detached luminous belt, which was not uniform, but in patches, had reached the planet Mars. Neither was the light in the north uniform, but here and there were clear spaces. By 8.10 the aurora was much dimmer. By 8.30 there was no luminosity except in the north, between the Great Bear and the horizon.

J. SHAW.

Tynron, Dumfriesshire.

#### A Snake "Playing 'Possum."

A PUFFING adder, *Heterodon platyrhynchus*, caught by the writer in May 1894, exhibited a most curious instance of feigned death which may be worthy of record.

The snake when discovered at first tried to escape, but on being captured it turned on itself with mouth wide open, head thrown back sharply, and tongue limp and protruding. The mouth remained open thus to its fullest extent, while the head and upper part of the body thrashed violently from side to side for a few times, and then his snakeship rolled over on his back, and after a few convulsive movements became apparently lifeless. The body was then quite limp, and remained in whatever position it was placed, providing the snake was on his back, but when turned over in the proper position, he immediately rolled back by an almost imperceptible muscular contraction. When struck lightly, pinched or held up by the tail, there was very slight resistance. He continued in this state for about half an hour, when no attention having been paid to him, he resumed his normal position. A little teasing caused a repetition of this performance a number of times afterwards, and it did not vary in any essential particular. It would be interesting to know whether this is a ruse common to individuals of this species, and if so whether it is confined to them alone.

L. C. JONES.

#### The Soaking of Seeds.

IN reply to Mr. Alfred W. Bennett's inquiry as to the soaking of seeds in milk before sowing, it may interest him to learn that in book iii. section v. of his "Deipnosophists," Theophrastus is quoted by Athenæus as saying that "cucumbers contain a more agreeable and wholesome juice if the seed be steeped in milk or mead before it is sown," and that "plants come up quicker if they are steeped in water or milk before they are put in the ground."

P. C. GLUBB.

Pen-lean, Liskeard, November 13.

## HISTORY OF ENCKE'S COMET.

**H**ISTORICALLY, Encke's comet, which has recently come into view again, stands next in interest to Halley's. The history of the latter can be carried back much farther than that of any other comet. It was indeed conjectured that the one (the first telescopically discovered comet, by Kirch) which made so near an approach to the sun in 1680, and in reference to which Newton first applied his principle of universal gravitation to the motions of these bodies, was identical with comets seen at intervals of about 575 years before, and Gibbon not exactly an astronomical authority, who recommends others to study Newton and Halley on the question devotes a section of his forty-third chapter to the supposed history of these early appearances (two of them in mythical times), concluding with the remark that the calculations with regard to it might perhaps in the year 2355 "be verified by the astronomers of some future capital in the Siberian or American wilderness," little thinking how many splendid telescopes would be employed on the study of the heavens in the "far west," before a century had elapsed from his own death. There was then, in 1704, no observatory on any part of the American continent. But it is now known that the period of the comet of 1680 amounts not only to hundreds, but to thousands of years; and one of the supposed previous appearances, that in the reign of the Emperor Justinian, was in all probability a return of the smaller or less conspicuous comet which appeared in 1682, and at the next return in 1758-9 acquired the name of Halley's comet, because that eminent astronomer had confidently predicted its return at that date, calling upon posterity to notice that the prediction had been made by an Englishman. He recognised its identity with comets observed in 1531 and 1607, by a comparison of the orbits calculated for each, and considered from the similarity of period, that the fine comet of 1456 was also probably an earlier appearance of the same. Later investigations, and the accessibility of Chinese records, have shown since his time that successive appearances of this body can be traced with very great probability to a date before the Christian era, our distinguished countryman, Dr. Hind, having taken a leading part in these calculations.

Of the subsequent observations of this comet in 1835, this is not the place to speak, nor of the full expectation astronomers then living will entertain of seeing it again in 1910, and applying the new methods of analysis to it, thereby obtaining information respecting its constitution, which was beyond the wildest flights of imagination at its last appearance. For our present subject is a comet which acquired the name by which it is now universally known as a fitting meed of honour to an astronomer who worthily presided over the then new observatory at Berlin within our own recollection. Many comets have since that time returned according to prediction; but when Encke announced that the small one discovered by Pons at Marseilles on November 26, 1818, was identical with the discovery of Mechain in 1786, of Miss Herschel in 1795, and of Thulin in 1805, no predicted return of any comet but Halley's had ever taken place, though two predictions had been made, by himself and by Bessel respectively, of the returns of comets observed in 1812 and 1815, which duly came to pass in 1883 and 1887, the periods of these being nearly as long as that of Halley's. The remarkable point about Encke's comet was the extreme shortness of its period, amounting only to 1212 days, or three years and about four months. It was therefore concluded that it would reappear in 1822; true to prediction it did then appear, but from its situation in the heavens was visible only in the southern hemisphere, which then possessed only one observatory, that established (but which has long ceased to exist) by Sir Thomas Brisbane at Parramatta, New South Wales, where the

comet was rediscovered by Rümker on June 2. The next appearance took place in the autumn of 1825, when the comet was observed in this hemisphere, and since that time it has never failed to be observed at the calculated epochs. Encke did not desert it after he had determined its period in 1819, but, following up its motions with accuracy, was led to notice a remarkable continuous shortening of the period by a fraction of a day at each return. The question had before his time been started whether a medium might be diffused through the solar system which, though insufficient to affect the motions of the planets, would produce appreciable effects upon those of comets, composed as they must be of matter in a state of great rarity. Here was a case which seemed to settle the question in the affirmative. Encke's calculations showing that the diminution in the observed length of the period was such as might well be caused by the action of such a resisting medium checking the onward motion of the comet, which would bring it a little nearer to the sun at each return, and thus shorten both the orbit of revolution and the period of time in which it was accomplished. The difficulty remained how to explain the fact that no such effect was perceptible in the motions of any other comet; a difficulty which the lapse of time has not removed, for though in one other case (that of a comet known as Winnecke's) a similar effect was for a while thought to be noticed, further investigation showed that this view could not be sustained. Encke, however, to the end of his life (he died in 1865) was able to trace the above continuous effect in the motion of his own comet, the period of which was then 1210.2 days, or 1.6 days shorter than it had been in 1819. But, strangely enough, soon afterwards, the amount of retardation was reduced by about one half, at which it has remained from 1868 to the present time. Must the resisting-medium theory be modified, or must it be altogether abandoned and some other cause be sought for the retardation in question? Prof. Young suggests a regularly-recurring encounter with a cloud of meteoric matter.

When nearest the sun, Encke's comet is at very nearly the same distance from him as the planet Mercury. When farthest from him, it is in the zone of small planets (nearly four hundred of which are now known), revolving between the orbits of Mars and Jupiter. May the attraction of some of these have something to do with the effect above referred to? Small as is the mass of most of the tiny bodies in question, it is possible that at certain times some of them may act together and produce a cumulative and appreciable effect. Of great value to astronomy has been the position of Encke's comet at the other extremity of its orbit, in perihelion. Before its discovery, the mass of Mercury had been rather a matter of conjectural inference than of actual calculation, that planet having no satellite the motions of which would be affected by its attraction. But at certain returns, the comet of which we are treating, made very near approaches to the planet, and the effects produced on these occasions have enabled astronomers to obtain determinations of the mass of the planet as accurate, or nearly so, as those determined for the larger planets which have satellites. The first of these near approaches since the comet's discovery took place in 1835; the last at the most recent return, in 1891.

We now come to the physical appearance of Encke's comet. It has on some occasions, when nearest the Earth, been just visible to the naked eye, particularly in the autumns of 1828 and 1848. After Miss Herschel had detected it (supposed to be a new comet), at its return in 1795, her brother, Sir William Herschel, observed it on November 8, and noticed it the following day pass centrally over a star of the twelfth magnitude without obscuring it, whence he concluded that the comet "is evidently nothing but what may be called a collection of vapours." Maskelyne, who observed it at

Greenwich a few nights afterwards Bode had in the meantime, in company with an amateur astronomical friend, detected it at Berlin on November 11, four days after Miss Herschel's discovery at Slough). contested this view on the ground that the nucleus might be situated not in the apparent centre of the comet. And this indeed would seem to be the case: the general appearance of the comet, when seen under the most favourable circumstances, being that of a slightly oval vaporous mass, with a small ill-defined nucleus eccentrically situated within the coma. In 1848, towards the end of September, a faint brush of light was noticed by Prof. Bode, extending from the more condensed part of this towards the sun; and a few weeks afterwards a tail, between one and two degrees in length, was seen on the other side, *i.e.* the normal position of a comet's tail. Late in the month of November in the same year, it may be remarked, the comet made one of its very near approaches to Mercury, coming within the distance  $0.038$  of the Earth's mean distance from the sun, or about three and a half millions of miles. The return of 1871 was a noteworthy one in several respects: and particularly for the remarkable fan-like appearance which the coma presented in November and December.

The apparent contraction of a comet's bulk as it approaches the sun, and dilatation of it again when receding from him, which has been manifested in several of these bodies, has been especially marked in the case of Encke's, the visible diameter at perihelion being not equal to the twentieth part of what it is about the time when the comet first comes into view. The most probable cause of this would seem to be that suggested by Sir John Herschel, which would make it rather apparent than real, namely, that near the sun a part of the cometary matter becomes invisible by evaporation, just as a cloud of fog might be.

In 1871 the spectrum of this comet was examined by Prof. Young, and found to consist of three bright bands, of which the central one was the most prominent; they were somewhat sharply defined on the least refrangible side, whilst on the other they were diffused. "Of a continuous spectrum there was no trace, and the spectrum was the same from every part of the comet." But in 1881 a faint continuous spectrum was detected by Prof. Tacchini, so that the result of spectrum analysis applied to this comet would seem to be essentially the same as that obtained from the great majority of comets of which the light has been examined in this way.

At the last appearance of Encke's comet, in 1891, it was first seen by Prof. Barnard at the Lick Observatory in California, at the beginning of August, and passed its perihelion on October 18. At the present return it was detected at the Nice Observatory on October 31, in the constellation Pegasus; and Dr. Max Wolf found it registered on a photographic plate taken by him the same evening at Heidelberg. As on several previous occasions, its ephemeris has been calculated by Dr. Backlund, of Pulkowa; and it is matter of regret to notice his accompanying announcement that this is the last occasion on which he will be able to undertake it. The earlier portion of this ephemeris was given in NATURE last week.

W. T. LYNN.

#### PROGRESS OF THE CATARACT CONSTRUCTION COMPANY'S WORKS AT NIAGARA.

THE general scheme of the Niagara Falls Power Company has already been described in these columns (NATURE, vol. xlix. p. 482). We understand that the great power house is now complete, and the foundations ready for the three great 5000-horse power dynamos

which have been constructed by the Westinghouse Company. The turbines and vertical shafts up to the floor of the power house have long been in place, and the dynamos may now be shipped any day. They have already been revolved in the shops at full speed. Our readers will remember that there is no gearing. The dynamos are on a vertical shaft, and the revolving fields are external to the armature, forming a sort of bell cover to it, with the poles pointing radially inwards. This was the only design which Prof. Forbes could make to fulfil the requirements of the turbine designers as to maximum weight and minimum fly-wheel effect to be allowed. It gives a splendid mechanical construction, as the revolving pole-pieces and coils are retained in place against the centrifugal forces by the nickel-steel ring which forms the yoke.

The first place to be supplied with current is the aluminium works of the Pittsburg Reduction Company. To convert the two-phase, 2000 volt alternating current into a continuous current of 160 volts at these works, 2500 feet from the power house, transformers are there used, and the low pressure alternating current in two phases is supplied to commutating machines. This is a new departure of great interest, as no machines of this class have been previously built except for experimental purposes. They are each of 500-horse power, and are continuous current machines with four rings attached to four bars of the commutator. The alternating current is supplied by brushes rubbing on these rings, and it drives the machine as a motor. The continuous current is taken from the commutator by brushes in the ordinary way. All this machinery was made for the Cataract Construction Company by the General Electric Company, which is far the largest electrical concern in the United States. The machinery was tried in September, and it seems to work admirably. Four of these machines, with eight transformers, equal to 2000-horse power, are being put down to begin with.

The next place to be supplied is the Carborundum Company, which makes a substitute for emery, much harder, being composed of carbon and silicon raised to a high temperature in an electric furnace. They begin with 1000-horse power, and their factory is making good progress.

After that the Buffalo transmission will go on, but the selling of power in the neighbourhood is more profitable than at a distance; and many of the manufacturers, who have been holding back for two years to see how the tariff was to be settled, will now start factories, and some of them will settle at Niagara Falls to get the cheap power.

The transformer house, for raising the electric pressure from 2000 to 10,000 or 20,000 volts, is on the side of the canal opposite the power house, and these are connected by a massive stone bridge, with a covered way for carrying the cables. The concrete subway starts from the transformer house, and is at present to be used for supplying the first customers on the Company's lands.

Everything looks most promising at present, and as to the electrical works, everything indicates that any other general scheme than the one adopted would have been vastly inferior. Especially is low frequency proving itself invaluable. The continuous current could not have been got for the aluminium works without it, the motors will be far more satisfactory, and the safety and economy of the line is far higher. It was once objected that transformers could not be cheap or efficient at the low frequency proposed. Prof. Forbes held, however, that large sizes could be got even with low frequency at half the cost and at higher efficiency than anything that had been done on a small scale. This statement was based upon his own designs; and now it is entirely supported by all the manufacturers who have made designs for the work.

## THE NILE RESERVOIR.

AN official memorandum upon the proposed modifications in the Assuan dam project has been drawn up by Mr. W. E. Garstin, C.M.G., Under-Secretary of State in the Egyptian Ministry of Public Works, and is published in Tuesday's *Times*. It will be remembered that an account of the schemes for the irrigation of Egypt was given in these columns a few months ago (vol. I, p. 80).

Several arguments have been brought against the Assuan cataract as the site for the dam. The first is that this site is not the only possible one to be found north of Wadi Halfa. The second, and, at first sight, the strongest, argument against the proposal is that it is impossible to lay down as an axiom that the Assuan cataract site is the only feasible one for a dam, while the river valley south of Wadi Halfa has been unexplored and unsurveyed.

Mr. Garstin criticises the arguments, and shows that the project proposed best meets the case. In this opinion he is supported by the English and Italian members of the Technical Commission Sir Benjamin Baker and Signor Torricelli—who reported that there is only one safe site for a dam between Cairo and Wady Halfa, namely, the Assuan cataract. Subjoined is Mr. Garstin's description of the scheme. The careful consideration which has been given to the matter reflects great credit upon the Egyptian Government. Science is to be congratulated upon the action that has been taken; for the benefits that will accrue to it from the investigations which it is proposed to carry out over the whole of Nubia will be of the highest importance.

The Council of Ministers on June 3, 1894, approved in principle of the proposed dam and reservoir at the Assuan cataract, and directed the Ministry of Finance, when preparing the Budget for 1895, to occupy itself with the question of obtaining the funds necessary for the execution of this work.

The project, as then submitted to the Government, consisted of a dam with its crest at R.L. 114'00, which height would have enabled water to be stored in sufficient quantity for the requirements of Middle and Lower Egypt; in other words, for the whole country lying to the north of Assyut.

Most unfortunately the construction of this dam would have necessitated the submersion for some six months every year of the celebrated Philæ temples, as well as of a considerable number of Nubian monuments, which, although less known than those of Philæ, are of great importance to all those interested in the history of ancient Egypt.

The archaeological societies of Europe, upon hearing of this proposal, protested against it in the strongest terms, and begged the Egyptian Government to reconsider its decision, and to endeavour to find some alternative scheme by which the country might reap the advantages to be derived from a storage reservoir, without sacrificing the interests of science and archaeology.

The Ministry of Public Works, recognising that these protests were founded upon reasons so strong as to command respect, reconsidered the whole matter in detail, and endeavoured to find such modifications of the original scheme as might reconcile the interests of Egypt and of science.

The result of its studies is the modified project which has now been submitted to the Egyptian Government.

The modified scheme as at present submitted is of the nature of a compromise; it is hoped that it will satisfy the scientific world, while, at the same time, it will further the interests of this country.

It is now proposed to build a dam at Assuan with its crest at R.L. 109'00, or eight metres (26 ft.) lower than that of the original project. This work will of necessity store very much less water than the high-level dam would have done. At the same time a reservoir of this height will supply sufficient water for the wants of either Middle or Lower Egypt separately, although not for their combined areas.

This will mean that the reclamation of the country will proceed more slowly than was at first proposed; and when in course of time the country to the south has been explored a

second dam can be made which will store sufficient water for the needs of the rest of Egypt.

This proposal is no new one, but has been fully discussed and estimated for in Mr. Willecocks's report upon the different sites.

The great advantage to be derived from carrying out the work in the above manner is that it will only submerge portions of the Philæ island, while it will leave the rest of the Nubian monuments untouched. A reference to Mr. Somers Clarke's note upon these latter will show that their levels are all well above that of the highest water surface in the modified project as now submitted.

As regards the Philæ temples, the main buildings will be above high-water level altogether. It is true that the South Quay wall, and some of the smaller temples, would be submerged if left unprotected. It will, however, be possible, by the construction of a low water-tight wall, or by other means, to so arrange for their protection that no damage will be done to them by the water.

To a certain extent the artistic beauty of the group will be impaired, but in a land so full of interesting relics as is Egypt, it is unfortunately impossible to carry out any great public work without in some degree interfering with some one or other of these. The only thing to be done is to try and minimise this interference as far as is possible, and in the present case the Ministry of Public Works thinks that it has succeeded in so doing.

As regards the details of the protection works to be carried out upon the Philæ island this Ministry will consult the scientific societies upon every point, and will endeavour, as far as lies in its power, to meet their wishes in the matter.

In order to still further minimise any possible loss to science which might ensue from the construction of the reservoir, it is proposed to carry out an archaeological and scientific investigation of the whole of Nubia.

The English societies very rightly impressed the necessity of this work upon the Egyptian Government. The latter, although both willing and anxious to carry it out, found it impossible to do so, owing to the necessary funds not being available. If, however, the reservoir be made this difficulty at once disappears, as the cost of the above investigation will be added to the estimate of the dam itself.

The Public Works Department has been directed to put in hand as much of the work as lies within its scope and power during the ensuing winter season. Topographical surveys will be made and plans prepared; the true bearings of the temples will be fixed and the preliminary plans of all sites completed.

This portion of the work being done, the Egyptian Government will ask the European scientific societies to depute certain of their members to come to Egypt and complete the work.

In this manner it is hoped that a record and a knowledge will be obtained of this most interesting country which will be worthy of the present age, and which should be of the greatest value to the scientific world in the future.

## NOTES.

WHERE the good of science is concerned, the Goldsmiths' Company is generally among the leading benefactors. With characteristic generosity, the Company has decided to make a grant of one thousand pounds for the purpose of prosecuting research work in connection with the anti-toxin treatment of diphtheria, and in aid of the manufacture of the serum. At the request of the Company, the Laboratories' Committee of the Royal College of Physicians and Surgeons have undertaken the administration of the grant.

REUTER'S correspondent at Rome reports that at a quarter past six on the morning of Tuesday, November 27, an earthquake occurred at Brescia, in Lombardy. The shock was followed by subterranean rumblings. A similar, though less violent, movement was felt at Bologna at nine minutes past six. Five minutes earlier a sharp disturbance occurred at Vienna, lasting four seconds. It was followed almost immediately by a second slighter shock of two seconds' duration. Shocks were experienced about the same time at Domodossola, Mantua, Favia, Parma, and Bergamo, while at Rome the seismic instruments gave evidence of disturbance.

THE Société Internationale des Electriciens established a central laboratory at Paris about seven years ago. The principal object of the laboratory was the preservation of electrical standards, and to afford practical electricians an opportunity for testing their various instruments. It is evident that such a laboratory offers special advantages for the investigation of questions belonging to the science and industry of electricity. These facilities have been to some extent utilised; but in order to increase the usefulness of the institution, the Society has added to it a School of Applied Electricity. This school, which will be opened on December 3, has been constructed on a plot of land granted by the city of Paris, the funds for the building having been raised by private subscription. Purely practical instruction will be given at the school. There will be two chief courses, one dealing with the industrial applications of electricity, and the other with electrometry. It is hoped that the school will be a training ground for higher work in the Central Laboratory, to which it is attached.

A RUSSIAN ethnographic exhibition will be held next year in the Champ de Mars, Paris.

THE University of Chicago is establishing a special department of botany, with Prof. J. M. Coulter at its head.

IT is announced that the printing of the important and laborious "Index Kewensis" will probably be completed about Midsummer 1895.

THE death has recently occurred of Dr. L. Schwarz, the Director of Dorpat Observatory, and the Professor of Astronomy in the University there.

THE resolutions passed by Convocation at Oxford, last summer, in favour of conferring degrees upon persons who have pursued a course of special study or research in the University, were submitted to a Congregation on Tuesday, and, after some discussion, the preamble was carried by a majority of sixty-nine votes.

A DALZIEL telegram from Halifax, Nova Scotia, dated November 27, says: "It is reported that the steamer *Falcon*, of the Peary Arctic Exploration Expedition, was wrecked on the Virgin rocks, some distance off the southern coast of Greenland in October, and that all on board perished."

THE Royal Botanical Society of Belgium has established a Committee of Vegetable Pathology, holding its sittings in the Botanic Garden at Brussels, for the purpose of affording information to nurserymen, horticulturists, and arboriculturists, respecting the diseases which attack plants, and the best mode of combating them.

IN January last, attention was drawn to the fact that a sale of seven lions had taken place at the gardens of the Royal Zoological Society of Ireland, of which number six were born in Ireland. A further batch of five cubs, all males, has recently been disposed of by the Council, after a protracted correspondence. The total exchange value for these twelve lions exceeds, we understand, £500.

AGRICULTURAL Associations seem to be waking up to the necessity for the scientific investigation of diseases and pests affecting crops. One of the resolutions passed at a largely-attended conference of agricultural societies of New Zealand held during the past summer, was—"That the services of a first-class entomologist be obtained by Government, who shall give his whole time to an examination of insect pests, with a view to their destruction." It was also resolved to request the Government to get expert opinions as to the best method of exterminating the grub in corn and grass crops.

THE promotion of an intellectual observance of Sunday is the object of the Sunday Society. At present the Society numbers

among its chief aims the opening of the Natural History Museum and the South Kensington Museum on Sundays, so that the scientific collections of the nation shall enlighten a wider public. In furtherance of the general principle involved, a number of special sermons will be delivered next Sunday, this being the Society's third annual Museum Sunday; and several science and art collections will be open to members of the Society.

NEAR Dunkeld Cathedral, in the Duke of Athole's grounds, are two of the original five larch trees said to be the first introduced into this country. They were planted in 1738, and in the year 1888 they were measured with the following results:

Height	...	...	...	102 ft. 4 in.
Circumference:				
3 ft. from ground	...	...	...	17 ft. 2 in.
5 ft. " "	...	...	...	15 ft. 1 in.
17 ft. " "	...	...	...	12 ft. 10½ in.
51 ft. " "	...	...	...	8 ft. 8 in.
68 ft. " "	...	...	...	6 ft. 1 in.

MR. WALTER B. HARRIS gave an account of his recent journey to Tafilet, at the last meeting of the Royal Geographical Society. He left Morocco city on November 1, 1893, in disguise, and crossed the Atlas at an elevation of a little over 8000 feet. In connection with this, it is worth noting that the *Bulletin* of the Paris Geographical Society (vol. xv. p. 199) contains a description, by M. Gabriel Delbrel, of a visit he paid to Tafilet last year.

DR. KARL KARSTENS, of Kiel, has made a critical revision of the various estimates of the average depth of the oceans, as arrived at by the methods of different calculators. These methods he classes as of three kinds: that of measuring areas by the planimeter on a contoured map, that of calculating the areas of successive profiles drawn at intervals of 5° of latitude apart, and that of taking the mean depth of the soundings in definite small areas, and combining these to give the mean depth of the whole. Murray and Penck had made calculations by variations of the first method, and got out the mean depth of the oceans as 3797 metres (2074 fathoms) and 3650 metres (1995 fathoms) respectively; Heiderich, by the second method, got 3438 metres (1881 fathoms); and Krümmel, by the third method, gave the figure 3320 metres (1815 fathoms). Since Krümmel's calculations were made in 1886, his student Karstens has gone over them, taking advantage of the very numerous additional soundings which have been made, and he comes to the conclusion that the average depth of the oceans as a whole is 3496 metres, or 1909 fathoms. The maximum probable value was 3632, and the minimum 3377 metres. The mean depth of the Pacific Ocean is given as 3829, of the Indian Ocean 3593, and of the Atlantic 3160 metres.

HERR P. DINSE published the first part of a discussion of the geographical characteristics of fjords in a recent number of the *Zeitschrift* of the Berlin Geographical Society, vol. xxix. p. 189. This instalment deals with the morphology of fjord-riven coasts, a subsequent paper being intended to treat of the theory of the origin of fjords. The author distinguishes between *fjords* or inlets running into steep coasts, and sometimes branching, including one or more basins deeper than the sea immediately outside, and *fjord-channels* or sounds which are similar but open at both ends, and *fjord-lakes* which are similar but closed at both ends, and separated from the sea. A farther distinction is drawn between the different kinds of inlet which superficially resemble fjords, the most contrasted in submarine configuration being the *rias* of Spain and other coasts, in which the depth of the water gradually increases from the head until it merges in the general deepening of the sea outside. The inlets of the south-west of Ireland are examples of this type, contrasting with the characteristic fjords of the

north-west of Ireland, the west of Scotland, and Norway. The greater part of the paper is occupied by an account of the distribution of the varieties of fjord-coasts in different parts of the world, and the generalisation is made that there are none of those coast-features outside the limits of lands which bear signs of recent glaciation. Herr Dinse has made a complete discussion of the principal dimensions and the exact configuration of eighty-three fjords in all parts of the world, taking his data from the largest-scale sea-charts available for each region, and these figures are printed as an appendix. The paper is illustrated by a few contoured maps of fjords, and by profiles showing their longitudinal and transverse sections.

THE Gradient-Telemeter Level, of which we give an illustration, should be of service to civil engineers and surveyors. Its novelty consists in the absence of a vertical circle, while a circle tilted out of the horizontal plane takes the place of the horizontal circle in an ordinary theodolite. So constructed, the instrument can be used to obtain linear distances, gradients, and differences in level of objects without the use of land-chain or tape. The circle is divided into natural tangents instead of degrees. When the reading is zero, the telescope is horizontal, but by rotating the circle, the telescope is inclined to the horizontal line, and the inclination is indicated by the pointer to the circle. As an example of the use of the instrument,

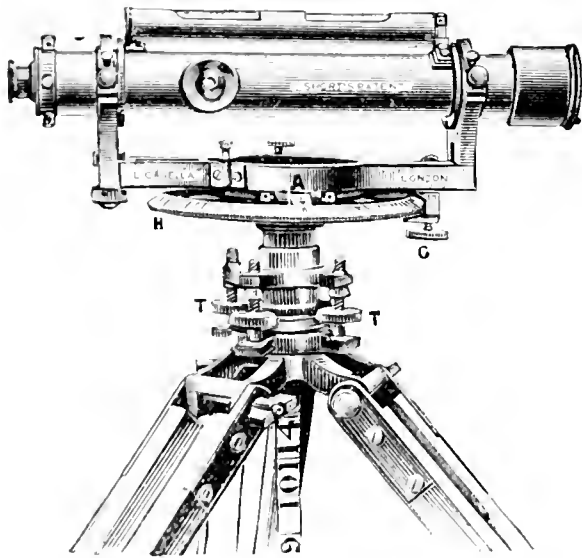

suppose the whole of the levelling staff to be below the horizontal line of sight. Setting the circle for a gradient of one in twenty-five, let the reading of the staff be 13.86. Now set the circle so that the index points to a gradient of one in twenty, and let the reading be 8.45. The difference between these two readings is 5.41, and, eliminating the decimal point, the number obtained—541—is the horizontal distance in feet between the instrument and the staff, without any further calculation. Other pairs of gradients may be used, and the difference of their staff-readings gives the linear horizontal distance. The instrument thus greatly simplifies many surveying operations.

A COLLECTION of valuable notes on the aborigines of various parts of Australia is given in the November *Journal* of the Anthropological Institute. The notes, which take the form of answers to questions on the manners, customs, religions, superstitions, &c., of the native tribes of Australia, have been collected by Dr. L. C. Stirling. The natives are divided into

innumerable tribes, and different customs prevail every two hundred miles or so. Arithmetic is beyond their comprehension. Most of the tribes appear to have distinctive names for one and two, but for three they say two and one; for four, they say two and two; and for five, two two and one. The fingers are used in counting, but numbers beyond five are very seldom used. Numbers greater than ten are usually described as "plenty" and "many," and explained by opening and closing the hands several times. The tribes have a very limited knowledge of the measurement of time. They tell the time of day by the sun, and speak of the different times of the position of the sun. They reckon by so many moons, and determine the year by the seasons; but they have no knowledge of the constellations, nor have they any names for the months, or moons, as they call them, or any recognised beginning of the year, nor artificial timekeeper of the nature of sun-dials, though the lengths of the shadows of trees is used by some tribes to determine the time of day. The heavenly bodies are not worshipped, neither are any ceremonies performed at the new moon, sunrise, sunset, the solstices, equinoxes, &c. The Milky Way is supposed to be the largest creek or river. A fresh sun is believed to shine every day, and the phases of the moon are explained by the prevailing course of the wind and prevailing quarter of the rain. Eclipses, rain, thunder, lightning, rainbows, wind, and Aurora Australis are supposed to be the work of evil spirits. Many other beliefs are described in the notes, which will be read with great interest by every student of anthropology and folk-lore.

THE mutual alterations effected between an invading igneous mass and the rock which it invades, have long been the subject of much study and speculation. An interesting case, presenting some exceptional features, has recently been described by Prof. Cole (*Trans. Roy. Dublin Soc.* vol. v. (n.s.) No. 5). On the coast of Co. Down, the Ordovician strata are cut by numerous basic dykes. In some cases, material of more acid composition has intruded at a later date, and, forcing its way along the same lines of weakness as the earlier basic material, has produced "compound" dykes. It is one such compound dyke, at Glasdrumman, consisting of basaltic andesite rifted lengthwise by later erite, that Prof. Cole describes in detail. The new-comer has re-melted the more easily fusible andesite, and the two magmas have mixed along the contact. Various stages of mixture are described, but the most interesting facts are those concerning the large crystals of quartz and felspar which abound in the marginal portions of the erite. These crystals have evidently consolidated under other, and earlier, conditions than the main mass of the rock, since portions of the erite-matrix have eaten their way into them before solidifying. But crystals undoubtedly so corroded are also found in the andesite, into which they must have floated from the erite. The presence in a rock of crystals of evident foreign origin is no new thing, but hitherto it has, in all such cases, been either shown or assumed that they were caught up by the rock in which they are found from some other into which it had intruded; whereas, here, it is the invading erite that has parted with its crystals for the benefit of its host. Thus the common dictum, that "an enclosed block must be older than the rock immediately enclosing it," is apparently controverted; yet, since consolidation is the datum from which age is measured, it becomes a decidedly nice point in geological nomenclature whether a partially re-fused rock can be allowed to pass as entirely older than the rock which has re-melted it.

SOME interesting particulars concerning "aventurine glass," one of the most curious products of the world-renowned glass-works at Murano, near Venice, are given in the current number of the *Amer. Journal of Science*, by Mr. Henry S. Washington. Its name is derived from its supposed discovery "by

chance," some brass filings having been dropped accidentally into a pot of molten glass. After the late Dr. Salvati's revival of the glass industry at Murano it was rediscovered, but the present process is a trade secret. The best glass is of a copper-brown colour, and transparent to translucent in thin flakes, showing on the edges a pale brown colour. It is filled with innumerable small flakes and spangles of a slightly brownish yellow colour and brilliant metallic lustre, consisting of crystallised copper. Under the microscope the glass shows a porphyritic structure, the ground-mass being composed of a perfectly clear and colourless glass basis. The crystallised portions consist of large phenocrysts, small phenocrysts, and microlites. The former range in diameter from 0.05 to 0.12 mm., are tubular and extremely thin, the thickness scarcely exceeding 0.002 mm., and are perfectly opaque notwithstanding their excessive tenuity. Most of them are hexagonal in outline, the hexagons being of almost ideal symmetry; but equilateral triangles, which occasionally show truncated angles, also occur. The smaller phenocrysts are much more diverse in crystalline form, and may be generally grouped in one of three divisions: cubo-octahedral forms, octahedra, and twins. They occur in portions of the glass free from the larger phenocrysts, but filled with abundant microlites, from which they are usually separated by a clear zone. The copper has evidently crystallised out from solution in the molten glass exactly like a salt from water, following Lehmann's laws of crystal growth in solutions. Mr. Washington is of the opinion that the glass is produced by melting together glass, cuprous oxide, and some reducing agent, such as siderite; and that FeO is in this case the reducing agent is shown by the greenish colour of the imperfect glass, which is not the blue green of copper, but the yellow green of ferrous glass, and perhaps due to too large a quantity of reducing agent.

At the last meeting of the French Physical Society, MM. Cailletet and Colardeau read a very interesting paper on the condensation of the gases produced by electrolysis on electrodes formed of metals of the platinum group. It is well known that when acidulated water is electrolysed by means of platinum electrodes that, on removing the battery and connecting the electrodes, a current is obtained in the opposite direction to the original current used to perform the electrolysis. This current, which only lasts for a short time, is explained by the recombination of the hydrogen and oxygen which coat the platinum electrodes. The authors, taking advantage of the well-known property of finely-divided platinum of occluding gas in large quantity, were led to use masses of finely-divided platinum contained in silk bags as electrodes, and in this way, using electrodes weighing six grms. each, a current was obtained, after disconnecting the battery, which continued for some time, and was of sufficient strength to ring an electric bell. By enclosing this form of the cell in a receiver, and compressing the air within the receiver, the following results were obtained:—With an additional pressure of one atmosphere, the E.M.F. immediately after charging was 1.8 volts, which fell regularly to zero when the cell was discharged. On increasing the pressure the character of the discharge-curve obtained entirely alters, and consists of three parts. (1) A portion in which the intensity of the discharge current rapidly diminishes. (2) A portion during which the current remains constant. This period occupies the major part of the time occupied in the discharge, and the E.M.F. at this time is about one volt. (3) A second period in which the current diminishes and finally becomes zero. The capacity of such an accumulator, the weight of the two electrodes being 1 kilogram, is, under a pressure of 580 atmospheres, 56 ampere-hours, while a current of 100 amperes can be obtained. To obtain the best possible result, the negative

electrode should contain three times the weight of platinum in the positive electrode. With finely-divided palladium a storage capacity of 176 ampere-hours per kilogram of palladium was obtained at a pressure of 600 atmospheres. It is interesting to note that the storage capacity of an ordinary lead accumulator is about 15 ampere-hours per kilo of metal.

LEON GUIGNARD, in the *Journal de Botanique*, adds another important contribution to our knowledge of the centrospheres of plant-nuclei, entitled "Sur l'origine des sphères directrices." It will be remembered that this author was the first to demonstrate the existence of these structures in vegetable cells (*Comptes-rendus*, 1891), and also, in a later paper, to describe their behaviour during the origin of the sexual cells and the part they take in the phenomena of fertilisation (*Ann. des Sc. Nat.* 1891). In these earlier works Guignard already figured many resting nuclei with the centrospheres lying outside the nuclear membrane, and usually in close proximity to it, while within the nuclear membrane are to be seen one or more nucleoli. Strasburger also observed and figured centrospheres outside resting nuclei in *Sphaelaria sesparia* (*Hist. Beltrige*, iv. p. 52). Recently, however, G. Karsten was led to believe, from a study of the relations of the nucleoli and centrosomes in the mother cells of the spores of *Pislotium triquetrum* that the centrosomes (or minute bodies included in the centrospheres) owe their origin to the nucleoli, and after karyokinesis are re-included as nucleoli in the daughter nuclei. Guignard's last paper is chiefly concerned with an examination of this point, and he comes to the conclusion that prior to karyokinesis the centrospheres in the cells of the sporangia of *P. triquetrum* are external to the nuclear membrane, and that after karyokinesis, while some of the small nucleoli which have not disappeared during the division of the nucleus are re-included within the nuclear membranes of the daughter nuclei, they remain external to them.

A RECENT number of the *Minnesota Botanical Studies* contains a bibliography on the subject of the fixation of free nitrogen by plants, embracing over 600 titles.

THE report of the fifth meeting of the Australasian Association for the Advancement of Science, held at Adelaide, in September 1893, has just reached us from Sydney, where the permanent office of the Association is situated.

MESSRS. RIVINGTON, PERCIVAL, AND CO. have published a third edition of "Practical Inorganic Chemistry," by Mr E. J. Cox. The book is intended for students preparing for the elementary practical chemistry examination of the Department of Science and Art.

IN the form of "Bulletin No. 56," Mr. P. H. Mell, the State Botanist for Alabama, records the result of a series of observations on the crossing of different varieties of the cotton-plant at the Agricultural Experiment Station at Auburn. The plant is pollinated by the agency of the wind and of insects, and he finds inter-crossing to have a material effect in increasing the strength of the fibre.

MISS ORMEROD will issue in a few days an abstract of information on the history and habits of that seriously destructive cattle-pest, the Warble Fly or Ox Bot Fly. The description will be very fully illustrated, and will be an epitome of the knowledge and experience gained up to the present time, and especially during the years 1884 to 1894. It will deal practically with means of prevention and remedy. The publishers are Messrs. Simpkin, Marshall, Hamilton, Kent, and Co.

AN "Artificial Spectrum Top," devised by Mr. C. E. Benham, and sold by Messrs. Newton and Co., furnishes an interesting phenomenon to students of physiological optics. The top consists of a disc, one half of which is black, while the

other half has twelve arcs of concentric circles drawn upon it. Each arc subtends an angle of forty-five degrees. In the first quadrant there are three such concentric arcs, in the next three more, and so on; the only difference being that the arcs are parts of circles of which the radii increase in arithmetical progression. Each quadrant thus contains a group of arcs differing in length from those of the other quadrants. The curious point is that when this disc is revolved, the impression of concentric circles of different colours is produced upon the retina. If the direction of rotation is reversed, the order of these tints is also reversed. The cause of these appearances does not appear to have been exactly worked out.

THE additions to the Zoological Society's Gardens during the past week include a Black Lemur (*Lemur macaco*, ♂) from Madagascar, presented by Mr. Roche; a Snowy Owl (*Nyctea scandiaca*), captured in mid-Atlantic, 700 miles from land, presented by Mr. Harston Eagle; two Levaillant's Cynictis (*Cynictis levaillantii*), two Domestic Sheep (*Ovis aries*, var.), two Puffin Adlers (*Puffina arctica*), a Cape Bucephalus (*Bucephalus capensis*), six Hissid Lizards (*Agama hispida*), five Rough-scaled Lizards (*Amphiscolopius*), a Delalande's Lizard (*Nuro adelaidae*), a Crossed Snake (*Psemmophis crucifer*) from South Africa, two Bennett's Tree Kangaroos (*Dendrolagus lemmingii*) from North Queensland; an Allied Goshawk (*Accipiter affinis*), three Long-necked Chelodines (*Chelodina longicollis*), twenty-two Golden Tree Frogs (*Hyla aurea*), seventeen White's Tree Frogs (*Hyla cornuta*) from Australia, a Spi's Macaw (*Aratinga*) from North Brazil, deposited; two Car-line Coueas (*Coueas carolinensis*) from North America, purchased; two Queen-land Tree Kangaroos (*Dendrolagus quinquecoloratus*) from Queensland; four Brush Turkeys (*Argus australis*, 4 ♂) from Australia, received in exchange.

OUR ASTRONOMICAL COLUMN.

THE PARALLAX OF NEBULA  $\delta$  2241.—At the time when Dr. Wilsing took photographs of the nebula B.D. + 41° 4004 for the determination of parallax, he obtained also a series of negatives of B.D. - 41° 4773 ( $\delta$  2241) for the same purpose. This nebula is almost ring-shaped, and displays a central condensation. The latter appears more distinct on the photographic plates than can be seen by eye observations, and its contour is only sufficiently sharp for micrometric measurements on the best plate, so that the centre of the whole apparent disc has been generally used. From June 1892 to August of the following year, 33 plates were obtained, 31 of which have been used in this research. Six comparison stars, the positions of which were taken from the Bonn zones, have been adopted. In the account of the result obtained (*Astr. Nach.* No. 3261), Dr. Wilsing gives a table showing the deduced distances of the nebula from the two comparison stars 3 and 6. A second table contains the mean monthly values of these distances with their differences from the whole mean value obtained from all the measurements, together with the most probable errors of the measurements.

The following table shows these differences between the total and monthly means for the two stars 3 and 6:

	Star 3	Star 6	Prob. error.	N. of plates.
1892 June 21	0.03	0.28	±0.08	5
July 13	0.11	0.03	0.06	9
Aug. 9	0.07	0.04	0.13	2
Sept. 25	0.01	0.09	0.05	5
Oct. 4	0.13	0.01	0.13	2
Nov. 5	0.29	0.03	0.10	3
Dec. 22	0.53	0.11	0.18	1
1893 Feb. 4	0.13	0.31	0.18	1
July	0.08	0.19	0.13	2
Aug.	0.53	0.11	0.18	1

These differences, when considered in relation with the probable errors of the measurements, have as Dr. Wilsing

suggests, to be cautiously dealt with, and he is led to conclude from this series of measures that the relative parallax of this nebula does not exceed one or two tenths of a second of arc.

A POSSIBLE NEW ZONE OF ASTEROIDS.—The secular variations of the orbits of the four inner planets has lately occupied Prof. Newcomb's attention, with the result that several elements have been found to vary in a manner unaccounted for by existing theory. (*Astronomical Journal*, No. 327.) "These anomalies," says Prof. Newcomb, "cannot be simultaneously explained either by an intra-mercurial zone of planets, by the action of matter reflecting the zodiacal light, or by a deviation of gravitation from the usually accepted law. The uncertainty as to the mass of Mercury makes the construction even of a working hypothesis difficult; but apart from all considerations of probabilities, *a priori*, the hypothesis which best represents observations, is that of a ring of planetoids of small eccentricity a little outside the orbit of Mercury, and a little more inclined to the ecliptic. The total mass of the ring may range from one-fiftieth to, perhaps, one three-hundredth of the mass of Venus, according to its distance from Mercury." Prof. Newcomb intends to carefully investigate the matter in order "to decide whether the results of the hypothesis are such as to counterbalance its extreme improbability."

A NEW COMET.—*Edinburgh Circular*, No. 43, dated November 23, states that a telegram received from the Central Astronomical Station at Kiel announces the discovery of a very faint comet, by Mr. Edward Swift, at 8 p.m., Californian time, on the 20th inst. It was situated in Right Ascension, 22h. 18m. 24s., and South Declination, 13° 7', and was moving slowly towards the east.

A NEW SERIES OF NITROGEN COMPOUNDS.

ANOTHER new series of nitrogen compounds, containing four atoms of that element along with one atom of carbon in a closed chain, are described by Prof. v. Pechmann and Herr Runge in the current *Berichte*. They are termed "tetrazolium" compounds, and the parent base of the series is tetrazolium hydroxide, whose constitution is represented by the

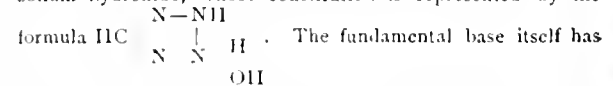

not yet been isolated; the compounds prepared comprise the derivative in which the two hydrogen atoms directly attached to the two end nitrogen atoms are replaced by phenyl, together with a large number of salts of this base, formed by replacement of the hydroxyl by halogens or other acid radicles just as in the case of metallic hydroxides. The hydrogen atom attached to the carbon is likewise capable of replacement by many organic radicles, so that a large number of still more complicated bases have likewise been prepared, together with their corresponding salts. The hydroxides of this new series are characterised by possessing strong basic properties. They may all be prepared most conveniently from their chlorides, by the action upon them of silver oxide. They are extremely soluble in water, but are completely precipitated from their solutions by ether. The aqueous solutions absorb carbon dioxide and behave very much like caustic alkalis. They cannot, however, be crystallised, forming resins upon concentration. The salts, on the other hand, crystallise admirably; they are usually soluble in water, react neutral to litmus, and possess a very bitter taste. Diphenyl

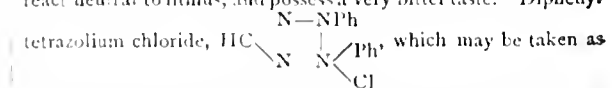

a typical salt of the series, crystallises in colourless radiating groups of needles very sensitive to light, which renders them yellow. The aqueous solution yields a flesh-coloured precipitate of a chloroplatinate with platinum chloride, and the double salt may be crystallised from hot water. A crystalline double chloride is likewise produced with gold chloride. The addition of a soluble nitrate or iodide causes the precipitation of the difficultly soluble nitrate or iodide of the base. A solution of iodine in potassium iodide precipitates an iodine addition product, which can be crystallised from alcohol in beautiful brown tabular crystals exhibiting a violet reflection. The parent base is produced in solution upon the addition of silver oxide, silver



chloride being likewise formed. The chloride is reduced by ammonium sulphide to a compound of the constitution:

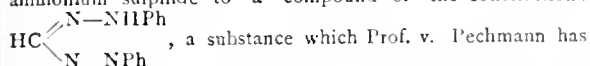

previously described, and which is interesting as forming the starting-point for the preparation of the new series. For the chloride may at once be prepared from this latter substance by oxidation with amyl nitrite and hydrochloric acid. The substance is readily prepared by the action of diazobenzene chloride upon malonic acid, constituting the insoluble product of the reaction. It is of considerable interest to observe that the main product of the dry distillation of diphenyl tetrazolium chloride is azobenzene.

### THE SCIENTIFIC INVESTIGATIONS OF THE SCOTTISH FISHERY BOARD.

THE Twelfth Annual Report of the Fishery Board for Scotland (Part III. Scientific Investigations for 1893) contains a quantity of new information upon fishery problems, and marks an important stage in the history of the Board, owing to the successful inauguration during the past year of a hatchery at Dunbar for the artificial propagation of marine food-fishes.

A number of important conclusions are formulated by the Board upon various matters. In the first place, the closure of the territorial waters to beam-trawling is admitted to have had no appreciable effect towards arresting the continued decline in the supply of flat-fishes, although the interdicted area has been very large. The greater part of the territorial waters of the East Coast, the Firth of Forth, and St. Andrews Bay have been protected (except for experimental purposes) since 1885, and this area was greatly extended in 1889, when practically the whole of the territorial waters and several extensive bays (the Firth of Clyde and the Moray Firth) were closed against the operations of the beam-trawler. The reason for the failure of this method of protection is sought for in the fact that the present protected area does not embrace the spawning grounds of food-fishes, except in the case of the Moray Firth. It is most unfortunate that, from lack of a sufficiently seaworthy vessel, the Board has been unable to devote the same attention to the Moray Firth as to the Firth of Forth and St. Andrews Bay, for statistics upon the condition of the Moray Firth throughout the year would have been invaluable. But it can be definitely asserted that the mere protection of areas that do not include spawning grounds is practically useless to prevent depletion of the home fisheries. The recommendation of the recent Parliamentary Committee that the present territorial limit should be considerably extended, is accordingly endorsed; and, in order to ensure the enclosure of the more important breeding-grounds, the Board emphasises its recommendation of the previous year, that the limit of jurisdiction should be extended to ten or twelve miles from shore.

Experiments have been made upon the effects of alteration in the size of the mesh of the beam-trawl upon the capture of immature fish. It was found that, contrary to the opinion of most practical men at the recent Parliamentary inquiry, the size of the mesh has a most appreciable influence in determining the size of the fish captured. Dr. Fulton's effective experimental trawlings show that the proportion of fishes that escape through the cod-end of the trawl increases greatly as the width of the meshes is enlarged.

Prof. McIntosh gives an interesting review of the trawling question in general, and includes a valuable sketch of the changes which have taken place during the past ten years in trawling-vessels and their apparatus. Reasons are adduced which tend to show that line-fishing is quite as destructive as trawling to immature round fishes, such as cod and haddock; and it is maintained that the perennial abundance of the floating fauna, of which larval stages of bottom-animals form so large a proportion, is sufficient to prevent the trawling-grounds from being depleted of fish-food to any serious extent.

The volume includes a number of papers of a more purely biological character upon the development of fishes, on the invertebrate fauna of the Firth of Forth and certain inland lochs, on the oviposition and rate of growth of the sand-eel and certain other fishes, and on some seasonal changes in the histology of

fishes. Two papers on the osteology of the tunny and on the anatomy of the pectoral arch in the gurnard seem to us to be completely out of place in an official publication ostensibly devoted to fishery investigations, with which they have nothing to do.

Turning to Prof. McIntosh's "Remarks on Trawling," justifiable as his general position appears to be, he has, nevertheless, left himself open to criticism on a number of minor points. It is difficult to reconcile with the statistics of the *Garland* trawlings the Professor's remark that "the closure of the inshore waters—e.g. St. Andrews Bay—must have conduced to the prosperity of the turbot and the brill of that neighbourhood, most of the turbot (ranging from 9 to 11 inches) which formerly were captured by the trawler: now being unmolested" (p. 167). For in Dr. Fulton's introductory report on the work of the *Garland* it is stated that in St. Andrews Bay, as in the Firth of Forth, there was an actual decrease in 1893 of "turbot and brill" in the closed areas as compared with 1892 (p. 26): and the decrease of flat-fishes in general during the eight years of closure is demonstrated on p. 33. Moreover, out of the twenty-four experimental trawlings conducted by the *Garland* in the closed waters of St. Andrews Bay in 1893 only two turbot, and no brill at all, were obtained. Indeed, the average take of turbot was twice as great in the unprotected as in the protected areas of the Bay (p. 42).

In one of the most interesting sections of his "Remarks" (p. 184), Prof. McIntosh discusses the "effect of trawling on the invertebrate fauna of the sea-bottom (forming fish-food)." It is full of valuable observations from the rich stores of the Professor's experience, but, as an argument, seems to us to be vitiated by a very questionable assumption which underlies it, viz. that all invertebrate life on the sea-bottom furnishes food for fishes. Half the groups, at least, which are mentioned by the Professor in this connection should, in our opinion, be eliminated, viz. sponges, hydroids, anemones, alcyonaria, star-fishes, balani, and ascidians, although we are quite prepared to allow that now and then, in exceptional cases, particular species of some of these groups may be swallowed by fishes. Therefore the Professor's argument that the trawl causes little impoverishment of the supply of fish-food, owing to the rapid powers of growth and repair which the above groups (among some others) possess, is seriously impaired.

In Mr. Harald Dannevig's Report (p. 211) we notice the interesting observation that fishes which spawn during the night in open ponds will do so during the day also if the pond be darkened.

Coming to the biological investigations, we observe that Prof. McIntosh has overlooked (p. 227) the fact that the Norwegian Topknot (*Zeugopterus norvegicus*) has been recorded by Mr. Cunningham as occurring in considerable numbers at Plymouth (*Jour. M.B.A.* ii. 1892, p. 325). In connection with Mr. Sandeman's investigations on seasonal changes in the histology of fishes, attention may be drawn to another paper by Mr. Cunningham (*Jour. M.B.A.* ii. 1891, pp. 16-42), in which a number of remarkable histological changes are shown to take place in the female conger during the period of the maturation of her eggs.

The main results of Mr. Dickson's physical investigations in the Faroe-Shetland seas seem to us to be of profound importance. If, as he contends, a mass of Atlantic water is every year admitted through the Faroe-Shetland Channel, winds round the Shetlands, and bores its way down the eastern coasts of Scotland in the summer months, guided by a bank of dense water in the upper regions of the North Sea, it is clear that we have at once an explanation of numbers of isolated facts of occasional or periodic distribution of pelagic animals in those regions, which have hitherto seemed merely freaks of Neptune or Eolus. And it cannot be doubted that a further extension of such investigations as Mr. Dickson has been carrying out in H.M.S. *Tarba*, if coupled with a corresponding survey of the pelagic fauna, will provide the long-sought solution of the migrations of the herring and other nomad fishes round our coasts.

In congratulating the Board upon its scientific achievements for the year, we cannot help expressing our intense regret that the recently vacant chairmanship was not offered by the Government to Dr. John Murray. His experience and energy would at all times be invaluable, but at the present juncture, when so many important fishery problems of a physico-biological nature are pressing for solution, the loss to the Board and to the country of his counsel and aid is incalculable. W. G.

SIR JOHN DONNELLY ON TECHNICAL EDUCATION.

At the first ordinary meeting of the new session of the Society of Arts, Major-General Sir John Donnelly delivered an address in which he dealt with some points in the history of the Society, and especially with those connected with the promotion of education. The following is a condensed report of his remarks bearing upon the development of technical instruction:—

In 1808, a Conference on Technical Education was held by the Society of Arts, and shortly afterwards—on March 24, 1808—on the motion of Mr., now Sir B. Samuelson, Bart., the House of Commons granted a Select Committee, of which he was appointed chairman, "to inquire into the provisions for giving instruction in theoretical and applied science to the industrial classes." The first three of their conclusions were—(1) That, with the view to enable the working classes to benefit by scientific instruction, it is of the utmost importance that efficient elementary instruction should be within the reach of every child; (2) that unless regular attendance of the children for a sufficient period can be obtained, little can be done in the way of their scientific instruction; (3) that elementary instruction in drawing, in physical geography, and in the phenomena of nature should be given in elementary schools. Throughout these discussions the object-lesson afforded by the Paris Exhibition of 1807 was universally acknowledged to be the main feature of the movement.

Sir John Donnelly brought before the Society in 1872 a scheme for examinations in technology, which were to be supplementary to the examinations of the Science and Art Department. The scheme did not meet with much enthusiasm, and manufacturers set themselves against it on the grounds that trade secrets should not be the talk of the class-room. However, since then the examinations have been very largely developed by the City and Guilds of London Institute.

Owing to a set of circumstances, with which everyone is now thoroughly conversant, there was, shortly after the passing of the Technical Instruction Act, in 1889, a great windfall for technical education. Under the Customs and Excise Act of 1890, the residue, amounting to something over three-quarters of a million of money in England and Wales, became applicable to technical education. It has been so applied very largely. From a recent return it appears that, of the forty-nine County Councils, excluding Wales and Monmouth, forty-one are applying the whole, and eight a part of the residue to technical education. Of the sixty-one County Boroughs, fifty-three are applying the whole, and seven a part of the residue to technical education; while in one case only (the County Borough of Preston) the residue is being applied wholly to relief of rates. Farther than this, ten County Boroughs are, in addition, levying a rate under the Technical Instruction Acts.

For the year 1893-94, the forty-nine County Councils have allocated about £465,000, and the County Boroughs about £191,000 from the Customs and Excise grant, besides raising over £12,700 by rates. This makes a total of almost exactly £669,700, raised in England alone for technical instruction for the year, independent of the grants from the Science and Art Department.

It is purely at the option of local authorities whether they apply the "beer" money to technical education, or whether they use it in relief of the rates. It is very gratifying to see the extent to which they have devoted it to the former object, and it shows that the operations of the Science and Art Department, the Society of Arts, the City and Guilds of London, and other bodies which had previously been engaged in the movement, have not been unfruitful. But unquestionably a great danger lurks around a sudden outburst of zeal of this kind. How far have the public generally been convinced of the efficacy of science and art and technical instruction, and the advantage of sending all the money on it, rather than in relief of rates? or how far have they been only momentarily carried away unwilling captives at the chariot-wheel of the enthusiasts? How will the pendulum of public opinion which has been so violently and so severely forced in one direction swing back again? Or—a still greater danger—how soon will the critics, the "young," and the "practical" man commence their innings by a bid to have the account balanced and the profit shown? There are already murmurings in the air: did not our forefathers get on very well without technical education? or how is

it that we stand—or, at least, stood—at the head of manufacturing and commercial fame and engineering ability? At all events, if you cannot show any fruit let us have an inquiry; dig up the plant and have a look at its roots to see that we have planted the right sort.

Now what is this "technical instruction" with which the country is so much occupied at the present time? It is defined in the Act of 1889 as instruction in the principles of science and art applicable to industries, and in the application of special branches of science and art to specific industries or employments, as well as in modern languages and commercial and agricultural subjects, but not in teaching the practice of any trade, or industry, or employment.

The Act, in fact, provides for instruction in technology and not in technics. Besides, though the definition clause is careful to indicate that the principles of science and art are to be cultivated, the title of the Act appeals to the sympathy of the great mass who always clamour for a short cut—some way for arriving at the money-making application of science and art without that preliminary study which is so laborious and apparently unremunerative.

After dwelling upon changes of style in artistic work and design, Sir John Donnelly went on to say that every now and then we hear a great outcry against South Kensington and its "system." And if South Kensington now, why not in a few years hence the technical schools and courses of instruction which are being set up with so much care and thought in all parts of the country? This danger is already felt by many who are interested in technical instruction. The Science and Art Department could always point to the fact that, if its science teaching was wrong, it erred in good company, for the syllabuses were prepared, and the examinations were conducted by some of the most eminent men of science of the day.

But to whom can the local authorities under the Technical Instruction Act appeal? It seemed to him that for their own satisfaction, and for the future stability of technical instruction, they will desire, instead of remaining, as it were, isolated and self-contained, to have an influential examining and inspecting board, to which they might refer, if they found it desirable, for assistance and advice. There are at present several bodies partially covering the ground—but only partially, and there is the great disadvantage of a want of unity. He threw out the suggestion that the Society of Arts, which is at present covering part of the field, should take the initiative in bringing all these bodies together, so that they may form some kind of joint board, or at least co-operate.

THE BATTLE OF THE FORESTS.<sup>1</sup>

I

THE earth is a potential forest. Given time, freedom from geologic revolutions and from interference by man, the tree growth must finally dominate everywhere, with few excepted localities.

Its perennial nature and its elevation in height above all other forms of vegetation, together with its remarkable recuperative powers, assure to the arborescent flora this final victory over its competitors.

So impressed was Dr. Asa Gray with the persistence of individual tree life that he questioned whether a tree need ever die: "For the tree (unlike the animal) is gradually developed by the successive addition of new parts. It annually renews not only its buds and leaves, but its wood and its roots; everything, indeed, that is concerned in its life and growth." Thus, like the fabled Jason, being restored from the decrepitude of age to the bloom of early youth, the most recent branchlets being placed by means of the latest layer of wood in favourable communication with the newly-formed roots, and these extending at a corresponding rate into fresh soil, why has not the tree all the conditions of existence in the thousandth that is possessed of in the hundredth or the tenth year of its age?

The old and central part of the trunk may, indeed, decay, but this is of little moment, so long as new layers are regularly formed at the circumference. The tree survives, and it is difficult to show that it is liable to death from old age in any proper sense of the term."

<sup>1</sup> A lecture delivered by Prof. B. E. Fernow, Chief of the Forestry Department of Agriculture, U.S.A., during the Brooklyn meeting of the American Association for the Advancement of Science.

However this may be, we know trees succumb to external causes. Nevertheless, they are perennial enough to outlive aught else, "to be the oldest inhabitants of the globe, to be more ancient than any human monument, and exhibit in some of the survivors a living antiquity compared with which the mouldering relics of the earliest Egyptian civilisation, the pyramids themselves, are but structures of yesterday." The dragon trees, so called, found on the island of Tenerife, off the African coast, are believed to be many thousand years old. The largest is only 15 feet in diameter and 75 feet high. Our sequoias are more rapid growers, and attain in 3000 to 4000 years, which may be the highest age of living ones, more than double these dimensions.

While this persistence of life is one of the attributes which in the battle for life must count of immeasurable advantage, the other characteristic of arboreal development, its elevation in height above everything living, is no less an advantage over all competitors for light, the source of all life. Can there be any doubt that in this competition size must ultimately triumph, and the undersized go to the wall?

Endowed with these weapons of defensive and offensive warfare, forest growth, through all geologic ages during which the earth supported life, has endeavoured, and no doubt to a degree succeeded, in gaining possession of the earth's surface.

As *terra firma* increased emerging in islands above the ocean, so increased the area of forest, changing in composition to correspond with the change of physical and climatic conditions.

As early as the Devonian age, when but a small part of our continent was formed, the mud flats and sand reefs, ever increasing by new accumulations under the action of the waves and currents of the ocean, were changed from a bare and lifeless world above tide level to one of forest-clad hills and dales.

Not only were such quaint forms as the tree rushes *Calamites*, *Lepidodendron* and *Sigillaria* present, but the prototype of our pine, the *Dadoxylon*, had made its appearance.

The same class of flowerless plants known as vascular cryptogams, with the colossal tree ferns added, became more numerous and luxuriant in the Carboniferous age, as well as the flowering *Sigillaria* and coniferous *Dadoxylon*. This vegetation probably spread over all the dry land, but the thick deposits of vegetable remains accumulating in the marshy places under dense jungle growth and in shallow lakes with floating islands, were finally, in the course of geologic revolutions, turned into the great coal fields.

In those and subsequent geologic times some of the floral types vanished altogether and new ones originated, so that at the end of Mesozoic times a considerable change in the landscape had taken place.

In addition to coniferous trees, the palms appeared, and also the first of angiosperms, such as the oak, dogwood, beech, poplar, willow, sassafras, and tulip tree. Species increased in numbers, adapted to all sorts of conditions; the forest in a most varied and luxuriant form climbed the mountain-sides to the very crests, and covered the land to the very poles with a flora of tropical and semi-tropical species.

Then came the levelling process and other changes of post-Tertiary or Quaternary times; the glaciation of lands in northern latitudes, with the consequent changes of climate, which brought about corresponding changes in the ranks of the forest, killing out many of the species around the north pole. Only the hardier races survived, and these were driven southward in a veritable rout.

When these boreal times subsided in a degree, the advance of the forest was as sure as before, but the battle order was somewhat changed to suit the new conditions of soil and climate. Only the hardiest tribes could regain the northernmost posts, and these found their former places of occupancy changed by fluvial and lacustrine formations and the drifts borne and deposited by the ice-sheets, while some by their constitution were entirely unfitted for engaging in a northern campaign, or found insurmountable barriers in the refrigerated east-west elevations of Europe and Western Asia.

In addition, there had come new troubles from volcanic eruptions, which continually wrested the reconquered ground from the persistent advance guards of the arboreal army, annihilating them again and again.

Finally, when the more settled geologic and climatic conditions of the present era arrived, and the sun rose over a world ready for human habitation, man found what we are

pleased to call the virgin forest—a product of long-continued evolutionary changes—occupying most, if not all the dry land, and ever intent upon extending its realm.

This prehistoric view of the battle of the forest cannot be left without giving some historic evidences of its truth.

Not only have palæobotanists unearthed the remnants of the circumpolar flora, which give evidence that it resembled that of present tropic and semi-tropic composition, but they have also shown that sequoias, magnolias, liquidambars and hickories existed in Europe and on our own continent in regions where they are now extinct. We have also evidences of the repeated successes and reverses of the forest in its attempts to establish itself through long geologic transformations.

One of the most interesting evidences of these vicissitudes in the battle of the forest is represented in a section of Amethyst Mountain in Yellowstone National Park, exhibiting the remains of fifteen forest growths, one above the other, buried in the lava. Again and again the forest subdued the inhospitable excoriations; again and again it had to yield to superior force.

Among these petrified witnesses of former forest glory, magnolia, oak, tulip tree, sassafras, linden and ash have been identified, accompanying the sequoia in regions where now only the hardiest conifer growths of pines and spruces find a congenial climate.

As the forest formed and spread thus during the course of ages, so does it form and spread to-day, unless man, driven by the increasing needs of existence, checks its progress and reduces its area by the cultivation of the soil. This natural extension of the forest cover or afforestation takes place readily whenever soil and climate is favourable, but it is accomplished just as surely, though infinitely slower, in unfavourable situations. On the naked rock, the coarse detritus and gravel beds, on the purely siliceous sand deposits of river and ocean, or in the hot dry plains, the preliminary pioneer work of the lower vegetation is required. Algae, lichens, mosses, grasses, herbs, and shrubs must precede to cultivate the naked rock, to mellow the rough moisture by shading the ground, and gradually render it fit for the abode of the forest monarch. The army of soil-makers and soil-breakers, the pioneers, as it were, of the forest, are a hardy race, making less demands for their support than those that follow. They come from different tribes, according to the soil conditions in which they have to battle.

The aspen (*Populus tremuloides*) is one of these forerunners, which is readily wafted by the winds over hundreds of miles, readily germinates and rapidly grows under exposure to full sunlight, and even now in the Rocky Mountains and elsewhere quickly takes possession of the areas which man has ruthlessly destroyed by fire. This humble and ubiquitous, but otherwise almost useless, tree is nature's restorative, covering the sores and scalds of the burnt mountain side, the balm poured upon grievous wounds. Though short-lived, with its light summer foliage turning into brilliant golden autumn hues, it gives grateful shade and preserves from the thirsty sun and wind some moisture, so that the better kinds may thrive and take its place when it has fulfilled its mission.

One of the shrubs or half-trees which first take possession of the soil in the western mountain country is the so-called mountain mahogany (*Cercocarpus ledifolius*), covering the bare slopes after the fire has killed the old timber.

In other regions, as on the prairies of Iowa and Illinois, hazel bushes, or in the mountains of Pennsylvania and the Alleghanies in general, ericaceous shrubs like the laurel and rhododendrons or hawthorn, viburnum and wild cherry are the first comers, while along water-courses alders and willows crowd even the water into narrower channels, catching the soil which is washed from the hill-sides and increasing the land area.

One of the most interesting soil-makers, wresting new territory from the ocean itself, is the mangrove along the coast of Florida. Not only does it reach out with its aerial roots, entangling in their meshes whatever litter may float about, and thus gradually building up the shore, but it pitches even its young brood into the advance of the battle, to wrestle with the waves, and gain a foothold as best it may.

Not less interesting in this respect is that denizen of the southern swamp, the bald cypress, with its curious root excrescences known as cypress knees, which, whatever their physiologic significance, are most helpful in expediting changes of water into land sufficiently dry to be capable of supporting the more fastidious species in regard to moisture and conditions.

On the dry hot mesas, and in the arroyos of the south-western

tier of our States and Territories, we meet a different set of skirmishers following up the huge cacti and agaves, which together with the tree yuccas, penetrate into the very desert. In these regions the mesquite or algaroba and others of the acacia tribe form the second phalanx, as it were, gradually advancing their lines in spite of adverse conditions. In other regions the pine, satisfied with but scanty favour of soil moisture, and the spruce, able to sustain life in shallow soil, and the fir, in the higher, colder, and wetter elevations, sometimes much stunted, form the skirmish line. These improve the soil in its moisture contents by their shade, and by the foliage and litter falling and decaying they deepen the soil, forming a humus cover. The dust that is found covering the rocky subsoil of the Adirondacks is formed in this way at the rate of about one foot in 500 years. They are soon followed by the birch, maple, elm, and ash, and in moister situations by the oak—first, that hardy pioneer, the black oak tribe, and then the more fastidious white oak, with whom the slower but persistent hickories, beeches, and other shade-enduring species begin to quarrel for the right of occupancy of the ground, until the battle is no longer that of the forest against the elements and lower vegetation, but between the mighty conquerors themselves. This struggle we can see going on in our primeval forests, wind, storms, and decay acting as allies now to one, now to the other side, and thus changing the balance of power again and again.

In this struggle for supremacy between the different arborescent species the competition is less for the soil than for the light, especially for tree growth. It is under the influence of light that foliage develops, and that leaves exercise their functions and feed the tree by assimilating the carbon of the air and transpiring the water from the soil. The more foliage and the more light a tree has at its disposal, the more vigorously it will grow and spread itself.

Now the spreading oak or beech of the open field finds close neighbours in the forest, and is narrowed in from all sides and forced to lengthen its shaft, to elevate its crown, to reach up for light, if it would escape being over-shadowed, repressed, and perhaps finally killed by more powerful densely-foliaged competitors.

The various species are differently endowed as regards the amount of light which they need for their existence. Go into the dense forest and see what kinds of trees are vegetating in the dense shade of the older trees, and then go into the opening recently made, an abandoned field or other place, where the full benefit of light is to be had by all alike, and one will find a different set altogether occupying the ground and dominating. In the first case there may be found, perhaps, beech and sugar maple or fir and spruce; in the second case aspen, poplar, willow, soft maple, oak or pine, tamarack, &c.

All trees thrive ultimately best in full enjoyment of light. But some, like those first mentioned, can at least subsist and their foliage functionate with a small amount—they are shade-enduring kinds, usually having a dense foliage, many leaves, and each one needs to do but little work—and exert considerable work when fully developed. Those last named, however, are light-needing kinds, and having less foliage, cannot exist long without a considerable amount of light.

To meet this drawback in the constitution of these latter, nature has endowed them as a rule with the capacity of rapid height growth, to escape their would-be suppressors; but again, what they have gained in the rapidity of development they lose in the length of life. They are mostly short-lived species, while the shade-enduring are generally slower growers, but persistent and long-lived. Some kinds, like most of the oaks, stand between the two; while exhibiting a remarkable capacity of vegetation in the shade, they are really light-needing species, but comparatively slow growers and long-lived. One of the same species behaves also somewhat differently under different soil and climatic conditions; for instance, as a rule, the light-needing species can endure more shade on moist soils, and the shade-enduring require more light on drier soils.

In the earliest stages of life the little seedlings of most trees require partial shade, and are quite sensitive in regard to light and its conditions. Some have such a small range of light and shade endurance that, while there may be millions of little seedlings sprouted, they will all perish if some of the mother trees are not removed and more light given; and they will perish equally if the light growth is removed too suddenly, and the delicate leaf structure, under the influence of direct sunlight, is unable to increase its functions beyond its capacity.

Left to itself the forest grows up, and as the individual trees develop, each trying to hold its ground and struggling for light, a natural thinning takes place, some trees lagging behind in growth and being shaded out, until in old age only as many trees remain as can occupy the ground without incommoding each other.

This struggle among the individuals goes on during their entire life. Some few shoot ahead, perhaps, because of a stronger constitution or some favourable external cause, and over-tower their neighbours. These, lagging behind, fall more and more under the shading influence of their stronger neighbours until entirely suppressed, when they only vegetate until they die. The struggle continues, however, among the dominant class, and it never ends.

Thus the alterations of forest growth take place, oak following pine, or pine following oak; the poplar, birch and cherry appearing on the sunny burns, or the hickory, beech, and maple creeping into the shadier pine growths. While in the eastern forests under natural conditions the rotation of power is accomplished in at least from 300 to 500 years, the old monarchs of the Pacific, towering above all competitors, have held sway 2000 or more years. In this warfare, with changes in climatic and soil conditions going on at the same time, it may well occur that a whole race may even be exterminated.

The study of the formative period of the forest is necessary in order to show clearly that the virgin forest is a product of long struggles, extending over centuries, nay, thousands of years. Some of the mightiest representatives of the old families, which at one time of prehistoric date were powerful, still survive, but are gradually succumbing to their fate in our era.

The largest of our eastern forest trees, reaching a height of 140 feet and diameters up to twelve feet, the most beautiful and one of the most useful, the tulip tree (*Liriodendron tulipifera*), is a survivor of an early era, once widely distributed, but now confined to eastern North America, and doomed to vanish soon from our woods through man's improper partisanship.

Others, like the Torreya and Cypress, seem to have succumbed to a natural decadence, if we may judge from their confined limits of distribution. So, too, the colossal sequoias, remnants of an age when things generally were of larger size than now, appear to be near the end of their reign, while the mighty taxodium or bald cypress, the big tree of the East, still seems vigorous and prosperous, being able to live with wet feet without harm to its constitution, weird with the grey tillandsia or Spanish moss.

Having thus scanned through the traditions of unwritten history of the battle of the forest, having seen some of the combatants in the struggle, and learned something of their methods of conquering the earth and each other, we may take a look at the condition of things on the North American continent as it presumably was in the beginning of historic times or within our century.

As far as occupancy of the soil by the forest is concerned, we find that the struggle had not yet been determined in its favour everywhere. While a vast territory on the Atlantic side and a narrower belt on the Pacific Coast, connected by a broad belt through the northern latitudes, was almost entirely under its undisputed sway, and while the backbone of the continent, the crest and slopes of the Rocky Mountains, was more or less in its possession, there still remained a vast empire in the interior unconquered.

Of parts of this territory we feel reasonably certain from strong evidences that the forest once occupied them, but has been driven off by aboriginal man, the firebrand taking sides with the grasses, and the buffalo probably being a potent element in preventing re-establishment. In other parts it is questionable whether the lines along the river-courses, the straggling trees on the plateaus and slopes, are remnants of a vanquished army or outposts of an advancing one. In some parts, like the dry mesas, plateaus and arroyos of the interior basin and the desert-like valleys toward the southern frontiers, it may reasonably be doubted whether arborescent flora has more than begun its slow advance from the outskirts of the established territory.

Certain it is that climatic conditions in these forestless regions are most unfavourable to tree growth, and it may well be questioned whether in some parts the odds are not entirely against the progress of the forest.

Temperature and moisture conditions of air and soil determine ultimately the character of vegetation, and these are

dependent not only on latitude, but largely on configuration of the land, and especially on the direction of moisture-bearing winds with reference to the trend of mountains.

The winds from the Pacific Ocean striking against the coast range are forced by the expansion and consequent cooling to give up much of their moisture on the windward side; a second impact and further condensation of the moisture takes place on the Cascade range and Sierra Nevada. On descending, with consequent compression, the wind becomes warmer and drier, so that the interior basin, without additional sources of moisture and no additional cause for condensation, is left without much rainfall and with a very low relative humidity, namely, below 50 per cent. The Rocky Mountains finally squeeze out whatever moisture remains in the air currents, which arrive proportionally drier on the eastern slope. This dry condition extends over the plains until the moist currents from the Gulf of Mexico modify it. Somewhat corresponding, yet not quite, to this distribution of moisture, the western slopes are found to be better wooded than the eastern, and the greater difficulty of establishing a forest cover here must be admitted; yet since the forest has the capacity of creating its own conditions of existence by increasing the most important factor of its life, the relative humidity, the extension of the same may only be a question of time.

Temperature extremes, to be sure, also set a limit to tree growth, and hence the so-called timber line of high mountains, which changes in altitude according to the latitude.

If now we turn our attention from the phyto-topographic consideration of the forest cover to the phyto-geographic and botanical features, we may claim that the North American forest, with 425 or more arborescent species, belonging to 158 genera, many of which are truly endemic, surpasses in variety of useful species and magnificent development any other forest of the temperature zone, Japan hardly excepted. In addition there are probably nowhere to be seen such extensive fields of distribution of single species.

These two facts are probably explained by the north-and-south direction of the mountain ranges, which permitted a re-establishment after the Ice Age of many species farther northward, while in Europe and the main part of Asia the east-west direction of the mountains offered an effectual barrier to such re-establishment, and reduced the number of species and their field of distribution; nor are the climatic differences of different latitudes in North America as great as in Europe, which again predicates greater extents in the fields of distribution north and south. On the other hand, the differences east and west in floral composition of the American forest are greater than if an ocean had separated the two parts instead of the prairie and plains. This fact would militate against our theory that the intermediate forestless region was or would be eventually forested with species from both the established forest regions, if we did not find some species represented in both regions and a junction of the two floras in the very region of the forestless areas.

(To be continued.)

## SOCIETIES AND ACADEMIES.

### LONDON.

Zoological Society, November 20.—Sir W. H. Flower, K.C.B., F.R.S., President, in the chair.—Mr. F. G. Parsons read a paper on the anatomy of *Atherura africana*, compared with that of other porcupines. In addition to the points mentioned by Drs. Gray and Günther, as differences between the skulls of *A. africana* and *A. macrura*, the arrangement of the fronto-nasal suture, the position of the maxillo-malar suture, and the frequent presence of an "os anti-epilepticum" were noticed.—A communication from Mr. J. T. Cunningham treated of the significance of diagnostic characters in the Pleuronectidae.—Mr. A. Smith Woodward read a description of the so-called Salmonoid fishes of the English Chalk, dealing with the osteology of *Osmoroides lewesiensis*, *Elopopsis crassus*, and *Aulolepis typus*.—Mr. W. Garstang read a paper on the Gastropod *Colpodaspis pusilla* of Michael Sars. He described a specimen of this rare mollusk found by him at Plymouth in the early part of the year.—A communication from Mr. A. D. Bartlett gave an account of the recent occurrence in the Society's menagerie of a case of one boa swallowing

another of nearly equal size.—A communication from Prof. R. Collett contained a description of a new Agonoid fish from Kamtschatka, proposed to be called *Agonus gilberti*.

Royal Meteorological Society, November 21.—Mr. R. Inwards, President, in the chair.—Dr. H. B. Guppy read a paper on suggestions as to the methods of determining the influence of springs on the temperature of a river as illustrated by the Thames and its tributaries. The methods suggested were (1) comparison of the curves of the monthly means of the temperatures of the air and of the water for the river under observation with those of a river beyond the controlling influence of springs; (2) comparison of the monthly means of the temperature of the river under investigation with that of a river beyond the control of the springs; (3) comparison of the range of the monthly means of the river temperature with that of the air in the shade; (4) comparison of the daily range of water temperature at different stations along a river's course; (5) comparison of sunrise observations made at different stations along a river's course; (6) comparison of observations made at different stations along a river's course at the hour of maximum temperature; (7) comparison of the results obtained from a single series of observations made in one day along the whole course of a small tributary like the Wandle, or along the upper course of a larger tributary as the Kennet; and (8) determination of the distance from its sources at which the river begins to freeze.—Mr. Eric S. Bruce exhibited and described some lantern slides showing the disastrous effects of the great gale of November 17 and 18, 1893, upon trees in Perthshire, Scotland.—Mr. Alfred B. Wollaston gave an account of the formation of some water-spouts which he had observed in the Bay of Bengal.

### CAMBRIDGE.

Philosophical Society, November 12.—Prof. J. J. Thomson, President, in the chair.—On the inadequacy of the cell theory and on the development of nerves, by Mr. A. Sedgwick. The author pointed out that the cell-theory, in so far as it implied that the organism was composed of cell-units derived by division from a single primitive cell-unit, the ovicell, would not bear the scrutiny of modern embryology, and that in fixing men's attention too much upon the cell as a unit of structure, it had had a retarding influence on the progress of the knowledge of structure. He illustrated this latter point by reference to the current ideas on two important subjects: the structure of the embryonic tissue called mesenchyme, and the development of nerves. The mesenchyme is not composed of separate branched cells, but has rather a spongy or reticulate structure, and is continuous both with ectoderm and endoderm. Nerves do not develop as outgrowths of the central organ, but arise *in situ* from the mesenchyme.—Note on the evolution of gas by water-plants, by Mr. F. Darwin.

### PARIS.

Academy of Sciences, November 19.—M. Læwy in the chair.—After the reading of the *procès verbal*, the meeting was adjourned as a mark of respect to the late Czar of Russia.

### AMSTERDAM.

Royal Academy of Sciences, October 27.—Prof. Van de Sande Bakhuyzen in the chair.—Mr. Franchimont, in presenting Mr. H. van Erp's thesis for the Doctorate in Chemistry at the University of Leyden, entitled "Studie over aliphatische nitraminen," described it as a summary of all the known acid and neutral nitramines and nitramides, and also of their modes of formation. In dealing with the action of water, acids and alkalis on these bodies, Mr. van Erp considers them as derived from the amide of nitric acid, and compares them to the analogous derivatives of nitrous acid, hypochlorous acid, &c. For experimental purposes he made the unknown butyl- and hexyl-derivatives: nine urethanes, seven nitro-urethanes, four acid nitramines with several salts, two mixed neutral nitramines. He failed, however, to obtain nitro-compounds of the tertiary butyl amidoformates. He has observed that while the potassium salts of the acid nitramines yield the neutral methyl-derivatives by the action of methyl iodide, the silver salts produce an isomeric methylated nitramine, or a mixture of the two. Similar observations in the case of the salts of phenylnitramine were made later by Bamberger. The behaviour of acid nitramines towards dilute sulphuric acid was studied on hexylnitramine, the result being N<sub>2</sub>O, two hexanoles, a primary and a secondary

2. The ethyl and allylic ether. Mr. van Erp has also observed the behaviour of neutral nitramines with alkalis. Dimethylnitramine gives nitrous acid, monomethylamine, formic acid and methyl alcohol? Diethyl- and dipropylnitramine seemed not to be changed. Normal butylnitramine, less easily than dimethylnitramine, gives nitrous acid, butylamine, formic acid and methyl alcohol? It therefore seems that mixed nitramines give the amine with the greatest alkyl, or the methyl radical is most easily separated from the nitrogen.—On quadrinodal quintics, by Mr. Jan de Vries.—On the cranial nerves of vertebrates in amphioxus, by Mr. van Wijhe. The olfactory nerve represents a type of its own. The ventral nerves, or nerves of the myotomes, do not exhibit special characteristics. Among the dorsal or septal nerves, the trigeminal, facial, glossopharyngeal and vagus nerves could be recognised with more or less probability, chiefly by their relations to the branchial clefts, the first of which on the left side becomes the opening of the velum.

DIARY OF SOCIETIES.

LONDON.

THURSDAY, NOVEMBER 29.  
SOCIETY OF CHEMISTS.—Lecture.—W. Roberts in Copper, Zinc, Brass, and Tin: Prof. M. S. Ewart.

FRIDAY, NOVEMBER 30.

ROYAL SOCIETY (at the Anniversary Meeting).  
INSTITUTION OF CIVIL ENGINEERS, at 3.—Subaqueous Excavation at Newry: Mr. H. G. O'Connell.  
SOCIETY OF BARRISTERS.—Sanitary Law: Prof. A. Wynter Blyth.

SATURDAY, DECEMBER 1.

SOCIETY OF CHEMISTS, at 4.—Village Litem in India: Mr. R. W. Frazer.

SUNDAY, DECEMBER 2.

SOCIETY OF CHEMISTS, at 4.—Modern Developments in Explosives: Prof. A. B. Lewis.

SOCIETY OF CHEMICAL INDUSTRY (Burlington House), at 7.—The National Steam Station of America: Mr. J. W. Kuhn (of Paris)—Analysis of the Natural Sulphate Lakes of Wyoming, U.S.A.: Dr. H. H. Van Slyke.—Specimens of India-rubber, and Petroleum Oil, Vaseline, and Soap will be exhibited by Mr. F. Ross, Christy.

TUESDAY, DECEMBER 4.

ZOOLOGICAL SOCIETY, at 8.—On some Points in the Anatomy of the Salamander, *Ambystoma*: Mr. T. M. Myers Smith.—On certain Points in the General Anatomy of *Orthorhynchus*: Mr. F. E. Beddard.—Fishes.—On some Remarkable Cases of Great Size from North-West America: Prof. F. Jersey Bell.—Second Report on Additions to the Zoological Collections in the Natural History Museum: Mr. G. A. Boulenger, F.R.S.

INSTITUTION OF CIVIL ENGINEERS, at 8.—The Machinery of War-Ships: Mr. A. W. J. Darston.—Culinary Surface-Works: Mr. E. B. Wain.  
LONDON SOCIETY OF SCIENTISTS, at 8.15.—The Eleventh United States Exhibition: Mr. R. P. Porter.—Exhibition of the Hollerith Electrical Counting Machine: Dr. H. H. Berrill.

WEDNESDAY, DECEMBER 5.

SOCIETY OF ARTISTS, at 8.—Fire-Proofing: Edwin D. Sachs.  
GEOLOGICAL SOCIETY, at 8.—Supplementary Note on the North-east of the Isle of Skye: Prof. J. G. Bonney, F.R.S.—The Farms of the Isle of Skye: Mr. J. F. Marr, F.R.S.—The Marble Beds of Natal, Mr. G. H. Cooper.—The Application of a New Instrument for Surveying by the Method of the Vertical Angle: Observations upon the Applicability of the Method to the Surveying of a Range of Mountains: Mr. J. Bridges Lee.

ENTOMOLOGICAL SOCIETY, at 8.—A List of the Lepidoptera of the Khasia Hills: Mr. H. H. Arnold.—On the Life History of a Monophagous British Butterfly: Mr. A. G. Rehn, F.R.S.—A. Marshall.—On the Longhorn Cuckoo: Mr. W. A. Ingleton.—Mr. Charles J. Galvan.—Notes on the Food Habits of a Large Series of Seromyiinae species, 1892: Mr. J. W. Mead.—An Account of the Sexual Preference in a Male Insect: Prof. E. H. Snodgrass.

THURSDAY, DECEMBER 6.

AGRICULTURAL SOCIETY, at 8.—Experimental Researches on Vegetable Assimilation: Mr. J. G. Bennett.—Notes on a New Method for Investigating the Effects of Various Gases on Plants: No. 2: On the Paths of Gaseous Exchange between a Plant and the Atmosphere: Mr. F. I. Blackburn.

SOCIETY OF ARTISTS, at 8.—Paints and British Indian Systems of Colouring: Mr. H. W. Lee, Worcester, C.S.I.  
LONDON SOCIETY OF SCIENTISTS, at 8.—A New Process of Dyeing: Mr. J. W. Mead.—A New Process of Spinning: Mr. H. H. Berrill.

CHEMICAL SOCIETY, at 8.—The Crystallographic Study of Crystals: Mr. J. V. B. Smith, F.R.S.—Lecture: Heat of Fusion: Mr. H. G. O'Connell.—New Method of Preparing Dichloroacetic Acid: Mr. H. H. Berrill.—Lecture: The Chemistry of the Fertilizer: Mr. A. C. Chapman.

FRIDAY, DECEMBER 7.

ROYAL ENTOMOLOGICAL SOCIETY, at 8.—General Monthly Meeting.  
GEOLOGICAL SOCIETY, at 8.—Notes on Megalobryaria, Teeth, discovered by Mr. J. Alcock in the Purpurina at Aylesbury: Mr. V. Smith.  
WILSON.—On the Geology of the Strath and Firth: Mr. H. W. Mead.

SATURDAY, DECEMBER 8.

ROYAL ENTOMOLOGICAL SOCIETY, at 8.

BOOKS, PAMPHLETS, and SERIALS RECEIVED

Books.—Imperial University of Japan. Calendar 1895-4 (Tokyo: Maruyak).—Catalogue of the Snakes in the British Museum (Natural History): G. A. Boulenger, Vol. 2 (London).—The Flower of the Ocean, the Island of Madeira: Surgeon-General C. A. Gordon (Bailière).—Topographische Anatomie des Pferdes: Ellenburger and Baum, Zweiter Teil (Berlin, Parey).—Butterflies and Moths (British): W. Furneaux (Longmans).

PAMPHLETS.—Sulle Oscillazioni Elettriche a Piccola Lunghezza d'Onda: Sc. 2: Prof. A. Righi (Fologna).—North of England Institute of Mining and Mechanical Engineers: Report of the Proceedings of the Flameless Explosives Committee. Part 1: Air and Combustible Gases: A. C. Kayll (Reid).—Resultate der im Sommer 1893 in dem Nordlichsten Theile Norwegens ausgeführten Pendelbeobachtungen: O. F. Schmidt (Kristiania, Dydward).

SERIALS.—Cassell's Magazine, December (Cassell).—Proceedings of the Aristotelian Society, Vol. 2, No. 3, Part 2 (Williams).—Transactions and Proceedings of the Botanical Society of Edinburgh, Vol. xx, Part 1 (Edinburgh).—Proceeding of the American Academy of Arts and Sciences, new Series, Vol. xxi, (Boston).—Brain, Part lxxvii (Macmillan).—Kryptogamen-Flora von Schlesien, iii, Band, 2 Hälfte, 3 Liefg. (Breslau, Kern).—Journal of the Institute of Jamaica, September (Sotheran).—Longman's Magazine, December (Longmans).—Chambers's Journal, December (Chambers).—Natural Science, December (Macmillan).—Good Words, December and Christmas (Isbister).—Sunday Magazine, December and Christmas (Isbister).—Century Magazine, December (Unwin).—Humanitarian, December (Hutchinson).—Udgivet af den Norske Gradnaaings-Kommission, Vaadstansobservationer, 8 Hefte Christiania, Fabritius).—Botanische Jahrbücher, 8c., Zwanzigster Band, 1 and 2 Heft (Leipzig, Engelmann).

CONTENTS.

PAGE

Locomotive Construction. By N. J. Lockyer . . . . . 97  
Indo-Malayan Spiders. By R. I. Pocock . . . . . 99  
The Plateau Region of Southern France. By Canon Bonney, F.R.S. . . . . 100  
Our Book Shelf:—  
Ziwet: "An Elementary Treatise on Theoretical Mechanics."—G. . . . . 101  
Aubertin: "By Order of the Sun to Chile to see his Total Eclipse, April 16, 1893" . . . . . 101  
Schmidt: "Reise nach Südindien" . . . . . 101  
Step: "By Vocal Wools and Waters" . . . . . 102  
Letters to the Editor:—  
Acquired Characters.—Prof. E. Ray Lankester, F.R.S. . . . . 102  
The Present State of Physiological Research.—Prof. Francis Gotch, F.R.S. . . . . 103  
Wilde's Theory of the Secular Variation of Terrestrial Magnetism.—L. A. Bauer . . . . . 103  
Boltzmann's Minimum Theorem.—Rev. H. W. Watson, F.R.S.; Edwd. P. Culverwell . . . . . 105  
The Alleged Absoluteness of Motions of Rotation.—A. E. H. Love, F.R.S.; Prof. A. G. Greenhill, F.R.S. . . . . 105  
Science Teaching in Schools.—O. Henrici; H. G. Wells . . . . . 106  
The Explosion of a Mixture of Acetylene and Oxygen. Dr. T. E. Thorpe, F.R.S. . . . . 106  
"Newth's Inorganic Chemistry." G. S. Newth; M. M. Pattison Muir . . . . . 106  
Singing Water Pipes.—W. B. Croft . . . . . 107  
An Aurora on November 23.—J. Shaw . . . . . 107  
A Snake "Playing Possum." L. C. Jones . . . . . 107  
The Soaking of Seeds.—P. C. Glubb . . . . . 107  
History of Encke's Comet. By W. T. Lynn . . . . . 108  
Progress of the Cataract Construction Company's Works at Niagara . . . . . 109  
The Nile Reservoir . . . . . 110  
Notes (Illustrated) . . . . . 110  
Our Astronomical Column:—  
The Parallax of Nebula *h* 2241 . . . . . 114  
A Possible New Zone of Asteroids . . . . . 114  
A New Comet . . . . . 114  
A New Series of Nitrogen Compounds . . . . . 114  
The Scientific Investigations of the Scottish Fishery Board. By W. G. . . . . 115  
Sir John Donnelly on Technical Education . . . . . 116  
The Battle of the Forests. I. By Prof. B. E. Fernow . . . . . 116  
Societies and Academies . . . . . 119  
Diary of Societies . . . . . 120  
Books, Pamphlets, and Serials Received . . . . . 120

THURSDAY, DECEMBER 6, 1894

*PECULIARITIES OF PSYCHICAL RESEARCH.**Apparitions and Thought Transference.* By Frank Podmore, M.A. London: Walter Scott, 1894

MR. PODMORE, in the opening chapter of this popular exposition of telepathy, pleads for the recognition of psychical research by the general body of scientific workers. He reminds us of the opposition geological and biological discoveries have encountered, and ventures to compare the circumstances of the small group of investigators with which he is connected, and more particularly the prejudice and derision they encounter, with the experiences of Cuvier and Agassiz. Convincing as this comparison may appear to the general reader, in one respect at least it fails. Three hundred years ago, all these phenomena of crystal gazing, thought transference, and apparitions had a broader basis of belief than they have to-day: even a hundred years ago, the ordinary scientific investigator was at little or no advantage over the exponent of magic arts. But though, as Mr. Podmore reminds us, the leading propositions of natural science once encountered popular prejudice, ridicule, contempt, hatred, far more abundantly than has ever been the lot of psychical interpretations, they have won through and triumphed, while the credit accorded such evidence as the S.P.R. accumulates has, if anything, diminished. A thing Mr. Podmore scarcely lays sufficient stress upon is the fundamental difference in the quality of the facts of "psychical research," as distinguished from those of scientific investigation—using scientific in its stricter sense. It is true he has, with an appearance of frankness, devoted a chapter to "special grounds of caution," in which he concedes the truth of various criticisms, and owns to several undeniable impostures: but even here he passes from admissions to a skilful argument in favour of telepathy, and avoids the cardinal reason for keeping aloof from this field of inquiry, that lies in the quality of the evidence.

The scientific advances of Cuvier and Agassiz, like all true scientific discoveries, were based upon things that could be perceived directly by themselves, and which could be reproduced whenever required, and completely examined under this condition and that, by those who doubted the facts. That is the essential difference between natural science and such a subject as history; science produces its facts, history at best produces reputable witnesses to facts. Scientific men have never attached much importance to unverifiable statements, however eminent the source. If, to suppose an instance, the greatest living anatomist were to announce that he had dissected a dogfish and discovered lungs therein, adduce his wife, a local general practitioner, two servants, and a lady "named Miss Z." in evidence, and add that he had lost the specimen, there can be scarcely any doubt that, in spite of his position and his character, the science of anatomy would remain exactly where it was before his discovery was proclaimed. But in this "psychical research" the deliberate reproduction of phenomena under conditions that admit of exhaustive sceptical examination appears to be generally impossible, and we are re-

peatedly asked to form opinions on the hearsay of Mr. Podmore and his fellow-investigators.

This is not all. Few of the phenomena are directly observed. Dr. Dee had his Kelly. Prof. Oliver J. Lodge his Mrs. Piper. If Prof. Sedgwick would read the thoughts of Prof. Oliver J. Lodge, or—as a phantasm of the living—take to haunting some sceptical person, we should have at least a statement at first hand, to doubt: but as it is, these investigators manifest, as a rule, no other mental phenomena than belief and repetition. Reading through Mr. Podmore's book, the student will be struck by the fact that the persons who are in immediate contact with the alleged phenomena, the hiring eyes of the psychological inquirer, are persons usually youthful and coming from a social level below that of the investigators. Take, for instance, the Guthrie cases, to which Mr. Podmore attaches considerable importance. Mr. Guthrie is a draper in Liverpool, and by some means, not stated, he became aware of psychic powers possessed by two of his employees—young ladies—whose identity is for some reason veiled under the initials "E." and "R." These young ladies were accordingly liberated at intervals from the toils of shop or workroom, and made the subjects of various experiments: Mr. Guthrie, for instance, putting cayenne pepper in his mouth, during a profound silence, and Miss E. experiencing a taste of "mustard." Now we must insist upon the fact, because it seriously affects this question of evidence, that to a young lady following the irksome and precarious calling of a draper's assistant, the manifestation of psychic gifts opens up eminently desirable possibilities and interests. Then, among other of these intermediaries, we find "Jane"—a pitman's wife—"Bertha J.," a peasant woman, hospital nurses and out-patients, two men "who had been subjects of an itinerant lecturer upon hypnotism," most of the letters of the alphabet, several American M.D.'s, lady medical students, a baker's assistant, Mr. P., "a clerk in a wholesale house, aged nineteen, who possesses a good deal of humour," and so forth.

Scarcely ever is the medium a person really independent, in a financial sense, of the investigators who are craving for phenomena. It is necessary for us to believe in the general good faith of this extremely dubious material, or in the adequacy of the precautions against fraud taken by persons whose scientific reputations are now hopelessly bound up with the reality of the alleged facts, before one can even begin to accept the experimental basis upon which the theory of telepathy rests. And this is the character of the investigations that Mr. Podmore has compared with the work of Cuvier and Agassiz! In no other field of inquiry is so much faith in personal character and intelligence demanded, or so little experimental verification possible. Indeed, the book is oddly suggestive in places, with its use of initials and second-hand guarantees of character, of the testimony one finds adduced in favour of patent medicines.

Now, to the attentive reader of Mr. Podmore, the persuasion is unavoidable that the ordinary psychical investigator is endowed with a considerable facility of belief, and is by no means instinct with the scientific method. And this, where we are to take very much on faith, is a material consideration. Anonymous statements

are accepted, and not only anonymous but self-contradictory ones. Mrs. Piper hypnotised, personated a French physician Dr. Phinuit, who did not know French, and failed to give a satisfactory account of himself. Mrs. Piper, during her trance as Dr. Phinuit, gabbled, made chance shots, "fished" for information, and was generally a transparent enough imposition. Yet she occasionally spoke of things she could not, according to the investigators, have obtained a knowledge of by ordinary means. For that they give her credit, and forgive all her failures. Prof. Lodge, apparently eager to believe, compares her utterances to the experience of anyone listening at a telephone: "you hear the dim and meaningless fragments of a city's gossip till back again comes the voice obviously addressed to you, and speaking with firmness and decision." Imagine in a real scientific inquiry an investigator pursuing a theory through a complicated series of observations, arbitrarily selecting those that advance his views, and calling the others "dim and meaningless until back comes the result obviously addressed to you!"

As one instance of the absence of scientific method from these discussions, take M. Richet's and Mr. Gurney's experiments with cards. In these experiments an agent looked at the card, and a percipient guessed the suit. M. Richet conducted 2927 trials, and 789 correct guesses were made, the theory of probability only granting 722. The S.P.R. trials numbered 17,653, with 4760 successes—347 in excess of the probable number. Now this is adduced by Mr. Podmore as evidence for telepathy: we are asked to believe that about once in sixty times—that is the excess above the probable ratio of successes—the mental impression of the agent recorded itself upon the brain of the percipient. Whether during the interval of fifty-nine trials telepathy was in abeyance, Mr. Podmore does not say, and the failure of the American S.P.R. to confirm these results he sets aside because the details of their experiments are not given—an excellent example to the sceptic. Are we to believe that only once in sixty times did the transferred thought surge up into consciousness, or that the transference occurs only at the sixth time, or what? A most obvious collateral test seems to have been altogether overlooked, namely, for someone to guess cards *before* the agent saw them, and so to ascertain how far pure haphazard guessing of this kind, or guessing, on any particular gambler's "system," may fall away from the theory of probability. The deductions of the theory of probability, be it remembered, become certainties only when the number of cases is infinite. We have no grounds for assuming that in seventeen thousand or twenty thousand, or in any finite number of cases, facts come into coincidence with this theory. In an infinite number of sets of 17,653 trials we might have every possible divergence from the average result up to 17,653 successive failures or 17,653 successive successes. Taking a number of sets, they may be expected to fluctuate round a mean result in agreement with the theory of probability—that is all. These three sets of experiments manifestly prove nothing. And this is how Mr. Podmore prefaces his account of them: "In the following cases, where the exact nature of the impression received was not apparently classified by the percipient, it may be presumed to have been either of a visual or

an auditory nature." He begs the question, and in a book addressed to the untrained mind of the general reader! Nothing could show more clearly the tendency of this psychical research to accept as evidence what is really not evidence at all, its lack of critical capacity and severe confirmatory inquiry, and the missionary spirit of its exposition.

Enough has been said to show the essential difference between "psychical" and scientific investigations, and to justify the attitude of scepticism. After all, that scepticism does nothing to hamper Mr. Podmore and his associates from collecting their evidence, clarifying their opinions, and building up such a defensible case as their peculiar circumstances permit. And be it remembered the scientific man of to-day occupies a responsible position, that he possesses even a disproportionate share of the public confidence, because of his reputation for sceptical caution. The public mind is incapable of the suspended judgment; it will not stop at telepathy. Any general recognition of the evidence of "psychical" research will be taken by the outside public to mean the recognition of ghosts, witchcraft, miracles, and the pretensions of many a shabby-genteel Cagliostro, now pining in a desert of incredulity, as undeniable facts. Were Mr. Podmore's case strong—and it is singularly weak—the undeniable possibility of a recrudescence of superstition remains as a consideration against the unqualified recognition of his evidence.

H. G. WELLS.

#### THE BEGINNINGS OF HISTORY.

*The Dawn of Civilisation—Egypt and Chaldea.* By G. Maspero. Edited by A. H. Sayce. Translated by M. L. McClure. London: Society for Promoting Christian Knowledge, 1894.)

AS the winter season advances, and folk begin to wind their way to Egypt, the enterprise of authors and publishers keeps up a steady supply of good literature concerning the country which, since the English occupation in 1882, has exercised upon people of all nations a fascination which may be described as marvellous. Only a few weeks ago an English translation of Dr. Erman's *Aegypten* appeared, and already we have before us a translation of a very important work by Prof. Maspero in the same language. Both works are excellent, but each is typical of the nationality of its writer, and is really addressed to a different class of readers. The work of Dr. Erman possesses a minuteness of detail characteristic of the true German student, laborious and accurate, while that of M. Maspero, though no less accurate, discusses facts on a large scale with due reference to everything which bears upon them, and contains generalisations which all thoughtful readers will accept with gratitude; added to this, we have the light and easy style and logical arrangement of facts and sentences which are the type of the work of the French master of his subject. In short, Dr. Erman's book will form a standard work of reference for the student of Egypt; but that of M. Maspero will take its place as a general history of early Oriental civilisation on the banks of the Nile, Tigris, and Euphrates, and in the countries which lie between.



The volume which we have in our hands, although it is nowhere stated in it, seems to be the first of a series which M. Maspero intends to devote to the history of the ancient nations of the East; and indeed the original French work began to appear in weekly numbers with the general title of *Histoire Ancienne des Peuples de l'Orient* some time ago. It is necessary to state this in order that the reader may not confuse the new work of M. Maspero with the small and older work, the first edition of which appeared in Paris so far back as 1875, for although both books run on the same lines, and have the same aim, and the smaller originated the idea of the larger, yet the scale of the new work has been so greatly increased that it practically forms a new and independent treatise on Oriental history and archæology. The first work ran through four editions at least, and was exceedingly popular; but the new work, with its beautiful illustrations, is intended to be in France what Rawlinson's "Ancient Monarchies" was in England.

M. Maspero divides the first volume of his history into two parts: the first treats of Egypt, and the second of Ancient Chaldæa, six chapters being devoted to the former subject, and three to the latter. A detailed description of the formation of Egypt as a land is followed by an account of the Nile and of its influence upon the history of the country and its people. The civilisation of Egypt, according to M. Maspero, sprang up in the country on the banks of the Nile, which was bounded by Gebel Silsila on the south, Buto in the Delta on the north, the mountain of Bakha on the east, and the mountain of Manu on the west. The origin of the people who produced it is difficult to trace, for the camp of Egyptologists is divided in opinion on the matter. Many scholars hold that the Egyptians came from Asia, but not all who are of this opinion agree as to the route followed by them into Egypt. Some would have them enter Egypt by the Isthmus of Suez, and having gained possession of the Delta, make their way up to Memphis, Heliopolis, and further south; others would have them cross the Red Sea to Kosseir and so thence to Coptos, and thus account partially for the traditions which made Abydos in Upper Egypt the oldest city in Egypt; and again, others would make them cross over from the Arabian Peninsula by the Straits of Bâb el-Mandeb into Africa, and skirting the Abyssinian mountains, enter Egypt from the south. The first theory holds water so long as we assume that the Egyptians made their way from the East by the old trade routes into Egypt through Syria; in fact, this would be their only way if they set out from countries on about the same parallel of latitude as Babylon, for the want of water in the desert between the Euphrates and Egypt has from time immemorial made the route impossible even for the armies of mighty kings, and every invasion of Egypt by peoples from this region has been made by the way of northern Syria. The second theory makes it necessary for the emigrants from Asia to have crossed the waterless desert in the Arabian Peninsula, and to have built boats sufficiently large to cross the Red Sea; this appears to be the most improbable of all the theories yet put forth. The third theory has much in its favour, for the passage across the Straits of Bâb el-Mandeb would be easy, and the distance from shore to shore was probably less in

those days than now. There exists yet another theory, however, as to the Asiatic origin of the Egyptians. In a paper read at the Oriental Congress in 1892, Dr. Hommel boldly asserted that the Egyptian civilisation was derived from that of Babylon, and he attempted to prove that the names of the gods of the one country were but slightly modified forms of those of the others. Egyptologists have not, up to the present, accepted this theory. A still more remarkable theory is that of Reinisch, who believes that Asiatics, Europeans and Africans spring from one family, whose original home was in the heart of Africa, near the great equatorial lakes. M. Maspero does not accept the theory of an Asiatic origin, but rather believes that the Egyptian

"population presents the characteristics of those white races which have been found established from all antiquity on the Mediterranean slope of the Libyan continent; this population is of African origin, and came to Egypt from the west or south-west. In the valley, perhaps, it may have met with a black race which it drove back or destroyed; and there, perhaps, too, it afterwards received an accretion of Asiatic elements, introduced by way of the isthmus and marshes of the Delta."

The caution with which M. Maspero puts forth this theory shows that he has some doubts about it, and, indeed, leaves the question exactly where it was. As to the relationship between the Semitic languages and the language of the hieroglyphics, he has no doubt that at one time they all belonged to the same group; the latter, however, separated from the former very early, "at a time when the vocabulary and the grammatical system of the group had not as yet taken definite shape." This is an important pronouncement for an Egyptologist to make, and although it was said long ago by Semitic scholars, it is none the less welcome since it comes from one of the first Egyptologists of our times. Passing from the origin of the people to their religion and manners and customs, M. Maspero concisely and graphically describes their gods and mythology, and the beliefs which swayed the minds of the Egyptians for several thousands of years. The size of M. Maspero's work and the limits of a brief article absolutely preclude the possibility of noticing many new points in these subjects, which are admirably described, and we rapidly pass from the account of the political constitution of Egypt to the historical section of this division of the book, which treats of the first fourteen dynasties.

The second part of the volume follows the plan of the first, and sets out by describing the country, people, gods, &c., of the ancient Chaldæans, or more properly Babylonians, and the chapter which treats of their ideas concerning the Creation is of considerable interest. In this M. Maspero has rightly relied upon Jensen's epoch-marking book, "Die Kosmologie der Babylonier," for information, but it is to be regretted that Zimmern's translations of the "Creation" and other tablets were not published in time to be used by him. M. Maspero is, however, the first to describe popularly the excellent results achieved by Jensen in a subject which before he treated it was truly chaos. Passing to historical times, M. Maspero describes the foundation of the Babylonian empire, basing all his statements upon a series of works by Assyriological authorities, and cleverly harmonising

their various opinions. The chapter on the Chaldean civilisation is interesting, and is full of curious information. The volume is concluded by an appendix treating of the Pharaohs of the Ancient and Middle Empires, and by a useful index. M. Maspero is fortunate in having found so careful a translator as Mrs. McClure, who introduces her work in a preface which is at once business-like and to the point. The editor's remarks are, however, somewhat rambling, and in professing to criticise M. Maspero's knowledge of matters Egyptian or Babylonian, we think greatly out of place.

#### THE TRANSMISSION OF POWER.

*On the Development and Transmission of Power.* By William Cawthorne Unwin, F.R.S. London: Longmans, Green, and Co. (1894.)

IT is well known that the author of this work has had special opportunities for studying the subject of transmission of power by all the various methods which have, at different times, been adopted, and the engineering world is to be congratulated on having received from his pen a summary of the principles utilised in this class of work, and of the possibilities of the future, as well as very complete and authentic information about the principal work that has been done in the past. This book is the outcome of a course of "Howard" lectures delivered before the Society of Arts in 1893. It deals with the generation, storage, and transmission or distribution of power. The methods of transmission and distribution include water under pressure, compressed air, wire ropes, steam, gas and electricity. The author recognises the fact that transmission of power to distances has not been so fully developed in the past as it is likely to be shortly, and that the electrical transmission and distribution of power has more to claim in the way of promises for the future than large achievements in the past.

The first chapters deal with the generation and the cost of generating power by steam or hydraulically. One of the most valuable parts of the book is found in those chapters where the economy of steam engines is considered. These chapters deal with the losses in a boiler and engine in a very complete manner. The author has realised very fully the fact that in any case of generating power in large quantities, and distributing it to small consumers, the cost of the horse power depends largely upon the load losses at different times of the day, and he draws attention to the very large excess of cost per horse power of electric lighting stations over those which are delivering power at a constant rate. Even in a pumping station where the work is continuous, he finds that about 15 per cent. more fuel is required than in a careful trial, but that a station from which electric light or power is distributed, the losses due to banking of boilers and to engines working a portion of their time at an output which is not economical, are such that the quantity of fuel used per indicated horse power rises from 1½ lbs. per hour in a test trial with a condensing engine, to 2½ lbs. under the special circumstances. The relative advantages of the condensing and non-condensing engines, of the simple, compound, and triple expansion engines, of the steam-jacketing and superheating, are all discussed admirably. Some pages also are devoted to

the utilisation of house refuse as a fuel, and the Halpin system of thermal storage receives some attention.

Some of the most important cases of utilising water power are also discussed. It will surprise many readers to find that even in 1876, 70,000-horse power was generated for manufacturing purposes from waterfalls in Switzerland, and that in the United States in 1880, 36 per cent. of the power used in manufacturing was water power, and only 64 per cent. steam power.

Among the chapters devoted to transmission of power, the most important, as pertaining more especially to the author's experience, are those on hydraulic and compressed air transmission. But in all branches of the subject, not only are the general principles dealt with, but there is to a pretty full extent a recapitulation of what has already been done. The London Hydraulic Power Company is taken as the best example of hydraulic transmission, but Liverpool, Birmingham and Manchester are also referred to, whilst most interesting accounts of the hydraulic supply at Zurich and Geneva are given. The principles of pneumatic distribution are very completely described, and the author has certainly made out the case that when these principles are properly applied, this system of distribution deserves more consideration than is generally accorded to it. Naturally the Paris distribution by this method is dealt with very fully, but other examples of interest are added. With regard to the distribution of power by steam, the most important case is that of New York, which Dr. Emery started in 1881. Eight pages upon gas distribution for power purposes are well worth some study, whether with regard to manufactured gas, or the natural gas supply in Pennsylvania. Whilst compressed air receives the author's attention to the extent of forty-eight pages, electrical distribution is by no means so well favoured; but the author explains that, in the first place, it is not his own speciality, and, in the second place, there are at the present moment few cases of electrical transmission combined with a complete system of distribution in a town. A chapter is at the end devoted to the great work which is now approaching its full development at Niagara Falls.

This short review cannot pretend to give an adequate idea of the contents or value of Prof. Unwin's book. Regarding the merits of the work generally, it is sufficient to say, first, that throughout it is written with the utmost firmness and impartiality; and secondly, that if any engineer were planning a system of transmission and distribution of power in any special case, he would be labouring under very considerable disadvantages if he had not first consulted this latest and most complete work on the development and transmission of power. G. F.

#### OUR BOOK SHELF.

*A Treatise on Hygiene and Public Health.* By Thomas Stevenson, M.D., F.R.C.P., and Shirley F. Murphy. (London: J. and A. Churchill, 1894.)

THIS volume is devoted to the subject of sanitary law, and it well maintains the all-round excellence of the two volumes that preceded it. Health officers will welcome the appearance of such a lucid and comprehensive digest of the law relating to the public health in England and Wales, Ireland and Scotland.

During comparatively recent years an immense amount

of piece-meal legislation bearing upon the public health has been passed; that much of this legislation, despite subsequent amendments, still remains obscure and unsatisfactory is clearly shown in the results of proceedings undertaken by those whose duty it is to put it in force. What cause to wonder, then, if the lay reader, by reason of obscurities in the particular Act itself, or from the fact that either amendments have been introduced by succeeding enactments or the particular Act is itself an amendment of earlier statutes, becomes bewildered, and a laudable desire to master an important subject is nipped in the bud? Those who are concerned in the administration of this branch of the law have frequent occasions to regret the lamentable ignorance existing among all sections of the community as to their powers and liabilities in matters which may seriously affect their vital interests. Any simplification and consolidation, therefore, more especially when it is undertaken, as in this instance, by gentlemen of recognised legal ability, should prove very welcome not only to health officers, but also to the general public.

The decisions of the authors of the work to collate the various provisions contained in different enactments dealing with the same subject, and to present these—so far as possible freed of all legal phraseology, was a happy one; it makes the work unique in its serviceability to the lay reader, who will gain from its perusal a clearer and more definite knowledge of the public health laws of the different parts of the United Kingdom than he would succeed in doing—at a much greater sacrifice of time and patience—from any other publication dealing with the same subject.

*Involution and Evolution according to the Philosophy of Cycles.* By Kalpa. (London: Eyre and Spottiswoode, 1894.)

THIS is one of the books that most people would be glad to lay aside, and, indeed, it is very difficult to say with what object it has been written. The cycles described have nothing to do with approximate commensurability of planetary motions, and certainly not with evolution as understood in the modern acceptation of the term. The author is a disciple of the school of Mme. Blavatsky, and draws his inspiration from that source, tinged, it may be, with something of esoteric Buddhism, and a good deal "spider-wove from his own brain." If anyone wants to know what absurdities modern theosophy is capable of, by all means let him read it, but most people will be satisfied to take the contents at second-hand. A very objectionable feature in the book is the occasional quotation at the heads of chapters of extracts from recognised writers of authority, conveying the impression that the contents of the chapters following are based upon modern science, and would meet the approval of the authors from whom the quotations are made. One illustration will be sufficient to show the style of the author's reasoning and the character of the information conveyed. The particular object is to demonstrate the birth of comets and worlds (p. 148). "But the least subtilised type of those disembodied groups does not take the same direction as the others. It keeps going in orbits round the sun, shooting beams at him, which, expelled (seemingly, at least), spread out behind as a lengthy tail. Then, when the sun takes a short rest, his brilliancy nearly spent, that entity moves off, its beams showing the way, but greatly reduced, and of which nought remains ere the comet disappears for parts unknown. It will be known to us as comet 1." We have, approximately, 200 pages of this sort of stuff, paragraph after paragraph, all of which are utterly incomprehensible, and to wind up the whole we have sheet after sheet of diagrams or illustrations which no man can understand, and on which we should imagine the author himself would pass a very doubtful examination.

*The Mountains of California.* By John Muir. Pp. 381. (London: T. Fisher Unwin, 1894.)

Few regions offer more remarkable subjects for the student of nature than the State of California. There are the two great mountain ranges—the Coast Range on the west, and the Sierra Nevada on the east. Great canons farrow the latter to depths of from two thousand to five thousand feet, and in the middle of the deepest of them flourish the Sequoia, the noble sugar and yellow pines, Douglas spruce, Libocedrus, and the silver firs, each a giant of its kind. Floods of lava cover the north half of the High Sierra, and volcanic craters, recent and in all stages of decay, are dotted over it. Mount Shasta is one of these volcanic cones, rising to a height of more than fourteen thousand feet above sea-level. Deep grooves flute the sides of the mountains, and testify to glacial erosion. It appears that so far south as latitude thirty-six degrees, traces of glacial action abound. Mr. Muir has found sixty-five residual glaciers in the portion of the Sierra lying between latitudes thirty-six and thirty-nine degrees. The first one of these was discovered by him in 1871 between two of the peaks of the Merced group. He also determined the rate of motion of the middle of the Maclure glacier, near Mount Lyell, to be but little more than an inch a day. Mount Shasta has three glaciers; while Mount Whitney, though the highest mountain in the range, has none.

The special features of the volume are the descriptions of the glaciers, glacier lakes, and glacier meadows in the Californian mountains, and the interesting account of the grand forest-trees of the Sierra.

#### LETTERS TO THE EDITOR.

[The Editor does not hold himself responsible for opinions expressed by his correspondents. Neither can he undertake to return, or to correspond with the writers of, rejected manuscripts intended for this or any other part of NATURE. No notice is taken of anonymous communications.]

##### Origin of Classes among the "Parasol" Ants.

MR. J. H. HART is Superintendent of the Royal Botanic Gardens in Trinidad. He has sent me a copy of his report presented to the Legislative Council in March 1893, and has drawn my attention to certain facts contained in it concerning the "Parasol" ants—the leaf-cutting ants which feed on the fungi developed in masses of the cut leaves carried to their nests. Both Mr. Bates and Mr. Belt described these ants; but described, it seems, different, though nearly allied, species, the habits of which are partially unlike. As they are garden-pests, Mr. Hart was led to examine into the development and social arrangements of these ants; establishing, to that end, artificial nests, after the manner adopted by Sir John Lubbock. Several of the facts set down have an important bearing on a question now under discussion. The following extracts, in which they are named, I abridge by omitting passages not relevant to the issue:—

"The history of my nests is as follows: Numbers one and two were both taken (August 9) on the same day, while destroying nests in the Gardens, and were portions of separate nests but of the same species. No. 3 was procured on September 5, and is evidently a different although an allied species to Nos. 1 and 2.

"Finding neither of my nests had a queen, I procured one from another nest about to be destroyed, and placed it with No. 1 nest. It was received by the workers, and at once attended by a numerous retinue in royal style. On August 30 I removed the queen from No. 1 and placed it with No. 2, when it was again received in a most loyal manner. . . .

"Ants taken from Nos. 1 and 2 and placed with No. 3 were immediately destroyed by the latter, and even the soldiers of No. 3, as well as workers or nurses, were destroyed when placed with Nos. 1 and 2.

"In nest No. 2, from which I removed the queen on August 30, there are now in the pupa stage several queens and several

males. The forms of ant in nests Nos. 1 and 2 are as follows: (a) queen, (b) male (both winged, but the queen loses its wings after marital flight), (c) large workers, (d) small workers, and (e) nurses. In nest No. 3 I have not yet seen the queen or male, but it possesses—(a) soldier, (b) larger workers, (c) smaller workers, and (d) nurses; but these are different in form to those of nests No. 1 and No. 2. Probably we might add a third form of worker, as there are several sizes in the nest.

It is curious that in No. 1 nest, from which the queen was removed on August 30, new queens and males are now being developed, while in No. 2 nest, where the queen is at present, nothing but workers have been brought out, and if a queen larva or pupa is placed there it is at once destroyed, while worker larvae or pupae are amicably received. In No. 3 all the eggs, larvæ, and pupæ collected with the nest have been hatched, and no eggs have since made their appearance to date. There is no queen with this nest. . . . On November 14 I attempted to prove by experiment how small a number of 'parasol' ants it required to form a new colony. I placed two dozen of ants (one dozen workers and one dozen nurses) in two separate nests, No. 4 and No. 5. With No. 4 I placed a few larvae with a few rose petals for them to manipulate. With No. 5 I gave a small piece of nest covered with mycelium. On the 16th these nests were destroyed by small foraging ants, known as the 'sugar' or 'meat' ant, and I had to remove them and replace with a new colony. My notes on these are not sufficiently lengthy to be of much importance. But I noted four eggs laid on the 16th, or two days after being placed in their new quarters; no queen being present. The experiment is being continued. I may mention that in No. 4 nest, in which no fungus was present, the larvæ of all sizes appeared to change into the pupæ stage at once for want of food (a fact corresponding with the fact I have named as observed by myself sixty years ago in the case of wasp larvæ). The circumstance tends to show that the development of the insect is influenced entirely by the feeding it gets in the larvæ stage.

In nest No. 2 before the introduction of a queen there were no eggs or larvæ. The first worker was hatched on October 27, or fifty-seven days afterwards, and a continual succession has since been maintained, but as yet (November 19) no males or queens have made their appearance.

In a letter accompanying the report, Mr. Hart says:—

"Since these were published, my notes go to prove that ants can aperiodically manufacture at will; male, female, soldier, worker, or nurse. Some of the workers are capable of laying eggs, and from these can be produced all the various forms as well as from a queen's egg.

There is, I find, however, appear to be any difference in the character of the food; as I cannot find that the larger larvæ are fed with anything different to that given to the smaller."

These results were obtained before the recent discussion of the question commenced, and as they agree with the results reached by Gray in the case of the *Termite*, it can now scarcely be doubted that the various forms or classes among the social insects are wholly determined by the treatment of the larvæ.

S. LEONARDI, Dilemmer 2. HERBERT SPENCER.

"Acquired Characters."

I do not think we are in any way bound by the terms of the law enunciated by Lamarck. Those laws may be shown to be erroneous in all but the suggestion of a principle which may possibly be developed into an important and far-reaching doctrine, and if so the importance of the doctrine will be in no wise diminished by the error of the early suggestion. There is scarcely any scientific generalization which does not require a amended enunciation in each generation if it is to be in accordance with the contemporary state of knowledge. Nevertheless it seems to me that the general law of Lamarck does not state that a character acquired by individuals *per se* is inherited, or "alters the potential character of the species." The law states that nature preserves by generation what has been acquired by individuals by the influence of the circumstances to which *they* have been long exposed, and by the influence of the circumstances to which they alone have been exposed in their own individual existences.

Leaving Lamarck's laws and doctrines entirely out of the question, if we define an acquired character as one which is determined by the "operation on the individual of given and

related quantities of external agencies," I am not aware that anyone has ever asserted that such a character is inherited, in the sense of being completely reproduced in the offspring without the operation of those external agencies. But I think there is reason to believe that if the same quantity of external agency acts on successive generations, it will produce more effect on the second than on the first, or, to use more correct language, that the effect in the second generation will be increased by a potentiality derived from the first. It is argued that the very possibility of the acquisition of new characters by the individual under new conditions is a proof that the old character had not become fixed and congenital after the action of the old condition on thousands of successive generations. But this is an illustration of the difficulty of completely expressing the problem in abstract language without reference to particular cases. If we consider the case of the pigmentation of the skin of the flounder, we find experimentally that exposure to light of the lower side for some years produces some pigmentation, but not so much as that on the upper side exposed in the individual for the same time. The action on the two sides in the individual being thus equal, or even greater on the lower side, how are we to account for the difference in favour of the upper? Evidently the congenital potentiality of the two sides is different. The old character has then become fixed and congenital to a certain very important degree. If no effect were produced by the action of light on the lower side of the individual, there would be no evidence that the congenital difference in the two sides had been produced by the difference in the relation to light repeated in countless successive generations. On the other hand, if the equal exposure of both sides produced equal pigmentation in the same time, this would be evidence that the difference in the pigmentation under normal conditions was not a congenital character at all. But as the facts stand, the only conclusion which is in accordance with them is that the congenital difference between the two sides is due to the gradual accumulation of slight effects on the congenital potentiality of the germ consequent upon the action of light in the individual. I could mention many other similar instances, which I think do constitute a reason for "associating the somewhat superficial and late responses of the parts of a growing individual to normal or abnormal forces of its environment with that more subtle and profound disturbance which is permanent and affects the potential character of the germ."

I am far, however, from supposing that all specific, generic, or morphological characters are due to the direct action of the environment in the same, and equally far from admitting that every one of these characters has a part to play in the struggle for existence.

J. T. CUNNINGHAM.

Plymouth, November 30.

THE distinction between the "acquired characters" of Lamarck and the other "responsive characters" which follow the "influence of the normal environment" is, I venture to think, not very important. The two kinds of characters are indeed admitted by Prof. Lankester to be "of the same order," and their essential unity is clearly shown when we attempt to trace the history of evolution as Lamarck conceived it.

The first increase in length of the neck of the giraffe or swan was no doubt, according to Lamarck, "an acquisition under the conditions of *new* character." But when the process had started, its subsequent stages could hardly be spoken of in this way. The effort of stretching, which was supposed to supply the condition for further increase, was then neither "new" nor "special and abnormal."

In the numerous discussions of the last seven years the term "acquired" has been employed to cover both classes of characters, and, indeed, the argument has chiefly turned on the effect of normal rather than abnormal and special conditions, because the evidence supplied by the former for or against hereditary transmission was so much more convincing than that supplied by the latter.

Although the term "acquired" is an unfortunate one, and has added many difficulties and obscurities which would have been avoided by the substitution of Prof. Lankester's term, "responsive," I think it would only increase the difficulties if it were now authoritatively maintained that, although the majority of instances discussed and the really crucial cases adduced are "of the same order" as acquired characters, they must no longer be called by this name.

I entirely agree with Prof. Lankester as to the mutual anta-

gonism between the two laws of Lamarck. The first law assumes that a past history of indefinite duration is powerless to create a bias by which the present can be controlled; while the second assumes that the brief history of the present can readily raise a bias to control the future.

EDWARD B. POULTON.

Oxford, December 2.

The Homing of Limpets.

IN NATURE, vol. xxxi. p. 200, Prof. Ainsworth Davis describes some observations he had made on the habits of the limpet. Marked individuals were taken to return from their excursions, extending to a distance of some three feet, and to settle down on the spot which is their permanent home. By excision of the tentacles in two individuals Prof. Davis was led to conclude that it is not by these organs that the limpet finds its way back to its own particular scar. "The sense of smell then suggested itself, and it occurred to me," writes Prof. Davis, "that one reason why limpets kept on their scars when covered by the water was to prevent the scent being washed off. With a view to determine this, the space between a wandering limpet and its scar and the scar was carefully washed again and again with sea-water. In spite of this, the limpet in question readily found its way back again."

Last summer I had some opportunities of making observations at Mewps Bay, near Lulworth, in Dorsetshire. I trust that Prof. Davis will not consider a brief record of the results of these observations a case of unsportsmanlike poaching on his preserves.

The method I adopted was to remove the limpets from the rock and affix them at various distances from their scars. This can be done without difficulty or injury if one catches them as they are moving. But one must make sure that they are just leaving or returning to their own proper homes, and are not taken in the midst of a more extended peregrination, as in that case their special scars cannot be noted. Failure to be careful in this matter vitiated my earlier observations, which are therefore excluded in the following table:—

No. removed.	Distance in inches.	No. returned.		
		In 2 tides.	In 4 tides.	Later.
25	6	21	—	—
21	12	13	5	—
21	18	10	6	2
36	24	1	1	3

From the nature of the strata the removal to a distance of 12 inches or more generally involved taking the limpets over a corner of rock.

In most cases the individuals which failed to return to their respective scars took up new positions. In several cases when they were removed to a distance of a few inches from this new position they returned to it. In one case where the limpet had taken up such a new position it returned thereto after having been removed to its original scar.

Observation of the limpets without such experimental removal shows that they make their excursions in search of food chiefly as the tide leaves them and when it is returning. They generally seem to get back to the scar before the tide has well covered it. I have watched them return over considerable distances. In one case ten inches, over a somewhat curved course, was covered in a little under twenty minutes. In another case the limpet on its return journey had to pass between two other limpets, which necessitated the lifting of the shell to some height so as to pass over one of these. On reaching their scar they twist and turn about so as to fit down. When they come wrong way round they rotate pretty rapidly through the 180° to get into position. The final position on the scar is a constant one. One was observed to make a short excursion from and to return to its scar under stillish water. As a rule they seem to remain fixed under water.

The greatest distance I have watched a limpet reach from its scar was 22 inches. But I have found limpets at a distance of 3 feet from their scars—that is to say, from scars on to which they fitted perfectly. This was on a large flat surface.

When they move, the tentacles are projected out beyond the shell, and keep on touching and slightly adhering to the rock. On reaching the scar they carefully feel round it with the tentacles. I am disposed to question the results of Prof. Davis's experiments on the removal of the tentacles. But further

observations and experiments are needed to settle the point. I understand that Prof. Davis is now at work upon the subject.

An injury to the edge of the shell seems to be repaired with whitish shell-material in the course of about ten days. And when a new position is taken up to which the shape of the shell is not suited, there appears to be a tendency for the shell to accommodate itself to the uneven surface of new growth along the edges. But this again is a matter on which further observation and experiment are required.

C. LLOYD MORGAN.

Gravitation.

THE nature of my suggestion (*vide* NATURE November 15, p. 57) is simply this:—A phenomenon of adhesion between solids immersed in a tensile liquid presents itself. The explanation offered (as I understand it) suggests that whether the bodies are attracted at long or short distances, will be a question entirely of the extension in the stressed medium of the modified layer. If this explanation be a correct one, or if any explanation involving a reaction between a modified layer (whether condensed or rarefied) and a *tensile* liquid will account for the phenomenon, then I say the experiment is a suggestive one as regards gravitation.

How far the modified layer will extend depends upon the law according to which the stress is distributed in the medium. In the case of matter acting upon matter at molecular distances we have reason to believe that the decrement of the stress is a rapid one. We possess no such knowledge when matter and ether alone are involved, and until we know how a modification of the ether around matter would display itself to our observation, I do not think the possibility of a remotely extended modification can be denied. Gravitation might be the sole resultant phenomenon affecting our senses.

J. JOLY.

Trinity College, Dublin.

The Ratio of the Specific Heats of Gases.

I REMEMBER that in the discussion of eighteen years ago it was understood that you could get 1.4 for the ratio, if the molecules had each five degrees of freedom only—if they were, for instance, perfectly smooth, elastic spheroids. Probably the ultimate source of our knowledge in this respect was Boltzmann's paper, to which Mr. Bryan refers us. The difficulty at the time seemed to be mainly one of faith. One could not believe that the molecules were solid elastic bodies, however useful the discussion of such bodies might be in defining a limiting case. As the white posts along a road are put to show you where you should not go, not where you should go. It was further supposed, perhaps without sufficient reason, that the phenomena of the spectroscope required us to attribute many degrees of freedom to the molecules.

I hope Mr. Bryan will, as I have no doubt he can, develop his theory that all these phenomena can be accounted for by the electromagnetic theory of light, without attributing to the molecules more than five degrees of freedom. We have to explain, as it seems to me, how the ether will assume different sets of vibrations according to the shape of the bodies in contact with it.

S. H. BURBURY.

1 New Square, Lincoln's Inn.

An Observation on Moths.

I THINK Dr. L. C. Jones (No. 1308, p. 79) has missed the true reason of the unexpanding wings of his moths liberated from the pupa-case before the struggles of the inmate had split the skin, and freed them in the ordinary course.

What was missing to them was the pressure in the act of emergence, which at one and the same time expels a discharge of superfluous humours from the abdomen, and forces the vital fluids through the folded and crumpled wings. Special extra provision is made for this, in the flask-shaped cocoons of *Saturia Pavonia minor*, for example, and if the pupa be taken out of this, and allowed to emerge at full maturity, it is always an abortion with heavy, overloaded abdomen, and wings that never expand. Every collector, also, who has bred the earth-burying sphinxes—*Sphinx Ligustici*, for example—knows how often they emerge in this condition, either through not being supplied with soil of the needful tenacity, or from the difficulty of keeping it of the natural degree of moisture.

It was the same that the straggles...  
 we n... ing in the after vig...  
 the part of the English grass-snake...  
 English... 5, November 27.

**Snakes "Playing" Possum.**

In connection with Dr. L. C. Jones' account last week of a falling Alder that reigned death, it may be of interest to note that on several occasions I have observed similar behaviour on the part of the English grass-snake (*Crotalus*). On finding escape impossible the animal will roll slightly over, with its mouth open to its widest extent, and its tongue protruded, and remain perfectly limp and flaccid, allowing itself to be struck, moved, and even carried in the hand with the head and tail dangling down on opposite sides, without showing any signs of animation. So sudden is the change from activity to quiescence, and so admirable the imitation of lifelessness that

**VOLCANIC STALACTITES.**

A CURIOUS formation is described by Mr. E. Goldsmith in the *Proceedings* of the Philadelphia Academy of Natural Sciences (part i. 1894, p. 107). It is well known that the highly heated and very fluid lava in the Kilauea crater at Hawaii, as well as in other craters, is occasionally shot up into the air some thirty feet or more. This lava in its descent through the air becomes very porous. If such a highly porous rock have a space underneath, a fresh deposit of liquid lava will trickle through the porous cooled lava, forming as it solidifies the pendant stalactites shown in the accompanying picture, which illustrates Mr. Goldsmith's paper, and has been kindly sent to us by the Academy. The figure represents the entrance to a volcanic cave, photographed by Profs. Sharp and Libbey. It shows an overhanging roof of porous basalt, from which are sus-

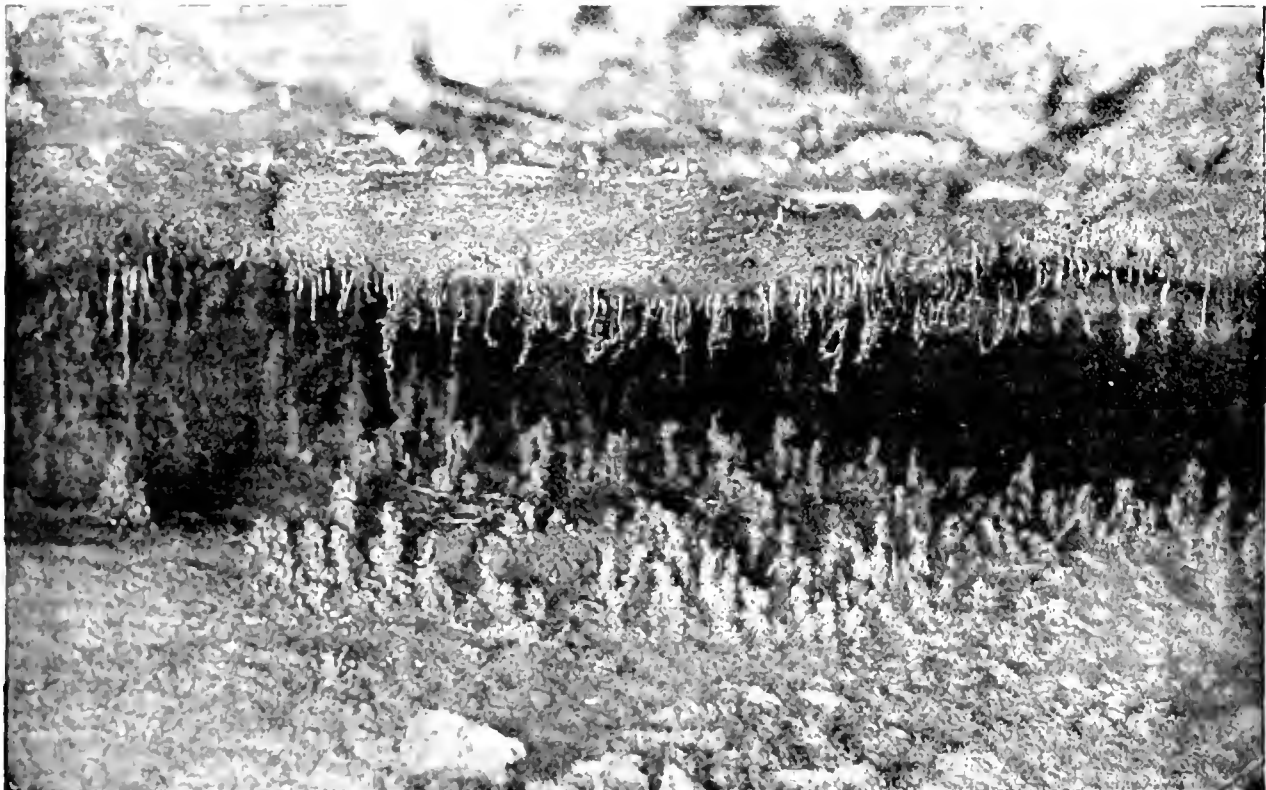

Fig. 1.—Volcanic Stalactites and Stalagmites.

...proved that on the first occasion which I witnessed it now many years ago, I observed the snake to have been seized by a species of bird and held at the point of death until, in a vain hope of alleviating its seemingly desperate condition, it plunged it into some pool of water, with the happy result of meeting an immediate respite, and, possibly, probably thinking it had been cured, it never was seen more free. I have since, however, at several times, the symptoms have persisted after the application of the same water cure. Subsequently I observed that to treat a snake in this way was necessary, as the bird would "come to" after a while, and then after a while.

At a point which I could not be very certain of, I was certain whether the snake was... for protection... the same with... as the... by the... which would... an alga...

pended irregularly gnarled rods of volcanic stalactites; on the floor are scattered fantastic-shaped volcanic stalagmites, which seem to be much thicker than the pendant rods above. Mr. Goldsmith says that the stalactites are about one-fourth of an inch thick, and about eight inches long. They show no disposition to form cones like those seen in limestone caves. They are mostly hollow and porous, and very brittle. The colour is usually a deep black, but sometimes a part is of a brownish tint, due, Mr. Goldsmith thinks, to a higher oxidation of the magnetite present. Fragments of the stalactites, when microscopically examined, exhibited a glassy texture having apparently the characteristic of sandstone. Magnetite occurred in great profusion, and also gases, probably ammonia. Augite was suspected, but not identified, determined. The specific gravity of a coarse

powder produced from the stalactites was found to be 2.85. The lava is decidedly basic, as the quantity of silica determined analytically was 48.55 per cent. On some of the stalactites a thin layer of colourless crystals were recognised under the microscope. An examination of these incrusting crystals proved them to be selenite.

## NOTES.

WE are pleased to note that the Court of the Salters' Company have placed at the disposal of the City and Guilds of London Institute a grant of £150 a year, for founding one or more Fellowships for the encouragement of higher research in chemistry in its relation to manufactures. The Fellowships will be awarded by the Executive Committee of the Institute, and the amount of the grant attached to each will be determined by the Committee, with reference to the nature of the research, the time required to complete it, and the merits of the candidate. The Executive Committee will each year apply the sum provided by the Salters' Company to the award of Fellowships to students of the Institute who have completed a full three-years' course of instruction in the chemical department of the Central Technical College, or (b) to candidates duly qualified in the methods of chemical research in its relation to manufactures, without restriction as to age or place of previous study. A Fellowship may be renewed for a second and third year, but cannot be held by anyone for more than three years. The holders of the Fellowships will be required to devote their whole time to the prosecution of research, unless otherwise sanctioned by the Executive Committee. The researches will be carried out at the Institute's Central Technical College. Applications for Fellowships should be made in writing addressed to the Honorary Secretary of the Institute, Gresham College, Basinghall Street, London, E.C., and should state the nature of the research proposed to be undertaken, and the qualifications of the candidate. The first award will be made early in the new year.

WE notice with deep regret that Sir Charles T. Newton, K.C.B., the eminent archaeologist, died on November 28.

COMMUNICATION by telephone between Vienna and Berlin has just been opened. The length of the line is 410 miles.

DR. S. NAWASCHIN has been appointed Professor of Botany and Director of the Botanic Garden at the University of Kiev; and Dr. K. Schillersky Professor of Botany and Vegetable Pathology at the Hungarian Agricultural Institute, Buda-Pesth.

THE editorship of the *Jahrbücher für wissenschaftliche Botanik*, vacant by the death of Dr. Pringsheim, has been accepted by Prof. Pfeffer, of Leipzig, and Prof. Strasburger, of Bonn. All communications should be addressed to the former of these. The *Jahrbücher* have been edited by Dr. Pringsheim since their commencement in 1857, and contain many important contributions to structural and physiological botany.

DR. PHILIP LENARD, who was the late Prof. Hertz's assistant and *privat-docent* at the University of Bonn, has recently been appointed Extraordinary Professor of Physics in the University of Breslau. He has published a number of important investigations on cathode rays, phosphorescence, electrification of water-drops, and kindred subjects.

THE Council of the British Institute of Public Health, realising the great and general interest which is at the present time taken in the question of the anti-toxic serum treatment of diphtheria, have made arrangements for a lecture to be given in the Examination Hall of the Royal Colleges of

Physicians and Surgeons, Victoria Embankment, on Friday, December 7, at 5 p.m. by Dr. G. Sims Woodhead, entitled "The Diagnosis and Anti-toxic Treatment of Diphtheria."

THE second series of lectures given by the Sunday Lecture Society begins on Sunday afternoon, December 9, in St. George's Hall, Langham Place, at 4 p.m., when Mr. E. Neville Rolfe will lecture on "The Buried Cities of Campania." Lectures will be subsequently given by Mr. Wyke Bayliss, Prof. Marshall Ward, F.R.S., Prof. Vivian B. Lewes, Mr. Oswald Brown, Mr. Arthur Clayden, and Mr. Jas. Craven.

THE following lecture arrangements have been made at the Royal Institution: Prof. J. A. Fleming, F.R.S., six lectures (adapted to a juvenile auditory) on the work of an electric current; Prof. Charles Stewart, twelve lectures on the internal framework of plants and animals; Mr. L. Fletcher, F.R.S., three lectures on meteorites; Dr. E. B. Tylor, F.R.S., two lectures on animism; Lord Rayleigh will also deliver six lectures. The Friday evening meetings will commence on January 18, when Prof. Dewar will deliver a discourse on phosphorescence and photographic action at the temperature of boiling liquid air. Succeeding discourses will probably be given by Sir Colin Scott-Moncrieff, Dr. G. Sims Woodhead, Mr. Clinton T. Dent, Prof. A. Schuster, Prof. A. W. Rucker, Prof. Roberts-Austen, Prof. H. E. Armstrong, and Lord Rayleigh, among others.

DR. PATTERSON, in a lecture before the Piscatorial Society, at the Holborn Restaurant this week, entitled "Salmon, Sea-trout, and Trout—What are they?" maintained that they were all varieties of one species, varying according to their environments. On the same evening an exhibition of this year's specimen fish was held by this Society in their museum at the Holborn.

AT a meeting held at the Borough Road Polytechnic, on November 23, a London branch of the Conchological Society of Great Britain and Ireland was formed. It is thought that such a branch, with monthly meetings for discussion, for exhibition, and for exchange, cannot fail to be of advantage. The branch will in no way be a rival of the Malacological Society, but probably a feeder to it. The first ordinary meeting will be held on Thursday, January 10, 1895, at 7 p.m., in a room lent by the Governors of the Borough Road Polytechnic. The attendance of any conchologists in or near London will be welcomed at this meeting.

DURING the past few years the American Museum of Natural History, situated in Central Park, New York City, has grown very considerably. It suffers from the common complaint, however, of not having sufficient funds to devote to the enlargement of the collections, and this in a city where millionaires most do congregate. The report of the operations of the Institution last year shows that the opening of the museum on Sundays is greatly appreciated. Many important additions have been made to the various collections, the most noteworthy accessions being in the department of mammalian palæontology. Although only in the third year of its establishment, the collections in this department already equal in importance those secured by other institutions through many years of effort. The intention is to form a great collection to represent the evolution of the mammals of North America. Thus far the expeditions to the Rocky Mountain region have secured nearly one thousand five hundred specimens. Fifteen perfect skulls have been obtained from the Bridger Basin, Wyoming. The remains of monkeys, horses, tapirs, primitive rhinoceroses and rodents have also been obtained by the explorations under Dr. J. L. Wortman, and many of them are in an excellent state of preservation. The most notable specimen in the collection is a complete

skeleton of a large Carnivore of the size of a tiger, and is said to be the most perfect specimen of the kind ever found. The total number of volumes in the library now exceeds twenty-eight thousand. We sincerely hope that the citizens of New York will see that the usefulness of the Institution is not limited by the lack of means to acquire new and important material, and to provide proper accommodation for it. They must surely recognise that, even from a commercial point of view, the museum is of the highest value.

In connection with our note last week, on the wreck of the *Finn*, the steamer of the Peary expedition, and the loss of all on board, it ought to have been stated that the vessel, after landing the returning members of Mr. Peary's party, had sailed from St. John's with a cargo of coal, and that none of the exploring party, whose charter of the vessel terminated on their landing, were on board.

In the *Geographical Journal* for December, Captain Mockler Ferryman describes and illustrates the glacier lake known as the Dæmme Vand, near the Hardanger Fiord, in Norway. The Rembesdal glacier at the head of the Simodal, stretches across and dams up a lateral valley in which the lake in question is formed. When during summer the ice-barrier gives way, as it occasionally does, floods of the most disastrous kind are produced in the Simodal. The Norwegian Government has determined to construct a tunnel through the rocks at the mouth of the lateral valley, through which the surplus water of the Dæmme Vand may be harmlessly drained when the level rises to a dangerous height.

CHEMICAL laboratories can now dispense with the wasteful and unpleasant installation for generating sulphuretted hydrogen, for we learn from *Industries and Iron* that liquid sulphuretted hydrogen is commercially obtainable. Although this gas is easily liquefied, the difficulties of manufacture in large quantities at an economic rate have prevented its introduction as a laboratory reagent. Messrs. Baird and Tatlock, who are the sole agents for this commodity, supply the liquid compressed into specially-prepared steel cylinders, each containing one pound of liquid, equal to about eleven cubic feet of gas at atmospheric pressure. Larger cylinders can also be had. In this compressed form, the gas has the advantage of being cleanly and always ready for use, and in those laboratories in which it is only occasionally required as a reagent, a cylinder ought to be included in the laboratory stock. Our contemporary announces that the same firm is about to place liquid chlorine and ethylene on the market.

FOR collections of Coleopterous, Lepidopterous and other insects, the nature of the pin for fastening the specimens is a question of great importance. Ordinary pins of brass, even though well tinned, frequently oxidise in the body of the insect, and eventually destroy the specimen. Black varnished pins are almost as bad, for the varnish soon cracks, leaving the metal exposed. Even plated pins do not appear to resist the action of the compounds developed in the body of the insect, though solid silver ones will. Dr. H. G. Knaggs introduced a bronze pin which has found favour among many entomologists; nevertheless, it is far from being a perfect fastener. In the December number of the *Entomologist's Monthly Magazine*, he drew attention to a pin made from a nickel alloy by Messrs. Deyrolle, of Paris. This pin possesses great advantages over those generally used, and of which the metal basis is brass. It will probably be widely used by collectors, for its price need only be a little higher than that of an ordinary pin.

THAT the efficiency of acoustic fog signals for purposes of navigation is as yet very doubtful, may be seen from a discussion appearing in *Hull's*. There are many peculiarities in

the behaviour of sound, propagated over the surface of the sea from the coast, which require further scientific investigation. Mr. Arnold B. Johnson, author of "The Modern Lighthouse Service," gives it as a general rule, that in proceeding from the neighbourhood of the fog-signal apparatus out into the sea for about two miles a zone is entered in which the signal becomes inaudible. This zone has a width varying from one mile to a mile and a half. That this phenomenon is not confined to coast stations is evident from the fact that it was observed in the case of a station situated on a rock twenty miles from the nearest land. Several such zones are often produced when a steep cliff lies at the back of the signal station. The observations made on the coast of New England are fully borne out by those made at the mouths of the Elbe and Weser. Among the pilots of the German coast it is well known that the sound rockets fired on Heligoland are heard at distances sometimes exceeding twenty miles, become inaudible on approaching the island, and reappear in the immediate neighbourhood of the island. An altogether unexplained and apparently undiscussed phenomenon is that noticed in a specially marked manner in the fog-horn of the Weser lightship. When the sound commences it appears to proceed from a direction entirely different from that in which it dies away.

A SERIES of *Bulletins* of the Madras Government Museum has been commenced by the superintendent, Mr. Edgar Thurston; and parts i. and ii., which have reached this country, contain much useful information upon the fisheries and marine zoology of the Presidency. Part i. contains a revised account of the superintendent's "Notes on the Pearl and Shank Fisheries of the Gulf of Manar," and its subject matter is already known in great part to British students of "applied zoology." Part ii., entitled "Note on Tours along the Malabar Coast," records a number of interesting observations in marine zoology made on the west coast of Madras. It is instructive to note that even there the natives have their fishery question. It is stated that formerly the sardines of the coast always arrived regularly, and remained throughout the season; and the fishermen's belief is that they are at the present day frightened away by the numerous steamers which call at Cochin, and retire in search of a less disturbed spot. In addition to steamboat traffic; noises in boats, ringing church bells, artillery practice, the erection of lighthouses, gutting fish at sea, using fish as manure, burning kelp, and the wickedness of the people, have been charged with being responsible for a falling off of the fish supply; but, as Mr. C. E. Fryer has naively remarked, "of these alleged causes only the last, it is to be feared, has been, and is likely to be, a permanent factor in the case."

We have received from the Rev. S. Chevalier, the second report of the Shanghai Meteorological Society. This number is entirely devoted to a notice of the typhoons of the year 1893, and a final chapter on the general tracks of the typhoons in the Chinese seas. The discussion of each storm is accompanied by diagrams showing the position of the centre at various dates; several examples reported in the present work show that the bearing of the centre coincides with the direction of the swell of the sea, but further observations on that special point are required. The tracks of the typhoons have been classed (1) according to the times of their occurrence, and (2) according to the countries which they visit. The first month of the typhoon season is May, but the storms are of rare occurrence before July; it is noticeable that they originate in different positions, and take somewhat different routes in different months. From the middle of September the typhoons do not reach Shanghai, but they occur further south for some months later. In dividing them according to localities, Father Chevalier distinguishes three classes, viz. Japan typhoons, China, and Cochin China typhoons.



THE *Report* of the Botanical Exchange Club of the British Isles for 1893, just received, contains a number of useful and interesting notes on critical and rare British species, the general *Rubus*, *Hieracium*, and *Potamogeton* coming in for a specially large share of attention. It is edited by Mr. Jas. Groves.

THE results of the meteorological observations made at the United States Naval Observatory during 1889, and the magnetic observations made at the same observatory during 1892, have just reached us. It would be to the advantage of science if the observations could be published without such a long delay.

THE twenty-first annual report of the Geological and Natural History Survey of Minnesota has been received. It embraces statements relating to progress in the strictly geological portion of the Survey. Independent reports will be published upon the botanical and zoological departments of the work.

THE December number of the *Geological Magazine* contains an account of the life and work of the late Mr. William Topley, F.R.S., written by Mr. H. B. Woodward, and accompanied by a portrait of the deceased geologist. The memoir is a tribute to a life of unremitting labour in the cause of geology, and an expression of the high regard in which Mr. Topley is held by all who cherish his memory.

THE *Geographical Journal* this month gives prominence to a new feature in the way of short summaries of the most recent and trustworthy literature on parts of the world where public interest is concentrated for the time. The regions dealt with are the Waziri country and Madagascar, and in addition there are two special papers of considerable length on Eastern Asia—one by Mr. A. R. Agassiz, on the commercial resources of Manchuria; the other by Baron von Richthofen, on China, Japan, and Korea.

HERETO Brehm's well-known collection of works on natural history, in the *Merveilles de la Nature* series, published by M. J. B. Baillière et Fils, Paris, has not comprised a volume on botany. This gap is now, however, to be filled by "*Le Monde des Plantes*," of which the first part has just appeared. The author of the work is Prof. Paul Constantin. There will be eight fasciculi altogether. When the work is completed its two volumes will run into fifteen hundred pages, and be embellished by two thousand illustrations. Particular attention is paid to the use of plants for food, and in medicine, industries, agriculture, and horticulture. The biological characters are also carefully treated. The work promises to be the best popular botanical work published in France, and therefore fittingly finds a place in Brehm's series on the wonders of nature.

MR. A. S. GHOSH has sent us a slender little pamphlet on "*Pedal and Antipedal Triangles*," being an attempt to investigate the laws of their evolution. (Calcutta: Patrick Press, 1894.) The primitive triangle is considered as obtained from the pedal triangle, and is called its antipedal triangle; so that what is sometimes called the excentric triangle is the antipedal of the primitive triangle. The whole of the pamphlet, which is a fairly neat piece of work, is merely a solution *in extenso* of a "ten-minute conundrum."

WE have received the *Proceedings and Transactions* of the Royal Society of Canada, for the year 1892 (vol. x.). The volume contains six papers in the section of mathematical, physical, and chemical sciences. Among these we notice one on the Mexican type in the crystallisation of the topaz, and another on observations of sun-spots at the McGill College Observatory. The section of geological and biological sciences contains the presidential address on the diffusion and sequence of the Cambrian faunas; and, among others, papers on the artificial propa-

gation of marine food fishes and edible crustaceans, and on the correlation of early cretaceous floras in Canada and the United States.

At the inaugural meeting of the fourteenth session of the Institution of Junior Engineers, held on November 16, Mr. Alexander Siemens gave some wholesome advice to young engineers and inventors. In the course of his address, he dispelled the fable about the circumstances which led to the invention of the steam engine. According to the popular version, Watt, as a small boy, saw the lid of a tea-kettle move up and down, when the water was boiling, and this suggested to him the construction of the steam engine. As a matter of fact, Watt made himself acquainted with what had been done before (a point altogether ignored in the popular version), and had to work very hard before he brought his invention to a successful issue. His example is typical of the true method of progress, and it may be said generally, that in order to approach a problem with the best prospect of success, it is necessary (1) to define, as accurately as possible, the want that exists, or the particular object that is to be attained; (2) to be well acquainted with the scientific principles which come into play; (3) to know how the want is met, or the object attained in practical life; (4) to find out what proposals have been made by others in the same or in a similar case. A careful attention to these requirements will prevent much disappointment and waste of energy. The records of the Patent Office show that one or more of these conditions is frequently ignored. A large class of inventors do not realise that a knowledge of scientific principles would be an assistance in their efforts; or if they study science at all, they think they can acquire the necessary knowledge by a short study, and without much trouble.

A NOTE concerning the synthesis of the chlorides of carbon  $C_2Cl_4$  and  $C_2Cl_6$ , during the preparation of carbon tetrachloride by the chlorination of carbon disulphide at low temperatures, is communicated to the *Berichte* by Prof. Victor Meyer. It is a well-known fact that at a red heat the vapour of carbon tetrachloride is dissociated, a portion of the chlorine being liberated and the two chlorides above mentioned being produced. It now appears that this change occurs to some extent at temperatures but slightly elevated above the ordinary. At the chemical works of Messrs. Muller and Dubois, near Mannheim, carbon tetrachloride is manufactured in large quantities by the chlorination of carbon disulphide at temperatures between  $20^\circ$  and  $40^\circ$ . Each operation is allowed to proceed for several days, and the completion is indicated when the liquid has become deeply coloured owing to the formation of sulphur dichloride,  $S_2Cl_2$ . The carbon tetrachloride is then distilled off, leaving the chloride of sulphur behind. Upon rectification of the carbon tetrachloride a quantity of a higher boiling oil is obtained, the nature of which Prof. Meyer has investigated. Upon fractionation it separates into three constituents, carbon tetrachloride  $CCl_4$ , the liquid chloride analogous to ethylene  $C_2Cl_4$ , and the solid chloride  $C_2Cl_6$ , the so-called perchlorethane. Excellent crystals of the latter compound are at once obtained practically pure. That a real synthesis of these two latter compounds occurs during the manufacture of carbon tetrachloride at so low a temperature as  $20^\circ$ - $40^\circ$ , is proved by the fact that the carbon disulphide employed is found to be quite pure, except for a mere trace of dissolved free sulphur. Prof. Meyer considers that the two chlorides are produced in accordance with the equations:

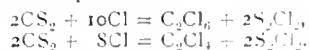

THE atomic weight of bismuth has been re-determined by Prof. Schneider, of Berlin, and the result is remarkable as once more affording exactly a whole number, 208, as the relative weight of

an elementary atom compared with the atom of hydrogen. The relative weight of this particularly heavy atom was determined so long as forty-three years ago by Prof. Schneider, and the value obtained was identical with that which is now afforded. Eight years after Prof. Schneider's first determination, Dumas published the results of a number of atomic weight determinations, among them being that of bismuth, to which he assigned the value 210. From that time, 1850, until 1883, Dumas' value came to be generally accepted, although no doubt his method was by no means so little open to objection as that employed by Prof. Schneider. However, in 1883 Marignac took up the subject, and as the result of determinations carried out with the thoroughness for which he was remarkable, the number 208.16 was obtained, thus substantiating the work of Prof. Schneider. More recently Classen has obtained a higher result, 208.9, by an electrolytic method, and Prof. Schneider has undertaken a further series of determinations with the view of testing certain suggestions of Prof. Classen regarding possibility of error in his former estimations. The method is based upon a comparison of the equivalent relation of metallic bismuth to bismuth trioxide. The final result obtained, if  $O = 16$ , is 208.05, and the greatest divergence from this number among the whole of the individual values is only 0.21. Prof. Schneider's original work, and likewise that of Marignac, is thus confirmed, and bismuth must now be added to the rapidly growing list of elements whose atomic weights are represented by whole numbers.

THE ADICTIONS to the Zoological Society's Gardens during the past week include a Sykes' Monkey (*Cercopithecus albigularis*, ?) from West Africa, presented by Mr. J. H. Prestwich; a Mozambique Monkey (*Cercopithecus pygmylorus*, ?) from East Africa, presented by Mr. C. O. Gridley; a Leopard (*Felis pardus*) from Southern India, presented by Mr. John Christie; two Spotted Eagle Owls (*Bubo maculosa*) from South Africa, presented by Mr. R. A. Langford; an Antipodes Island Parakeet (*Cyanorhamphus unicolor*) from Antipodes Island, seven South Island Thrushes *Turdus crassirostris* from South Island, New Zealand, presented by Sir Walter L. Buller; two Canary Finches (*Serinus canarius*), four — Frogs *Lana*, sp. inc. from Madeira, four Dwarf Chameleons, *Chamaeleon famulus* from South Africa, presented by Mr. H. Benelack; a Rhomb-marked Snake (*Pseustes rhombatus*) from South Africa, presented by Mr. J. E. Matcham; an Arctic Fox (*Canis laicus*) from the Arctic Regions, purchased; four Niterackers *Nucifraga cygneata*, European, purchased; sixteen Deally Snakes (*Trochophyllus atrus*), born in the Gardens.

OUR ASTRONOMICAL COLUMN.

THE NEW COMET.—The comet of which the discovery was announced in the last number of NATURE is likely to prove a very interesting object. A communication from Prof. Kraeger informs us that Dr. Berberich, who is probably in possession of ephemerides of the best comets depending on various dates of perihelion passage, has noticed the coincidence in the position of this comet at the first observation with that which De Vico's comet of 1844 can assume. It will be remembered that it was this same astronomer who conjectured from somewhat similar grounds the identity of Holmes' comet with that of Biela. But the conjecture in this case seems to be better founded, for elements computed by Dr. Feuschner show a decided similarity with those of De Vico, as computed by the late Dr. Brunnow from the 1844 observations. Seeing that the comet has undergone some fifty years' perturbations since that time, and that the present elements are founded on the observations of but three consecutive days, and can only be considered as roughly approximate, we must be prepared for some considerable deviation.

	Leuschner's elements of Swift's comet.	Brunnow's elements of De Vico's comet.
Long. of perihelion	201 48 ...	342 30
„ nodes	43 4 ...	03 40
Inclination ...	3 16 ...	2 55
Minimum distance	1.4703 ...	1.1864

De Vico's comet has not been seen since 1844, though, with a period of approximately five and a half years, nine returns have occurred, and when the perihelia fall in the autumn, the comet is fairly favourable for observation. There is extant, it is true, an observation of a nebula by Goldschmidt in May 1855, which he thought might have reference to the comet, but Brunnow could not reconcile it with the computed path, and it is usually believed that the comet disappeared after observation in 1844. But Le Verrier and Brunnow both thought that the comet of 1678 was identical with that of 1844, and if this be the case it would seem that the comet might be subject to fluctuations of brilliancy, which would explain the fact of its passage through perihelion without notice.

Further, a similarity between the elements of Finlay (1886 VII.) and De Vico has been noticed, and the agreement between those of the present comet and Finlay's is probably more marked than with De Vico. Tisserand's well-known criterion of identity does not favour the supposition that De Vico and Finlay are one and the same comet, since a very considerable perturbative effect would have to be attributed to the action of Mars. It would seem, therefore, more probable that several comets are moving in approximately the same orbits than that we have to do with the actual return of a comet lost for so long a period as De Vico's. But under any circumstances, seeing that the comet is diminishing in brilliancy, it is of the utmost importance to secure observations as early and as long as possible, since upon the accurate determination of the orbit several important questions may finally rest. The following positions are given in the ephemeris received from Kiel:—

	R.A.			Decl.	
	h	m	s.	°	'
Dec. 6	23	2	52 ...	7	50.9
„ 7	23	5	40 ...	7	31.1

THE SPECTRUM OF MARS.—Prof. W. W. Campbell has lately brought together all the observations of the spectrum of Mars, and discussed them in connection with the telluric spectrum and with his own observations made during the past summer. (*Publications of the Astronomical Society of the Pacific*, vol. vi. No. 37.) He concludes as follows:

(1) The spectra of Mars and the Moon, observed under favourable and identical circumstances, seem to be identical in every respect. The atmospheric and aqueous vapour bands which were observed in both spectra appear to be produced wholly by the elements of the Earth's atmosphere. The observations, therefore, furnish no evidence whatever of a Martian atmosphere containing aqueous vapour.

(2) The observations do not prove that Mars has no atmosphere similar to our own; but they set a superior limit to the extent of such an atmosphere. Sunlight coming to the Earth via Mars passes twice either partially or completely through his atmosphere. If an increase of 25 to 50 per cent. in the thickness of our own atmosphere produces an appreciable effect, a possible Martian atmosphere one fourth as extensive as our own ought to be detected by the method employed.

(3) If Mars has an atmosphere of appreciable extent, its absorptive effect should be noticeable especially at the limb of the planet. Prof. Campbell's observations do not show an increased absorption at the limb. This portion of the investigation greatly strengthens the view that Mars has not an extensive atmosphere.

THE ANNIVERSARY MEETING OF THE ROYAL SOCIETY.

THE anniversary meeting of the Royal Society was held in the apartments of the Society at Burlington House on St. Andrew's Day, November 30. The auditors of the Treasurer's accounts having presented their report, the Secretary read the lists of Fellows elected and deceased since the last anniversary meeting. The qualification of the new Fellows on the home list were given in NATURE of May 17 (vol. i. p. 55). The new Fellows

on the foreign list are Henri Ernest Baillon, Henri Poincaré, and Eduard Suess. During the year, the Society lost eighteen Fellows and three Foreign Members.

II. R. 11. Louis Philippe d'Orleans, Count of Paris, September 8, 1894, aged 56.

John Tyndall, December 4, 1893, aged 73.

The Earl of Lovelace, December 29, 1893, aged 89.

Sir Samuel White Baker, December 30, 1893, aged 72.

Arthur Milnes Marshall, December 31, 1893, aged 41.

Pierre J. Van Beneden, January 8, 1894, aged 93.

William Pengelly, March 16, 1894, aged 82.

Lord Hannen, March 29, 1894, aged 73.

Dr. Charles Edouard Brown-Séquard, April 1, 1894, aged 77.

Lord Bowen, April 10, 1894, aged 58.

Brian Houghton Hodgson, May 23, 1894, aged 94.

George John Romanes, May 23, 1894, aged 46.

Lord Coleridge, June 5, 1894, aged 74.

Charles R. Alder Wright, July 25, 1894, aged 50.

Rev. William Bentinck Latham Hawkins, August 31, 1894, aged 83.

Admiral Sir Edward Augustus Ingfield, September 5, 1894, aged 74.

Hermann Ludwig Ferdinand von Helmholtz, September 8, 1894, aged 73.

Jean Charles Galissard de Marignac, September 15, 1894, aged 77.

William Topley, October 2, 1894, aged 53.

Lord Basing, October 23, 1894, aged 68.

Colonel R. Y. Armstrong, November 1, 1894, aged 55.

Lord Kelvin, the President, then delivered the Anniversary Address as follows:—

Science has lost severely during the past year. In the list of Fellows deceased, which I have read to you, you have heard the names of Tyndall, Milnes Marshall, Van Beneden, Pengelly, Brown-Séquard, Romanes, Alder Wright, Helmholtz, Marignac, Topley, all well known to you as having been in their lives zealous and successful scientific investigators, who have largely contributed to the object for which the Royal Society works, "The Increase of Natural Knowledge." Tyndall, full of fire and enthusiasm in solid experimental work advancing the boundaries of science, contributed largely, by his brilliant lectures and books, to make science popular, as it now is in England and America. By the sad death of Milnes Marshall on Scawfell, in Cumberland, on the last day of 1893, we lost a young, able, and enthusiastic worker in zoology. A few months later, we lost the veteran Pengelly, who did so much for geological science, and gave such delightful and valuable lessons to the larger world of not scientific geologists, in what he did in his exploration of Kent's Cavern, Torquay. Romanes, full of zeal, fighting to the end with the most difficult problems that have ever occupied the mind of man, and devoting his health and his wealth to promote not merely philosophical speculation but also the experimental research by which alone philosophy can have a foundation, left us at the early age of forty-six.

A year ago, in my anniversary address, I called your attention to Hertz's experimental demonstration of electric waves, which he found in working out an experimental problem originally proposed by Helmholtz to him when he was engaged in experimental researches in the Physical Institute of Berlin in 1879. An English translation by Jones, of Hertz's book describing his work on electric waves, dedicated "with gratitude" to Helmholtz, was published in England and America in December 1893. On the first day of the new year the disciple died, and within the year the master followed him. Of the whole of Helmholtz's great and splendid work in physiology, physics, and mathematics, I doubt whether any one man may be qualified to speak with the power which knowledge and understanding can give: but we can all appreciate, to some degree, the vast services which he has rendered to biology by the application of his mathematical genius and highly trained capacity for experimental research to physiological investigation.

In his interesting autobiographical sketch he tells us that his early natural inclination was for physics, which he found more attractive than purely geometrical and algebraic studies; but his father could only give him the opportunity of studying physics by his learning medicine to earn a livelihood, and he himself was by no means averse to thus entering on the study of living matter instead of confining himself to the physics of dead matter. I

think we may now feel that the world has gained largely by this early necessity for a young man of great genius and power to choose a practical profession.

One early result was his careful examination, while still a student, of the theory of animal heat, and a little later (1847) his great essay, "Ueber die Erhaltung der Kraft," Conservation of Energy as we now call it, communicated to the Society of Berlin on July 3 1847, of which he said in 1891. "My aim was merely to give a critical investigation and arrangement of the facts for the benefit of physiologists." As a student he had found that Stahl's theory, ascribing to every living body the possession of the property of "The Perpetual Motion" as an essence of its "vital force," was still held by most physiologists. His essay on the "Conservation of Energy," giving strong reasons for rejecting that theory, though looked upon, at first, by many of the physical and philosophical authorities of the time as a fantastic speculation, was enthusiastically welcomed by younger student philosophers, and must soon have convinced the elder men that, whatever may be the real efficiency of vitality, vast and wonderful as it is, it does not include the performance of work without drawing upon a source of energy. This conclusion had been virtually foreseen before the end of last century by Rumford and Davy, and had been clearly stated and powerfully supported by Joule and Mayer a few years before Helmholtz found it for himself and successfully persuaded others of its truth.

It is interesting for us now to know that, while thus contributing so effectively to the abandonment of the old doctrine that vital "force" can work without drawing on an external source of energy, Helmholtz was even more effectively concerned in the establishment of a new doctrine which has given a vast extension to the province of life previously perhaps undreamt of, but now universally recognised as thoroughly well established, and supremely important in modern physiology and medicine. On recovering from a typhus fever in the autumn of 1841, at the age of twenty, the last year of his undergraduate course in the Army Medical School of the Friedrich Wilhelm's Institute, he spent the accumulations of his income, which free treatment at the hospital during his illness had left him, in the purchase of a microscope, an instrument then but little used in medical education. He began immediately to use it, and made some important observations on the ganglion cells of invertebrates, which, at the suggestion of his master, Johannes Müller, he took as the subject of his inaugural thesis for the doctor's degree, in November 1842, and which was his first published work.<sup>1</sup> With the same microscope, he observed vibrios in putrefying liquids, which he described in his second published paper (1843). "On the Nature of Putrefaction and Fermentation." His distinguished comrade, Schwann, in the laboratory of Johannes Müller, had already shown that vegetable cells are present in fermenting solutions of sugar, and that air, which had been highly heated, was incapable of exciting the fermentation which the access of ordinary atmospheric air was known to produce. Helmholtz found that oxygen, yielded by the decomposition of water in flasks containing small pieces of boiled meat, did not produce putrefaction. Thus the doctrine, held perhaps by all before them, and certainly supported by the great Liebig, that putrefaction and fermentation are purely chemical processes of *cremation* (or slow combustion), produced by oxygen, was thoroughly disproved by the two young investigators. But Helmholtz went farther, and showed almost certainly that the actual presence of a living creature, vibrio, as he called it, bacterium, as we more commonly call it now, is necessary for either fermentation or putrefaction. He proved by experiment that a partition of moist bladder, between the yeast and the fermentable liquid, prevented the entrance of the vibrios which he had observed, and prevented the fermentation. It had been reasonably suggested that fermentation or putrefaction might be a purely chemical process produced by a quasi-chemical agent or poison secreted by a living organism; but Helmholtz's observation disproved this supposition almost certainly, because any such chemical substance in solution would pass by diffusion through the bladder, and produce its effect without any direct action of the living creatures. Although Helmholtz himself was characteristically philosophical and conscientious in not claiming, as absolutely proved, what he had only rendered probable, it is certain that this early work of his on putrefaction and fermentation constituted a very long step towards the great generalisa-

<sup>1</sup> Helmholtz's "Wissenschaftliche Abhandlungen," vol. ii. p. 166.

tion of Pasteur, adverse to spontaneous generation, and decisive in attributing to living creatures, born from previous living creatures, not only fermentation and putrefaction, but a vast array of the virulent diseases and blights, which had been most destructive to men, and the lower animals and crops and fruits. It is well that Helmholtz himself lived to see the great benefits conferred on mankind by Pasteur's work; and by the annulment of the deadliness of compound fractures and the abolition of hospital gangrene in virtue of Lister's antiseptic treatment; and by the sanitary defences against fevers and blights, realised by many other distinguished men as practical applications of the science which his own typhus fever of 1841 brought so much to create.

Close after his work on this subject and on animal heat, followed investigations on the velocity of transmission along the sensory nerves of the disturbance to which sensation is due, the time which the person perceiving the sensation takes to decide what to do in consequence, and the velocity of transmission of his orders along the motor nerves to the muscles which are to carry out his will. Results of the highest scientific interest and of large practical importance were given in two great papers published in 1850. This was followed a few years later by his "Tonempfindungen," a great work not merely confined to the perception of sound, but including mathematical and experimental investigations on the inanimate external influences concerned in sound, investigation of the anatomical structure of the ear in virtue of which it perceives sound, and applications to the philosophical foundation of the musical art; which holds a unique position in the literature of philosophy, and is certainly a splendid monument to the genius and indomitable working power of its author. Another great work of Helmholtz is his "Physiologische Optik"; who shall say which of the two books is the more important, the more interesting, or the more valuable? Each of them has all these qualities to a wonderful degree. Perhaps the most interesting of his experimental investigations in physiological optics was the measurements, by his ophthalmometer, of the curvatures of the several refracting surfaces constituting the lens system of the eye, from which he ascertained that it is almost altogether by changing the curvature of the front surface of the crystalline lens that the eye is accommodated by its possessor to vision at different distances. His ophthalmoscope, by which for the first time he himself saw and showed to others the retina of the living eye, was a splendid and precious contribution to medicine. By showing that outlying portion of the brain to be distinctly seen and examined, it has shown the cause of many illnesses which had been regarded as hopelessly obscure; and for diagnosis and guidance of medical treatment; it is now continually used not only by oculists, but by general practitioners.

Constrained as I feel not to overtax your patience, I find it impossible on the present occasion, to enter upon Helmholtz's work in mathematics and mathematical physics farther than to mention in his small but exquisite paper on anomalous dispersion, and the grand contribution to hydrodynamics which we have in his "Integrals of the Hydrodynamical Equations which express Vortex Motion."

Some four or five years ago, important questions regarding the rights of the Society in its meetings and the publication of papers, then the *Proceedings* and *Proceedings* of the Royal Society, have been engaged the attention of the Council, with the assistance of a committee appointed on July 5, 1893. The final report of this committee was submitted to the Council on August 1, 1894, when resolutions were adopted accepting some of the recommendations, and referring the consideration of others to a later date.

At the request of the Philosophical Society, a committee was appointed by the Council of the Royal Society to consider the advisability of asking the Government to undertake an Antarctic expedition. A very important and valuable part of the advantages which such an expedition would bring, to science and to the world in general, was presented by a committee to the Council on May 24. The Council, after careful consideration, resolved to ask the Lords of the Admiralty to grant an interview on this subject with representatives of the Royal Society. The request was assented to; an interview was accordingly held between the First Lord

of the Admiralty and representatives of the Royal Society; but the proposal of an Antarctic expedition was not favourably received.

The Joule Fund Committee submitted its report on December 7, 1893, and the Council, on its recommendation, adopted the following resolutions:—

1. That the regulations for administering the Joule Memorial Fund be as follows:—

- (1) That the proceeds be applied in the form of a studentship or grant, to be awarded every year, to assist research, especially among younger men, in those branches of physical science more immediately connected with Joule's work.
- (2) That this grant be international in its character, and awarded alternately in Great Britain and abroad, or in such order as the President and Council shall from time to time decide.
- (3) That it be awarded in Great Britain by the President and Council of the Royal Society; and, for award in France, offered to the Académie des Sciences, Paris; and in Germany to the K. Akademie der Wissenschaften, Berlin; or, in any other country, to the leading scientific institution, for award in that country.
- (4) That the award in Great Britain be made on the recommendation of a committee, from time to time appointed by the President and Council of the Royal Society, but not of necessity confined to Fellows of the Society.

II. That a sum of £100, which is now, or shortly will be, available, for the first studentship or grant be awarded in accordance with Regulation 4.

The first appointment was accordingly made on June 21, 1894, when it was resolved:—

- (1) "That a Joule Scholarship of the Royal Society Memorial Fund be awarded to Mr J. D. Chorlton, of Owens College, Manchester, for the purpose of enabling him to carry on certain researches on lines laid down by Dr. Joule, more especially with the view of determining the constants of some of the instruments employed by Dr. Joule, which can be placed at his disposal by his representatives."
- (2) "That the value of the Scholarship be £100, payable quarterly, on the certificate from the authorities of Owens College that the researches are being conducted in a satisfactory manner."

On the occasion of Sir George Buchanan's retirement from the post of Chief Medical Officer to the Local Government Board, it was decided by some of his friends that a testimonial should be presented to him, and a sum, amounting to about £340, has been subscribed by medical officers of health, sanitary engineers, and others interested in sanitary science. It was resolved, on the suggestion of Sir George Buchanan himself, that this testimonial should take the form of a medal, to be awarded periodically for work done in connection with sanitary science, and that the Royal Society should be asked to administer the testimonial fund under the following conditions:—

1. The money collected, after paying expenses incurred, to be devoted—

- (a) To the foundation of a Gold Medal of the value as nearly as may be of twenty guineas, with a portrait of Sir George Buchanan on the one side and an appropriate design on the other, to be awarded every three or five years in respect of distinguished services to Hygienic Science or Practice, in the direction either of original research or of professional, administrative, or constructive work.
- (b) To the bestowal on the recipient of the Medal of the amount (remaining after paying for the Medal and discharging the incidental expenses) which has accumulated since the last award.

(2) The Medal to be awarded without limit of nationality or sex.

The Council of the Royal Society has accepted the trust under these conditions; and it was agreed that the first medal should be given to Lady Buchanan by the testimonialists themselves.

The Catalogue Department has been specially active in the past session. Mr. Ludwig Mond's generous gift of £2000, which I announced to the Society in my anniversary address last year, has given a new impulse to our operations in that department, and enabled us to increase the staff of assistants. Under the able superintendence of Miss Chambers, volume to

of the Catalogue under authors' names has been completed, and was issued in June of the present year. The Society is indebted to several members of the Catalogue Committee who have lent their scientific knowledge to aid in the revision of the proofs, and especially to the Treasurer, under whose experienced eye every sheet in the catalogue has passed. The preparation of copy for a supplementary volume, which will include papers from a large number of periodicals not included in the existing volumes, is now nearing completion.

The Catalogue Committee have held several meetings and discussed some important questions. The proposed subject-index to the existing catalogue has been the chief matter under consideration, and the burning question of the respective merits of an alphabetical and a classified index has been so far settled as to make it possible to commence the work of transcription and translation, nearly 40,000 slips being already finished, so that when the details of the plan agreed upon have been finally settled, as there is good hope they will be in the near future, the preparation of the copy for the printer can be speedily proceeded with. Before, however, any final steps can be taken, it will be necessary that the supplement volume of the catalogue should have issued from the press. The preparations for this volume are in active progress.

A kindred subject, but one of still wider scope, has been discussed by a special committee appointed by the Council at their first meeting in the present session. The question, namely, of a scientific subject-catalogue, which it is proposed to carry out by means of international co-operation. This committee, with the sanction of the Council, have addressed a circular letter to scientific societies and institutions in this country and abroad, offering by way of preliminary suggestions, first, that the catalogue should commence with the next century; secondly, that a central office or bureau should be maintained by international contributions; and third, that this office should be supplied with all the information necessary for the construction of the catalogue. The circular invites the views on this subject of scientific bodies and scientific men, without in any way committing the Society to farther action. A large number of replies to this circular have been received, many of them carefully prepared and able documents. They will be submitted to the new Council of the Royal Society, and will, I am sure, be most valuable in assisting it to judge as to future proceedings.

The principal question which the Library Committee have had before them during the past session is the accumulation of the stock of *Philosophical Transactions* from the beginning of the century to the present time. New racks have been erected in the basement, which have partly relieved the pressure on our space, but the Committee recognise the necessity of some active measures being taken to increase the sale of this accumulated stock. They are of opinion that the sale might be much facilitated if the memoirs composing the volumes published in the past were made separately available to the public, as is done with those that are published at the present time. On the advice of the committee, the Council have empowered the Treasurer to treat with one of the leading booksellers with the view of bringing some such arrangement into effect.

The collection of marble busts belonging to the Society, which is of such personal and historical interest to all our Fellows, has received a most important and valuable accession. The sons of our former President, Mr. William Spottiswoode—Messrs. Hugh and Cyril Spottiswoode—have presented to the Society a marble bust of their father, by Woolner, which will find in our apartments a fitting home among the busts of many of our former Presidents and distinguished Fellows, and will hand down to posterity a striking likeness of one who deserved so well of the Society and whose premature decease we all still deplore.

The House and Soirée Committee have discussed the advisability of increasing the accommodation in the tea room, and have presented a report to the Council upon the subject. The Council, while not disagreeing with this report, considered it wiser, in the present state of finances, to defer the matter for a time.

A third report of the Water Research Committee has been issued during the present year. It gives the results of further experiments by Prof. Marshall Ward on the "Action of Light on Bacillus Anthracis," and on the "Bacteria of the Thames," and the experiments of Prof. Percy Frankland on the

"Behaviour of the Typhoid Bacillus and of the *Bacillus Cœli Communis* in Potable Water," the whole filling 242 octavo pages.

Unusually large as was the amount of matter published last year, this year the amount is even larger. In the mathematical and physical section of the *Philosophical Transactions*, seventeen papers have been published, eighteen in the biological section. The two sections together contain, in all, 1992 pages of letterpress, and 112 plates; to which must be added eight or ten papers now passing through the press, and probably to be issued before the close of the year. Of the *Proceedings*, ten numbers have been issued, containing 1026 pages. As a result, the finances of the Society are, I regret to say, in not such a satisfactory condition as could be desired. The cost of the publications, which, last year, was far in excess of what it was in previous years, and of what the Society could really afford, has, in the year 1894, amounted to nearly £3260, or about £90 more than it was in 1893. For lithography and engraving alone £1516 have been paid, as against £977 last year. There is, moreover, an accumulation of printed matter now almost in readiness to be issued, the cost of which has still to be defrayed. To meet this extraordinary expenditure it has been necessary to sell out enough of the Society's funded capital to produce £1000, and rigorous retrenchment will be necessary in order to avoid further loss of provision for continued work in future. While the Council feels the importance of all the publications of the Society being as completely illustrated and as fully detailed as the subjects discussed may require, it is evident that some check must be placed on the extent of the publications, and the best manner of effecting this end is occupying the careful attention of the Council.

The establishment of the Faraday-Davy Research Laboratory, in connection with the Royal Institution, is a splendid benefaction which science has gained during the past year, through the untiring and grand generosity of Mr. Ludwig Mond. The Royal Society interests itself in all work contributing towards the object for which it was founded—the increase of natural knowledge; and while gratefully remembering the assistance so generously given to it in the humble but highly valuable work of cataloguing papers which describe the results of scientific investigations already made, it hails with delight this grand foundation of a practical laboratory, of which the purpose is not the teaching of scientific truths already discovered, but the conquering of fresh provinces from the great region of the unknown in nature.

The greatest scientific event of the past year is, to my mind, undoubtedly the discovery of a new constituent of our atmosphere. If anything could add to the interest which we must all feel in this startling discovery, it is the consideration of the way by which it was found. In his presidential address to Section A of the meeting of the British Association at Southampton in 1882, Lord Rayleigh, after calling attention to Prout's law, according to which the atomic weights of the chemical elements stand in simple relationship to that of hydrogen, said:—"Some chemists have reprobated strongly the importation of *a priori* views into the consideration of the question, and maintain that the only numbers worthy of recognition are the immediate results of experiment. Others, more impressed by the argument that the close approximations to simple numbers cannot be merely fortuitous, and more alive to the inevitable imperfections of our measurements, consider that the experimental evidence against the simple numbers is of a very slender character, balanced, if not outweighed, by the *a priori* argument in favour of simplicity. The subject is eminently one for further experiment; and as it is now engaging the attention of chemists, we may look forward to the settlement of the question by the present generation. The time has, perhaps, come when a redetermination of the densities of the principal gases may be desirable—an undertaking for which I have made some preparations." The arduous work thus commenced in 1882, has been continued for twelve years,<sup>1</sup> by Rayleigh, with unremitting perseverance. After

<sup>1</sup> "On the relative Densities of Hydrogen and Oxygen. Preliminary Notice," by Lord Rayleigh, February 2, 1877. "On the Composition of Water," by Lord Rayleigh, February 26, 1878. "On the relative Densities of Hydrogen and Oxygen. II." By Lord Rayleigh, February 5, 1880. "On the Densities of the principal Gases," by Lord Rayleigh, March 23, 1882. "On an Anomaly encountered in Determinations of the Density of Nitrogen Gas," by Lord Rayleigh, April 10, 1894. All published in the *Proceedings* of the Royal Society.

twelve years, the most important part of the object, the determination of the atomic weight of oxygen with as possible accuracy was attained by the comparison of Scott's determination of the ratio of the volumes of hydrogen and oxygen in the constitution of water, with Rayleigh's determination of the ratio of the densities. The result was 15.82, which is almost 1 per cent., or 87 per cent. less than the 17, which it would be according to Prout's law. It is very slightly less than Dittmar and Henderson's value obtained by an investigation for which the Graham medal of the Glasgow Philosophical Society was awarded in 1867. Values, not quite so small as the one for the atomic weight of oxygen, had been previously found by Cooke and Richards (15.802) and by Leduc (15.876). There can be no doubt whatever now that the true value is more than  $\frac{1}{2}$  per cent. smaller than according to Prout's law, and that in all probability it agrees exceedingly closely with the results obtained by Rayleigh and Scott, and by Dittmar and Henderson. The question of Prout's law being thus so far set at rest, Rayleigh, perceiving in the main object which he had promised in 1882, "a redetermination of the densities of the principal gases," attacked nitrogen resolutely and, stimulated by most disturbing and unexpected difficulties in the way of obtaining concordant results for the density of this gas as obtained from different sources, discovered that the gas obtained by taking vapour of water, carbonic acid, and oxygen from common air was denser by 1.250 than nitrogen obtained by chemical processes from nitric oxide or from nitrous oxide, or from ammonium nitrite, thereby rendering it probable that atmospheric air is a mixture of nitrogen, and a small proportion of some unknown and heavier gas. Rayleigh and Ramsay, who happily joined in the work at this stage, have since succeeded in isolating the new gas, both by removing nitrogen from common air by Cavendish's old process of passing electric sparks through it, and taking away the nitrous compounds thus produced by alkaline liquor; and by absorption by metallic magnesium. Thus we have a fresh and most interesting verification of a statement which I took occasion to make in my presidential address to the British Association in 1874, "Accurate and minute measurement seems to the non-mathematical imagination a less lofty and dignified work than looking for something new. But nearly all the grandest discoveries of science have been but the rewards of accurate measurement and patient long continued labour in the minute sifting of numerical results." The investigation of the new gas is now being carried on vigorously, and has already led to the wonderful conclusion that the new gas does not combine with any other chemical substance which has hitherto been presented to it. We all wait with impatience for further results of their work; we wish success to it, and we hope that it will give us, before the next anniversary meeting of the Royal Society, such knowledge of the properties, both physical and chemical, of the hitherto unknown and still anonymous fifth constituent of our atmosphere.

COBLEY MEDAL.

*Dr. Edward Frankland, F.R.S.*

The Cobley Medal is awarded to Dr. E. Frankland for his eminent services to theoretical and applied chemistry.

At a time when the classification of organic compounds in homologous series was a comparative novelty, when isomerism was still a profound mystery, and the theory of compound radicals introduced by Liebig was still on its trial, Dr. Frankland made his first attempt, in 1848, to isolate the radicle of common alcohol. Though the attempt was in one sense unsuccessful, inasmuch as the free radicle was never obtained, for reasons which we now more fully understand, the research led to important consequences. The discovery of the organo-metallic compounds, and the study of their composition and properties, was followed by a recognition of the fact, first that the capacity for combination possessed by the atoms of the metals was limited (*Phil. Trans.*, 1852), and secondly that variation of "atomicity," as it was then called, usually occurs by an even number of units (*Phil. Trans.*, 1860), represented by atoms of hydrogen, chlorine, or such compound radicles as ethyl, ethyl, and the rest. These discoveries form the basis

of the modern doctrine of valency, with all the important consequences that follow, including the idea of the orderly linking of atoms, and hence the theories of structure or constitution now current.

The discovery of zinc ethyl placed in the hands of chemists an important new instrument of research, which Dr. Frankland was himself the first to use in his investigations concerning the synthetical production of acids of the lactic and acrylic series. Further important synthetical work, conducted in concert with Mr. Duppa, led to a method of ascending the series of acids homologous with acetic acid.

Dr. Frankland's researches in pure chemistry are almost rivalled in interest by his discoveries in physical chemistry, especially in relation to the influence of pressure on the rate of combustion, on the light emitted during combustion, and on the cause of luminosity in hydrocarbon flames.

The important work done by Dr. Frankland in the study of water supply and sewage, and illuminating gas, has proved of great practical value, and has rendered his name famous in connection with the application of chemistry to technical purposes.

RUMFORD MEDAL.

*Professor Dewar.*

During more than twenty years past Prof. Dewar has been engaged in researches of great difficulty, in the first instance at very high, and latterly at very low temperatures, his inquiries having extended over an extraordinary wide field, as will be seen by reference to the "Royal Society Catalogue" of scientific papers.

In conjunction with Prof. Liveing, he has communicated to the Royal Society a large number of papers which have added much to our knowledge of spectroscopic phenomena.

During recent years he has made the liquefaction of gases a subject of deepest study, and in the course of this work has displayed not only marvellous manipulative skill and fertility of resource, but also great personal courage, such researches being attended with considerable danger. One of his chief objects has been so to improve and develop the methods of liquefying the more permanent gases that it shall become possible to deal with large quantities of liquid, and to use such liquids as instruments of research in extending our knowledge of the general behaviour of substances at very low temperatures. In this he has already been highly successful. Not only has he succeeded in preparing large quantities of liquid oxygen, but he has been able by the device of vacuum-jacketed vessels to store this liquid under atmospheric pressure during long periods, and thus to use it as a cooling agent. Very valuable outcome of these labours has been the series of determinations, made by him in conjunction with Dr. Fleming, of the electrical conductivity of metals at exceedingly low temperatures, which have furnished results of a most unexpected character, and of extraordinary interest and importance. Prof. Dewar's experiment showing the great magnetic susceptibility of liquid oxygen is exceedingly important and interesting. His recent observations on phosphorescence, and on photography, and on ozone at very low temperatures, have given surprising results of a highly instructive and interesting character. It is difficult to exaggerate the importance of extending these researches, which certainly deserve all possible encouragement and support. The award of the Rumford Medal to Prof. Dewar is made in recognition of the services which he has rendered to science by the work which he has already done and the provision he has been successful in making for future work, in the investigation of properties of matter at lowest temperatures.

ROYAL MEDAL.

*Prof. J. Thomson, F.R.S.*

Prof. J. J. Thomson has distinguished himself in both mathematical and experimental fields of work. His first essay on vortex rings showed power of grappling with difficult problems, and added to our knowledge concerning the encounter of rings which came within a moderate distance of one another so as to deflect each others' paths.

His theoretical work in the borderland of chemistry and physics has been very interesting and suggestive. His experimental work has likewise been mainly on the borders of chemistry and physics. He has observed the large conductivity

of many gases and vapours, and proved the non-conducting power of several others, founding on the conducting power of iodine vapour important speculations as to its probable chemical constitution.

He has also measured the specific resistance of various electrolytes, under extremely rapid electric oscillations, by an ingenious and valuable method, based on the partial opacity of semi-conducting matter to electromagnetic waves. Recently he has worked at the discharge of electricity through rarefied gases, getting induced currents in closed circuits in sealed bulbs without electrodes, and, in especial, measuring to a first approximation the absolute velocity of the positive discharge through a long vacuum tube, proving that it was comparable with, though decidedly less than, the velocity of light. He also gave an ingenious theory of the stric—a theory which he has since endeavoured, with some success, to extend to a large number of electrical phenomena, the whole of electric conduction and induction being regarded by him from the chemical side as a modified or incipient electrolysis, or as concerned with electrolytic chains of molecules or "Faraday tubes."

Some of his recent mathematical work on the theory of electric oscillations in spheres and cylinders, and in dumb-bell oscillators of the kind used by Hertz, with reference to not only their oscillation-frequency but also their damping efficiency, has been of much service to experimental workers in those branches of physics. And, in general, the effective manner in which he attacks any electrical problem presenting itself, as evidenced by his book on "Recent Researches in Electricity and Magnetism," wherein he worthily carries on into a third volume the great treatise begun by Clerk Maxwell, is evidence of consummate ability combined with remarkable energy and power of work.

#### ROYAL MEDAL.

*Prof. Victor Horsley, F.R.S.*

A Royal Medal is awarded to Prof. Victor Horsley, F.R.S., for his laborious and fruitful researches in physiology and pathology, and particularly for those relating to the functions of the nervous system and of the thyroid gland. His inquiries relating to the former subject have been pursued for more than ten years, and have been communicated to the Royal Society in a succession of papers, the most important of which have been published in the *Philosophical Transactions*. The first of the series of researches (*Phil. Trans.*, 1888), which was conducted in co-operation with Prof. Schafer, and concerned the relation of a part of the cerebral cortex (the limbic lobe) to sensation, afforded a new confirmation and extension of the doctrine of the localisation of cerebral function now generally accepted. While this work was in progress, Prof. Horsley engaged with Dr. Beevor in a long and laborious series of experiments for the purpose of determining with the utmost attainable accuracy the nature of the muscular responses which are evoked by stimulating the convolutions in the quadrumana. The results of these researches were communicated in four papers, of which the first three relate to the "cortical representations" of the movement of the limbs, and of those of the tongue and face (*Phil. Trans.*, 1887-1890); the fourth on the channels (in the internal capsule) by which the cortex exercises its influence on the rest of the nervous system (*Phil. Trans.*, 1890).

These experiments not only served to bring to light a number of new facts, and to elucidate their physiological relations in a very remarkable way, but had a special interest in their bearing on the physiology and pathology of the brain in man. Their importance in this respect is enhanced by the circumstance that in the course of the inquiry the opportunity offered itself of comparing the brain of the monkey with that of the orang (*Phil. Trans.*, 1890), a brain which so closely approaches that of man in its structure that the knowledge acquired by these researches may now be confidently used as a guide in the diagnosis and treatment of cerebral disease. Prof. Horsley has himself shown—and this is not the least of the merits which it is desired to recognise in the bestowal of the Royal Medal—in how many instances the knowledge which is acquired by patient and skilful work in the laboratory may be made available for the saving of life, or the alleviation of human suffering.

In connection with this leading series of researches, two others relating to the physiology of the central nervous system must be referred to. In one of these (*Phil. Trans.*, 1890), Prof. Horsley (in co-operation with Dr. Semon) established the existence, not only of a co-ordinating centre in the bulb, but of

a cortical area in physiological relation with the respiratory and phonatory movements of the larynx; in the other, in conjunction with Prof. Gotch, he investigated the electrical changes in the spinal cord which are associated with excitation of the cortex and internal capsule, and showed how the observation of these facts can be made available for tracing channels of conduction in the cord.

As regards the thyroid gland, Prof. Horsley's inquiries relating to functions of that organ were like those relating to the nervous system, begun ten years ago, though the results were not communicated to the Royal Society until three years later. Their purpose was to ascertain the nature of the very marked influence which the thyroid was known to exercise on the nutritive functions of the organism, and to show that this influence is constant and definite. In this field, Prof. Horsley has not only the merit of having been one of the earliest workers, but of having at this early period arrived at results which the numerous investigations of subsequent writers have in all essential particulars confirmed.

#### DAVY MEDAL.

*Prof. Peter Theodor Cleve.*

The Davy Medal is awarded to Peter Theodor Cleve, Professor of Chemistry in the University of Upsala, for his services to chemical science during the last thirty years, and in particular for his long-continued and valuable researches on the chemistry of the rare earths.

This field of inquiry is pre-eminently Scandinavian. By the manner in which he has cultivated it, Prof. Cleve has shown himself a worthy successor of such forerunners as Gadolin, Berzelius, and Mosander, and by sound and patient investigation he has faithfully upheld the traditions inseparably associated with these names. All chemists are agreed that no department of their science demands greater insight or more analytical skill than this particular section. Many of the minerals which furnish the starting-point for investigation are extremely rare, and the amounts of the several earths which they contain are frequently very small. Moreover, the substances themselves are most difficult of isolation, and their characters are so nearly allied that the greatest care and judgment are required in order to determine their individuality.

A remarkable example of Prof. Cleve's power in overcoming these difficulties is seen in his masterly inquiry into the affinities and relations of the element scandium, discovered by Nilson. This, one of the rarest of the metals, is found only in gadolinite to the extent of 0.003 per cent., and in yttrite to the extent of about 0.005 per cent. The whole amount of the material, as oxide, at Cleve's disposal was only about 1 gram, but with this small quantity he determined the atomic weight of the element, and ascertained the characters of its salts with such precision as to leave no doubt of the identity of scandium with the element *Ekabor*, the existence of which was predicted by Mendeléef, in the memorable paper in which he first enunciated the Law of Periodicity. Cleve's research, indeed, constitutes one of the most brilliant proofs of the soundness of the great generalisation which science owes to the Russian chemist.

A not less remarkable instance of Cleve's skill as a worker is seen in his research on samarium and its compounds, which he communicated as one of its Honorary Foreign Fellows to the Chemical Society of London. The existence of samarium was inferred independently by Delafontaine and Lecoq de Boisbaudran, but we owe to Cleve the first comprehensive investigation of its characters and chemical relations. From the nature of its compounds, a large number of which were first prepared and quantitatively analysed by Cleve, and from the value of its atomic weight, which was first definitely established by him, it would appear that samarium most probably fills a gap in the eighth group of Mendeléef's system.

We are further indebted to Cleve for a series of determinations of the atomic weights of the rare substances yttrium, lanthanum, and didymium; these are generally accepted as among the best authenticated values for these particular bodies.

No record of Cleve's scientific activity would be complete without some reference to his investigations in the domain of organic chemistry, and more particularly to his studies, extending over twenty years, of naphthalene derivatives. By these researches, made partly independently, and partly in conjunction with his pupils, among whom may be named Aterberg, Widman, Forsing, and Hellstrom, Cleve has gradually brought order out of confusion, and has supplied most valuable experimental

evidence of the position of naphthalene, and of the course of substitution of naphthalene derivatives. Within recent years a score of workers have occupied themselves with the same field of research, and no greater proof of Cleve's accuracy and care as an investigator could be furnished than the manner in which his naphthalene work—confessedly one of the most intricate and complicated sections of the chemistry of aromatic compounds—has stood the ordeal of revision.

#### DARWIN MEDAL.

*Read by Mr. T. H. H. Esq., F.R.S.*

The Darwin Medal is awarded to Thomas Henry Huxley.

Of Mr. Huxley's general labours in biological and geological science I need say nothing here. They are known of all men, and the Society showed its appreciation of their worth when it awarded to him the Copley Medal in 1888. The present medal is a token of the value put by the Society on the part of his scientific activity bearing more directly on the biological ideas with which the name of Charles Darwin will always be associated.

All the world now knows in part, no one perhaps will ever know in full, how, in the working out of his great idea, Darwin was encouraged, helped, and guided by constant communion with three close and faithful friends, Charles Lyell, the younger Joseph Dalton Hooker, and the still younger Thomas Henry Huxley. Each representing more or less different branches of science, each bringing to bear on the problems in hand more or less different mental characters, all three bore share, and were proud to bear share, in aiding the birth of the "Origin of Species." Charles Lyell has long been removed from amongst our midst. Two years ago it was my pleasing duty to place the Darwin Medal in the hands of Joseph Dalton Hooker; that pleasing duty is renewed to-day in now giving it to the last of the three "who kept the bridge."

To the world at large, perhaps, Mr. Huxley's share in moulding the thesis of "Natural Selection" is less well known than is his bold unwearied exposition and defence of it after it had been made public. And, indeed, a speculative trifler, revelling in problems of the "might have been," would find a congenial theme in the inquiry how soon what we now call "Darwinism" would have met with the acceptance with which it has met, and gained the power which it has gained, had it not been for the brilliant advocacy with which in its early days it was expounded to all classes of men.

That advocacy had one striking mark; while it made or strove to make clear how deep the new view went down and how far it reached, it never shrank from striving to make equally clear the limits beyond which it could not go. In these latter days there is fear lest the view, once new but now familiar, may, through being stretched farther than it will bear, seem to lose some of its real worth. We may well be glad that the advocates of the "Origin of Species by Natural Selection," who once bore down it, are still among us ready, if needs be, to "save it from its friends."

The Society next proceeded to elect the officers and Council for the ensuing year. We gave the list of those recommended for election in our issue of November 8.

In the evening the Fellows and their friends dined together at the Whitehall Rooms of the Hotel Metropole.

After the usual toasts, the President proposed that of "The Medallists," coming with it the names of Prof. Cleve and Mr. Huxley. The toast was most cordially drunk. The *Time* reports the response as follows:—

Prof. Cleve, in responding, quoted the noble words of Davy—"Science, like that nature to which it is bound, is neither limited by time nor by space but belongs to the world, and is of no country and of no age." In the same sense the Royal Society continues to award its medals to men of science, without regard to their nationality. It was a great and elevating thought that there existed a spot in the world where members of all nations met each other as friends, assisting each other in their work for the advancement of science, and therefore for the good of humanity and the prosperity of mankind. It was the first time that the Davy medal had found its way to Sweden, but it was not the first time that other medals of the Royal Society had been voted to Professors of the University to which he was attached. The Rumford medal had been given not less than three times to his colleague, and when he offered to the

Royal Society his respectful thanks he was happy to include also those of the University of Upsala.

Mr. Huxley said—I am extremely grateful for the respite which has been afforded me by the distinguished foreigner to whom you have just been listening with so much pleasure, because I am loaded with five distinct and separate parcels of gratitude. That is a substance of which I believe the specific gravity has never yet been accurately determined. I am told that in some parts of the world, and especially in the political world, it is lighter than hydrogen; but in the scientific world, and when the object of it is the approbation of a body like the Royal Society, I am disposed to think that we may rank it rather with platinum, so largely does it affect the destinies of those who are fortunate enough to receive it. In respect of four of these parcels I am simply a representative, and perhaps I ought to content myself with acting purely as a representative of those who I wish had been called upon to express their gratitude for themselves. But perhaps I may venture to add that in some cases I have a little personal word to say for myself, as, for example, in that of the Copley medal, which you have adjudged one of my oldest friends and many years a colleague, so that I have a strong and warm interest in the fact that his great services to the science of chemistry have been recognised. And, again, I think that there is another friend in whom I may claim a personal interest—I mean my friend Prof. Dewar—for the remarkable character of his discoveries allows a person who indulges so little in flights of imagination as myself to think of the time when, instead of the excellent liquid with which we have been supplied here, we may have at these dinners of the Royal Society liquid oxygen *à la carte*, and then, gentlemen, with that stimulus there is no saying to what length the eloquence of persons who address you may go. And then, again, in one of the youngest of those whom you have honoured with your approbation to-day, and whose work lies within the province in which I am still capable if not of knowledge at least of appreciation—I mean Prof. Victor Horsley—I may say that it is pleasant to me to see him here like a Ulysses who has escaped from the toils of the Circes of anti vivisection. But the most difficult task that remains is that which concerns myself. It is forty-three years ago this day since the Royal Society did me the honour to award me a Royal medal, and thereby determined my career. But, having long retired into the position of a veteran, I confess I was extremely astonished. I honestly also say that I was extremely pleased—to receive the announcement that you had been good enough to award to me the Darwin medal. But you know the Royal Society, like all things in this world, is subject to criticism. I confess that with the ingrained instincts of an old official that which arose in my mind after the reception of the information that I had been thus distinguished was to start an inquiry which I suppose suggests itself to every old official—How can my government be justified? In reflecting upon what had been my own share in what are now very largely ancient transactions it was perfectly obvious to me that I had no such claims as those of Mr. Wallace. It was also perfectly clear to me that I had no such claims as those of my life-long friend Sir Joseph Hooker, who for twenty-five years placed all his great sources of knowledge, his sagacity, his industry, at the disposition of his friend Darwin. And really, I began to despair of what possible answer could be given to the critics whom the Royal Society, meeting as it does on November 30, has lately been very apt to hear about on December 1. Naturally there occurred to my mind that famous and comfortable line, which I suppose has helped so many people under like circumstances, "They also serve who only stand and wait." I am bound to confess that the standing and waiting to which I refer, has been, so far as I am concerned, of a somewhat peculiar character. I can only explain it, if you will permit me to narrate a story which came to me in my old nautical days, and which, I believe, has just as much foundation as a good deal of other information which I derived at the same period from the same source. There was a merchant ship in which a member of the Society of Friends had taken passage. That ship was attacked by a pirate, and the captain thereupon put into the hands of the member of the Society of Friends a pike, and desired him to take part in the subsequent action, to which, as you may imagine, the reply was that he would do nothing of the kind; but he said that he had no objection to stand and wait at the gangway. He did stand and wait with the pike in his hand, and when the pirates mounted and showed themselves coming on board, he thrust his pike (with the



sharp end forward) into the persons who were mounting, and he said, "Friend, keep on board thine own ship." It is in that sense that I venture to interpret the principle of standing and waiting to which I have referred. I was convinced as firmly as I have ever been convinced of anything in my life that the "Origin of Species" was a ship laden with a cargo of great value, and which, if she were permitted to pursue her course, would reach a veritable scientific Golconda, and I thought it my duty, however naturally averse I might be to fighting, to bid those who would disturb her beneficent operations to keep on board their own ship. If it has pleased the Royal Society to recognise such poor services as I may have rendered in that capacity I am very glad, because I am as much convinced now as I was thirty-four years ago that the theory propounded by Mr. Darwin, I mean that which he propounded—not that which has been reported to be his by too many ill-instructed, both friends and foes—has never yet been shown to be inconsistent with any positive observations, and if I may use a phrase which I know has been objected to and which I use in a totally different sense from that in which it was first proposed by its first propounder, I do believe that on all grounds of pure science it "holds the field," as the only hypothesis at present before us which has a sound scientific foundation. It is quite possible that you will apply to me the remark that has often been applied to persons in such a position as mine, that we are apt to exaggerate the importance of that to which our lives have been more or less devoted. But I am sincerely of opinion that the views which were propounded by Mr. Darwin thirty-four years ago will be understood hereafter to mark an epoch in the intellectual history of the human race. They will modify the whole system of our thoughts and opinions, and shape our most intimate convictions. I do not know, I do not think anybody knows, whether the particular views which Darwin held will be fortified by the experience of the ages which come after us. But of this thing I am perfectly certain, that the present state of things has resulted from the feeling of the smaller men who have followed him that they are incompetent to bend the bow of Ulysses, and in consequence many of them are preferring to employ the air-gun of mere speculation. Those who wish to attain to some clear and definite solution of the problems which Mr. Darwin was the first person to set before us in later times, must base themselves upon the facts which are stated in his great work, and, still more, must pursue their inquiries by the methods of which he was so brilliant an exemplar throughout the whole of his life. You must have his sagacity, his untiring search after the knowledge of fact, his readiness always to give up a preconceived opinion to that which was demonstrably true, before you can hope to carry his doctrines to their ultimate issue; and whether the particular form in which he has put them before us may be such as is finally destined to survive or not is more, I venture to think, than anybody is capable at this present moment of saying. But this one thing is perfectly certain—that it is only by pursuing his methods, by that wonderful single-mindedness, devotion to truth, readiness to sacrifice all things for the advance of definite knowledge, that we can hope to come any nearer than we are at present to the truths which he struggled to attain.

## THE BATTLE OF THE FORESTS.<sup>1</sup>

### II.

IN the sand-hills which traverse Nebraska from east to west there are now found in eastern counties the sand-drowned trunks of the western bull pine, and the same pine belonging to the Pacific flora is found associated with the black walnut of the eastern region along the Niobrara River.

We may, however, divide the North American forest, according to its botanical features, into two great forest regions, namely, the Atlantic, which is in the main characterised by broad-leaved trees, and the Pacific, which is made up almost wholly of coniferous species.

In the Atlantic forest we can again discern several floral subdivisions, each of which shows special characteristics. The southernmost coast and keys of Florida, although several degrees north of the geographical limit of the tropics, present a truly

<sup>1</sup>A lecture delivered by Prof. B. E. Fernow, Chief of the Forestry Department of Agriculture, U.S.A., during the Brooklyn meeting of the American Association for the Advancement of Science. (Continued from page 119.)

tropical forest, rich in species of the West Indian flora, which here finds its most northern extension. There is no good reason for calling this outpost semi-tropical, as is done on Sargent's map. With the mahogany, the mastic, the royal palm, the mangrove, the sea grape, and some sixty more West Indian species represented, it is tropical in all but its geographic position. That the northern flora joins the tropic forest here, and thus brings together on this insignificant spot some hundred species, nearly one quarter of all the species found in the Atlantic forest, does not detract from its tropical character.

On the other hand, the forest north of this region may be called sub-tropical, for here the live and water oak, the magnolia, the bay tree and holly, and many other broad-leaved trees are mixed with the sabal and dwarf palmetto. As they retain their green foliage throughout the winter, this region is truly semi-tropical in character, and under the influence of the Gulf Stream, extends in a narrow belt some twenty or twenty-five miles in width along the coast as far north as North Carolina.

While this ever-green, broad-leaved forest is more or less confined to the rich hammocks and moister situations, the poor sandy soils of this as well as of the more northern region are occupied by pines; and as those, especially the long leaf pine, are celebrated all over the world, and give the great mercantile significance to these forests, this region may well be called the great southern pine belt. North of the evergreen subtropical forest stretches the vast deciduous leaved forest of the Atlantic, nowhere equalled in the temperate regions of the world in extent and perfection of form, and hardly in the number of species. This designation applies to the entire area up to the northern forest belt, for the region segregated on the census map as the northern pine belt is still in the main the dominion of the deciduous-leaved forest trees. On certain areas pines and spruces are intermixed, and on certain soils, especially gravelly drifts and dry sand plains, as on the pine barrens of Northern Michigan, they congregate even to the exclusion of other species. Instead, we can divide this deciduous-leaved forest by a line running somewhere below the fortieth degree of latitude, where with the northern limits of the southern magnolias and other species we may locate in general the northern limit of the southern forest flora. Northward from here, in what may be called the "middle Atlantic forest," the deciduous species rapidly decrease, and the coniferous growth predominates, until we arrive at the broad belt of the northern forest, which, crossing from the Atlantic to the Pacific, and composed of only eight hardy species, takes its stand against the frigid breath and icy hands of Boreas.

Abounding in streams, lakes, and swampy areas, the low divides of this region are occupied by an open stunted forest of black and white spruce, while the bottoms are held by the balsam fir, larch or tamarack, poplar, dwarf birch and willow. The white spruce, paper or canoe birch, balsam poplar and aspen stretch their lines from the Atlantic to the Pacific over the whole continent.

On the Pacific side the subdivisions are rather ranked from west to east. While the northern forest battles against the cold blasts from icy fields, the front of the Pacific interior forest is wrestling with the dry atmosphere of the plains and interior basin. Here, on the driest parts, where the sage brush finds its home, the ponderous bull pine is the foremost fighter, and where even this hardy tree cannot succeed in the interior basin several species of cedar hold the fort, in company with the nut pine, covering with an open growth the mesas and lower mountain slopes. Small and stunted, although of immense age, these valiant outposts show the marks of severe struggles for existence.

On the higher, and therefore moister and cooler elevations, and in the narrow canyons, where evaporation is diminished and the soil is fresher, the sombre Douglas, Engelmann, and blue spruce, and the silver-foliated white fir, join the pines or take their place.

With few exceptions, the same species, only of better development, are found in the second parallel, which occupies the western slopes of the Sierra Nevada. Additional forces here strengthen the ranks, the great sugar pine, two noble firs, a mighty larch, hemlocks and cedars vie with their leaders, the big sequoias, in showing of what metal they are made. The third parallel, occupied by the forest of the Coast Range, the most wonderfully developed, although far from being the most varied of this continent, is commanded by the redwood, with the tide-land spruce, hemlock, and gigantic arborescent-joining the ranks.

Broad-leaved trees are not absent, but so little developed in comparison with the mighty conifers that they play no conspicuous part except along the river bottoms, where the maple, cottonwood, ash, and alder thrive, and in the narrow interior valleys, where an open growth of oak is found. Towards the south and on the lower levels these broad-leaved trees again become evergreen, as on the Atlantic side, but of different tribes, and form a sub-tropic flora.

Along the coast we find several species of true cypress, including the well-known, although rare, Monterey cypress, which clings to the gigantic rocks, and braves the briny ocean winds, and with its branches twisted landward. Finally, flanking the battle order of the Pacific forest, we find another section of the army, composed of the northern extension of the Mexican flora, mingled with which are species from the Pacific forest on the west, and from the Atlantic on the east.

The mesquite and some acacias, the tree yuccas and the giant or tree cactus are perhaps the most characteristic and remarkable species of the forests of this region, while the high mountains support dense forests of firs and pines.

So far we have considered the forest only from the geographical and botanical point of view, and have watched the history of its struggle for existence against the elements and against the lower vegetation and other forces of nature. A new chapter of its life history, which we shall have time only to scan very briefly, began when man came upon the scene, and the economic point of view had to be considered.

For ages man has taken sides against the forest. Not only has he contested for the occupancy of the soil, in order to cultivate his crops or to make the meadow for his cattle—a most legitimate and justifiable proceeding—and not only has he utilised the vast stores of wood accumulated through centuries, for the ten thousand uses to which this material can be applied, and in the application of which he exhibits his superior intelligence, but he has also shown a woeful lack of intelligence in the wilful or careless destruction of the forest without justifiable cause, and by just so much curtailing the bountiful stores provided by nature for him and his progeny. Not only has he, like a spendthrift, wasted his stores of useful material, but more—he has wasted the work of nature through thousands of years by the foolish destruction of the forest cover, wresting from it the toil-some achievement victory over the soil. He has destroyed the grasses and even all vestige of vegetation, and has handed over the naked soil to the action of wind and water. As the fertility and agriculture of the plain is dependent upon the regular and equal flow of water from the mountains, such as a forest cover alone can secure, he has by barring the slopes accomplished in many localities utter ruin to himself, and turned them back into inhospitable deserts as they were first before the struggle of the forest had made them inhabitable.

One would hardly believe that certain mountains in France had ever seen a luxuriant forest growth, and could during historical times have been so utterly despoiled of their vegetal cover. Yet axe, fire, and cattle have been most successful, and the consequence have been felt not only in the mountains, but in the valleys below. The waters in torrents have brought down the soil and debris, covering out of sight the fertile fields of thousands of toiling farmers. They themselves have brought this ruin upon them on account of their ignorance of the relation of forest cover to their occupation. Now, with infinite hard work and expenditure of energy and money, the slow work of restoring the forest to its possession has begun. The first work is to take care of the rain waters, and by artificial breaks turn them from rushing torrents over the bare surface into a succession of gentle runs and ledges by masonry and stone works. This work must be begun at the very top of the mountains, at the very source of the evil, where the water receives its first momentum in the descent to the valley. The ditches or wattles, laid across each rivulet at more or less frequent distances from each other, and fastened down by heavy stones, are made of live willows or other readily sprouting species, which in course of time strike root and become living barriers. The pockets behind these breastworks gradually fill up, and the contour of the mountain-side is changed from an even and rapid descent into a series of steps with gentle fall, over which the formerly rushing waters, gradually and without turbulence, find their way to the valley below. Where the incline is too steep, and higher breastworks are necessary, they are made of masonry, sometimes at great expense. At the base of these overflow dams an opening is left for the water to drain through, even after the deposit behind

the rampart has filled up with debris, and soil has washed down from above. Then, when in this way the soil has come to rest, forest planting begins, and gradually the torrent is "drowned in vegetation." Sometimes, where on a steep mountain-side the naked rock alone has been left, it becomes necessary to carry in baskets the soil to the trenches hewn in the rock, where the little seedlings may take their first hold, until they are strong enough to fight their own battle and make their own soil, gradually restoring the beneficent conditions which nature had provided before the arrival of man and his senseless, improvident, self-destructive greed. By the irrational destruction of the forest, first for the supply of timber, then through the careless use of fire, by the clearing for unsuitable farm use, by excessive grazing of sheep and goat, the mountain-sides themselves are not only devastated and made useless, but fertile farms for two hundred miles from the source of the evil are ruined by the deposits of debris, and the population pauperised and driven from their homes. Many millions of dollars have been and many more will have to be spent before these regions become habitable again.

That we are working in this country towards the same conditions is too well known to need rehearsal. Go to the shores of Lake Michigan, or visit the coast of New England, New Jersey, Pennsylvania, down to the Gulf, and you can see the destructive action of the shifting sands set loose by improvident removal of the plant cover. Go to the Adirondacks, the highlands of Mississippi, or the eastern slopes of the Rocky Mountains, and aspects similar to those derived from France will meet your view.

What the farmer has brought upon himself here by excessive clearing, the lumberer, prospector, miner, or hunter prepares in the farthest West by reckless and purposeless use of fire. Burnt mountain-sides, where no living thing can subsist in comfort, cover not acres but hundreds of square miles in the western country. While the first fire only deadens the trees or undermines their constitution, the second or third fire usually is sufficient to kill what remain alive, and even to clean up the fallen timber. That these bald spots are not more frequent than they are, is only due to the short period of our endeavours in disturbing the balance of nature.

But as our nation prides itself on the rapidity of its development, exercising to the utmost our constructive energies, so do we excel in destructive and wasteful energies and tendencies, and we shall come to grief with our resources much sooner than some of our happy-go-lucky friends would like to make us believe. While these exhibitions of American vandalism are beyond the proprieties of legitimate warfare, there is not much more propriety or intelligence visible in the manner in which we levy tribute to the forest for our legitimate needs. Forests grow to be used, but there is a great difference between intelligent and unintelligent use. Improvidence and ignorance characterise the present methods of using the forest growth. The value of it is not even known. Of the 425 or more species which are represented in the forests, not more than forty or fifty at the most are found in the markets. Although, to be sure, many of the species are of but little or no economic value, the number of the truly useful trees is probably twice or three times as great as that actually used. Ignorance as to the true value of them keeps many from little more than simply a strictly local use, or from their most fit employment. The story of the black walnut used for fence rails or firewood is well known. Six years ago the red gum or liquidambar, now a fashionable finishing material, was despised. Ten years ago large hemlock trees were mouldering in the woods after the bark had been taken for tanning purposes because the value of the wood was unknown. Cypress and Douglas spruce cannot yet overcome the prejudice of the market. On the other hand, cottonwood and tulip poplar, not long ago among the despised or only locally used, can hardly now be furnished in sufficient quantities, and the long leaf pine, which had been bled for turpentine, was considered an inferior material, which, as has lately been shown, is nothing but an unwarranted prejudice.

In a vague empirical way the choice of the useful has been attempted, and only lately have we begun to systematically study our forest resources, to determine the qualities and adaptabilities of our timbers, and to find out the conditions under which they produce not only the largest amount but the best quality of timber.

Yet in another direction do the forest users act unintelligently.

As we have seen, most of our forest trees are of a social character. With few exceptions, they keep company with other kinds than their own; they appear in mixed forests. Hence, where certain species, as the pines and spruces, become gregarious, and form unmixed, pure forests, the axe of the lumberer does not as a rule level the entire forest, but he selects the kinds which he wishes to use—he culls the forest. At first sight this would appear rather an advantage for the existence of the forest. So it is from a botanic, geographic, or landscape point of view, yet from an economic point it is exactly the reverse—it is disastrous.

In the well-managed forests of Germany the undeserving species are exterminated, and the most useful fostered, just as the agriculturist exterminates the weeds and cultivates the crop. Not only is the forest there confined to those soils and locations which cannot be used to better advantage, or which require a forest cover in order to protect the soil against detrimental displacement, but it is so managed as to become a more and more valuable resource, a crop of increasing importance, under the management of skilled foresters, of whom, in a late debate on the floor of the Landtag of Prussia, it was said that "While most other productive business has declined, the forest administration has steadily improved and yielded increasing revenues."

The battle of the forest in this country is now fought by man, the unintelligent and greedy carrying on a war of extermination, without the knowledge that victory may lead eventually to their own destitution; the intelligent and provident trying to defend the forest cover, and endeavouring to prevent its removal from such lands as cannot serve a better purpose, and to restrict the use of the balance to such rational harvest of its material, without injurious effects on soil and water conditions, as will insure an ever reproducing crop and a permanent national resource.

While man may study the geography of the earth as it exists, here is about the only opportunity for him to make geography, to shape the surface conditions of the earth, and even to some extent influence its climatic conditions.

The lecturer then referred to the Adirondacks in particular, showing views of forest destruction by fire, water storage, and lumbering, and claiming that they need especially conservative treatment, because the soil itself there is made by the forest, the duff covering the native rock formed at the rate of one foot in 300 to 500 years by the decay of foliage and litter, and hence its loss by washing of the rains is practically irremediable.

He showed the paramount interest which the State has in maintaining favourable forest conditions, and claimed that the private owners, being naturally interested mostly in the timber only, and not caring for the future generations or distant and indirect benefits to others, could not be expected to manage conservatively.

Let it not be overlooked, that the State is not only the representative of communal interests as against individual interests, but also of future interest as against the present: the private interest is not sufficient to protect this class of lands; that State ownership or, what is more objectionable and less effective, State supervision of private forest lands is indispensable in those regions where the forest subserves other functions than that of mere material supply.

Grant for once that the community is interested in the preservation of the forest cover and its rational use with proper regard to the maintenance of permanently beneficial conditions, that the community would suffer from a destructive policy in those watersheds, and you must come to the logical conclusion that the community alone can be expected to guard its interests, that the community, the State, must own and manage these woods.

This does not mean that the same should be kept in virgin condition and unused, that the timber should be left to rot, and the productive capacity of nature's forces be allowed to go to waste, but that a conservative management be instituted, keeping in view both the indirect and the direct benefits of the forest cover, utilising the crop without detriment to the forest conditions.

This, to be sure, is not done by such rules of thumb as a restriction to cutting trees of given diameter, nor can the legislator prescribe to the forest how to grow. He cannot be expected to legislate how many trees to cut, how many to leave, or to lay down rules of technical forest management, any more than he would attempt to prescribe the size of the pillars supporting the roof of the Capitol, or to legislate on the pro-

portions of an arch. It requires the knowledge, the experience, the skill of a professional, technically educated engineer, just as an effective management of the forest requires the knowledge, the experience, the skill of professional foresters, and may not be left to the ignorance and carelessness of the wood-chopper.

May the wisdom of the people of New York, of their legislators and executive officers, be equal to the difficulties of solving the problem as a business proposition, and settling it in a common sense, business-like manner. May their intelligence and business capacity at least equal that of other States and nations, and forestall the disastrous consequences that follow unavoidably from neutrality or improper partisanship in this battle of the forest.

#### THE RELATION OF ENERGY OF COMBINATION TO ELECTRICAL ENERGY.

THE problem of directly converting the stored-up energy of coal into available electrical energy is one of great importance; and as a first attempt to perform this operation, the experiments made by Dr. W. Borchers, of Duisburg, and which he described before the first annual meeting of the Deutsche Elektrochemische Gesellschaft, possess great interest. The author in the first place produced an electric current by the "combustion" of carbonic oxide gas. The original form of the apparatus used consisted of a glass vessel divided into three compartments by two glass plates which nearly reached to the bottom of the vessel. In the two exterior compartments copper tubes were placed, which served for the introduction of the carbonic oxide, while the middle compartment contained a bell-shaped mass of carbon. This carbon bell constituted one plate of the cell, and the oxygen was introduced by means of a tube within this bell. As electrolyte the author uses an ammoniacal or acid solution of cuprous chloride; this liquid readily absorbs both oxygen and carbonic oxide, and is therefore particularly well suited to form the electrolyte in a gas battery in which these gases are used. Coal gas which contains 5 per cent. of carbonic oxide was, after the first experiments, used in place of pure carbonic oxide. The copper tubes were weighed before and after each experiment, and no decrease in their weight was ever found. With such a cell working through an external resistance of 0.1 ohm a current of 0.5 ampere was obtained, while with an external resistance of 50 ohms the difference of potential between the terminals was 0.4 volt.

With a cell in which the outer compartments were filled with copper turnings, in order to increase the absorption of carbonic oxide by exposing a greater surface, and by using coal gas in place of pure carbonic oxide, a maximum current of 0.64 ampere was obtained, and by increasing the external resistance a maximum difference of potential of 0.56 volt was maintained. The E.M.F. obtained by calculation from the heat developed in the combination of CO and O is 1.47 volts, so that in the above experiment 27 per cent. of the energy of combination of the fuel is converted into electrical energy. Since a solution of cuprous chloride dissolves hydrocarbons, powdered coal was tried in place of carbonic oxide, when a maximum current of 0.4 ampere and a maximum E.M.F. of 0.3 volt were obtained. The above E.M.F. (0.3) corresponds to about 15 per cent. of the energy corresponding to the oxidation of carbon. In the case of the coal-dust, even when the liquid was kept in motion, there was always a considerable falling off in the current, while the pollution of the electrolyte by the coal would quite prevent its use. With the gases, however, there is no falling off of the E.M.F., and this pollution of the electrolyte does not occur.

#### UNIVERSITY AND EDUCATIONAL INTELLIGENCE.

CAMBRIDGE.—Dr. R. D. Roberts has been appointed chief secretary for the University Extension scheme, in the room of Mr. A. Berry, who retires at the beginning of the Lent Term 1895.

The General Board of Studies report in favour of steps being taken to establish a closer connection between Addenbrooke's Hospital and the University teachers in the departments of medicine, surgery, and therapeutics.

The Syndics for State Medicine report that in the past year fifty-six candidates presented themselves for examination in this

subject, of these thirty-six received the University's diploma in Public Health.

Mr. H. Vule of Itham, University Lecturer in Geography, has been admitted by incorporation to the degree of M.A.

The *Proceedings of the Reporter* of December 3 contains a full report of the speeches delivered at a meeting in King's College for the purpose of promoting the foundation of a memorial library of Oriental literature in honour of the late Prof. Robertson Smith, editor of *The English and Oriental*.

SCIENTIFIC SERIAL.

*Transactions of the Royal Meteorological Society*, November.—Cyclonic precipitation in New England, by Prof. W. Upton. A list of cyclones was made out, including nearly all in which the precipitation had been general over New England, and the amounts and distribution noted on maps, with regard to the track of the minimum pressure. The velocity with which the storms passed ranged from fifteen to sixty miles per hour. The tables show that the heaviest rainfall is rarely found along the central path of the storm. Of the cyclones which came from the west across New England, only ten out of sixty-nine had their heaviest precipitation on or near the storm path, while forty-five had the maximum area on the right of the storm-track; similarly, out of eighty-four cyclones which moved from the west over New England, seventy-three had their maximum precipitation south of the storm-track. Further comments are reserved until the results of a study of the storms coming from the south are given.—The barometer at sea, by T. S. O'Leary. This paper deals with observations made chiefly by captains of American vessels. The author considers that a great step forward was made when the number of observations was reduced from twelve to one daily, the result being that the number of observers has increased nearly eight-fold. Another valuable feature is that the leaves of the log-books are forwarded to the central office as soon as opportunities are offered, so that the captains can see their observations made use of without delay. A simple plan for obtaining comparisons of the barometers has been adopted with very satisfactory results. The observers when in port record readings at certain hours, and forward them on post-cards to the central office, a copy of the "corrections" is immediately returned to them, and a copy filed for use and future reference.

SOCIETIES AND ACADEMIES.

LONDON.

Royal Society, November 15.—"The Pigments of the Genitalia: A Contribution to the Study of Excretory Substances which Occur in Ornament." By F. G. Howland Hopkins.

The various scales of the white Pierids are shown to contain uric acid, and to hence practically acting as a white pigment in these insects. A yellow pigment, widely distributed in the group, is shown to be a derivative of uric acid, and its artificial production as a by-product of the hydrolysis of uric acid is demonstrated. That this yellow pigment is an ordinary excretory product of the animal is indicated by the fact that an identical substance is voided from the rectum on emergence from the pupa.

The excretory pigments, which have well marked reactions, are also found in other Pierids, and are not found in other Lepidoptera. This fact enables the observation to be made that when a pupal mimesis an insect belonging to another group, the pigments of the mimicked and mimicking insects, respectively, are almost invariably distinct.

Other pigments existing not in the scales, but between the wing membranes, are described, and are shown sometimes to function ornamentally. The analysis, and the properties of the yellow and purple pigments are also given in the paper.

Physical Society, November 23.—Prof. Recker, F.R.S., President, in the chair. Mr. Womack read a paper on a modification of the ballistic galvanometer method of determining the electro-magnetic capacity of a condenser. The condenser employed in parallel with one arm of a Wheatstone's bridge arrangement of non-inductive resistances. A balance for the current having been obtained, the condenser is placed in circuit, and the throw of the needle of the battery key depends on it. The condenser is then thrown out of circuit, and

the proportionality of the arms of the bridge disturbed by changing the value of S to S +  $\delta$ S. The steady deflection due to this change is then read. From these two readings and the known values of S and  $\delta$ S the capacity is immediately determined. In practice readings of deflection may be taken with equal positive and negative values of  $\delta$ S. To avoid changes of E.M.F. of the battery, the author finds it best to use a reversing key in the battery circuit, and to observe the throw on reversing the current instead of on simply breaking it. One advantage of the method is that there is no need to know the galvanometer- or battery-resistance, and the author points out that it may be of service in the simultaneous determination of the resistance and of the joint capacity and inductance of a submarine cable or of a telephone or telegraph line. Prof. Perry asked what were the advantages of the method as compared with the Rayleigh-Sumpner method. Mr. Blakesley thought that the correction for damping in the ballistic part of the experiment might be avoided if in the second part the disturbance of balance due to the increment  $\delta$ S were measured by half the first throw of the needle on making the galvanometer circuit, instead of by the steady deflection. He doubted whether reversing the current in the battery circuit would have just twice the effect of simply breaking the circuit. In reply, Mr. Womack said he had not tried the method of reading suggested by Mr. Blakesley, but with regard to the reversing of the battery circuit, that was found to give in practice as nearly as possible twice the deflection which resulted from simply breaking.—A paper, by Prof. S. P. Thompson and Mr. Miles Walker, on mirrors of magnetism, was read by Prof. Thompson. It was pointed out that, corresponding to the theory of electric images produced by insulated conductors, there is a theory of magnetic images produced by bodies of infinite magnetic permeability. A magnet pole in the latter theory is the analogue of an electric charge in the former, and a body of infinite magnetic permeability is the analogue of an insulated conductor (which is electrostatically indistinguishable from a body of infinite dielectric capacity). Experiments were made to determine how far the magnetic images due to thick sheets of iron accorded with those deduced by theory for the case of infinite permeability. The image of a north pole in an infinite plane sheet should consist of a south pole of the same strength at a point coinciding with the optical image of the north pole, together with an equal north pole distributed uniformly over the surface of the infinite sheet, as a free electrical charge would be, and so exerting no finite action. Working at distances of a few inches in front of the surface, a sheet of iron a few feet in length and breadth, and a couple of inches thick, was found to realise the theoretical conditions with very tolerable exactness. In a coil of wire placed on one side of the sheet a current was started or stopped, and the electromotive impulse produced in a subsidiary exploring coil was detected by means of a ballistic galvanometer. That the effect of the actual mirror was equivalent to that of the theoretical image, was verified by substituting for the iron a coil equal and similar to the first, and coinciding with its optical image. Sending the same primary current as before round the two coils (with due regard to its direction in the second coil), hardly any appreciable difference in the secondary impulse was observed. This was found to hold good whether the original primary coil had its axis perpendicular or oblique to the plane of the magnetic mirror. Some observations on spherical sheets were also recorded, but in this case the conclusions were less simple. The paper was followed by a discussion, in which Mr. Blyss, Prof. Perry, Prof. Ayrton, Dr. Burton, Mr. W. Bailey, and Prof. Carey Foster took part.—Prof. Ayrton exhibited a student's apparatus for verifying Ohm's law, designed by himself and Mr. Mather. The current flowing through a circuit is to be measured (not necessarily in terms of any defined unit) by means of a galvanometer, while the potential-difference between two fixed points is measured by means of an idiostatic electrometer. Within small limits of experimental error, the current and potential-difference are found to vary in the same proportion; but the electrometer and its manner of use constituted the chief interest of the paper. The fixed and moving parts (inductors and needle) are alike cylindrical in form (the term being understood in its most unrestricted sense), and the generating lines are vertical. There is a vertical axis of symmetry, such that the disposition of these cylindrical parts would remain unchanged if the instrument were rotated through 180° about the axis. The needle is hung by a very thin phosphor-

bronze strip, and to obtain a reading when it differs in potential from the inductors by an amount which we have to measure, it is brought back to its ordinary zero position by turning a torsion-head to which the upper end of the suspending strip is fixed. The potential difference is then proportional to the square root of the angle through which the torsion-head has been turned, but the E.M.F. of a moderate battery of accumulators can be read with very fair accuracy. The authors have bestowed great care on the design of the needle, so that, for a given potential-difference, the turning-moment divided by the moment of inertia may be as great as possible. The whole instrument is protected from external inductive influence by having the inner surface of its glass case coated with a transparent conducting varnish, which Prof. Ayrton has described elsewhere.—Prof. Ayrton also showed an idiostatic electrometer, whose needle, instead of being suspended, was pivoted on an axle. The instrument is rapid and nearly dead-beat in action, and gives a scale-reading of about three inches for an E.M.F. of 100 volts. Prof. S. P. Thompson expressed great admiration for the instruments exhibited, but denied that the law which they served to prove was Ohm's law at all; and this led to some discussion as to what Ohm's law really is. Prof. Ayrton briefly replied.

**Chemical Society, November 1.**—Dr. Armstrong, President, in the chair.—The following papers were read: The electromotive force of alloys in a voltaic cell, by A. P. Laurie.—Determinations of the E.M.F. developed by sixteen alloys of the heavy metals confirm Matthiessen's conclusion that the tinfoil alloy is the only definite compound amongst them.—A product of the action of nitric oxide on sodium ethylate, by G. W. MacDonald, and O. Masson. Nitric oxide is absorbed by an alcoholic solution of sodium ethylate with formation of an explosive salt, probably the sodium salt of methylenedihydroxynitrosamine,  $\text{CH}_2[\text{N}(\text{NO})\text{OH}]_2$ . The incomplete combustion of some gaseous carbon compounds, by W. A. Bone and J. C. Cain. When a hydrocarbon containing  $n$  atoms of carbon is burnt with  $n$  atoms of oxygen, the interaction may be represented by the following equation:  $\text{C}_n\text{H}_2 + \text{O}_2 =$

$n\text{CO} + \frac{n}{2}\text{H}_2$ .—Derivatives of tetramethylene, by W. II. Perkin, jun. A number of halogen and hydroxy-derivatives of tetramethylene and tetramethylenedicarboxylic acid are described. Pentamethylenedicarboxylic acid,

$\text{CH}_2 \begin{array}{c} \diagup \text{CH}_2 \cdot \text{CH} \cdot \text{COOH} \\ | \\ \text{CH}_2 \cdot \text{CH} \cdot \text{COOH} \\ \diagdown \end{array}$ , by E. Haworth and W. II. Perkin,

jun. A number of derivatives of this acid are described.—Substituted pimelic acids, by A. W. Crossley and W. H. Perkin, jun. The authors have succeeded in preparing ethyl and methylethyl-pimelic acid, and also describe several other new aliphatic acids.—Homologues of butanetetracarboxylic acid and of adipic acid, by B. Lean. The disodio-derivative of ethylic butanetetracarboxylate reacts readily with the alkyl iodides or chlorides yielding derivatives which on hydrolysis are converted into tetracarboxylic acids of the constitution,  $\text{CR}(\text{COOH})_2 \cdot \text{CH}_2 \cdot \text{CH}_2 \cdot \text{CR}(\text{COOH})_2$ ; on heating these acids, di-substituted adipic acids are obtained.—Contributions to the chemistry of cellulose. (1) Cellulose sulphuric acid, and the products of its hydrolysis, by A. I. Stern. Cellulose disulphuric acid,  $\text{C}_6\text{H}_8\text{O}_2(\text{HSO}_4)_2$ , is obtained by dissolving cellulose in sulphuric acid; on hydrolysis, it yields first cellulose monosulphuric acid, and then products containing less sulphur.—The chlorination of aniline, by J. J. Sudborough.—Condensation of benzil with ethyl malonate, by F. R. Japp and W. B. Davidson. Benzil and ethylic malonate condense yielding monoethylic benzoylmalonate  $\text{COPh} \cdot \text{CPh}(\text{OH}) \cdot \text{CH}(\text{COOH})\text{COOEt}$ , and desylenemalonic acid  $\text{COPh} \cdot \text{CPh} \cdot \text{C}(\text{COOH})_2$ .

**Linnean Society, November 15.**—Mr. C. B. Clarke, F.R.S., President, in the chair.—Mr. J. E. S. Moore exhibited preparations illustrative of his investigations concerning the origin and nature of the achromatic spindle in the spermatocytes of elasmobranch fishes. His results were approximately in agreement with those arrived at by Hermann in regard to the corresponding elements in amphibia, and more in accord with those of Ishikawa relating to the division of noctilaca. As to the spindle fibres themselves, it appeared that during the diastal stage of the division they were the optical expression of thickenings in the wall of a membranous cylinder stretched out

between the chromosomes.—The Rev. G. Henslow exhibited some curious iron implements of somewhat varied pattern, used in Egypt for cutting off the top of the Alexandrine fig, *Ficus Sycamorus*, Linn., the operation being necessary to render it edible by getting rid of the parasitic insect *Syophaga crassipes*, Westwood, with which it is always infested. The practice was said to be very ancient, being described by Theophrastus, and alluded to by the same word, *κρίσαν*, in the septuagint version of the Old Testament (Amos vii. 14) in translating from the Hebrew.—Mr. H. N. Ridley showed some drawings of the green larva of a sphinx moth mimicking a green tree snake, *Trimeresurus Wayleri*, as well as a cluster of caterpillars mimicking a fruit, all of which were found in Singapore. He also exhibited a drawing from life of the tan-producing gumbr-plant (*Uncaria Gambir*) in flower.—Mr. Thomas Christy exhibited some germinating seeds of pepper showing the testa being carried up by the cotyledons.—A paper was then read by Dr. D. Prain, on the plant-yielding Bhang *Cannabis sativa*. Illustrating by lantern slides the anatomy of flower and fruit in *Cannabis*, he reviewed the theories propounded of their structure; confirmed from teratology those of Payer (1857) and Celakovsky (1875), and refuted those of B. Clarke (1853) and Macchiati (1889). He then explained (1) the prevention of fertilisation for development of narcotic properties, and (2) of the various forms of the narcotic to each other. A series of mono-cious conditions described in plants of both sexes show that the so-called ♂ flower is probably an inflorescence, the perianth segments being bracts, not sepals, while the stamen is the homologue of the anterior sterile carpel of the ♀ flower.—A paper, on the proposed revision of the British Copepoda, by Mr. Thomas Scott, was, in the unavoidable absence of the author, read by the secretary.

**Geological Society, November 21.**—Dr. Henry Woodward, F.R.S., President, in the chair.—The Pleistocene beds of the Maltese Islands, by John H. Cooke. An especially noticeable feature of these beds is the absence of ordinary anticlinal and synclinal folding, and the predominance of monoclinal faults, which largely affect the character of the surface. These faults were formed prior to the deposition of the Pleistocene beds. The plateaux of Malta, rising to a height of 600–800 feet above sea-level, occur south of the great east-and-west fault, which has a downthrow to the north. They have no Pleistocene deposits upon their summits. Three classes of superficial deposits were described, namely: (1) Valley-deposits; (2) agglomerates and breccias found along coast-lines and fault-terraces, always at the foot of the fault-terraces, or along the lower slopes of the depressed areas; (3) ossiferous deposits of caves and fissures.—Geological notes of a journey in Madagascar, by the Rev. R. Baron.—On a collection of fossils from Madagascar obtained by the Rev. R. Baron, by R. Bullen Newton.

**Mineralogical Society.**—Anniversary meeting, November 20.—Prof. N. S. Maskelyne, F.R.S., President, in the chair.—The annual report of Council was read and adopted.—The following were elected ordinary members of Council: Prof. A. H. Green, F.R.S., Mr. A. Harker, Mr. A. E. Tutton, and Mr. W. W. Watts, in place of the four retiring members; in other respects the list of officers and Council remains unchanged. The following papers were read: On cone-in-cone structure, by the Rev. Prof. T. G. Bonney, F.R.S.; confirming and extending the views previously published by Prof. Cole.—On a basic ferric sulphate from Parys Mount, Anglesey, by Prof. A. H. Church, F.R.S.; containing the analysis of an earthy mineral corresponding to a compound of one molecule of coquimbite with five molecules of normal ferric hydrate.—Angelite, by Mr. G. T. Prior and Mr. L. J. Spencer; containing a full account of the chemical, physical and crystallographical characters of specimens from Machacamara, Bolivia, of a mineral previously described only from massive material found in Sweden.—On the occurrence of delessite in Cantyre, by Prof. M. F. Heddle and Mr. J. S. Thomson; containing two analyses of the mineral.—Specimens of angelite, and of a beautiful opal cast of a bivalve from Australia, were exhibited.

## PARIS.

**Academy of Sciences, November 26.**—M. Lœwy in the chair.—Photographic studies of some parts of the lunar surface, by M. M. Lœwy and Puisseux. The need of care in interpreting photographs taken under ordinary conditions is emphasised; the many ways in which accidental circumstances may produce

may be considered as a case where the more obscure details shall be fully explained by a corresponding correspondence in form and extent on different negatives. Again, the tendency to aggregation of the retained silver in the negative destroys all value in enlargements carried beyond a certain limit, say thirty or forty times the original size. Certain clear negatives, obtained at Paris on February 13 and March 14, have been enlarged by Dr. W. L. G. and compared with the best maps of the corresponding region, with the result that many new details, fully described on the paper, have been added to our knowledge of the moon's surface.—A note on the calculation of the orbits of planets, by M. F. Tisserand.—A note on the orbit of Wolf's planet (1894 B.F.), made with the Bessel's equation, by M. G. Kavel.—On the laws of air resistance, by M. E. Vallier. Formule are derived which express the specific resistance of air to a moving body ( $v$ ) where the velocity is greater than 330 metres, and where the velocity is less than 100 metres per second.—New data concerning the Nymphonia, a tertiary Nymphonia, by M. G. de Seta.—The elements of the planet B.F., by M. L. Sédille.—Observations of Swift's new comet F. 1894, November 2, from the Paris Observatory, by M. G. Liguari.—On the distribution of planets between Mars and Jupiter, by M. L. Roger. A mathematical paper in which the author endeavours to obtain, from the known distribution of the minor planets, some support for a hypothesis formulated in a previous communication (*Congress-ventue*, to exist on the movement of a solid body, by M. G. Koenigs).

On an application of the principle of areas, by M. L. Lecointre.—On functional equations, by M. Leau.—On Bertrand's theorem, by M. Cartan.—A *Mémoire* concerning M. P. S. de la notation on the problems of dynamics of which the differential equations admit an infinitesimal transformation, M. G. S. published a paper on this subject in 1892. M. S. has recently extended the theorems therein demonstrated from two and three to  $n$  variables.—On the tempest of November 12, 1894, by M. Alfred Angot. A tabular comparison is made between data obtained at the Meteorological Bureau and on the Eiffel Tower, respectively. Interesting conclusions are drawn from the tower observations, which are free from the disturbances ordinarily brought in owing to the nearness of the surface of the soil.—On the conversion of propionic acid into lactic acid, by M. Fernand Gaul. By heating a mixture of 10 per cent of amylic alcohol with Fehling's solution for 200 hours at 24°, the author has obtained both the ordinary and isomeric lactic acids. As metallic copper is produced on heating copper propionate with excess of water at 200°, the equation representing the production of the lactic acid must be written  $2C_2H_5CO_2Cu + 2H_2O = 2C_2H_5CO_2H + 2C_2H_5O_2$ .—On the ethereal salts derived from active amylic alcohol, by MM. Paul A. Guye and L. Chavanne. The specific rotations are given for a number of these esters, the maximum value is 20° for the ethyl ester with amylic propionate. The product of asymmetry reaches its maximum with amylic acetate.—On the synthesis of organic chlorine of the gastric juice, by M. H. L. L. A direct method of determining *organic chlorine* is described, and it is pointed out that the *organic* chlorine of MM. Hayen and Winter is partly derived from ammonium chloride, which is itself partly formed at a high temperature from the cyan chloride present. On the composition of the red pigment from *Lygodium filix-foemina*, by M. A. B. Griffiths. The analytical results give the formula  $C_{12}H_{12}N_2O_4$  for the dry residue. On acid leathers, by MM. Ballard and Mahéan.—A new optical phenomenon, by M. S. Tchiriew. The principle of chemistry or physiological synthesis of colour, by M. W. S. On the effects of ablation of the venom glands in the spider *Theridion*, Linn., by MM. C. Phisalix and G. Bertrand. Contributions to the study of the "cellule connective" in the molluscs Gasteropods, by M. Joannes Chatin.—A new method for the cultivation of fish-ponds, by M. J. J. de Bellesme. The reptiles of the upper jurassic age in the Boulonnais, by M. H. F. Sauvage.—On the new ivory human stilette from the prehistoric station at Brassempouty, by M. L. Piette.—Influence of arsenic acid on the growth of algae, by M. Raoul Bonilland. It is shown that arsenic acid in certain cases acts like phosphoric acid, which it may replace in some plant cultivations.—On the age of Lake Bourget and the ancient alluvial deposits of Chambéry and the valley of the Isère, by M. A. Delebecque.

BOOKS, PAMPHLETS, and SERIALS RECEIVED

Province of South Australia: J. D. Woods (Adelaide, Brisbane).—The Mathematics of Waves: J. W. Foy (Melbourne).—Meteorology: Practical and Applied: Dr. J. W. Moore (Rebman).—Life of Richard Owen: Rev. R. Owen. 2 Vols. (Murray).—Elements of Astrology: G. W. Parker (London).—A Handbook to the Order Lepidoptera: Part 1, Butterflies, Vol. 1; W. P. Kirby (Allen).—A Handbook to the Primates: Dr. H. O. F. Vol. 1; 2 Vols. (Allen).—Iswald's Klassiker der Exakten Wissenschaften: N. S. 125 (Leipzig, Engelmann).—Physikalische Kryptallographie: P. G. Th. Dörre Auflage, Part 1 and 2 Aethig. (Leipzig, Engelmann).—Grundriss der Physik: E. O. Knappe (Leipzig, Engelmann).—Portraits berühmter Naturforscher (Wien, Richter).—The Iron-bearing Rocks of the Mesozoic Range in Minnesota: J. E. Spurr (Minneapolis).—Cul. Deposits of Iowa: C. R. Keyes (De Moines).—U. S. Geological Survey, Twelfth Annual Report, 1893, Part 1, Geology; Part 2, Irrigation (Washington).—Ditto, Thirtieth Annual Report, Part 1, Report of Director; Part 2, Geology; Part 3, Irrigation (Washington).—N. Z. Papers and Reports relating to Minerals and Mining (Wellington).—Annuaire de l'Observatoire de Meudon de Mémoires, 1893 (Paris, Gauthier-Villars).—Ketchen-Boiler Explosions: R. D. Munn (Griffin).—The Elementary Properties of the Lame Functions: Prof. A. C. Dixon (Macmillan).—Birds of the West and Woodland: P. Robinson (Lisister).—Elementary Commercial Geography: Dr. E. K. Mill, 2nd edition (Cambridge University Press).—An Introduction to the Theory of Electricity: L. Cummings edition (Macmillan).—Symbolic Logic: Dr. I. Venn, 2nd edition (Macmillan).—Eten. Verum, edited by J. Watson (Rider).—The Cyclopaedia of Names: edited by P. T. Smith (Cuswin).

Geological and Natural History of Minnesota: N. H. Washell (Minneapolis).—Magnetic Observations made at the U.S. Naval Observatory during the Year 1893: Prof. S. J. Brown (Washington).—Meteorological Observations and Results, U.S. Naval Observatory, 1893 (Washington).—The Warlike Fly: P. A. Ormerod (Stimpkin).—American Magazine of Natural History, Annual Report for 1893 (New York).

Archiv für Entwickelungsmechanik der Organismen: Prof. W. Roux, Erster Band, Erstes Heft (Leipzig, Engelmann).—Studies from the Yale Psychological Laboratory, Vol. 2 (New Haven).—Biology Notes, Nos. 1 and 2 (Chelmsford).—Bulletin of the American Mathematical Society, 2nd series, Vol. 1, No. 2 (New York, Macmillan).—School Review, November (Haddon, New York).—Journal of the College of Science, Imperial University of Japan, Vol. 6, Part 1 (Tokyo, Japan).—Contemporary Review, December (London).—Proceedings and Transactions of the Nova Scotian Institute of Science, Halifax, second series, Vol. 1, Part 1 (Halifax).—Proceedings of the American Philological Society, June (Philadelphia).—Transactions of the Academy of Science of St. Louis, Vol. 6, Nos. 4 to 17 (St. Louis).—Quarterly Journal of Microscopical Science, November (Chelmsford).—Fortschritt-Review, December (Chapman).—Morphologisch-jahrbuch, Band 1, Heft 1 (Leipzig, Engelmann).—Zeitschrift für Physikalische Chemie, 20. Band, 3. Heft (Leipzig, Engelmann).—National Review, December Available Science Magazine, December (Lond).

CONTENTS.

PAGE

Peculiarities of Psychological Research. By H. G. Wells . . . . .	121
The Beginnings of History . . . . .	122
The Transmission of Power. By G. F. . . . .	124
Our Book Shelf:—	
Stevenson: "A Treatise on Hygiene and Public Health" . . . . .	124
Kalpa: "Involution and Evolution according to the Philosophical of Cycles" . . . . .	125
Muir: "The Mountains of California" . . . . .	125
Letters to the Editor:—	
Origin of Classes among the "Parasol" Ants. — Herbert Spencer . . . . .	125
"Acquired Characters." — J. T. Cunningham; Prof. Edward B. Poulton, F.R.S. . . . .	126
The Homing of Lampets. — Prof. C. Lloyd Morgan . . . . .	127
Gravitation. — Dr. J. Joly, F.R.S. . . . .	127
The Ratio of the Specific Heats of Gases. — S. H. Burbury, F.R.S. . . . .	127
An Observation on Moths. — Henry Cecil . . . . .	127
Snakes "Playing Possum." — G. E. Hadow . . . . .	127
Volcanic Stalactites. ( <i>Illustrated</i> ) . . . . .	128
Notes . . . . .	129
Our Astronomical Column:—	
The New Comet . . . . .	132
The Spectrum of Mars . . . . .	132
The Anniversary Meeting of the Royal Society . . . . .	132
The Battle of the Forests. II. By Prof. B. E. Fernow . . . . .	139
The Relation of Energy of Combination to Electrical Energy . . . . .	141
University and Educational Intelligence . . . . .	141
Scientific Serial . . . . .	142
Societies and Academies . . . . .	142
Books, Pamphlets, and Serials Received . . . . .	144

THURSDAY, DECEMBER 13, 1894.

## DILETTANTISM AND STATISTICS.

*The Growth of St. Louis Children.* By William Townsend Porter. Vol. vi. No 12: Transactions of the Academy of Science of St. Louis.

THE anthropometrical researches of Mr. Francis Galton have had a very widespread influence, and, under his inspiration, a large mass of material has been, and is being collected, which cannot fail to be of service in elucidating a number of knotty problems. In particular, very comprehensive measurements of children have been made in America by Bowditch, Sargant, and Porter, the results being tabulated by aid of Mr. Galton's method of percentiles.

It is not only in the form of statistics of measurements on man, but also of measurements on the lower animals and on plants, that material for the study of variation and correlation is accumulating with almost alarming rapidity. We say with almost alarming rapidity, for not only is theory lagging somewhat behind the needs of statistical experience, but, what is far worse, many collectors have no real insight into the theory which does exist. They are tabulating results in a form which will be of no permanent service, or neglecting to publish the very details which alone would enable us to test any development of statistical theory. The ignorance of the elements of mathematics, to say nothing of the theory of chance, is, indeed, singularly characteristic of many investigators, who think statistics can be handled, and conclusions drawn from them, without the least preliminary training. For example, in a recent paper on variation in the flowers of buttercups and clover, by Herr de Vries, we are introduced to our old friend the normal curve of errors as a definite symmetrical polygon; no attempt is made to fit it by aid of the probable error of the observations, but a particular form of it, apparently selected at random, is plumped down on the top of another polygon representing the observations. The odds against the thus selected theoretical polygon (curiously called the "Galton Curve") expressing the real distribution of variation, are, it is needless to say, many thousands to one. Still more curiously, sets of observations giving theoretically very good frequency curves of the type which occurs in infantile mortality, the valuation of houses, &c., are termed "Half-Galton-Curves," although the type, so far from being represented by the half of the normal curve of errors, corresponds to a curve asymptotic to the ordinate of maximum frequency! We might pass these eccentricities by, were not statistics thus handled used to support some vague theory of heredity, or to question some principle of variation.

Mr. Porter is not quite so wild in theory as Herr de Vries, but for him also the normal curve of errors appears to be a polygon, and he tells us, on p. 277, after a table of its ordinates—which are quoted from Thoma, and given only to the units, and *not to decims*—"that there is a limit beyond which no deviation occurs." It is, perhaps, needless to say that if we start only with a knowledge of the theory of chance, such as may be found in

works like those of Thoma and Stieda, we are hardly likely to avoid bad theoretical blunders. Mr. Porter is no worse than many writers of memoirs in the *Journal of the Royal Statistical Society*; but the time has come when statistics, as well as archæology, must be taken out of the hands of the dilettanti, and when a man, if he takes upon himself to publish statistical researches, must, like the physicist, show his credentials in the form of a fair mathematical training.

Unfortunately, Mr. Galton's method of percentiles, useful as it is in the right place, is now acting as a distinct check to statistical theory in a somewhat unexpected manner. Before that theory was disseminated the dilettante statistician was compelled to publish his raw material, and his remarks on it did not impair its value to the trained scientist. Now, however, the percentile method of dealing with statistics seems so intelligible, that the non-mathematical anthropologist or physiologist grasps it at once, reserves his raw material, and publishes tables of percentiles. It is hard to conceive anything more disastrous for true statistical progress.

The reason for this is easily explained. As is well known, any normal curve of errors can be reduced to any other by uniform stretches (or squeezes) parallel to its base and its axis. The area of any portion of any normal curve up to a deviation of given magnitude cannot be given by a finite series; it can by stretching be reduced to an integral, the values of which are tabulated, but which is not itself finitely expressible for an indefinite value of the deviation. The tables formed of this integral, however, enable us to pass from selected percentiles to the constants, and so to the form of the frequency curve. Now, innumerable frequency curves in biological, just as in economical statistics, are *not* of the normal type. A generalised frequency curve can be theoretically obtained fitting closely the observations in many, perhaps in all such cases, but owing to its asymmetry or skewness, its limited range and other features, it neither possesses the stretch property of the normal curve, nor can its areas be expressed by tables of one entry. The tables required are, according to the type, of two or three entries, and such tables are not likely to be prepared for a long time to come, and if prepared, would be of little service except for the case when the statistics are given in percentiles. In other words, the use of percentiles may suffice to demonstrate the skewness of the statistics, but at once precludes the use of any theory higher than that of the normal curve, by which the skewness could be accounted for. This is the fundamental defect of Mr. Porter's labours. He gives us a most extensive system of measurement on boys and girls from six to twenty years of age—ample material, if properly dealt with, to provide solutions for innumerable problems in correlation and selection with age. The material, however, is only given in the form of percentiles or in diagrams of the "ogive" curve corresponding to the integral of the frequency curve. These diagrams fully confirm the results of Bowditch—that *the statistics are skew, and that the degree of skewness varies with the age*. But all means of scientifically treating this skewness disappear, because we have only percentile results. The skewness of the original frequency curve cannot be deduced from nine or ten points on a curve, the equation of which is only expressible by an unintegratable form containing the con-

stants to be determined. This is all the more tantalising, as the variation with age or with selection of the skewness of the frequency curve for a given organ is very probably a most important factor in the mathematical treatment of evolution, while it is precisely *latter* material which enables us to record the age, too often an unknown quantity in investigations on the lower animals. It must not be supposed, however, that Mr. Porter realises that skewness in the percentiles marks want of normality in the frequency curve. On the contrary, he takes the raw material for the height of 2192 girls aged eight, and fits it, not very accurately, to a normal frequency distribution. Although the measurements better fit a skew than a normal distribution, the divergence from the normal is not very marked, and Mr. Porter writes:

"It is not necessary to make this comparison at more than one age, or in more than one dimension, for it is known that if one series in a group like that with which we have to deal shows this agreement, the other series will be found to do the same." (p. 290.)

Now the whole point of the measurements, if properly interpreted, is to ascertain the varying degree of skewness with age, *i.e.* the varying amount of divergence from the normal curve. To emphasise this divergence when remarking on his raw material, but to fail to recognise what bearing it has on theory, is typical of the untrained statistician.

As we have seen, the use of percentiles renders Mr. Porter's material of small value for the problem of selection. The same remark again applies in the case of correlation. The ten organs measured would have been most valuable material for the problem of correlation; the percentile results alone being given, nothing can be done. In Chapter ix. Mr. Porter does develop a theory of correlation, which, however, seems to us absolutely erroneous. As he makes it the basis of a scheme for the school physician to testify whether the pupil's strength is equal to the strain put upon it, this want of accurate theoretical knowledge appears doubly unfortunate.

We have ventured to point out these failings in Mr. Porter's work, not because they are peculiar to him—they are characteristic of much work of a statistical kind which is now being turned out in both Europe and America—but rather because they point to a new need, which the public has hardly yet recognised. There has been up to the present time—with the honourable exception of courses of lectures by Dr. Venn in Cambridge—no teaching of statistical theory in England. There is no chair of statistics in any English university, and the Newmarch lectureship at University College, except for the year of its tenancy by Prof. Edgeworth, has been held by economists, and not by mathematically trained statisticians. We want a centre, which shall not only contain a statistical museum, but embrace as well a statistical laboratory and workshop. In such a centre students might not only receive a mathematical training in dealing with raw statistics, but also be exercised in the methods of collecting and tabulating, which must precede mathematical reduction. To such a centre the biologist and anthropometrist could send their measurements to be plotted, the physicist his observations to be dealt with, and the economist or sociologist his price or labour

statistics to be analysed. At the same time, absolute measurements might be made bearing on the problems of evolution, disease and national economy. In this manner a number of efficient young statisticians might be trained, who would not only find a life-work ready for them in craniology, zoology, botany, and economics, but who, passing into government departments, census offices and labour bureaus, might remove from us the reproach of a recent continental writer, that nowhere were statistical dilettanti so rampant as in England.

KARL PEARSON.

#### WATER SUPPLY AND WATER-WORKS.

*The Principles of Water-works Engineering.* By J. H. Tuftsbery Turner and A. W. Brightmore. (London: Spon, 1893.)

*The Water Supply of Towns.* By W. K. Burton. (London: Crosby Lockwood and Son, 1894.)

WITH the constant growth of population, and the increasing tendency of the population to congregate into large towns, the provision of an ample supply of pure water to towns becomes every year of greater importance; whilst, as the nearer sources of supply become inadequate for the ever-growing demands, a sufficient supply becomes more difficult to obtain, and has to be sought at considerable distances. Accordingly, the subject of water-supply has assumed an enhanced importance within recent years; and till these books appeared, there was a dearth of comprehensive textbooks on this branch of engineering. As the sources of water-supply, and the works for its provision and distribution are comprised within very definite limits, both books necessarily traverse much the same ground, and deal with similar classes of works; but, nevertheless, they exhibit differences in arrangement, and in the method of treating the various subjects. Thus, whereas "Water-works Engineering" extends over 420 pages, separated into only eight chapters, and illustrated by one hundred and twenty figures in the text, "The Water Supply of Towns" is subdivided into twenty-two chapters, occupying only 272 pages, somewhat larger in size, but illustrated by two hundred and fifty-seven drawings, several of which are put into forty-three large folding-plates. The first book, moreover, is subdivided into numbered sections, the numbers of which are merely used for reference, and instead of the pages in the index; whilst the various subjects in the second book are clearly indicated by black-letter headings. Altogether, "The Water Supply of Towns" is much better arranged for reference; and though containing slightly less matter, it is much more fully illustrated, is in larger print, and has a somewhat longer index than "Water-works Engineering." Neither book gives a summary of contents at the head of each chapter, which is often serviceable for reference.

In "Water-works Engineering," the sources, measurement, collection, storage, purification, conveyance, and distribution of water, and the maintenance of water-works, are successively dealt with in the eight chapters. The most logical sequence would be to describe in regular order the various processes to which water is subjected, from its source up to its delivery to the consumer.



This has only been partially accomplished in "Water-works Engineering," for, owing to the small number of chapters, such dissimilar subjects as the available rainfall and the gauging of the flow of streams have been put in the same chapter, near the beginning of the book, with water-meters, which latter subject should properly have been dealt with at the end, in connection with consumption and waste. Moreover, impounding reservoirs and dams are grouped with service reservoirs, tanks, and house cisterns; whilst the filtration, purification, and softening of water, are considered before the preliminary process of conveyance from the source of supply by aqueducts and conduits. Though the grouping of dissimilar subjects has been avoided in "The Water-Supply of Towns" by the multiplication of chapters, the natural sequence of processes has not been always maintained: for the chapters on pumping machinery, and the flow of water in conduits and open channels, follow after the chapters on purification; whereas the flow of water is intimately connected with the conveyance of the supply from impounding reservoirs; and purification and softening are more needed for waters pumped out of rivers, or from wells, than for waters impounded in a reservoir in a mountainous uninhabited district. In this book, however, the descriptions of water-meters are given in the chapter on the prevention of waste of water, to which subject they properly belong; and cisterns are referred to in this connection, as well as in relation to distribution.

The most notable difference between these two books consists in the use made of mathematical calculations and formulæ. Prof. Burton rarely introduces any formulæ, contenting himself, in the case of high masonry dams, with diagrams of the theoretical profiles proposed by Prof. Rankine and Mr. Wergmann, in addition to the actual sections of the Vyrnwy dam in Wales, and the Tytam dam at Hong Kong; whilst he refers his readers to Fanning's "Treatise on Hydraulics and Water-works Engineering" for formulæ relating to the flow of water. A less cursory treatment of these important subjects, in relation to water-supply, might reasonably be expected in a book which is stated, on its title-page, to be "a practical treatise for the use of engineers and students of engineering"; but perhaps Prof. Burton exercised a wise discretion in this matter, for in the calculation of the cross-section of a stream, on page 28, he falls into an obvious error in including the depths at both extremities to obtain the average depth. The authors of "Water-works Engineering," on the contrary, incline towards the other extreme, and devote more attention to mathematical solutions than to practical considerations. Some amount of mathematical treatment is unquestionably expedient in dealing with the flow of water and the design of masonry dams; and formulæ based upon experience, together with diagrams, furnish almost indispensable aids in the consideration of these matters, and for their practical application. It is, however, an undue extension of the province of mathematics, in such a treatise, to use them to prove that impalpably fine matter in suspension in water would never fully settle (pp. 266-7), which is a subject for physical experiment; and the result would vary with the nature of the material and its specific gravity. Moreover, considering the uncertainties that

exist as to the precise distribution of the pressures over the masonry of a reservoir dam, it appears somewhat superfluous to devote over two pages in calculations proving that wind pressure against the outer face of a masonry dam has only a very slight influence in modifying the position of the line of resultant pressures, with the reservoir empty, under the exceptional conditions of a high wind blowing up the valley, and the reservoir being empty. The somewhat free use of mathematical processes, and the occasional introduction of the integral calculus, will unfortunately be liable to deter persons, who have not received a regular mathematical training, from consulting "Water-works Engineering"; though the greater part of the book deals clearly and concisely with the practical matters and works relating to this branch of engineering. More frequent references to executed works, by way of illustration, would have added interest to the book, and would have served to exhibit the methods of application of general principles, and their results: but the authors explain in their preface, that they considered descriptions of works outside the scope of their book. Owing doubtless to their having lived in cities supplied from wells and impounding reservoirs, they condemn the quality of river waters in stronger terms than the inhabitants of London, deriving a large proportion of their supply from the Thames, would be prepared to admit as correct. They say: "The quality of river-water is seldom unexceptionable, and is frequently bad. . . Rivers are generally charged with impurities of vegetable, animal, and mineral origin, to such an extent as to render them frequently a most desirable source of water for irrigation purposes, but not for domestic supply." After this it is only a slight consolation to be told that, "still, by certain processes, even the most unpromising river-water is often rendered generally serviceable," especially as, shortly after, they quote the statement of the Rivers Pollution Commission of 1868, that "there is no river in the United Kingdom long enough to effect the destruction by oxidation of sewage put into it at its source," and add, in conclusion, that "the result of the aëration produced by even the Falls of Niagara is so insignificant as to be insensible so far as regards any purifying effect upon the water."

As the author of "The Water Supply of Towns" is Professor of Sanitary Engineering in the University of Tokyo, he has naturally inserted some matters relating more particularly to Japan, such as, for instance, certain special provisions for the extinction of fires which are very common in Japan, owing to the light construction of the houses, and more especially the probable effects of earthquakes on water-works, and the precautions to be taken against them. Most, however, of these special matters have been relegated to foot-notes and an appendix; whilst some particulars of general interest relating to the Tokyo water-works are given in the text.

Both books contain a fairly complete exposition of the principles relating to the water supply of towns, and a general description of the construction of water-works; and they should both prove valuable to the engineer and the student, in relation to this special branch of engineering. Whilst, however, the engineering student, who has had the advantage of a mathematical and scientific training, will doubtless prefer the more scientific metho-

exhibited in "The Principles of Water-works Engineering," the practical engineer will obtain fuller information, with less trouble, from the more clearly arranged and better illustrated pages of "The Water Supply of Towns."

#### HAMILTON'S PATHOLOGY.

*A Text-book of Pathology, Systematic and Practical.*  
By D. J. Hamilton, M.B., F.R.C.S.E., F.R.S.E.,  
Professor of Pathology, University of Aberdeen.  
Vol. II. Parts 1 and 2. London: Macmillan and Co.,  
1894.)

THESE two handsome volumes complete the laborious task which Prof. Hamilton set himself many years ago, of producing a text-book of pathology, which should include not merely morbid anatomy and histology, but should deal also with clinical medicine, and those new but rapidly developing sciences, pathological chemistry, pathological physiology, and bacteriology.

It is true that the many varied problems which come before a pathologist require for their solution a more or less extensive acquaintance with each and all of these branches. So many, however, are the workers, and so vast has the literature become in each branch, that it is already impossible for anyone to be equally proficient in all, and it is necessary to specialise.

If this is the case with the individual, it is much more so with the text-book. It is impossible to compress within even 1800 pages, a tithe of our present knowledge of all these branches, and opinions will differ widely as to how the selection should be made.

The task of making such a selection is herculean enough to daunt any man, and the thanks of all interested in pathology are due to the Professor for the very valuable addition he has made to our literature on the subject. The amount of original work is considerable, and the volumes are copiously illustrated by drawings, the majority of which are by the author.

An extremely useful feature in the book consists in the bibliography of both the English and foreign literature at the end of each section. The convenient system is also adopted of indicating the title of any publication referred to in the text by a number in Roman letters, while the full titles and the corresponding numbers are given in a list at the end of the book. The first volume, which was reviewed in these columns in 1889, met with general appreciation. This volume commenced with full directions for making systematic post-mortem inspections, and for the practical bacteriology and histology of the tissues removed. Nearly 200 pages were devoted to a full account of inflammation and suppuration, and of tumors and new formations, while the remainder of the book was occupied by an account of the heart, the blood, and the vascular system generally.

The two parts of the second volume now issued are bound up separately. The first part of the present volume is devoted to a systematic account of the pathology of the respiratory organs, the liver and the kidney; a good solid piece of work containing much original research, in which are embodied the well-known papers of the author on diseases of the lungs, and on cirrhosis of the liver. Among the many observations, we would draw attention to the important conclusion that in nephritis

the fatty granular remains of the convoluted epithelium are absorbed by the lymphatic system, and are not, as is generally supposed, mainly washed out by the urine.

The drawings, illustrating the author's views, are worthy of all praise; they are well executed, and are sufficiently diagrammatic to impress the conclusion to be indicated, while their reproduction also reflects great credit on the publishers.

The remainder of the volume deals with the diseases of the digestive, the nervous, the osseous and the cutaneous systems, finishing with a short statement of the various malformations, and a good summary of systematic bacteriology and of human parasites.

The present volume is overweighted by 150 pages of normal anatomy and physiology, which preface the accounts of the various organs, nearly fifty pages and twenty illustrations being devoted to the nervous system. This material is surely out of place in a book, in which the author has been compelled by the exigencies of space and time to reduce his account of the pathology of many conditions to too brief an account to be of value, so that often there is no indication as to which lesions and causes are common and important to remember, and which are exceptional; frequently a mere list of them is given.

It is also to be regretted that it has been thought desirable to devote valuable space to the description of the various tests for sugar and albumen in the urine, as this information is contained in the ordinary standard books on clinical medicine.

The author apologises for the lapse of five years since the appearance of the first volume; and we cannot help regretting that Prof. Hamilton did not publish only the first part of the present volume, and allow himself another year or more in which to have worked up the second part to the high standard reached in the earlier portion of the book. Although five years may appear a long time, for the production of the second volume of this book, still the amount of labour required was so extreme that more time was really necessary. The lack of space also has necessitated so much compression, that often the pathology is reduced to a mere explanation of the terms used; while the numerous omissions of important facts suggest that this part has been produced at very high pressure, so that the facts are not presented in their due relation to one another, while there are several statements to which we would take exception.

While such common causes of optic neuritis as plumbism and anemia are omitted, excessively rare ones, such as pneumonia and measles, are given; again, while optic neuritis is discussed, optic atrophy is omitted. Among the causes of cerebral hemorrhage, such well-recognised ones as glioma and aneurysm are omitted.

Through oversight the following conflicting statements have been allowed to appear. Under cysts of the liver, the association of such with similar ones in the kidney is said to be fortuitous; while under the head of renal diseases, it is noted that out of sixty-two cases of cystic kidneys, seventeen were associated with similar cysts in the liver. On one page, in discussing the growth of typhoid bacilli, great doubt is thrown on whether they spore; on the next page, it is stated that they invariably spore when grown under suitable conditions.

The excellence of the work, and it is great, lies in the histological and bacteriological portions, and in the numerous and ingenious theories and suggestions; but the necessity of finishing the book soon, and of keeping it within reasonable size, appear to be responsible for the less satisfactory accounts of the morbid anatomy and of the etiology of the lesions in certain of the sections. This, however, will probably be remedied in later editions.

#### OUR BOOK SHELF.

*The Mechanism of Weaving.* By T. W. Fox. Pp. 464. (London: Macmillan and Co., 1894.)

ONE result of the application of the "beer money" to education is the increasing production of technical handbooks similar to that before us. Technical Instruction Committees found, very soon after their responsibilities were thrust upon them, that there were few competent teachers of technology, and that the literature of arts and crafts was very limited. Many books have been made for the purpose of supplying the need, some good and others of doubtful utility. The new conditions have been favourable to the development of technological books and teachers, and we must not complain if a few monstrosities occur in the case of each, for they are more than counterbalanced by many admirable examples on the other side. The book under review is one of these new guides to industries, and nothing but good can be said of it. It deals with a branch of weaving that has been almost ignored by previous writers. Much has been written on designing and fabric structure, but practically nothing on the mechanical processes of the weaving trade, though new machinery and new processes have been increasing ever since the power-loom supplanted the hand-loom. This gap is admirably filled by Mr. Fox's treatise. The leading types of weaving machinery are clearly described, and the numerous illustrations (256 in all) of machines, appliances, and constructions pertaining to the textile industry are most instructive. We have no hesitation in saying that Mr. Fox, who is the lecturer on textile fabrics at the excellent Municipal School at Manchester, has produced a practical handbook of great value.

*Memorials of Old Whitby.* By Rev. J. C. Atkinson, D.C.L. Pp. 326. (London: Macmillan and Co., 1894.)

FICTION, "like the baseless fabric of a vision, leaves not a wrack behind," because it has no foundation in fact. Stories that are commonly classified as "fabulous" usually have, however, a nucleus of scientific import. In the words of Canon Atkinson: "The myth, the fable (of the mystic sort), the legend, has always a base, a substratum or foundation of some sort. Like the Pentacle, with its mystic application and use, or the Svastika, Fylfot, or Hammer of Thor, the Monolith or Standing-stone—from Jacob's stone at Bethel, and before and since—it has always had its own something to rest upon, to spring from its actual material 'base' or occasion." Scientific inquiry is required to reveal this base; but by this we do not mean that facts of physical or of natural science are necessarily involved in every marvellous story, but rather that the investigator of legendary lore should conduct his research in a scientific spirit, discarding speculative evidence, and reducing the problem to its simplest appearance. This is the spirit in which Canon Atkinson has investigated the myths, legends, and traditions connected with Whitby. His treatment of the Caedmon legend is worthy of special mention. It will be remembered that Caedmon produced his great sacred poem at Whitby. According to Baeda, he was a common cowherd or oxherd, to whom the gift of poesy was miraculously, or at least suddenly, given, and this story has been generally accepted in spite of its great

improbability. Canon Atkinson rids the story of its miraculous element, and justifies the dictum *poeta nascitur, non fit*. He shows that it is largely mythical, and that Caedmon was probably a homely native poet of some genius, but undeveloped, before the Abbess Hild took him up. This view is practically clinched by the evidence that Caedmon's name is of Celtic origin, and that therefore he doubtless possessed the fervid imagination and vivid fancy of the Celtic temperament. It need hardly be said that the miracle described by Baeda would have been eliminated from the story at once by a man of science. To us it seems that Canon Atkinson comes to the only conclusion possible after a careful consideration of historical records, and a common-sense view of the case. Other stories and customs connected with Whitby are discussed with a similar broad-mindedness, and in a manner which local historians generally would do well to follow.

*Die Schöpfung der Tierwelt.* Von Dr. Wilhelm Haacke. Pp. 552. (Leipzig and Vienna: Bibliographisches Institut, 1893.)

It is just as well to state at once that this is a scientifically-arranged description of the animal kingdom, profusely and beautifully illustrated with twenty coloured plates and 469 figures in the text. The illustrations are certainly among the finest of their class, and one cannot help regretting that, as the text is in German, the work can only have a limited sale in England. We can console ourselves, however, with Mr. Lydekker's "Royal Natural History," now being published, and which is rather more popular than the volume under review. The order in which Dr. Haacke treats his subject is uncommon. The book is divided into two parts, one dealing with the various forms of animal life from the point of view of their development, while in the second part the characteristics of different groups of animals are described. The first part is thus chiefly concerned with embryology and paleontology in their relations to zoological affinities: with the functions of organs and the influence of environment; and with the distribution of animal life upon the earth. In the second part, invertebrated and vertebrated animals occupy two separate sections, and life is traced from the protozoa up to the higher forms. From this brief sketch it will be seen that the book has the theory of evolution as the basis of its construction. It is therefore a work in which the facts of natural science are presented in scientific order, and as such deserves high commendation.

*The Vaccination Question.* By Arthur Wollaston Hutton, M.A. Pp. 128. (London: Methuen and Co., 1894.)

MR. HUTTON is among the mistaken people who distrust vaccination, and advocate the repeal of the compulsory laws relating to it. His book is in the form of a letter addressed to Mr. Asquith, in the hope of converting him to the opinion that compulsory vaccination is indefensible. It would be futile for us to discuss the subject, or to attempt to show the fallacy of much of the evidence adduced against vaccination. We may, however, point out that, to be consistent, the anti-vaccinationists must oppose the treatment of diphtheria by anti-toxic serum; but this they are doubtless ready to do.

*Dr. William Smellie and his Contemporaries.* By John Glaister, M.D. Pp. 360. (Glasgow: James Maclehose and Sons, 1894.)

DR. GLAISTER'S book throws some new light upon the history of obstetrics in Great Britain and France, during the eighteenth century, in addition to tracing the career of one of the founders of scientific midwifery.

Smellie's work, however, was so purely medical in character, that a review of it would be of little interest to most of the readers of NATURE.

## LETTERS TO THE EDITOR.

[The Editor is not responsible for the opinions expressed in the correspondence. Neither can he undertake any responsibility for the publication of notices, notices of meetings, or any other part of NATURE. Notices must be in an anonymous communication.]

## Dr. Watt's Dictionary of the Economic Products of India.

THE notice of this important undertaking in a recent number of NATURE (November 1, p. 41) seems to me somewhat unsympathetic, and scarcely to do justice to its undoubted merits. At any rate, the Government of India, at whose instance the Dictionary was prepared, might draw the conclusion from the review that the work was more open to criticism than I believe to be really the case. A British Government is never too ready to undertake an enterprise of this kind, and anything of the nature of a disappointment, when it has made the experiment, is little likely to induce it to make another.

As I warmly encouraged the inception, and have taken a keen interest in the progress of the Dictionary, I feel bound to express my opinion that it is one of the most important aids which has yet been given to the material advancement of India.

As the reviewer correctly remarks, "the large proportion of the products" of that country "are of vegetable origin." It is, however, astonishing how little they are known in Europe. I can speak with some confidence on this subject, because, in 1886, the India Office transferred to Kew the entire economic-botanical collections forming part of the India Museum at South Kensington. Their incorporation with the existing contents of the Kew Museum was carried out under my supervision. I was struck, as every one has been who has had to do with the subject, with the profusion of products for which some useful purpose ought to be found in the arts. As Kew undertook the duty of acting as referee with regard to these matters, it became necessary to accumulate information with regard to them. I therefore formed in my office a sort of rough dictionary, in which I posted up every paper, document, and scrap of information which I could collect about Indian vegetable products. This enabled me to deal rapidly with a great number of commercial inquiries. But for this purpose, Dr. Watt's Dictionary is an infinitely superior instrument. It is in constant use in my office, and I am at a loss to conceive how the day's work could now be got through without it. As I am continually testing its contents, I can only express my surprise at the degree of accuracy which Dr. Watt has attained. I am quite satisfied that the catalogue of not very important blemishes which the reviewer has managed to collect, must have cost him no small labour. The criticisms, with one exception, I do not propose to discuss. I cannot help, however, regretting that the reviewer both begins and ends his article with something like a sneer—in the one case at the size of the book, in the other at the paper on which it is printed.

Such an encyclopædia of economic products as the Dictionary awards, has long been needed. Indirectly I regard it as one of the outcomes of the Famine Commission, the second part of whose Report was presented to Parliament in 1880. In this Report (p. 175) the Commission point out that "at the root of much of the poverty of the people of India . . . lies the unfortunate circumstance that agriculture forms almost the sole occupation of the mass of the population." "Facilities for obtaining profitable markets for all sorts of produce" is a necessary means of remedying this state of things. But it is obvious that the market will not come into existence till the products are brought into demand by better knowledge.

The bulk of the book and the length of the articles was, I imagine, the result of a deliberate plan on the part of the Department of Revenue and Agriculture under whose authority the Dictionary was issued. One object in view was to afford to Indian officials, who cannot be expected to take a miscellaneous library about with them, a standard book of reference. The want of something of the kind led Mr. Edwin T. Atkinson, of the Bengal Civil Service, to commence a sort of industrial survey of the north-western provinces. The work is only a fragment, as Dr. Watt's Dictionary has now covered the ground. The preface to the first part (Allahabad, 1876) puts the needs of Indian officials so clearly, that it will be useful to quote from it.

There is no subject perhaps regarding which so much

has been written and spoken as 'the development of the resources of the country.' The phrase is a pretentious one, and has a rounded, rolling sound worthy of many of the ideas launched in its name, but really expresses what must form one of the first duties of every civilised Government. As early as June 1804 a Mr. Gott was deputed to examine the forests of Rohilkhand and Gorakhpur, with the view of ascertaining what local products could be a advantageously brought to the notice of the European world. . . . He was followed by Laillay and others, who examined into many of the questions which even now are made the subjects of inquiry. Their reports lie unused and unknown amid the twelve hundred volumes of records composing a portion of the immense library of our Board of Revenue, and surely it would be a saving of money and labour if these reports were given to the official and non-official public. My own inquiries have shown me that it is the tendency of all these questions to crop up in cycles, with the same result, the same perfunctory procedure; and were official memory long enough to recollect what has already been done, and know where to find it, one half of the erratic circulars which now puzzle and worry the district officers, might be answered by a reference to the correspondence on the same subject. . . . A review of the efforts made in the past to attain a knowledge of the resources of the country is not unmixt with regret. They have all gone by without leaving any trace behind them, and without advancing our knowledge one single step, because they wanted organisation."

In criticising Dr. Watt's Dictionary, a statement like this should be borne in mind. Dr. Watt has, in fact, and it is one of the great obligations we owe to him, gutted and boiled down the colossal and inaccessible official literature of India. For the first time, an Indian official has at hand all that is practically to be said about any local product with which he has to deal.

These points were, I think, not clearly brought out in the review in NATURE, and I think it is only due to the Government of India that they should be stated.

There is one detailed criticism on which I absolutely take issue with the reviewer. He devotes some space to the expression of the opinion that with regard to "drugs and therapeutics, the details are out of place in a description of economic products." He particularly objects to the inclusion of plants, "solely because of some medicinal, or supposed medicinal, use, frequently by ignorant people." To me the subject seems, on the contrary, of the deepest importance. It is the empirical knowledge acquired by "ignorant people" which is at the base of almost all our knowledge of drugs. And the extension of modern therapeutics must in the main depend on following up the beginnings in new directions which ignorant people have made. In this respect the Dictionary is a mine of information available for the guidance of future research. In India itself a trustworthy account of the properties of the plants used by the natives for therapeutic or even criminal purposes, must, it seems to me, be of every-day utility.

W. T. THRELTON-DYER.

Royal Gardens, Kew, December 8.

IN your recent review of the above work, attention is drawn to the startling statement that "Diamond dust is known to be a powerful mechanical poison." This statement, occurring as it does in an official work, issued by the Government of India, aroused my amazement when I first had occasion to consult the Dictionary. It occurred to me then, and I still think, that the author would have done better to have quoted the words of Colonel Wilks on the subject ("South of India," vol. ii. p. 197), namely, "Whatever doubts may be entertained of the fact, there is none regarding the belief [by the Mahomedans of Southern India in the power of diamonds as a poison], and the supposed powder of diamonds is kept as a last resource like the sword of the Roman, but I never met with any person, who from his own knowledge could describe its visible effects, &c."

Better still perhaps, instead of giving what, as you have pointed out, is a erroneous account of the celebrated Gaikwar's case, Dr. Watt might have quoted the emphatic words of the Commissioners who tried the Gaikwar, that "Diamond dust according to the best authorities has no injurious effect on the human body" ("Commission Report," p. 223).

With some inconsistency—although Dr. Watt quotes an account of the reputed medicinal qualities of prepared diamond

—he does not follow up the first statement by including it in his list of reputed poisons (vol. vi. p. 309.) It may be added that Dr. Watt's selection of authorities, generally, appears to be somewhat capricious. He does not appear to be acquainted with Garcia de Orta's famous work on Indian drugs, for he gives Linschoten and others credit for observations not originally made by them, but by Garcia, *eg. art. Manna*.

Again, when writing of ambergris, surely he might have found some more direct source of information regarding a product derived from *whales*, than a work, excellent though it be, which deals properly with the products of the Punjab.

I write as one not wishing to find fault, especially as I recognise the good services done by Dr. Watt, but because I believe such a work so brought out, should be a faithful summary of recorded facts, which, if hitherto only known to comparatively few, should be so stated as not to mislead the many who may have occasion to refer to the Dictionary.

V. BALL.

Science and Art Museum, Dublin, November 19.

#### Drift-Bottles in the Irish Sea.

IN NATURE for Nov. 8 (p. 35) mention is made of the travels of some drift-bottles in the south seas. It may be of interest to put on record the results so far obtained of the distribution of bottles set free by the Liverpool Marine Biology Committee in order to get further information in regard to those currents in the Irish Sea which would affect small floating bodies. The objects we have had in view are: (1) A purely scientific matter, the source and distribution of the plankton; and (2) the probably utilitarian object of determining the movements of the food of fishes, and so one of the causes of their migrations, and also the drift of the floating ova and embryos of food fishes. The tidal currents of the area in question are to a considerable extent known, and marked on the charts and given in books on "Sailing Directions"; but to these currents have to be added the modifying influence of prevalent winds, and what we want to get at is the resulting average effect. We want to know in what direction an object set floating at any spot will probably be carried at various times of the year in ordinary weather. The surface organisms are such feeble swimmers, if locomotory at all, that any results obtained from small floating bottles may reasonably enough be regarded as holding good for the plankton.

The form of bottle we have chosen is cheap, buoyant, strong, and well corked. It measures 7.5 cm. in length over all, and 1.8 cm. in diameter. Inside it is placed a printed paper requesting the finder to fill in date and locality, in spaces left for the purpose, and post it back to myself. The papers are numbered, and are folded in the bottle in such a way that the distinguishing numbers can be read through the glass, so as to ensure that the bottles are set free in consecutive order. After the bottle has been corked up, the end is immersed a couple of times in melted paraffin, so as to close up the pores in the cork. None of the papers that have been returned show signs of water having got into the bottles.

As to the distribution, I sent off the first few dozen myself from steamers crossing between Liverpool and the Isle of Man, dropping a bottle over every fifteen or twenty minutes between the Bar and Douglas, and also from a steam-*trawler* while dredging between Port Erin and Ireland. Mr. A. Holt has had a number of bottles distributed for me from his outward-bound steamers on their course between Liverpool and St. George's Channel, and from the Mull of Galloway round to the Mersey. The Lancashire Sea-Fisheries steamer has set free another series along various lines up and down the Lancashire coast, and finally some have been set free at equal intervals of time during the rise and fall of the tide from the Morecambe Bay Light vessel in the northern part of the district, and from the Liverpool North-west Light vessel in the southern part. The distribution has now been going on since the beginning of October, and a very fair proportion (about one out of every three) of the papers have already been returned to me duly filled in and signed. They have come from various parts of the coast of the Irish Sea—Scotland, England, Wales, Isle of Man, and Ireland. Some of the bottles have gone quite a short distance, having evidently been taken straight ashore by the rising tide. Others have been carried an unexpected length—*eg.* one (No. 35) set free near the Crosby Light vessel off Liverpool at 12.30 p.m. on October 1, was picked up at Saltcoats in Ayrshire on November 7, having travelled a distance

of at least 180 miles (probably far more) in 37 days or less; another (H 20), set free near the Skerries, Anglesey, on October 6, was picked up at Ardrrossan, Ayrshire, on November 7, having gone at least 150 miles in 31 days.

It would be premature as yet, until many more dozens or hundreds have been distributed and returned, to draw any very definite conclusions. It is only by the evidence of large numbers that the vitiating effect of exceptional circumstances, such as an unusual gale, can be eliminated. However, I may state, as provisional results so far, that nearly fifty per cent. of the bottles found have been carried across to Ireland, and they are chiefly ones that had been set free in the southern part of the district (between Liverpool and Holyhead) and off the Isle of Man. The bottles set free along the Lancashire coast and in Morecambe Bay seem chiefly to have been carried to the south and west—to about Point of Ayre, in North Wales, and Douglas, in Isle of Man. It is apparently only a few that have been carried out of the district through the North Channel. The most interesting point, so far, is that so many of the bottles have been stranded on the Irish coast, although they were sent off for the most part much nearer to the English and Welsh coasts, showing no doubt the influence of the spell of easterly winds in October.

W. A. HERDMAN.

University College, Liverpool, November 29.

#### The Explosion of Gases in Glass Vessels.

WHEN Prof. Lothar Meyer was visiting Manchester a few years ago (on the occasion of the meeting of the British Association), he surprised me by saying that it was his custom in lecture to explode mixtures of ethylene and other hydrocarbons with oxygen in glass cylinders, some 10 to 12 inches long by  $1\frac{1}{2}$  to 2 inches in diameter (if I remember rightly), and that he had never had an accident. I suppose I did not sufficiently conceal my surprise, for he immediately demanded that we should go to the laboratory and repeat the experiment. Not having a mixture of ethylene and oxygen ready, I could not accept the challenge on the spot. The issue was therefore changed. Prof. Lothar Meyer said that he would fire a mixture of hydrogen and oxygen in a thin glass test-tube without breaking it. I confess I was sceptical, until I saw him do it time after time without injury. He argued that if the thin test-tube would withstand the explosion of hydrogen and oxygen, a thick glass cylinder would withstand the more violent explosion of a hydrocarbon. Nevertheless I ventured to warn him against trying the experiment with either acetylene or with cyanogen, the two gases I had found to explode more violently than any others, especially with a small quantity of oxygen. Prof. Meyer's recent accident with acetylene and oxygen has led him to warn chemists against the danger of that mixture. I would wish to add to that warning that the danger is equally great, if not greater, with a mixture of cyanogen and oxygen.

Prof. Lothar Meyer asks how we can account for the violence of the explosion of acetylene, when the velocity of its explosion is so little greater than the velocity of explosion of marsh gas and of ethylene, while it is far less than that of hydrogen? It is important to bear in mind that the explosion-wave is not set up at once; when a gaseous mixture is ignited at the open end of a tube the flame starts comparatively slowly. The violence of an explosion in a short tube depends mainly on whether the explosion wave is set up or not. I think the immunity so long enjoyed by Prof. Meyer's cylinders depends on the fact that the wave was not set up. I have found that pieces of strong combustion tubing, which will stand an hydraulic pressure of twenty-five atmospheres, are broken by the explosion-wave of hydrogen and oxygen. It requires exceptionally strong glass tubes, capable of bearing at least 120 atmospheres, to withstand the shock of the explosion-wave with cyanogen or acetylene. With both these gases it is the incomplete combustion which occurs with the greatest rapidity and violence. According to the hypothesis I have published, viz. that the explosion-wave travels with the velocity of sound in the burning gases, the pressures existing in the explosion-wave of cyanogen and acetylene with their own volume of oxygen are 117 and 105 atmospheres respectively. Quite apart from this hypothesis, the pressures may be calculated from Kiemann's equation for the propagation of a wave of constant type, since we know the density of the unburnt gases and the rate of propagation of the wave. According to Kiemann's equation the pressure in the cyanogen explosion is 140 atmospheres, and in

the acetylene explosion 114. Some experiments I have recently made in conjunction with Mr. J. C. Cain confirm these calculated pressures. When the explosion-wave was propagated through a mixture of equal volumes of cyanogen and oxygen it broke sola-lime tubing of 18 m.m. external diameter and 2.5 m.m. thickness. Pieces of this tubing broke at a mean hydraulic pressure of 70 atmospheres. Green glass tubing of 2.8 mm. thickness withstood the explosion; it broke at a pressure of 140 atmospheres. More exact results were obtained when the gases were diluted with an equal volume of nitrogen:  $-C_2N_2 + O_2 + 2N_2 = 2CO + 3N_2$ .

Pieces of the tube which were broken by the explosion were broken hydraulically at 63 atmospheres; pieces of the tube which withstood the explosion were broken hydraulically at 84 atmospheres.

Pressures in the Explosion Wave.

Gas-mixture.	Calculated pressures.		Observed pressures.
	Kiemann.	Dixon.	
$C_2N_2 + O_2$	140 At.	117 At.	70-140
$C_2N_2 + O_2 + 2N_2$	73.5 At.	57 At.	63 84

When oxygen is added to these mixtures the rate of explosion is diminished and the pressure falls. For instance, according to Kiemann's equation, the pressures produced in the explosion of acetylene with increasing quantities of oxygen are as follow:—

Gas-mixture.	Calculated pressure.
$C_2H_2 + O_2$	114 At.
$C_2H_2 + O_3$	98 At.
$C_2H_2 + O_5$	78 At.

In the same way the pressures produced in the explosion of ethylene with different quantities of oxygen may be calculated:—

Gas-mixture.	Calculated pressure.
$C_2H_4 + O_3$	98 At.
$C_2H_4 + O_4$	91 At.
$C_2H_4 + O_5$	78 At.

The lowest of these pressures is probably sufficient to break the cylinders used by Prof. Lothar Meyer. As Prof. Thorpe says in NATURE, the danger of acetylene lies in the rapidity with which the explosion-wave is initiated, even when the air alone is used as "tamping." Safety lies not in thickening the glass, but in shortening the tubes.

H. B. DIXON.

Owen College, December 1.

The Kinetic Theory of Gases.

I HAVE to thank Mr. Culverwell for his reply to my letter on the discussion at Oxford. To quote his own words (in answering Mr. Burbury, p. 195, Mr. Culverwell's letter was "exactly the kind of letter that I hoped to elicit," as I had not been able to recall the exact purport of Prof. Fitzgerald's "laugh"). Although Prof. Boltzmann made no attempt to answer Prof. Fitzgerald's objection in the short space of time

available after the other speakers had concluded, he several times mentioned the question to me after the debate as one which had not been hitherto satisfactorily cleared up. In preparing my Report, the question of the spectra of gases came prominently before me, but I purposely refrained from expressing my own opinions on a subject about which so little had been written in a report which was intended to be chiefly a record of work actually done. My frequent allusions to the question of the uniqueness of the Boltzmann-Maxwell Law were intended, however, to pave the way, if possible, for an explanation of the discrepancies alluded to by Prof. Fitzgerald, and I should like now to attempt to answer some of his objections.

According to Mr. Culverwell, Prof. Fitzgerald asked why the ether, the solar system, and the whole universe were not subject to the Boltzmann-Maxwell Law? Let us take the solar system first.

The law is obviously inapplicable to a single system (as I pointed out in my Report, and hope to prove still more conclusively shortly). In order to apply it, Prof. Fitzgerald would have to take an infinitely large number of solar systems, each consisting of similarly constituted planets differing, however, in their motions. What the law states is that, if the coordinates and momenta of the different systems were at any instant distributed according to the Boltzmann-Maxwell distribution (i.e. with frequencies proportional to  $e^{-E}$ ), they would be so distributed at any subsequent instant. In the absence of mutual action between the various solar systems, this would not be the only permanent distribution, nor would there be any tendency to assume such a distribution. If, however, the different solar systems were to collide with or encounter one another at random in such a way that transference of energy was liable to take place between any of the coordinates of any one system and any of the coordinates of any other system, the Boltzmann-Maxwell distribution would probably be unique, and there would be a tendency to assume such a distribution as the ultimate result of a great number of encounters taking place. Will not Prof. Fitzgerald agree to this?

With regard to the ether, I notice that Mr. Culverwell emphasises Prof. Fitzgerald's contention that the investigations ought to take "ethereal" as well as "molecular" coordinates and momenta into account. But here I agree with Prof. Boltzmann that the *onus probandi* lies with physicists. If they will give us a clear and definite statement as to what are the coordinates and momenta of the ether, and how transference of energy takes place between these and the molecules, and if they will show that the Boltzmann-Maxwell law is violated under conditions under which we have proved it to be unique, a "true bill will have been found."

At present all we assert is that if the "ethereal coordinates and momenta" satisfy a determinantal relation similar to that proved on p. 22 of Dr. Watson's new edition, the Boltzmann-Maxwell distribution, if it ever once existed, will be permanent in the absence of disturbing influences. But the test case in which molecules are regarded as smooth solids symmetrical about an axis (see my Report, § 45, case iii.) affords an instance in which partition of energy does not take place between all the coordinates of a system, the angular velocity of each molecule about its axis of symmetry being constant and unaffected by collisions, and therefore independent of the Boltzmann-Maxwell Law. And why should not a similar explanation be applicable to the ether? At any rate, this hypothesis is supported by the views advanced by Prof. Oliver Lodge at the Nottingham meeting of the British Association ("Nottingham Report," p. 688).

G. H. BRYAN.

Cambridge, November 30.

It appears to me that the difficulty raised by recent critics against Maxwell's law of partition of energy in the theory of gases, and Boltzmann's minimum theorem relating thereto, by consideration of the effect of a complete reversal of the motions, is capable of direct explanation; and that whatever weak points the theory may have, they are not in that direction. Indeed, if that were not so, the criticism would apply equally against the Second Law of Thermodynamics.

The theorem in question is that there exists a positive function belonging to a group of molecules, which as they settle themselves into a steady state maintains—on the average derived from a great number of configurations—a steady downward trend; that the Maxwell-Boltzmann steady state is that one for

which this function has finally attained its minimum, and is thus the unique steady state; it still being borne in mind that this is only a proposition of averages derived from a great variety of instances in which nothing is conserved in encounters except the energy, and that exceptional cases may exist, comparatively very few in number, in which the trend is, at any rate temporarily, the other way.

Such an exceptional case is in fact the very striking one, pointed out by Maxwell and Helmholtz, in which the motions of the system are all at some stage precisely reversed, so that it retraces its previous history backwards, and the trend of the reversed system is therefore in the opposite direction to the one which would lead towards the steady state. Now it has been assumed, at first sight plausibly, that there are just as many cases of this reversed motion as there are of the direct motion; and if that were so, it would undoubtedly go hard with the distribution theorem. But a fallacy underlies such an assumption, as indeed the other accepted proofs of simple cases of the distribution theorem would lead us to expect. Consider an arbitrary distribution of velocity and configuration of the system to begin with; and let it settle down for a time towards the final state, whatever that may be. Suppose at the end of that time that its velocities are all reversed; the system will retrace its course up to the initial state, but when it has got there, it will presumably go on settling down towards the final state by another route, because there is no longer any reason for exceptional behaviour. Thus there will be only a temporary aberration in the course of the reversed system; and further, if the original progress towards a steady state was at all rapid, this aberration will be sensible only for a brief time, the remainder of the history of the reversed motion corresponding nearly to the steady state. It is true that if the whole universe were thus reversed, the aberration would be permanent; but then the whole universe is a permanently dissipative system, and there is no question of a steady state being attained by it in measurable time. For a finite system, like a mass of gas imagined as bounded by a rigid envelope, the case would be different.

Thus even if these reversed states amounted to half the possible states, there would still be a preponderating, though not immense, probability in favour of a final settling down. But are these reversed states half the total number? The characteristic of such a state is that it is derived from an entirely fortuitous initial distribution by a process of change which is in the direction of the final steady state, whatever that may be, and much in that direction if the time concerned be considerable. It seems then that the number of configurations which can retrace their history for a sensible time is very much more limited than the total number of possible configurations, and that they are simply the exceptions which do not disprove the rule. For a theorem of average, derived from a very great number of instances, is of course not invalidated by picking out a comparatively small number of instances which depart widely from the average. J. LARMOR.

Cambridge, December 4.

#### Peculiarities of Psychological Research.

MR. H. G. WELLS disposes very aptly of most of the claims set up by Mr. Podmore and his colleagues to be real scientific investigators. But, I think, he rather disguises the significance of the card-drawing experiments to which he refers. The experiments of M. Richet and those of the S.P.R. belong to two very different categories. In the former case, 789 correct guesses were made in 2927 trials, or a deviation from the most probable result of 57 or 58; this is about 2.4 times the standard deviation, or the odds against a deviation in excess of this amount are only about 100 to 1, or odds of only about 50 to 1 of a deviation of this magnitude either way.

On the other hand, in the S.P.R. trials we have a deviation from the most probable of 347, about six times the standard deviation. That is to say, the odds against such a result are in round numbers about 2,000,000,000 to 3! Now, this is of a totally different order to that given by M. Richet's numbers. I have obtained odds as great as 100 to 1 against the results of very carefully conducted lottery experiments. There is in reality nothing significant about such odds. But the odds against the S.P.R. experiments are almost equal to the odds against the Monte Carlo roulette returns! The experiments are significant, very significant—not to my mind, however, of telepathy, but of the want of scientific acumen in the psychological researchers. The

interesting point as to whether an abnormal distribution was also in the cards turned up as well as in the percipient, does not appear to have been recorded. Mr. Wells has, however, passed over the difference between the two cases, and given, I fear, the psychological researchers the chance of a little self-glorification on their due appreciation of the significant.

University College, December 8.

KARL PEARSON.

#### Chronometer Trials.

THE Mersey Docks and Harbour Board have, by an Order dated November 29, 1894, modified the regulations under which they are prepared to issue certificates to those who deposit chronometers and other scientific apparatus at their Observatory for test and examination. Under the new regulations, instrument-makers can re-submit their apparatus within a twelvemonth of first deposit, without any additional fee. In the case of chronometer-makers this concession will probably be welcomed for the following reasons. Hitherto, the certificates granted have simply been regarded as a protection to the public, and the makers have had to apply their own tests to ensure accurate performance before submitting them to independent examination. But it will now be possible for makers to spare, in some degree, their own rigorous control, since the certificate granted will show the direction in which correction must be made, and a second certificate will be granted without fee to the improved instrument. If no alteration be needed, the time required for the additional trial is of course saved. Another modification, which will be appreciated by those who seek certificates for watches, is that affecting the condition under which these certificates are granted. The alteration will be best shown by an example. Suppose a watch to have a normal rate in the first position of trial of nine seconds a day, and under the various tests to which it is submitted the rate increase more than a second daily. Such a watch or chronometer, under the old regulations, would be refused an "A" certificate because the daily rate increased to more than ten seconds from mean time. But the watch might evidently be superior to one with a normal rate of two seconds, and which varied some five or six seconds in the various stages of its trial. The alteration in the regulations sanctioned by the Board will now permit the variations to be reckoned from the normal rate, and not from mean times. WILLIAM E. PLUMMER.

Liverpool Observatory, December 10.

#### Indo-Malayan Spiders.

IN your issue of November 29, Mr. R. I. Pocock, reviewing Mr. and Mrs. Workman's book on "Malaysian Spiders," states: "But the pine-apple is a native of South America, and has only of late years been introduced into Singapore; &c." Now, twenty years ago it was as common at Singapore as any other fruit, more so than many indigenous ones. How long before it may have been introduced I am unable to say, but that also should surely be stated "Before such a conclusion, however, can be looked upon as an established fact." I quite grant that in all probability the plant and spider were introduced simultaneously.

New Club, Grafton Street, W.

B. A. MUIRHEAD.

#### Death-feigning in Snakes.

IN NATURE of November 29, p. 107, L. C. Jones asks whether death-feigning is, among snakes, confined to *Heterodon platyrhynchus*.

A writer in the *American Naturalist*, November 1894, pp. 966-8, tells almost precisely the same story of the "Moccasin" snake (*Ancistrodon*) and of "a black or blowing viper."

He also finds "letisimulation" in the toad, and in certain arthropods, worms, and protozoa.

December 1.

GERARD W. BUTLER.

#### The alleged Absoluteness of Motions of Rotation.

PROF. GREENHILL'S remarks on my letter on this subject (*NATURE*, November 29), admitting that he is unconverted, and throwing out a suggestion that further arguments or explanations are desirable, appear to open a wider question than can

be effectively dealt with in the limits of an ordinary letter. I propose therefore to deal with the subject in a special article to be written shortly.

A. E. H. LOVE.

St. John's College, Cambridge, December 3.

### Gravitation.

MAY I ask Dr. Joly whether Newton himself did not point out that a graduated tension excited by matter in a continuous inextensible medium, of an intensity proportional to the mass and the inverse distance, would account for gravitation; and whether he did not refrain from further elaborating this idea because there seemed at that time no adequate way of explaining the existence of such a tension?

OLIVER J. LODGE.

### "Outlines of Quaternions."

MAY I make a short explanation on one or two points on which my reviewer (NATURE, November 22) does not appear to have understood me?

(1) I mentioned Prof. Hardy and Dr. Odstrčil's names in one or two places, because I quoted their language verbally. I found it was better than any language I could devise.

(2) The extraordinary oversight on p. 75 would never have seen the light had I had either good health, or the assistance of a friend, in correcting the proofs of a MS. which was written at odds and ends of time, at places as widely separated as Norway, Gibraltar, and India.

(3) My reviewer says eq. 8 of p. 40— $i = \sqrt{-1}$ —"plays sad havoc with one's very definitions." Having defined  $i$  as a right versor on p. 37, and explained on p. 39 that  $i^2$  means  $ii$ , I deduced in the usual manner the eq.— $i^2 = -1$ , or—

$$ii = i^2 = -1 = \sqrt{-1} \times \sqrt{-1}.$$

Hence I concluded that  $i = \sqrt{-1}$ ; and I fail to see how I have played havoc with my definitions in doing so. Had I begun by explaining that Hamilton built up his system by treating  $\sqrt{-1}$  as a right versor perpendicular to the line it operates on, I might have been open to criticism; but I did not do so. I took another course, which may not have been the best one; but that is a different thing from violating one's own definitions.

H. W. L. HIME.

24 Haymarket, S.W., November 26.

[A pointed reference to a scientific writer usually implies one of three things—that the writer is an authority on the particular subject under discussion, or has made a noted discovery in connection with it, or has been guilty of a serious blunder. Dr. Odstrčil's corollary hardly comes under the second category, and Prof. Hardy's statement differs in no essential word from Hamilton's own language in the "Lectures" (p. 83).

Equation 8 (p. 40, in "The Outlines of Quaternions") asserts the equality of  $i, j, k, -i, -j, -k$ , and as these symbols are by definition all different, the said equation is inconsistent with the definitions. To speak of  $\sqrt{-1}$  as an indeterminate right versor, that is, an operator which rotates any vector through a right angle about an indeterminate axis—a most difficult operation for the mind even to imagine—may be permitted as a figure of speech; but to equate this backboneless thing to a real unit vector or right versor with all its powers of action, is making a serious demand upon the credulity of the student. After defining  $i, j, k$  as symbols involving both axis and angle, what right or reason has Colonel Hime thus arbitrarily to annihilate the axis? Is it not playing havoc with the very props of the calculus?—THE REVIEWER.]

### THE WARBLE FLY<sup>1</sup>

IT is only within comparatively recent years that much attention has been paid to the insect pests of the farm and garden. It is true that when these assume unusually devastating proportions, especially when they make their appearance suddenly, as in the case of locust-swarms, the attention of whole nations is called to them

for the moment: but the loss caused by less obtrusive creatures may proceed unchecked and almost unsuspected for years, without attracting the notice even of those who suffer from it most. But there are now many entomologists, among whom Miss Ormerod deserves special notice in England, and Prof. Riley in America, who have been working zealously for years to diminish the loss and injury caused by injurious insects; and the pamphlet before us, with its clear descriptions and statistics, and excellent illustrations, conveys a mass of information, in a very handy form, which certainly deserves the most serious attention of all who are interested in the cattle and leather trades, whether as graziers, butchers, or tanners.

The total loss caused by the warble fly in the United Kingdom alone is estimated at something like £8,000,000 per annum; an enormous amount, but which the facts given in Miss Ormerod's pamphlet fully appear to bear out. When hides are sometimes so deteriorated that the loss on each may be as much as from twenty-five to thirty shillings, to say nothing of hides rendered utterly worthless; cattle killed, or the best parts of the carcase destroyed, and diminished yield of milk, the importance of the matter becomes very apparent. And beyond this, there remains a very serious question which Miss Ormerod has not touched upon at all: how far the milk of badly-infested cows, or the apparently sound portions of a carcase, even when all the obviously diseased part has been conscientiously removed, may be liable to cause disease in man—disease, possibly, of a nature the origin of which is at present absolutely unknown and unsuspected by medical men. And yet we remember once to have met with the statement that the best hides generally contained warbles. This, however, if true in any sense, could only mean that the fly attacks the strongest and healthiest animals in preference to weaker ones, thereby of course increasing the mischief produced by its attacks.

Although the insect is so abundant that as many as 500 maggots have been found in a single hide, yet the fly is rarely seen. When the cattle are attacked by it, they gallop wildly about, with their tails in the air, and seek the shelter of trees or sheds, or rush into the water; and in any of these situations, the fly does not appear to follow them. Cattle will act in the same manner when attacked by true gad-flies, one of the largest British species of which, *Tabanus bovinus*, is likewise noticed and figured by Miss Ormerod in her pamphlet. The gad-flies, however, simply pierce the skin of the cattle, and suck their blood, but inflict no permanent injury; and their larvæ are subterranean, and not epizootic.

According to the observations of Prof. Riley in America, the egg of the warble fly is deposited on, and not under, the skin. In the earliest stage of the maggot, which Miss Ormerod has herself observed, it is a small blood-red worm-like creature, scarcely visible to the naked eye, embedded in a slight swelling, composed of blood-red tissue, through which a fine channel, no wider than a hair, passes up to the surface of the skin (Fig. 1). In the very young stage, the maggot, which always rests with its head at the bottom of the sore, and the breathing apparatus, which is at the opposite extremity of the body, directed towards the opening which communicates with the external air, is provided with two forks or diggers, probably used for piercing through the substance of the hide. In this stage, too, the maggots are capable of inflating themselves with fluid which they have apparently no means of discharging, and become so hard that they can scarcely be compressed with the fingers, thus forming living and growing plugs, which act the part of setons, and which cannot be pressed back out of the wound, more especially as they are furnished with short bands of prickles along a portion of the back. Having penetrated the hide, the

<sup>1</sup> Observations on Warble Fly or Gad Fly (*Tabanus bovinus*). By Dr. G. E. Ormerod, F.R.S. (London: Simpkin, Marshall, Hamilton, Kent, and Co., Ltd., 1894.)



maggot rests in the sore, and presently assumes a more pear-shaped form.

When about one-third grown, a great change takes place in the structure of the creature, which, while it was forcing its passage, was "little more than a bag of fluid, with a large proportion of the space occupied by breathing-tubes." At this stage, however, "the hard tips necessary, or at least serviceable for forcing a passage up the hide, are no longer needed, and they are exchanged for a broad form of spiracle, and the internal organs become suited to provide material for the development of the fly, which will presently form in the dry husk of the maggot, which serves as the chrysalis-case."

The further development of the maggot is so well known that we scarcely need trace its course until it reaches its final shape of a hairy two-winged fly, not very unlike a small humble-bee in general appearance, nor need we go into the elaborate accounts of the enormous loss which is frequently caused by it to all persons interested in living or dead cattle. The fly

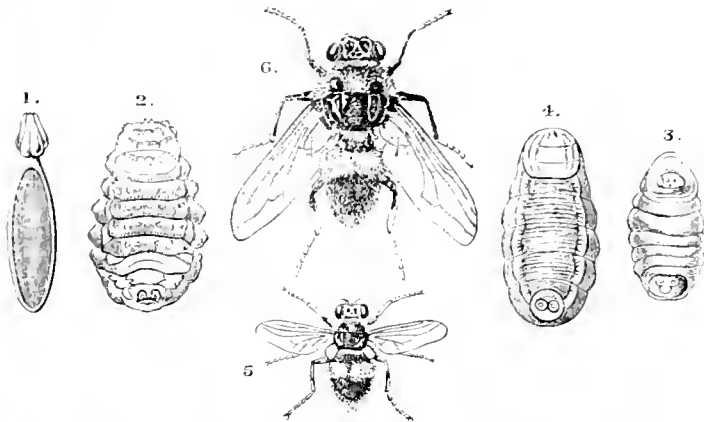

FIG. 1.—*Hypoderma bovis*. 1, egg; 2, maggot; 3 and 4, chrysalis-case; 5 and 6, fly; 3 and 5 natural size, after Bruey Clark; the other figures, after Brauer, and all magnified.

appears to be found in most parts of the world, but is a much greater pest in some countries than in others; and it is worthy of notice that, while goats appear to suffer from the warble as much or more than cattle, horses seem never to be attacked by it.

Miss Ormerod, however, gives several easy, harmless, and efficacious methods by which the mischief may be abated or removed; and the fly appears to be sluggish, and not to stray far from where it lived as a maggot, for after a few years' careful destruction of the maggots, the pest seems to disappear, without the farm being liable to fresh incursions from surrounding farms where similar precautions have not been taken to exterminate the maggots. Miss Ormerod has evidently done her best to show the farmers how they may best exterminate the pest; and if they do not avail themselves of the information which she has been at so much trouble to collect and to disseminate, it will not be her fault. The accompanying illustration is from her useful pamphlet.

W. F. KIRBY.

FERDINAND DE LESSEPS.

THE death of M. de Lesseps, on Friday last, removes from the world one of its more prominent men. To say that it was his indefatigable energy which brought to a successful termination the scheme to pierce the Isthmus of Suez, is but to repeat what is known to every schoolboy. With the affairs that during the last two years have obscured his fame to the political eye we have nothing to do. The work which earned for him the

title of "Le Grand Français" is sufficient to command the admiration of every man of science. The appreciative obituary notice in the *Times*, running into nearly four columns, deals largely with de Lesseps' diplomatic career, but this does not concern us. We are indebted to the notice, however, for some of the following particulars of interest to our readers.

Ferdinand de Lesseps was born at Versailles, November 19, 1805. His early public life was spent in the diplomatic service, for which he manifested the same predilections as his ancestors. But so far back as 1841, the project for cutting through the Isthmus of Suez had occurred to him. It was not until 1854, however, that he first revealed the scheme that will be most lastingly associated with his name. Two years later, Said Pasha, the Viceroy of Egypt, granted him a formal letter of concession. In the same year de Lesseps published a clear and definite exposition of his views in his pamphlet "Perçement de l'Isthme de Suez. Exposé et documents officiels." Many eminent engineers questioned the practicability of the scheme; nevertheless a capital of two millions of francs was subscribed, and in 1859 the works were commenced.

Difficulties and disputes of a most serious character cropped up from time to time, but they were overcome, with the result that a canal, having sufficient water to admit of the passage of steamboats, was opened on August 15, 1865. The channel was widened and deepened by special machinery, and in March, 1867, small ships were able to make use of the Canal. The waters of the Mediterranean mingled with those of the Red Sea in the Bitter Lakes on August 15, 1869, and the event was commemorated by grand *fétes* at Suez. On November 20 following, the Canal was formally opened at Port Said amid a series of brilliant festivities. The Canal is about 100 miles long, with a bottom width of upwards of 200 feet, and a depth of 28 or 29 feet.

Honours poured in upon M. de Lesseps after the successful opening of the Canal. In February, 1870, the Geographical Society of Paris awarded him the Empress's new prize of 10,000 francs. He gave it as a contribution to the Society's projected expedition to Equatorial Africa. He was appointed to the rank of Grand Cross of the Legion of Honour, and received the cordon of the Italian Order of St. Maurice. The honorary freedom of the City of London was presented to him, and Queen Victoria created him an honorary Knight Grand Commander of the Order of the Star of India. In July, 1873, the Paris Academy of Sciences elected M. de Lesseps a member, in the place of the late M. de Verneuil. In 1875 he published his "Lettres, Journal, et Documents pour servir à l'Histoire du Canal de Suez." For this work the French Academy awarded to him the Marcelin Gaërin prize of 5000 francs. In June, 1881, he was elected President of the French Geographical Society, in the place of Admiral de la Roncière-le-Noury. The Broad Riband of the Persian Order of the Lion and the Sun was presented to him in 1883.

M. de Lesseps promoted the project of the Corinth Canal, and made a journey in Algeria and Tunis to study the scheme of Commandant Rondure for the creation of an inland sea in Africa—a scheme of which he formed a favourable opinion. Gradually, however, he became wholly absorbed in the undertaking which was to prove his ruin—the Panama Canal. All the world knows how this ended. After the humiliating drama had been played out at the beginning of last year, the central figure sunk

into a state of stupor, and in this condition almost oblivious of everything that went on around him he remained until he passed into the silence of death.

But let us forget these events. However dark they may seem to be, they cannot hide from us the wonderful applications of science we owe to Lesseps.

We learn from the *Times* that M<sup>me</sup>. de Lesseps has received many messages of condolence. The Emperor of Germany telegraphed to her, "All intellectual and scientific people mourn over the tomb of one of the greatest minds and of a genius which embraced the universe." Lord Dufferin has conveyed the sincere grief of the Prince of Wales, as also the sympathy of Lord Kimberley. It is understood that a committee of the Suez Canal Board is to propose to the company that a statue be erected to M. de Lesseps at the expense of the company, and that the city of Paris is to be asked to grant a site in one of the public squares.

These expressions show the high regard in which de Lesseps was held. A still more striking testimony is afforded by the fact that the Paris Academy of Sciences adjourned on Monday in sign of mourning, when the president, M. Lœwy, is reported to have said: "Many storms had latterly broken over the head of the illustrious veteran. It is, perhaps, not to be too much regretted that his declining strength had for several years made him almost a stranger to the melancholy affairs of this world. His name will for ever be linked with a grand work, the success of which is due entirely to his glorious efforts, and will be a memorable date in the history of civilisation."

Scientific posterity will remember the Academy's act of respect to de Lesseps, and M. Lœwy's words of tribute to his colleague's memory.

#### NOTES.

WE are glad to see the report that M. Pasteur, who has been poorly for some little time, is improving in health.

PROF. G. LEWITZKY, the Director of Charcow Observatory, has been appointed Director of Dorpat Observatory, in succession to the late Prof. L. Schwarz. Dr. L. Struve goes to fill Prof. Lewitzky's place at Charcow.

THE Academy of Sciences of Berlin has granted a subsidy of 1200 marks to Dr. P. Kuckuck, to aid him in the investigation of the alga-flora of Heligoland.

WE learn from the *Botanisches Centralblatt*, that Herr W. Siehe, of Berlin, has undertaken a botanical exploration of the almost unknown region of Cilicia Trachæa.

CONSIDERABLE changes have recently been made in the scientific department of Smith College, U.S.A. The botanical department has been reorganised, and Dr. W. F. Ganong appointed professor. Miss Grace D. Chester, formerly instructor in botany, has been appointed instructor in cryptogamic botany.

OUR correspondent at Cambridge has sent us the following notes:—The Council of the Senate have appointed Dr. R. D. Roberts to be a governor of the Royal Holloway College, Egham. Dr. H. H. Tooth, of St. John's College, has been appointed an additional examiner in medicine. The Walsingham Medal for biological research has been awarded to H. Burkill, assistant curator of the Herbarium. The following awards for Natural Science have been made at St. John's College: G. S. West, Royal College of Science, London, Foundation Scholarship of £50 a year; L. F. Hudson, Dulwich College, and T. F. R. McDonnell, St. Paul's School, Minor Scholarships of £50 a year; A. C. Ingram, Felsted School, Exhibition of £30.

A SOCIÉTÉ des Amis des Explorateurs français has recently been formed at Paris. Its object is to collect and administer funds for the purpose of aiding travellers, particularly in their return, and to contribute to the progress of geography by the publication of the results of explorations, and other contributions to geographical science. The Society is in connection with the Paris Geographical Society.

WE thought it would come. The anti-vaccinationists, anti-visitationists, and kindred souls have, if only for the sake of consistency, protested against the new treatment for diphtheria. At the ordinary fortnightly meeting of the Metropolitan Asylums Board, on Saturday last, a deputation, headed by Lord Coleridge, waited upon the Board to present a memorial against experiments being carried out in the hospitals in the Metropolitan Asylums district in the use of the anti-toxin cure for diphtheria. The Royal College of Physicians had offered to supply serum for the treatment of diphtheric patients in the Board's hospitals, and the General Purposes Committee advised the acceptance of it, but the deputation wished to stop the action altogether. By arguments that have been used over and over again, it was urged that the experiments led to injurious effects, and were of doubtful utility. Therefore, the deputation submitted, "public money ought not to be devoted to experiments in physiology." The Board, however, thought differently, for the report of the Committee was adopted.

PROF. W. C. MCINTOSH writes on the artificial hatching of marine food-fishes in *Science Progress* for December. In the course of his article, he pleads for increased funds to carry on experiments on a larger scale than is at present possible at Dunbar. The sum of £3000 per annum is granted to the Scottish Fishery Board for scientific investigations, but really only £1800 a year is available for research. "This income has to bear the salaries of the staff, experiments in fish-, lobster-, and mussel culture, the cost of apparatus, the marine laboratory at St. Andrews, the hatchery for marine fishes, with its small laboratory at Dunbar, and the carrying out of other scientific fishery work." Leaving England out of consideration, compare this with what is done on the other side of the Atlantic. "The United States spends annually £70,000 on fish-culture and scientific investigations, and employs two large steamers and a sailing vessel exclusively for the work. Besides this large sum, the Fish Commissioners of the various States also disburse considerably on the development of their fisheries. Canada, again, expends £100,000 yearly on her fisheries, of which a sum of about £10,000 is devoted to fish culture."

IT was pointed out by Lord Rayleigh in these columns in 1883 (vol. 27, p. 535), that whenever a bird pursues its course for some time without moving its wings, we must conclude either (1) that the course is not horizontal, (2) that the wind is not horizontal, or (3) that the wind is not uniform. Prof. S. P. Langley's recently published memoir on the internal work of the wind shows that the condition represented by the third case, which Lord Rayleigh believed must sometimes operate, always exists. The investigations described in the memoir distinctly prove that the wind is never a homogeneous current, but consists of a continued series of rapid pulsations varying indefinitely in amplitude and period. These pulsations undoubtedly help a bird to maintain its flight without working its wings or expending energy. This may be accomplished by a succession of ascents and descents; the ascents being made during the wind-gusts, and the descents during the lulls. Prof. George L. Curtis, of Washington, has lately investigated mathematically whether the third case of Lord Rayleigh's analysis is the one actually employed by a bird in soaring; that is to say, he has tested whether the pulsations of the wind,

in addition to being qualitatively applicable, are also quantitatively sufficient to produce the result. (*Annals of Mathematics*, vol. viii. No. 6.) With this application in view, he has determined the course in the air of a free heavy plane subjected to definite wind pulsations. For a period of action of ten seconds, the following result was obtained "without any internal source of energy, during the 10 seconds of alternate calm and wind, the plane has in the first 2.75 seconds made a descent of 36 feet, and in the remaining 7.25 seconds has risen 46.9 feet, travelling at the same time horizontally a distance of 251 feet, of which 154 feet is made against the wind. In addition, the relative velocity of the plane and wind (58.9 feet per second) at the end of this period is sufficient, if the wind continue with the same velocity, to yield a considerable further ascent before the vertical component of pressure is reduced to such an extent that it no longer exceeds the weight of the plane under the constant angle of inclination." Though the conditions of the problem solved by Prof. Curtis are seldom met with in nature, the results he has obtained have a very important bearing upon mechanical flight.

A NUMBER of papers of considerable value are published in the *Mittheilungen der Prähistorischen Commission der Kais. Akademie der Wissenschaften*. (Bd. I, No 3. Wien, 1893). J. Szombathy describes the ceramics discovered by him in a tumulus at Langenlebar, in Lower Austria. He points out that double and multiple vessels were common in the finds of the bronze period and first iron age of the eastern Mediterranean countries, especially in Cyprus and Troas, somewhat rarer at a later time in the graves of the first Italian iron age, and still more rare in the later graves of the Hallstatt period of the Austrian Alps and of Central Europe. The doubling arose from the gradual increase in diameter of the lower portion of the long cylindrical neck of an earlier type of vessel. Dr. M. Hoernes gives a study of the forms of various prehistoric objects which he has observed in the museums of North-east Italy. Amongst other objects he refers to bronze and iron knives in the museum at Padua. The resemblances in the handles and ornamentation of certain clay vessels leads him to the conclusion that the culture of the bronze age of North-eastern Italy extended to the East, and included Bosnia-Herzegovina and Istria; but from this he does not deduce an ethnical relationship. In the bronze period of Eastern Upper Italy not only were pile-dwellings inhabited, but mounds as well, as in Istria and Bosnia-Herzegovina. Even if related pile-structures are not to be found in the north-west of the Balkan Peninsula, the difference in the mode of life is counterbalanced by other considerations. The evolution of the Italians and the Illyrians later diverged in the historically well-known way. He would add the Ligurian people as belonging to the same culture group of that age; this culture-unity separated these people from other peoples living further north and south of this zone. Dr. Hoernes also describes some triangular and other ornaments, human and animal forms, especially those with associated birds, as well as bronze and iron fire-dogs. Prof. R. Trampler writes on the oldest graves in the Brunnens Valley district; and F. Heger, on finds from prehistoric and Roman times in Lower Austria. The author of this well-illustrated paper states that there was a pure bronze age in the district of Upper and Lower Austria, which had points of relationship with the Western finds, and especially with those in the North and East.

A CURIOUS formation is illustrated in the first annual report of the Iowa Geological Survey, published a few months ago. Good exposures of limestone rocks are found all along the Mississippi from Keokuk to Burlington, in south-eastern Iowa. The limestone often stands out in overhanging cliffs over the

softer shale beds beneath, and gives the appearance of a cascade, as shown in the accompanying illustration, which is reduced from a plate in the report. The Survey was only established



in 1892, but the report shows that a large amount of useful information, of great economic interest to the people of the State, has already been collected.

THE volume referred to in the foregoing note showed us that the publications of the Iowa Geological Survey were to be of a high character. The second volume, which reached us a few days ago, goes to confirm this view. It is a description of the coal deposits of Iowa, by Dr. C. R. Keyes, and is a model of what a general report should be. With text running into more than five hundred quarto pages, eighteen full-page plates of a high quality, representing interesting formations in connection with the coal-measures, and over two hundred figures in the text, the volume is an attractive handbook for the coal-miners of Iowa. It is not a detailed account of the geological features of the coal districts—that will follow when sufficient facts have been accumulated; it is rather a preliminary report, somewhat general in character, but sufficient to supply temporarily the demand for information pertaining to the coal deposits of the State. Separate volumes will be devoted to practical mining in Iowa, and to a description of the uses and properties of Iowa coals. We offer our congratulations to Dr. Keyes and the geological corps with which he is associated. May their intentions with regard to future work be satisfactorily realised.

IN the current number of the *Zoologischer Anzeiger* (No. 462), Dr. Arnold Graf records some novel observations made by him in the course of some experiments on the effects of compression on the segmentation of the egg of the sea-urchin *Arbacia*. Driesch has already shown that compression of the

segmenting egg between slide and cover-slip leads to the formation of a flat plate of blastomeres, and Dr. Graf's observations coincide completely with those of Driesch up to the 32-cell stage. At this point the author determined to remove the pressure exerted by the cover-slip, and to notice the effect produced on the egg by this reversion to normal conditions. To his astonishment he found that, after removing the pressure (by gradually adding a surplus of water between slide and cover-slip) the various blastomeres began to fuse together again. In this way a plate of 15 cells was produced, each cell containing two and, in a few cases, three nuclei. Shortly afterwards the separate nuclei in each cell reunited. The last transformation observed by the author was the conversion of the plate into a 12 cell stage, consisting of eight macromeres and eight micromeres. The results of the experiment are full of interest, and well worthy of renewed trial. The author is certain that the fusion of the blastomeres took place quite regularly: the two or three daughter-cells of one mother-cell reunited to form the single uni-nucleated equivalent of the mother-cell again.

CERTAIN obscure phenomena connected with the mingling of two masses of liquid are dealt with by Herr E. Kaiser in the current number of *Wiedemann's Annalen*. Two soap-bubbles or two jets of water when brought into immediate juxtaposition will not always mingle at once, and sometimes they will not do so at all. Impurities in the water or soap solution will encourage fusion, and so will a difference of potential. Whether the influence of the latter may be explained on the supposition of sparks breaking down the intervening layer of air, is a question which has been answered in the affirmative. But Herr Kaiser's experiments tend to show that in reality the difference of potential simply increases the pressure on the intervening air, and forces it out at the sides, thus diminishing the distance between the two surfaces down to the radius of molecular action. He suspended a circular film of Terquem's sugar-soap solution in a wire ring by a delicate spring balance, and brought a bubble to bear against it from below. The film and bubble were placed in electric connection through their supports, and differences of potential due to 1, 2, 3 and more Daniells were subsequently introduced. With the films investigated, the time necessary for fusion was about 3.2 seconds with no difference of potential, 1.4 seconds with one Daniell, and 0.4 with two. With more Daniells fusion took place instantly, and the films burst in most cases. The pressure was 1.016 gr. The displacement of air from between the films was studied by the aid of the Newton's rings formed between them. The rings widened out, rapidly at first, then more slowly, and the mingling was heralded by the appearance of the grey-blue of the first order. A difference of potential simply accelerated this process.

It has been said by someone, that a whole set of meteorological predictions may be disturbed by a cowboy carelessly throwing down a burning match upon a prairie. The match starts a prairie fire which, as it exchanges extending throughout the atmosphere, an Indian accident may upset the most carefully prepared forecast. This is, of course, a far-fetched case, but it is worth while knowing what effect great forest fires have upon the atmosphere. To this end Prof. Cleveland Abbe, in the *Monthly Weather Review*, determines some of the meteorological results of the extensive forest fires in the United States during July and August of this year. It appears that, with regard to their influence upon atmospheric moisture, the experience of the past summer is sufficient to show that forest fires are not necessarily followed by rain, and are not a practical method of inducing rain in dry season. Comparing the normal maximum effect of solar heat with the computation of the effect of burning forest, Prof. Abbe finds that, in the locality where it occurs, a

forest fire can heat its atmosphere more than the hottest sun of June, in the ratio of 10,000 to 750. Fortunately, however, the general influence of the forest fire upon the whole atmosphere is much smaller than that of the sun, because the fire is of small extent, while the sun affects the whole earth. The actual area covered by the forest fires of August in Minnesota, Wisconsin, and Michigan did not exceed five thousand square miles, whereas the area covered by the smoke, and, therefore, hot air, from these fires before the heat was all lost by radiation, was not less than one million square miles. A comparison of the solar effect over this large area and the more intense forest fire effect over the small area, shows that the former is fifteen times that of the latter. Prof. Abbe's calculations thus afford no foundation for the belief that forest fires have important meteorological sequelæ. The story of the connection between careless cowboys and atmospheric circulation is, therefore, no longer worth telling.

THE current number of *L'Electricista* contains a description of a new method for measuring small resistances, due to Dr. Pasqualini. This method, which requires no special apparatus that cannot be easily set up in the laboratory, consists in having a coil, composed of a few turns of wire, wound double, so that there are two similar circuits. This double coil is fixed to the case of an ordinary galvanometer, so as to act on the needle. The main current sent through the resistance to be measured passes through one of the circuits of this auxiliary coil. A shunt circuit to the resistance is formed by the second circuit of the coil, the galvanometer, and a resistance-box. The connections are so arranged that the main current and the shunt current in the galvanometer coils tend to turn the needle in opposite directions. The resistance of the shunt circuit is varied till the galvanometer deflection is zero. Suppose  $K$  is the galvanometer constant, while  $K_1$  is the constant which expresses the effect of either of the circuits in the auxiliary coils on the needle, and if  $I$  and  $i$  are the total main current and the fraction which passes through the shunt circuit respectively. Then  $K I = K_1 I - K_1 i$ , or if  $R$  is the resistance of the shunt circuit, the resistance to be measured =  $\frac{K_1}{K} R$ . The value of the constant  $K_1$  can be obtained by performing the experiment on a known  $K$  resistance. With an auxiliary coil consisting of two similar circuits containing four turns each, and a Wiedemann galvanometer of 8 ohms resistance, the author finds he can measure a resistance of 0.002 ohms within  $\frac{4}{1000} I$ , using a standard ohm to determine the constant  $\frac{K_1}{K}$ .

IN a paper communicated to the *Physical Review*, Mr. S. H. Brackett gives an account of some experiments he has made on the magnetic properties of iridium. The samples used contained 98 per cent iridium, with some platinum, and a trace of phosphorus, but no iron. A bar of the metal 15.3 m.m. long, 3.2 m.m. wide, and 0.9 m.m. thick, when brought into the field of an electromagnet, set itself at right angles to the lines of force, and became permanently magnetised in a transverse direction, and when suspended, freely set itself E. and W. The permeability of a larger bar was tested, and was found to be unity; and although the specimen was sharply struck while in the magnetising coil, no induced magnetisation was produced.

A NEW illustrated descriptive price list of electric and magnetic apparatus, for use in colleges and scientific institutions, has been issued by Messrs. King, Mendham, and Co., Bristol.

WE have received a *Zahrbuch* containing the results of meteorological observations made at the observatory of the

*Magdeburgischen Zeitung* during 1893. The volume is edited by Herr A. W. Grützmaker, and is in its thirteenth year.

THE *Bulletins* of the Michigan State Agricultural College Experiment Station, for October, contain an exhaustive paper on the insects which attack clover, by Mr. G. C. Davis, and one on rape as a forage-plant, by Mr. C. D. Smith and Mr. F. B. Mumford.

THE eighth part of "The Natural History of Plants" has been published by Messrs. Blackie and Son. It deals with the genesis of plant-offspring, one section being devoted to asexual reproduction, while the other refers to reproduction by means of fruits.

MM. J. B. BAILLIÈRE ET FILS, of Paris, following other firms of booksellers and publishers, have commenced the issue of a monthly list of new books, under the title *Bibliographie des sciences naturelles*. The list for November comprises the titles and prices of important works on protozoa, sponges, coelenterata, echinoderms, &c.

THE *Transactions* of the Academy of Science of St. Louis, U.S.A., include a paper on *Sclerotinia Libertiana*, a fungus parasite of the sunflower, by Prof. L. H. Pammel, to which is appended a bibliography of the fungus diseases of roots, covering thirty-seven pages; also a further instalment of Mr. C. Robertson's observations on the relationship between flowers and insects in the process of pollination, the present paper treating of American species of *Rosaceæ* and *Compositæ*.

A VOLUME containing a number of important papers and reports relating to the gold fields of New Zealand has just reached this country. The mining industry has formed a large factor in the advancement of the colony, and the statement issued by the Government shows the direction in which further developments should be made. The volume comprises reports on the gold fields and coal mines, geological reports on the older quartz-drifts in Central Otago, and a report on deep quartz-mining in New Zealand.

MR. EDWARD STANFORD has acted wisely in reissuing Dr. A. R. Wallace's standard work on "Australasia" in a revised and enlarged form. The first volume of the new edition, dealing with Australia and New Zealand, was published a few months ago. The second volume, which has just appeared, has for its subject Malaysia and the Pacific Archipelagoes, being an enlargement of the part devoted to that region in the original work. Dr. F. H. H. Guillemand is responsible for the new work, and he has performed his task so thoroughly that the present volume occupies nearly twice the number of pages previously allotted to the region with which it deals. The work is certainly the most interesting and accurate account extant on the tropical portion of the Eastern Archipelago.

STUDENTS of the anatomy of the horse will be glad to learn that the second volume of the elaborate "Topographische Anatomie des Pferdes," by Drs. W. Ellenberger and H. Baum, has been published by Paul Parey, Berlin. The first volume, dealing with the structure of the limbs of the horse, appeared in the spring of last year. The volume just received has for its subject the head and shoulders; while the third, which the publisher informs us will be issued early next year, will be devoted to the trunk. We shall review the work when it is completed. So far as we can at present judge, it promises to be a useful contribution to the literature of the subject, possessing both scientific and practical importance.

PROF. W. NERNST's important treatise on "Theoretical Chemistry, from the Standpoint of Avogadro's Rule and Thermodynamics," the German edition of which was enthusiastically received last year, has been translated by Prof. C. S.

Palmer, of the University of Colorado, and the translation will shortly be published by Messrs. Macmillan and Co. The work is a development of Prof. Nernst's introduction to the "Handbuch der Anorganischen Chemie" of Dr. O. Dammer. It is, however, quite an independent text-book for students of the new physical chemistry, and includes the results of all recent investigations bearing upon that science. The book will serve at once both as a treatise in itself, and also as an introduction to, and companion in, the larger field covered by the *Zeitschrift für Physikalische Chemie* and the related literature.

ANOTHER scientific work which Messrs. Macmillan will shortly issue, is "Steam and the Marine Steam Engine," by Mr. John Yeo. The book is chiefly intended for naval officers, and for students of engineering in the earlier part of their training. It aims especially at giving a sound general knowledge of the propelling machinery of ships, and of various matters connected with its use and management.

IN "Darwinism and Race Progress," which Messrs. Swan Sonnenschein and Co. will shortly publish, Prof. Haycraft shows how the racial deterioration which would of necessity ensue upon our modern care of the sickly and enfeebled, may be counteracted by a keener public conscience. Our preservation of unworthy types by public and private charity is strongly animadverted upon, and with regard to intellectual development, it is pointed out that the present democratic movement, while it gives a chance to the clever and capable of becoming educated and well-to-do, entails upon them conditions which generally imply late marriages and relative sterility. Without supplementary action, nothing could be devised which would more effectually breed capacity out of the race.

TWO volumes have lately been added to the comprehensive engineering division of the *Encyclopédie Scientifique des Aide-Mémoire*, published jointly by Gauthier-Villars and Masson. They are "Les Chronomètres de Marine," by M. E. Caspari, and "Torilles Seches," by M. E. Hennebert. As is the case with all the volumes in the same series, the two new ones are practical handbooks of a very instructive character. In the former, the construction of chronometers, and the theory relating to it, are clearly described, and a deal of space is devoted to the effects of various conditions upon the rate, and also to the determination of the coefficients of the rate-formula. The determination of longitude by means of chronometers, and the methods of testing and comparing the instruments, are concisely described. Both M. Caspari's work, and that by Lieut.-Colonel Hennebert on torpedoes, bring together a lot of scattered information of great use to students of the subjects with which they respectively deal.

COMMERCIAL geography is just the kind of subject to be fostered by County Councillors, hence, from the time that the Technical Instruction Act came into operation, there has been an increasing demand for text-books upon it. The first edition of Dr. H. R. Mill's "Elementary Commercial Geography," in the Pitt Press Series (Cambridge University Press), appeared in 1888, when the boundary line of commercial geography was in a more or less nebulous condition. Thanks to the impetus that has been given to the subject during the past few years, the book has reached a second edition. The new issue is not, however, merely the original work reprinted, for it has almost entirely been rewritten. To quote the preface: "The book has been revised throughout by the aid of official publications, and the facts are as far as possible brought down to date. It is enlarged by treating more fully of the principles of commercial geography, by describing the African possessions of the European powers in greater detail, and by many small additions in every chapter."

These additions have enlarged the book from 132 to 181 pages, and have correspondingly increased its value. It would be difficult to find an elementary class-book of commercial geography constructed on better lines, or in which the information is more concisely and accurately stated.

THE additions to the Zoological Society's Gardens during the past week include a Spotted Owl (*Athene brama*), four Grey Francolins (*Francolinus ponicerianus*), three Rain Quails (*Coturnix coromandelica*), an Indian House Sparrow (*Passer domesticus*), two Red-headed Buntings (*Emberiza luteola*), two Nutmeg Finches (*Munia rubro-nigra*), a Spotted Turtle Dove (*Turtur meena*) from India, presented by Mr. E. W. Harper, a West African Love Bird (*Agapornis pullaria*) from West Africa, presented by Mrs. Robinson; a Reticulated Python (*Python reticulatus*) from Malacca, presented by Mr. Sigismund Bruzard; an American Black Bear (*Ursus americanus*, var. *annularis*) from the Rocky Mountains, two Common Cassowaries (*Casuarus gallicus*) from India, a Red-vented Parrot (*Pionus menturus*), two Orange-flanked Parrakeets (*Brotogeris pyrropterus*) from South America, a Scops Owl (*Scops* —) from Formosa, deposited; a Short-billed Toucan (*Raphaella recicarinatus*) from Central America, received in exchange.

OUR ASTRONOMICAL COLUMN.

MOTION AND MAGNITUDE.—Students of elementary astronomy often believe that stellar motions in the line of sight soon produce changes in the magnitudes of stars. Motion towards the earth involves, of course, a certain increase of magnitude, and a motion of recession must carry with it a decrease, but the amount in the case of a star is far too small to be measurable, even if the magnitudes are observed during many generations. At the meeting of the Amsterdam Academy on November 24, Prof. Oudemans communicated the results of an investigation to determine exactly how long stars of which the velocity in the line of sight are known would have to go on moving, in order to produce a change of 0.1 magnitude. From his own list of parallaxes in vol. 122 of the *Astr. Nachrichten*, and Vogel and Scheiner's list of proper motions in the line of sight "Potsdam Observations," vii. i. p. 153, 154, fourteen stars were selected, four of them receding from, and the remaining ten approaching, the solar system. Adopting a solar parallax =  $8''.815$ , and the logarithm of the proportion of the increase of brilliancy for one magnitude = 0.400, he found that the period required is given by the formula

$$\frac{6105}{\text{parallax} \times \text{motion}} \text{ years for stars that are receding from,}$$

$$\text{and } \frac{5610}{\text{parallax} \times \text{motion}} \text{ years for those that are approaching}$$

to the solar system; the parallax being expressed in seconds, and the motion in geographical miles (1 geographical mile = 4.61 English miles). Aldebaran proved to be the only star of which the brightness could, since Ptolemy's time, have experienced a loss of 0.1 magnitude by its radial motion, provided that the parallax 0".52, found by Otto Struve, is trustworthy. Elkin found a value = 0".12, and adopting this value, the period becomes 4 times longer. For the other stars the result was 5500 years at least for Procyon; while most of them gave ten-thousands of years as the result.

THE RECENT TRANSIT OF MERCURY.—Details of several of the American observations are published in *Astronomical Journal*, No. 330. At most of the stations, some of the contacts could not be observed on account of clouds, but, on the whole, a fair amount of success attended the observers. Prof. Young observed the first and second contacts, and reports that there was a sort of "hardening" of the sun's limb close to the expected point of first contact a few seconds before the actual contact took place; he has now observed this phenomenon four times, and states that "it may be due to the planet's absorption of the brightest part of the chromosphere close to the limb of the sun, or to some diffraction effect at the limb of

the planet." A large "black drop" was observed two seconds before the second contact. Prof. Todd failed to observe the contacts on account of unfavourable weather, but obtained some results during the passage across the disc. He says:—"The planet appeared perfectly circular, sharply defined about the limb, unattended by any halo or atmospheric ring, and of the same colour as the umbrae of the spots on the sun. No attendant satellite of Mercury was seen, nor could any bright spot be discerned upon the centre of the disc, although intently looked for. Any satellite smaller than 100 miles would have escaped detection."

THE NEW ACHROMATIC OBJECT-GLASS.—*Engineering* for November 23 and 30 contains a full account of a fine 12½ inch equatorial that has just been built by Messrs. Thomas Cooke and Sons, York, for the new observatory at Rio de Janeiro, together with a sketch of the Buckingham Works at York. The description is accompanied with twenty-nine detailed drawings of the instrument. It appears that the works are the only ones in this country where every part of a modern astronomical telescope is constructed; with the exception of the actual making of the glass, everything is done on the premises, even the heavy cast-iron pillars being made in the firm's own foundry. The new instrument, with Messrs. Cooke's standard form of equatorial mounting for large refracting telescopes, is fully equipped for all branches of astronomical research. The clock, too, has all the latest improvements for adjustment. The object-glass is of the three lens form, invented by Mr. Taylor, who deserves the thanks of astronomers for producing an objective which, whilst made of durable kinds of glass, and of moderate focal length, is perfectly achromatic. How this end is attained was described in these columns on March 15 (vol. xlix. p. 464). A section of the lens is shown in Fig. 1. The first,  $L_1$ , is made of baryta light flint, having a refractive index of 1.5637 for the D ray, and its reciprocal of dispersive power is 50.6. The second lens,  $L_2$ , is made of a new glass known as boro-silicate flint. This glass has a refractive index of 1.54685 for the D ray, and the reciprocal of its dispersive power is 50.2. The third lens,  $L_3$ , is made of light silicate crown glass having the following characteristics: refractive index for D ray, 1.5109; reciprocal of dispersive power 60.4. By suitably proportioning the various radii of the lenses, the middle negative lens may be made to almost exactly compensate for the dispersion effected by the other two, and this without necessitating any exceptionally great focal length. If necessary this may be made so small as fifteen times the aperture, and there is no difficulty whatever in making a glass with a focal length of eighteen apertures. A small space is provided between the second and third lens, the object of this being to make the correction for spherical aberration as complete as possible; and when the thickness of this space is properly proportioned, there is an entire absence of spherical aberration for all colours of the spectrum. Object-glasses made on this plan have been tested by astronomers for visual and photographic observations. In both cases the stellar images showed no indications of residual colour, the lenses behaving just like the mirror of a reflector.

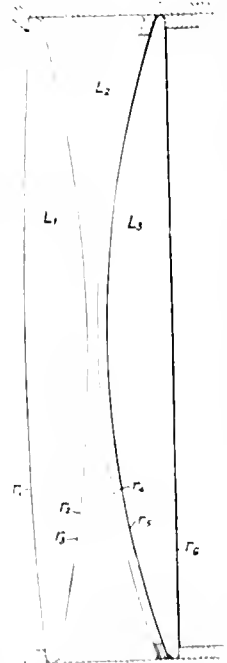

FIG. 1.—Section of the New Object-glass.

EPHEMERIS FOR SWIFT'S COMET.—The surmise noted in these columns last week has proved to be correct. M. Schulhof shows pretty conclusively, in the current *Compte-rendus*, that Swift's new comet is really identical with De Vico's comet 1844 I. The subjoined ephemeris is from one given by Prof. Lamp in the *Astronomische Nachrichten*, No. 3260.

*Ephemeris for Berlin Midnight.*

1894.	R.A. (app.)			Decl. (app.)	Brightness.
	h.	m.	s.		
Dec. 13 ...	23	21	36	... -5 33'9	
" 15 ...	26	46	...	4 55'7	... 0.53
" 17 ...	31	52	...	4 17'0	
" 19 ...	36	54	...	3 40'5	... 0.48
" 21 ...	41	53	...	3 3'5	
" 23 ...	23	46	48	... -2 26'9	... 0.43

The brightness of the comet on November 21 has been taken as unity.

**A NEW STAR?**—The Rev. T. E. Espin has announced that a very red star of the eighth magnitude, not in the Bonn Durchmusterung, was found by him on November 29, in R. A. 17h. 54.3m. Decl. + 58° 14'. The spectrum belongs to Secchi's Type IV.

**PROF. VICTOR MEYER'S NEW METHOD OF DETERMINING HIGH MELTING POINTS.**

**A DESCRIPTION** of improved apparatus for the determination of high melting points, by his admirable new method, is contributed to the current *Berichte* by Prof. Victor Meyer, in conjunction with his students Messrs. Riddle and Lamb. The simplicity of the method will doubtless cause it to take rank immediately among the standard processes for the determination of physical constants, and alongside the universally popular method of determining vapour densities, which we likewise owe to the distinguished Heidelberg professor. Naturally, however, operations at temperatures higher than those at which the hardest varieties of glass soften, must perforce be conducted in apparatus constructed of platinum, just as in the cases of the determinations of vapour density at the same high temperatures. One of the main advantages of the method is that it only necessitates the use of a very small quantity of the substance whose melting point is to be determined, thus enabling it to be extended to compounds of the most extreme rarity.

The method is based upon the principle of measuring the temperature by means of a miniature air thermometer constructed of platinum, the air contained in which is expelled, at the moment when the fusion of the substance under investigation occurs, by means of a soluble gas into a gas-measuring vessel filled with a liquid capable of dissolving the expelling gas. The substance whose melting point is to be determined is placed in a small and very narrow platinum tube, which is fixed to the bulb of the air thermometer during the operation, and both are immersed in a bath of a fused salt whose melting point is considerably below that of the substance under investigation. Hence the operation of determining a high melting point by this method is perfectly analogous to that usually adopted in determining ordinary melting points lower than the temperature of boiling mercury.

The air thermometer is simplicity itself. It consists of a spherical platinum bulb of about 25 c.c. capacity, from which rise parallel to each other two relatively long capillary tubes, also of platinum. One of the tubes passes down into the interior of the sphere, almost touching the opposite inner surface, while the other only just pierces the envelope. Both are bent at right angles at their upper extremities, in opposite directions. In order to eliminate all errors due to the capillary tubes a compensator is also employed, consisting of a long capillary U-tube of the same bore and bent at right angles at the extremities, so as to form an exact counterpart of the capillary portion of the air thermometer. The small tube containing the substance is firmly fixed by means of stout platinum wire so that its lower portion is in close contact with the sphere; the walls of the tube are of the same thickness as those of the sphere. The salt employed for the purposes of a bath is contained in a capacious platinum crucible, supported over a table furnace in a miniature basket of platinum gauze. One of the capillary tubes of the air thermometer is ready to be connected with an apparatus for generating pure carbon dioxide, and the other is attached to a gas-measuring burette similar to the well-known Schiff nitrogen apparatus, but somewhat narrower, and surrounded by the outer tube of a Liebig's condenser, through which a stream of cold water is continually passed. This arrangement enables the air to be collected and measured in the proximity of the furnace. The measuring

burette is filled with a concentrated solution of caustic potash. The temperature of the water-jacket is measured by a thermometer immersed in a small accessory reservoir, through which the water passes immediately after leaving the jacket. A very simple device has been adopted for determining the exact moment when fusion occurs. Before the experiment the little test-tube is heated until the substance melts; a fine platinum wire, furnished with a thickened end, is then inserted in it, and allowed to become fixed by the solidification of the substance. The fine wire is then passed over a pulley some distance overhead, and the free depending end is attached to a weight; just below the weight a bell is hung.

When everything is ready for the actual operation of determining a melting point, the salt in the crucible is fused, the lower part of the air thermometer and its attached substance-tube are inserted in the bath of liquid, as is likewise the compensator, connection with the measuring burette is made, and the carbon dioxide apparatus is arranged to be delivering the pure gas. When the temperature of the bath at length attains that of the melting point of the substance, the portion of the latter in immediate contact with the walls of the platinum tube fuses, and instantly the wire is released, and the weight falls and strikes the bell. The moment the sound is heard, connection with the carbon dioxide apparatus is established, and the air contained in the thermometer is displaced and driven into the measuring burette. The compensator is similarly treated, and the quantity of air which it contained deducted from that contained in the thermometer. From the resulting volume, together with the knowledge previously obtained concerning the capacity of the thermometer and compensator and the known expansion of air, the melting point is obtained by a very simple calculation.

Four groups of interesting results have already been obtained by use of the new method, indicating the dependence of the melting point upon atomic weight. They are as follows:

Salt.	Melting point.	Salt.	Melting point.
Potassium chloride	800.0	Potassium iodide	684.7
Potassium bromide	722.0	Rubidium iodide	641.5
Potassium iodide	684.7	Cesium iodide	621.0
Sodium chloride	815.4	Calcium chloride	806.4
Sodium bromide	757.7	Strontium chloride	832.0
Sodium iodide	661.4	Barium chloride	921.8

It will be observed that in the halogen salts of both sodium and potassium a diminution of melting point accompanies a rise in the atomic weight of the halogen; also that a lowering of the melting point accompanies a rise in the weight of the metallic atom in the case of the iodides of the alkali metals potassium, rubidium, and cesium, while the reverse occurs with respect to the chlorides of the alkaline earthy metals calcium, strontium, and barium. Whether there is rise or fall of the melting point with ascending atomic weight, however, the salt of intermediate molecular weight invariably exhibits an intermediate melting point.

A. E. TUTTON.

*SCIENCE IN THE MAGAZINES.*

**THERE** are very few articles on purely scientific subjects in the magazines received by us this month. Apparently the magazine-reading public thinks a scientific pabulum unsuitable for Christmas reading; or is it that men of science are too deeply engrossed in their researches to cultivate the art of writing interestingly upon the wonders of nature? Literary men frequently play fast and loose with natural phenomena and laws, and are often pilloried for doing so; but, on the other hand, many men of science do not pay due regard to the literary polish which is essential to an attractive style.

The first number of the *Fortnightly* under the new editor, Mr. W. L. Courtenay, contains two articles of interest to our readers, one on "A True University of London," by Mr. Montague Crackenthorpe, and the other on "The Spread of Diphtheria," by Dr. Robson Roose. Mr. Crackenthorpe deals broadly with the whole question of the expediency of establishing in London a University which shall teach as well as examine. He defines the work of a true metropolitan University as follows: (1) To do the work of the higher teaching by its own professorial staff, and to superintend and aid its being done by other educational agencies in the metropolis. (2) To examine and to

grant degrees, but to grant them as a mark of success in regular and systematic courses of study, rather than in the display of hastily acquired, and, therefore, ill-digested knowledge. To stimulate scholarly and scientific research by means of well-equipped libraries, laboratories, and other like apparatus, and by the institution of public lectures of an advanced character, like those of the Sorbonne and the College de France. The scheme drawn up by the Gresham Commissioners satisfies most of these requirements, and a *Senatus Academicus* in the shape of a Statutory Commission is all that is wanted to establish it.

So much attention has recently been given to the new treatment of diphtheria, that Dr. Roose's sketch of the history of the complaint, and the circumstances which tend to promote its spread, comes very opportunely. His description of the measures calculated to check the prevalence of the disease, and of the remedy lately introduced, is clear and concise, whilst the following statement, though commonly known in the scientific world, will remove the misapprehension that exists in the minds of a large section of the general public—"Löffler and Klebs discovered the microbe of diphtheria, and studied its life-history; Roux and Yersin demonstrated that the bacillus was capable of evolving toxic material, and Behring crowned the edifice by discovering the antidote."

An address by Prof. G. W. Prothero, on "Why should we learn History?" contained in the *National*, would at first hardly seem to be a subject for comment in these columns. There is, however, much in the address worth noticing here, for Prof. Prothero shows that history, if not strictly speaking a science, may be taught in a scientific way. Let us briefly state his argument. There are many gaps in history, but in every science there is a lack of information on certain points. Even astronomy, the most exact of the sciences, has its dark spots, and there are shady places in evolutionary biology. Thus, so far as imperfection of knowledge goes, history and science only differ in degree. A greater difficulty, perhaps, is that the historian cannot employ experiments either to discover facts or to test observations; but here again it suffers in company with geology and other branches of natural knowledge concerned with the past. History is therefore not disqualified from being a science because it is not experimental. The infinite variety and extent of historical phenomena, and the presence of the human element are, however, "obstacles which, it must be allowed, check history on the threshold of science. If indeed the term science is to be restricted to the knowledge and application of general laws—if that alone is science which can be felt with certainty the occurrence of certain results—if science deals with no phenomena but such as can be exactly weighed and measured—then history is not a science at all. But this is surely to restrict science within too narrow limits. All sciences are not equally exact or equally capable of generalisation. There is, in fact, a regular gradation from the sciences of abstract reason and mathematical formulæ, through the phenomena of the inanimate and the animate world to the world of man." But, says Prof. Prothero, if history be granted a place among the sciences, it must be scientific in the ascertainment of its facts. Take the Black Death as an illustration. The vague and exaggerated statements of certain chroniclers of its ravages may be taken as evidence, or the more laborious process of searching the registers of the time may be explored. The difference is that one of the ways is scientific, while the other is unscientific. In the drawing of conclusions, also, there is the same distinction between scientific and unscientific work, as there is in the ascertainment of historic facts. For instance, Buckle, in illustrating his theory that national character depends largely upon food, attributes the weakness of the Hindus to an almost exclusive diet of rice. A striking but misleading generalisation, for, as Sir H. Maine has pointed out, the great majority of the Hindus never eat rice at all. There is, then, a scientific way as there is an unscientific way of studying history. If treated one way, its results are guess-work and delusion; if treated another way, if industry, reason, and sober judgment are brought to bear, its results are in many cases matter of certainty in many others matter of at least high probability. And, if we except the sciences of mathematics, what more can be said of any science? The main object of Prof. Prothero's address was to show that historical study exerts considerable influence upon the mind and character. This is certainly the case, and if the student is trained on the lines indicated in the foregoing, intellectual results of the highest order must follow.

The great landslip which caused the formation of the Gohna Lake, Gurhwal, in the central Himalayas, has led Mr. W. M. Conway to write on "Mountain Falls" in the *Contemporary*. This catastrophe, however, is only used as a peg upon which to hang an account of the great Alpine landslip which buried part of the village of Elm, in Canton Clarus, thirteen years ago. The *Contemporary* also contains a metaphysical article by Emma Marie Caillard, in which cosmic and ethical processes are discussed, and Prof. Huxley's opinions on evolution and ethics are criticised. Prof. Huxley is also involved in a paper on religion and science, contributed by A. J. Du Bois to the *Century*. Another article for abstract philosophers is Prof. Seth's second paper on "A New Theory of the Absolute."

Sir Robert Ball contributes to *Good Words* another of his interesting—albeit superficial—papers on great astronomers, the subject being Sir John Herschel. *Chambers's Journal* contains the usual complement of chatty articles, among which we notice one on smoke absorption, descriptive of Colonel Dulier's patent system of removing the soot and sulphurous acid from the products of combustion, by treatment, before passage into the chimney, by both steam and water; and another on remarkable hailstorms.

A passing reference will suffice for the remaining papers on scientific topics. The result of prematurely releasing a chrysalis from its cocoon, a subject on which we published a letter by Dr. L. C. Jones in our issue of November 22 (p. 79), serves Mr. W. C. Wilkinson as the theme of a poem in the *Century*. St. George Mivart writes popularly on "Heredity" in the *Humanitarian*, his paper dealing chiefly with Prof. Weismann's speculations. A posthumous paper of Richard Jefferies' appears in *Longman's Magazine*, and Mr. Phil Robinson contributes a facetious paper on rattlesnakes to the *English Illustrated*. In addition to the magazines and reviews named in the foregoing, we have received *Scribner*, *Cassell's*, and the *Sunday Magazine*; but these do not contain any articles that can be commented upon here.

#### OYSTER CULTURE ON THE WEST COAST OF FRANCE.

AT the request of the Lancashire Sea-Fisheries Committee, I spent some time, last June and July, in investigating the various methods of shell fish culture in use along the western coast of France from Arcachon in the south to Brittany in the north. There can be no doubt that there are extensive and flourishing shell-fish industries along the French coast, and one is struck very forcibly with the admirable manner in which the people seem to make the best of unfavourable conditions, and to take full advantage of any opportunity given to them by nature. Few places on any coast could look more desolate and forbidding than the vast mud swamps of the Bay of Aiguillon, and yet by means of the "bonchot" system many square miles of this useless ground have been brought under cultivation, and an industry established which supports several villages. Then again, the neat little enclosures along the beach at many places, carefully tended by the owners at low tide, remind one constantly of market gardening, and enforce the truth of the idea, long familiar to the biologist, and now beginning to be more generally recognised, that the fisherman should be the farmer, not the mere hunter of his fish, and that aqua-culture must be carried on as industriously and scientifically as agriculture.

In addition to industry and care on the part of the fisherfolk, women as well as men, the success of the shell-fish industries in France is largely due to the encouragement and wise assistance of the Government, especially in the regulation of general oyster-dredging and the reservation of certain grounds for supplying seed. The practical question—and one of enormous importance—is: Is there anything special in the conditions in France, either of the land or of the water, which would render their methods inapplicable to our more northern shores? I do not believe that the question can be satisfactorily and finally answered until some experimental cultures on a fairly large scale have been tried; but a consideration of the details and results of the French methods will at least give us some idea of which experiments are worth trying, and of the localities which might be cultivated with most prospect of success.

(Abstract forwarded by Prof. W. A. Herdman, F.R.S., to the Lancashire Sea-Fisheries Committee.)



The leading characteristics of French oyster culture are 1) that the whole is under the regulation and supervision of the State, concessions of ground being given to individuals or companies (e.g. at about 30 francs the hectare at Arcachon, for the purpose of forming oyster "parcs"; (2) that certain grounds are set aside or preserved as banks of breeding oysters to supply the spat; and 3) that the whole process of raising the spat, and rearing and fattening the oyster, is not carried on at one locality, but is subdivided and specialised, spat-production taking place best at one locality, such as Arcachon, and fattening for market at another, such as Marennes.

Two species of oyster are cultivated, *Ostrea edulis*, the ordinary rounded flat oyster of north-west Europe; and *O. angulata*, the elongated Portuguese oyster. The latter, although increasing in numbers in some places, and becoming of considerable commercial importance, is not so highly thought of as is *Ostrea edulis*.

There are now only two places on the coast of France where spat is produced in sufficient quantity to be of commercial importance. These are Auray, in the north, and Arcachon, in the south, and these two localities supply all the other oyster culture centres in France, and even export to other countries. One merchant I met at Arcachon told me that he had already sent eleven millions of oysters to London that season.<sup>1</sup> I visited in all about ten different oyster-culture centres; but as several of these showed nothing special, they need not be mentioned. The arrangements for the capture and rearing of spat were best seen at Arcachon, and for the further rearing and the fattening of the adults at La Tremblade and Marennes on the estuary of the Seudre. At Arcachon I was fortunate in enjoying the hospitality of the excellent Biological Station, which was established nearly thirty years ago by La Société Scientifique d'Arcachon, and which was made use of by Paul Bert in 1867 for his observations on the physiology of marine animals.

Arcachon presents remarkable facilities for the study of shallow-water marine forms, and is of great interest to the biologist, as well as to the ostriculturnist. Its vast inland sea (Bassin d'Arcachon), which is about 80 kilom. in circumference, contains at high tide about 15,000 hectares of area, and is, over the greater number of the channels, about 5 to 10 fathoms in depth, while two-thirds of the whole area dries at low tide. In the middle of the "bassin," and north of the town of Arcachon, is a small island, Ile des Oiseaux, and on the shores of this, and on various other flat shallow parts which are exposed at low tide, and which are called "crassats," are situated the oyster "parcs." Some of these areas are reserved by the State for the purpose of producing spat, a wise precaution, although some of the parqueurs think the State reservations unnecessary, as there are so many adult oysters over the ground that plenty of spat is sure to be produced. Certainly during the time of my visit, which was just when the free-swimming embryos were settling down, the water over the parcs seemed to be swarming with them, and the spat was making its appearance over all sorts of suitable submerged objects. The summer of 1893 was, however, a particularly good season, which the parqueurs attributed to the great heat. Probably calm weather and absence of rain during the critical period when the young oysters are free-swimming, and then settling down, has as much to do with a heavy fall of spat as the actual temperature.

The oyster reproduces at Arcachon between May and the beginning of July, and the young animal leads a free swimming existence for about a week before settling down as spat. The parqueurs examine carefully the condition of the spawn in the old oyster, and at what they consider to be the proper time (generally about the end of June) for catching the deposit of spat, they place their "collectors" in position. It is of importance that the collectors should not be put in the water too soon, as they are liable to become coated with slime and sediment, which will prevent the young oyster spat ("naissain" from adhering. The collectors are crates "gabarets" or "ruches") of earthenware tiles, coated with a limy cement

<sup>1</sup> Two-year olds, measuring 3 to 2 cm. across, cost at the rate of 12 francs per 1000, and somewhat older ones, measuring 6 to 7 cm., 25 francs per 1000. These prices include packing and carriage as far as Bordeaux, where they meet the steamer. On an average only a per cent. die on the journey. From the middle of March to the middle of April is the best time to send young oysters for stocking purposes to England. Before that it is liable to be too cold in England, and later it is too hot in Arcachon for transportation to be effected safely.

which gives them a whitewashed appearance. The tiles are like ordinary roofing tiles, about fourteen inches long by six inches at one end and five at the other, and half an inch in thickness. The cement with which they are coated is made of lime mixed with sea-water and a certain amount of sand, so as to form a creamy paste. Different proprietors use slightly different proportions of lime and sand. The process of coating ("chaulage") adds from one-sixteenth to one-eighth inch in thickness to each side of the tile. It has to be done with some care, so that the limy layer may be of the right nature, sufficiently strong and adhesive, and yet readily detachable when the time for "detrouage" comes, so that the young oysters may be removed from the tiles without injury, and without the necessity of breaking up the tiles, as used to be the case. By the present method the little oysters and film of cement can be flicked off rapidly by a skilled hand with a square-ended knife, and the tiles preserved for use again the following year. A dozen or more millions of these tiles are probably employed each year at Arcachon. The prepared tiles are arranged in alternating rows lengthways and breadthways inside cases made of strips of wood, so that the water may flow in readily between and around them. The cases of collectors I measured were about 6 feet 2 feet and 3 feet in height, each holding 120 tiles arranged in ten layers. The alternating arrangement of the layers is intended to break up the currents of water as the tide runs through the "ruche," form eddies, and so give the young oysters a better opportunity of affixing themselves to the tiles. The tiles are all placed with the convex surface upwards, as it is very important that there should be as little opportunity as possible given for the collection of any fine sediment in which the young spat might be smothered. The arrangement of tiles above described is now considered the best at Arcachon. Various other arrangements have been tried, and may be suited to special conditions of bottom or depths of water.

I was very fortunate in seeing some of the tiles just after the young oyster spat had been deposited, and photographed such a tile covered thickly with the minute amber-coloured specks. There may be several hundred such young oysters on one side of a tile. During my stay at Arcachon I found that the temperature of the water varied from 74 F. to over 80 F., and the specific gravity from 1.022 to 1.024. However, it is known that no such high temperatures are really required for spat production, since, e.g., Captain Dannevig has had an abundant deposit of spat in his pond near Arendal in Norway, where the July temperature of the water was only 63 F. To compare these with our own district, we find that in the same week of July 1893 the water off the south end of the Isle of Man was on the average about 60 F. with a specific gravity ranging from 1.025 to 1.026, while shoal pools near the Biological Station at Port Erin, comparable as to exposure with the oyster parcs at Arcachon, reached as high a temperature as 76 F. Dr. Bashford Dean<sup>1</sup> and other authorities state as their opinion, that a low specific gravity is necessary for a good deposit of spat, but there is no unanimity on this point amongst the practical men at Arcachon—some of whom are keen observers, and are in the habit of taking the temperature and specific gravity.

After removal from the tiles, those young oysters which are not sold to "civeurs" away from Arcachon are kept for another year or two in the parcs. They are placed at first in flat trays having a floor and lid of close galvanised wire netting, of about half-inch mesh, and these trays ("ambulances" or "caisses ostreophiles") are placed between short posts in the water on the oyster parc, so that the tide can run freely through them, supplying the oysters with food and oxygen. They measure about 6 feet by 4, and are 6 inches deep. They serve to keep the young oyster, during the early period of its life, out of the sediment, and they also protect it from its numerous natural enemies, such as the starfishes and crabs, which manage to suck or pick out the soft body, and whelks, such as *Barbana*, *Murex* and *Nassa*, which can bore a hole through the shell. The ambulances are constantly looked after by the oyster men and women, who come at low tide, when they are exposed, open the lids, and pick over the contents, removing enemies and impurities which may have got in, taking out any dead oysters, and rearranging those that are left, so that all may have a fair chance of obtaining food and growing normally. The young oysters grow rapidly in the ambulances, and soon have to be thinned out. The larger ones are removed, and if large enough are thrown into the open areas of the parc. In this way, by

<sup>1</sup> Various important papers in Bulletin U.S. Fish Comm. 1890.

thinning out, rearranging, and adding fresh supplies, relays of young oysters in their first year may occupy the ambulances for eight months, although an individual oyster may only be in for a month or so.

Eventually all the oysters not sold to cleveurs get transferred from the ambulances to the open rectangular areas, like little fields, which make up the rest of the parc. The low banks bounding these areas are formed of two parallel rows of close set vertical bunches of the local heath, *Erica scoparia*, with the space between, a foot or more wide, filled in with masses of a tenacious clay obtained from the Ile des Oiseaux. Planks of wood and stakes, to strengthen the boundary, are also used in places, and at one corner a sluice is formed, so that the water at low tide may either be retained to a depth of 6 or 8 inches, or allowed to run off as required. About one million oysters can be accommodated in each little field, which is about at the rate of 125 to the square metre. Going thoroughly over a parc, partly in a boat and partly by wading, gives one an excellent idea of the extensive and profitable system of aquiculture practised at Arcachon.

Between neighbouring oyster parcs, and surrounding the "concessions" of the various proprietors, run lanes of water about 4 metres wide. These give ready access to the parcs, and can be traversed by the long gondola-like boats of the parqueurs. The lanes are bordered by tall saplings with bunches of twigs left on. These are called "pignons." They keep waving in any slight breeze, and give a characteristic appearance to the scene. The oyster men declare that they are of use in frightening away fish, and especially the voracious ray *Myliobatis*, which might otherwise do great damage in the preserves. Possible depredations of another kind are guarded against by the "pontons," or large barges, moored at the corners of the parcs in which the "gardes des peches" live.

Great numbers of the oysters bred and reared through their early stages at Arcachon are sent to Marennes and La Tremblade, in the flat district on both sides of the estuary of the Gendres, to be fattened in a *par d'écuage*, and "greened" by feeding upon the diatom *Nitzschia fusiformis*, var. *ostrearia*. Wide canals from the estuary lead the sea-water inland, and supply the numerous "claires," which are merely shallow artificial ponds excavated in the clay and marly soil. In spring and early summer the muddy floor of the claire undergoes a good deal of preparation by digging, cleaning, draining, and exposure to sun and air, in order that later on, when sea-water is re-admitted, at first in small quantity, it may be in what has been found by experience the most favourable condition for the growth of the desired kinds of lower algae. These soon cover the floor with a dense green growth, which the cleveurs recognise as being of great importance to the nutrition of the oysters. Samples of the growth which I collected from the bottoms of several claires consisted of *Chlorella vulgaris*, and *C. cf. caudata*, along with *Stauroneis glacialis* and a *Lyngbya* and little tufts of *C. cf. caudata*, while a more detailed examination with the microscope shows that these plants are teeming with small animals and other forms of life, and nearly everything is covered with innumerable diatoms. Probably the larger green algae, thought so much of by the cleveurs, are only of importance in oyster culture in providing points of attachment and shelter or favourable environment for the microscopic forms of life, and especially for the diatoms. It is well known that diatoms form a most important constituent of the food of oysters, and that the greenish blue tint of the celebrated Marennes oysters is due to the presence in the claires of enormous quantities of *Nitzschia fusiformis*, var. *ostrearia*, upon which the oysters feed. This form is found in our own fishery district in the estuary of the Dee and probably elsewhere, although not abundantly; but it is probable that there are various other allied diatoms that would do equally well for rearing and fattening oysters on, and as a matter of fact the examination of the contents of an oyster's stomach shows that the food consists of a number of different kinds of diatoms as well as other minute organisms.

Altogether, all the evidence I was able to collect shows, I think, that the bottom of a claire is teeming with microscopic life, and that it is probably this rich feeding *alim* which is necessary in order to bring the oysters, in a very short period—a few weeks usually, sometimes ten days or a fortnight is sufficient—to the desired condition of fatness and flavour. The autumn and early winter months are said to be the best for fattening and greening.

I have never seen all reference to the industry at Pointe

le Chapus, at the Island of Oléron, at La Rochelle, at Les Sables d'Olonne, and at Le Croisic—except a brief explanation of the basins of "degorgement" seen at Le Chapus and elsewhere. These are shallow tanks, high up on the beach, with smooth bricked or tiled floors, so that they can be kept clean and free from mud. Their purpose is to enable the oysters taken fresh from the parcs and claires, and which naturally have some fine mud and food-matters of a decomposable nature clinging to them, both externally and internally, to lie for a few days in clean water, and so get rid of their impure mud and excreta before being packed up and sent off on a journey. The oysters also become accustomed in these basins, which can be emptied and filled with water periodically, to close their shells and stand prolonged exposure to air.

I do not see that the French shores are, in any important respects better fitted for shell-fish culture than some parts of our own Lancashire and Cheshire coast.<sup>1</sup> The deposits, both littoral and submarine, are, on the whole, much the same, the fauna, both macroscopic and microscopic, is scarcely appreciably richer, and although the temperature of the water is decidedly higher in the south—probably on the average about 10° F. higher in summer—I do not think that that is an essential condition, so long as the winter temperature of our water does not get too low. It would certainly be necessary, I think, to keep our oysters completely submerged during the winter months; but there are several places in the estuaries of the Dee and the Ribble, and in the Barrow Channel near Roe and Peel Islands, where "littoral" cultivation in summer might be combined with "bedding out" in winter—somewhat as is done at present with American oysters in the estuary of the Wyre, near Fleetwood. As to the other conditions—of bottom, of water, and of food, several places in the Barrow Channel and in the Dee estuary seem to me to be well fitted for oyster culture.

#### ENDOWMENT FOR SCIENTIFIC RESEARCH AND PUBLICATION?

##### I.

TWENTY years ago Prof. Tyndall delivered in New York and in other cities of this country a series of lectures upon light. The last of the series was an impressive plea for a more thorough prosecution of original research in pure science; and incidentally, for the need of endowments to maintain it. I was fortunate in having the opportunity to listen to that remarkable course of lectures, and to that plea for science. Its impression has never left me. The impression was the deeper, because Tyndall set upon it the seal of self-denial. Some 30,000 dol., nearly the entire net proceeds of his lectures in the United States—money for which he undoubtedly had abundant use in his own affairs, or at least in the prosecution of researches in his own country, and which by all precedent and the example of other lecturers he would have taken with him—this he has given to the science of this country, endowing therewith, in 1885, three scholarships for the prosecution of original research in physics, one under the direction of Columbia College, one under Harvard, and a third at the University of Pennsylvania.

The truths uttered and the example set by this self-denying master have already many times borne fruit. The late President Barnard, of Columbia College, who was a warm supporter of Prof. Tyndall when here, bequeathed to Columbia upon his decease a few years since the sum of 10,000 dol. for the endowment of another fellowship for the encouragement of scientific research, upon substantially the same terms as those of the Tyndall scholarships. In other parts of the country there have been some other endowments for similar purposes. In the last year Columbia has also received 100,000 dol., the munificent bequest of Mr. Da Costa, for the establishment of the department of biology. Although this bequest is not primarily for the prosecution of original research, it is not restricted by hampering conditions, and will to some extent, it is hoped, admit of a direct and continuous support of the highest and most advanced studies.

The appeal made by Tyndall has been often renewed by

<sup>1</sup> This, being a report to the Lancashire Sea Fisheries Committee, is only concerned with localities within the Fishery District.  
Address delivered by Mr. Addison Brown, at a meeting of the Scientific Alliance of New York. (Reprinted from Smithsonian Report, 1902.)

scientific men; by the heads of universities; by the presidents of scientific associations, here and abroad; and by none, perhaps, more eloquently than by Dr. Edwin Ray Lankester, in his address before the biological section of the British Association at Southport, in 1883.

What shall we say to the call and the examples of such men? Was the gift of Tyndall based only upon an idle fancy? Or was it the result of a clear perception of a profound truth, viz. America's need of that money as a stimulus and support to more scientific research; the call on him being felt to be the more imperious, because the need of it was so plain to him, while obscure to others; and making his act, therefore, a noble instance of self-renunciation in an unappreciated cause?

"To keep society as regards science in healthy play," he says, "three classes of workers are necessary:

"(1) The investigator of natural truth, whose vocation it is to pursue that truth and extend the field of discovery for truth's own sake, without reference to practical ends.

"(2) The teacher, to diffuse this knowledge. . . .

"(3) The applier of these principles and truths to make them available to the needs, the comforts, or the luxuries of life. . . .

"These three classes ought to coexist and interact. The popular notions of science. . . often relate, not to science strictly so-called, but to the application of science."

The great discoveries of scientific truth, he continues, are "not made by practical men, and they never will be made by them; because their minds are beset by ideas which, though of the highest value in one point of view, are not those which stimulate the original discoverer."

In a chance conversation, a few weeks since, I received a confirmation of these words, so direct and unexpected, that it may bear citation. I was talking with an electrical expert who had made several very interesting and important inventions. I asked him of how much importance he conceived that the scientific men of the closet, the original investigators, so-called, had been in working out the great inventions of electricity during the last fifty years—the telegraph cables, telephones, the electric lighting, and the electric motors; and whether these achievements were not in reality due, mainly, to the practical men, the inventors, who knew what they were after, rather than to the men of science, who rarely applied their work to practical use?

"Not at all," he said, "the scientific men are of the utmost importance; everything that has been done has proceeded upon the basis of what they have previously discovered, and upon the principles and laws which they have laid down. Now-a-days we never work at random. Look at that electric light! Of the energy expended in producing it, only 7 per cent. appears as light; the rest, 93 per cent. is wasted, mainly in heat. We are all now trying to prevent this enormous waste. I want to reverse that proportion; but if I can reduce the waste to only 33 per cent. a patent of my invention will be worth millions of dollars for its economy in production. In seeking this we do not work at random. I go to my laboratory; study the applications of the principles, facts, and laws which the great scientists like Faraday, Thompson, and Maxwell have worked out, and endeavour to find such devices as shall secure my aim."

This is but an expression, in another form, of what Tyndall said twenty years ago: "Behind all our practical applications there is a region of intellectual action to which practical men have rarely contributed, but from which they draw all their supplies. Cut them off from that region, and they become eventually helpless."

What is true in one department of natural science is, I apprehend, equally true in all. The practical men do not work at random, but upon the basis of what scientific research and publication have previously put within their grasp.

It is evident, therefore, that not only the advancement of knowledge itself, but all possibility of any continuous advance in those great improvements which are to mitigate the sorrows, and promote the health, the conveniences, and the comforts of men, is vitally dependent upon the progress of scientific research. In recent years how marvellous have these improvements been! Besides those that are most common and familiar to all, what miracles, almost, have been achieved through the photograph, the spectroscope, the microscope; by the discovery of the sources of fermentation and of putrefaction; by the discovery of anaesthetics and the application of antiseptic methods in surgery, and in the treatment of other lesions! These latter discoveries

alone have ameliorated beyond expression the sufferings of man; they save more lives than war and pestilence destroy, surpassing even in that regard the safety lamp of Sir Humphrey Davy—an invention which at the time it was made, was said to have exceeded every previous discovery as a means of saving human life, except, possibly, inoculation for smallpox.

This vital relation between the advancement of knowledge and the welfare of man furnishes an all-sufficient reason for the continuous and never-ending prosecution of original research. Of necessity the original work of discovery must always lead; that must always precede the practical applications. The necessity for such research must therefore continue so long as science and human society endure. As there is no limit to the advance of knowledge, so there can be no limit to the benefactions it is capable of conferring upon mankind. The more rapid the advance, the more speedy the enjoyment of its fruits. In this relation alone the need of ample provision for scientific progress is one that addresses itself equally to the nation, to the State, to philanthropists, and to all who would advance the welfare of man on the broadest and most enduring lines.

How shall such research be maintained and extended? The investigator of pure science does not work for profit. His discoveries are not marketable. The law allows no patent upon a principle of nature or the discovery of a new truth. Newton could not patent the law of gravitation, nor Volta the galvanism of the voltaic pile; nor Ehrenberg and Schwann the discovery of the widespread influence of bacteria; nor Faraday, nor Henry, electro-magnetism; nor Joule, his correlation of forces; nor Jackson, his anaesthetics; nor Lister, his antiseptic treatment; nor Koch, nor Pasteur, their discoveries of the bacilli, the destruction of which may lead to the cure or amelioration of terrible diseases. To the practical men and to the inventors, on the other hand, who apply to the specific wants of men the truths and principles which the men of science have made known to them, the law, in the form of a patent, gives a monopoly of from fourteen to twenty-one years. They thus obtain, as a rule, a reasonable, and, in some cases, even an excessive, pecuniary reward. In this country alone nearly 500,000 patents have been issued; they are increasing at the rate of about 25,000 per year. In the extreme multiplication of patents affecting a large part of everything we use, the whole world, it might almost be said, is paying tribute to the inventors and practical men; while to the original discoverers, who have made so much of all this possible, there is no promise of pecuniary reward.

This is not said by way of complaint. In the nature of things it is scarcely avoidable. The aims, the motives, the methods, and the genius of the two classes of minds are and ever must be widely distinct. Original discoverers cannot be turned aside from their special work to become mechanics and inventors without infinite loss. Prof. Henry had one form of the electric telegraph in actual use some years before Morse conceived it.<sup>1</sup> But how great would have been the loss to science, without any corresponding gain, had Prof. Henry in 1830 turned away from pure science to do the subsequent work of Morse in adapting the telegraph to common and valuable use!

Research in pure science can never be made a self-supporting pursuit. It can never, therefore, be carried forward broadly, and continuously, and effectively, except through men sustained by some form of stipend or endowment. Occasionally, it is true, men of independent fortune, like Harvey, and Darwin, and Lyell, and Agassiz, have devoted themselves to original research upon their own means, and have accomplished most important results. But these instances are rare. Many other persons, too, with aptitudes and tastes for research, though not following a scientific career, have carried on private researches in the intervals of leisure stolen from the exacting demands of professional or business life; and these have, in the aggregate, added no small amount to the common stock of knowledge.

It is no disparagement, however, of these subordinate workers to say that nearly all the great discoveries, and nearly all the great advances along the lines of knowledge, have been achieved by men who in the main have devoted their lives to the work, and have been supported through institutions or endowments which made this devotion possible. Government appointments, professorial chairs, or salaried positions in scientific institutions of some kind, have been and must continue to be our chief dependence. And it is manifest that these can only be maintained by Government aid, or by the bounty of private in-

<sup>1</sup> "Smithsonian Report," 1872, pp. 170, 272.

Methods. The former is mainly the European system; the latter, in the main, is ours. There, universities are founded by the Government; here, chiefly by the people.

In Germany there are twenty-one universities maintained by the Government. In each of these, as Dr. Lankester states, there are five independent establishments in the department of biology, *viz.*, in physiology, anatomy, pathology, zoology, and botany. At the head of each of these establishments there is a professor, with two paid assistants, making altogether about 300 for biological research in Germany; and he estimates about one-quarter of that number in the same department in England. In all the sciences, therefore, there would probably be found in Germany from 800 to 1000 persons of high scientific attainments, supported by the Government in the universities, who are regularly and systematically engaged in the discovery of new scientific truth. For it is there made both the object and the duty of the professors of natural science to carry on original investigations by work in the laboratory. Their positions are obtained through previous distinction in such investigations, and it is for this work that their small but fixed stipend is paid by the Government.

In the College de France, also maintained by the Government, there is the same requirement, though with a larger salary to the professors, and with the added duty imposed on them to deliver to the students about forty lectures yearly upon the subjects of the professors' researches; while in Germany the professors also receive from each student who attends their lectures, a moderate fee, which serves to increase their meagre stipend, as well as to stimulate their activity and usefulness. Under this system, Germany has become the greatest school of science, and the resort of the whole world.

In this country the opposite system prevails. The colleges and universities are mainly private foundations, dependent on private gifts and endowments. The colleges are unwisely multiplied. All are more or less cramped for money. This limits the number of professors and assistants appointed for instruction, and crowds them with routine work. The result is that in all but a few colleges, and in these until comparatively recently, the duties of instruction have left to the professors but little time or opportunity for the prosecution of original investigations, and these with but poor equipment and inadequate means.

In not one of all our colleges and universities, so far as I have been able to ascertain, is there a single professorship endowed or founded, even in part, for the avowed object of original scientific research. Instruction, not discovery, is the only avowed object. It is to the great credit of American professors and teachers that, with so much routine work on their hands, and so little leisure for research, they should have accomplished by purely voluntary studies so much as is shown in their contributions to our scientific publications.

To what is said above, perhaps a virtual exception should be made as respects our astronomical observatories, in which, the labors of instruction being less, original work has been perhaps neglected, and has been accomplished with most signal success. To some extent this may possibly apply to our medical schools also. And in other departments, generally, wherever time and opportunity have been afforded, much original work has been done by our professors; some of it of the first class. This is attested, not to mention living instances, by the work of Prof. Henry at Princeton, Dr. Torrey at Columbia, Dr. Silliman at Yale, Dr. Gray at Harvard, and many others that might be named. In a number of the States, also, and at Washington, there have been maintained by the State or nation a number of scientific men, in connection with certain State or national interests, who have accomplished most important results; of these, Dr. James Hall, of this State, is a conspicuous instance. At Harvard and at other colleges some tables of apparatus for special study have been also provided in the scientific schools and museums; notably in the biological museum, the Jefferson Physical Laboratory, and the Peabody Museum of Archaeology at Cambridge, and also in the department of hygiene at the University of Pennsylvania. But in most of these, the great complaint is the lack of necessary endowments to make possible the active advanced work in original discovery for which these institutions are designed. In the Peabody Museum there was in 1891 a gift of 10,000 dols. by Mrs. Hays to establish a postgraduate fellowship; and in the University of Illinois, early Mr. Woodruff, for the general support of the natural sciences, New York, 1870, within

a few years past seen spring up almost as by magic, through the efforts of a single leading spirit, seconded by other public-spirited men and women, and by municipal aid, a museum of natural history that bids fair to stand in the front rank of scientific opportunities; but the endowments of fellowships and professors necessary to make its opportunities available in active research are as yet wanting.

England holds a position midway between the United States and Germany. Her scientific men lament her deficiencies. They are striving to increase their means for scientific work, and are doing so yearly.

If experience teaches anything, it is that no broad and general development of scientific work of the first class is possible, except either through independent establishments for special work, or else by the university system, in which professors in science and their assistants are first selected on account of their previous distinction in original research, and are then appointed to continue that work, and in the teaching of students, to transmit to them the zeal of discovery and the true methods of advance.

It matters little whether the support of the university or of special institutions for research comes from the Government or from private endowment, provided the provision is adequate and constant. The difficulty with us has been, and still is, that funds are insufficient, the means and equipment inadequate, and the time allowed to the professors for research insufficient. There has been too much of the schoolmaster, and too little of the real professor. Too great absorption of the professor's time in the work of instruction is injurious to both teacher and pupil. The most stimulating of teachers is he who by daily experiment is in vital touch with nature—he who brings from the fires of the laboratory the warmth, the illumination, and the inspiration of his own researches.

This is now well recognised; and so far as their means will permit, the leading colleges are by degrees relieving their professors of the work of elementary instruction, so that they may the better prosecute original researches, and at the same time become best qualified for the highest work of instruction. This system will doubtless demand watchfulness and discrimination. To prevent abuses, regulation and responsibility may have to be imposed. But it involves the appointment of additional instructors. It requires added means. And this is indispensable as a part of the transition of our leading colleges to the university system. It is indispensable, also, if we are to have in this country any considerable systematic prosecution of original research. We must use existing instrumentalities and existing institutions. And all experience shows that outside of the few Government positions, and in the absence of special institutions for research, the professorial chairs are best adapted to such investigations. No greater service could be done to science than to make such endowments as should insure systematic and continuous research by the professors as a part of the new university system.

Endowments for the same object, and operating in the same line, might also take a different form, *viz.* the endowment of several professorial fellowships, each, say, of 1000 dols. annual income; to be controlled and awarded by some independent scientific body (such as this alliance might afford) for distinction in active scientific investigations, either within the country or within the State. I know of no more quickening impulse to original scientific research than such as would be given to it by those means.

How backward we have been in this country, through the lack of proper endowments, in making use of the best existing opportunities for research, may be illustrated by a single instance. Some twenty years ago a school was established at Naples for the prosecution of marine biological research. It is most thoroughly equipped, and, being a general resort, is the most advantageous for study in the world. It is maintained by a charge of 500 dols. per year upon each table occupied, each occupant being entitled to all the advantages of the institution. Of these tables, the German States for several years have taken thirteen; Italy, eight; Austria, Russia, Spain, and England, each three; Switzerland, Belgium and Holland, each one; the United States, until 1891, none, except one table supported by Williams College for two years, and one by the University of Pennsylvania for one year. Prior to that time about fifteen other American students in all had obtained places at the tables taken and paid for by other nations. In 1890 this arrangement was prohibited by the administration of the institution;

and the right to a table in 1891, was secured to Americans, only through the private benefaction of Major Alex. Henry Davis, of Syracuse. For the year 1892 the use of a table has been secured through a subscription started by the American Association for the Advancement of Science, toward which the Association itself granted out of its scanty funds 100 dol., and was the means, I believe, of procuring the rest.<sup>1</sup>

We have not, however, been wholly without some such means of study in this country through the marine biological laboratories established some years ago at Newport and at Wood's Holl, by Prof. Alex. Agassiz. The former has been now enlarged so as to accommodate eight advanced students, besides the professor and his assistant.<sup>2</sup> The Johns Hopkins University also has supplied some opportunities of this kind by its summer school, formerly at Beaufort; later, at Jamaica; but at present, as I understand, it is without any permanent location.

Our neighbour, the Brooklyn Institute, has organised similar investigations, on a minor scale, during the summer months at different places on Long Island. But what is needed for the most effective work is suitable endowments for professors and advanced students, in connection with an adequate biological laboratory, such as the Newport one enlarged might afford, equal in means and equipment to that at Naples, or at least to that recently completed, largely through private enterprise, at Plymouth, England.<sup>3</sup>

(To be continued.)

### SCIENTIFIC SERIALS.

*Bulletin de l'Académie Royale de Belgique*, Nos. 9 and 10.—On the conversion of black mercuric sulphide into red sulphide, and on the density and specific heat of these bodies, by W. Spring. As a general rule, if a body is capable of existing in two allotropic states with different densities, it is possible to convert the lighter into the heavier kind by compressing it to the higher density, the pressure depending upon its compressibility. Sometimes this conversion is only possible above a certain "critical temperature." In the case of the sulphide of mercury the conversion of the black into the red variety (vermilion) involves a compression of 9 per cent., and would require a pressure of 35,000 atmospheres, which is not at present attainable. But M. Spring has succeeded in obtaining a new form of black HgS which only requires 2500 atmospheres. It is obtained by sublimation of ordinary black HgS in an atmosphere of nitrogen or CO<sub>2</sub>. Its density is 8.0395, while that of vermilion is 8.1587, and of ordinary black HgS 7.6242. A curious side result of the investigation is that the black sulphide hitherto known, after being made to expand by heat and then cooled, takes about a day to return to its original density.—Vapour tension and hygrometric state, by Dr. J. Verschaffelt. A new hygrometer may be based upon the fact that the hygrometric state of the atmosphere may be taken as the ratio of the vapour tension inside a solution to the highest possible vapour tension of water at the same temperature, if the tension inside the solution is equal to that in the atmosphere, *i.e.* when the solution does not evaporate or gather moisture from the air. The ratio mentioned is independent of the temperature, and hence the humidity is simply a function of the concentration of the solution. In practice, Dr. Verschaffelt moistens a weighed piece of blotting-paper with a weighed quantity of a solution of lithium chloride of known concentration, exposes it to the atmosphere, and weighs it again. From the last weight the "equilibrium concentration" may be calculated, and from this the humidity with the aid of Dieterici's data for this salt. The apparatus might be made self-registering.

*Bulletin of the American Mathematical Society*, vol. i, No. 2. (New York, Macmillan, November, 1894.)—On the problem of the minimum sum of the distances of a point from given points, is the translation, by A. Ziwet, of a paper presented to the Society at its summer meeting August 15, by Prof. V. Schlegel (pp. 33-52). This frequently discussed problem (see references given by Sturm, *Crelle's Journal*, vol. 97, is considered by the author to offer room for further treatment. He discusses the best method of investigating the question, and in the end treats it by means of the simplest methods of Grassmann's "Ausdehnungslehre." Prof. Cajori collects a number of authorities in confirmation of a statement in his "History of Mathematics" (p. 218), that it is *not* true that the binomial theorem is engraved on Newton's monument in Westminster Abbey. The latest additional authority for his statement is contained in a letter from the present Dean of Westminster, whom Prof. Cajori calls "Dr. Granville":—The only other matters are the notes and new publications.

### SOCIETIES AND ACADEMIES.

#### CAMBRIDGE.

Philosophical Society, November 26.—Prof. J. J. Thomson, President, in the chair.—On Benham's artificial spectrum, by Prof. G. D. Liveing. Prof. Liveing exhibited one of Benham's "artificial spectrum tops" (see NATURE, November 29, p. 113), and a variety of discs with figures in black disposed on a white ground, and with white figures on a black ground, which, when revolved in a bright light showed remarkable bands of colour of various shades of red, green, and blue. The general result of his observations of these discs was that if a succession of black and white objects were presented to the eye with moderate, but not too great, rapidity, then, when black was followed by white, an impression of a more or less red colour was perceived, while when white was succeeded by black a more or less blue colour was perceived. If the succession of black and white was very rapid the appearance presented to the eye was of a more or less neutral green or drab. The explanation offered by Prof. Liveing was based on the known facts that the impression produced on the retina by a bright object remained for an appreciable time after the light from the object had been cut off, and that the duration of that impression was different for different colours; and on a supposition, which he did not know to have been as yet verified experimentally, that the rapidity with which the eye perceives colours was greater for one end of the spectrum than for the other. From this point of view the explanation of the blue colour seen when white is followed by black would be that the impression of blue on the retina lasts a little longer than that of the other colours; while the red colour seen when white succeeds black is due to the greater rapidity with which the eye perceives red light than that with which it perceives blue. If, however, the alternations of white and black succeed each other with sufficient rapidity, the new impression of a white patch will be produced before that of its predecessor has vanished, and there will be an overlapping of impressions, and the sensation will be that of a mixture of colours, or of a more or less neutral tint. So far as he could test the theory by his own eyes it appeared to him that the residual impression, left when the light from a white object was suddenly cut off, was at first green and faded out through a more or less blue or slate colour.—On a simple test case of Maxwell's law of partition of energy, by Mr. G. H. Bryan.

#### PARIS.

Academy of Sciences, December 3.—M. Lewy in the chair. The reduction of alumina by carbon, by M. Henri Moissan. The author describes the reduction of pure corundum by means of his now well-known electric furnace. Liquid alumina is not reduced by carbon; the reduction only takes place when the vapours of these substances are carried to a very high temperature, metallic aluminium is then produced and partially combines with carbon.—Reply to M. Mayer-Aymar concerning his defence of *Saharien* as a name for the latest geological period, by M. A. Pomel.—A letter from Prof. R. Fresenius was read announcing the formation of a German committee in connection with the Lavoisier monument. The Academy appointed Prof. Fresenius delegate for this work. Prof. G. Hinrichs was similarly appointed delegate for the

<sup>1</sup> See *Proceedings American Association A. S.* 1891, vol. XI, p. 449-451.

<sup>2</sup> *Report Harvard College*, 1893, p. 122.

<sup>3</sup> In his address before the American Association for the Advancement of Science, in 1891, President Prescott, referring to this general subject, said

"To nurture investigation in science is the largest opportunity before the American people. Research, systematic and wisely directed, requires good organisation and strong support, the support of many powers. It must have the support of able and persistent men. It needs the conference of workers, and the dissemination of knowledge in societies like this. It wants the interest and the confidence of the public. It asks and will always obtain the constant, helpful use of the press. It requires distinct provision in colleges, and in the institutions of higher education. It ought to be sustained expressly by the Government, both in the several States and under the United States, and sustained on broad and permanent foundations. Still, it needs private benefactions. Research is the growth of years. Let it be the demand of all, and let this call find utterance everywhere."—*Proceedings American Association*, 1891, vol. XI, p. 440.

United States.—On the identity of the new comet with De Vico's comet, by M. L. Schulhof (see our Astronomical Column, December 6, p. 132).—Observations of the planet B II 1894, discovered by M. Borrelly at Marseilles Observatory, November 10, 1894; by M. Borrelly.—On the distribution of planets between Mars and Jupiter, by M. E. Roger. A mathematical paper in continuation of a paper on the same subject in the previous number.—On quasi-alternate permutations, by M. Désiré André.—On the temperature of the electric arc, by M. J. Violle. The conclusion is drawn, from a spectroscopic study of the poles and the arc itself, that the temperature of the arc is generally higher than that of the positive carbon, and that it increases with the electric energy employed.—On the solubility of ozone, by M. l'Abbe Maillert. At a pressure of 75 mm. water dissolves two-thirds of its volume of ozone at 0° C., at 12° about one-half. The solubility of ozone in water acidified with sulphuric acid is the same as its solubility in pure water up to about 20° C.; more ozone is dissolved by the acid solution above this temperature. The suggestion is made that ozonised water might be employed as a disinfectant and antiseptic.—On the superposition of the optical effects of different asymmetric carbon atoms in the same active molecule, by MM. Ph. A. Guye and M. Gautier. For the determination of this point the authors have used in the present instance amyl valerate. The ester produced by combining inactive amyl alcohol with active valeric acid gives  $[\alpha]_D = +1.08$ , the corresponding compound with active amyl alcohol and inactive valeric acid gives  $[\alpha]_D = -4.26$ ; the ester obtained from active alcohol and active acid gives  $[\alpha]_D = -5.32$ , while the sum of the two former is  $-5.34$ . Theoretically a better agreement should be obtained by using the racemic in place of the inactive forms; in this case the sum is  $5.62$ . The difference is probably due merely to experimental errors.—Experimental researches on the crystallisation point of some organic substances, by M. Raoul Pietet. The crystallisation points of a number of organic substances are given, and the results are embodied in a number of general conclusions confirming previous work.—On the emission of a saccharine liquid by the green parts of the orange-tree, by Dr. M. Busgen. The author calls attention to the part played by aphides and similar parasites in the production of saccharine liquids from plants, and includes the orange-tree among the cases of this kind.—Osteomyelitis of the inferior maxillary in the kangaroo, by MM. Lannelongue and Achard.—On the action of the toxine from the pyrogenous Staphylococcus on the rabbit, and on the secondary infections which it determines, by MM. Mosny and G. Marcano. The toxine does not confer immunity against the attacks of the living microbe. Action of high pressures on some bacteria, by M. H. Roger. Notable differences were observed between different bacteria in regard to their behaviour under pressure. The virulence of the anthrax bacillus was very much diminished by a pressure of 3000 kgs.—On the disinfection of fecal matter, by M. H. Vincent. At about 16° C. the disinfection of normal fecal substances is brought about in twenty-four hours by 6 kgs. of copper sulphate per cubic metre. Lberth's bacillus is destroyed in typhoidal refuse by 5 kgs. per cubic metre, and the cholera bacillus by 3.5 kgs. of copper sulphate per cubic metre after twelve hours contact.—Marine muds and their classification, by M. J. Thoulet.

BERLIN.

Physical Society, November 2.—Prof. du Bois Reymond, President, in the chair.—The President alluded to the death of Prof. Pringheim, and drew attention to his important researches on the fertilisation of algae. Dr. C. H. Wind gave a comprehensive review of the researches carried on by Dutch observers with reference to Kerr's phenomenon. He then discussed Lorentz's theory, and described the elaborate experiments made by Sissingh and Zeeman and by himself, which had yielded results for iron, nickel, and cobalt, which were not quite in accord with the theory. Since the other theories as to this phenomenon, as, for instance, that of Drude, are still less in accord with experimental facts, the speaker had extended Lorentz's theory so as to take into account the results obtained by Sissingh and Zeeman, and to bring the phenomenon of Kerr into relation with that of Hall. This extension of the theory had been accepted by Lorentz, and Dr. Wind is now engaged on the investigation of certain phases of Hall's phenomenon.

BOOKS, PAMPHLETS, and SERIALS RECEIVED.

Books.—In the Guiana Forest: J. Rodway (Unwin).—The Electropater's Handbook: G. E. Bonney, 2nd edition (Whittaker).—Lehrbuch der Botanik für Hochschulen: Drs. Strasburger, Noll, Schenck, and Schimper (Jena, Fischer).—Lehrbuch der Zoologie: Dr. R. Hertwig, Dritte Auflage (Jena, Fischer).—Climbing in the Himalayas: Maps and Scientific Reports: W. M. Conway (Unwin).—Ortica: Prof. E. Gelechi (Milano, Hoepli).—The Dynamics of Life: Dr. W. R. Gowers (Churchill).—The Planet Earth: R. A. Gregory (Macmillan).—Britain's Naval Power: H. Williams (Macmillan).—The Warwick Shakespeare. "As you like it," edited by J. C. Smith (Blackie).—The Teacher's Manual of Lessons in Elementary Science: H. Major (Blackie).—Handbuch der Stereochemie: Drs. Walden and Bischoff, II. Band (Frankfurt a. M., Bechhold).—Forty-three Graphic Tables or Diagrams for the Conversion of Measurements in Different Units: Prof. R. H. Smith (Griffin).—Torpilles Sèches: E. Hennebert (Paris, Gauthier-Villars).  
PAMPHLET.—Gehirn und Seele: Prof. A. Forel (Bonn, Straus).  
SERIALS.—Observer, December (Taylor and Francis).—Companion to Observatory (Taylor and Francis).—Himmel und Erde, December (Berlin, Paetel).—Geographical Journal, December (Stanford).—Natural History of Plants: Kerner and Oliver, Part 8 (Blackie).—Tide Annual (Cassell).—Science Progress, December (Scientific Press).

CONTENTS.

PAGE

Dilettantism and Statistics. By Prof. Karl Pearson	145
Water Supply and Water-works	146
Hamilton's Pathology	148
Our Book Shelf:—	
Fox: "The Mechanism of Weaving"	149
Atkinson: "Memorials of Old Whitby"	149
Haacke: "Die Schöpfung der Tierwelt"	149
Hutton: "The Vaccination Question,"	149
Glaister: "Dr. William Smellie and his Contemporaries"	149
Letters to the Editor:—	
Dr. Watt's Dictionary of the Economic Products of India.—W. T. Thiselton-Dyer, C.M.G., F.R.S.; Dr. V. Ball, F.R.S.	150
Drift-Bottles in the Irish Sea.—Prof. W. A. Herdman, F.R.S.	151
The Explosion of Gases in Glass Vessels.—Prof. H. B. Dixon, F.R.S.	151
The Kinetic Theory of Gases.—G. H. Bryan; Dr. J. Larmor, F.R.S.	152
Peculiarities of Psychical Research.—Prof. Karl Pearson	153
Chronometer Trials.—William E. Plummer	153
Indo-Malayan Spiders.—B. A. Muirhead	153
Death-feigning in Snakes.—Gerard W. Butler	153
The Alleged Absoluteness of Motions of Rotation.—A. E. H. Love, F.R.S.	153
Gravitation.—Prof. Oliver J. Lodge, F.R.S.	154
Outlines of Quaternions.—Lieut. Colonel H. W. L. Hime	154
The Warble Fly. (Illustrated.) By W. F. Kirby	154
Ferdinand de Lesseps	155
Notes (Illustrated)	156
Our Astronomical Column:—	
Motion and Magnitude	160
The Recent Transit of Mercury	160
The New Achromatic Object-glass. (Illustrated.)	160
Ephemeris for Swift's Comet	160
A New Star?	161
Prof. Victor Meyer's New Method of Determining High Melting Points. By A. E. Tutton	161
Science in the Magazines	161
Oyster Culture on the West Coast of France. By Prof. W. A. Herdman, F.R.S.	162
Endowment for Scientific Research and Publication. I.	164
Scientific Serials	167
Societies and Academies	167
Books, Pamphlets, and Serials Received	168

THURSDAY, DECEMBER 20, 1894.

## SIR RICHARD OWEN.

*The Life of Richard Owen.* By his grandson, the Rev. Richard Owen, M.A. With the scientific portions revised by C. Davies Sherborn. Also an Essay on Owen's Position in Anatomical Science, by the Right Hon. T. H. Huxley, F.R.S. (London: John Murray, 1894.)

THE life of this well-known and eminent anatomist, written by his grandson, the Rev. Richard Owen, has been based on such a large amount of material that "the writer's chief difficulty has been to compress the biography within reasonable limits." While acknowledging that the art of compression is a difficult one, we still must express some disappointment at the way in which it has been carried out in the two volumes of this biography. For over sixty years Owen filled a more or less conspicuous place in the scientific world; in a large measure a self-taught anatomist, he at a very early age became a teacher of anatomy to others, with a wondrous collection of material at his disposal to illustrate his teaching. In these volumes we do not seem to find enough about his evolution as a man of science, and we could, in some measure, have dispensed with many of the trifling details of his every-day life, which have, if any, but a passing interest. In the following sketch we attempt to show but a phase of Owen's character; but, in common with all who had any personal knowledge of him, we do not overlook, nor can we forget, the charm of his domestic and cultured life.

Richard Owen was the younger son of Richard Owen, of Fulmer Place, Bucks; he was born at Lancaster on July 20, 1804. His mother was of a Huguenot family of the name of Parrin, who came from Provence at the time of the revocation of the Edict of Nantes. He would seem to have inherited from his father many of his physical characters, his height and sturdy frame; while from his mother came his fondness for music, and a certain refinement and courtier-like style of manner which were of some value to him in after-life. Apparently his mental training began early, for we find his father writing from St. Kitt's to his mother, "that he was glad to know James (the elder brother) and Richard came on so well with their studies, and were so attentive," at a date when Richard could not have been more than three years and a half old. When six years old he was sent to the Lancaster Grammar School, to join his elder brother, a school that will be always associated with the name of Whewell, the great Master of Trinity, Cambridge, who received here his early education. Soon after he had left school, we find him apprenticed to Mr. Leonard Dickson, of Lancaster, surgeon and apothecary, and on his death, in 1822, he was transferred to Surgeon Seed, of the Royal Navy; and finally, on Mr. Seed being called upon by the Service, he was committed to the care of Mr. J. S. Harrison. Matriculating at Edinburgh University in October, 1824, he seems to have attended one winter, and possibly a summer, course of lectures. In 1825 he was in London, attending lectures at St. Bartholomew's Hospital School, and became pro-

sector for Dr. Abernethy. On August 18, 1826, he was admitted a member of the Royal College of Surgeons, London.

To the medical student of the present day, compelled to attend a five years' course of lectures and demonstrations, and to pass several examinations, there will seem something enviable in the apparent ease with which Richard Owen obtained his qualification; there was an incomplete apprenticeship at Lancaster, perhaps a year's course of lectures at Edinburgh, and another year, about which we have few details, at St. Bartholomew's, and then he set up as a medical practitioner, and gradually secured a small practice among the lawyers at Lincoln's Inn Fields. To those, however, who try to read under the lines, it will be evident that the abilities and industry of Owen, about which his mother so proudly writes, must have been of no common order. Up in that old tower at Lancaster—"Hadrian's Tower, it was called"—after the first spasm of fright, the particulars of which are so graphically told us by the Professor himself, the youth of sixteen must have carried on his anatomical investigations to such a purpose that we find him, on his visit to Edinburgh, not only able to detect the defects of the teaching of anatomy of Prof. Monro (*tertius*), but able also to attract the notice of John Barclay, and finally, on his visit to London, able to act as prosector to Abernethy. We would have welcomed more information as to how Owen became an anatomist. Was his worthy master at Lancaster, who could learnedly descant on certain pathological conditions, an anatomist, or did the "elder fellow pupil" about whom he writes (who was he?) help him in his studies? Probably we will never know, and yet a knowledge of his doings during these few early years of study would have helped us to an understanding of the man.

In 1827, through the influence of Abernethy, who at the time was President of the College of Surgeons, Owen was appointed Assistant Curator of the College Museum, under William Clift, and he at once proceeded to arrange the collections and to write the descriptive catalogues, the first three parts of which were published in the course of 1830. Before the end of 1827 he was engaged to be married to Miss Clift, and after an eight years' courtship they were married in 1835. William Home Clift had died from an accident in September 1832, and Owen's place at the College then became a permanent one. In 1836 he was appointed Hunterian Professor, and on the retirement of Sir Charles Bell (in the early part of 1837) from the Professorship of Anatomy and Physiology in the College, Owen was elected to the vacant chair. For these latter statements we follow the text before us; but is it not possible that there is some slight confusion here? Up to about the period when Sir Charles Bell resigned the Professorship of Anatomy, the lectures bearing on the Hunterian collections were supposed to have been given in part by the Professor of Anatomy and in part by the Professor of Surgery; but, by a special arrangement, these lectures, twenty-four in number, were, after 1837, to be delivered by Owen, as Hunterian Professor, and "the awful first lecture" was given on May 2, 1837.

For the next twenty years of Owen's life the scene was for the most part laid in Lincoln's Inn Fields.

"Mr. Owen was put up on our door-plate to-day. Looks most imposing," records Mrs. Owen, under the date of July 22, 1836, and it was in June 1835 that he entered upon his duties as Superintendent of the Natural History Department of the British Museum. These twenty years were, perhaps, the fullest of Owen's life. The boy who had begun his anatomical studies in Lancaster at sixteen years of age, was, some sixteen years afterwards Hunterian Professor, lecturing before brilliant audiences of grown-up men, and with material to lecture about such as has seldom fallen to the lot of any other man. Numerous were the works published during these years, and numerous were the honours conferred on him. Fully detailed lists of both, occupying many pages, will be found at the close of volume ii. The time was not all spent in tiresome work: Owen's social qualities were of a well developed order. We are permitted, by his wife's records of their daily lives, to know of days and evenings spent in gay and festive scenes.

In chapter ix. we have a fuller account than, we think, has to this been published about the daring thoughts that were at one time in Owen's mind (1846) about the zoological collections of the British Museum. He calls them "speculations on a concentration of all zoological illustrations—living, dead, exterior, and anatomical—in one great connected establishment"; but, failing such a realisation, he would be satisfied if "all the recent and fossil zoology of the British Museum would come to this College of Surgeons. The mineralogy would naturally be transferred to the Government Museum of Economic Geology," and "the British Museum would then be left free for the full extension of the departments which concern intellectual man." The last sentence was unfortunately expressed; and within ten years, Owen's ideas—possibly affected by lapse of time and change of scene—had vastly changed. He thought, in 1846, Lincoln's Inn Fields as central a position as Great Russell Street; afterwards, in 1856, though he liked the position in Great Russell Street well, yet for the sake of space he went out into the country. Perhaps, in taking note of this episode, we ought also mention that in 1848 he strongly urged on his friend, Dean Buckland, the importance of the great collection of shells, made by Hugh Canning, being purchased for the British Museum.

At the close of the first volume there is an interesting letter, dated July 17, 1854, from Charles Darwin, which we do not remember to have seen before. He thanks Owen for his kind appreciation of his work on the *Cirripedia*. "I am so frightened at the thoughts of all the seaside specimens that I have not illustrated and given in detail nearly enough my anatomical work, which is the only part of the work which has really interested me. I find the mere systematic part a hateful tedious. I can, however, honestly state that all I have said on the modes of life and Scalpellum is the result of the most careful and repeated observation. If I am ever proved wrong in it I shall be surprised."

On May 26, 1856, Owen was appointed Superintendent of the Natural History Department of the British Museum, and he entered on his duties on June 8 following. We presume that he resigned his position at the College of Surgeons at the end of May, as the letter of

the Secretary of the College, forwarding the regrets of the Council, is dated June 12, 1856. Lord Macaulay's letter to the Marquis of Lansdowne, urging that the post should be made for Owen, was written in February 1856; so that the one scene of labour was exchanged for the other almost with the rapidity of a transformation scene, and before the end of June, Owen was examining the "two collections of Mr. Hawkins—those of Dr. Mantell and Mr. Koch"—in the British Museum, which in 1846 he had believed to be so much out of place there. For the next twenty-seven years the interests of the wonderful collection were always very dear to him, and no difficulties, no rebuffs, stopped him from carrying out his plans about them to their uttermost.

Chapter ii. of vol. ii. is devoted to the history of Owen's connection with the British Museum of Natural History at South Kensington. This account "is given as nearly as possible in his own words, the substance being taken from his address to the British Association at York in 1881." It would have been well if this chapter had been revised by some one with a personal knowledge of the state of things existing in the Natural History Department of the British Museum prior to Owen's appointment, or, failing this, of some one up to the traditions of the place; for though, undeniably, space was sadly wanted for the proper display of the specimens, this department, as a department, was scarcely "the most neglected branch of the institution," nor could the condition of affairs be described as "chaos." However, in February 1859, Owen submitted his views in a report to the Trustees, asking for space to display the existing specimens and those that might be expected to come for a generation. Organised and crystallised forms, all were to be now included. This report, with plans, was presented to Parliament by the Trustees; the space demanded required the removal of the collections from Bloomsbury, the time had not come for so great a change, and Mr. Gregory, afterwards Sir William Gregory, here referred to as an "Irish Member," asked for a Committee of Inquiry, which, after a pretty vigorous debate on July 22, 1861, was granted. In May 1862 there was a second stormy debate in the House of Commons, led by Lord Beaconsfield, and the Government were refused leave, by a large majority, to bring in a Bill for the removal of portions of the Trustees' collections in the British Museum. Things, however, changed in 1863; Sir William Gregory had been made Governor of Ceylon (it is difficult to see what effect this could have had on the matter), and in June of that year leave was obtained by a majority of 132 to purchase five acres for the required Natural History building. Between 1880 and 1883 Owen was engaged in superintending the removal of the specimens from Bloomsbury to South Kensington, and at the close of the latter year he retired from his post, the realisation of his idea being attained.

When Owen gave up the charge of the Museum of the College of Surgeons, he also surrendered the Hunterian Chair; he was thus enabled to accept the Lectureship on Palæontology at the Royal School of Mines, in 1857. He gave his first lecture on February 26, concluding the course on April 2. Mrs. Owen notes in her diary, Richard's "design has been clear throughout in these lectures—to show the power of God in his creation." Towards the end of



the same year he was appointed Fullerman Professor of Physiology at the Royal Institution, so that there was no relaxation in lecturing work during these years. Owen was President of the British Association at its meeting at Leeds in 1857. We also get a glimpse of him at Aberdeen in 1859, but can find no trace in these volumes of his presence at the Oxford or Cambridge meetings of 1860 and 1862; indeed, even when noticing the publication of the memoir on the Aye-Aye in 1863, no reference is made to the remarkable paper read at the Cambridge meeting on the characters of this mammal as a test of the Lamarckian and Darwinian hypotheses of the transmutation and origin of species, nor is there any allusion to the "two pitched battles about the origin of species at Oxford," nor to Charles Kingsley's well-meant little squib, published during the Cambridge meeting by Macmillan and Co., "On the great Hippocampus Question."

Mrs. Owen, after a married life of nearly forty years, died in May 1873. In 1875 Owen refers to his daily task work becoming tiresome, as well it might to a man past seventy, but several important memoirs were published by him between this year and 1885, and in 1881 he delivered a long address to the Biological Section of the British Association at York, on the new Natural History Museum; this was almost his last public address, and it was delivered with a force and power that reminded his hearers of his early days. On January 5, 1884, Owen was, on his retirement from the post of Superintendent of the British Museum, gazetted a K.C.B. He was present at a meeting of the Linnean Society, at Burlington House, in May 1888, "to receive a gold medal." The medal thus alluded to was one of two struck in commemoration of the centenary of the Linnean Society; one medal was to be given to a botanist, and one to a zoologist. The botanist on this occasion was Sir Joseph Dalton Hooker. Up to the close of 1889 he was occasionally seen at the Athenæum. Early in 1890 he had a slight paralytic seizure, from which he never entirely recovered. In his well-known library, when able to be out of bed, he would sometimes sit for hours looking out wistfully at the view over the park, and on the morning of December 16, 1892, the end quite peacefully came.

As to Owen's position as a writer on anatomical science, we have no occasion to enter, for what we conceive to be by far the most interesting portion of these two volumes is a criticism, in the true sense of this word, thereof so straightforward, searching, and honest as to leave nothing further to be desired. We should like to have transferred the greater part of this analysis by Prof. Huxley of the work done by Owen to our pages. He doubts "if in the long annals of anatomy more is to be placed to the credit of any single worker" than to Owen, and his is "work some of which occupies a unique position, if one considers, not merely its general high standard of excellence, but the way in which so many of the memoirs have opened up new regions of investigation."

As to the judgment passed on the speculative side of Owen's work, will not all now deplore that so much tireless industry, great capacity, and extensive learning were spent on themes profiting so little as the archetype of the vertebrate skeleton and the nature of limbs? Perhaps it may seem to some that Prof. Huxley has

devoted too much space to Owen's speculative writings, but, as he says:

"Obvious as are the merits of Owen's anatomical and palæontological work to every expert, it is necessary to be an expert to discern them; and endless pages of analysis of his memoirs would not have made the general reader any wiser than he was at first. On the other hand, the nature of the broad problems of the 'Archetype' and of 'Parthenogenesis' may easily be stated in such a way as to be generally intelligible; while from Goethe to Zola, poets and novelists have made them interesting to the public. I have therefore permitted myself to dwell upon these topics at some length; but the reader must bear in mind that whatever view is taken of Sir Richard Owen's speculations on these subjects, his claims to a high place among those who have made great and permanently valuable contributions to knowledge remain unassailable."

Several interesting portraits of Owen, taken at different periods of his life, form part of the illustrations of these volumes. There are also sketches of the Gateway, Lancaster Castle, and of Sheen Lodge, in Richmond Park.

#### ELECTROMAGNETIC THEORY.

*Electromagnetic Theory.* By Oliver Heaviside. F.R.S. Vol. I. (London: The Electrician Printing and Publishing Company, Limited, 1893.)

THE basis of Mr. Heaviside's treatise is the interlinked magnetic and electric circuits. This is taken from Maxwell, but it is much more fully developed, and the analogy between the electric and magnetic circuits is followed out with great care, and is insisted upon at every turn. That you can have a conductor charged electrically, while you cannot have a single magnetic pole, destroys the perfection of the analogy but little. There is a more serious hiatus in the absence of the magnetic analogue to an electric conductor. Mr. Heaviside, however, completes the analogy by imagining such things as magnetic conductors and magnetic currents. The magnetic displacement and convection currents of course exist, but magnetic conduction current, with its corresponding magnetic conductivity, is a most useful notion. The ideas of the magnetic current must not be confused with the unscientific notions of magnetomotive force and magnetic resistance, which are supposed to bring electromagnetism within the intellectual reach of the benighted practical man. At first Mr. Heaviside uses the hypothetical magnetic current as a means of giving his readers a thorough grasp of the interlinked circuits, and of completing the analogy between them. Later, however, in dealing with submarine messages, he shows that magnetic conductivity outside the wires, which is easy to treat mathematically, would have the same effect on the messages as electric resistance in the cable itself, which would be more difficult.

As Mr. Heaviside's first volume has been already reviewed in the *Electrician* and *Philosophical Magazine* by Profs. Fitzgerald and Minchin, and as the work is so full and so suggestive that a review might be longer than the book, this notice will deal mainly with matters not already fully discussed, though of course there will be some overlapping.

It is almost needless to say that Mr. Heaviside does not believe in action at a distance, that he regards energy as being continuous in space, and as moving as matter, and that he treats ether as an entity, and not as a working hypothesis. By the way, in discussing ether, as to whether it is stationary or not, stationary is generally taken to mean relatively to the earth which is honoured with our existence, or at least with regard to the sun which is to give us light. But if motion is considered with reference to infinite distances, the chances are that the ether moves past us at a speed in comparison with which  $v$  is infinitesimal. Mr. Heaviside hopes that in the future the young will be trained up to believe in ether as a thing, and will therefore believe in it; but this would be a sort of religion rather than knowledge. No one doubts that electrical disturbances are propagated at a finite speed, and matter, with its inconvenient properties removed or altered, provides a convenient working hypothesis; but to talk of the inconceivable as existing, is using words to which no concepts belong. As most people agree with Mr. Heaviside on these matters, however, it may be as well to say no more in a review. Dealing with the medium, or rather its states, Mr. Heaviside gets rid of the potential treatment. To him induction and its change is of primary importance, and potential is a mere derivative of it. The idea of induction as the essential and potential as derived is less common with the academical than the practical electrician who also uses the notion of lines of induction.

This treatise is remarkable, among other things, in beginning almost at once with the propagation of disturbances at the speed of light. The author hopes that text-books on light will soon discuss electricity at the beginning instead of at the end. He certainly sets a good example by beginning a book on electromagnetism with the propagation of disturbances in time. By the way, he regards chemistry as an unmathematical science; it is to be hoped chemistry books will soon begin with thermodynamics and electricity, so as to lay an engineering foundation for the study of chemical action.

Mr. Heaviside is, as is well known, a determined opponent of the use of quaternions in physics, and an equally strong advocate of the use of vectors; and a long chapter is devoted to the "Elements of Vectorial Analysis," taking more than a third of the book. In quaternions, vector products have a part at right angles to both the vectors; the ideas thus fitted electromagnetism, and Maxwell availed himself of the conveniences of quaternion notation, and, to some extent, of quaternion ideas. The relations between vectors in quaternions are purely conventional, while in electricity they are physical in one sense, though in another they may be due to conventionalities of definition. The idea of the direction of a current flowing along in a wire was derived from the flow of water in a pipe, and it is possible that we might have so defined electrical and magnetic quantities, and so thought of them, that nothing corresponding to vector products or quotients came in when passing from one to the other of the electric and magnetic systems. Mr. Heaviside objects altogether to quaternions in physics, but does not differentiate clearly between vector and

quaternion analysis, and professes that he does not or cannot understand quaternions. It is not likely he cannot. Perhaps he won't. One difficulty, in the way of students at least, is due to writers on quaternions defining something that is not adding as addition, and something that is not multiplying as multiplication, and to their removing the operand and treating the operator as a quantity. This leads to  $Sa\beta$  being negative, to the square of a vector being negative, and to the reciprocal of a vector being taken in the opposite direction. When an eminent scientific writer recently found, by dividing the value of  $dy/dx$  by  $y$  that  $d/dx$  was equal to  $628$ , some wrongly thought he did not understand the principles of the calculus; but he was only doing in figures what is done in letters in many branches of mathematics. Mr. Heaviside starts off with a definition of the "product" of two vectors. The scalar part is positive, and the vector part is as in quaternions, but there is no idea of the multiplier rotating the multiplicand, though he gives no reason why the multiplicand need not be looked upon as turned through a right angle. It may be asked how Mr. Heaviside avoids quaternions. Using the word in one of its many senses as the operator necessary to change a vector into another, he avoids the difficulty, for the present, by not dividing. Surely if vectors are to be multiplied they must also be divided. If we have the induction and current at an angle, we can find the force; is it not as reasonable to find the induction or current if the force and one of them is given? Perhaps Mr. Heaviside may devise a new quotient or operator which will do this. If  $a\beta = \gamma$  we might expect that  $\gamma\beta = a$ . This is not so in quaternions, because the scalar part of  $a\beta$  is lost, and the quaternion  $\gamma\beta$  gives no scalar part. To recover  $a$  there might be a term  $Sa\beta\beta$ . Perhaps Mr. Heaviside will give his own ideas about division in his next volume. Meanwhile, though he avoids the ideas of turning, every vector multiplier is just as much a quaternion as any in Hamilton or Tait, as far as the versor is concerned. A quaternion, though sometimes called an operator, is really two operators. Mr. Heaviside admits quaternions can be developed from his definitions. He also finds it difficult to think of energy disappearing in one place and appearing elsewhere without passing through intermediate space; surely then he can look upon a vector disappearing and reappearing in a new direction, and of a new length, as having passed through intermediate positions and lengths. He then gets the idea of roots of quaternions,  $\sqrt{-1}$ , and so on, without complicating vector analysis, and has a system which will do all his vector algebra well, which makes sense of imaginaries and exponential values of sines and cosines, which does not involve the study of new symbols or ideas, and which is already worked out; in short, quaternions. He finds difficulty in knowing when a vector is a vector, and when a quaternion. The answer is: it is a vector when it is a quantity, and the versor of a quaternion when it is an operator. There would be no difficulty if people did not confuse an operator with the quantity that specifies it. Confusion, which is common to Mr. Heaviside's vector algebra, may come in between the scalar and vector part of the product of two vectors. He continually falls back

on cartesians, and his vector work is apt to degenerate into cartesian shorthand. The object of a calculus is not to save printing, and it is no advantage to have an expression condensed into two or three symbols if you have to think it out at length to understand it. Shorthand is not necessarily short-thought, especially if it also involves writing operators as quantities. It is possible to know the meaning of

$$\left( \mu\rho - \frac{\nabla^2}{c^2} \right) \Pi \text{ where } \frac{1}{\rho} \text{ is } \frac{dt}{d},$$

it is also possible to know what is meant by "Boyle was the father of chemistry, and brother to the Earl of Cork." It might be suggested that if Mr. Heaviside wants to make either vector analysis or quaternions simple to physicists, he should avoid the confusion between operators and quantities, and between operation generally and multiplication in particular; or else write an introductory calculus of functions showing where such liberties can be taken with impunity.

Mr. Heaviside has a rooted aversion to  $4\pi$ . This factor came into the system of units from statics, as the mathematical treatment of electricity was much the same. Mr. Heaviside employs a medium treatment, and thinks that  $4\pi$  should, therefore, disappear. He thinks that Maxwell and other mathematicians did not know how  $4\pi$  came about, and thought it was a physical necessity. With his treatment it is an advantage to remove the  $4\pi$  from its usual place: but it only appears in the denominator elsewhere. It is like the eruption due to a disease: suppress it, and it appears elsewhere. The unsavoury metaphor is not ours. The disease is the area of a unit sphere being  $4\pi$ . Until Mr. Heaviside can cure that, he cannot really eliminate  $4\pi$ . He whitewashes  $4\pi$  whenever it appears in his book, saying that it is not the B.A.  $4\pi$  of amazing irrationality. When a man refers to his own ideas as alone rational, or based on common-sense, or well-known facts, he is generally wrong.

Mr. Heaviside is, as is well known, a prolific inventor of new terms. He says he hates grammar; he has also a murderous hatred of the Queen's English when inventing terms such as "leakance," "reactance," and "potted." Generally speaking, a writer has no business to insist that his reader shall study a new terminology; but when any one of Mr. Heaviside's reputation invents names which are euphonious and good, they become parts of our language, and we must thank him, especially when his terms are suggestive and systematic. The example is bad though. The English language is capable of improvement; but if every writer is to alter it to suit his ideas, it will not improve. It is a matter of taste which terms should be adopted: many object to voltage and gausage as unsystematic where ampereage, farradage, &c., are not used. Voltage was originally used to denote the pressure for which lamps, dynamos, &c., were designed by the maker, whatever they were run at. Pressure belongs to the same set of ideas as current, capacity, resistance, and quantity; and if they are used, should also be employed. It is, however, a matter of taste only.

The style is that of Whitman, except that Mr. Heaviside is not affected, and has something to say. The similarity is also noted in the *Philosophical Magazine*. Every line of the book is important, and it is full of interesting digressions on all sorts of subjects. Though the converse may not be true, all clever men have a sense of humour, and it is therefore a pity that scientific writers emulate the ponderous dryness of the theologian. Mr. Heaviside's work bristles with humour of a type which he has invented.

It is generally assumed that a review should be written by a man who could have written the book himself. In the case of a writer of Mr. Heaviside's calibre there is difficulty in getting such reviewers. The real object of a book is, however, to teach not those who know the contents already, but the student, and it may therefore be an advantage to review a book from the student's point of view. This review must, therefore, be taken as from that point of view; that is, as written by a reader who has not devoted a large enough portion of his time to the study of mathematics or mathematical physics to be more than a student of them.

J. SWINBURNE.

#### RECENT PSYCHOLOGY.

*Lectures on Human and Animal Psychology.* By Wilhelm Wundt. Translated by J. E. Creighton and E. B. Titchener. Pp. x. 454. (London: Swan Sonnenschein and Co., 1894)

*Grundriss der Psychologie.* Von Oswald Kulpe. Pp. viii. 473. (Leipzig: W. Engelmann, 1893.)

*Introduction to Comparative Psychology.* By C. Lloyd Morgan. Pp. xiv. 382. (London: Walter Scott, 1894.)

*Psychology for Teachers.* By C. Lloyd Morgan. Pp. x. 251. (London: Edward Arnold, 1894)

*Primer of Psychology.* By George Trumbull Ladd. Pp. xv. 224. London: Longmans, Green, and Co., 1894.)

THE translation of Prof. Wundt's well-known lectures is taken from the second revised German edition which appeared in 1892, and is therefore well up to date. It is the first work of the author to appear in English, and the choice made by the translators is a good one: while the book will give to those specially interested in psychology a general sketch of the author's views. Its popular and lucid form will appeal to a wider circle of readers who would hardly care to digest the details and technicalities of the "Grundzuge der physiologischen Psychologie."

The greater part of the book is devoted to human Psychology, especially in its physiological and experimental aspects, and there are several interesting chapters on animal psychology, and a short account of the author's views on hypnotic conditions. Prof. Wundt's own opinions are stated rather more dogmatically than is altogether suitable for an elementary book in a science like psychology; thus, in dealing with intensity of sensation, the validity of the logarithmic formula is very positively enunciated, and it is somewhat surprising to find

on p. 309, that indirect association of ideas is "easily demonstrated," when several investigators, one recently in Prof. Wundt's own laboratory, have failed to find any evidence of such a mode of association.

The translation has been very well done, and especial care has evidently been devoted to the rendering of the German psychological terms. The translators have very freely used the term "to sense" as a verb corresponding to sensation, and as the equivalent of "empfinden." This American innovation, which has already been advocated by Dr. Titchener, is also used by Prof. Lloyd Morgan in his two books, and it must be acknowledged that there is decided need of some such term.

Dr. Kulpe is chief assistant to Prof. Wundt at the Leipzig Institute, and his experience in teaching and in directing investigation must have contributed largely to make his book what it is—one of the best existing expositions of experimental psychology. The general teaching follows that of Wundt, but there is much that is novel in matter and arrangement. Physiological details and the technique of experimental methods are omitted or treated very briefly, but the principles of the methods are fully discussed. Dr. Kulpe's book will probably be largely used as a text-book for advanced students.

Prof. Lloyd Morgan's two books, to a certain extent, cover the same ground. Each is an exposition of general psychological principles to serve as guides, in the one case, to the scientific study of the animal mind; in the other, to the practical study of the child's mind. Both books are characterised by the sound common sense with which the author treats his problems.

The views held on the nature of the animal mind are very similar to those of Wundt. Both agree that in studying animal psychology the scientific method is to explain actions by the simplest possible mental processes, and this method has led both to similar conclusions, though expressed in somewhat different language. Wundt refers all intelligent acts of animals to simple sensations, to the exclusion of any higher apperceptive processes; while Prof. Morgan explains such acts by simple sense-experience, and doubts, though he does not deny, the existence of any true reasoning or reflective process. A point largely insisted on by Prof. Morgan is that observation of an apparently rational action in an animal is of little use without knowledge of the process by which the action has been developed: "in zoological psychology we have got beyond the anecdotal stage; we have reached the stage of experimental investigation."

The book for teachers is very interesting, and contains much that should be of practical value. It is noteworthy that the apperceptive preface, with its ample recognition of the part that a knowledge of psychology should take in the equipment of the teacher, is written by Dr. Fitch, late one of H.M. Chief Inspectors of Training Colleges.

Prof. Ladd has attempted a very difficult task in writing a primer of psychology suited for the young. His book is often simple and clear; it is to be feared, however, that youthful readers will find much of it beyond their capacity. The author does, at any rate, avoid the fault of being too dogmatic.

### OUR BOOK SHELF.

*Radiant Suns.* By Agnes Giberne. (London: Seeley and Co., 1895.)

IN this sequel to a former work, the reader is taken by easy stages into the domain of spectroscopic astronomy and the evolution of worlds. Though following some astronomers who ought to know better, the authoress takes the unphilosophical view that the whole process of stellar evolution is one of cooling; and this is the more difficult to understand, as she is evidently not unfamiliar with the fact that a condensing body may actually be getting hotter (p. 307). While strongly advocating the value of hypotheses as aids to investigation, she is inconsistent enough to make contemptuous reference to the "half-fledged" theories of "scientists of a lower order" (p. 240); her qualifications for making such distinctions are not very clear to us, but her opinions seem to depend to some extent on personal bias, since special prominence is given to the views and work of one observer.

A preface is contributed by Mrs. Huggins, who is careful to disclaim responsibility in matters of opinion, and laments that the masses of men overlook the fact that "the investigator, absorbed in pursuits far removed from those of ordinary life, is also a toiling worker, and a worker of the highest order."

The illustrations are admirable and quite up to date. It would be worth while, however, to revise the coloured plate of stellar spectra, so that the spectrum of Vega would not be robbed of its strongest characteristic—the lines of hydrogen.

We believe that the book will succeed in awakening a desire for further knowledge in the minds of thoughtful readers; and it so, it will serve a useful purpose.

*Album on Papua-Tyfa.* Von A. B. Meyer and R. Parkinson. (Dresden: Stengel und Markert, 1894.)

TO ethnologists, the Papuan race is one of the most interesting in the world. Whether the Papuan represents a distinct type of mankind or not is doubted by some observers, though the balance of evidence is in favour of that conclusion. This splendid collection of fifty-four plates reproduced from photographs, and representing about six hundred portraits of individuals, should be of great assistance in studying the similarities and differences between the typical Papuan, and the natives of southern and eastern New Guinea. The photographs illustrate the natives of New Britain, the Duke of York Islands, New Ireland, Admiralty Islands, Solomon Islands, German New Guinea, and Dutch New Guinea. They represent the people as they are ordinarily seen, and also decorated with the strange costumes assumed at feasts. Particularly striking are the pictures of natives of New Britain adorned for one of their Dukduk dances, and of the ingenious basket-work traps used by the fishermen. Ethnology will benefit by the publication of this collection of really excellent pictures.

*Farm Vermin, Helpful and Harmful.* By various Writers. Edited by John Watson, F.L.S. Pp. 85. (London: William Rider and Son, Limited, 1894.)

COMPOSITE books are almost always unsatisfactory, the chapters by the various contributors being necessarily unequal in quality and length. We really cannot understand why this little book of eighty pages should not have been written by a single zoologist, instead of the eight who have helped to construct it. The only justification for the patch work is that each of the writers is more or less an authority upon the subject he describes; but the book is of such an elementary

character, that it is difficult to believe that so many minds are necessary for its construction. The contributors are Sir Herbert Maxwell, Mr. O. V. Alpin, Mr. John Cordeaux, Mr. Cecil Warburton, Dr. J. Nisbet, and Mr. C. B. Whitehead. Each tells his tale in his own way, and the editor amplifies the information here and there by means of foot-notes. Farmers will find the book a handy and simple guide, and one which will enable them to know their friends and enemies among the "varmints."

LETTERS TO THE EDITOR.

[The Editor does not hold himself responsible for opinions expressed by his correspondents. Neither can he undertake to return, or to correspond with the writers of, rejected manuscripts intended for this or any other part of NATURE. No notice is taken of anonymous communications.]

The New Cypress of Nyasaland.

THE interesting account of *Widdringtonia whytei* (NATURE, November 22, pp. 85-87) discovered by Mr. Whyte on the Milanji plateau, suggests a few brief comments.

(1) It is said to extend "the geographical range of the genus hitherto known only from South Africa, Madagascar, and Mauritius into tropical Africa." As far as the latter statement is concerned, this is no doubt true. But the existence of any species of the genus in Madagascar or Mauritius seems to be wanting in sufficient evidence, though repeatedly cited by authorities. Thus Madagascar is given in the geographical distribution for the aggregate genus *Callitris* in Benham and Hooker, "Genera Plantarum," vol. iii. p. 424; Dr. Masters, *Journ. Linn. Soc. Bot.* vol. xxx. p. 17, says "one (*Widdringtonia*) has been discovered in Madagascar"; Mr. Rendle, *Trans. Linn. Soc.* (2nd series) Bot. vol. iv. p. 61, speaks of the "South African and Mascarene *Widdringtonia*."

All these statements are based on a species, *Widdringtonia Commersonii*, which was cultivated at Réduit, Mauritius, and of which the native country was assumed to be Madagascar, though this has never been confirmed.

In 1806, it is referred to in the "Nouveau Duhamel," vol. iii. p. 10, as *Thuja quadrangularis*, with the following remark: "Habite l'Isle de Madagascar; depuis quelques années on le cultive au réduit, jardin de botanique a l'Isle de France."

The Madagascar habitat was apparently purely conjectural. And though the island has of late years been pretty assiduously worked by French, German, and English botanical collectors, no conifer has been detected in it except *Podocarpus*.

In 1833 the development of the myth went a step further. Brongniart cites the species in the *Ann. des Sc. Nat.*, series 1, vol. xxx. p. 19, under the name of *Pachylepis Commersonii*, with the remark: "Hab. in Insula Mauriti in loco dicto Le Réduit (Commerson, 1769)."

Thus it will be seen that, starting as an introduced Madagascar species cultivated in a botanic garden in Mauritius, it finishes with being treated as an undoubted native of that island.

It is, however, to be noted that from "Baker's Flora of Mauritius and the Seychelles" (1877) the *Conifera* appear to be entirely absent from the Mascarene Islands.

(2) There is nothing improbable in a *Widdringtonia* occurring in Madagascar. But none has yet been detected with any certainty. It seems not improbable that Commerson's plant was really derived from South Africa. This would seem to be the conclusion at which Carrière arrived in 1867, "Conifères," ed. ii. p. 67:—"Cette prétendue espèce me paraît être à peine une forme de la précédente." (*W. cupressines*, one of the two South African species).

(3) The *Conifera* for the most part can hardly be regarded as other than a very ancient and a decaying group. Their existing distribution is therefore peculiarly interesting. Bentham and Hooker unite under *Callitris* a number of small genera which practically only differ in the number of their ovule-bearing scales and in their geographic distribution. They divide the genus so reconstituted into four sections, of which two are broadly Australian, two are African. Other instances of parallelism between the Australian and African floras are well known and are full of interest. Of the African sections one is confined to the north, with one species, *Callitris quadrivalvis*, which yields the gum Sandarach of modern commerce, and produced the

Thyine wood once so prized by the Romans; the other section, with two species, is confined to the south. The occurrence of a third species on the Milanji highlands is entirely in harmony with what we know of the distribution of plants in Tropical Africa. As has been shown now in numerous cases, a temperate and possibly more ancient flora more or less overlies at elevations where it can exist, the lower lying tropical one, and it forms a series of broken links by which the connection of the temperate flora of Europe and of the Mediterranean basin with that of South Africa, and even of the Madagascar uplands, are at least indicated.

It may be remarked that another coniferous genus, *Podocarpus*, behaves much in the same way as *Callitris*. Four of the five African species occur at the Cape, and two on Kilima-n'jaro. *Tauiferus*, on the other hand, though well represented in Northern Africa, occurs in Abyssinia and the Masai country, but yet does not reach South Africa.

W. T. THIELTON-DYER.

Royal Gardens, Kew, December 10.

The Kinetic Theory of Gases.

I SHOULD like to ask Mr. Culverwell what are the "other considerations" from which we know that in a system of elastic spheres the error law gives the only permanent state.

I will endeavour to extend the proof of the H-theorem which I gave for elastic spheres to a more general, but not the most general, case.

The coordinates of a molecule are  $x, y, z$ , defining its position in space, and  $p_1, \dots, p_{n-3}$ , the momenta are  $p_1, \dots, p_{n-3}$ ; and different values of the same variables shall be denoted by PQ and I, as the case may require, by accented letters  $p'P$ , &c. The number per unit volume of molecules, for which the variables  $p$  and  $q$  are between assigned limits, is  $f dp dq$ , and  $f$  is a function of the  $p$ 's and  $q$ 's independent of  $xyz$ .

The number of pairs for which one molecule has variables  $P'Q'$  between assigned limits, i.e. is in the state  $P'Q'$ , and the other  $p''q''$  between assigned limits, i.e. is in the state  $p''q''$ , is  $F'f''P''Q''dp'dq''$ .

Each molecule has a centre of gravity. It is possible to describe a sphere about that point as centre, such that if the centre of gravity of another molecule be on or beyond that sphere, no appreciable force is exerted between the two molecules. Let  $a$  be the least radius of such a sphere. Then when the centre of one molecule is on the sphere of radius  $a$  described round the centre of another, an encounter begins or ends between the two molecules.

Now suppose an encounter to take place between a pair of molecules one of which is in the state  $P'Q'$ , and the other in the state  $p''q''$ . As the result of the encounter the variables  $P, \dots, q$  assume new values, but what particular values they shall assume, given  $P'Q'p''q''$  before encounter, depends on the two coordinates  $\theta, \phi'$  defining the position of the centre of one of the two molecules on the "a" sphere described about the centre of the other at the commencement of the encounter.

Inasmuch as no work is done in moving the centre of one molecule on the surface of this sphere, it is evident that the "sorting demons" can make the result of the encounter anything that they please, *conservatis conservandis*.

Let us suppose that if these spherical coordinates lie between the limits  $\theta'$  and  $\theta' + d\theta'$ ,  $\phi'$  and  $\phi' + d\phi'$ , the variables will after encounter lie between the limits  $P, \dots, P + dP$ , &c., that is, the pair will be in the state  $P, \dots, P + dP$ , and  $\theta, \phi'$  will have become  $\theta, \dots, \theta + d\theta$  and  $\phi, \dots, \phi + d\phi$ .

I will now assume (condition A) that the coordinates  $\theta, \phi'$  are taken at haphazard without regard to the variables  $P, \dots, q$ ; if that be so, the chance that, for given  $P'q'$  before encounter, the pair of molecules shall be in the  $P, \dots, P + dP$  state after encounter is  $\frac{d\theta' d\phi'}{4\pi}$ .

But the number of pairs which now are in the state  $P, \dots, P + dP$  is

$$F'f'dP \dots dP$$

And therefore the number which after encounter will be in the state  $P, \dots, P + dP$ , having passed thereto from the state  $P'q'$ , will be

$$F'f'dP \dots dP \frac{d\theta' d\phi'}{4\pi}$$

which is equal to

$$\frac{1}{4\pi} dP \dots dP d\theta d\phi \cdot F'f'$$

Now let  $P_1, \dots, p$  be made to pass through all values from which  $\theta$  and  $\phi$  being suitably chosen, they can assume after encounter the given values  $P_1, \dots, P, +dP_1, \dots, p + dp$ . The first values of  $\theta$  and  $\phi$  will vary, but all possible values of  $\theta$  and  $\phi$  must appear for some or other of the values through which  $P_1, \dots, p$  pass, and therefore we shall by this process obtain the whole number of pairs which are in the state  $P_1, \dots, p$  after encounter, without restriction of the state which they had before encounter. It will be, namely:

$$dP_1 dQ_1 dP_2 dQ_2 \dots \int \int F_1 \dots dP_1 \dots dQ_1 \dots \int \int (1 - H) dP_1 \dots dQ_1 \dots$$

the number which are in the state  $P_1, \dots, p$  now is

$$dP_1 dQ_1 dP_2 dQ_2 \dots$$

Therefore, as the result of encounter, it is increased by an amount proportional to

$$dP_1 dQ_1 dP_2 dQ_2 \dots \int \int F_1 - F_1' - H dP_1 dQ_1 dP_2 dQ_2 \dots$$

From this point, thanks to the labours of Boltzmann and Watson, the proof is easy, and I need not repeat it, that  $H$  is negative or zero.

I have assumed condition A. I do not say that that is the only assumption that will answer the purpose. But it is sufficient. And it is, I think, the most useful assumption, because the assumption of coordinates assumed to exist is that which would tend to be produced by any disturbances acting on the system from without.

The proof in this form is not open to the objection that by reversing the velocities we can prove two mutually contradictory propositions.

Oh, that now my friend would write a book, and point out with regard to these assumptions what more is necessary, or what less sufficient. S. H. BURBURY.

Lincoln's Inn, December 5.

P.S.—Dr. Larmor describes the reverse motions as the "exceptions which do not disprove the rule." I would apply the maxim *Ex ceptis generali regulam* in a slightly different sense. They are the exceptions which put the rule to the proof. They compel you to define accurately the limits within which the rule holds. When that has been done for Boltzmann's law (if it has not been done already), it will be time to consider how far the cases which fall within the law are more important than those which fall without it. S. H. B.

December 15.

The presence of any assumption in Dr. Watson's able proof of Boltzmann's Minimum Theorem might easily be overlooked; but if Mr. Culverwell will apply his test of reversing the motions in each separate stage of the proof, he will unearth the assumption of case. On the top of p. 43 Dr. Watson says:

"And therefore the expression

$$F(P_1, \dots, p) dP_1 \dots dp$$

the number of pair of molecules, one from each of these sets, passing from the state  $P_1, P_2, \dots, P, +dP_1, \dots, p + dp$  to the state  $P_1, P_2, \dots, P, -dP_1, \dots, p - dp$  per unit of time, where  $q_0$  is put equal to zero.

Now, let the motion of every molecule be reversed as Mr. Culverwell suggests. It would be convenient to speak of the two cases as the *reversed* and *original* states, and we shall thus have the assumption of the expression

$$F(P_1, \dots, p) dP_1 \dots dp$$

which is also equal to

$$F(P_1, \dots, p) dP_1 \dots dp \dots \int \int F_1 - F_1' - H dP_1 dQ_1 dP_2 dQ_2 \dots$$

will represent the number of pairs of molecules passing back from the *reversed* to the *original* state, and this number will depend on  $F_1$  and  $F_1'$ , the *reversed* and *original* states, the *reversed* and *original* velocities, and the *reversed* and *original* positions.

If this assumption be made, we shall have a case in which  $H$  tends to a maximum in the case of a minimum, and if Mr. Culverwell endows his molecules with the power of foresight, and the prediction regarding their future state may be made able them to regulate their movement according to the supposition law, then Dr. Watson's proof, and indeed

any proof, will necessarily fall to the ground. If however the motions of the molecules are allowed to take their own natural course, and nothing special is known about them, the only reasonable assumption to make is that the number of pairs passing from the accented to the unaccented state per unit time is

$$F(P_1, \dots, p) dP_1 \dots dp \dots \int \int F_1' - F_1 - H dP_1 dQ_1 dP_2 dQ_2 \dots$$

and this assumption is actually made by Dr. Watson in the next few lines of his proof that  $H$  tends to a minimum.

What Mr. Culverwell's objection shows, then, is that it is possible to conceive the molecules of a gas so projected that they would not tend to assume the Boltzmann-Maxwell distribution.

But practically it would be impossible to project the molecules in their reversed motions with sufficient accuracy to enable them to retrace their steps for more than a very few collisions, just as, if we try placing a number of pool balls in a straight line on a billiard table at distances of a foot or two apart, we find it impossible to project the first ball with sufficient accuracy for each ball to strike the next in front all down the line if there are many balls.

The question of the choice of co-ordinates has been so fully dealt with by Dr. Watson that I need say nothing more. However, if Mr. Culverwell prefers, he may transform from Dr. Watson's  $Q_1, \dots, q_0$  to any other variables defining the position of the pair of molecules, provided that he works with the corresponding generalised momenta instead of  $P_1, \dots, p_0$ , and he will have no difficulty in choosing one of his new variables to be such that it vanishes at an encounter.

I think Lorentz's paper ("Sitzungsberichte der Wiener Akademie," 1887, p. 115) affords the fullest account of the assumptions underlying the proof of the Minimum Theorem.

Cambridge, December 5.

G. H. BRYAN.

Science and History.

I SEE by your review of the *Nationalist* in the last number of NATURE, p. 162, that Prof. G. W. Prothero, in his "Address on History," takes occasion to notice Buckle's "History of Civilisation." "Buckle," he says, "in illustrating his theory that national character depends largely upon food, attributes the weakness of the Hindoos to an almost exclusive diet of rice. A striking but misleading generalisation, for, as Sir H. Maine has pointed out, the great majority of Hindoos never eat rice at all." Buckle, however, never said anything of the kind; and since no author wrote more clearly than he did, it is evident that the Professor, like many before him, has not taken this extract at first hand.

What Buckle did say was: that rice, millet, or whatever the Hindoos fed on, was grown with little trouble and in abundance; that the climate made clothes superfluous; that living was consequently cheap, and that hence the population increased beyond the demand for labour; labour was ill rewarded, and the population became practically enslaved. I put the argument very shortly and inadequately, for any one may see it fully set forth in the "History of Civilisation," 1858, vol. i. pp. 93-74.

Sir H. Maine utterly failed to perceive that whatever might have been the food that the Hindoos lived upon, it made no difference to the argument provided that that food was cheap. He was further wrong in his statement that the Hindoos did not feed on rice, as it used to be a far more usual article of diet than in later times; but his worst mistake was to limit the argument to the people of India, who were only one people, out of many, used to illustrate the point.

ALFRED H. HUTCH.

London, December 18.

Geometry in Schools.

As a mathematical teacher of long experience, I wish to state that I thoroughly agree with Prof. Henriot that experimental geometry should be taught antecedently to and concurrently with a rigorous deductive course.

Teachers who have to introduce young students to the study of deductive geometry (*à la géométrie*, as it is called) are confronted with two difficulties. Their pupils in many cases (1) have never been seriously taught to reason about anything; (2) have no stock of geometrical ideas to reason about. The attempts made in kindergartens to give sound notions of form

by means of models, patterns, &c., are excellent as far as they go, but there seems to be great need of a systematic course specially designed to lead gradually up to the study of deductive geometry. The following books will be found useful by teachers who care to give the experimental method a trial: "Paper Folding," by T. Sundara Row (Addison and Co., Madras); "Inventive Geometry," by W. G. Spencer (Williams and Norgate); "Experimental Geometry," by Paul Bert (Cassell and Co.); "Natural Geometry," by A. Mault (Macmillan and Co.); "Geometrical Drawing," by A. J. Pressland (Rivington, Percival, and Co.). To these may be added some older ones, which may occasionally be picked up second-hand: Scott Russell's "Geometry in Modern Life," Dupin's "Mathematics," and "Conversations on Geometry" (Abon.).

Adelaide Square, Bedford.

EDWARD M. LANGLEY.

#### LILIENTHAL'S EXPERIMENTS IN FLYING.

IN a previous article in NATURE (vol. xlix. p. 157) we had occasion to refer to the very interesting experiments which were being carried out by Herr Otto Lilienthal with regard to the possibility of human beings being able to acquire the art of flying through the air, more or less, in the fashion of birds.

These investigations in aerial navigation are conspicuous from all other attempts of the present day, by their great difference in the method of procedure adopted. The principle of Maxim's machine, for instance, is to construct an apparatus to navigate the air by itself, carrying one or more passengers. Every movement of the machine, however, is left to the apparatus itself, and to battle with the difficulty of sustaining its own equilibrium the mechanism must necessarily be most complicated.

Lilienthal depends for the success of his apparatus on himself, trusting to his powers of *instinct* to keep his equilibrium by corresponding movements of his centre of gravity. Man in this case is the main flyer, the apparatus being only an adjunct, and it is from the ability of the former that he expects to obtain positive results. His apparatus is simple, cheap, and easily constructed; these are great points, as experiments can be carried on, even at the expense of the loss of a few machines.

The whole success of aerial flying can be summed up in the word *equilibrium*, and it is here that the difficulty lies. Given a perfectly quiet or very nearly still air, there is no doubt that machines can be constructed so as to soar and travel through the air. This state of atmosphere is very rare; but, on the other hand, there are all sorts of disturbances, currents, and wave-motions which render aerial navigation a far greater difficulty than is usually imagined.

One often envies a bird which, with perfect ease, soars above us; but it must be recollected that it is endowed with a delicate system of nerves which are always on the alert, and answer to any call made on them to sustain equilibrium. These movements are made quite unconsciously, and with the loss of the minimum amount of energy. To construct an apparatus that would accomplish this in an efficient manner would be simply impossible; but there seems no reason why man should not approximate to it to a certain extent by the help of an appropriate framework. With perseverance and many trials he should be able to master at least some of the rudiments, and eventually make short flights.

For this reason Herr Lilienthal's experiments must be looked upon as yet only as first attempts, and consequently as experiments pure and simple, and experience only will show how far they can be successfully brought. Falls must be expected in the preliminary trials until the operator becomes accustomed to the many new conditions which make themselves apparent at every step, before they can be mastered instinctively. Similar difficulties have to be contended with when learn-

ing to ride a bicycle. The beginner is at first unable to keep his equilibrium, and so wobbles here and there, with the loss of much power, until he eventually finds himself hugging the earth. This is simply because he is doing something unusual, and is not accustomed to the new conditions. An adept rider, on the other hand, never thinks of the possibility of falling, and quite unconsciously keeps his equilibrium without any exertion or

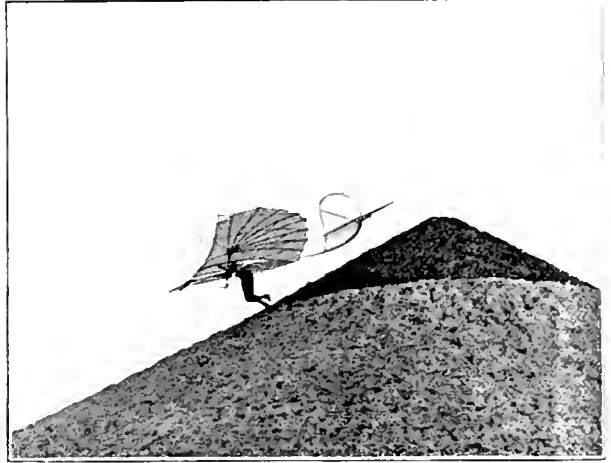

FIG. 1.

loss of power on his part. So it is with this new sailing machine, and it is only by practice that success can be attained.

To commence operations the simplest apparatus must be used, and the easiest steps attempted. This is the way Herr Lilienthal began. In his first experiments, with the help of his wing-shaped framework, he made flights from elevated points in calm weather, the lengths

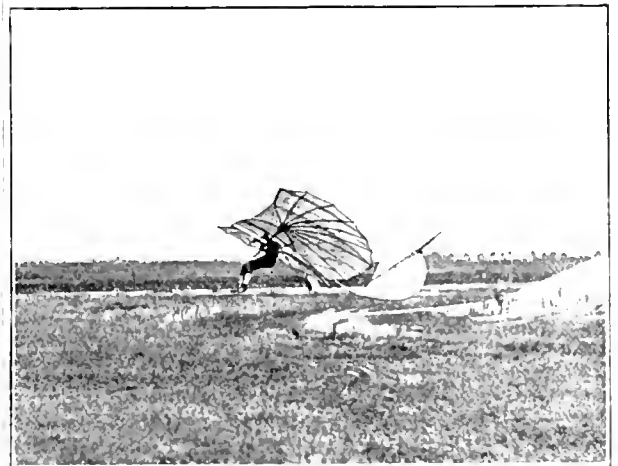

FIG. 2.

of these flights increasing as he gained in experience. Sometimes as many as 500 metres were covered in one bound under satisfactory conditions.

In his more recent experiments he has been making considerable progress in developing this mode of sailing. Two objects have been kept well in mind: the first, to accomplish that method of sailing which is adopted by birds which spend hours in the air at a time without ever

flapping their wings; and second, to apply to his apparatus such dynamical means that will enable him, when sailing in a calm atmosphere, to prolong his flights.

To carry out these experiments he has thrown up, in

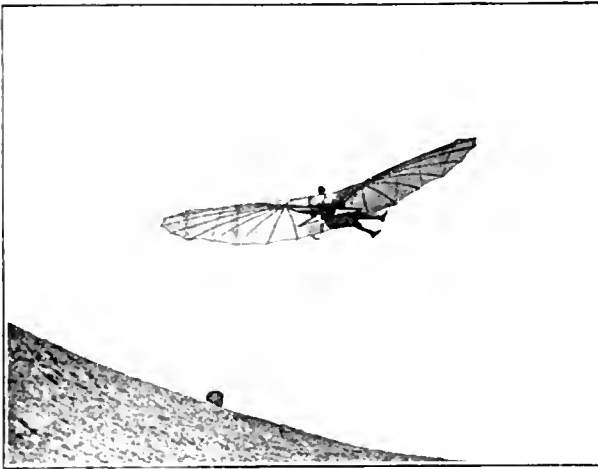

FIG. 1.

the neighbourhood of Berlin, a large conical mound, fifteen metres in height; this mound he uses as a starting-point for his flights. In Fig. 1 the operator is shown just commencing one of these flights.

sails off until he alights again on the earth. Fig. 2 shows him just about to alight. It will be noticed that to come down easily and softly, he puts on the brake by offering to the air a greater expanse of wing, whereby his velocity is at once reduced.

By experience Herr Lilienthal has found that although in quiet weather he can manipulate his craft very easily, in windy weather the operator has to be more careful. The investigations in this direction have, however, been satisfactorily made, and he can now by an adroit movement of his body and that of the apparatus sustain his equilibrium, and sail successfully.

In his article on this subject (*Prometheus*, No. 261, p. 7), from which these references to his new experiments have been taken, he states that sometimes, when a strong wind was blowing, he has been surprised by sudden gusts, which, before he had time to make the necessary movements to sustain his equilibrium, had carried him high up in such a manner as to often take his breath away.

Fig. 3 illustrates the operator receiving such a sudden shock: it will be seen at once that to contend with these new conditions he has had to bring his sail up to the direction of the blast, and to meet it if possible, while at the same time he has altered his whole centre of gravity by a movement of the lower part of his body.

Such movements as these cannot yet be made quite instantaneously, owing to lack of experience; but, as he justly remarks, with more practice he will no doubt be able to make them instinctively, just as the bicycle-rider does.

To attain his second object, that is, to employ some mechanical aid to help him to sustain himself for longer intervals of time in the air, he has constructed a

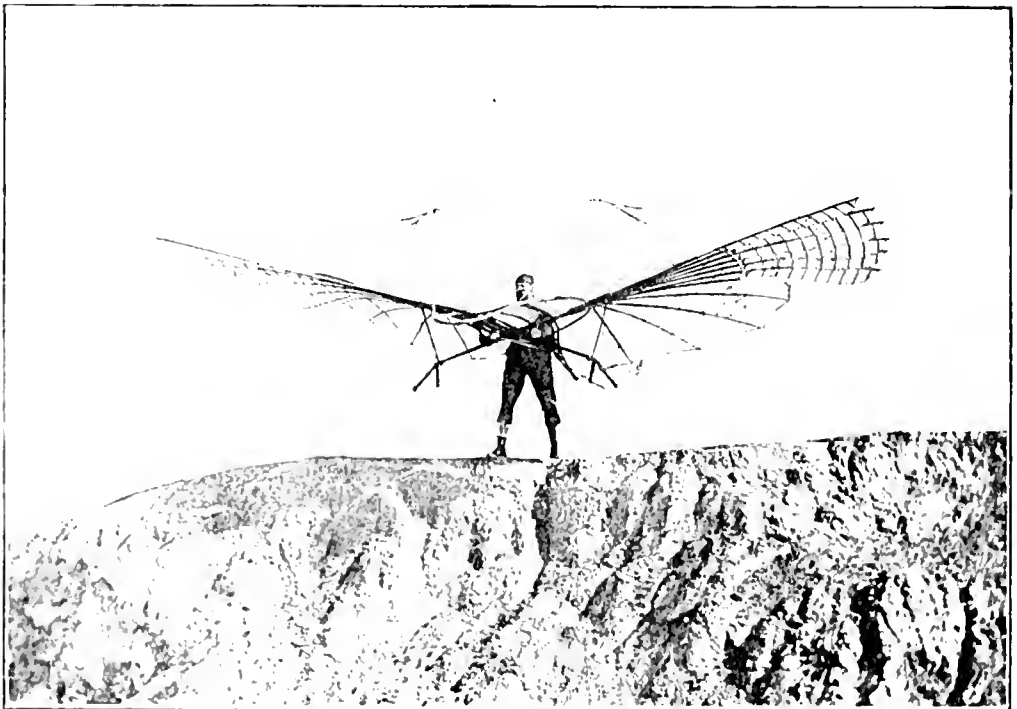

FIG. 4.

With a tight grip of the framework with his hands, he runs quickly down the slope until he has attained a sufficient velocity to raise him and his apparatus off the ground. When such conditions have been obtained, he

new apparatus, somewhat, but not quite, similar to that up till now used. A good idea of this can be obtained from the accompanying illustration (Fig. 4).

A comparison of this *flying* machine with the *sailing*



machine in the previous figures will show that the extremities of the wings have been differently constructed, being composed at the ends of a series of feather-like sails. These latter are connected with a small machine near the operator's body, which is driven by compressed carbonic acid gas; it is set in motion by a simple pressure of the finger. Such an addition has of course increased very considerably the weight and, therefore, the difficulty of handling the apparatus, and as yet it has only been used when the conditions were very suitable, as one serious fall would break up the machine.

Nevertheless the results up to now are very promising, and in calm weather Herr Lilienthal has been able to considerably prolong his flights. When, with the ordinary sailing machine, he would have come naturally down to the ground, he has found that an occasional flapping of these wings has helped to sustain him a longer time in the air, and to consequently cover greater distances.

Herr Lilienthal has shown now, that, with the simple sailing machine, flights can be made without any great risk. It would be good for the future progress of this mode of sailing if those interested in it, and who have the time and money, would take it up and pursue it further. What is wanted now is experience, and this can only be obtained by the co-operation of many workers.

#### PETERS-DENZA-RANYARD.

ASTRONOMICAL science has lost three of its votaries during the present month. Dr. C. F. W. Peters died on December 2, and Father F. Denza, as well as Mr. A. C. Ranyard, passed away on Friday last.

Dr. Carl Friedrich Wilhelm Peters, Director of the Königsberg Observatory, died on December 2, after a protracted illness. He was born on April 16, 1844, at the Pulkowa Observatory, where his father, Prof. C. A. F. Peters, held an appointment under the Russian Government. In 1849 his father was appointed to the Chair of Astronomy at Königsberg, and in 1854 he was made Director of the Altona Observatory, which was afterwards transferred to Kiel. The son studied astronomy and mathematics at Berlin, Kiel, München, and Göttingen, and was placed on the staff of the Hamburg and Altona Observatories. Between 1869 and 1872 he made some valuable pendulum observations, chiefly for the Prussian Government. As Privatdocent at Kiel University he undertook a long series of chronometer tests for the German Navy, in the course of which he proved that they are influenced by changes of humidity as well as by changes of temperature. In 1880, upon the death of his father, he edited the *Astronomische Nachrichten* for a year, after which he was appointed Extraordinary Professor at Kiel University. In 1883 he undertook the direction of the Naval Chronometric Observatory at Kiel, whence he proceeded in 1888 to the directorship at Königsberg, where he terminated a useful and laborious career.

Father F. Denza died at Rome on the 14th inst. from cerebral hemorrhage. He was well known to the scientific world by his works in astronomy, meteorology, and terrestrial magnetism, and at the time of his death was President of the Italian Meteorological Society, and Director of the Observatory at Moncalieri, which he founded in 1859, as well as of the Vatican Observatory, which was established by the Pope in 1891. It was owing to the untiring energy of Father Denza that the *Corrispondenza Meteorologica Italiana* was established in connection with the Alpine Clubs, and that the results of observations at a large number of stations in the Alps and Apennines have been regularly published in the organ of the Italian Meteorological Society.

He was elected an honorary member of the Royal Meteorological Society in 1870.

In astronomy his chief work relates to the observation of meteors. For several years he issued instructions to observers of meteors previous to every important shower, and he published numerous tables and papers on the observations carried on under his guidance, both in *Comptes-rendus* and the *Monthly Notices* of the Royal Astronomical Society. When the Directorship of the Vatican Observatory was taken by Father Denza a very comprehensive programme was drawn up, embracing investigations in meteorology, terrestrial magnetism, geodynamics, and astronomy. Observations in each of these branches of knowledge have increased in number every year since then, and the fourth volume of the *Pubblicazioni* of the Observatory, received by us on the same day as the news of Father Denza's death, is even greater in bulk than any of the previous ones. Father Denza was chiefly instrumental in making the Vatican Observatory one of those co-operating in the production of the photographic star-chart. He devoted his best energies to the advancement of the scheme, and to the progress of astronomical photography. The reports to which reference has been made, contain evidence of his knowledge of what had been done in other astronomical observatories, and of his ability to direct and further the advancement of celestial photography. His services to astronomy have earned for him an honoured place in our memory of the sons of science.

Mr. Ranyard was born in 1845. He was educated at Cambridge University, and was called to the Bar in 1871. He was one of the founders of the London Mathematical Society, of which he was originally joint secretary with Mr. George De Morgan, Prof. Augustus De Morgan being president. He became a Fellow of the Royal Astronomical Society in 1864. In 1870 he was assistant secretary of a joint committee of the Royal Society and the Astronomical Society, which organised the expedition despatched to Sicily, Spain, and Oran to observe the total solar eclipse of December 21. On his return to England he undertook to assist Sir G. B. Airy in the preparation of the report of the observations of the total eclipses both of 1870 and 1860. Ultimately Sir George Airy transferred the work entirely to Mr. Ranyard, and in 1880 the report was published by the Royal Astronomical Society as vol. xli. of its "Memoirs." He observed the total eclipse of July 29, 1878, from Cherry Creek, near Denver, Colorado, and the total eclipse of May, 1882, from Sohag, in Upper Egypt. In addition to papers on the corona and matters connected with physical astronomy, he also published papers on the "Early History of the Achromatic Telescope," and on "Photographic Action." In conjunction with Lord Crawford and Balcarras, he undertook in 1872 a series of experiments on photographic irradiation; and in 1886 he demonstrated by a series of experiments that the intensity of photographic action varies directly as the brightness of the object photographed, and directly as the time of the exposure. The "Old and New Astronomy," designed by Mr. Proctor, was completed in 1892 by Mr. Ranyard, who contributed to it some very important sections on the structure of the stellar universe.

#### NOTES.

THE newly-discovered gas is to be the subject of a discussion at a meeting of the Royal Society on January 31, when Lord Rayleigh and Prof. Ramsay will present their paper. This will be the first meeting under a resolution of the Council of the Society passed last session, whereby certain meetings, not more than four in number, are to be devoted every year, each to the hearing and consideration of some one important communication, or to the discussion of some important topic.

At the request of the Ottoman Government, Dr. G. Agamenzone, of the Italian Meteorological and Geodynamic Office, will shortly proceed to Constantinople to found there a seismological observatory of the first order. Amongst the instruments to be erected are an Agamenzone seismometrograph and a tromometer similar to those in use in the principal Italian observatories. The tromometer will be provided with a photographic recording apparatus, and is specially adapted for registering the long-period pulsations from distant earthquake centres.

DIRECTORS of Botanic Gardens abroad will be glad to know that a list of seeds of hardy herbaceous annual and perennial plants and of hardy trees and shrubs which, for the most part, have ripened at Kew during the year 1894, is given in an appendix, recently issued, to the *New Bulletin*. These seeds are not sold to the general public, but are available for exchange with Colonial, Indian, and Foreign Botanic Gardens, as well as with regular correspondents of Kew. No application, except from remote colonial possessions, can be entertained by the Director of the Royal Gardens at Kew after the end of March.

THE death is announced of Pafnutij Tchebitchef, the eminent Russian mathematician. He was a Foreign Member of the Royal Society, and an Associé Etranger of the Paris Academy of Sciences.

DR. F. B. HAWKINS died on December 7, at the great age ninety-eight. He was elected a Fellow of the Royal Society sixty years ago, and was one of the oldest members of the medical profession.

THE *Zuriger* understands that the Premier has consented to receive a deputation to advocate the formation of a University at London on the lines recommended by the recent Royal Commission. The meeting will probably take place about the middle of January.

THE Paris correspondent of the *Chemist and Druggist* reports that the Municipal Council have presented fifteen hundred francs to the Ecole Normale Supérieure, to erect a bust of M. Pasteur in that college. The Council have also voted in favour of changing the name of the rue d'Ulm to that of "rue Pasteur."

At the invitation of the associated scientific clubs of Berlin, a numerous assembly met on Friday last in order to commemorate the great services rendered to science by the late Prof. von Helmholtz. The German Emperor and Empress, and many Members and members of Parliament, attended the ceremony.

Our Cambridge correspondent informs us that the Counts after St. Nicholas' in Physics at Trinity College have been awarded for two years to Mr. J. L. Tuckett, and for one year to Mr. S. W. L. Smith, both being scholars of the College.

THE Council of the Marine Biological Association has appointed Mr. F. L. Allen to be director of the Plymouth laboratory in succession to Mr. E. J. Biles, who lately resigned the position. Mr. Allen is pupil of Prof. F. L. Schultze, of Bremen, and has been engaged in researches upon the colonial and nervous systems of Crustacea, some interesting results of which were recently noticed in our column.

At a recent meeting of the Council a report on a new series of observations made on the first day of the new year under wholly different conditions and a forecast. The *New York Tribune* says that the year will "probably be under the control of a representative special committee, and will undergo to report on the progress

of science for men of science. The managing committee is constituted as follows:—Mathematics, Prof. Simon Newcomb; Mechanics, Prof. R. S. Woodward; Astronomy, Prof. E. C. Pickering; Chemistry, Prof. Remsen; Physiography, Prof. W. M. Davis; Paleontology, Prof. O. C. Marsh; Morphology, Prof. W. K. Brooks; Zoology, Dr. C. Hart Merriam; Botany, Prof. N. L. Britton; Hygiene, Dr. J. S. Billings; Physiology, Dr. H. P. Bowditch; Ethnology, Dr. J. W. Powell; Anthropology, Dr. D. G. Brinton; Psychology, Prof. Cattell.

THE Organising Committee of the International Geographical Congress have issued an invitation circular to members of geographical societies, and all who take an interest in any of the various aspects of geography, to attend the meetings of the Sixth International Geographical Congress, which will be held in London from July 26 to August 23, 1895. The subjects to be dealt with at the Congress will be grouped under the following heads:—(1) Mathematical Geography; (2) Physical Geography, including Oceanography and Geographical Distribution; (3) Cartography; (4) Exploration; (5) Descriptive Geography; (6) Historical Geography; (7) Applied Geography, including Anthropo-Geography; (8) Education. Intending contributors of papers should send in their communications (written in English, French, German, or Italian) before the end of next April. An exhibition of instruments, maps, globes, photographs, and other objects representative of the present state and past history of geographical science, will be held in connection with the Congress.

DR. E. DE TELLENBERG writes to us, from the Natural History Museum at Berne, with reference to a communication made by Sir John Lubbock to the Geological Society, on November 7 (*NATURE*, vol. li, p. 94), on some nummulites from the valley of Lauterbrunnen at Murren. Sir John Lubbock remarked that "the find will necessitate a substantial correction of the geological map"; but Dr. de Tellenberg says that the nummulitic layer described was known long ago, and is shown on several geological maps; while the conclusion, that the rock is "not Malm, but Eocene," appears to have been arrived at fifty years ago.

In a presidential address to the members of the Tyneside Naturalists' Field Club, just received, Prof. G. S. Brady gives an interesting sketch of the present state of fisheries and fish-culture in Great Britain. He describes a visit to Mr. Armistead's successful salmon and trout hatchery near New Abbey, and recommends the foundation of a hatchery on the Northumberland coast to aid in keeping up and improving the supply of sea-fish, and of a biological laboratory attached to it for the scientific study of the marine fauna of the neighbourhood. We hope that everyone interested in the maintenance of our sea-fisheries, and in the study of marine biology in the north-east of England, will cordially assist in the realisation of this timely proposal. A work of this kind, as Prof. Brady suggests, comes fairly within the powers of the County Councils, which have already shown a commendable care for the interests of agriculture, and a desire generally to help forward technical and scientific education.

THE current number of the *Rivista mensile* of the Italian Meteorological Society contains a summary, by Profs. A. Bartoli and E. Stracconi, of their determinations of the absorption of solar radiation by fog and by cirrus clouds. The investigations were very carefully conducted, and the results are therefore of considerable interest. It was found that a veil of cirrus was able to intercept as much as 30 per cent. of the sun's rays; while a slight fog, equally diffused in all directions, intercepted from 58 to 92 per cent. of the solar rays, which would have been transmitted with a perfectly clear sky. Full particulars of

the numerous experiments made by the authors since the year 1885 will be found in the *Proceedings of the Royal Institute of Lombardy of July 19 last*.

THE Pilot Chart of the North Atlantic Ocean shows that the weather over that ocean during November was very severe. From the 9th to the 23rd of the month there were only two days of good weather between Newfoundland and this country. An appendix to the chart gives the synoptic weather conditions of the North Atlantic north of the 35th parallel for six consecutive days (September 28 to October 3) for the hour of Greenwich noon, showing the positions and behaviour of the various storms which were prevalent at that time. The excellent system adopted by the United States authorities for the collection and discussion of observations made at sea has enabled them to produce this synoptic chart so soon after date. We notice, however, that in the description of the storm signals used in various countries the "cylinder" or "drum" is referred to as now being employed by this country, but as a matter of fact it has not been used for many years.

IN *La Nature* of the 1st instant, M. de Nansouty gives an account of some interesting experiments by M. Kuechlin on the Eiffel Tower, with the view of measuring the force of the wind by the use of metal blocks whose resistance had been previously tested in the laboratory by means of compressed air. During the storm of November 12 last, the velocity anemometers registered 100 miles in the hour, and according to the formula used for the conversion of velocity into pressure, the blocks indicating a pressure of 200 kilograms ought to have been overturned, but only those indicating a pressure of 100 kilograms were displaced. From this, M. Kuechlin concludes that the formula gives results about 40 per cent. too high. It appears to us that the experiments afford a remarkable confirmation of Mr. W. H. Dines's recent investigations of anemometrical constants, in which he found that the usual theory of the cups moving with one-third of the wind's velocity gave values which were about 30 per cent. too high. Experiments very similar to those of M. Kuechlin were made by Mr. G. Dines some years ago, under less favourable conditions, but with nearly similar results.

A PICTURE-PUZZLE of a remarkable kind appears in the *Zoologist* for December. It is a reproduction of two photographs of a Little Bittern, showing the strange attitudes assumed by the bird to favour its concealment. One of the figures shows the bird standing in a reed-bed, erect, with neck stretched out and beak pointing upwards; and in this position, it is difficult to distinguish the bird at all from the reeds. The eye is deceived in a similar manner when the bird is crouching against a tree-stump at the river-side. Mr. J. E. Harting thinks that the curious attitudes adopted by the bird, on finding itself observed, are assumed in the exercise of the instinct of self-preservation. He mentions a similar habit, observed and described by Mr. W. H. Hudson, in the case of a South American Little Heron, which frequents the borders of the La Plata, and is occasionally found in the reed-beds scattered over the pampas. Without the aid of dogs, it was found impossible to secure any specimens of this bird, even after marking the spot where one had alighted.

THE architecture and sculpture of Gastropod shells has often arrested the attention of naturalists, for, in spite of the infinite variety of form assumed by the shell, it is in most cases extremely difficult to perceive any special utility in the nature of the modifications. A paper by Mr. W. H. Dall, however, in a recent number of the *American Naturalist* (No. 335), certainly tends to clear up two sets of these phenomena, viz. the ridges or plications of the columella, and the liræ or teeth of the outer lip. The author shows that among the fusiform rachi-

glossa the retractor or columellar muscle is longer, and attached deeper within the shell in the plicated (e.g. *Mitra*) than in the non-plicated forms (e.g. *Fusus*). The result of this is that in the former the mantle during contraction is withdrawn into a part of the shell too narrow to admit it in its normal shape. The mantle must wrinkle longitudinally; and the longitudinal shelly ridges on the pillar and towards the aperture of the shell are the mechanical consequences of this plication of the secreting surface. Similarly in forms possessing a very extensive mantle (*Volutidae*, *Cypræidae*) it may be noticed that the outer lip of the shell is toothed chiefly in those types in which the aperture is small, and that the denticulation is less marked as the aperture becomes larger. This is attributed by Mr. Dall to the fact that as the aperture becomes reduced the mantle must become increasingly wrinkled at its exit from the shell, thus causing the deposition of teeth and liræ on the outer lip (e.g. *Cypræa*). If these features fall under Prof. Lankester's category of "responsive characters," the question arises whether the whole molluscan shell, so far as its shape and sculpture is concerned, is not simply a combination of such characters.

THE first number of a series of hand-lists of the collections of living plants cultivated in the Royal Gardens, Kew, has just been received. This part, which contains a list of *Polyfetalis*, shows that the complete catalogue will be of the highest service in helping to establish a uniform system of nomenclature. An immense number of "trade" or "garden" names have been reduced to their proper synonyms, and as the woody plants (shrubs and trees), grown in the open air, are particularly liable to confusion in gardens, and in nurserymen's catalogues, the present list is most acceptable. It can easily be understood that the list "represents the work of many years, and has only been accomplished with considerable labour." From the preface we learn that, of the twenty thousand species and distinct varieties of plants cultivated at Kew, three thousand are hardy shrubs or trees. The first catalogue of plants cultivated at Kew, published in 1708, contained 3389 species, of which 488 were hardy trees and shrubs. The two Aiton's published similar lists, but that issued by the younger Aiton early in this century, and containing about eleven thousand species, was the latest comprehensive list of plants in cultivation at Kew, though lists of special collections have been published from time to time. The great importance of the series of hand-lists, which Mr. Thibetson-Dyer has instituted, will therefore be at once understood.

THE twenty-sixth volume of the *Memoirs* of the Russian Geographical Society (General Geography) contains an important work by Prof. Mashketoff and A. Orloff, being a catalogue of all the earthquakes which are known to have taken place in the Russian empire and the adjoining territories of China, Turkestan, Persia, and Asia Minor from the year 596 B.C. till the year 1887. The list comprises no less than 2400 separate earthquakes, of which 710 took place in China, 569 in East Siberia, 36 in West Siberia, 202 in Central Asia, 590 in Caucasia, 121 in North Persia and Asia Minor, and 188 in European Russia and Finland. These figures alone, if compared with those for China in the catalogues of R. Mallet, A. Perrey, and Fuchs, give an idea of the richness of the Russian catalogue. As to Russia, Siberia, and Turkestan, the catalogue is replete with entirely new data. Most of the earthquakes of the last two centuries, for which we possess full accounts, given by careful observers, are described at some length, and some of the descriptions, especially for the earth tremors of Shemakha, Lake Baikal, and Turkestan, are of great value. A map showing the distribution of the earthquakes over the territory, and diagrams showing their frequency during the different months, accompany this most valuable work.

A PAPER on the various more or less phantastic forms assumed by combinations of alkalis with oleic acid when brought into contact with water, is contributed to the current number of *Wissenschaften*, by Dr. G. Quincke. Oleic acid with little alkali, or containing an acid oleate of an alkali in solution, form in much water hollow spheres, globules, and foam, with walls of liquid oleic acid. The hollow spaces are filled with aqueous soap solution. When more water is added, the walls are covered with a solid skin of the acid oleate, which may then become quite liquid again by decomposition into liquid oleic acid and aqueous soap solution. The periodic flow of soap solution at the surface separating liquid oleic acid and water produces vortex motions, which may be made evident with methylene blue or other coloring matter. More hollow spheres and bubbles of oleic acid are formed, which are arranged by the capillary forces on the larger bubbles in definite positions, such as straight lines, circles, and ellipses. Dr. Quincke points out the remarkable analogy between this arrangement and the configuration of various small portions of the stellar universe, such as portions of Orion, Virgo, and Coma Berenice's, and recalls Plateau's experiments with weightless oil spheres illustrative of the generation of the solar system. He also emphasises the fact that the protoplasm of the organic world shows a structure and motions similar to those of oil foam with liquid or solid surfaces.

UNDER the title, "Science Teaching: an Ideal, and some Realities," Mr. H. G. Wells delivered a lecture at the College of Preceptors last week. Much attention is now being given to the methods of science teaching in our elementary schools and colleges, and Mr. Wells' views on the subject are sound enough to be taken into consideration. In the course of his lecture, he pointed out that a rational course of science should grow naturally out of kindergarten. This should lead to object-lessons proper, and demonstrations in physics and chemistry may be made to grow insensibly, without any formal beginning, out of such lessons. The best, about the only permanently valuable, preparation for a scientific calling that can be given to a boy in a secondary school, is the broad basis of physics and chemistry led up to in this way.

THE 1895 *Annuaire* of the Montsouris Observatory—the Observatory of the Paris Municipal Council—has been published. Though the observations made at the Observatory have general reference to the climatology and hygiene of Paris, researches into the domains of pure science are carried on. M. L. D. Croix has charge of the physical and meteorological services, and M. Albert Levy of the chemical part of the work. The department includes the study of the variations in the chemical composition of the air in various parts of Paris, and of rain and river waters. The third branch of the work, dealing with micro-organisms, is under the direction of Dr. Miquel, whose number to the *Annuaire* his sixteenth memoir on the organic matter found in air and water.

THE paper read at meetings of the Natural History Society of Southumberland, Durham, and Newcastle upon Tyne, and the Tyneside Natural Club, during the past two years, have just been published in the Society's *Transactions*, vol. xi. part ii. Among them is an article, by the President, Prof. G. S. Brady, F.R.S., on "The life history and character of some internal parasites, and a lecture on parasitism in plants and animals." The latter forms one of a series of reports of five lectures given in the Museum of the Society; the others being "On the Egg," by Dr. D. Imbleton; "Frog and Tadpoles," by Prof. M. G. Foster; "The structure of Timber," by Dr. W. Somerville; and "Germs," by Mr. H. D. Haviland. The Society appears to be in a far more flourishing condition than most provincial societies.

SEVERAL new editions of scientific books have been received during the past week. Prof. Richard Hertwig's "Lehrbuch der Zoologie" (Gustav Fischer, Jena) is one of these. The original edition was reviewed in NATURE in June 1893 (vol. xlviii. p. 173), and we have nothing to add to the remarks then made, except that the work has been improved by revision. We are glad to see that Mr. Cumming's "Introduction to the Theory of Electricity" (Macmillan) has reached a fourth edition. The chief additions to the new issue are articles upon the magnetic circuit and on the dynamo. "Symbolic Logic," by Dr. John Venn, F.R.S. (Macmillan), has survived the prejudices of anti-mathematical logicians, for a second edition, revised and rewritten, has just appeared. Finally, Messrs. Whittaker and Co., have issued a second edition of "The Electro-Platers' Handbook," by Mr. G. E. Bonney. This useful manual has been enlarged by an additional chapter on electrotyping, and by a number of short sections on new methods of interest to amateurs and young students of electro-metallurgy.

A BULLETIN (really a volume of 259 pages), by Mr. J. E. Spurr, has come to us from the Geological and Natural History Survey of Minnesota. The subject is "The Iron Bearing Rocks of the Mesabi Range in Minnesota," and the author treats it from many points of view. A number of reproductions of the appearances presented by thin sections of the rocks when microscopically examined, accompany the memoir. The matter is not merely descriptive of the general structure and characteristics of the Mesabi iron-bearing rocks; if it were, it would only be of local interest. Space is given to the statement of theories to account for the origin of rocks of the kind described—a subject which is still one of doubt, discussion, and speculation. In this connection the origin of glauconite is dealt with. An examination of a thin section, with a view to finding whether the forms in which the glauconitic grains sometimes occur have any resemblance to organic forms, led to a negative result. Mr. Spurr thinks it possible, however, that further study of more favourable sections may result in finding traces of the organisms which possibly once existed in the rocks investigated. His work throws new light upon several perplexing problems in economic geology.

ANHYDROUS hydrogen peroxide has at last been isolated by Dr. Wollenstein in the laboratory of the Technischen Hochschule at Berlin, and the somewhat surprising fact demonstrated that this substance, which has hitherto been regarded as possessing but little stability, is capable of actual distillation with scarcely any loss under reduced pressure. In attempting to concentrate solutions of hydrogen peroxide *in vacuo* by the method of Talbot and Moody, and also in the open air upon the water bath, a solution as strong as 60 per cent.  $H_2O_2$  was obtained, but with a loss of over 70 per cent. of the original amount of peroxide employed. Moreover, it was found that when the common commercial 3 per cent. solution is concentrated, the percentage of  $H_2O_2$  may be brought up to 45 without the loss of any considerable quantity of the peroxide by volatilisation, but that as the concentration continues to rise above this limit the volatilisation of the peroxide increases at a very rapid rate. For the great loss was proved not to be due to decomposition, but to actual vapourisation of the substance. Evidently hydrogen peroxide is remarkably stable at the temperature of a water bath. An attempt was therefore made to actually distil under reduced pressure. A quantity of commercial peroxide which had been further concentrated until it contained about 50 per cent.  $H_2O_2$  was first purified from all traces of suspended impurities, and at the same time still further concentrated, by extraction with ether; after evaporation of the ether the solution was found to contain 73 per cent.  $H_2O_2$ .

This solution was then submitted to distillation at the temperature of the water bath and under the reduced pressure of 68 m.m. of mercury. The distillate was received in two-fractions, boiling at  $71^{\circ}$ - $81^{\circ}$  and  $81^{\circ}$ - $85^{\circ}$  respectively. The first fraction contained 44 per cent.  $H_2O_2$ , while the latter was found to contain no less than 90.5 per cent. Upon again fractionally distilling the latter product, a large proportion distilled at  $84^{\circ}$ - $85^{\circ}$ , and this fraction proved to be practically pure  $H_2O_2$ , containing over 99 per cent. of the peroxide. The liquid thus isolated is a colourless syrup which exhibits but little inclination to wet the surface of the containing vessel. When exposed to the air it evaporates. It produces a prickly sensation when placed upon the skin, and causes the appearance of white spots which take several hours to disappear again. As regards the much-discussed and disputed question of the reaction of hydrogen peroxide towards litmus, Dr. Wolffenstein finds that even when the pure liquid is made strongly alkaline with soda and again distilled, the distillate exhibits strong acid characters, so that the acid nature of hydrogen peroxide must be regarded as fully established. It is finally shown that the use of ether in assisting the concentration is by no means essential. Ordinary commercial 3 per cent. peroxide can be immediately subjected to fractional distillation under reduced pressure, and a fraction eventually isolated, consisting of the pure substance boiling at  $84^{\circ}$ - $85^{\circ}$  under a pressure of 68 m.m.

THE additions to the Zoological Society's Gardens during the past week include a Common Fox (*Canis vulpes*), British, presented by Mr. Harold von Lohr; a Spotted Ichneumon (*Herpestes nepalensis*) from India, presented by the Misses Violet and Sylvia Brockelbank; two Curlews (*Numenius arquata*), British, purchased.

#### OUR ASTRONOMICAL COLUMN.

SECULAR VARIATIONS OF THE INTERIOR PLANETS.—As far back as 1859, Leverrier discovered that the movement of the perihelion point of the orbit of Mercury was greater than could be accounted for by the action of all the known planets, and he attributed this to the effect of a group of unknown bodies circulating between the orbit of Mercury and the sun. Prof. Newcomb has recently gone over the ground again, and the results of his work are given in *Comptes-rendus* of December 10. A brief statement of the tentative conclusions arrived at was given in these columns on November 29 (p. 114). From a discussion of a vast number of observations he has re-determined the secular variations for the orbits of Mercury, Venus, the Earth, and Mars, and he has computed the masses of Mercury, Venus, and Jupiter from the periodical perturbations which they produce; the adopted value of the earth's mass is deduced from the parallax  $8''.80$ , and for Mars the adopted mass is that derived from observations of the satellites. It is then shown that with these masses the calculated values of the secular variations differ from the observed ones, the divergences being especially great in the movements of the perihelia of the orbits of Mercury and Mars, and of the node of Venus. Two explanations of the differences are open to us: (1) It may be supposed, as suggested by Prof. Asaph Hall, that the law of gravitational attraction is not strictly true, and that the attractive force of the sun varies inversely as the distance raised to the power of approximately  $2.000001574$ ; (2) they may be attributed to the influence of unknown masses of matter.

At first sight, the second hypothesis seems preferable, as it involves no departure from an accepted law, and because it is the only one which will explain all the secular variations, while on the first hypothesis the perihelia would alone be affected. If there are unknown bodies between Mercury and the sun, Prof. Newcomb shows that in order to produce the observed effects, their mass must be great enough to produce a sensible ellipticity in the sun's figure; and as this has not been detected, he prefers to place these unknown bodies between the orbits of Mercury and Venus. He has computed the elements of an orbit which would reduce all the discrepancies between observed and calculated values of the secular variations to less than the

probable errors, the mean distance being 0.48, and the mass  $1/37,000,000$  that of the sun. At the same time, Prof. Newcomb regards this result more as a curiosity than as a reality, as it seems improbable that such a group of bodies should have escaped discovery.

Returning to the other hypothesis, he finds that if we accept Hall's modification of the law of gravitation, which accounts for the movements of the perihelia, the variations of the other elements can all be explained by slightly changing the value of the earth's mass. The new value corresponds to a solar parallax of  $8''.77$ . Although by no means regarding the latter hypothesis as established, Prof. Newcomb is inclined to adopt it provisionally.

IRREGULARITIES IN VARIABLE STARS.—In a summary of the observations of variable stars of long period, made by W. Maxwell Reed at Harvard College Observatory and the Abbot Academy (*Astron. Journ.* No. 330), the importance of studying the irregularities in the light curves is strongly insisted upon. The observations indicate numerous "stand-stills," or notches in the light-curves, and these are believed to be secondary phases produced by additions of light at those points. "A record of over ten years for T Cephei gives ten more or less well-defined stand-stills. The mean period is about twenty days less than that of the variable (about 383 days)." From studying these and other variables, Mr. Reed is inclined to believe that "the light-curve, in some cases at least, is the sum of two or more curves—each component curve having a different range, period, and character from the others. By such a hypothesis one can account for the changes in period and range of a variable, and the presence of "stand-stills" and secondary phases. Unfortunately, there is not enough evidence yet to give the elements of the two or more component curves for T Cephei." It will be remembered that Mr. Lockyer has also seen the necessity for supposing more than one source of variation in many cases, and some of his examples of the peculiar curves produced by integrating two perfectly regular ones were given in our columns four years ago (*NATURE*, vol. xlii, p. 550). With Mr. Reed we regret that less attention has been given by observers to the character of the light-curves of these variables, than to the determination of the maxima and minima.

THE RADCLIFFE CATALOGUE.—The new star catalogue recently issued by Mr. Stone contains the positions of 6424 stars for the epoch 1890, deduced from observations made with the transit circle at the Radcliffe Observatory between January 1, 1881, and December 31, 1893. Up to 1887 a considerable number of observations were made for the determination of systematic errors of the instrument and for errors of the refraction tables. Since then the observations have been more exclusively directed to obtaining the positions of stars for well-distributed zero-points between the equator and N.P.D.  $115^{\circ}$ , in continuation and completion of the work carried out under Mr. Stone's direction at the Cape of Good Hope between the years 1870 and 1879. The catalogue gives the positions of all stars down to seventh magnitude between the equator and N.P.D.  $115^{\circ}$ , except those in clusters; of fainter stars to fill existing lacunae; and of many stars of greater N.P.D. than  $115^{\circ}$  for comparison with the Cape catalogue of 1880. Many stars north of the equator are also included. The Cape catalogue and the present one together give a series of well-distributed zero-points for the whole southern hemisphere. With reference to future meridian work, Mr. Stone remarks: "From the facilities which photography affords for the rapid filling in of the positions of the fainter stars on a photographic plate, when those of a sufficient number of zero-points on the plate have been otherwise fixed, it would appear that the efforts of meridian observers will, for the future, be most advantageously directed to this class of stellar work." The catalogue includes estimates of proper motions as well as the usual constants, and there are also copious notes relating to the double and variable stars. The early appearance of a catalogue entailing such a vast amount of computation does great credit to the very limited staff of the observatory.

"L'ASTRONOMIE."—The decease of this monthly journal of popular astronomy is announced in the December number. For thirteen years M. Flammarion has conducted *L'Astronomie*, and has used it to popularise, and extend the study of, astronomical science, and now it dies from "difficultés d'administration." The Société Astronomique de France proposes to attempt to fill the gap by issuing their *Bulletin* monthly instead of quarterly, as heretofore.

### ON THE USE OF THE GLOBE IN THE STUDY OF CRYSTALLOGRAPHY.

IN modern treatises on crystallography, the crystal is imagined projected radially on the surface of a sphere, and the spherical triangles so obtained are dealt with by spherical trigonometry. Problems in astronomy and mathematical geography are also commonly dealt with by the methods of spherical trigonometry. But they can also be dealt with completely by the method of graphical construction on the surface of a sphere where the angles and arcs are directly measured with a divided circle; and the use of spherical trigonometry is dispensed with. Many years ago it occurred to the author that what eliminated the use of spherical trigonometry in the one case might eliminate it in the others; hence the idea of the use of the globe in the study of crystallography. Various arrangements of globe and circles were described and exhibited. The usual method of mounting globes on a polar axis, round which it can revolve inside a metal meridian, supported in its turn at right angles to a horizontal circle or equator, was found to be inconvenient. It is necessary to be able to reach every part of the globe, and to have it steady for drawing, and the fixed circle and axes stand greatly in the way of this. The instrument found most generally useful was a black globe, after a certain system of brass circles, divided into degrees, which can be applied directly and exactly to any part of its surface. The system of brass circles is called the *goniometer*, invented by Captain Aved de Magnac, of the French Navy, and published by L. Bertaux, of Paris. With this instrument every problem in the geometry of crystals can be solved with ease and accuracy by graphic construction alone. The various manipulations occurring in the use of the globes were described and illustrated. In the practical determination of a crystal, the inclinations of its faces are observed with the goniometer. From these observations, treated usually by the methods of spherical trigonometry, the elements of the crystal, namely, the inclination of its axes and the proportion of its parameters, are deduced. The process is then reversed, and the elements found are assumed, and from them the inclinations of the faces are calculated. The usefulness of the globe was illustrated by demonstrating how these two processes can be carried out by simple graphical construction. On the globe, the face of a crystal is represented by its pole, or the point where the radius of the sphere, which is perpendicular to the face, pierces the surface of the sphere. The angle between two faces, measured by the goniometer, is the angle contained between their normals. It is therefore ready to be transferred directly to the globe on which it is entered as an arc. In doing so, any point on the globe is taken as the pole of the face from which a start is made. From this a great circle is drawn in any direction. When the first angle has been measured on the goniometer, it is laid off on the globe as an arc, of an equal number of degrees, along this great circle, and from the initial fixed point. The poles of the first pair of faces are situated at the extremities of this arc, which becomes the *base line* of the survey of the crystal. By triangulation from it, the angles being supplied by the goniometer, the positions of the poles of all the faces are placed as points on the globe. The intersection of a face with the surface of the globe is a circle, which may be described on it with a pair of compasses, taking the pole of the face as centre. The circles in which any two faces, which are not parallel, meet the sphere, cut each other in two points. If these points be joined by the arc of a great circle, we obtain the projection of the edge which the two faces make on one another. It is perpendicular to the great circle passing through the poles of the two faces. If it be carried parallel to itself to the centre of the sphere, it coincides with a diameter, or the poles are indicated by points on the globe. When the operation has been repeated with all the faces, we have a set of intersecting points on the globe, which recognises the edges occurring in the crystal. If the circles, intersecting with the surface of the sphere, of any three faces, not in the same zone, be considered, the arcs connecting each pair of their centres meet in a point which is the projection of the line of intersection of the three faces which meet there. A third group of points, representing corners, is obtained on the globe, and the characteristics of the crystal are exhausted.

If the corners be carried parallel to themselves to the centre, they find themselves already represented by the intersections of the diameters representing their edges. If the similar poles of any such group of diameters be connected by arcs of great circles, a spherical triangle or polygon is marked out, and its area compared with that of a hemisphere is a measure of the corner, just as the arc is the measure of the angle which it subtends. The secondary figures thus described on the surface of the sphere are always different from the primary ones. Thus the corners of the cube, when collected at and radiating from the centre of the sphere, delineate the regular octahedron, which in its turn, when similarly treated, delineates the cube. From this point of view they are reciprocal inversion forms.

Having got a complete projection of it on the globe, the crystal can be studied. It can be referred with equal ease to any system of coordinates and to any number of different systems; it is only necessary to shift the *map* of the crystal over the surface of the globe. In fact, there is now no question touching the geometry of the crystal which cannot be directly answered after making one or more simple measurements; and the distinction between easy questions and difficult ones has almost disappeared.

The projection of the crystal has been constructed from supposed observed angles on the goniometer; but it is equally easy to construct it from its crystallographic specification—that is, the inclination of the axes and the proportion of the parameters.

The projections, of the normals to the faces, or the coordinate planes, are found by constructions on these planes. These positions are marked on the sphere by the points on the coordinate circles where they meet its surface. A great circle drawn through any one point, at right angles to the coordinate circle, contains the pole of the face. It is also contained in another great circle, found in the same way. It is fixed in their point of intersection.

In this way every possible face, permitted by the specification, can be easily and readily placed on the sphere by its representative pole; and the angles between every pair can be at once taken off with a pair of compasses or a tape. In a few minutes a complete catalogue can be made of the angles which each face makes with every other one. The advantage of this is particularly apparent in the oblique systems, which on the globe are dealt with as readily and as easily as those of the regular system.

In conclusion, the author alluded to other uses of the globe, where it does easily, and without fatigue, work which can be done in no other way without great labour; and he pointed out an important indirect advantage, gained by its use, in the education of the sense of direction, which is generally only sparingly developed in the mind.

### THE USE OF SAFETY EXPLOSIVES IN MINES.

A LARGE committee was appointed by the North of England Institute of Mechanical Engineers in 1888, to investigate and report upon the subject of flameless explosives in relation to their degree of safety in mines. Experiments with various explosives and apparatus connected with shot-firing were commenced in 1892 at Hebburn-upon-Tyne, and a number of papers referring to them have been contributed to the Institute's *Transactions*. The first part of the Report of the Committee has just been published, and it clears away many of the doubts and uncertainties connected with the employment of safety explosives in underground workings. Into the details of the experiments we have not space to enter, but the following conclusions deduced from them show the kind of results obtained:—

(1) All the high explosives (ammonite, tucker powder, bel-lite, carbonate, tobrinite, and securite) are less liable than blasting powder to ignite inflammable mixtures of air and fire-damp. These explosives, however, cannot be relied upon as ensuring absolute safety when used at places where inflammable mixtures of air and fire-damp may be present.

(2) The variable results following upon the detonation of high explosives appear to be due in some measure to defective admixture of, or variation in the proportions of, the ingredients used in the manufacture of the explosive.

In view of the changes from time to time made in the pro-

Fig. 1. G. Fig. 2. G. Fig. 3. G. Fig. 4. G. Fig. 5. G. Fig. 6. G. Fig. 7. G. Fig. 8. G. Fig. 9. G. Fig. 10. G. Fig. 11. G. Fig. 12. G. Fig. 13. G. Fig. 14. G. Fig. 15. G. Fig. 16. G. Fig. 17. G. Fig. 18. G. Fig. 19. G. Fig. 20. G. Fig. 21. G. Fig. 22. G. Fig. 23. G. Fig. 24. G. Fig. 25. G. Fig. 26. G. Fig. 27. G. Fig. 28. G. Fig. 29. G. Fig. 30. G. Fig. 31. G. Fig. 32. G. Fig. 33. G. Fig. 34. G. Fig. 35. G. Fig. 36. G. Fig. 37. G. Fig. 38. G. Fig. 39. G. Fig. 40. G. Fig. 41. G. Fig. 42. G. Fig. 43. G. Fig. 44. G. Fig. 45. G. Fig. 46. G. Fig. 47. G. Fig. 48. G. Fig. 49. G. Fig. 50. G. Fig. 51. G. Fig. 52. G. Fig. 53. G. Fig. 54. G. Fig. 55. G. Fig. 56. G. Fig. 57. G. Fig. 58. G. Fig. 59. G. Fig. 60. G. Fig. 61. G. Fig. 62. G. Fig. 63. G. Fig. 64. G. Fig. 65. G. Fig. 66. G. Fig. 67. G. Fig. 68. G. Fig. 69. G. Fig. 70. G. Fig. 71. G. Fig. 72. G. Fig. 73. G. Fig. 74. G. Fig. 75. G. Fig. 76. G. Fig. 77. G. Fig. 78. G. Fig. 79. G. Fig. 80. G. Fig. 81. G. Fig. 82. G. Fig. 83. G. Fig. 84. G. Fig. 85. G. Fig. 86. G. Fig. 87. G. Fig. 88. G. Fig. 89. G. Fig. 90. G. Fig. 91. G. Fig. 92. G. Fig. 93. G. Fig. 94. G. Fig. 95. G. Fig. 96. G. Fig. 97. G. Fig. 98. G. Fig. 99. G. Fig. 100. G. Fig. 101. G. Fig. 102. G. Fig. 103. G. Fig. 104. G. Fig. 105. G. Fig. 106. G. Fig. 107. G. Fig. 108. G. Fig. 109. G. Fig. 110. G. Fig. 111. G. Fig. 112. G. Fig. 113. G. Fig. 114. G. Fig. 115. G. Fig. 116. G. Fig. 117. G. Fig. 118. G. Fig. 119. G. Fig. 120. G. Fig. 121. G. Fig. 122. G. Fig. 123. G. Fig. 124. G. Fig. 125. G. Fig. 126. G. Fig. 127. G. Fig. 128. G. Fig. 129. G. Fig. 130. G. Fig. 131. G. Fig. 132. G. Fig. 133. G. Fig. 134. G. Fig. 135. G. Fig. 136. G. Fig. 137. G. Fig. 138. G. Fig. 139. G. Fig. 140. G. Fig. 141. G. Fig. 142. G. Fig. 143. G. Fig. 144. G. Fig. 145. G. Fig. 146. G. Fig. 147. G. Fig. 148. G. Fig. 149. G. Fig. 150. G. Fig. 151. G. Fig. 152. G. Fig. 153. G. Fig. 154. G. Fig. 155. G. Fig. 156. G. Fig. 157. G. Fig. 158. G. Fig. 159. G. Fig. 160. G. Fig. 161. G. Fig. 162. G. Fig. 163. G. Fig. 164. G. Fig. 165. G. Fig. 166. G. Fig. 167. G. Fig. 168. G. Fig. 169. G. Fig. 170. G. Fig. 171. G. Fig. 172. G. Fig. 173. G. Fig. 174. G. Fig. 175. G. Fig. 176. G. Fig. 177. G. Fig. 178. G. Fig. 179. G. Fig. 180. G. Fig. 181. G. Fig. 182. G. Fig. 183. G. Fig. 184. G. Fig. 185. G. Fig. 186. G. Fig. 187. G. Fig. 188. G. Fig. 189. G. Fig. 190. G. Fig. 191. G. Fig. 192. G. Fig. 193. G. Fig. 194. G. Fig. 195. G. Fig. 196. G. Fig. 197. G. Fig. 198. G. Fig. 199. G. Fig. 200. G. Fig. 201. G. Fig. 202. G. Fig. 203. G. Fig. 204. G. Fig. 205. G. Fig. 206. G. Fig. 207. G. Fig. 208. G. Fig. 209. G. Fig. 210. G. Fig. 211. G. Fig. 212. G. Fig. 213. G. Fig. 214. G. Fig. 215. G. Fig. 216. G. Fig. 217. G. Fig. 218. G. Fig. 219. G. Fig. 220. G. Fig. 221. G. Fig. 222. G. Fig. 223. G. Fig. 224. G. Fig. 225. G. Fig. 226. G. Fig. 227. G. Fig. 228. G. Fig. 229. G. Fig. 230. G. Fig. 231. G. Fig. 232. G. Fig. 233. G. Fig. 234. G. Fig. 235. G. Fig. 236. G. Fig. 237. G. Fig. 238. G. Fig. 239. G. Fig. 240. G. Fig. 241. G. Fig. 242. G. Fig. 243. G. Fig. 244. G. Fig. 245. G. Fig. 246. G. Fig. 247. G. Fig. 248. G. Fig. 249. G. Fig. 250. G. Fig. 251. G. Fig. 252. G. Fig. 253. G. Fig. 254. G. Fig. 255. G. Fig. 256. G. Fig. 257. G. Fig. 258. G. Fig. 259. G. Fig. 260. G. Fig. 261. G. Fig. 262. G. Fig. 263. G. Fig. 264. G. Fig. 265. G. Fig. 266. G. Fig. 267. G. Fig. 268. G. Fig. 269. G. Fig. 270. G. Fig. 271. G. Fig. 272. G. Fig. 273. G. Fig. 274. G. Fig. 275. G. Fig. 276. G. Fig. 277. G. Fig. 278. G. Fig. 279. G. Fig. 280. G. Fig. 281. G. Fig. 282. G. Fig. 283. G. Fig. 284. G. Fig. 285. G. Fig. 286. G. Fig. 287. G. Fig. 288. G. Fig. 289. G. Fig. 290. G. Fig. 291. G. Fig. 292. G. Fig. 293. G. Fig. 294. G. Fig. 295. G. Fig. 296. G. Fig. 297. G. Fig. 298. G. Fig. 299. G. Fig. 300. G. Fig. 301. G. Fig. 302. G. Fig. 303. G. Fig. 304. G. Fig. 305. G. Fig. 306. G. Fig. 307. G. Fig. 308. G. Fig. 309. G. Fig. 310. G. Fig. 311. G. Fig. 312. G. Fig. 313. G. Fig. 314. G. Fig. 315. G. Fig. 316. G. Fig. 317. G. Fig. 318. G. Fig. 319. G. Fig. 320. G. Fig. 321. G. Fig. 322. G. Fig. 323. G. Fig. 324. G. Fig. 325. G. Fig. 326. G. Fig. 327. G. Fig. 328. G. Fig. 329. G. Fig. 330. G. Fig. 331. G. Fig. 332. G. Fig. 333. G. Fig. 334. G. Fig. 335. G. Fig. 336. G. Fig. 337. G. Fig. 338. G. Fig. 339. G. Fig. 340. G. Fig. 341. G. Fig. 342. G. Fig. 343. G. Fig. 344. G. Fig. 345. G. Fig. 346. G. Fig. 347. G. Fig. 348. G. Fig. 349. G. Fig. 350. G. Fig. 351. G. Fig. 352. G. Fig. 353. G. Fig. 354. G. Fig. 355. G. Fig. 356. G. Fig. 357. G. Fig. 358. G. Fig. 359. G. Fig. 360. G. Fig. 361. G. Fig. 362. G. Fig. 363. G. Fig. 364. G. Fig. 365. G. Fig. 366. G. Fig. 367. G. Fig. 368. G. Fig. 369. G. Fig. 370. G. Fig. 371. G. Fig. 372. G. Fig. 373. G. Fig. 374. G. Fig. 375. G. Fig. 376. G. Fig. 377. G. Fig. 378. G. Fig. 379. G. Fig. 380. G. Fig. 381. G. Fig. 382. G. Fig. 383. G. Fig. 384. G. Fig. 385. G. Fig. 386. G. Fig. 387. G. Fig. 388. G. Fig. 389. G. Fig. 390. G. Fig. 391. G. Fig. 392. G. Fig. 393. G. Fig. 394. G. Fig. 395. G. Fig. 396. G. Fig. 397. G. Fig. 398. G. Fig. 399. G. Fig. 400. G. Fig. 401. G. Fig. 402. G. Fig. 403. G. Fig. 404. G. Fig. 405. G. Fig. 406. G. Fig. 407. G. Fig. 408. G. Fig. 409. G. Fig. 410. G. Fig. 411. G. Fig. 412. G. Fig. 413. G. Fig. 414. G. Fig. 415. G. Fig. 416. G. Fig. 417. G. Fig. 418. G. Fig. 419. G. Fig. 420. G. Fig. 421. G. Fig. 422. G. Fig. 423. G. Fig. 424. G. Fig. 425. G. Fig. 426. G. Fig. 427. G. Fig. 428. G. Fig. 429. G. Fig. 430. G. Fig. 431. G. Fig. 432. G. Fig. 433. G. Fig. 434. G. Fig. 435. G. Fig. 436. G. Fig. 437. G. Fig. 438. G. Fig. 439. G. Fig. 440. G. Fig. 441. G. Fig. 442. G. Fig. 443. G. Fig. 444. G. Fig. 445. G. Fig. 446. G. Fig. 447. G. Fig. 448. G. Fig. 449. G. Fig. 450. G. Fig. 451. G. Fig. 452. G. Fig. 453. G. Fig. 454. G. Fig. 455. G. Fig. 456. G. Fig. 457. G. Fig. 458. G. Fig. 459. G. Fig. 460. G. Fig. 461. G. Fig. 462. G. Fig. 463. G. Fig. 464. G. Fig. 465. G. Fig. 466. G. Fig. 467. G. Fig. 468. G. Fig. 469. G. Fig. 470. G. Fig. 471. G. Fig. 472. G. Fig. 473. G. Fig. 474. G. Fig. 475. G. Fig. 476. G. Fig. 477. G. Fig. 478. G. Fig. 479. G. Fig. 480. G. Fig. 481. G. Fig. 482. G. Fig. 483. G. Fig. 484. G. Fig. 485. G. Fig. 486. G. Fig. 487. G. Fig. 488. G. Fig. 489. G. Fig. 490. G. Fig. 491. G. Fig. 492. G. Fig. 493. G. Fig. 494. G. Fig. 495. G. Fig. 496. G. Fig. 497. G. Fig. 498. G. Fig. 499. G. Fig. 500. G. Fig. 501. G. Fig. 502. G. Fig. 503. G. Fig. 504. G. Fig. 505. G. Fig. 506. G. Fig. 507. G. Fig. 508. G. Fig. 509. G. Fig. 510. G. Fig. 511. G. Fig. 512. G. Fig. 513. G. Fig. 514. G. Fig. 515. G. Fig. 516. G. Fig. 517. G. Fig. 518. G. Fig. 519. G. Fig. 520. G. Fig. 521. G. Fig. 522. G. Fig. 523. G. Fig. 524. G. Fig. 525. G. Fig. 526. G. Fig. 527. G. Fig. 528. G. Fig. 529. G. Fig. 530. G. Fig. 531. G. Fig. 532. G. Fig. 533. G. Fig. 534. G. Fig. 535. G. Fig. 536. G. Fig. 537. G. Fig. 538. G. Fig. 539. G. Fig. 540. G. Fig. 541. G. Fig. 542. G. Fig. 543. G. Fig. 544. G. Fig. 545. G. Fig. 546. G. Fig. 547. G. Fig. 548. G. Fig. 549. G. Fig. 550. G. Fig. 551. G. Fig. 552. G. Fig. 553. G. Fig. 554. G. Fig. 555. G. Fig. 556. G. Fig. 557. G. Fig. 558. G. Fig. 559. G. Fig. 560. G. Fig. 561. G. Fig. 562. G. Fig. 563. G. Fig. 564. G. Fig. 565. G. Fig. 566. G. Fig. 567. G. Fig. 568. G. Fig. 569. G. Fig. 570. G. Fig. 571. G. Fig. 572. G. Fig. 573. G. Fig. 574. G. Fig. 575. G. Fig. 576. G. Fig. 577. G. Fig. 578. G. Fig. 579. G. Fig. 580. G. Fig. 581. G. Fig. 582. G. Fig. 583. G. Fig. 584. G. Fig. 585. G. Fig. 586. G. Fig. 587. G. Fig. 588. G. Fig. 589. G. Fig. 590. G. Fig. 591. G. Fig. 592. G. Fig. 593. G. Fig. 594. G. Fig. 595. G. Fig. 596. G. Fig. 597. G. Fig. 598. G. Fig. 599. G. Fig. 600. G. Fig. 601. G. Fig. 602. G. Fig. 603. G. Fig. 604. G. Fig. 605. G. Fig. 606. G. Fig. 607. G. Fig. 608. G. Fig. 609. G. Fig. 610. G. Fig. 611. G. Fig. 612. G. Fig. 613. G. Fig. 614. G. Fig. 615. G. Fig. 616. G. Fig. 617. G. Fig. 618. G. Fig. 619. G. Fig. 620. G. Fig. 621. G. Fig. 622. G. Fig. 623. G. Fig. 624. G. Fig. 625. G. Fig. 626. G. Fig. 627. G. Fig. 628. G. Fig. 629. G. Fig. 630. G. Fig. 631. G. Fig. 632. G. Fig. 633. G. Fig. 634. G. Fig. 635. G. Fig. 636. G. Fig. 637. G. Fig. 638. G. Fig. 639. G. Fig. 640. G. Fig. 641. G. Fig. 642. G. Fig. 643. G. Fig. 644. G. Fig. 645. G. Fig. 646. G. Fig. 647. G. Fig. 648. G. Fig. 649. G. Fig. 650. G. Fig. 651. G. Fig. 652. G. Fig. 653. G. Fig. 654. G. Fig. 655. G. Fig. 656. G. Fig. 657. G. Fig. 658. G. Fig. 659. G. Fig. 660. G. Fig. 661. G. Fig. 662. G. Fig. 663. G. Fig. 664. G. Fig. 665. G. Fig. 666. G. Fig. 667. G. Fig. 668. G. Fig. 669. G. Fig. 670. G. Fig. 671. G. Fig. 672. G. Fig. 673. G. Fig. 674. G. Fig. 675. G. Fig. 676. G. Fig. 677. G. Fig. 678. G. Fig. 679. G. Fig. 680. G. Fig. 681. G. Fig. 682. G. Fig. 683. G. Fig. 684. G. Fig. 685. G. Fig. 686. G. Fig. 687. G. Fig. 688. G. Fig. 689. G. Fig. 690. G. Fig. 691. G. Fig. 692. G. Fig. 693. G. Fig. 694. G. Fig. 695. G. Fig. 696. G. Fig. 697. G. Fig. 698. G. Fig. 699. G. Fig. 700. G. Fig. 701. G. Fig. 702. G. Fig. 703. G. Fig. 704. G. Fig. 705. G. Fig. 706. G. Fig. 707. G. Fig. 708. G. Fig. 709. G. Fig. 710. G. Fig. 711. G. Fig. 712. G. Fig. 713. G. Fig. 714. G. Fig. 715. G. Fig. 716. G. Fig. 717. G. Fig. 718. G. Fig. 719. G. Fig. 720. G. Fig. 721. G. Fig. 722. G. Fig. 723. G. Fig. 724. G. Fig. 725. G. Fig. 726. G. Fig. 727. G. Fig. 728. G. Fig. 729. G. Fig. 730. G. Fig. 731. G. Fig. 732. G. Fig. 733. G. Fig. 734. G. Fig. 735. G. Fig. 736. G. Fig. 737. G. Fig. 738. G. Fig. 739. G. Fig. 740. G. Fig. 741. G. Fig. 742. G. Fig. 743. G. Fig. 744. G. Fig. 745. G. Fig. 746. G. Fig. 747. G. Fig. 748. G. Fig. 749. G. Fig. 750. G. Fig. 751. G. Fig. 752. G. Fig. 753. G. Fig. 754. G. Fig. 755. G. Fig. 756. G. Fig. 757. G. Fig. 758. G. Fig. 759. G. Fig. 760. G. Fig. 761. G. Fig. 762. G. Fig. 763. G. Fig. 764. G. Fig. 765. G. Fig. 766. G. Fig. 767. G. Fig. 768. G. Fig. 769. G. Fig. 770. G. Fig. 771. G. Fig. 772. G. Fig. 773. G. Fig. 774. G. Fig. 775. G. Fig. 776. G. Fig. 777. G. Fig. 778. G. Fig. 779. G. Fig. 780. G. Fig. 781. G. Fig. 782. G. Fig. 783. G. Fig. 784. G. Fig. 785. G. Fig. 786. G. Fig. 787. G. Fig. 788. G. Fig. 789. G. Fig. 790. G. Fig. 791. G. Fig. 792. G. Fig. 793. G. Fig. 794. G. Fig. 795. G. Fig. 796. G. Fig. 797. G. Fig. 798. G. Fig. 799. G. Fig. 800. G. Fig. 801. G. Fig. 802. G. Fig. 803. G. Fig. 804. G. Fig. 805. G. Fig. 806. G. Fig. 807. G. Fig. 808. G. Fig. 809. G. Fig. 810. G. Fig. 811. G. Fig. 812. G. Fig. 813. G. Fig. 814. G. Fig. 815. G. Fig. 816. G. Fig. 817. G. Fig. 818. G. Fig. 819. G. Fig. 820. G. Fig. 821. G. Fig. 822. G. Fig. 823. G. Fig. 824. G. Fig. 825. G. Fig. 826. G. Fig. 827. G. Fig. 828. G. Fig. 829. G. Fig. 830. G. Fig. 831. G. Fig. 832. G. Fig. 833. G. Fig. 834. G. Fig. 835. G. Fig. 836. G. Fig. 837. G. Fig. 838. G. Fig. 839. G. Fig. 840. G. Fig. 841. G. Fig. 842. G. Fig. 843. G. Fig. 844. G. Fig. 845. G. Fig. 846. G. Fig. 847. G. Fig. 848. G. Fig. 849. G. Fig. 850. G. Fig. 851. G. Fig. 852. G. Fig. 853. G. Fig. 854. G. Fig. 855. G. Fig. 856. G. Fig. 857. G. Fig. 858. G. Fig. 859. G. Fig. 860. G. Fig. 861. G. Fig. 862. G. Fig. 863. G. Fig. 864. G. Fig. 865. G. Fig. 866. G. Fig. 867. G. Fig. 868. G. Fig. 869. G. Fig. 870. G. Fig. 871. G. Fig. 872. G. Fig. 873. G. Fig. 874. G. Fig. 875. G. Fig. 876. G. Fig. 877. G. Fig. 878. G. Fig. 879. G. Fig. 880. G. Fig. 881. G. Fig. 882. G. Fig. 883. G. Fig. 884. G. Fig. 885. G. Fig. 886. G. Fig. 887. G. Fig. 888. G. Fig. 889. G. Fig. 890. G. Fig. 891. G. Fig. 892. G. Fig. 893. G. Fig. 894. G. Fig. 895. G. Fig. 896. G. Fig. 897. G. Fig. 898. G. Fig. 899. G. Fig. 900. G. Fig. 901. G. Fig. 902. G. Fig. 903. G. Fig. 904. G. Fig. 905. G. Fig. 906. G. Fig. 907. G. Fig. 908. G. Fig. 909. G. Fig. 910. G. Fig. 911. G. Fig. 912. G. Fig. 913. G. Fig. 914. G. Fig. 915. G. Fig. 916. G. Fig. 917. G. Fig. 918. G. Fig. 919. G. Fig. 920. G. Fig. 921. G. Fig. 922. G. Fig. 923. G. Fig. 924. G. Fig. 925. G. Fig. 926. G. Fig. 927. G. Fig. 928. G. Fig. 929. G. Fig. 930. G. Fig. 931. G. Fig. 932. G. Fig. 933. G. Fig. 934. G. Fig. 935. G. Fig. 936. G. Fig. 937. G. Fig. 938. G. Fig. 939. G. Fig. 940. G. Fig. 941. G. Fig. 942. G. Fig. 943. G. Fig. 944. G. Fig. 945. G. Fig. 946. G. Fig. 947. G. Fig. 948. G. Fig. 949. G. Fig. 950. G. Fig. 951. G. Fig. 952. G. Fig. 953. G. Fig. 954. G. Fig. 955. G. Fig. 956. G. Fig. 957. G. Fig. 958. G. Fig. 959. G. Fig. 960. G. Fig. 961. G. Fig. 962. G. Fig. 963. G. Fig. 964. G. Fig. 965. G. Fig. 966. G. Fig. 967. G. Fig. 968. G. Fig. 969. G. Fig. 970. G. Fig. 971. G. Fig. 972. G. Fig. 973. G. Fig. 974. G. Fig. 975. G. Fig. 976. G. Fig. 977. G. Fig. 978. G. Fig. 979. G. Fig. 980. G. Fig. 981. G. Fig. 982. G. Fig. 983. G. Fig. 984. G. Fig. 985. G. Fig. 986. G. Fig. 987. G. Fig. 988. G. Fig. 989. G. Fig. 990. G. Fig. 991. G. Fig. 992. G. Fig. 993. G. Fig. 994. G. Fig. 995. G. Fig. 996. G. Fig. 997. G. Fig. 998. G. Fig. 999. G. Fig. 1000. G. Fig. 1001. G. Fig. 1002. G. Fig. 1003. G. Fig. 1004. G. Fig. 1005. G. Fig. 1006. G. Fig. 1007. G. Fig. 1008. G. Fig. 1009. G. Fig. 1010. G. Fig. 1011. G. Fig. 1012. G. Fig. 1013. G. Fig. 1014. G. Fig. 1015. G. Fig. 1016. G. Fig. 1017. G. Fig. 1018. G. Fig. 1019. G. Fig. 1020. G. Fig. 1021. G. Fig. 1022. G. Fig. 1023. G. Fig. 1024. G. Fig. 1025. G. Fig. 1026. G. Fig. 1027. G. Fig. 1028. G. Fig. 1029. G. Fig. 1030. G. Fig. 1031. G. Fig. 1032. G. Fig. 1033. G. Fig. 1034. G. Fig. 1035. G. Fig. 1036. G. Fig. 1037. G. Fig. 1038. G. Fig. 1039. G. Fig. 1040. G. Fig. 1041. G. Fig. 1042. G. Fig. 1043. G. Fig. 1044. G. Fig. 1045. G. Fig. 1046. G. Fig. 1047. G. Fig. 1048. G. Fig. 1049. G. Fig. 1050. G. Fig. 1051. G. Fig. 1052. G. Fig. 1053. G. Fig. 1054. G. Fig. 1055. G. Fig. 1056. G. Fig. 1057. G. Fig. 1058. G. Fig. 1059. G. Fig. 1060. G. Fig. 1061. G. Fig. 1062. G. Fig. 1063. G. Fig. 1064. G. Fig. 1065. G. Fig. 1066. G. Fig. 1067. G. Fig. 1068. G. Fig. 1069. G. Fig. 1070. G. Fig. 1071. G. Fig. 1072. G. Fig. 1073. G. Fig. 1074. G. Fig. 1075. G. Fig. 1076. G. Fig. 1077. G. Fig. 1078. G. Fig. 1079. G. Fig. 1080. G. Fig. 1081. G. Fig. 1082. G. Fig. 1083. G. Fig. 1084. G. Fig. 1085. G. Fig. 1086. G. Fig. 1087. G. Fig. 1088. G. Fig. 1089. G. Fig. 1090. G. Fig. 1091. G. Fig. 1092. G. Fig. 1093. G. Fig. 1094. G. Fig. 1095. G. Fig. 1096. G. Fig. 1097. G. Fig. 1098. G. Fig. 1099. G. Fig. 1100. G. Fig. 1101. G. Fig. 1102. G. Fig. 1103. G. Fig. 1104.

portions and constituents of high explosives, it seems desirable that this information should be afforded by the manufacturers to the users of the explosive.

(3) In the storage of high explosives, it is desirable that every care should be taken to insure their being maintained in a proper condition. It is also certain that these explosives alter in character with age.

(4) It is essential that similar examinations of the working-places and precautions which are in force in mines where blasting-powder is used, should be rigidly observed when a high explosive is employed.

(5) In selecting a high explosive for use in a mine, it should not be forgotten that the risk of explosion is only lessened and not abolished by its use.

(6) All of the high explosives on detonation produce evident flame.

(7) The emission of flame from a blown out shot of a detonated high explosive is not prevented by the quantity or length of stemming used.

(8) In the case of a charge of a high explosive which has missed fire, if a short length of stemming (proved up to 8 inches) has been employed, the charge can be detonated by another cartridge of the explosive and additional stemming being placed in the hole in front of the original stemming.

The experiments were carried out under the direction of Mr. J. L. Hedley, H.M. Inspector of Mines, and Mr. A. C. Kayll, the Engineer to the Committee.

The sincere thanks of mining engineers are due to the Institute for bearing the great expense involved by the experiments, and to the many mining companies, associations, and private firms that have rendered valuable assistance in the matter.

**THE UPSALA MEETING OF THE INTERNATIONAL METEOROLOGICAL COMMITTEE.**

AT the meetings of the International Meteorological Committee, held at the University of Upsala, in August, the secretary submitted a brief report, with the questions proposed for discussion. A statement of these, with the decisions, follows:—

*International Bureau.*—A report was presented by Prof. Hildebrandsson, in which the functions and cost of such a bureau were considered. The committee decided against its establishment.

*Agricultural Meteorology.*—Upon the proposition of Mr. Scott, it was decided that the methods employed to distribute weather predictions to farmers, and the results of climatological discussions relating to the crops in the various countries, be published.

*Establishment of Stations for Cloud Observations.*—Prof. Hildebrandsson presented a pamphlet containing a detailed account of the principal methods employed in these investigations. The committee adopted these resolutions:—

Since experience shows that the altitude of clouds can be easily determined with sufficient accuracy, the generalisation of these investigations in all countries is recommended, preferably by the use of the photographic process. Observations of direction and relative velocity should be made at as many stations as possible, and measures of height at a limited number of suitably distributed stations.

The value of these investigations would be greatly increased if made at the same epoch, therefore it is proposed that they be commenced May 1, 1896, and continued for one year.

The stations already promised are situated in Batavia, France, Norway, Portugal, Prussia, Rumania, Russia, Sweden, United States: Blue Hill, and Weather Bureau (six stations).

*Cloud Atlas.*—The committee appointed at Munich reported slightly modified definitions of some types in the Hildebrandsson-Koppen-Neumayer Atlas, and submitted photographs and pastels for reproduction in the new atlas, as well as instructions for observing clouds. These were adopted by the Permanent Committee after discussion and modification. (See subjoined report.) A special committee, composed of M. Teisserenc de Bort and Prof. Riggenbach, with Prof. Hildebrandsson as chairman, was appointed to publish the atlas, and the choice of the colour of each plate, to represent

as nearly as possible the natural conditions, was left to its discretion.

*More Rapid Transmission of Telegrams.*—Dr. Snellen presented a joint report with Dr. Neumayer on this question, in which the necessity of giving the meteorological dispatches precedence over others, by opening a circuit system with the other central bureaus, was urged. The introduction of simultaneous observations in the various countries was deemed necessary. The committee referred the matter to the International Telegraphic Bureau at Berne.

In more or less intimate relation with this question was a proposition by Dr. van Bebbler, on the importance of further experiments in tele-meteorography. Dr. Snellen explained the telegraphic transmission of the traces of self-recording instruments by the Olland apparatus, which operates over a short distance at Utrecht.

*Scintillation of Stars.*—At the request of M. Ch. Dufour, this question, which had been the object of investigations by M. Montigny, of Brussels, was brought before the committee. Further study by him, together with that of M. Ventosa, on the atmospheric movements observed around stars, was encouraged.

*Maritime Meteorology.*—A proposition of the Russian Admiral Makaroff, on the necessity of an international convention to arrange for the discussion of the data contained in ships' logs, was not approved.

*Psychrometric Observations below Freezing.*—This question was introduced by Profs. Hildebrandsson and Mohn. The employment of Ekholm's method for the reduction of mean values was recommended, but a report of further investigations was requested.

*Exploration of Upper Air.*—A resolution received from the *Congrès de la Science de l'Atmosphère*, which had recently met in Antwerp, on the importance of the balloon ascents now being made at Berlin for meteorological purposes, was confirmed in a more general sense.

*Next Congress.*—It was decided to convene a non-official congress at Paris in September 1896.

**THE CLASSIFICATION OF CLOUDS.**

In the cloud classification of Hildebrandsson and Abercromby, published in the Hildebrandsson-Koppen-Neumayer Atlas, in 1890, the word "diurnal" is added to the definition of Group D, so that it becomes:—

D. Clouds formed by the diurnal ascending currents. In this way, the cumulus arising from a mass of aqueous vapour ascending through calm air is distinguished from the nimbus caused by the general ascension of the whole mass of moist air.

With this change the classification of the ten principal forms is:—

- (a) Detached or rounded forms (most frequent in dry weather).
- (b) Wide-spread or veil-like forms (wet weather).
- A. Highest clouds, mean height 9000 metres.
  - (a) 1. Cirrus.
  - (b) 2. Cirro-stratus.
- B. Clouds of mean altitude, 3000-7000 metres.
  - (a) 3. Cirro-cumulus.
  - (b) 4. Alto-cumulus.
  - (c) 5. Alto-stratus.
- C. Low clouds: 1000-2000 metres.
  - (a) 6. Strato-cumulus.
  - (b) 7. Nimbus.
- D. Clouds formed by the diurnal ascending currents.
  - 8. Cumulus. Top, 1800 metres; base, 1400 metres.
  - 9. Cumulo-nimbus. Top, 3000-5000 metres; base, 1400 metres.
- E. Elevated fog, below 1000 metres.
  - 10. Stratus.

N.B. As the heights of the clouds marked \* do not agree with the heights of these clouds found at Blue Hill, Mr. Kotch has asked that the altitude of the low clouds be placed below 2000 metres simply, instead of between 1000 and 2000 metres, since the bases of nimbus are frequently below 1000 metres; and also that the superior limit of the tops of the cumulo-nimbus be raised to 8000 metres.

The following are descriptions of the clouds, modified from those in the Hildebrandsson-Koppen-Neumayer Atlas.

\* Extracted from a report by Mr. A. Lawrence Kotch, in the December number of the *American Meteorological Journal*.

(1) *Cirrus* (Ci).—Isolated feathery clouds of fine fibrous texture, generally of a white colour. Frequently arranged in bands which spread like the meridians on a celestial globe over a part of the sky, and converge in perspective towards one or two opposite points of the horizon. (In the formation of such bands, Ci. S. and Ci. Cu. often take part.)

(2) *Cirro-stratus* (Ci. S.).—Fine whitish veil, sometimes indistinct, giving a whitish appearance to the sky, and called by many cirrus haze, sometimes of more or less distinct structure, exhibiting confused lines. The veil often produces halos around the sun and moon.

(3) *Cirrus-cumulus* (Ci. Cu.).—Fleecy cloud. Small white balls and wisps without shadows, or with very faint shadows, which are arranged in groups and often in rows.

(4) *Alto-cumulus* (Al. Cu.).—Dense fleecy cloud. Larger whitish or greyish balls with shaded portions, grouped in flocks or rows, frequently so close together that their edges meet. The different balls are generally larger and more compact (passing into S. Cu.) towards the centre of the group, and more delicate and wispy (passing into Ci. Cu.) on its edges. They are very frequently arranged in stripes in one or two directions.

(The term *cumulo-cirrus* is given up as causing confusion.)  
(5) *Alto-stratus* (Al. S.).—Thick veil of a grey or bluish colour, extending in the vicinity of the sun and moon a brighter portion, at which, without causing halos, may produce coronæ. This form shows a gradual transition to cirro-stratus, but, according to the measurements made at Upsala, has only half the altitude.

(The term *stratus-cirrus* is abandoned as giving rise to confusion.)

(6) *Strato-cumulus* (S. Cu.).—Large balls or rolls of dark cloud which frequently cover the whole sky, especially in winter, and give it at times a wave-like appearance. The stratum of strato-cumulus is usually not very thick, and blue sky often appears in the breaks through it. Between this form and the alto-cumulus, all possible gradations are found. They are distinguished from nimbus by the ball-like or rolled form, and because they do not tend to bring rain.

(7) *Nimbus* (N.).—Rain clouds. Dense masses of dark formless clouds with ragged edges, from which generally continuous rain or snow is falling. Through the breaks in these clouds there is almost always seen a high sheet of cirro-stratus or alto-stratus. If the mass of nimbus is torn up into smaller patches, or if smaller clouds are floating very much below a great nimbus, the former may be called *Fracto-nimbus* ("Scud" of the sailors).

(8) *Cumulus* (Cu.).—Piled clouds. Thick clouds whose summits are domes with protuberances, but whose bases are flat. These clouds appear to form in a diurnal ascensional movement which is almost always apparent. When the cloud is opposite the sun, the surfaces which are usually seen by the observer are more brilliant than the edges of the protuberances. When the illumination comes from the side, this cloud shows a strong central shadow; on the sunny side of the sky, however, it appears to be with bright edges. The true cumulus shows a sharp lower or a dove and a glow. It is often torn by strong winds, and the detached parts (*Fracto-cumulus*) present continual changes.

(9) *Storm-Nimbus* (Cu. N.).—Thunder cloud; shower cloud. The system of clouds, rising like mountains, towers, or anvils, generally surrounded at the top by a veil or screen of fibrous texture ("false cirrus"), and below by nimbus-like masses of clouds. From their base generally fall local showers of rain or snow, and sometimes hail or sleet. The upper edges are either of compact rain-like outline, and form immense summits, or are hollowed out into false cirrus, or the edges themselves are drawn out into curls. This last form is most common in "spring" and "fall." The front of storm clouds of great extent sometimes shows a great white stretching across a portion of the sky, which is uniformly lighter in colour.

(10) *Stratus* (S.).—Flat clouds; a horizontal stratum. When this stratum is torn by the wind or by mountain summits into irregular fragments, they may be called *Fracto-stratus*.

INSTRUCTIONS FOR OBSERVING CLOUDS.

At each observation there are to be recorded:

1. *The Kind of Cloud*, denoted by the international letters of the cloud name, which may be more exactly defined by giving the number of the picture of the Atlas most nearly representing the observed form.

(2) *The Direction in which the Clouds come*.—If the observer remains completely at rest during a few seconds, the motion of the clouds may be easily observed relatively to a steeple or mast erected in an open space. If the motion of the cloud is very slow, the head must be supported. Clouds should be observed in this way only near the zenith, for if they are too far away from it the perspective may cause errors. In this case nephoscopes should be used, and the rules followed which apply to the particular instrument employed.

(3) *Radiant Point of the Upper Clouds*.—These clouds often appear in the form of fine parallel bands, which, by an effect of perspective, seem to come from one point of the horizon. The radiant point is that point where these bands, or their direction prolonged, meet the horizon. The position of this point on the horizon should be recorded in the same way as the wind direction, north, north-north-east, &c.

(4) *Undulatory Clouds*.—It often happens that the clouds show regular, parallel, and equidistant streaks, like the waves on the surface of water. This is the case for the greater part of the cirro-cumulus, strato-cumulus (roll cumulus), &c. It is important to note the direction of these streaks. When there are apparently two distinct systems, as is to be seen in clouds separated into balls by streaks in two directions, the directions of the two systems should be noted. As far as possible, observations should be made on streaks near the zenith to avoid effects of perspective.

(5) *Density and Position of Cirrus Banks*.—The upper clouds frequently take the form of flat or of a more or less dense veil, which, rising above the horizon, resembles a thin white or greyish bank. As this cloud form has an intimate relation to barometric depressions, it is important to note:—

- 1. The density—
  - 0 meaning very thin and irregular.
  - 1 meaning thin but regular.
  - 2 meaning rather dense.
  - 3 meaning dense.
  - 4 meaning very dense and of dark colour.

(6) *The direction in which the veil or bank appears densest.*

*Remarks*.—All interesting details should be noted, for example:

(1) On summer days all low clouds generally assume particular forms resembling cumulus more or less. In this case, there should be put under *Remarks*, "Stratus or Nimbus Cumuliform."

(2) Sometimes happens that a cumulus has a mammillated lower surface. This appearance should be described by the name of "Mammato-cumulus."

(3) It should always be noted whether the clouds appear stationary, or whether they have a very great velocity.

The text of the Atlas is to be in French, English, and German.

ENDOWMENT FOR SCIENTIFIC RESEARCH AND PUBLICATION.

II.

IMMEDIATELY connected with our colleges and universities is another field, in which additional endowments are greatly needed, viz. for fellowships in science for post-graduate studies.

Upon the post-graduate workers the future of science, and the recruits for future teachers and professors, must necessarily depend. In that view the importance of post-graduate endowments in science can scarcely be magnified. The great majority of the young men from whom all the new recruits must be drawn have little or no pecuniary means. After graduating, often through many difficulties, they must face the question of their future calling. They must consider what promise of a reasonable and comfortable support a life devoted to science affords. If this risk should not deter them, still there are many with talents of a high order who would be absolutely unable to proceed further in the advanced scientific studies necessary to qualify them to enter upon remunerative scientific

Address delivered by Mr. Addison Brown, at a meeting of the Scientific Alliance of New York. Reprinted from Smithsonian Report, 1892.

(Continued from page 177.)



work, or to obtain situations as professors or assistants, except by the aid of substantial endowments for their support, during the three or four years more of necessary assiduous study.

In the stress of modern life, and in the allurements towards more certain pecuniary results, nothing but such endowments can avert the withdrawal from scientific pursuits of many young men of high promise, whose genius and tastes and ambition strongly incline them to science, and who would be secured to it if this temporary support were afforded.

The endowments of our colleges and universities in aid of post-graduate work in science are much less, I suppose, than is commonly imagined. I find no such support for post-graduate work in science, either at Cornell University, at the University of the City of New York, at Brown University, at Amherst, or even at the Johns Hopkins University. No statement of the endowments of the new Clark University at Worcester has as yet been published. Princeton, though having a hundred under-graduate scholarships, has but one post-graduate fellowship for science; Yale but two—the Silliman and the Sloane Fellowships.

Columbia College has two fellowships expressly restricted to science, viz. the Tyndall Fellowship of 648 dols. annually, and the Bernard Fellowship, before referred to, of about 500 dols. annually. Besides these, however, twenty-four general university fellowships have been established, of 500 dols. each, for post-graduate study, of which eighteen are in present operation. About one-third of these are assigned to science; making now eight for science at Columbia, with probably two more in 1893 or 1894. In architecture, moreover, there are three additional noble post-graduate fellowships at Columbia—the Schermerhorn of 1300 dols. annually, and the two McKim Fellowships of 1000 dols. each, to support study in foreign travel. In the Medical Department, also, there are five valuable prizes for proficiency.

The University of Pennsylvania has the Tyndall Fellowship, before referred to; and, in the Department of Hygiene, an admirable laboratory fitted up by Mr. Henry C. Lea, with a fellowship of 10,000 dols. endowed by Mr. Thomas A. Scott, at present applied to original research in bacteriology.

At Harvard, besides the three Bullard Fellowships of 5000 dols. each, established in 1891, to promote original research in the medical school, there are two post-graduate fellowships restricted to science exclusively, namely, the Tyndall Fellowship of about 500 dols. annually, and the income of the recently established Joseph Lovering Fund, the principal of which is now about 8000 dols. There are also eleven other general fellowships, viz. the Parker, the Kirkland, and the Morgan Fellowships, available for promising graduate students in any branch, of which about five have been usually assigned to science. These fellowships give an income of from 450 dols. to 700 dols. a year. Harvard has also forty-six scholarships available for graduate students, varying in income from 150 dols. to 300 dols. each, of which about seventeen are assigned to science. During the last year, according to the report of Prof. Pierce, the Dean, there were 193 applications for those post-graduate fellowships and scholarships, seventy-one of which were in science. Only one-third of the applicants could receive the aid. The Dean adds:

"The number of appointments is still *very inefficient* to meet demands of promising students who wish to enter the graduate school, and are unable to do so without assistance." (Report Harvard Coll. 1891, p. 92.) The tables published by him indicate that a considerable number of those not aided withdrew from science; and that many others who were entered for the first year in the graduate school would, if not aided, afterwards leave. It is gratifying to observe the further fact, so encouraging also for the young graduates who wish, if possible, to enter upon a scientific career, that all who had enjoyed these fellowships for the full term of three years, and did not continue their studies further abroad, at once received honourable positions.

From the above synopsis it appears that in all these colleges (and I know of no other similar fellowships elsewhere) there are only about twenty-six adequately endowed post-graduate fellowships in science. As these should be continued for at least three years, there is provision altogether for only about nine per year—not one-fourth the number required to supply the annual loss in our 150 colleges, to say nothing of the increasing demand through the growth and improvements in the colleges themselves. As it is from such specially trained students that the great professors of the future must be drawn, the need of much greater endowments for new recruits is apparent.

In England the aids afforded by fellowships in their universities are familiar to all. Sir Isaac Newton, who is to modern science what Shakespeare is in literature, was sustained from his student days successively in a scholarship, a fellowship, and as professor at Trinity College at Cambridge. Besides those aids, the Royal Com. missioners of the Exhibition of 1851 instituted in 1891 "Exhibition Science scholarships" for advanced students, to which 25,000 dols. yearly is to be applied in sums of 750 dols. each. In the first year sixteen appointments were made, to be held for two, and probably for three, years by students who show capacity, and "who advance science by experimental work."

On this subject a most interesting discussion took place last year in the French Academy of Sciences. On April 27, 1891, the Secretary read the following extracts from the will of the late M. Cahours, a deceased member of the Academy:

"I have frequently had the opportunity of observing, in the course of my scientific career, that many young men distinguished and endowed with real talent for science, found themselves obliged to abandon it, because before beginning they had no efficacious help which provided them with the first necessities of life, and allowed them to devote themselves exclusively to scientific studies.

"With the object of encouraging such young workers, who for want of sufficient resources had themselves powerless to finish works in course of execution, . . . I bequeath to the Academy of Sciences . . . 100,000 francs, . . . the interest to be distributed yearly by way of encouragement to any young men who have made themselves known by some interesting works, and more particularly by chemical researches: . . . as far as possible to young men without fortune, not having salaried offices, and who, from want of a sufficient situation, would find themselves without the possibility of following up their researches. These pecuniary encouragements ought to be given for several years to the same young men, if the Commissioner thinks their productions have sufficient value: . . . to cease when they shall have other sufficiently remunerative positions."

M. Janssen, then addressing the Academy, said:

"This affords an example to all who hereafter may desire to encourage the sciences by their liberality. M. Cahours, who knew the urgent necessities of science, had, like most of us, become convinced of the need of introducing a new form of scientific recompenses.

"Our prizes will always continue to meet a great and noble necessity. Their value, the difficulty of obtaining them, and the *glad* they take from the illustriousness of the body that grants them, will always make them the highest and most valuable of recompenses. But the value also of the works it is necessary to produce in order to lay claim to them forbids them to beginners. It is a field only accessible to matured talents. But there are many young men endowed with precious aptitudes, inclined to pure science, but turned very often from this envied career by the difficulties of existence, and taking with regret a direction towards more immediate results. And yet many among them possess talents which, if well cultivated, might do honour and good to science. . . . These difficulties are increased every day by the marked advance of the exigencies of life.

"We must find a prompt remedy for this state of things, if we do not wish to see an end of the recruitment of science. This truth is beginning to be generally felt. The Government has already created institutions, scholarships, and encouragements, which partly meet the necessity. Some generous donors are also working in this manner. I will mention specially the noble foundation of Melle. Dosne, in accordance with whose instructions a hall is at this moment being built, where young men, having shown distinguished aptitudes for high administration, for the bar, or for history, will receive for three years all the means of carrying on high and peaceful studies. Let us say, then, plainly (and in speaking thus we only feebly echo the words of the most illustrious members of the Academy), that it is by following the way so nobly opened by Cahours that the interests and prospects of science will be most efficaciously served."

Huxley is said to have once stated that "any country would find it to its interest to spend 100,000 dols. in first *naming* a Faraday, and then putting him in a position where he could do

<sup>1</sup> Sir William Thomson, *Proceedings, Royal Society*, 1874, vol. I, p. 225.

<sup>2</sup> NATURE, May 7, 1891 (vol. xiv, p. 17).

the greatest amount of work." It is the post-graduate endowments that must first find and retain to science the Faradays of the future.

A notable instance of the need and value of such aid is found in the recently-appointed head of a great university, who, by such endowments alone, here and abroad, it is said, was enabled to prosecute his studies for ten years successively, reaching thereby the front rank in his chosen department of philosophy.

### III.

Another department in great need of pecuniary support is that of the learned and scientific societies. In these England is pre-eminent. Our own societies have endeavoured to follow, as far as they could, their English models. The English societies have rendered to science invaluable service in three main lines:

1. In providing ample means for the publication of scientific papers, showing the progress and the results of their scientific work. In this every society has taken part.

2. In the direct maintenance of original research, in which the Royal Institution has been most conspicuous.

3. In the award of prizes for scientific distinction; but still more important, in the distribution of pecuniary aid, for the prosecution of special scientific researches.

1. Of these, I regard publication as, perhaps, the most important; not only because it puts the world in possession of what has been done by investigators, but because the very fact that there are means of publication, is one of the greatest incentives to complete and thorough original scientific work.

Of the English societies the Royal Society is the oldest, having been chartered in 1662. It has published 181 volumes of *Transactions*, and about 50 volumes of *Proceedings*. For these purposes, in 1881 the expenditure was between 11,000 dol. and 12,000 dol. It has property to the value of about two-thirds of a million of dollars, more than half of which is in trust funds, held for scientific uses. The income on the trust funds in 1891 was about 17,500 dol. (*Proceedings*, 1891, vol. 1, p. 235.) In 1828 Dr. Wollaston, in giving it 10,000 dol. in 3 per cent. Consols "to promote scientific researches," charged upon the Society "not to hoard the income parsimoniously, but to expend it liberally for the objects named."

The Royal Institution of Great Britain was founded in 1779, largely through our countryman James Thompson, of Rumbold, Va., afterwards Count Rumford. In 1888 it had property and invested funds for general purposes to the amount of 350,000 dol., and about 50,000 dol. of invested funds for the maintenance of its three professors. In 1887 it expended about 2000 dol. in publications, and it has issued about forty volumes. (*Report*, 1888, p. 13.)

The Linnean Society, now furnished by the Government with permanent accommodation in Burlington House, free of rent, was founded by Sir James E. Smith in 1788, and is devoted to botany and zoology. Its property amounts to about 32,000 dol., but it has no endowed funds for scientific investigation. For some years past its receipts, mainly from contributions, have been about 10,000 dol. a year, of which one-half, about 5000 dol., is spent on its publications, which now number nearly fifty volumes of *Transactions* in quarto, and as many more of *Essays*. In 1888 7,000 dol. were expended in publications. (*Proceedings*, [May 4, 1888], 1890, pp. 15, 45.)

Next in order of time is the British Association for the Advancement of Science, founded in 1831. It is sustained wholly by voluntary contributions. Its invested funds amount to about 62,000 dol. Its income and contributions are about 10,000 dol. annually, of which it appropriates from 6000 dol. to 7000 dol. per annum for the encouragement of scientific investigation, and a further 1800 dol. annually for its yearly volume of *Transactions*. Its publications now number twenty-five volumes. (*Report*, 1891, pp. lxxviii to c. 79.)

The Ray Society was founded in 1844. It was named after the Rev. John Ray, who lived from 1692 until 1705. Haller, himself one of the greatest naturalists of his time, writing in 1771, in the full light of Linnaeus's opinions, Ray "the greatest naturalist within the memory of man" (*1771, p. 1, 1. 1. B. linnæi*). The society has published a number of volumes of scientific works of the highest importance. I have not seen any statistics concerning its means or acquisitions, nor have I found any official report of the scientific work of Edinburgh or Berlin.

Of these societies, only the Royal Institution directly

supports professors for scientific research. It has two laboratories, one chemical and one physical. These were rebuilt in 1872, "in order that original discovery might be more effectively carried on." The society was founded for the declared purpose of "promoting scientific and literary research." It has three professors—one in chemistry, one in physics, and one in physiology. Davy, Faraday, Tyndall, and others who have spent their lives there, have made its annals immortal.

(3) In stimulating research by the appropriation of moneys for specific objects, the Royal Society and the British Association are the chief agencies. Besides some of its own funds, the Royal Society distributes annually £4000, or 20,000 dol., granted by the Government "for the advancement of science." This has been done by applying it to numerous purposes; in 1891, for fifty-seven different scientific objects, in sums ranging from 25 dol. to 3000 dol. each; not confined to natural science alone, but including ethnology and magnetic surveys. Most of the grants were in sums of about 350 dol. or less. (*Proceedings*, 1891, vol. 1, p. 242.)

The British Association has disbursed annually for the last forty years from 6000 dol. to 7000 dol. per annum, upon the same system of dividing it up for numerous specific purposes; usually from thirty to forty objects yearly, the grants being in sums ranging from 25 dol. to 1000 dol. The grants are called for and expended for the specific purpose named, and under the direction of some prominent scientific man. Men of science like Sir William Thomson, and others of like renown, have had the administration of many of these grants. These have included for the last six years (save in 1890) the appropriation of 500 dol. per year for a table in the Naples Marine Laboratory. (*Report*, 1890, p. 90.)

We have no single society in this country, save the Smithsonian, that can rival in importance those that I have named in England. And the Smithsonian is not a society, but an institution, established by one man, and he an Englishman. This institution, based upon the bequest of James Smithson, was founded by act of Congress of August 10, 1846. I doubt whether in any country or in any age the bequest of half a million of dollars has ever been followed by such beneficent results, or has ever so profoundly affected the life of science in any country as the Smithsonian Institution has done in America during the last forty-four years of its existence. This has been owing (1) to the wisdom and the profound scientific insight of Prof. Henry, its first secretary and director; and (2) to the corps of able assistants and successors whom his spirit and policy have inspired. Its publications number 26 quarto volumes of "Contributions to Knowledge," 40 volumes of "Miscellaneous Collections," and 44 volumes of "Annual Reports." Its "Contributions to Knowledge" rival, if they do not excel, in rarity and importance, the publications of any other society during the same period. Its expenditure in publications is about 12,500 dol. a year. Under Prof. Henry a good deal was done in research. Under Prof. Langley, the present director, astro-physical research is carried on. Besides the direct scientific work of the Institution, however, its influence has been very great, especially in its relations with the other departments at Washington, and as a medium for the prosecution of other scientific enterprises under authority of Congress. Many of the appropriations of Congress for scientific expeditions for researches in ethnology, paleontology, chemistry, and physics have been due to the presence and co-operation of the Smithsonian Institution. For ethnologic researches alone during the last twelve years, under the administration of the Smithsonian, Congress has appropriated 400,000 dol.; to paleontologic researches within the last three years, 100,000 dol.; to chemical and physical research, 68,000 dol.; and to astro-physical research, 10,000 dol. Besides these, there have been for many years appropriations for maintaining the important investigations of the Coast and Geodetic Survey, and of the Weather Bureau in Meteorology; and for the great scientific work of the Naval Observatory, and of the various scientific divisions of the Agricultural Department and of the Geological Survey. Our Government has been by no means inactive in science.

The principal American scientific associations, omitting those of comparatively recent origin, are the American Philosophical Society of Philadelphia, originally founded in 1744; the American Academy of Arts and Sciences at Boston; the Boston Society of Natural History; the Academy of Natural Sciences; and the Franklin Institute at Philadelphia, the latter

founded in 1824 (see *Journal*, vol. i, pp. 71, 129); the New York Academy of Sciences (a continuation of the Lyceum of Natural History); the National Academy of Science at Washington, founded in 1863; and the American Association for the Advancement of Science. Of these, the Philosophical Society has published 29 volumes of its *Transactions*; the American Academy, 26 volumes of *Transactions* and 9 quarto volumes of *Memoirs*; the Boston Society of Natural History, 25 volumes, at a cost of about 600 dols. per year; the Academy of Natural Science of Philadelphia, 48 volumes of *Proceedings* and 12 quarto volumes of its *Journal*, at an average cost of about 1000 dols. per year; the Franklin Institute, 133 volumes of its *Journal*; the New York Academy and its predecessor, about 30 volumes of *Transactions* and *Annals*; the National Academy, 3 quarto volumes of *Memoirs* and some volumes of *Proceedings*; and the American Association for the Advancement of Science, about 40 volumes of *Proceedings*.

The latter society had in 1891 a "Research Fund" of 5254 dols. (*Proceedings*, 1891, p. 441.) None of the other societies, so far as I can find, has any fund specially devoted to research, or makes any specific appropriations therefor. The National Academy and the Academy of Philadelphia have each some funds for their support, and the latter also the Jes-up Fund for students in science, on which the income is about 550 dols. yearly. The Philosophical Society from time to time awards the prize established by John Hyacinth de Magellan in 1786—an oval gold plate "for the most useful discovery or invention in navigation or science." One of the earliest awards of this prize was for painting lightning-rods with black lead.

The American Academy of Arts and Sciences awards a gold and silver medal from a bequest of 5000 dols. made to it by Count Rumford, who in 1796 made a similar bequest to the Royal Society. In 1888 this prize was most worthily awarded to Prof. Michelson for his researches in light.<sup>1</sup>

The Boston Society of Natural History has a general fund, of which the income is about 6000 dols. It has also a small Walker prize fund and a grand prize fund, from which in 1884 it awarded a grand prize of 1000 dols. to James Hall, of Albany, "for his distinguished services to science." It also administers the expenditure of about 2700 dols. a year for instruction in laboratory work, drawn from the Boston University, and 1500 dols. from the Lowell Fund for the instruction of teachers.<sup>2</sup>

From this comparison of the voluntary associations, it appears that the property, endowed funds, and equipment of the English societies named are nearly tenfold greater than the American, and their publications double; while for direct original research our societies maintain no laboratories and no professors, as is done by the Royal Institution. The English societies distribute yearly from 25,000 dols. to 30,000 dols. for from sixty to seventy-five different scientific purposes, while ours make no such appropriations, simply because they have no funds. To supply this deficiency there is need of large endowments.

The publications of our societies are valuable; the papers have often been of a high character, rivalling those published abroad. But the funds available for publication are insufficient; it is always a question of means. There are a press and surplus of valuable scientific matter, which either is not printed at all, or only gets printed by special subscriptions for the purpose. This ought not to be. After valuable original matter has been produced with great pains and without hope of pecuniary reward, nothing is more discouraging to future research than that even publication can only be had as a charity. This I know, from repeated personal applications, is the condition of things in New York at this moment. It is not creditable that, in a State and country like ours, there should be practically nowhere adequate provision for even the publication of the researches of those who work for nothing but their love of science and its progress. There is very great need of a considerable publication fund, in the hands of some scientific body, through which every valuable contribution to science, not otherwise provided for, might be ensured a speedy publication, after it has been found worthy, as in the practice of the Linnæan Society, first by a critical expert in the particular department, and then by the council of publication.<sup>3</sup>

The stimulus, moreover, to scientific research that would be imparted by the distribution of comparatively small sums, such

as are given by the Royal Society and by the British Association, would also be very great; nor is there any reason why the founding of professorships for the express purpose of prosecuting original research in our scientific societies, after the model of the Royal Institution, should not in time be followed by results equally brilliant, and equally beneficial to mankind.

I have endeavoured to point out three main directions in which there is urgent need in this country of pecuniary endowments.

(1) In relief of professors during the transition of the colleges from the schoolmaster system to the university system, whereby all professors in science shall become actively enlisted in the prosecution of original discovery as a part of their duties.

(2) In providing for the future recruits in science, by more endowments for post-graduate study.

(3) By endowments of our scientific associations, both directly to promote original research, and especially also to supply larger means of publication.

It is gratifying to perceive what beginnings have been recently made in response to the needs of science. Only a short time since, in 1885, Mrs. Elizabeth Thompson, of Stamford, Conn., gave 25,000 dols. to a board of trustees of which Dr. Bowditch, of Boston, is president, for the "advancement of scientific research in its broadest sense." The income is annually distributed in sums of from two hundred to five hundred dollars.

Mr. Hodgkins, of Setauket, Long Island, has bequeathed to the Smithsonian Institution 200,000 dols., the income of one-half of which is to be devoted to research into the properties of atmospheric air.

Columbia College has, during the year 1891, received from Mr. Da Costa's estate, before referred to, 100,000 dols. for biology; Harvard, the Joseph Lovering Fund, above stated; 10,000 dols. from Henry Draper for the photography of stellar spectra; the endowments in archeology, above named; and some smaller gifts for various scientific purposes. The University of Chicago and some other institutions have also received important gifts, not to mention those yet to be realised to other colleges from the estate of Mr. Fairweather.

By a bequest of Charles Lenning, the Academy of Sciences of Philadelphia will, in time, receive 20,000 dols.; while half a million of dollars will go to the University of Pennsylvania in aid of instruction in theoretical and practical mechanics, and 200,000 dols. to maintain scholarships. At this University, also, a superb structure for the "Wistar Institute of Anatomy" is now building by General Isaac J. Wistar, at a cost of about 200,000 dols., including endowments designed for original research.<sup>4</sup>

Our reliance in this country must be mainly upon private endowments and the intelligent appreciation of the need of science. The national Government has done, and is doing, much in certain directions. But aside from the dispositions of legislators, it is restricted by the provisions of the Federal Constitution, and by debated questions of constitutional right. State aid is not thus hampered; but State aid is difficult to obtain, to any adequate degree, on account of the previous habits, prejudices, and political training of the people. No doubt this ought not so to be. The State of New York ought, abstractly considered, to maintain one university of the first class equal in every department to any in the world. But the multiplication of institutions already existing, local jealousies, and aversion to State taxation, make this now probably impracticable.

The remedy is with the people, and through their own voluntary methods. It is the people who have made our Government, its institutions, its methods, and the great aggregate, whatsoever it is, such as we see it to-day. Wealth is rapidly accumulating; much of it in the hands of those who, springing from the people, bear the love of the community in their hearts; and when they and the people at large shall come to see that the cause of scientific advance and the discovery of all new truth are in the deepest sense their cause, responses will, I believe, come to every urgent need; until the work of the people, by its own methods, shall, even in science, be able to confront, without shame, the best work of the monarchies of the Old World.

<sup>1</sup> Since the above was written an additional million of dollars has been given by Mr. John D. Rockefeller to the University of Chicago, making 3,000,000 dols. given by him alone to that institution within less than three years, a munificence hitherto unexampled in private endowments, some portions of which, it is hoped, will be available for the maintenance of original scientific research.

<sup>1</sup> President Lovering's Address, *Proceedings*, vol. xxiv, p. 330.

<sup>2</sup> *Proceedings*, vol. xxiv, p. 14.

<sup>3</sup> President Carruthers, *Proceedings*, *Linn. Soc.*, May 1890, p. 39.

## SCIENTIFIC SERIALS.

*American Journal of Science*, December. — Inversion of temperatures in the 26<sup>th</sup> day solar magnetic period, by Frank H. Bigelow. The northern low-pressure and the southern high-pressure belts of North America vary in latitude directly with the solar magnetic intensity, being further north at the maximum and further south at the minimum of the period; whilst the northern high and southern low-pressure belts vary in the opposite manner. This means that an increase of solar magnetic intensity generates the cyclones further south, and causes the anti-cyclones from the polar circulation to travel to the south. — Remarks on colloidal silver, by C. Barus. Colloidal silver possesses properties which can be explained with reference to the analogous behaviour of suspended sediments, allowance being made for differences in the size of particles. The high degree of insulation detected in Carey Lea's metallic mirrors may be interpreted as an instance of the altered behaviour of non-coherent metallic matter. — Resonance analysis of alternating currents, by M. I. Pupin, Part ii. Closed magnetic circuit transformers distort the primary current considerably more than transformers with open magnetic circuits under equal degrees of magnetisation. A ferric self-inductance in circuit with an alternator which gives a simple harmonic E.M.F. distorts the current by introducing higher odd harmonics, principally the harmonic of three times the frequency of the fundamental. Rotary magnetic fields produced by reasonably well-constructed machines are not accompanied by fluctuations in their intensity. An improved form of interruptor for large induction coils, by F. L. O. Wadsworth. The interruptor consists of a brass wheel about six inches in diameter, with two insulating and two contact segments placed in its circumference, and mounted directly on the shaft of a small electric motor making about 1200 revolutions per minute. Two copper brushes are made to bear on the hub of the wheel and its circumference respectively. The hub and the conducting sectors are in one piece. The insulators are made of slate.

*Wiedemann's Annalen der Physik und Chemie*, No. 12. — On the measurement of surface tension of water in capillary tubes of different glasses, by P. Volkmann. A good wetting capacity may be insured by soaking the glass tubes in caustic potash, and then washing with distilled water. That the tubes are perfectly wetted is shown by the perfect mobility of the line of contact. The more nearly circular the section of a tube is, the more does the value of the surface tension of water approach 7.38 mg/mm. at 20°C., whatever the kind of glass. Tubes of very small diameter give larger values. — On the thermochemical processes in the secondary cell, by Franz Streintz. The following thermochemical equations were derived from the author's experiments:

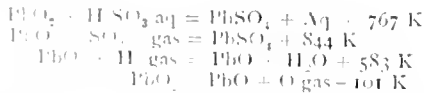

The E.M.F. resulting from these equations is 1.885 volts. One of the cells worked with that having the least concentration, gave 1.90 volts. On the magnetisation of iron and nickel wires by rapid electric oscillations, by Ignaz Klemencic. The strong damping action of magnetisable metals upon electric oscillation is explained by their circular or transverse magnetisation, which crowds the oscillations into the surface layers much more than in the case of other metals. Hence the resistance of a magnetisable wire to electric oscillations is much greater than that of another of equal conductivity. This resistance was determined by a galvanic development of heat in the wire by means of a thermo couple. The permeabilities of the metals deduced by the formulae of Lord Rayleigh and Stefan were: Soft iron, 118; steel piano-forte wire, soft 106, hard 115; Bessemer steel, soft 77, hard 74; nickel, 27. These are very near the values found by Baur and Lord Rayleigh for feeble magnetising fields. — Studies of the electric resonator, by P. Drupe. The author shows that a Hertzian resonator must be chiefly affected by the electric force, playing at that part of the resonator circuit which lies opposite the gap, and proves this experimentally. The resistance of a Zeherler vacuum tube used in these experiments was incidentally found to be 2870 million ohms when the interruptor made 25 breaks per second.

## SOCIETIES AND ACADEMIES.

LONDON.

**Entomological Society**, December 5. — Capt. H. J. Elwes, President, in the chair. — Mr. F. Merrifield exhibited hybrids belonging to the genus *Saturnia*, obtained by Dr. Standfuss, of Zurich; viz. a male and female hybrid from a male of *Saturnia pavonia* and a female of *Saturnia pyri*, to which he had given the name of *Saturnia emilia*; also hybrids from what Dr. Standfuss described as "a male of *Callimorpha dominula*, var. *persona*" (received from Tuscany) and a typical female of *Callimorpha dominula*, to which he had given the name of *romanae*. Mr. Merrifield remarked that the so-called var. *persona* differed entirely from the type of *Callimorpha dominula*. — Mr. J. W. Tutt exhibited, and read notes on, specimens of a very small form of *Euchloa*, taken in Shropshire by the Rev. F. B. Newnham, who was of opinion that it was distinct from *E. cardamines*. He pointed out that it was much smaller than the latter species, and that the discoidal spot was placed as in *E. turritis* and *E. graveri* at the juncture of the orange and white spaces, and not, as in *E. cardamines*, well within the orange tip. Mr. Tutt also exhibited, and read notes on, specimens of *Noctua dalhii*, from Cheshire, Essex, Yorkshire, Aberdeenshire, and other counties. The variation in the specimens was said to be partly due to their geographical distribution. Herr Jacoby read a letter received from Mr. Buxton Forman, one of the Assistant Secretaries of the Post Office, to the effect that the Postal Union had decided to make a rule not to allow natural history specimens to be sent by sample post, which was intended for the transmission of *bona fide* trade patterns or samples of merchandise, and consequently that the forwarding of such specimens at the sample rate would in future be irregular. Lord Walsingham, F.R.S., stated that he had had a long correspondence with the Post Office authorities on the subject, and that the late Mr. Raikes, when Postmaster-General, promised him in 1891 that such specimens should, so far as the British Post Office was concerned, be transmitted at the sample rates; and a letter to the same effect, from the late Sir Arthur Blackwood, when Secretary of the Post Office, was published in the *Proceedings* of the Society for 1891. — Mr. C. G. Barrett exhibited, for Mr. A. J. Hodges, a specimen of *Hydrilla palustris*, from Wicken Fen, also specimens of *Caradrina ambigua*, from the Isle of Wight. He remarked that one specimen of the latter had the hind margin of the right fore-wing indented, and the wing broadened as though from an injury to the pupa. In this wing the margins of the large orbicular and reniform stigmata had become so joined that the dividing lines had disappeared, and the stigmata were fused into one irregular blotch. — Mr. McLachlan, F.R.S., exhibited, on behalf of Mr. G. F. Wilson, F.R.S., a "grease band" which had been tied round trees to prevent the females of *Cheimatobia ramata* from ascending the trunks for the purposes of oviposition; the band was thickly covered with the bodies of the females, together with a few males. — Surgeon-Captain Manders exhibited a pair of *Chelura bifasciata*, from the Shan States, and called attention to the "assembling" habits of the males, some hundreds of which were attracted by the numerous females which emerged from the cocoons at sunset. Mr. B. A. Bower exhibited a beautiful variety of *Zygona lineata*, Esp., having the spots confluent, taken at Chattenden Wood, North Kent, in June last. — Mr. H. Gosse exhibited, for Mr. F. W. Ulrich, of Trinidad, a series of males, females, and workers of *Seriomyrmex opacus*, Mayr., a species of fungus-growing and fungus eating ant. — Colonel Swinhoe read a paper entitled "A List of the *Acrotopora* of the Khasia Hills, Part III." — Mr. C. J. Gahan read a paper entitled "On the Longicorn *Colopectera* of the West India Islands." Mr. F. W. Ulrich communicated a paper entitled "Notes on the Fungus Growing and Eating Habit of *Seriomyrmex opacus*, Mayr." Prof. E. B. Poulton, F.R.S., read a paper, by Prof. E. B. Titchener, entitled "An apparent case of Sexual Preference in a male Insect." — The Rev. H. S. Gorham communicated a paper entitled "Notes on Herr A. Kuwert's Revision der Ceriden-gattung *Amadus*, Lap."

**Geological Society**, December 5. — Dr. Henry Woodward, F.R.S., President, in the chair. — Supplementary note on the Narborough district (Leicestershire), by Prof. T. G. Bonney, F.R.S. — The tarns of Lakeland, by J. E. Marr, F.R.S. The author had examined several tarns of the English Lake district.

In those cases where the stream issues from the tarn over solid rock, he found either (1) direct evidence that the tarn results from the blocking up of part of a pre-existing valley by drift, causing the deflection of the water to a direction different from that of the original stream in this locality; or (2) evidence which is perfectly consistent with such an explanation of the origin of the tarn. Under the circumstances he submitted that tarns cannot be assumed to lie in rock-basins simply because the issuing stream flows over solid rock (and this assumption has been made), but that those who maintain the existence of such rock-basins must prove the occurrence of solid rock entirely around the tarn.—Description of a new instrument for surveying by the aid of photography, with some observations upon the applicability of the instrument to geological purposes, by J. Bridges Lee. The instrument described in this paper consists essentially of a photographic camera fitted inside with a magnetic needle, which carries a vertical transparent scale divided and numbered to  $360^\circ$ , and also with cross fibres which intersect at right angles. The fittings and adjustments of the instrument are of such a character that the camera can be accurately levelled and directed towards any point in a horizontal direction, and when a photograph is taken in an ordinary way the bearing of the median vertical plane which bisects the instrument through the photographic lens will be recorded automatically on the face of the photograph. The vertical fibre (and its image on the photograph) serves as an index to read the bearing; and the same fibre marks by its shadow a line right across the photograph, which marks the median vertical plane on the image. The horizontal fibre is adjusted to mark on the image the horizontal plane which bisects the photographic lens.—The marble beds of Natal, by David Draper.

Royal Microscopical Society, November 21.—Mr. A. D. Michael, President, in the chair.—Messrs. Swift exhibited and described a microtome, which was made as an improvement on the Cambridge rocking microtome. The chief features were that the razor could be fitted at any angle that might be found best suited to the substance it was desired to cut, that it was possible to cut sections embedded in celloidin in spirit, and that it could be used with the ether-freezing apparatus. Messrs. Swift also exhibited an improved example of their new mechanical stage. The milled heads of the stage were now placed on the same side; the stage had also a greater lateral movement than in the first examples.—Dr. Measures exhibited a new mechanical stage by Messrs. Zeiss. He considered that it would be found to be better protected than the old one, and it would admit a much larger plate. It was also fitted with verniers in both directions reading to  $\frac{1}{10}$  of a millimetre.—Dr. W. A. Turner gave a lantern demonstration on recent methods of staining sections of the central nervous system.—Mr. E. M. Nelson described a simple method for measuring the refractive indices of media. He also described a new reflecting camera lucida, and a portable microscope by Zeiss.

Zoological Society, December 4.—Henry Seebohm, Vice-President, in the chair.—A communication was read from Mr. T. Manners Smith, on some points in the anatomy of the water-mole (*Ornithorhynchus paradoxus*). The paper related chiefly to the muscular anatomy of *Ornithorhynchus*, which was followed by a short description of the trunk-arterial system. As regards the anatomy, Mr. Smith appeared to have worked out for the first time the comparative morphology of the skeletal muscles of the Monotremes as determined by their innervation.—Mr. F. E. Beddard, F.R.S., read a paper upon certain points in the visceral anatomy of *Ornithorhynchus*. The paper dwelt in the first instance with the existence of a free fold passing from the bladder to the liver, where it became continuous with the falciform ligament of the liver. This fold, however, exhibited no traces of an anterior abdominal vein. The author also gave a description of the right auriculo-ventricular valve of the heart. In two hearts examined by him the septal flap of this valve was complete, though less conspicuous than the free flap, owing to the fact that it had either no papillary muscles attached to it, or that the muscles were very small. Mr. Boulenger read a second report on additions to the Lizard Collection in the Natural History Museum.—Prof. F. Jeffrey Bell called attention to the acquisition by the Natural History Museum of some specimens of remarkable corals of great size from North-west Australia, of which he showed some admirable photographs taken by Mr. Percy Highley. Prof. Bell urged the necessity of the acquisition of large specimens of corals, before coming to any conclusion as to their specific distinctions.

## PARIS.

Academy of Sciences, December 10.—M. Lœvy in the chair.—The Secretary announced the death of M. Tchouichouf, foreign associate, on December 8.—The decease of M. Ferdinand de Lesseps, on December 7, was referred to by the President, and the meeting adjourned, after receiving the correspondence, as a mark of respect for the deceased member.—A study of the different varieties of graphite, by M. Henri Moissan. Any variety of carbon may be converted into graphite by sufficiently raising the temperature. This graphite may be amorphous or crystalline. Its specific gravity varies from 2.10 to 2.25. Its ignition point in oxygen is about  $660^\circ$ . Its stability, as evidenced by its resistance to transformation into graphitic acid, depends on the temperature to which it has been raised.—A survey made by means of photography, for the delimitation of the frontier between Alaska and British Columbia, by M. Laussedat.—On the secular variations of the orbits of the four inner planets, by Prof. S. Newcomb. (See "Our Astronomical Column.")—On a new ossiferous cavern discovered at Pointe-Pescade, to the west of Alger-Saint-Eugene, by M. A. Pomel. There appears to be no trace of man or of the monkey, though numerous other species of animals are represented in the remains.—On the solution of numerical equations by means of recurrent series, by M. K. Perrin.—On the composition of linear forms and congruences, by M. Stouff.—On elimination, by M. Hadamard.—On the law of resistance of air, by M. C. Chapel. A claim to priority over M. Vallier in regard to the empirical laws recently enunciated by the latter.—An experimental theory of the clipping and punching of metals, by M. Ch. Fremont. A machine is described with which the author has succeeded in registering the work done during punching operations on an indicator diagram.—Integration of the equations of light in transparent and isotropic media, by M. E. Carvallo.—Electromotive force of magnetisation, by M. D. Hurmuzescu.—Determination of the proportions of carbonate of lime and carbonate of magnesia in earths, ashes, &c., by M. Albert Trubert. A description of a simple indirect analysis.—The phosphate of the Grande Connetable, by M. A. Andouard.—On pectase and pectic fermentation, by MM. G. Bertrand and A. Malleve. The conclusions have been arrived at, that (1) this ferment is not able to coagulate pectin when acting alone; (2) it produces this transformation only in presence of salts of calcium, barium, or strontium; (3) the precipitate produced is an alkaline-earthly pectate.—On a new process for the purification of alcohols, sugars, and a certain number of other organic matters, by M. E. Maumené.—Influence of radiation at low temperatures on the phenomena of digestion; Frigotherapeutics, by M. Raoul Pictet.—On the morphology and classification of the Coccidians, by M. Alphonse Labbé.—Succession of the lower Tertiary strata in the cretaceous protuberance of Saint-Sever, by M. L. Rey.—On the *calcaire lithographique* of the valley of the Chêlif, by M. Repelin.—Influence of the dryness of the year 1893 on the forest vegetation in Lorraine, by M. Henry. The production of wood for 1893 was but 30 to 76 per cent. of the normal yield.—The ascension of the balloon *Archimède* (October 11, 1894). Comparative thermometric and hygrometric diagrams of the aerostat gas and the surrounding atmosphere, by MM. Gustave Hermite and Georges Besançon.

## BERLIN.

Physical Society, November 16. Prof. von Bezold, President, in the chair.—Prof. H. W. Vogel spoke on the perception of colours, and demonstrated the various effects which monochromatic illumination has on a series of pigments. The effect of two coloured lights on the several pigments was specially interesting. Thus, for instance, red or yellow squares illuminated by yellow and red light appeared to be white and grey; under yellow and blue they appeared to be red, and in yellow and green lights they appeared the same as when illuminated by white light. Dr. Rubens gave an account of experiments carried out on a large scale in conjunction with W. and E. Rathenau on telegraphing to a distance without wires. They were based, in contradistinction to those of Preece, on the principle of the distribution of currents in the conducting earth. On the banks of the Wannsee, near Potsdam, two electrodes were sunk in the water at a distance from each other of 500 metres, and a current from fifty-five accumulators placed on the bank was sent through them. From each of two boats connected by a cable an

electr. he was immersed in the water, and a telephone inserted into the connection. When the current from the accumulators on the bank was broken, this produced in effect on the telephone audible at a distance of 4.5 kilometres. Small islands lying between the shore and the boats had no influence on the transmission of the signals.

Meteorological Society, November 6. Prof. Hellmann, President, in the chair.—Dr. Meinardus spoke on sheet-lightning and the various theories in explanation of this phenomenon. He sided with the view that it is due to a thunderstorm in which the lightning is visible, whereas the thunder does not reach the observer owing to total reflection brought about by refraction in the several superimposed layers of air.—Prof. von Danckelman spoke on the climate of Java, on the basis of observations made by Dr. Scheinbach since the beginning of 1893 with accurate self-registering instruments. Among the peculiarities of the climate, which is continuous and uniformly warm and moist, it is more especially remarkable that thunderstorms and heavy rainstorms occur most usually between 9 and 10 o'clock in the morning. This phenomenon has not as yet been observed anywhere else.

Physiological Society, November 9.—Prof. du Bois Reymond, President, in the chair.—Dr. Levy-Dorn spoke on the effect of various temperatures on the secretion of sweat, and communicated the results of his own experiments on cats, dealing with the secretion of sweat at low temperatures. The sweat glands themselves were kept at the temperature (19°-30 C.) most favourable for the secretion, while the animal's body was cooled by water at 6° C., and secretion was obtained as a result of dyspnoea, notwithstanding the cooling of the body. The same speaker further gave an account of experiments made with a view to testing Prof. Gruzner's assertion that heat acts only on centripetal and vasomotor nerves, but does not affect motor or centrifugal nerves. Carefully observing all the experimental conditions described by Gruzner, he had found that the action of heat on the sciatic nerve leads to a copious secretion of sweat on the cat's paws, that is to say, stimulates centripetal nerves.—Prof. Zuntz criticised the objections raised by Bohr and Henríquez against his experiments on the measurement of the work done by the heart, and showed up the errors which had crept into their observations. He next demonstrated the apparatus he had employed for measuring the amount of blood forced out by the heart.

NEW SOUTH WALES.

Linnean Society, October 31.—Prof. Haswell, Vice-President, in the chair.—Notes of a visit to the island of Erromanga, New Hebrides, in May 1894, by Sutherland Simelair.—Preliminary communications on the cerebral commissures of the manumalia, with special reference to Monotremata and Marsupialia, by G. Elliott Smith. From an examination of the brain in platypus, *Perameles*, kangaroo, wallaby, kangaroo rat, *Peromyscus*, and phalanger, the superior commissure of the cerebrum was shown by the author to be homologous with the pecten of Placentalia, and not with the corpus callosum. There appear to be no true corpus callosum as distinct from a pecten in any monotreme or marsupial. The hook-like pecten of the hippocampal commissure in sagittal section in man, monkey, and phalanger, which Flower regarded as corpus callosum, was seen to correspond to the shape of the hippocampus, which is co-extensive with the lateral ventricle. In platypus only the dorsal part of the hook is present, because there is only a rudimentary ascending horn of the ventricle and hippocampus. In Erromanga only the ventral limb persists, because the superior part of the horn of the hippocampus disappears to allow a corpus callosum to appear in the situation occupied by the dorsal limb of the hippocampal commissure in *Meathenia*, the ventral to the dorsal limb. The fascia dentata, as a consequence of the presence of the pecten, is absent. A doubt was expressed as to the possibility of any structure in the submanumalia being homologous to the Erromanga corpus callosum. The hypothesis was advanced that the latter structure appears only as the hippocampal commissure (or some what either) to supply the demand for a connection of path for the great partial development of the sensory mammalian feature.—Description of some new species of Australian Coleoptera, by A. M. Leys. Descriptions were given of only nine species from New South Wales, most of which belong to the *Chrysomelidae*. A remarkable *Deropoda* from the Liverpool River was described, and

a species of *Leptis* living in ants' nests.—Description of a new *Leptis* from New South Wales, by R. T. Baker. The *Leptis* described was obtained on the Murrumbidgee Ranges, Goulburn River. It differs from the N.S.W. *L. anemonifolius* in having deeply-divided leaves on long petioles and a silky hairy perianth; from the West Australian *L. longifolius* in its longer and pinnately divided leaves, smaller cones and longer perianth.—Synonymy of some Australian and Tasmanian mollusca, by John Brazier. The synonymy of twelve species were given with references and habitats.—Further observations upon the anatomy of the integumentary structures in the muzzle of *Ornithorhynchus*, by Prof. J. T. Wilson and C. J. Martin. The authors specially dealt with the details of structure of the "push-rod" in the skin of the snout of the platypus, and offered further confirmation of their views in opposition to a recent criticism of some of these by Prof. E. B. Poulton.—Description of the external characters of a very young specimen of *Ornithorhynchus*, by Prof. J. T. Wilson.

BOOKS, PAMPHLETS, and SERIALS RECEIVED.

BOOKS.—University Tutorial Series, Vol. 1: A Text-book of Sound: F. Caterpool (Clive).—Manual of Practical Morbid Anatomy: Drs. Rolleston and Keithback (Cambridge University Press). The Book of the Rose: Rev. A. Foster-Melliar (Macmillan).—An Elementary Treatise on Theoretical Mechanics, Part 1: Kinetics. Prof. A. Zwet (Macmillan).—Natural Rights. Prof. D. G. Ritchie (Somnenschein).—Elementary Qualitative Chemical Analysis: Dr. F. Clowes and J. B. C. Ieman (Churchill).—Pubblicazioni della Specola Vaticana, Vol. iv. (Torino, Artigianelli).—A Few Chapters in Astronomy: C. Kennedy (Taylor and Francis). PAMPHLETS.—On the Natural Immunity against Cholera, &c.: C. G. Gumpel (Williams and Norgaic).—Ecliptical Orbits: H. Larkin (Usun).—Royal Gardens, Kew, Hand-list of Trees and Shrubs grown in Arboretum, Part 1: Polypetalae (Eyre and Spottiswoode). SERIALS.—Engineering Magazine, December (Tucker).—American Journal of Science, December (New Haven).—Strand Magazine, December (Newnes).—Natural History Transactions of Northumberland, &c., Vol. XI, Part 1: (Williams and Norgaic).—Verhandlungen des Naturhistorischen Vereins der Preussischen Rheinlande, &c., Einundfunftzigster Jahrgang, Sechste Folge, L. Jahrgang, Erste Hälfte (Bonn, Cohen).—Medical Magazine, December (Strand).—Le Monde Moderne, January (Paris).—American Naturalist, December (Wesley).—Strand Musical Magazine, No. 1 (Newnes).—Royal Natural History, Part 14 (Warne).

CONTENTS. PAGE

Sir Richard Owen . . . . . 169
Electromagnetic Theory. By J. Swinburne . . . . . 171
Recent Psychology . . . . . 173
Our Book Shelf:—
Giberne: "Rudiant Suns" . . . . . 174
Meyer and Parkinson: "Album von Papua-Typen" . . . . . 174
"Farm Vermin, Helpful and Harmful" . . . . . 174
Letters to the Editor:—
The New Cypess of Nyasaland.—W. T. Thiselton-Dyer, C.M.G., F.R.S. . . . . 175
The Kinetic Theory of Gases.—S. H. Burbury, F.R.S.; G. H. Bryan . . . . . 175
Science and History.—Alfred H. Huth . . . . . 179
Geometry in Schools.—Edward M. Langley . . . . . 179
Lilienthal's Experiments in Flying. (Illustrated.) . . . . 179
Peters—Denza Ranyard . . . . . 179
Notes . . . . . 179
Our Astronomical Column:—
Secular Variations of the Interior Planets . . . . . 183
Irregularities in Variable Stars . . . . . 183
The Radcliffe Catalogue . . . . . 183
'La Tronemie' . . . . . 183
On the Use of the Globe in the Study of Crystallography. By J. Y. Buchanan, F.R.S. . . . . 184
The Use of Safety Explosives in Mines . . . . . 184
The Upsala Meeting of the International Meteorological Committee. . . . . 185
Endowment for Scientific Research and Publication. H. . . . . 186
Scientific Serials . . . . . 190
Societies and Academies . . . . . 190
Books, Pamphlets, and Serials Received . . . . . 192

THURSDAY, DECEMBER 27, 1894.

*A STANDARD TREATISE ON CHEMISTRY.*

*A Treatise on Chemistry.* By Sir H. E. Roscoe, F.R.S., and C. Schorlemmer, F.R.S. Vol. I. "The Non-Metallic Elements." New edition, completely revised by Sir H. E. Roscoe, assisted by Drs. H. G. Colman and A. Harden. Pp. xi. 888. (London: Macmillan and Co., 1894).

TO write a satisfactory review of this book is no easy task. The word which shall express an appreciation and a criticism does not come readily to one's pen. Turning over the pages and reading the lucid descriptions of preparations and properties of element after element, and compound following compound, one is depressed, and borne down by the burden of many facts and much learning. But to this depression succeed the pleasure and the sense of power that belong to the gaining of knowledge, and the feeling of security that remains with the man who has got down to fundamental facts.

In the preface to the first edition of this "Treatise," the authors said:

"It has been the aim of the authors . . . to place before the reader a fairly complete, and yet a clear and succinct, statement of the facts of modern chemistry, whilst at the same time entering so far into a discussion of chemical theory as the size of the work and the present transition state of the science permit."

In his preface to the present edition, Sir Henry Roscoe says:

"In this new, completely revised and reprinted, edition I have endeavoured to carry out the aims which were put forward in the preceding preface seventeen years ago."

The aim and scope of the work are made evident by these extracts from the prefaces. There can be no doubt that the authors succeed in giving "a fairly complete, and yet a clear and succinct, statement of the facts of modern chemistry." The descriptions of the properties of elements and compounds are lucid, full, and accurate; where all the properties of a substance cannot be described, the selection made is satisfactory, sometimes, one may suppose a student to say, too satisfying. But this even flow of excellent description does not inspire with enthusiasm him who reads; it does not open up glimpses of the unexplored regions; it fails to stir the emotions. The book is wanting in the charm that accompanies the "twilight of dubiety."

It is difficult always to agree with the authors in their estimate of the relative importance of chemical facts. The most important fact of modern chemistry I take to be the statement that "the properties of the elements and compounds, and the compositions of compounds, vary periodically with the atomic weights of the elements." This fact ought, I think, to be made the basis of every treatise on descriptive chemistry; because only by doing this can the facts regarding individual substances appear in right perspective. The great fact which we owe to the genius of Mendeléeff will find expression in a later volume of this "Treatise" (see p. 53); but the student who uses the book will then probably have arranged the intel-

lectual contents of his mind, so far as chemistry is concerned, in many little parcels, each tied up separately, and he will find much difficulty in untying the parcels, arranging their contents afresh, and getting them all within the compass of the one binding generalisation.

As regards the statements of the properties of the different non-metallic elements and their chief compounds, no detailed appreciation is called for. Where all is excellent, a general expression of praise is sufficient. The chapters wherein are described hydrogen, fluorine, oxygen, sulphur, nitrogen, and the other non-metals, and the principal compounds which these elements form by combining with one another, contain all that student of chemistry requires to know about these elements and compounds, except the comparison and contrast—that is to say, the classification—of the substances described. The student has presented to him, in this volume of the "Treatise," the material that is needed for acquiring a real knowledge of the chemistry of the non-metallic elements.

Some of the expressions, and the ways of putting descriptive facts, might be improved, in my opinion.

"Hydrogen occurs almost solely in a state of combination in nature" (p. 129).

"In a state of combination hydrogen occurs in water" (p. 129).

"Bromine does not occur in the free state in nature" (p. 188).

Expressions like these seem to me to be survivals from the alchemical times, when, to take an example, nitric acid was looked on as water endowed with acidic qualities, which could be removed or restored at pleasure, and hence was called *agua fortis*. Surely it is not hydrogen that occurs "in a state of combination," but compounds of hydrogen that occur in nature. Similarly if bromine occurs at all it must be "in the free state," else it would not be bromine but something else. Each compound of hydrogen, and each compound of bromine is just as definitely a chemical individual as hydrogen, or bromine, itself.

I do not think that the object of chemistry, namely the study of the connexions between changes of composition and changes of properties, is set forth with sufficient clearness. The statement on pp. 51, 52, for instance, that

"the science of chemistry has for its aim the experimental examination of the elements and their compounds, and the investigation of the laws of their combination one with another,"

cannot be regarded as satisfactory. On the other hand, the examples given of chemical action, in the pages preceding that where the sentence just quoted occurs, undoubtedly serve to keep before the student the fundamental fact that change is the essential note of all chemical occurrences.

The term *density* is sometimes applied to gases in a way that is confusing. For instance, on p. 160 the term is applied to the relative density of chlorine, referred to hydrogen as unity, and also referred to air as unity, without an indication that the unit has been changed.

A feature of the book which is much to be commended is the giving of the definite experimental data from which important conclusions are deduced. A good

example of this is seen in the authors' treatment of the eudiometric synthesis of water (pp. 246-252). The actual details of an experiment are given, with the experimentally determined data, and the conclusion to be drawn is then stated. It is much to be regretted that the authors do not quote the results obtained by Scott regarding the volumes of hydrogen and oxygen which combine to form water, but content themselves with the less recent, and certainly less accurate, measurements made by Morley (p. 251).

The authors would have done well to have followed their own practice elsewhere, and to have given moderately complete details of the methods, and the data, whereby the atomic weight of each element has been determined. In describing the electrolysis of dilute sulphuric acid solution (pp. 25, 129, 251), the authors might have more clearly insisted on the fact that the electric current is employed to set free hydrogen and oxygen from an aqueous solution of sulphuric acid, and that they had not followed what is true almost every other text-book, speaking of the phenomena as the electrolysis of water.

The authors' equations convey, at the best, only a small portion of the information one wishes to have regarding chemical differences, but, by the simple devices of using three kinds of types, and adopting a symbol to represent an aqueous solution of a substance, these equations may be made to tell much more than is conveyed to the reader by the equations used in this "Treatise."

In the extract from their preface already quoted, the authors say that they enter into "a discussion of chemical theory so far as the size of the work and the transition state of the science permit." The subject-matter of chemistry is so large, and the difficulties of bringing the vast array of facts into a focus are so great, that the science is likely to continue for a long time in a transitional state, and the principles of chemistry to continue to be, as they are at present, rather a number of somewhat loosely attached hypotheses than an harmonious and building theory. Nevertheless, more unity might profitably have been given to the chapter on the "General Principles of the Science." Many portions of this chapter are admirable; the whole of it is characterised by lucidity. The portions dealing with the laws of combination and the Daltonian atomic theory are especially excellent. Brief but very clear accounts are given of the experimental methods for determining molecular weights, of finding the methods which are based on van't Hoff's extension to dilute solutions of the law of Avogadro. In connexion with the molecular condition of substances in solution, there is a deliciously airy note (p. 111): "For the literature of this subject the volumes of the *Zeitschrift für Physikalische Chemie* . . . may be consulted." The student who proceeds, with a light heart, to consult the journal in question will find he has his work cut out for him.

The book, taken as a whole, is admirable. The sure prediction that the earlier editions of the "Treatise" have taken in chemical literature has shown how much the work was wanted, and how cordially it has been welcomed by chemists. It is sufficient to say that this, the first volume of the revised edition, well maintains the reputation of the original "Roscoe and Schöberlein."

M. M. PATERSON MUIR.

#### MAN—THE PRIMEVAL SAVAGE.

*Man—the Primeval Savage.* By Worthington G. Smith. (London: Stanford, 1894.)

MR. WORTHINGTON SMITH has devoted himself for many years to a study of the localities near London where implements have been found, and has described the various palæolithic floors with great minuteness, and illustrated them with great artistic skill. In this book he brings all his previous discoveries together, and groups them round his last work at Caddington, near Dunstable, on the borders of Hertfordshire and Bedfordshire. He has presented to us a monograph on palæolithic camping-places, rather than a general treatise on Man, the Primeval Savage.

The palæolithic floor at Caddington was buried under a depth of clay, sand and gravel, amounting in some places to thirteen feet from the surface. The strata occur in the following order from the surface: 1) Contorted drift; 2) reddish-brown clay, with implements stained with red ochre; (3) subangular gravel with ochreous implements, slightly worn and battered; (4) white clay; (5) gravel, with white unworn implements; (6) reddish-brown clay with implements; (7) clayey gravel with implements; (8) clayey brick-earth; (9) palæolithic floor resting on a clayey brick-earth similar to that above it. All these deposits form a thickness about eight feet in this section, and belong to the complicated series of superficial sand clays and gravels grouped together by the Geological Survey as brick-earth, and clay-with-flints, and which are clearly proved to be later than the boulder clay of the district. The interest chiefly centres in the palæolithic floor No. 9, resting upon a sun-cracked surface in some places, and in others supporting heaps of flints carefully selected, and evidently piled together for the purposes of implement making. Around them lay worked flints by the thousand. It is obvious that here we are on the track of a palæolithic camping-ground, and that the deposits which now cover it up have been accumulated, the fine clays by heavy rains on the margin of a stream or on the borders of a lake, and the sands and gravels by the natural drift of the soil downwards from a higher level. The distribution also of the flint implements in the section, prove that man inhabited the district while the strata were being accumulated above the palæolithic floor up to No. 2 inclusive. As the mud accumulated on the old floor, the hunters, attracted probably by the water close at hand, visited the same spot from time to time, and left their implements in 7, 6, and 5 of the section. These, our author considers to be the same age as those of the palæolithic floor. The worn ochreous implements in Nos. 2 and 3, he relegates to a later time in the palæolithic age, and considers them to have drifted downwards from a higher level into their present position. "The water must have drained elevations which have now vanished, and the hill tops of the Dunstable district of the present time must represent the valleys of the old time." Caddington is now on the water-parting between the sources of the Lea and the Ver, and under present conditions there is no higher ground from which these materials could have been derived.

The worked flints on the palæolithic floor represent



every stage of manufacture, from the unshaped block to the finished *hache*. There are the flint cores and the flakes lying beside them, there are flint hammer-stones and anvils, punches and scrapers, and other implements broken in various stages of manufacture. Very few of the latter are finished. They would, of course, be carried off for use, as was the case with those of the palæolithic floor discovered some ten years ago, in the brickpit at Crayford, by Mr. Flaxman Spurrell. Mr. Smith, we may remark, has followed the example of the latter, in the infinite pains he has taken to build up the original forms of the flint blocks from the broken implements and splinters. It is clear that in this place we have the workshop in the condition in which it was left by the palæolithic hunter. The fact that no bones and no charcoal have been discovered, shows that the palæolithic huts were some little distance away, and that this spot was selected solely for the purpose of implement-making.

The association of the ruder with the more finished of the palæolithic implements in this floor, as in the case of many of the palæolithic caverns, proves that an appeal to rudeness of form as a test of age, is a wrong principle. That man must have learnt first of all to make the simpler before he made the more complex implements, is so obvious, that it has never been disputed. The ruder, however, were used side by side with the more finished, and many of those forms which are taken to be of pre-palæolithic age in the gravels of the Kentish plateau are the necessary result of the working of the flint block into the palæolithic *hache*. We may remark, further, that some of these are also found in the refuse-heaps round the old flint-mines of Cissbury, and have been made in the manufacture of neolithic implements.

In the introduction, Mr. Smith deals with the general question of the relation of palæolithic man to the glacial period, and concludes, rightly in our opinion, that man inhabited south-eastern England after the glacial period. We also agree with him in looking at the pre-glacial or post-glacial age of man as merely of local significance, because the glacial period is a purely local phenomenon not marked in the warmer southern lands, such as the Indian peninsula, which was inhabited by the palæolithic hunter. We know of him in India simply as living in the pleistocene age. He probably invaded Europe in the pre-glacial age, and lived in the south while Britain lay buried under a mass of glaciers, or was covered by a berg-laden sea. He is post-glacial in the valley of the Thames. He is not separated from our own times either by a wall of ice—one of the ice periods of Prof. James Geikie—or by the tumultuous waters of a vast deluge, such as that recently put before us by Sir Henry Howorth. He is separated by a geographical revolution during which the seaboard of north-western Europe, as we find it now, came into being, and Britain became an island—as well as by a change in our land from a continental to an insular climate.

The author also touches the difficult problem of the physique of primeval man, and he accepts the "type de Canstadt" as the earliest palæolithic race. This is, however, founded on a human skull which M. d'Acy has conclusively proved to have no claim to any

definite age. According to the evidence of the catalogue, still preserved, of the pleistocene mammalia found at Canstadt in 1700, it was not found along with them. Dr. Reissel, who superintended the exploration for the Duke of Würtemberg, wrote in 1701 that no human remains were then found, "inter quæ tamen nulla humanis possunt comparari." Some fifty years later Dr. Albrecht Gessner, writing on the discovery, remarks that it is strange that no human remains had been met with. Both these were doctors to the Dukes of Würtemberg, and can only be supposed to know a human skull when they saw it. It was not until 1835 that the skull in question was found by Dr. Jaeger, in the Museum at Stuttgart, and assigned without proof of any kind to the find made 135 years before. It is very unfortunate that such faulty evidence as this should not only be accepted by the authors of "Crania Ethnica," but also used for the definition of the type "de la plus vieille des races humaines." In the present unsatisfactory state of the inquiry into the physique of palæolithic man, the only safe course is to subject all the facts which have been recorded to the most searching criticism, and to wait for the further light which will come sooner or later from new discoveries. In this small and well-illustrated monograph, Mr. Smith has made our knowledge of the palæolithic workshop more definite than it was before, and has collected together a mass of information which will be of great service to the archaeologists of London.

W. BOYD DAWKINS.

#### THE SEQUENCE OF STUDIES.

*Physiology for Beginners.* By Professor M. Foster, M.A., M.D., F.R.S., and Lewis E. Shore, M.A., M.D. (London: Macmillan and Co., 1894.)

*Outlines of Biology.* By P. Chalmers Mitchell, M.A., F.Z.S. London: Methuen and Co., 1894.)

*Practical Methods in Microscopy.* By C. H. Clark A.M. Boston: Heath and Co., 1894.)

THE scientific precision and modernness of a book of elementary physiology, written by Dr. Shore, under the supervision of Prof. Foster, is scarcely to be called in question. This little volume is amply illustrated, and written with clearness as well as exactness. The authors are especially to be commended for laying stress in their preface upon the necessity of a preliminary acquaintance with Chemistry and Physics, and it is to be regretted that they had not the courage to insist upon this point. But here they are gravely open to criticism. "Knowing," they say, "how frequently a book on physiology is taken up without any such previous acquaintance, we have given a few chemical and physical facts as preliminaries in chapter i." A few, and quite too few, it is—six complete pages—expanding scarcely any of the principles which are involved in the simplest physiological explanation, giving, of course, no conceptions of the relations of chemical combination to energy, nor of osmose, diffusion, solution, isomerism, nor the action of ferments, all of which come to the front directly one approaches respiration or digestion. We cannot but think that this concession to a common educational error is greatly to be deplored. The authors occupy a position of authority, and it was their privilege—a privi-

lege they have neglected—to demand here, by assuming a sound basis of chemical and physical knowledge, the proper sequence of studies. As it is they have produced a little primer that by virtue of its clearness and attractiveness and the prestige of their names, will serve to uphold for a few years longer a fundamentally faulty system of scientific education.

The evil of a neglect of the rational sequence of studies becomes particularly apparent in the chapters upon the eye and ear. In the former of these an attempt is made to convey all the optical principles involved, in seven lines—"convex lens" is not even denied—and in the latter comes a series of dogmatic statements about sounds and noises, without a particle of that progressive reasoning process which is the very essence of genuine scientific study. Once the initial concession was made, however, this kind of thing was an inevitable consequence. In order to explain the science in hand, three or four others have to be compressed to the limits of a paragraph.

The same unfortunate disposition to begin the wrong way about is apparent in the little book by Mr. Chalmers Mitchell. But in his case there is even less excuse. His book is designed to prepare students for the Conjoint Boards Examination, and therein he is an examiner. Since he calls the tune he might have danced as he liked, and he has, we conclude, preferred of his own free will to contravene the common-places of educational science. We find such a proposition as the following, printed in spaced type; so that the medical student, preparing for examination by Mr. Chalmers Mitchell, who fails to learn it by heart will have only himself to blame for his failure. The earthworm, we are told,

"has reached the second stage of cœlomate development in that it is very highly segmented, and there is little or no trace of the third stage, the stage of the condensation of segments." . . . "Vertebrates are highly segmented animals, in which condensation of segments has become an important factor, resulting notably in the formation of a complicated head, and of kidneys formed by the aggregation of many nephridia."

Now these propositions are illustrated rather than supported by a brief description of the anatomy of the earthworm, dogfish, and frog, and we find that even in the case of these types the metameric segmentation of the cranial nerves is scarcely alluded to, and the homology of the mandibular arch with the branchial bars is not presented as a probability, but stated as a fact. And, in brief, Mr. Chalmers Mitchell, who is not a crammer, but a teacher, gives the medical student the impression almost in so many words "cut and dried" and ready to be cast into the oven—that the vertebrate type is merely a concentrated derivative (concertina fashion) of the chaetopod type, advancing this pure, and as he gives it, baseless, speculation, in the face of the absence of any chaetopod stage in the embryology or paleontology of the vertebrates, in the face of the lesser metamericism in the vertebral column of more primitive fishes, and in the face of the declared opinion of many prominent anatomists. But whether the view he gives is right or wrong is, from our point of view, the smaller issue: the great and grave objection is the unscientific spirit of the presentation, the narrowness of the base of anatomical fact upon which this far-reaching generalisation is raised. We find this

disposition to what is really the old theological trick of dogmatism, again and again in his book, and it is the evident and necessary consequence of an attempt to touch the far-reaching theories of comparative anatomy without a sufficient preliminary study of individual types.

It is odd that we should find another aspect of the same mistake cropping up in one chapter of Mr. Clark's extremely useful and well-arranged handbook for the beginner in microscopy. It is in almost every way a well-arranged and well-written work, and will be particularly a boon to the amateur to whom experienced advice is inaccessible. But before proceeding to the petrographical instrument, Mr. Clark has attempted a "concise description" of polarised light, which begins—

"The elasticity of the ether in space is believed to be equal in all directions. The same is true of the ether in non-crystalline substances and in crystalline substances of the cubical system. The particles of ether are consequently free to vibrate equally in all directions. In other crystalline substances the elasticity of the ether is modified by the crystalline structure. In some crystals there is one axis or direction about which the molecules are arranged in a uniform manner; such crystals are said to be uniaxial. In other crystals there are two such axes."

Now we believe a student who will clearly understand this will be sufficiently advanced not to require it, and that to the raw beginner, this passage, and its context, will be incomprehensible. Were it not for the actual evidence of these books it would seem the most unnecessary thing in the world to assert that a clear working idea of the *theory* of polarised light, or the general ideas of chemistry and physics, or a cyclopædia of the anatomy of the metazoa, cannot be imparted in half a dozen pages or so of text. If it could, our textbooks in these subjects would be unnecessary, for the ultimate aim of all intelligent research and teaching in pure science is broader and simpler general notions, and there can be no need for a volume if a handbill will suffice. Cannot the scientific writer insist upon the proper sequence of studies in his preface, and proceed on the assumption that his counsel will be observed? To positively encourage students to proceed to subjects for which they have not the necessary grounding, to proffer them snap-shot chapters upon these neglected preliminaries, is really, we are persuaded, to place a grave impediment in their way to genuine knowledge, all the graver because it seems a help, and to place one also in the way of our advance towards more efficient science teaching in the future. H. G. WELLS.

#### OUR BOOK SHELF

*Climbing and Exploration in the Karakoram-Himalayas.*

By William Martin Conway, M.A., F.S.A., &c. Containing Scientific Reports. (London: T. Fisher Unwin, 1894.)

THIS supplementary volume contains reports on the scientific results of Mr. Conway's adventurous journey, with his map of the mountain region between Rakipushi and Golden Throne, through which he travelled. The author supplies a list of measured altitudes and notes on the map, mentioning the differences from that of the Trigonometrical Survey of India. Lieut.-Colonel A. G. Durand describes the ethnology and later history of the

Eastern Hindu Kush, giving a brief sketch of the physiography of the region. Prof. T. G. Bonney and Miss C. A. Raisin furnish notes on the rocks collected by Mr. Conway, from which it appears that the majority much resemble those of the Alps. The most interesting specimens are a peculiar schist with secondary mica, a piemontite-schist, and a fragment allied to pseudo-jade. Mr. W. F. Kirby identifies the butterflies, Dr. A. G. Butler the moths, and Mr. W. B. Hemsley the plants. Of the last about a dozen were obtained at or over 16,000 feet. The well-known *Saxifraga oppositifolia* was gathered at 17,000 feet, and another species (the highest habitat) at 17,320 feet. Mr. W. L. H. Duckworth writes on two skulls brought from Nagyr, and Prof. C. Roy discusses Mr. Conway's notes on mountain sickness, coming to the conclusion that the primary cause of it is asphyxia. Mr. Conway's observations agree with those of other experienced climbers, that a man in good condition begins to feel the effect of increased altitude at about 16,500 feet. The fact that he is sensible of more inconvenience when in a hollow among the peaks than when on an exposed ridge, Prof. Roy attributes to some loss of oxygen by the air when it has passed over a considerable tract of melting snow. Mr. Conway has made valuable additions to our knowledge of the geography and physical history of this remote mountain region, and the present volume supplements the more popular account of his travels, which appeared earlier in the year.

*The Royal Natural History.* Edited by Richard Lydekker, B.A., F.R.S. Vols. i. and ii. (London: Frederick Warne and Co., 1893-94.)

ABOUT twelve months ago (*NATURE*, vol. xlix. p. 220), in a short notice of the two first parts of this work, we heartily recommended it as worthy of the notice of our readers. On a careful perusal of the two volumes now before us, which equal one-third of the projected series, we still feel quite justified in our recommendation; the illustrations are for the most part extremely good, and the text is not only interesting, but it is also intelligently written.

The first of these volumes treats, in fifteen chapters, of the Primates, the Chiroptera, the Insectivora, and the Carnivora, as far as the dogs. We would especially notice the chapters on the cats and the dogs, as having information well up to date. Instead of the often-quoted old stories, it is refreshing to meet with accounts of the habits of these animals, taken from the writings of V. Ball, Blandford, Guillemard, Hudson, and Sterndale. Thus, in the account of the common Indian mongoose, we find mention of the results, to within the last year or two, of Mr. Espent's experiments of introducing this little carnivore to Jamaica. The sugar-planting industry in this island was threatened with destruction on account of the swarms of rats; within three or four years after the introduction of the mongoose the rat plague came to an end, and the beneficial results to the island exceeded £150,000 a year. Volume ii. commencing with the bears, finishes the Carnivora, and describes the hoofed mammals. The illustrations play so important a part in these volumes, that we would suggest that the comparative sizes of the figures should always be given, and when possible the reader should be told where the figures first appeared.

*Kitchen Boiler Explosions.* By R. D. Munro. Pp. 44. (London: Charles Griffin and Co., 1895.)

THE time having again arrived when domestic boilers will be a source of trouble to paterfamilias, Mr. Munro comes forward with an account of a series of experiments with red-hot kitchen boilers, apparently reprinted from the *Transactions* of some Society. Whether this be so or not we do not wish to inquire, but to us it seems that the diagrams of steam-pressure are little

suitable to the "intelligent householder" for whose edification they are intended. The chief conclusions drawn from the experiments are that (1) a dead-weight safety-valve should be fitted to every boiler; (2) water will flow into a red-hot boiler although there is no free outlet, and, also, that a steam-pressure can be attained in such circumstances sufficient to cause rupture of the strongest boilers in use; (3) whilst a very high steam-pressure may be generated in a red-hot boiler by the sudden injection of cold water, a disastrous explosion cannot thus be produced; (4) an explosion, in the true sense of the word, cannot occur unless the boiler contains water as well as steam. Probably the perusal of Mr. Munro's book will help to diminish the disasters from boiler explosions.

*The Island of Madeira, for the Invalid and Naturalist.*

By Surgeon-General C. A. Gordon, M.D., C.B. Pp. 110. (London: Baillière, Tindall, and Cox, 1894.)

PERSONS who are fortunate enough to be able to leave England during the dreary months of winter, and who select to sojourn in Madeira—"The Flower of the Ocean"—should take this brochure with them. The characteristics of the people and the place are concisely stated, and there is more information on the geology, meteorology, zoology, and botany of the island than is usually given in guide-books of a similar kind. It is well known that Madeira has an extensive fauna and flora, and we agree with the author that it is a matter of regret that the island has no public museum where they could be collected and investigated. Prof. Smitz, however, is gradually forming such an institution at the college in Funchal.

#### LETTERS TO THE EDITOR.

[The Editor does not hold himself responsible for opinions expressed by his correspondents. Neither can he undertake to return, or to correspond with the writers of, rejected manuscripts intended for this or any other part of *NATURE*. No notice is taken of anonymous communications.]

#### "Acquired Characters."

NOW that the correspondence on this subject, which you all-wel me to start in your number of November 1, seems drawing towards a close, I ask leave through you to thank your correspondents for their courtesy in replying to my inquiries, and also to make a few observations by way, so far as I am concerned, of conclusion.

As none of your correspondents has found any fault with the conditions which I suggested as essential to a good definition, I conceive that I may assume them to be correct.

Furthermore, as none of these writers has adopted or defended any of the definitions which Weismann appeared to me to give or to suggest, or has said anything by way of criticism on my strictures on these definitions, I think that I may conclude that I was not far wrong in those strictures, and that Weismann's writings do not afford any good definition of the words to which he has given currency.

Mr. Poulton has suggested that a definition may be found in the statement that "whenever an organism reacts under an external force, that part of the reaction which is directly due to the force is an acquired character." But surely this is difficult of application: for in every case of a reaction on an external stimulus there are two elements—viz. first, the internal capacity to respond, and secondly, the external force or stimulus. Each of these is necessary to the result and to every part of the result, and neither is of itself sufficient to the result or to any part of the result. How then can we analyse or break up the result or the reaction into two parts, and say that the one is the direct result of the external force, and the other is either not its result at all, or its indirect result? Where there is the joint action of two causes, each necessary but neither sufficient of itself, I conceive that you cannot either logically or physically sever any part of the result from the action of both of the causes, and there is no ground for attributing directness to one part of the effect, and indirectness to another. Mr. Poulton dwells truly on the reaction having two causes—the internal and the

external; but this does not justify the analysis of their results into two parts.

Nor does the matter become plainer to me when I follow Mr. Poulton in his application of his definition to concrete cases. The first is the case of the so-called "Exercierknochen," a reaction on an external force resulting in a certain number of changes of tissue. How is it possible to classify those changes into two categories—the one including changes directly due to the external force, the other changes not directly due to it? If the stress is to be laid on the word "direct," then one must respectfully ask what is its meaning? how is it to be ascertained and verified? one must inquire whether what is said to be an indirect result, means anything but a result which is transmitted? in which case we should find ourselves in a vicious circle. I will not follow Mr. Poulton through the other instances, but I believe the reader will find, like me, that each raises similar difficulties, and that in no case does he analyse the actual result into two distinct and separable parts.

Mr. Gilton proposes, and Prof. Ray Lankester adopts another definition, *viz.* "Character are said to be acquired when they are regularly found in those individuals only who have been subjected to certain special and abnormal conditions." Now I suppose that characters can be found regularly only either (1) in individuals exposed to conditions which induce them, or (2) in individuals who have inherited them. To say, then, of a character that it appears only regularly in individuals exposed to certain conditions, is to say that it does not appear in individuals by inheritance, and the proposition that acquired characters are not transmissible is thus reduced to an identical one. The possibility of inheritance is excluded by the definition, and the inquiry whether acquired characters are inherited is impossible.

I do not propose to follow your learned correspondents into many of the subjects touched on by them; but the more their letters are read, the more apparent does it become that they are not at one, either with themselves or with Lamarck or Weismann, as to the use of the words "acquired characters;" and for myself, I repeat my regret that an inquiry of great moment should be obscured, as I venture to think, by a premature use of classificatory words before the real classification of nature herself has been ascertained. For the question, "Are acquired characters transmissible?" I hope to see substituted the inquiry "What characters are transmitted?"

EDW. FRY.

#### The alleged Absoluteness of Motions of Rotation.

*It is not a relative motion.* This apparently universal statement is a particular statement about the meanings of words. The word "motion" means "relative motion," or, more precisely, "the motion of a body" means its motion relative to other bodies. We may go further and make the still more fundamental meaning that *all motion is relative*; or, in other words, "the motion of a body" means its position relative to other bodies. It is not easy to see how this words together without reflecting on their meaning to put together the noun "motion" and "rotation" and the adjective "absolute," but the expressions "absolute motion" and "absolute position" are not more in a logical angle, just as much so as "white blackness," "the motion of progress," "the action between a rough body and a smooth body at their point of contact," or "the potential energy of a non-conservative force."

The axes of rotation in the standpoint from which it is concluded that motions of rotation are no more "absolute" than motions of translation. Anyone who accepts them for translation, but rejects them for rotation, places himself in an illogical position. He has misunderstood them, this is the position of Mr. Maxwell and Prof. Greenhill. The "translation" and "rotation" position and motion are in the same relation to the absolute as that of Newton. He held that there was an unmovable space, and relative positions within it, and correspondingly there are absolute and relative motions; that absolute motion of a body is a translation from one absolute place to another absolute place, that we can never determine the absolute place of a body, only its relative place; that in cases of rotation we can distinguish absolute from relative motion by the effects of "centrifugal force." He gives no indication how to distinguish absolute and relative motions of translation. From the impossibility of determining the absolute position of a body it seems to follow that absolute motion of translation cannot be determined; this view is adopted by Maxwell.

Assuming that it is the object of the Science of Mechanics to give as simple a description as possible of the observed facts about the motions of bodies, the assumption at the outset of absolute motions or positions about which we can know nothing appears an unnecessary complication.

From a logical point of view the cardinal statement in the discussion is that all position is relative. It appears to be conceded by Newton, and has been insisted upon by Maxwell, that all knowable position is relative. To say that at any instant a body has an absolute position in space, but that we can never know where it is except by reference to other bodies, that is to say that every body has an absolute position, although we can only know its relative position, is to introduce an unnecessary complication, if it is not to talk nonsense.

What is done in practice is to determine the position of a point by reference to a Cartesian system of axes, or by an equivalent method. What is called "the velocity of a body" is its velocity relative to the axes; what is called "the acceleration of a body" is its acceleration relative to the axes; a body has a motion of rotation when the angles between lines of the body and any axis are changing with the time. It is part of the solution of a mechanical problem, as presented by any set of observed facts, to determine the system of axes with reference to which the description of the observed motion becomes as simple as possible, and there exists a calculus for transforming the expression of a motion from one system of axes to another when the relative motion of the two systems is known.

The question how the axes are to be determined has been much discussed, but no general answer appears possible. Particular answers apply in particular cases. In general any three points, not in a straight line, determine a set of coordinate axes. For one of the points may be chosen as origin, the line joining this point to another of the points may be chosen as one coordinate axis, and the plane of the three points may be chosen as one coordinate plane. For the three points any identifiable parts of bodies may be taken; but, in general, axes so chosen will be inconvenient, or, what comes to the same thing, the description of a motion by reference to them will not be simple.

The description of motion is generally made in terms of the concept *force*, that is to say, we state the acceleration relative to the axes which a free body placed in a given position relative to the axes, and moving with a given velocity relative to the axes would have, and the nature of the constraints which give rise to differences of acceleration in a constrained and a free body moving through the same position with the same velocity relative to the axes. In an actual problem the acceleration of a free body whose other circumstances (position and velocity relative to the axes) are known, must be found by experiment. It does not concern the matter now under discussion that among these circumstances position is generally predominant over velocity in determining accelerations. What is of more importance is the fact that *the force acting on a body depends on the system of axes chosen*. For the force is a vector quantity whose line of action coincides with the line of the acceleration relative to the axes, and whose magnitude is proportional to this acceleration. This point has been noted by Maxwell. The result that the field of force depends partly on the axes is frequently a guide to the choice of convenient axes of reference, namely, we choose axes with respect to which the expression of the field of force is simple, and it often happens that in this way all motional forces, other than frictional resistances, can be made to disappear. An easy and striking example of the differences introduced by changing the axes can be found by considering the motion of two particles which move in one of the planes chosen as coordinate planes with uniform velocities in different lines relative to the coordinate axes. If a new set of axes is constructed by taking one of the particles as origin, and the line joining the particles as one axis, the acceleration of the other particle relative to the new axes is directed towards the first particle, and varies inversely as the cube of the distance between the two particles. Another very interesting example is furnished by Foucault's pendulum, to be discussed presently.

These remarks will serve as a preparation for the way in which we interpret, in accordance with the principle of the relativity of motion, those experiences which have been held to favour the view that motions of rotation admit of absolute determination. The history of the discussion appears to show that little would have been heard of this doctrine apart from the desire to explain to a public unused to regard motion as relative the theory of the rotation of the earth. To one who has mastered

the relativity of motion it is manifestly the same thing to say (1) that referred to axes fixed in the earth all the stars describe circles every day about the polar axis, or (2) that referred to axes fixed among the stars the earth rotates about its polar axis once a day. If any ground can be alleged for holding that one of these statements is the simpler, that is a ground for a certain choice of axes, not for saying that one motion is "real" or "absolute," and the other "relative" or "apparent."

All the so-called "proofs of the earth's rotation" are deductions from particular experiences which show that other motions besides the diurnal relative motions of the earth and stars are more simply expressed by referring to axes fixed among the stars than by referring to axes fixed in the earth. They all depend on the specification of "the acceleration due to gravity" near the earth's surface. The neighbourhood of the earth is a field of force, and the magnitude and direction of the force at any point depend on the axes of reference. The specification of the field of force is simplest when referred to the centre of the earth as origin, and to axes fixed in direction with reference to the stars. The field is then expressed by the law of gravitation.

It is worth while to elucidate this matter in greater detail by an examination of the most famous of these "proofs," that by means of Foucault's pendulum. What is observed is that if the pendulum is really free to swing about a point, and if the bob always passes above the same point of a horizontal table (fixed with reference to the earth) when at the lowest point of its swing, then the plane of vibration turns slowly round, so that the line of vibration is above now one, now another line drawn on the table, the oscillation in the line being practically simple harmonic. If this motion were referred to axes fixed with reference to the table, there would be a component acceleration from the bob of the pendulum towards the point of support (to be accounted for by the constraint), a component acceleration in the plane of vibration at right angles to the former which we should recognise as a component of gravity, and a component acceleration perpendicular to the plane of vibration, and proportional at any instant to the velocity in the simple harmonic motion. If we had nothing else to guide us, no observation of the stars, no theory of gravitation, but knew only from less refined observations that free bodies fall downwards with constant acceleration, we should have to do two things: we should have to try to simplify the specification of the acceleration of the bob of the pendulum by referring to a new set of axes, and we should have to conclude that our previous observations of falling bodies had not disclosed all the facts about the field of force in the neighbourhood of the earth. We should simplify the specification of the observed accelerations by referring to axes which (relative to the earth) rotate with the plane of vibration of the pendulum, and we should conclude that such axes are required in order that the laws governing the motion of falling bodies may be correctly formulated. What the experiment with Foucault's pendulum really proves is not that the rotation of the earth relative to the stars is an "absolute motion," but that the system of axes, with reference to which the acceleration of a free body near the earth's surface is of constant amount and directed towards the earth's centre, is not fixed in the earth, but (relative to axes fixed in the earth) these axes rotate with the stars.

It will be found on examination that every other so-called "proof of the earth's rotation" is of the same character. By each it is shown that the earth rotates in the same time and in the same way relative to the axes required for the statement of the law of gravitation as relative to the stars. It is not legitimate to suppose that two relatives make one absolute.

It is true that the conclusion at which we have arrived takes longer to state, and appears at first sight less simple than the statement by way of "absolute motion," but it contains no undefined terms, and no reference to anything assumed to exist, but about which nothing can be known.

Objection has been taken to the attempt to express mechanical theory in terms of relative motion, on the ground that it will be perplexing to beginners, and difficult at any stage. In answer to this it may be urged that in teaching beginners there is no need to say anything about either relativity or absoluteness. The motions that interest them are motions relative to the earth; the motions of boats, trains, cricket-balls, billiard-balls, and machinery; things that can be sufficiently described by reference to lines fixed in the earth. It is only at a later stage when general mechanical theories have to be studied, and a foundation laid for physical astronomy and mathematical physics, that is proper to insist on the relativity of motion; and at this

stage it appears to me more important that our statements of principles should be free from metaphysical obscurity than that they should be verbally short. A. E. H. LOVE.

#### The Antiquity of the "Finger-Print" Method.

SIR WILLIAM HERSCHEL, in his letter to NATURE (Nov. 22, p. 77), expresses his unbelief in the statement in the *Nineteenth Century* (No. 211, p. 365), which ascribes to the Chinese the original invention of the "finger-print" method of personal identification. While I do not know upon what Mr. Spearman has founded this statement, I have collected from a few sources some facts which seem to justify the claim made on behalf of the Chinese.

Although at present I have no record to refer to, it is a fact that every Japanese, old enough to have outlived the *ancien régime* that passed away in 1869, well remembers the then current usage of "stamping with the thumb" (*Bō-in*) on legal papers, popularly called "nail-stamp" (*Tsume-in*), on account of the common use of a thumb with the edge of its nail in ink; whereas on papers of solemn contract, accompanied by written oath, the "blood-stamp" (*Keffan*), or the stamp of the ring-finger in blood drawn therefrom, was demanded.<sup>1</sup>

Churyō Katsurakawa, the Japanese antiquary (1754-1808), writes on the subject as follows: "According to the 'Domestic Law' (*Kōra*), to divorce the wife the husband must give her a document stating which of the Seven Reasons<sup>2</sup> was assigned for the action. . . . All [letters] must be in the husband's handwriting, but in case he does not understand how to write, he should sign with a finger-print. An ancient commentary on this passage is: 'In case a husband cannot write, let him hire another man to write the document . . . and after the husband's name sign with his own index-finger.' Perhaps this is the first mention [in Japanese literature] of the 'finger-print' method" (1) This "Domestic Law" forms a part of the "Laws of Taihō" enacted in 702 A.D.; with some exceptions, the main points of these "Laws" were borrowed and transplanted from the Chinese "Laws of Yung-IIwui" (*circa* 650-55 A.D.) (2); so it appears that the Chinese of the 7th century A.D. had already acquired the "finger-print" method.

After the above-quoted passage, Katsurakawa continues thus: "That the Chinese apply on divorce-papers the stamps of the ends of the thumb and four fingers, which they call 'Shau-mū ying' (*i.e.* hand-pattern stamp) is mentioned in 'Shwui-hu-chuen' &c." (3). This "Shwui-hu-chuen" is one of the most popular novels enjoyed by the modern Chinese—so popular that I have met with many Chinese labourers possessing it in the West Indies; its heroes flourished about 1160, and its author lived in the twelfth or thirteenth century A.D. (4). As is usual with many other examples, this novel gives us more accurate descriptions of minor institutional features that co-existed with either the heroes or the author, or both (5). After making careful search in this novel, I can now affirm that the Chinese in the twelfth or thirteenth century used the finger-prints, not only in divorce, but also in criminal cases. Thus the chapter narrating Lin Chung's divorce of his wife, has this passage: "Then Lin Chung, after his amanuensis had copied what he dictated, marked his signature, and stamped his 'hand-pattern'" (6). And in another place, giving details of Wu Sung's capture of the two women, the murderers of his brother, we read: "He called forth the two women; compelled them both to ink and stamp their fingers; then called forth the neighbours; made them write down the names and stamp [with fingers]" (7).

It has been lately suggested by my friend, Mr. Teitaro Nakamura, that possibly the "finger-stamp" was merely a simplified form of the "hand-stamp," which latter method had once been so current in Japan that it gave to the documents the common names "Tegata" (*i.e.* hand-pattern) and "O-hite" (*i.e.* impressed hand)<sup>3</sup> (8). This view applies equally well to

<sup>1</sup> The "thumb-stamp" was equally regarded with the formal engraved seal (*Tsūse-in*), but the "blood-stamp" had nothing to do for identification. For the formula of the latter mode of stamp, see Ota, "Ichiwa Ichigen," new edition, Tokyo, 1778, vol. xiii, p. 30.

<sup>2</sup> The Seven Reasons for divorcing the wife are: (1) filial disobedience; (2) barrenness; (3) licentiousness; (4) jealousy; (5) leprosy; (6) quantity; (7) larceny.

<sup>3</sup> It must not be presumed as a fact that after the "finger-stamp" was introduced, it soon supplanted the "hand-stamp," for even in the seventeenth century the latter was sometimes used, as is instanced in the writing of Kato-Kiyomasa (1562-1611) preserved in a monastery near Tokyo. Cf. Kitamura, "Kiyū Shōran," new edition, 2, vol. iv, p. 16.

the case of the Chinese, for they still use the name "hand-pattern" for the finger-print (see above). That this "hand-stamp" was in use in an ancient kingdom of Southern India, there is a proof in the Chinese records (9).

When we recognize that the hand-marks were early in use for identification by the three distinct nations, the Japanese, Chinese, and Indians, and when we consider that even the teeth marks were so commonly used for authentication in India that the heir-apparent to Asoka Kojja did not hesitate in plucking out his own eyes on recognizing the king's teeth-mark that accompanied the false epistle (10), it would seem quite true that among those ancient nations who were, with few exceptions, ignorant of the use of "written signature" method, it was but a natural process that the methods were invented to apply to identification some more or less unchanging members of human body.

Further, that the Chinese have paid minute attention to the finger furrows, is well attested by the classified illustrations given of them in the household "Fa-tsah-tsa"—the "Great Miscellany" of magic and divination—with the end of foretelling the predestined and hence unchangeable fortunes (11); and as the art of chiromancy is alluded to in a political essay written in the third century (12), we have reason to suppose that the Chinese in such early times had already conceived—if not perceived—the "for ever unchanging" furrows on the finger-tips.

(9) *Reiki*, 27, 11, 1. "Keirin Man'oku," 1800, new edition, 1801, p. 17. (10) Y. Hagino, "Nihon Rekishi Hy-rin," 1843, vol. vi, pp. 2, 24. (11) Same as (10). (12) Takizawa, "Gendo H-gen," 1818, vol. ii, chap. xli. (13) C. Davis, "China," vol. ii, p. 192; Bazin, "Théorie Chinoise," Introduction, p. li. (14) *Sin-tsing*, n. 26. "Shwai-lin-chuen," Kin's edition, Canton, 1883, 100, xii, p. 4. (15) *Reiki*, tom. xxx, p. 18. (16) C. Terashima, "Wakan San-ai-zue," 1743, tom. xv, art. "Tegya." (17) T'wan Ch'ing-shih, "Yi-yang Tsah-tsu," ninth century A.D., tom. xiv. (18) Huen-t'ang, "Ssu-y-ki," sub. "Takcha-sha." Hirata, "Indo-zoshi," MSS, vol. xxi, pp. 10-11, 26. (19) Terashima, *op. cit.* tom. viii, art. "Nins-oni." (20) "Kan-tetsu-zu," tom. xvii, sub. "Kwei-shi."

KUMAGESU MINAKATA.

15 Bitchfield Street, Kensington, W., December 18.

Peculiarities of Psychological Research.

MAX I enter an emphatic protest against the notion insinuated both by Mr. Wells and Prof. Karl Pearson, that "Psychical Researchers" are a sort of sect engaged in "spiritualistic or other propaganda." Most people, I am afraid, fight shy of psychological research, either because they are afraid that there is a "devil" in it, or because they have a scientific opinion in which they are afraid of losing. I do not know to which category Mr. Wells belongs, but apparently he fails to understand that in order to make out a case against psychical research it is not to show, not that the existence of telepathy and clairvoyance has not been proved, but that there is not even a probability of success with investigating. When we remember that ten years ago the term "medium" was included along with telepathy and clairvoyance, we shall not attach much importance to such efforts to discredit it. Even if the result should be to confirm Mr. Wells' opinion, and show that all the coincidences that have been reported are explained away as mistakes or mis-statements, the matter will yet have been worth the labour bestowed on it, if only for the sake of a manure of the value of testimony to the matter. And if this comes to pass, the bugats of science will be rich enough to claim a share in the work, if only by saying, "I told so."

I do not know what Prof. Karl Pearson means by his quite gratuitous attack on "the scientific acumen of the psychical researchers." Surely he cannot mean that they overlooked the point which he has mentioned. The instructions to the experimenters were that "the agent should draw a card at random, and on the paper between which draw" ("Phantasms of the Living," vol. i, p. 33, foot-note). Could an abnormal distribution of the cards affect the result if those precautions were taken, or has the Professor any reason to suppose the instructions were not carried out? I. D. ALEX. T. DIXON.

Cambridge, December 14.

THE following are a few of my grounds for questioning the scientific acumen of the psychical researchers:—(1) M. Richet's experiments are cited as if they were significant of telepathic action. On the contrary, they give odds of so little weight that they are significant of nothing but want of acumen. I have in card drawing, tossing and lottery experiments, all conducted with every precaution to secure a random distribution, obtained results against which the odds were more considerable. (2) Mr. Dixon is unable to see the importance of ascertaining whether there was an abnormal distribution in the cards cut or the cards guessed. His inability is a strong confirmation of my standpoint. (3) I have heard lectures, and read papers written by psychical researchers. Both alike seem to me akin to those products of circle squarers and paradoxers, with which, as a reviewer, I am painfully familiar. As a concrete example, I take my friend Dr. Oliver Lodge's psychical papers. They are typical, to my mind, of the manner in which the scientific acumen of even a professed and most highly competent man of science vanishes when he enters this field of "research."

I do not intend to take part in a controversy on the subject at the present time, but I do suggest that no better exercise could be found for a strictly logical mind with plenty of leisure than a criticism of the products of the chief psychical researchers. Such a criticism would be of much social value, in the light of recent attempts to popularise the "results" reached by these investigators.

KARL PEARSON.

University College, London, W.C., December 10.

The Artificial Spectrum Top.

I HAVE read with interest Prof. Living's theory of my artificial spectrum top as summarised in NATURE of Dec. 13, p. 107, and am sorry I did not know of his conclusions before he made them public, because a very simple experiment would, I think, have convinced him of their inaccuracy. If Prof. Living, or any of your readers, will examine my top rotated in the light of a 2 1/2 sodium flame, they will find that the colours are quite distinct. I know of no other way of seeing blue and red by the light of sodium, and the phenomenon, I think, shows decisively that the colours of the top are "artificial" sensations in the sense explained in my theory of the instrument.

December 10.

CHARLES E. BENHAM.

I HAVE examined Mr. Benham's top by the light of a bright sodium flame, but have failed to see anything like the colours which I see by daylight or by the light of an incandescent electric lamp. By the sodium light the outmost three circles appear, when the rotation is one way, to be dark brown, the inmost three dark leaden grey, while the intermediate circles are paler brown. Reversing the direction of rotation interchanges the appearances of the outmost and inmost three circles. I cannot see any red or blue, or green, in any case. Other people here seem to see much the same as I do when the top is illuminated by the sodium flame only. With certain black and white figures of my own, I can get a pink appearance in the sodium light, but no green or blue. With spiral figures, which are worrying to look at, I find that some people can see a play of colour even with the sodium light, but I do not see it myself. Using a turn-table, by which the rate of rotation can be regulated at will, I have found that the speed, in white light, required to bring out the colours is decidedly different for different people. This fact convinced me that the explanation of these very curious appearances must be looked for in some physiological cause. It is perhaps worth remark that a sodium flame, when there is much sodium in it to make it bright, is by no means monochromatic, though sufficiently so to make the experiment with the top a very interesting one; and as Mr. Benham sees colours by this light which some others fail to see, it goes far to prove the phenomenon to be subjective.

Cambridge, December 10.

G. D. LIVING.

"Solute."

PLEASE REFER to the words "solvent" and "solution," some word is very badly wanted to express "the dissolved substance." The analogous word is evidently "solute," and it is as short and euphonious as the others. May I inquire why it is not in general use? Surely some one must have proposed it?

Leipzig.

F. G. DOSSAN.

### "The Elements of Quaternions"

IN answer to my reviewer's question (*vide* p. 154), I must frankly admit that

(a) Eq. 8, p. 40, should have been a group of six equations,  $i^2 = \sqrt{-1}$ ,  $j^2 = \sqrt{-1}$ , &c.; and that

(b) The inference should have been that  $i$ ,  $j$ , &c., are (unequal) square roots of negative unity. H. W. L. HIME.

### THE LICK OBSERVATORY.

THE recent issue of volumes ii. and iii. of the "Publications" of the Lick Observatory serves to give some indication of the growing activity of this world-famed institution, and to foreshadow the great part which it is destined to play in the astronomy of the future. As in the case of so many other observatory publications, these volumes contain much with which the various astronomical journals have already made us familiar, and one of their chief objects appears to be to collect the observations into a convenient form for reference.

Volume ii. is entirely devoted to the magnificent micrometric work on stars and nebulae performed by Mr. Burnham during his four years' connection with the Observatory, which, to the general regret, terminated in June 1892. It will be a matter of satisfaction to all interested in the progress of astronomy to learn that this keen-sighted astronomer has nothing but praise for the great telescope. He says: "It has more than satisfied the severest tests which could be applied, and the highest expectations concerning its performance have been realised. It is a monument of the genius and skill of the unrivalled opticians, Alvan Clark and Sons, to whom the progress of astronomical work all over the world is so largely indebted." The fact that powers up to 2600 have been successfully employed, further emphasises the excellence of the objective.

Mr. Burnham strongly insists upon the advantages to be gained by the use of a micrometer in which the wires are bright on a dark field. With this method of illumination, he tells us, "any object that can be seen under any circumstances, however faint, can be well and accurately measured. There is no such thing as a star too faint for measurement, if it can be seen at all."

Besides the immense number of numerical results, the volume gives a mass of most interesting information relating to the various objects observed. Some of this has already been published, but many new points have been added. Thus, it appears that the observations of  $\theta$  Orionis show that "the six principal stars are absolutely fixed with reference to each other, so far as any change is concerned which could be detected by observations covering more than half a century." The fulness of the account of this remarkable group, and of the numerous supposed discoveries of stars within the trapezium, furnish an excellent example of the thoroughness which is so characteristic of Mr. Burnham's work. With reference to the very faint star discovered within the trapezium by Mr. Alvan E. Clark soon after the telescope was erected, he writes: "It is a difficult object with the 36-inch, and certainly has never been seen before, notwithstanding the numerous alleged discoveries with telescopes down to three or four inches aperture. Not less than a dozen of these imaginary stars have been distributed about the interior of the trapezium."

To the average astronomer, the star  $\gamma$  Ceti would probably not be of absorbing interest, but to Mr. Burnham it is "the most mysterious and strange double star in the heavens." The companion was discovered by Clark with a 7½-inch, was subsequently measured by Dawes in 1854, and by Burnham with some difficulty in 1888, since when he has not been able to see it even with the 36-inch.

Mr. Burnham finds that "none of the stars which have been supposed from spectroscopic observations to be

close doubles, have shown any evidence of the fact when examined with the large telescope under the most favourable conditions." He then goes on to say that "it is possible some other explanation will be found for the recurrent phenomenon first discovered by Miss Maury in the Harvard spectrum photographs. At all events, it is hardly worth while, until the method has been verified upon some of the numerous known pairs suitable for this purpose, to consume the valuable time of the great telescope in a further examination of objects of this class." One would almost imagine that Mr. Burnham had failed to grasp the fact that the separation of the component stars in such cases, by the spectroscopic method, is solely due to their relative velocity, which in ordinary pairs is relatively small. At any rate, it has been estimated that a telescope of sufficient dividing power to separate the components of  $\beta$  Aurigæ must have an aperture, not of three, but of eighty feet!

Limitations of space forbid further reference to the rich feast which Mr. Burnham has provided; the value of much of his work will probably be only fully realised by astronomers of another age, but at the same time a large proportion of his results are of the greatest immediate interest and value.

Vol. iii. of the "Publications" consists of Prof. Weinek's now well-known selenographical studies; a report on specimens of glass similar to those used in the construction of the great object-glass; an investigation of the glass scale of the measuring engine; and Prof. Keeler's observations of the spectra of nebulae.

It comes as a surprise to us to learn from Prof. Holden's introduction to this volume, that the work of the Lick Observatory is not without danger of suffering for want of funds. Even so small a matter as a suitable instantaneous shutter "could not be constructed until the summer of 1893, for lack of funds and of skilled workmen." In the early stages of the lunar photographic studies, we are also informed that the work would have been seriously interrupted had not the Smithsonian Institution come to the rescue with "several small appropriations of money." The appearance of the present volume has been made possible by the generosity of Mr. Walter W. Law, of New York City, in providing funds to cover the whole cost of producing the fifteen magnificent plates of the moon which embellish its pages. They are modestly described as "a gift to science," and they afford another example of the practical sympathy with astronomical inquiries displayed by so many of our American cousins.

Few will be inclined to deny the great value of the lunar photographs which have been taken at the Lick Observatory, and it is a matter for congratulation that the astronomical world has so soon been made acquainted with the first-fruits of their investigation.

Prof. Holden tells us that it was quite impossible to undertake the investigation of the negatives at the Lick Observatory, owing to the limited staff, and they were therefore placed freely at the disposal of Prof. Weinek, "whose previous experience in lunar observations and in photography, as well as his very unusual artistic skill, made his advice and assistance of extreme value."

No pains have been spared to make the study of the objects selected as complete as possible. As an instance we may mention that Prof. Weinek's drawing of Copernicus, enlarged twenty times from the negative, represents the great labour of 224½ hours, and is described by Prof. Holden as "a monument of skill and patience."

It is proposed that a complete map of the moon, on a scale of 3 feet to the diameter, shall eventually be made, though the practicability of making a map on four times the scale is demonstrated by an enlargement of Tycho. The photograph of the Lunar Apennines, on the 3-foot scale, reproduced in Fig. 1, is a magnificent example of a camera enlargement from one of the negatives.

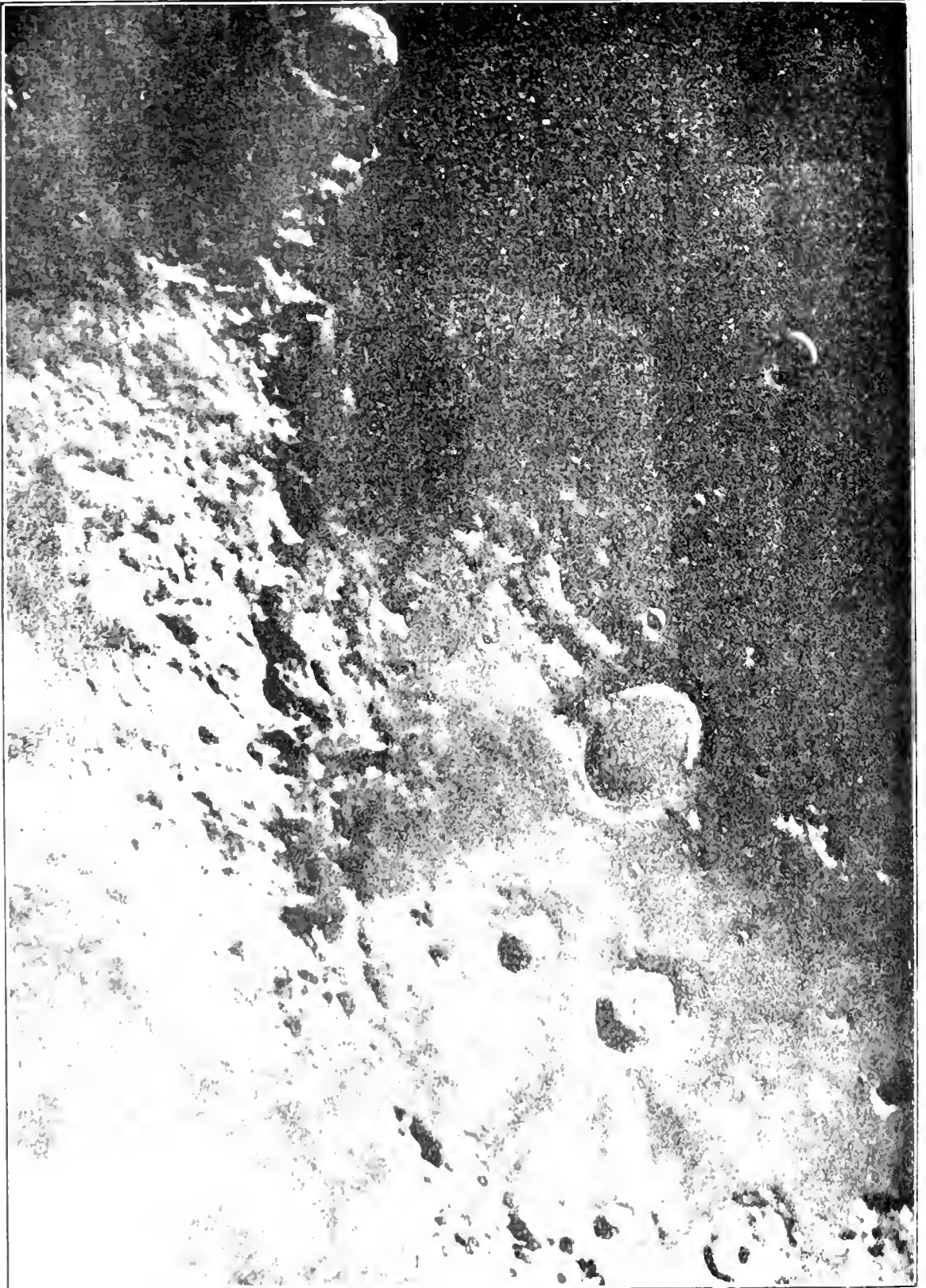



Several points of great interest are touched upon by Prof. Holden, among which is a brief discussion of the dimensions of the smallest object on the moon which can be registered on the photographic plate by the 3-foot refractor. From this we learn that a crater on the moon which is less than one-tenth of a mile in diameter will form an image which is about the same size as the grains of silver in the photographic film, and cannot in general be distinguished. Craters not more than 0.3 and 0.15 English miles in diameter, however, have been detected already. Prof. Holden concludes that for further advances in lunar photography it will be necessary to employ plates of greater sensitiveness so as to shorten exposure, and also plates in which the grain is finer. Workers in all departments of celestial photography have felt the need of such improvements, and, as Prof. Holden remarks, "future improvements depend more upon the manufacturer of plates than upon the astronomer who uses them."

Prof. Weinek's concise descriptions of the lunar formations figured in the volume, and his account of the new features so far discovered, leave nothing to be desired. Observers of the lunar surface may take consolation in the fact that even yet they are not in danger of being entirely superseded by photographic methods, for, as Prof. Weinek points out, "both methods must be perfected, and each must support the other." It is worth remark here, however, that enlargements recently made of lunar photographs taken at the Paris Observatory seem to mark a clear step towards perfection. (See page 207.)

Prof. Keeler's work on the spectra of nebulae during his connection with the Lick Observatory, may fairly be said to mark the commencement of a new era in the history of the spectroscopic instrument of precision. The observations were undertaken in the first instance at the suggestion of Dr. Huggins, who appealed to the Lick astronomers in 1890 in connection with the discussion as to the origin of the chief nebular line. It was found possible to use the third and fourth order spectra of a grating spectroscope with advantage, and even then the spectra were "by no means extremely feeble." Former work left the wave-lengths of the nebular lines uncertain to at least two tenths-metres, but the uncertainties now amount to only a small fraction of a tenth-metre. Further, it is claimed that the observations of the nebulae have shown the existence of errors in Angström's scale and in the wave-lengths of the reference lines, so that the observations did not become consistent until more reliable reference wave-lengths were determined by Prof. Rowland. As an example of the accuracy attainable, the velocity of Venus in the line of sight was found to be 6.4 miles per second at a time when the computed velocity was 7.69 miles.

It is not a part of our present purpose to discuss the origin of the chief line in the spectrum of the nebulae, but we may say that Prof. Keeler does not favour the suggestion that it is due to magnesium; but, on the other hand, his measures definitely decide against the nitrogen origin of the line.

After all corrections have been applied, the normal positions of the first and second lines in the nebular spectrum are stated to be  $5007.05 \pm 0.03$  and  $4959.02 \pm 0.04$  respectively, and neither of the lines is represented among the Fraunhofer lines which appear in Rowland's photographic map. Indeed, we are not aware that either of these lines has ever been recorded as an absorption line in the spectrum of any celestial body whatever.

The observations have not been entirely limited to the determination of the position of the chief line. It has been found, for instance, that "the nebulae are moving in space with velocities of the same order as those of the stars. Of the nebulae observed, that having the greatest

motion of approach, 40.2 miles per second, is G.C. 4373; that having the greatest motion of recession, 30.1 miles per second, is N.G.C. 6790. Most of the nebulae have considerably smaller velocities than these."

It might well be imagined by anyone who has seen a photograph of the Orion nebula that the different parts would have a relative movement with regard to each other. Such, however, does not appear to be the case, according to Mr. Keeler; or, at least, there is no relative movement greater than four or five miles per second. Attempts to measure the velocity of rotation of the large planetary nebula G.C. 2102 showed that there was no radial motion greater than eight miles per second.

A study of the spectra of the nuclei of the planetary nebulae has led Prof. Keeler, as it has independently led Prof. Pickering, to the conclusion that they are very closely connected with the bright-line stars, and thus the latest and most precise work goes to confirm one of the fundamental points of Mr. Lockyer's meteoritic hypothesis.

With reference to the discordant accounts of the spectrum of G.C. 826, to which attention was drawn by myself in 1889 (NATURE, vol. xli. p. 163), it is stated that Dr. Huggins's observation of a continuous spectrum in 1864 "was evidently a mistake," the spectrum being of the usual bright-line type.

Apparently in order to reconcile the presence of a continuous spectrum in such a nebula as that of Orion with the idea that masses of rarefied gas were alone in question, it has been suggested that this continuous spectrum may really be a large number of adjacent bright lines. The enormous dispersion employed by Prof. Keeler, however, fails to resolve it into lines, and thus Prof. Tait's suggestion as to the meteoritic constitution of nebulae still stands as the best explanation of the spectrum.

Many other points of interest are raised by Prof. Keeler's admirable work, but sufficient has been said to indicate the progress which has been made in this branch of celestial physics and chemistry. Although Prof. Keeler has now removed to the Allegheny Observatory, his successor at the Lick Observatory—Prof. Campbell—has already shown himself to be fully capable of maintaining the spectroscopic department of the Observatory at the same high standard of efficiency.

A. FOWLER.

#### STUDIES OF A GROWING ATOLL.

THE researches of the surveying ships of the British Navy have from time to time rendered services to science no less important than those which it is their function to perform for navigation. It has become an established practice to encourage the surgeons of these vessels to undertake scientific investigations in the leisure which their professional duties frequently afford, and facilities are sometimes given for a competent man to continue such work by allowing his transference to another vessel when his own has to leave the place where he has been working. For this the Admiralty deserves credit and the thanks of those who desire to see her Majesty's ships maintaining the position they took up in the days of Cook, and continued through the voyage of the *Beagle*, and the long line of expeditions which followed it, to the voyage of the *Challenger*. While it may not be too much to hope for a renewal of special marine research by the Royal Navy before private enterprise reaps the waiting scientific harvest of the unknown Antarctic, we feel that too much prominence cannot be given to the good work done incidentally in the course of routine surveys.

The hydrographer, Captain Wharton, in his preface to the reports of Mr. Bassett-Smith on the *Macclesfield*

bank, expresses the general result of this piece of research very clearly and concisely, showing that its value is fully recognised by the authorities at the Admiralty.

The Maclesfield Bank is a shallow patch, rising rapidly from deep water in the middle of the China Sea, crossed by the parallel of 1° N., and frequently passed by vessels. It is of an oval shape, about 80 miles long and 37 wide, with a general depth of about 40 fathoms. Reports having been made of very shallow water on the edge of this bank, forming a possible danger to shipping, a complete survey was resolved upon, and as preliminary soundings had shown indications of a raised rim, instructions were given to pay special attention to the animal life upon what might turn out to be an atoll entirely beneath the surface of the sea. Half of the reef was surveyed by Captain Moore in the *Penguin* in 1892, and collections made by means of dredges and divers, under the superintendence of Mr. Bassett-Smith, several tons of specimens being subsequently despatched to the Natural History Museum for full study. The remainder of the bank was examined in 1893 by Captain Field in the *Zetland*, which ship Mr. Bassett-Smith had exchanged in order to continue his work, and the result is such an investigation into the biological conditions of a submerged coral reef in mid-ocean as has never been made before.

The whole circumference of the bank rises as a ring of coral to within from 9 to 15 fathoms of the surface, being broken here and there by wide gaps of greater depth, but never so deep as the central depression, which varied generally from 40 to 48 fathoms. The minimum depth on the rim was 6½ fathoms, and an isolated shoal rising from the centre of the inner depression reached to within 5 fathoms of the surface.

The uniformity of the depth appears to Captain Wharton to be a strong argument against any movement of the bottom since the period when the atoll form was assumed; and he shows that the simple growth of coral on the rim will in time suffice to produce a perfect ring-shaped coral island without the aid of subsidence or upheaval. It appears, in fact, that here is an atoll in course of formation on a foundation sufficiently near the surface to allow coral to grow. Such a foundation, Dr. Murray admitted might allow a coral island to form without subsidence, and the recently discovered abundance of similar elevations in the tropical oceans is one of the main arguments for Murray's general theory of coral growth.

Mr. Bassett-Smith's first day's dredging convinced him that the Maclesfield Bank was by no means a "drowned atoll," but on the contrary that it was very much alive. The basis of the bank appeared certainly to be dead coral rock, or in many places a calcareous rock composed of the consolidated vegetable organisms which are so common between the depths of 20 and 50 fathoms. Upon this ground corals grew in great patches, and other forms of life were very abundant, especially echinoderms, molluscs, crustaceans, and annelids, many of which bore a close resemblance to those which were discovered in the atoll. Altogether forty-one genera of coral were recorded, excluding alcyonarian and hydrocoral genera, and one occurred between 3 and 5 fathoms, and twenty-seven genera in deeper water. It appears that the shallow corals can thrive at depths a great way below the conditions of the Maclesfield Bank, where the water is very clear and the temperature of the surface is exceeded, Mr. Bassett-Smith says.

The most universally distributed were *Seriatopora*, *Pavonia* (especially a variety of forms very nearly allied to *Mycodium elegans* of Milne Edwards), *Leptoseris*, *Montipora*, and *Stylophora Guntheri*, at all depths, but the sections 'Madreporaria Fungida' and 'Perforata' are undoubtedly most frequently met with in depths over 20 fathoms, and continued down to between 40 and 50 fathoms: the corallum being almost always light and delicate. *Agaricia*, *Phyllostroea*, *Pachyseris*, *Turbinaria*, and *Leptoseris*, in cups of varying size, from two inches to twenty inches across; *Oxyphora*, *Pavonia*, *Hydrophora*, *Scaphophyllia*, and *Montipora*, in leaf-like expansions; *Cyphastræa*, *Galaxea*, *Turbinaria* and *Montipora*, in encrusting growths; or in branching forms, as *Seriatopora*, *Mussa*, *Madrepora*, *Psammocora*, *Napopora*, *Anacropora*, *Alveopora*, and *Rhodaria*; the most massive forms found in deep water being *Pocillopora*, *Stylophora* and *Mussa*. On the sandy bottom of the lagoon, and near the rim, the corals that seemed to thrive best were small branching forms of *Psammocora*, and *Anacropora*; delicate frond-bearing clumps of *Pavonia*; *Leptoseris* cups, thick but light spreading branches of *Alveopora*, *Montipora*; and many simple corals as *Cycloseris*, *Fungia*, &c. Small fragments of more massive *Astræa* were brought up three times from deep water, twice from 30 to 40 fathoms, and once from 40 to 50 fathoms."

There was a strong current over the rim, even in calm weather, and the surface water, the temperature of which was sometimes as high as 88 F., swarmed with Plankton.

In addition to the chart of the bank showing its unmistakable atoll form, the blue-book contains two sections of the outer slope on a natural scale. The angles varied somewhat on different sides. On the north the slope was gradual, the 100 fathom line being one mile distant from the 20-fathom line, while 200 fathoms was only found ten miles farther out, beyond which the slope became more rapid to 1100 fathoms six miles beyond. On the east there was a much steeper slope, the 100-fathom soundings being found half a mile from the 20-fathom and 300 at the distance of a mile, while fifteen miles away the depth was 2100 fathoms. The wall-like spring of the bank from the ocean floor is still more striking on the south, where depths of 150 fathoms occur half a mile from the edge of the bank, 300 fathoms at the distance of one mile, and the oceanic depth of 1100 fathoms, only 3½ miles away, giving the remarkably high average slope of 1 in 3. The shoal at the north end of the future island is attributed to the strong current from the south-west sweeping the debris over the edge of the oceanic hill into the deep beyond.

The observations fully confirm Dr. Murray's preference for the term "organic" rather than "coral" as applied to the origin of atolls, for a very large part of the growing rock was shown to be due to calcareous algae, to corals other than reef builders, and to the accumulation of the calcareous remains of crustacea, mollusca and annelids. Mr. Bassett-Smith suggests that the crust of algae prevents the dissolved carbonic acid of the sea-water from touching the dead coral rock below, while the action of the growing algae might decompose the carbonic anhydride. This we are inclined to doubt, as the decaying organisms would seem likely to produce far more carbonic acid than could be disposed of by the very feeble daylight which reaches depths approaching 40 fathoms; and from the continual dredging of "rotten rock" in the central depression, we feel inclined to think that active life and rock-growth are taking place there only in restricted patches. The observations seem to leave no doubt that the atoll is growing towards maturity and the air, not declining from a past existence as an island.

HUGH ROBERT MILL.

## NOTES.

PROF. GEORGE FORBES, F.R.S., who has for the last three years been engaged on the utilisation of Niagara Falls, has, we understand, just returned to this country from the United States, the construction stage of the work being now completed. The close of the three years of Prof. Forbes's connection with the great work at Niagara Falls, which marks the change from the period of design and construction to the period of commercial activity in the existence of the Niagara Falls Power Company, forms a fitting opportunity for expressing the sense of gratification that all Englishmen, and the scientific world in particular, must feel in having had one of their

evolved a system which for completeness, adaptability, and security against breakdowns, had not been dreamt of before. The adoption of the alternating current before its value was fully realised by others, the initiation of the world in the use of a lower frequency than any that has hitherto been employed, and the remarkable confirmation of the foresight as to the economy of large transformers at high electric pressure, even at the low frequency employed, that has been established, are matters for congratulation. Although for fuller particulars of the system and apparatus employed, we must refer our readers to a previous account (*NATURE*, vol. xlix. p. 482), we may draw attention to the method by which Prof. Forbes met one of the most troublesome questions in connection with the design of

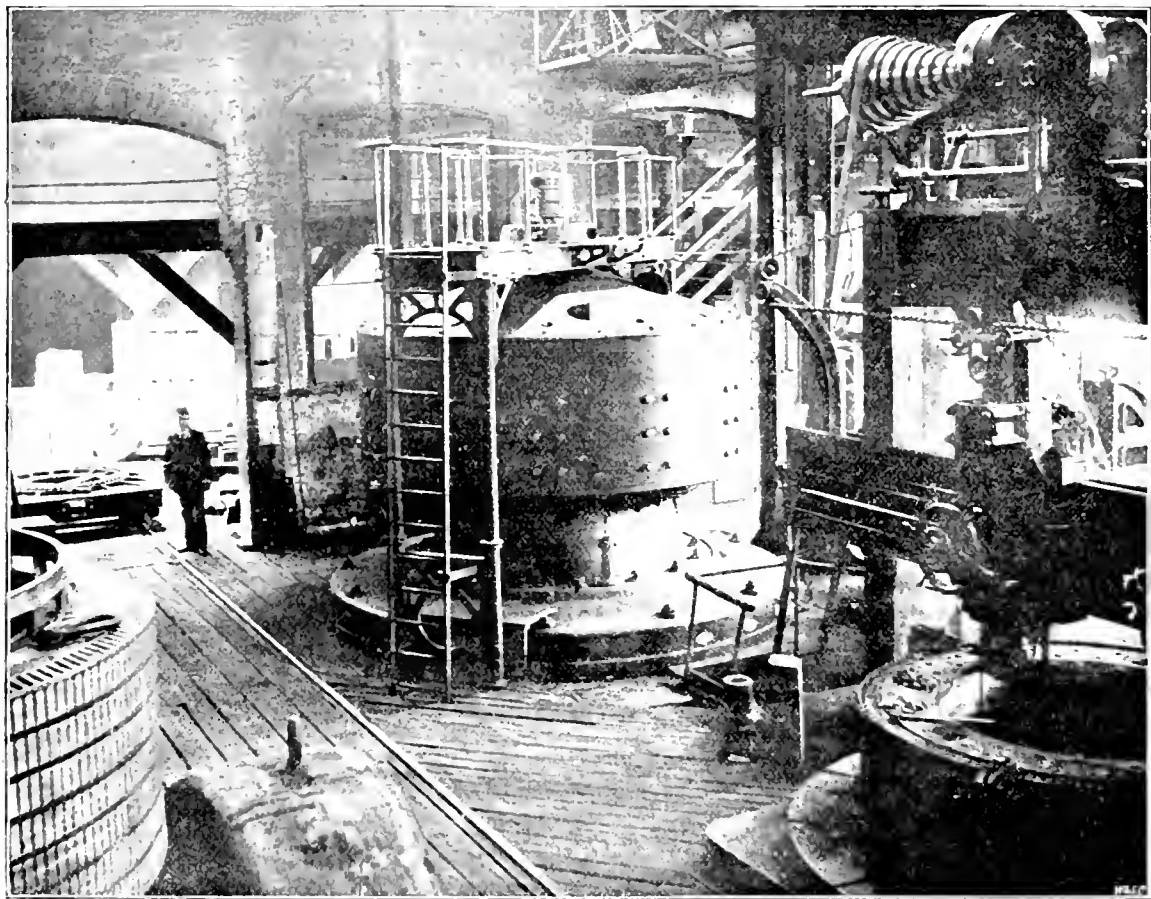

FIG. 1.

countrymen chosen to undertake the important and difficult duties of electrical consulting engineer to an undertaking of such magnitude. The manner in which those duties have been discharged, and the pioneer services which Prof. Forbes has rendered them in respect of the work, have, we are in a position to say, received most gratifying testimony and cordial acknowledgment from his Company, who recognise in Prof. Forbes the scientific attainment, combined with independence of thought and action, which have been invaluable throughout the stage of operations now completed. Few realise the many novel conditions that have had to be met at Niagara Falls. But by dint of years of study of the many problems presented, Prof. Forbes has

the 5000-horse power generators (Fig. 1), arising in consequence of some requirements of the turbine designers—viz. the securing of a certain necessary momentum of the revolving part of the dynamo, without increasing the weight to be supported by the hydraulic piston in the turbine above a certain limit. The difficulty was met by fixing the armature, and revolving the field-magnet, formed of a nickel-steel ring with the pole-pieces pointing radially inwards, outside, the ring, or yoke, and the pole-pieces being supported by a bell-shaped cover fixed rigidly to the top of the vertical shaft from the turbine, the shaft being supported by bearings in the interior of the fixed armature. The foreseen ability to convert the alternating current into continuous current, and the low frequency into high frequency, which is

now realised in the invention of Messrs. Hutin and Leblanc, gives greater elasticity to the system; while the precautions taken to avoid sudden opening or closing of the circuits, gives a security against troubles experienced in the past by others such as has not been obtained before. The success that has attended Prof. Forbes's efforts during the period of design and construction is of good augury for a successful issue to the commercial stage which the Niagara Falls Power Company now enters upon.

REUTER reports that a violent earthquake shock, lasting one minute, was felt at Oravica, South Hungary, at 10.35 p.m. on December 19. Many houses fell in, while the walls of others were seriously cracked.

A BACTERIOLOGICAL Institute is about to be established in the University of Kiev (says the *British Medical Journal*), at an estimated cost of £10,000. A well-known druggist of Moscow has also given a house, valued at £3000, with £500 towards the fitting up of it as a bacteriological laboratory.

WE regret to record the death, on the 19th inst., of Prof. Allen Harker, of the Royal Agricultural College, Cirencester, at the age of forty-six. Mr. Harker was a popular and successful teacher, and did good work, not only at the College, but in connection with County Council technical education schemes, both in Gloucestershire and Bedfordshire.

THE Italian Botanical Society has decided to hold its annual meeting for 1895 in Palermo, in the latter part of April.

THE influence of the Royal Gardens at Kew upon other Botanic Gardens is strikingly shown in a list of the staffs of botanical departments and establishments at home, and in India and the Colonies, given in the *Kew Bulletin* (Appendix III.). Disciples have gone from Kew to the ends of the world to become directors or curators of Botanic Gardens; indeed, almost every Garden seems to have on its staff someone trained at Kew, or recommended by the Director there. A clearer testimony of esteem could not be desired.

FROM Mr. Carruthers's Report of the Department of Botany in the British Museum for 1893, we learn that the herbarium received some valuable additions during that year by gift and purchase. The most important were Mr. Deby's great collection of diatoms, numbering nearly 30,000 named slides; the late Mr. Jenner's collection of over 6000 specimens of algae, a collection of over 1000 of the lower cryptogams of Dominica and St. Vincent, presented by the committee for the exploration of the West Indies; and a large number of flowering plants from Malaya, presented by Mr. Ridley.

A VIOLENT fall of the barometer on Friday, the 21st inst., made it clear that a serious disturbance was approaching our shores from the Atlantic. By 6 p.m. of that day a "fresh" gale had already set in on the north-west coast of Ireland. During the night the gale rapidly crossed Scotland, and the whole of the United Kingdom experienced severe westerly gales, which occasioned great damage and property, and although the storm area subsequently crossed the North Sea, violent north-westerly winds continued to rage the whole of Saturday. The aneroid at Greenwich on Saturday morning showed a pressure of 29.6 in. on the scale of 30, which is equivalent to a velocity of about 70 miles in the hour; but considering that the centre of the disturbance was at that time at least 400 miles to the north, there is no doubt that considerably higher velocities occurred in other parts of the country. In Scotland the barometer fell more than an inch and a half in 24 hours, and the subsequent rise was even more rapid.

WE have received two numbers of *Zentralblatt*, a monthly pamphlet published by the Technical Education Committee of

the Essex County Council. Under the direction of Mr. Houston the problem of reconciling the practical requirements of this district with a really scientific method of instruction in biology seems to be in rapid progress towards a satisfactory solution. Pioneer lectures are given, short courses for farmers and gardeners on such immediate topics as plant diseases, and systematic and largely practical courses of study in botanical science, at the Chelmsford Laboratory, and at various local centres. In addition, the Chelmsford Laboratory is rapidly becoming a centre for inquiry into, and the discussion of, agricultural problems. During the last three months the influence of ergot on gravid cattle, the toxic effect of bracken fronds, certain samples of foreign hay that had caused disease, and the distribution of potato disease, among other topics, have received attention. The combination of elementary instruction in science, on the one hand, with original inquiry on the other, and the practical simplicity of both departments of work, appear to us to be admirable features, and we would recommend it to the attention of those who are interested in Technical Education in similar districts in other parts of the county.

FIELD experiments of an instructive kind are carried on at the Royal Agricultural College, Cirencester, under the direction of Prof. E. Kinch. A pamphlet just received contains an account of experiments on oats grown this year on twenty-four plots differently treated. The general results were as follows:—The smallest yield of corn was from the plots receiving ammonium salts only, the unmanured plots, and the plots receiving cinereal manures only. The highest yield of corn was from the plots receiving four teen tons of farmyard manure every year since 1885, followed by the plots receiving cinereals and mineral nitrogen, and phosphates and mineral nitrogen. The largest amount of straw was also given by the plots which had received the larger amount of farmyard manure annually, followed by those receiving mineral nitrogen with phosphates. The withholding of potash appeared to make little or no difference in the yield of straw, but the withholding of phosphates made a difference. The unmanured and cinereal manured plots gave the least straw. Experiments were also made to determine the crops of hay from twenty plots, to which different kinds and quantities of manures had been applied.

THE last issue of the *Zentralblatt für Physikalische Chemie* (vol. xv. part 3, p. 386) contains a paper by Messrs. Rival Pietet and Alschul on "Phosphorescence at very Low Temperatures," which is of special interest in connection with recent work on this phenomenon. Glass tubes containing the sulphides of calcium, strontium, and barium were exposed to sunlight, and the duration and the extent of the phosphorescence were noted. The various tubes, after having been again exposed to sunlight, were plunged into liquid nitrous oxide, the temperature of which, by rapid diminution of pressure, could be brought to  $-140^{\circ}$ . After twelve minutes' immersion the tubes were brought into a dark room, and their behaviour carefully observed. At first no indication of phosphorescence could be seen. In a few moments the upper part of the tube, which had not been so strongly cooled as the rest, began to phosphoresce, and gradually the feeble light seemed to spread itself down the tube, the lower part of which, however, glowed much more feebly than the upper. After five minutes the tubes acquired their ordinary vivid colour, without subsequent exposure to sunlight or even to diffused daylight. All phosphorescent substance appeared to behave in this way. Further experiments were then made in order to determine the limits between which these phenomena occurred. For this purpose a quantity of alcohol was cooled to  $-80^{\circ}$ , and in it a tube containing some phosphorescent substance, after insulation, was immersed. That portion of the tube which was surrounded by alcohol in the outset glowed feebly, but in proportion as it took up the tempera-

ture of the cooled liquid its phosphorescence diminished, until at  $-65^{\circ}$  it entirely disappeared. The portion of the tube above the alcohol continued to phosphoresce strongly. After thirty minutes' immersion in the cooled alcohol, the tube was removed, and as it gradually acquired the temperature of the air, the lower portion began to glow. Before the glow—blue, green, or orange in colour, depending on the nature of the metallic sulphide—entirely disappeared, the colour became a faint yellow. It was found by comparative experiments that the alcohol exerted no specific influence on the results. These seemed to be entirely dependent upon the diminution or total cessation of molecular vibrations at the low temperature.

An interesting paper on the Sicilian earthquakes of last August has recently been published by Dr. Mario Baratta (*Boll. della Soc. Geogr. Ital.*, Ott., 1894). The first shock of the series was felt on July 29 at Randazzo, and was succeeded by several other slight shocks, mostly in the Lipari Islands. Then came the severe earthquake of August 7 at 12h. 58m. p.m., and the still stronger one of August 8 at 5h. 16m. a.m. (Greenwich mean time). These affected chiefly the south-eastern slope of Etna, and were followed by more than twenty shocks in the same district, lasting until August 26. The meizoseismal area of the principal earthquake (August 8) is only about 7 km. long and 3 to 4 km. broad, and, as the intensity diminished rapidly outwards, it would seem that the focus cannot have been far from the surface. Moreover, the longer axis of this area runs north-west and south-east, and, when produced, passes through the central crater of Etna. It therefore probably coincides with a radial fissure of the cone, and indeed is not far, if at all, distant from that along which the eruption of 1329 took place. The pressure exerted by the column of lava in the central funnel, or by the forces which have raised it to its present height, may have caused such a fracture to be reopened. Thus, it is not impossible that the recent earthquakes indicate an unsuccessful attempt at a new lateral eruption.

FURTHER details relating to the same earthquake are given in the *Bollettino Meteorico* (Suppl. 110) of the Geodynamic Office of Rome. The depth of the focus of the principal earthquake, according to Prof. Riccio, was about 4 km. The pulsations were recorded at Rome by the great seismograph, consisting of a pendulum 16 metres long, with a mass of 200 kg.; the first traces at 5h. 17m. 30s., and the principal maximum at 5h. 18m. 55s. The pycnometer of the Observatory of Catania shows a trace about  $21\frac{1}{2}$  mm. long, indicating a temporary lowering of the well-water, which, in returning, stopped about 4 mm. below its original level.

THE additions to the Zoological Society's Gardens during the past week include a Yellow Baboon (*Cynocephalus babouin*, ♀) from Fort Salisbury, South Africa, presented by General Owen Williams; two Grisons (*Gallieti vittata*) from Brazil, presented by Mr. H. A. Catlett; a Song Thrush (*Turdus musicus*), a Goldfinch (*Carduelis degans*, British, presented by Mr. B. M. Smith; a Grenadier Weaver Bird (*Euplectes oryx*, ♂) from West Africa, presented by Lady McKenna; a Wild Cat (*Felis catus*) from Scotland, deposited; five Shore Larks (*Otocorys alpestris*), British, purchased.

OUR ASTRONOMICAL COLUMN.

ADVANCES IN LUNAR PHOTOGRAPHY.—MM. Lowy and Puiseux recently communicated to the Paris Academy a paper on photographs of the moon, taken at the Paris Observatory, by means of the great Condé equatorial. Some of the photographs have been enlarged by Dr. Weinek, and the enlargements seem to have excelled in beauty and detail previous lunar pictures of a similar kind. An examination of the photographs shows that not

only can they be used to verify the general features of the moon's surface, as depicted upon the most recent and complete lunar maps, but they also show a number of details and small craters which so far have been omitted from such maps. There are, of course, a number of causes which prevent a single photograph from being an ideal representation of a celestial object, and enlargements are usually regarded with a certain amount of suspicion, for there is always a possibility that interesting formations will be unconsciously manufactured in the process. MM. Lowy and Puiseux know this as well as anyone; nevertheless, they find that the enlargements undoubtedly reveal new features, and definitely determine the existence of several contested objects. They think an instrument of long focus is essential for the best results, and that the enlargements should not be carried beyond twenty or thirty diameters. One object upon which the photographs have thrown light is the small isolated crater Linné, situated in the middle of the Sea of Senenit. According to Shroeter, Beer, Maedler, Lohrmann, and other selenographers, this crater was distinctly visible up to 1866, when Schmidt announced its disappearance. It was afterwards discovered again, but was much smaller than when described and figured by Beer and Maedler. Dr. Weinek finds that the object appears upon a plate taken on March 14, but only one kilometre in diameter—that is, about one-tenth the value assigned to it by the earlier observers. The crater has also been found on other plates, and Sig. Schiaparelli has testified to its reality. Four new objects—three craters, and the fourth an isolated elevation of some kind—have been found in the plain which extends to the south of Ariadaeus, between the bright crater-plain Cayley and the Silberschlag crater. Ten new craters can be detected in the typical walled plain Albatagnius. All the rills observed to the west of Triesnecker can be seen to extend beyond the limits previously assigned to them, and to connect Ariadaeus, Hyginus, and Triesnecker with interlacing clefts. Judging from these results, we cannot but conclude that the photographs represent real advances in lunar photography.

COMETARY EPHEMERIDES.—The following ephemeris for Encke's comet is in continuation of that given on November 22, and is due to Dr. O. Backlund. M. Schulhof's ephemeris, in the *Astronomisch. Mittheilungen*, No. 3267, is used for Swift's comet:—

Date	ENCKE'S COMET. Ephemeris for Berlin		SWIFT'S COMET. Ephemeris for Paris	
	R.A. (app.) h. m. s.	Decl. (app.)	R.A. (app.) h. m. s.	Decl. (app.)
Dec. 28	22 14 57	3 35 18	0 3 25	0 20 22
30	14 27	3 19 58	0 8 33	0 17 53
Jan. 1	13 52	3 3 38	0 13 41	0 53 45
3	13 9	2 45 51	18 46	1 33 10
5	12 16	2 29 7	23 49	2 10 0
7	11 8	2 3 47	28 51	2 49 41
9	0 42	1 58 1	33 50	3 22 44
11	7 52	1 7 53	38 48	3 58 19
13	5 31	+0 32 10	43 43	4 33 24
15	2 32	-0 10 34	48 37	5 8 0
17	21 58 47	1 2 10	53 29	5 42 5
19	51 3	2 4 42	58 19	6 15 42
21	48 10	3 20 29	13 8	6 48 48
23	40 57	4 51 53	7 55	7 21 21
25	32 43	6 40 45	12 41	7 53 20
27	21 57	8 47 28	17 26	8 25 4

It will be seen from these ephemerides that the two comets are in the same region of the sky, both being a few degrees south of Pegasus. Observations of the comets are greatly needed.

RUSSIAN ASTRONOMICAL OBSERVATIONS. The latest *Bulletin* (vol. xxxv, No. 4) of the Imperial Academy of Sciences at St. Petersburg is almost entirely devoted to astronomical papers. L. Lindemann contributes a discussion of the visual and photographic magnitudes of Nova Aurigæ, and gives a light curve extending from December 10, 1891, to April 13, 1892. N. Nyren discusses the observations made at Pulkova with the vertical circle, between 1882 and 1891, from the point of view of variations of latitude. The curves derived from the observations indicate that the interval between two maxima is 433 days, and between two minima, 434 days. As to the amplitude of the variation, though no definitive result is stated, the value of the radius of the circle described by the instantaneous pole appears to be 0.145, and the direction of

mation from west to east. Another paper on the same subject is contributed to the *Bulletin* by S. Kowinsky. In this case, the observations and calculations were made with the great meridian instrument of the Pulkova Observatory, mounted in the prime vertical. The period obtained was 411 days, and the amplitude 521. In addition to these papers, there is one on the orbits of Halley's comet, deduced by M. Besselin from observations made in 1892.

*N. A. REMARKABLE EARTHQUAKE DISTURBANCE OBSERVED AT STRASSBURG, NICOLAIEW, AND BIRMINGHAM, ON JUNE 3, 1893.*

INTRODUCTION NOTE.

*J. M. H. Bullen, F.R.S.* The observations described in the subsequent article were made with the horizontal pendulum designed by Prof. Z. Iner, and modified by Dr. von Rebeur-Paschwitz. This instrument consists of three thin brass tubes joined together in the form of an isosceles triangle, the vertical angle of which is about 45°. The two outer sides are prolonged slightly beyond the base, and to the ends are attached two small spherical agate cups, the centre of the lower one being directed from the centre of gravity of the pendulum, and that of the upper one towards it. When the pendulum is placed in position, these cups rest on two steel points attached to the stand of the instrument and directed normally to the surfaces of the agate cups. One steel point is almost exactly above the other, so that the axis of rotation is nearly, but not quite, vertical, its inclination to the vertical being still great compared with the movements of the ground we wish to investigate. The pendulum rests in the vertical plane passing through the axis of rotation, and on the side towards which it inclines. If this is towards the east, and if the axis is slightly tilted in the east and west plane, there will be no deflection of the pendulum; the only change will be in its sensitiveness. But if the axis is tilted in any other plane, it will no longer incline towards the east, and the pendulum will be deflected from its normal position, in order to remain in the same vertical plane with the axis of rotation. It is evident that the smaller the original inclination of the axis to the vertical, the greater will be the deflection for a given tilt of the axis in the north and south plane; that is, the greater will be the sensitiveness of the pendulum.

From the middle of the nearly vertical tube of the pendulum, there projects outwards a small bar. Passing through an aperture in the frame to which the steel-points are attached, this bar carries a mirror, whose plane is at right angles to that of the pendulum. A ray of light, proceeding from a fixed source, is reflected by the mirror, and registers the movements of the pendulum on a strip of photographic paper wrapped round a revolving drum. The zero-line is traced by a ray of light reflected by a fixed mirror just below the other, and attached to the stand of the instrument.

*Observation at Nicolaiew, Pulkova.*—Nothing could show better than Dr. von Rebeur-Paschwitz's interesting paper how desirable it would be to have a few well chosen stations in different parts of the world where these pulsations could be registered. They might then be traced as they spread out from the origin of great earthquake, and might even be followed, as he suggests, in their course, completely round the world.

In several of our more remote territories are established instruments suitable for this purpose. Horizontal pendulums, with recording apparatus, are in use at Charlsw and Nicolshew in the North of Ireland, and two others will soon be ready at Strassburg and Marsden in Germany. A bifilar pendulum at Birmingham, designed by the British Association, will hardly be far below a photographic recorder. Thus Europe is provided fairly well prepared for.

Large quantities of instruments of this kind are being made by Messrs. Bullen and Wood, and their sale will be of great value to the owners of recording instruments who are situated at places near

the east and west coasts of North America, in South America, South Africa, India, Australia or New Zealand, and the Sandwich Islands. In Japan Prof. Milne's tromometer leaves little to be desired.

The chief element to be determined is the exact epoch of the beginning, maximum amplitude, and end of the pulsations, or of each group of pulsations. The horizontal pendulum, Dr. von Rebeur-Paschwitz informs me, can be arranged so that its sensitiveness for slow tilts of the ground can be diminished without necessarily lessening its sensitiveness for earthquake shocks. The strip of photographic paper can thus be reduced in width without running any risk of the spot of light leaving the paper during its ordinary daily and other movements. Without increasing the expense, a more rapid movement of the paper could be permitted, and this would enable the determination of the time to be made with greater accuracy. Possibly, also, the construction of the instruments might be simplified if earthquake-pulsations are to be the principal subject of investigation. In the bifilar pendulum, for example, since the amplitude of the oscillations is a point of minor importance, the somewhat elaborate machinery for determining the angular value of the scale divisions might be dispensed with, and also the arrangements for readjusting the spot of light from a distance.

Hardly less important in these investigations is the determination of the exact time of occurrence of the earthquake at or near its centre of disturbance. But on this it is the less necessary to insist, for in so many of the more marked seismic districts there now exist organisations for the study of earthquakes. It may not be out of place, however, to suggest that in all seismic records, and in every part if periodically published, the standard time employed should be clearly stated. It is not universally known, for instance, that in Japan Tokio time was replaced on January 1, 1888, by the time of 135° E. long. In accounts from Beluchistan, again, we cannot be certain whether Madras time or railway time is meant, for both are used. The trouble of inserting this important detail is hardly to be compared with the confusion and error that may result from its omission.

C. DAVISON.

IN the last report of the Earth Tremor Committee of the British Association, reference is made to an observation of earth-pulsations by Mr. C. Davison on the evening of June 3, 1893, at Birmingham, which was obtained by the aid of Mr. H. Darwin's bifilar pendulum. I take the following details from the report.—At 5.43 p.m. (G.M.T.) the image was found to be perfectly steady, but at 6.20, when the observer returned to the cellar, it was moving slowly and steadily from side to side of the field of view, thus indicating the passage of a system of earth-waves. At 6.42 the image had come to rest, but at 6.46 the oscillations commenced again, and continued to be visible with varying amplitude until 8.13. After 8.13, though the observer watched for two hours and a half, no further motion was noticed. The period of the waves was found by a number of observations to be between fifteen and twenty seconds, and the range of motion at its maximum one-eighth of a second.

Mr. Davison's observation is especially interesting, because it corresponds exactly with a *very extraordinary disturbance* which was registered by the horizontal pendulums at Strassburg and Nicolaiew. Amongst the considerable number of disturbances common to both these places, that of June 3 is certainly the most prominent during the interval from January 1 to September 4, 1893. In the accompanying illustration (Fig. 1) the two curves, obtained by photography, are shown side by side: in correspondence with the difference of longitude between the two places, the lower curve was moved 17.75 mm. to the left. The pendulum in both cases was placed in the east-west plane. In the following notes the time is Greenwich-Mean Solar Time, and is given in decimal parts of the hour.

(a) *At Nicolaiew.*—The disturbance begins suddenly and small at 4.47, the curve having been perfectly sharp and steady before. The range of motion increases to 4 mm. at 4.52 and decreases at 4.60. It then again increases, so as to make the curve disappear entirely between 4.77 and 5.05. During the interval the high point was displaced by 3 mm. to the north, which corresponds with a deflection of the pendulum towards the south. At 4.82, the person who keeps control over the instrument entered the cellar, to look after it and to determine the time correction, which is done by shutting off the light during

For a full description of the instrument and the observations, see Dr. von Rebeur-Paschwitz's paper, *Ueber die Beobachtung von Erdbebenerschütterungen*, *Monatsh. d. Naturh. Ver. zu Bonn*, vol. 27, p. 107, 1893. See also the paper by J. M. H. Bullen, *Phil. Mag.*, vol. 28, p. 411, 1894.

a known interval of five minutes. He then locked the cellar, and when he returned at 8:45 he was obliged to make a correction,<sup>1</sup> because the light-point had left the paper. Unfortunately, he forgot to note down its exact place, but from the inspection of the curve it is evident that at 5:61, after a short interval of steadiness between 5:25 and 5:61, the pendulum received a sudden shock, which caused it to oscillate, and at the same time produced a deflection, by which the light-point was probably brought off the lower edge of the paper, from which it was distant 48 mm. at the time of the shock. There can be no doubt that such was the cause of the disappearance of the curve, for the base-line runs on perfectly undisturbed, which is a sign that the instrument continued to be in good working order, as usually. From 8:45 to 9:65 the motion is small; and from 9:65 till 11:16 the curve is nearly perfectly steady.

At 11:16 a new disturbance begins: the range of motion is very small at first, but increases to 5 mm. at 11:45, and to 10 mm. at 11:60; at 12:10 the disturbance, which is much like the first one, comes to an end, and is again followed by a steady part of the curve.

At 12:26 commences the last disturbance, which at 12:47 increases to 6 mm. Between 12:73 and 13:03 no traces of the curve are visible, and during this interval a displacement of 10½ mm. has occurred, which indicates a deflection of the

At 11:05 a new disturbance begins, which increases suddenly at 11:36, diminishes a little at 12:3, and increases again at 12:47. From 12:7 to 13:22 no traces of the curve are visible. At 13:9, the motion decreases considerably, and after another small increase at 14:87 reaches its end at 15:17.

The figure shows that the motion at Nicolaiew is much more considerable than at Strassburg. Whilst at the latter place the whole disturbance is divided into four distinct parts, which are separated by moments of nearly perfect steadiness, at Nicolaiew the first and second, as well as the third and fourth part, each form a continuous disturbance.

If we denote by  $V$  the relative strength of a shock in a direction normal to that of the pendulum, by  $a$  the range of motion, measured on the curve, by  $d$  and  $T$  the distance between the photographic drum and the pendulum mirror, and the period of oscillation of the pendulum, then we have the following relation between the observations in two different places:—

$$\frac{V_1}{V_2} = \frac{a_1}{a_2} \cdot \frac{d_2 T_1}{d_1 T_2}$$

In the present case

$$d_1 = 1.8m., d_2 = 4.6m., T_1 = 17.0s., T_2 = 10.2s.,$$

thus  $\frac{d_2 T_1}{d_1 T_2} = 47$ . A shock of the same strength therefore produces at Nicolaiew a disturbance 1½ times as large as at Strassburg.

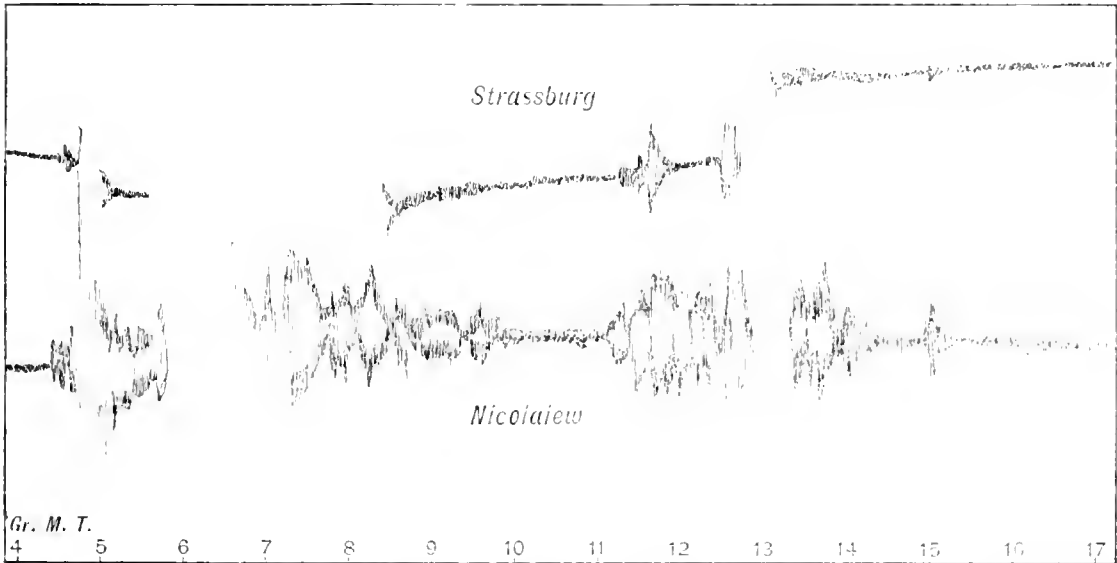

FIG. 1.—Earthquake Disturbance observed at Strassburg and at Nicolaiew on June 11, 1894.

pendulum towards the north. The motion continues to be visible until 14:45; the curve then resumes its nearly steady appearance, which is once again interrupted by small motion at 14:95.

(b) *Nicolaiew*.—The following details were communicated to me by Prof. Kortazzi, who informed me that on this day he went down into the cellar one half-hour later than usually, at 6:54, when he found that the light-point had passed from the paper on to the brass rod, which serves to clamp the paper, and was swinging considerably. From this reason the light-point could leave no traces on the paper between 5:05 and 6:02. The disturbance is very large and of long duration. It commences at 4:32 and reaches its first maximum at 4:50, when the range is .60 mm. Strong motion continues until 8:4. From the copy of the disturbance, which Prof. Kortazzi kindly sent me, and which is represented in the above figure, it appears that at about 5:77, or 11m. before the light-point was prevented to trace a curve, by passing on to the brass rod, the curve was suddenly interrupted, which shows that the pendulum was performing large oscillations. Between 9:72 and 11:05 the motion is small.

<sup>1</sup> In the original photograph the second part of the curve is much displaced, in the same way as the third part after the interruption. This was altered in the figure to economise space.

In comparing the two curves, it is evident that the different intensity of motion at the two places is not due to the difference in the values of the instrumental constants. The reason why the motion of the pendulum is so much stronger at Nicolaiew is this, that the soil consists down to a great depth of sand, which is particularly favourable for the development of strong motion. In this respect Nicolaiew resembles the two former stations, Potsdam and Wilhelmshaven. Many facts tend to show that the soil at Strassburg, though often disturbed by small earthquakes of distant origin, never oscillates as much as at the fore-named places. It would not be right, therefore, from the mere look of the curves, to draw the conclusion that the earthquake—if such was the cause of the disturbance—must have originated at a place considerably nearer to Nicolaiew than to Strassburg.

Until now I have not been able to find a record of a phenomenon which might possibly be connected with this disturbance. From its size and duration, one ought to think that it must have been caused by a strong catastrophe, surpassing anything that has been reported during the last year from all parts of the world. But it is strange that the magnetic recording instruments at Potsdam have shown no trace of motion, and that nothing is reported from the delicate seismological instruments which are at work in Italy.

The case is remarkable in more than one respect. Displacements of the light-point, which, though the oscillations of the pendulum were much larger generally, were scarcely noticeable during the former observations with this instrument at other places, do not occur at Strassburg. I am inclined to think that they are due to a vibratory motion of the ground, which scarcely affects the motion of the pendulum, but may cause a change in its position with regard to the steel pivots. The vibrations appear to be more easily propagated by the soil at Strassburg than at Nicolaiew, for though small displacements occasionally occur at the latter place, they are considerably smaller. This is particularly evident in the present case, where the only displacement of the instrument connects with the shock at 5:77. On the other side, the displacement at Strassburg, which produced the "strong" break in the curve, is far the largest that occurred during one of a half year's service. It is much larger than that which took place when an iron hook was driven into the ground at Nicolaiew, and of the pendulum.

On the present as well as the displacements of the pendulum were comparatively larger during the first and second than during the third and fourth motion. The change during No. III. is about 1 mm. Another peculiarity with regard is that in the two first observations the direction of the wind was the south, and in the two latter was the north. This seems to indicate, if one considers the position of the instrument, that the north-south line of the instrument in the first and second, and from the third and fourth observations. The displacement of the ground at Nicolaiew on 5:77 is also directed towards the south, and is probably the same as that at Strassburg. The above observations are in the position that the displacement of the ground is towards the north, which causes the steel-points to slip on the pivots of the instrument to slip on the agate surface. The above observations probably much more completely than the former ones, in supposing the direction of the wind, and the direction of the pendulum.

The following table, arranged in order of time, leads to a summary of the observations:

	Strassburg.	Nicolaiew.	Birmingham.
	4:42 h. first trace	4:32 first trace	
	4:52 increase 4mm.		
	4:56 decreases and increases again		
	4:77 curve disappears	4:8 first maximum 60mm.	
	5:05 reappears		
	5:25 end		
	5:04 new shock	5:8 curve disappears	5:72 the image was found to be steady
		strong motion	6:48 strong motion
			6:70 6:77 steady again
			8:22 end
	8:47 light point corrected	8:4	
	9:05 motion small	9:72 small motion	
	11:49 nearly steady	11:05	
	11:45 h. increase 5mm.	11:30 sudden increase	
	11:50 end increase 10 mm		
	12:10 curve	12:3 diminishes	
	12:20 small motion		
	12:47 increase 6mm.	12:7 curve disappears	
	12:7 curve disappears	13:22 reappears	
	13:17 reappears	13:07 decrease of motion	
	13:43 motion small	14:57 new increase	
	14:15 end all increase	15:17 end	

While the observations are being made, I am inclined to think that the remarkable increase of the curve were several phases of the disturbance at the different places. If we take as the beginning of the disturbance at Nicolaiew, where the first traces are visible, we find the following order of events at Strassburg:—H. I., I. 1:15; at Birmingham, H. III., I. 1:15; H. I., I. 0:74h.; IV., II., I. 0:60. At Nicolaiew, where I. II., III., I., and IV., appear in the order of time, we find H. I., I. 0:73h.

The disturbance at Birmingham is probably due to the same cause as that at Nicolaiew, and is probably the same as that at Strassburg.

Again the times of disappearance of the curve or of maximum motion are separated by nearly the same interval, viz., at Strassburg H. I., I. = 6:83h., IV., II. = 7:12h., and at Nicolaiew IV., II. = 6:9h. The duration at Strassburg of No. I. is 0:83h., and of No. II. 0:04h.; the duration of No. III., if we omit the last part, in which the motion was very small, is 2:84h., of No. IV. 2:60h. At Nicolaiew, during the first half of the disturbance, the strong motion ends 4:08h. after the beginning, and the second part lasts 4:12h. The intensity of I. and II. is evidently larger than that of III. and IV.

We will now see if the direction of motion can be determined by the observations.

I. Though the first trace of motion is 0:10h. earlier at Nicolaiew than at Strassburg, yet it is probable that the corresponding moments are those of the disappearance of the curve at Strassburg and of maximum oscillation at Nicolaiew, or 4:77h. and 4:8h. To judge from the copy, which Prof. Kortazzi sent me, the latter value is only approximate. The difference in time is certainly small, and the direction of the motion remains rather uncertain; the general aspect of the figure, however, makes it more probable that it came from the east.

II. The time of disappearance of the curve at Strassburg, 5:04h., is probably correct within 0:02h. or 0:03h. Mr. Davison's observation shows that the motion, which in this case appears to have commenced suddenly, had not reached Birmingham at 5:72h.; on the other hand, the disappearance of the curve at Nicolaiew took place at 5:8h., or about 12m. later than at Strassburg. If these times were all correct, and if the three moments really corresponded with the same phase, the centre of disturbance ought to be looked for somewhere at the south-west and not too far away from Strassburg. This, however, is a very improbable result. Mr. Davison's instrument could only indicate an east-west tilt, and perhaps the motion had already set in when he left the instrument at 5:72h., but was not perceptible enough in the east-west direction.

The two other observations make it nearly certain that the motion arrived from the west.

III. The case is very much like No. I.; probably the motion

arrived at Nicolaiew first, but its direction cannot be determined with certainty.

The beginning of H., though sudden and sharp, need not necessarily indicate the movement of greatest motion, in this case the difference IV., II. would have a smaller value.

The distance between Strassburg and Birmingham is about 300 kilometers.

Mr. Davison's weight cannot be attached to the absence of observed motion at Birmingham at 5:43h. The image of the wire was adjusted on the cross-wire of the telescope without difficulty, and must have remained practically in contact for a few seconds. A small movement, with a period so long as twenty seconds, might easily at this time have escaped notice. (C. D.)



IV. The curves again disappear at about the same time; but to judge from the time of greatest steadiness before the disturbance commenced at Nicolaiew, it appears to have reached Strassburg first. The last small increase at 14.87h. and 14.95h. is, on the contrary, earlier at Nicolaiew than at Strassburg, but this might be an independent disturbance. After the strongest motion, the light-point resumes its steadiness much sooner at Strassburg than at Nicolaiew.

It is evident that the case is, on the whole, not favourable to an hypothesis which first occurred to me, that all four disturbances might have been caused by four successive waves emanating from a single centre and a single shock, and circulating round the earth. The fact that II. and IV. are more considerable than I. and III. does not appear of much importance, for it is proved by many examples that the intensity of a disturbance is not alone dependent from the distance from the centre; but, if the hypothesis were right, disturbances III. and IV. ought probably to be much smaller. Besides, the velocity of about 100 km. per minute would be a very small value compared to those determined on other occasions.

I reject this hypothesis, but I do not think it improbable that I. and II., III. and IV. may be connected in the way just mentioned, and that both disturbances came from the same part of the world. It is the principal object of this communication to induce persons interested in the subject to study carefully the records of all self-registering instruments. If the disturbance originated at the bottom of the sea, something about it might be found in the ship journals, the tidal records might show a trace, or perhaps the magnetical records at distant places. I have many proofs that the size of a disturbance, traced by the horizontal pendulum, is not always a measure for the importance of the catastrophe which produced it; but in the present case many instances indicate an extraordinary phenomenon, of which an account is likely to appear sooner or later, in case it should have taken place at some remote corner of the earth.

Merseburg, May 18.

P.S.—Some time after having written the above, I received the third volume of the *Seismological Journal of Japan* (1894), in which there is an interesting paper by F. Omori on the eruption of Azuma-san in 1893. From this paper it appears that the volcano was in an active state since May 19, when an explosion took place, which was followed by two other ones on June 4, 4.10 a.m., and on June 7, of which the former is said to have been the strongest. It was accompanied by an earthquake, which was felt at the meteorological station of Fukushima. Supposing the above time to be Standard Time (9h. east of Greenwich), the explosion took place at 7h. 10m. p.m. G.M.T. on June 3, and thus it is seen that it coincides with a part of our great disturbance. I do not, however, believe that this is more than a casual coincidence, for the two other eruptions produced no disturbances. It is also a well-known fact that volcanic eruptions, even when accompanied by earthquakes, are generally not felt to any great distance, unless they bear a very violent character, like the eruption of Krakatoa; but from Mr. Omori's description it appears that the eruption of Azuma-san was nothing very extraordinary. I therefore believe that we must wait to find another explanation for our disturbance.

E. VON RESEUR-PASCHWITZ.

### EXPLOSIONS IN MINES.

IN a lecture on some modern developments in explosives, given at the Society of Arts on December 17, Prof. Vivian B. Lewes threw out a suggestion as to the cause of explosions in dusty mines free from fire-damp, which explains the anomalies which have presented themselves in several recent explosions.

It was pointed out that until quite recently explosions in mines were always attributed to the accidental ignition of mixtures of air and methane, to which the name of "fire-damp" is given, and undoubtedly this cause is the prime factor in this class of disaster, and the introduction of such precautions as safety-lamps at once brought about a considerable reduction in the number of explosions taking place. Many disasters, however, still continued to occur under apparently mysterious circumstances, the conditions being such that any large proportion of methane in the air of the mine appeared practically

impossible, but investigations of such explosions showed that coal-dust in a dry and finely powdered condition had generally been present in the mine at the time of the explosion, and the coked residue of this dust was found afterwards on the surface exposed to the explosive wave, and years of experimental investigation by scientific men of the greatest ability proved the fact that air containing so small a proportion of methane as to be itself perfectly non-explosive, becomes a good explosive again when holding dry and finely divided coal-dust in suspension, and within the last few years explosions having taken place in mines, which have always been celebrated for their freedom from any trace of methane. Further experiments have been made by Mr. H. Hall and Mr. W. Galloway, who have shown that the violent ignition of dust-laden air is possible by a blown-out shot, even if free from any trace of marsh gas, and there is evidence to show that the explosion is developed in throbs or waves.

It is therefore found that the explosions in mines may be brought about, first, by the ignition of a mixture of methane and air, in which the former rises above a certain percentage; secondly, by mixtures of air, coal-dust, and methane, in which the amount of the latter may be excessively small; lastly, by mixtures of coal-dust and air. With regard to these explosions caused by coal-dust and air alone, the Royal Commission on Explosions from Coal-Dust in Mines, in their second report, published this year, say:—

"On a general review of the evidence on this point, we have no hesitation in expressing our opinion that a blown-out shot may, under certain conditions, set up a most dangerous explosion in a mine, even where fire-damp is not present at all, or only in infinitesimal quantities; and while we are prepared to admit that the danger of a coal-dust explosion varies greatly according to the composition of the dust, we are unable to say that any mine is safe in this respect, or that its owners can properly be absolved from taking reasonable precautions against a possible explosion from this cause. But even if we had been able to come to a different conclusion, and to agree with the minority of the witnesses examined, who think that coal-dust alone cannot originate an explosion, we should still have to call attention to the serious danger which results from the action of coal-dust in carrying on and extending an explosion which may originally have been set up by the ignition of fire-damp."

One of the most interesting and instructive explosions which have taken place recently was that which occurred a little more than a year ago at the Camerton Collieries, Somersetshire, in which as far as investigation could go, no trace of combustible gas could be found in the mine at any period prior to the explosion or subsequent to it, and in which everything pointed to the explosion being entirely due to the presence of dry coal-dust in the air.

Of absorbing interest, also, are the experiments made by Mr. Hall at the latter end of 1892 and the early part of 1893, and reported upon by him to the Secretary of State on January 23, 1893, in which he shows by conclusive experiments that dry coal-dust under conditions frequently present in coal mines and in the entire absence of fire-damp, may be inflamed by a blown-out gunpowder shot, and cause a disastrous colliery explosion.

The evidence which can be collected from the investigation in the Camerton disaster, and from Mr. Hall's experiments, point to a cause for such explosions, which has apparently been overlooked, and which Prof. Lewes thought worthy of the gravest attention. Both at the Camerton Colliery and in Mr. Hall's experiments, powder was the blasting agent used, and such powder as is employed for this purpose, gives amongst the products of combustion nearly half the volume of permanent gases in the condition of carbon monoxide, methane, and hydrogen.

In the Camerton explosion, it seems probable that about 1½ lbs. of such powder were used in the shot which caused the disaster, and this quantity of powder would give, roughly, a little over three feet of inflammable gas, which when mixed with pure air would give over 10 cubic feet of an explosive or, at any rate, rapidly burning mixture, and experiments which have been made upon the effect of fire-damp and dust combined in causing colliery explosions show conclusively that even when the fire-damp is present in such minute quantities as to form a mixture very far removed from the point of explosion, it still makes the mixture of coal-dust and air highly explosive; and from experiments which Prof. Lewes has made, it is clear that traces of

carbon monoxide will do exactly the same thing when the air is laden with coal-dust, whilst the temperature of ignition is slightly lower than with methane, so that in the case of the Cameron colliery, it being perfectly well ascertained that the air was saturated with coal-dust, the probabilities are that not 10 feet, but a larger volume of explosive mixture was formed by the direct escape of the products of combustion into the coal-lane, and thus being ignited, either by the flame or red-hot solid particles driven out into it by the blown-out shot, would initiate a considerable area of explosion.

The classical researches of Prof. H. Dixon have shown that hydrocarbons and, probably, carbon burn in air to carbon monoxide, and that this carbon monoxide will not form explosive mixtures with air, or even with oxygen, if they are absolutely dry; but if water vapour is present, they explode owing to the oxidation of the carbon monoxide to dioxide, causing the propagation of an explosive wave, which reaches its maximum velocity when the percentage of water vapour, between 5 and 6 per cent., and inasmuch as the air of the mines would always contain some moisture, and as the products of combustion also would give a large volume of water vapour, these requirements would be amply fulfilled.

Still more conclusive on this point were Mr. Hall's experiments. In these a charge of blasting powder was fired from a cannon suspended in a shaft, the air of which was proved by careful chemical analysis to be absolutely free from any trace of combustible gas.

In order to get some idea of the condition of the air inside the pit during the explosion, samples of air were taken and were analysed. Two brass tubes were fastened to the rope that was used to lower the cannon, one twenty yards from the bottom, the other forty yards from the bottom.

These tubes were so arranged and constructed that the explosion, as it passed the tubes, unsealed the outlet pipe, and the escaping water sucked in a sample of air which was trapped by a special arrangement, and kept in the tube until the rope could be wound up. By this method it was intended that the sample of gas taken should represent that state of the air whilst the flame was passing, or directly afterwards.

The tube nearest the bottom, as the analysis will show, did partly collect the gas in the above condition. The tube at the top, however, commenced to act prematurely, and was probably started by the sound wave which preceded the explosion. This tube simply contained ordinary air.

The following is an analysis of the gases found in the lowest tube:—

	Per cent
Oxygen	3.9
Nitrogen	75.9
Carbon dioxide	12.1
Carbon monoxide	8.1
	100.0

This ingenious arrangement was due to Mr. W. J. Orsman, and is probably the first successful attempt which has been made to get a sample of gas during the progress of explosion, and there is not the slightest doubt that the presence of such an amount of carbon monoxide converts mixtures of coal dust and air into a highly explosive body.

As the explosion takes place, and as the carbon monoxide really produced is oxidised to carbon dioxide by the action upon it of water vapour present, and also by its direct combination with oxygen, the hydrogen of the water vapour is set free, while the fire itself just also yields certain inflammable products of combustion to the air, and partial combustion also of the coal-dust gives a considerable proportion of carbon monoxide or more, and the explosion rapidly ahead of the explosion front with more coal-dust and air a new explosive zone, and so by waves and throbs the explosion is carried through the dust-laden galleries of the mine.

The experiments made by Mr. Hall, and investigations in various colliery explosions, moreover, conclusively manifest that no explosive should be licensed for use in mines unless it can be absolutely proved that it gives off no inflammable products of combustion. The following table will show the results given by some of the explosives most largely used, which point very clearly to the fact that, with the exception of the Sprengel explosives, such as roborite and nitroglycerine, none of the bodies in use conform to this important requirement.

Products of Combustion of Blasting Explosives.

Powder.	Combustibles.		
	Carbon dioxide	Carbon monoxide.	Hydrogen and marsh gas.
Gunpowder	50.6	10.5	3.1
Blasting powder	32.1	33.7	7.9
Sprengel explosives—			
Roburite	32.0	nil	nil
Ammonite	33.0	nil	nil
Nitroglycerine explosives—			
Nitroglycerine	63.0	nil	nil
Gelignite	25.0	7.0	nil
Carbonite	10.0	15.0	26.0
Blasting gelatine	36.5	32.3	8.6

Whilst not only these considerations, but Mr. Hall's experiments, point to the absolute necessity of legislative enactments at once forbidding the use of blasting powder in any coal mines, no matter how free they may appear to be from fire-damp or from dust, if the returns made as to deaths caused by gunpowder and other explosives in mines for the year 1893 are examined, it will be clearly seen that the exclusion of gunpowder, in handling alone, would do away with 80 per cent. of the accidents. So that if explosives of the Sprengel class were employed, accidents due to the explosives used would be practically eliminated from the mining death-roll; and it is only a question of time as to when England will follow the action of France and Germany in altogether prohibiting the use of blasting powder in dusty mines.

THE POSSIBILITIES OF LONG-RANGE WEATHER FORECASTS.<sup>1</sup>

IF we had perfect command of this subject, we should be able to trace the motion of a particle of aqueous vapour from point to point over the whole earth, and could predict whether at any time in the future it will fall as rain, or rise and fly away as an invisible gas. In the absence of this higher knowledge the only long-range forecasts that we are at present able to make are based upon empirical and very imperfect rules deduced from our study of the accumulated climatological statistics. Of course, such predictions do not imply any special knowledge of meteorology. Among the methods adopted in long-range forecasts are the following:

(a) The average rainfall, temperature, &c., for any period, such as a month, and deduced from many years of observation, is called the normal. The excess or deficiency of this month in any given year is called the departure for that year. A general prediction may be made to the effect that the rain-fall for a given month and place may be expected to lie within the range of the values indicated by these known departures.

(b) The series of annual or monthly values just mentioned gives us the means of finding out whether there is any simple sequence or connection between them and the apparently unconnected values that occur from year to year. Thus, it sometimes happens that rainy seasons come after two or three dry seasons, or that after the same month has been dry in three successive years, one is then justified in predicting a wet month. Thus, Governor Rawson elaborated a system for the prediction of rain and the sugar crop in Barbados.

(c) Slight but appreciable widespread, rather regular fluctuations of temperature, pressure, and rain have been revealed in the climate of Europe by Dr. Bruckner, who finds that a deficient temperature and an excess of rain have alternated with excess of temperature and deficiency of rain in periods of thirty-six or thirty-seven years during the past two or three centuries; the glaciers increase and diminish in volume, or advance and retreat, in correspondingly regular but somewhat retarded intervals. Predictions may be based on these well-established periods.

(d) Droughts are sometimes due to what happens in distant regions: thus, if there is a heavy snow on the Himalayas during the winter, there is a special liability to drought in lower India in the following summer, so that the prediction of a drought may be based upon the reports of snow fall in a distant region several months before the drought occurs; but other droughts may occur without this preliminary snow-fall. This connection

<sup>1</sup>Report of an article contributed by Prof. Cleveland Able to the *U.S. Monthly Weather Review*.

is, so far as at present known, a local, arbitrary, or accidental one, and has not yet been found to recur in any other portion of the globe.

(e) Droughts or floods may occur every year in some portion of an extensive region, so that it may become possible to predict the occurrence in a special section one year because one has occurred in another section a previous year. Thus, a serious drought in the lower Indian peninsula has, on five occasions, been followed by one in northern India the next year.

(f) If we had maps of the weather of the whole globe for every month for a long series of years we should, undoubtedly, be able to find many similar coincidences, so that a drought for a given section might be predicted from the rain-fall, the snow-fall, the temperature, the pressure, or other conditions in a distant part of the globe. As a rule, important climatic crises are the results of changes that have been going on slowly for a long time in distant parts of the earth. The general circulation of the air constitutes a complex system in which the areas of high pressure and dry clear air are the results of slowly descending winds moving toward the equator; the general rains are formed wherever a descending current of air, a mountain range, or other obstacle has an opportunity to push up the moister air of the earth's surface. From this point of view rainy and dry and cold and hot seasons depend largely upon the varying relations of the upper and lower currents to the continents and even to each other. The long-range prediction of the climate of any season must depend upon the prediction of the general character of the horizontal and vertical movement of the air. In our present geological epoch the continents are permanent features, and we consider only the changes that take place in the atmosphere, but in studying the climatic changes of earlier geological epochs we have to consider the changes in elevation of the continents themselves.

(g) Such apparent connections as that between snow-fall on the Himalayas and the subsequent drought in northern India are not to be thought of as cause and effect respectively. It might be argued that the layer of snow must be evaporated, or melted, thereby absorbing more heat than would have been required if it had fallen as rain and rapidly drained away; but this cooling influence is distributed over many weeks, and through the immense quantity of air that has passed over the snow-fields during the winter and the spring, and is thereby rendered too slight to have any great local influence in India. A broader view of the subject shows us that the winter snow-fall and the summer drought are simply two features of an extensive system of changes in which the whole atmosphere of the earth takes part. The whole globe may be divided into regions where the lower stratum is moving either horizontally or upward or downward, and where the upper stratum has similar diversities of movement. These systems of motion determine whether we shall have fair weather or rain, hot weather or cold, from day to day and accumulatively from month to month. Now these three movements are related to each other in such a way that the sum total of the energy involved throughout the atmosphere is sensibly constant, while the localities at which the upward and downward motions are taking place are undergoing perpetual changes.

The centres of high pressure over the oceans and continents slowly sway east and west or north or south; the paths of the storm-centres vary in a similar manner to suit the changes of these larger areas, and the centres themselves move rapidly or slowly in response to these same changes. The air that ascends between the northern and southern tropical regions of high pressure descends sometimes in high latitudes, giving them cold weather with rain or snow; at other times in low latitudes, giving them warm weather with droughts. It matters not whether the droughts in southern regions chronologically follow or precede the snows of the northern regions; in neither case can either one be spoken of as the cause of the other, but each in its turn the result of changes in the so-called general circulation of the atmosphere.

This general circulation, with all its variations, diurnal, annual, and secular, is dependent upon the intrinsic density of each portion of the atmosphere and on numerous forces, such as the heat received from the sun, the attraction of the sun, moon, and earth, the resistance offered by the irregular surface of the earth, and the interaction of slow and rapidly moving masses of air. The proper study of this subject constitutes the application of hydrodynamics to meteorology.

The meteorological problem has some analogy to that offered

by the hydraulics of the Mississippi River, where cut-offs, cave-ins, mud-bars, and crevasses are continually forming and re-forming. We do not expect to be able to foretell when and where these will occur many years in advance, but we do keep a watch on the condition of the river; and when conditions are favourable for the formation of any important change, we watch the process until the catastrophe becomes more or less imminent, and then begin to make estimates, that may be called predictions, as to the exact time and place of the event.

In meteorology the best we can do at present in long-range predictions is to chart and study the occurrence of abnormal weather conditions over the whole globe; these phenomena must be interpreted in the light of all the knowledge we have of the mechanics of the atmosphere, for they are the results of purely mechanical operations covering the whole range of the mechanics of heat, gases, and vapours.

### SCIENTIFIC SERIAL.

*The Quarterly Journal of Microscopical Science*, November. —On *Julinia*, a new genus of compound ascidians from the Antarctic Ocean, by W. T. Calman (plates 1-3). The colony is described as irregularly cylindrical in shape, measuring 78.5 cm. in length, and from 1.5 to 2.5 cm. in diameter; it was found floating on the surface of the sea in the north of Erebus and Terror Gulf; a considerable quantity was seen; no attaching fibres were found, but it was probably an attached form. The species is described as *Julinia australis*, and it is provisionally placed in the Distomida. —Hermaphroditism in mollusca, by Dr. Paul Pelsceer (Ghent) (plates 4-6). Hermaphroditism is found in the Amphineura, the Gastropoda, and the Lamellibranchia. It is not self-sufficient, is sometimes protandric; it would seem to the author to be not a primitive arrangement, but to be derived from the unisexual state, and to have been established upon the female organism. —Description of the cerebral convolutions of the chimpanzee known as "Sally," with notes on the convolutions of the brains of other chimpanzees and of two orangs, by W. Blaxland Bertram (plates 7-11). —On the inadequacy of the cellular theory of development and on the early development of nerves, particularly of the third nerve and of the sympathetic, in Elasmobranchia, by Adam Sedgwick, F.R.S. More than ten years ago the author called attention to the inadequacy of the cellular theory of development: "Embryonic development can no longer be looked upon as being essentially the formation by fission of a number of units from a single primitive unit, and the coordination and modification of these units into a harmonious whole. But it must rather be regarded as a multiplication of nuclei and a specialisation of tracts and vacuoles in a continuous mass of vacuolated protoplasm." And "although opinions have changed on this important subject, and although there are some who think that they have escaped from the domination of this fetish of their predecessors, yet as a matter of fact the cellular theory of development is still rampant, still blinds men's eyes to the most patent facts, and still obstructs the way of real progress in the knowledge of structure." When a student begins his zoology he is told that "the various structures present in a protozoon are all parts of one cell, whereas in a metazoan the various parts are composed of groups of cells which differ from one another in structure." When in a later period of his studies he begins embryology, "the importance and distinctness of the cell meets him at every step, from the complete cleavage which he is led to believe is primitive, to the development of nerves according to the views of His." If we take the so-called mesenchyme tissue of clasp-branch embryos, it is described as consisting of "branched cells lying between the ecto- and the endo-derm," while, as a matter of fact, "the separate cells have no existence," but "there is a reticulum of a pale non-staining substance holding nuclei at its nodes. And far from the development of nerves being an outgrowth of cell-processes from certain central cells, it is simply a differentiation of a substance which was already in position." This important memoir is so condensed as to make it extremely difficult to condense it further, but enough has been given to indicate its nature. —On *Benhamia coriifera*, n. sp., from the Gold Coast, by W. B. Benham (plate 12). This large species (20 inches) was found at Axim in the Fantee country, on the west coast of Africa.

SOCIETIES AND ACADEMIES.

LONDON.

Royal Society, November 22.—A Determination of the Specific Heat of Water in terms of the International Electric Units. By Prof. Arthur Schuster, F.R.S., and William Johann (1851) Scholar, Queen's College, Galway.

This research was originally undertaken by Prof. Schuster and Mr. H. Halley, before the authors were aware that Mr. J. H. Griffiths was engaged on a similar investigation. After a number of preliminary experiments, and just as the final arrangements for the conduct of the measurements were being definitely made, Mr. Halley, on his appointment to the head-mastership of the School of Science and Art, Kidderminster, had to leave Manchester.

On Mr. Halley's departure, Mr. W. Gannon took his place. From the former gentleman we received a good deal of help in devising and constructing some important parts of the apparatus.

The principle of the method we have used is extremely simple. The electrical work done in a conductor being easily given if  $I$  is the current,  $R$  is the difference of potential at the ends of the conductor,  $t$  the time. We suppose the electrical units to be constant, and measure  $\int CR dt$  directly,  $w$  is the weight of water. We do not, therefore, require to know the resistance of the wire, and we thus avoid the difficulty of having to estimate the excess of temperature of the wire over that of the water in which it is placed. We also gain the advantage of having to measure time, and therefore to repeat the series of the experiments more quickly than we could have done if the length of time the current passed through the wire were to be measured with great accuracy.

At 19° C.  $J = 4.184$  Joules on the mercury scale of hard French glass,  $J = 4.185$  on the nitrogen scale,  $J = 4.187$  on the hydrogen scale, at a temperature of 19° C.

In comparing our results with that of other observers, we have first had to take into consideration the value which Mr. Griffiths has assigned to his very excellent series of measurements. His final result is  $J = 4.1821 \pm 0.000266 \theta - 15 \pm 10.7$

where  $\theta$  refers to the nitrogen thermometer. At a temperature of 19° C. the value would be reduced to 4.1839, which corresponds to our 4.185 at the same temperature. Griffiths' value is to be regarded as probably owing to the fact that he really measures the difference between the specific heat of water and of air. This value is not the value of  $J$  by 0.011 about, so that the value of  $J$  would be raised to 4.1947, which is exactly the opposite of what we find, and larger than ours. The difference is small, but it is not due to some systematic error, as both Griffiths' and our own values agree so well with each other, that ordinary errors due to accidental disturbances could not have produced so large a difference in our results. The least satisfactory part of our calorimetric measurement must always be the application of the cooling correction, and we have considered this of great importance to reduce that correction as much as possible. The uncertainty of the cooling correction does not necessarily depend on its value; thus we can much diminish it by starting, as we have done in the third series, with the initial temperature of the thermometer about as much below that of the water jacket as the final temperature is above it; yet the uncertainty of the correction does not seem to us to be diminished by that process. We may reasonably estimate the uncertainty due to the cooling correction, by calculating what the error in the observed rate of cooling, either at the beginning or at the end of the experiment, must have been in order to produce a difference of one part in a thousand in the final result. We find in our own experiments that the error must have amounted to more than 15 per cent. We consider it unlikely that so large an error occurred always in the same direction. Apart from the cooling correction, however, it is difficult to see how a difference one-tenth per cent. in our result can be produced merely by the accumulation of a number of small errors.

The difference between our value of the equivalent and that

of Mr. Griffiths are, however, of smaller importance than the difference which exists between them and the equivalent as determined directly by Joule, Rowland, and Miculescu. Joule's latest value, which is the only one which needs consideration, is 772.05 foot-pounds, at 61.7° F. The number refers to the degree as measured by Joule's mercury thermometer. Rowland adds to this a correction to the air thermometer of about 3, and another small correction for a change in the heat capacity of the apparatus, which brings the value up to about 776. The correction to the air thermometer has been obtained by means of a comparison made by Joule himself with one of Rowland's thermometers. Joule's original thermometers have been temporarily placed by Mr. B. A. Joule in the hands of Prof. Schuster, in order that an accurate comparison may be instituted between them and modern thermometers. A full description of the comparisons made will be given on another occasion. The result arrived at shows that the correction is less than that assumed by Rowland, and would bring his value up only to 775 at the temperature indicated.

Great weight must be attached to Rowland's determination, which at the temperature to which Joule's number applies is 777.0, and at 19° C. 776.1, corresponding to our 778.5.

Equivalent in foot-pounds at Greenich at 19° C referred to the "Paris" Nitrogen Thermometer.

Joule.	Rowland.	Griffiths.	Schuster and Gannon.
774	776.1	776.1	778.5

We now turn to an investigation of Miculescu (*Annales de Chimie et de Physique*, vol. 27, 1892), in which the mechanical equivalent of heat is measured directly by what seems a very excellently devised series of experiments. Its result is  $4.1857 \pm 10$ .

In order to compare Miculescu's value with that of others, we must apply a temperature correction which is somewhat doubtful; but taking the mean of Rowland's and Griffiths' values as the most probable at present, we obtain at 15° the following table:—

Equivalent in foot-pounds at Greenich at 15° referred to the "Paris" Nitrogen Thermometer.

Joule.	Rowland.	Miculescu.	Griffiths.	Schuster and Gannon.
775	778.3	776.6	780.2	779.7

If we remember that Rowland's number referred to the "Paris" nitrogen thermometer would probably be smaller by one unit, we are struck with the fair agreement there is, on the one hand, between the results of Joule, Rowland, and Miculescu, and on the other hand between Griffiths and ourselves.

As far as we can draw any conclusions from the comparison, it seems to point to a difference in the value obtained by the electrical and direct methods. Whether this difference is due to some remaining error in the method adopted by Mr. Griffiths and ourselves, remains to be decided by further investigation.

Linnean Society, December 6.—Mr. C. B. Clarke, F.R.S., President, in the chair.—Mr. E. M. Holmes exhibited and made remarks upon a small collection of Japanese marine algae, some of which were of considerable rarity in European collections.—Prof. D. Campbell brought forward some illustrations of the relations of vascular cryptogams, as deduced from their development. His remarks, which were listened to with great attention, gave rise to an interesting discussion, in which Prof. Bower, Dr. D. H. Scott, Mr. Carruthers, and Prof. Marshall Ward took part. "A new revision of the *Dipterocarpacee*," was the title of a paper by Sir Dietrich Brandis, K.C.I.E., who gave an excellent account of this order of forest trees, their structure and mode of growth, together with a survey of the literature relating to them, and a clear exposition of his views concerning classification. He pointed out that the order *Dipterocarpacee* consists almost entirely of large trees which do not flower until they have attained a great size, with a spreading crown on a branchless stem often more than 100 feet high. Hence it is difficult to obtain complete specimens in flower and fruit; and this explains why a large proportion of the genera and species have only of late years become accurately known. Korthals in 1840 knew 34 species; A. de Candolle in 1868 described 129; Mr. Thinsleton Dyer in 1874 estimated the order at 170. Sir D. Brandis now considers that there are 320 well-

ascertained species, belonging to sixteen genera, omitting the genera *Ancistrocladus* and *Lophita*, which he regards as justly excluded from the order. Notable species are the Sal tree of India (*Shorea robusta*), great forests of which extend along the foot of the Himalayas and in Central India, the Eng tree (*Dipterocarpus tuberculatus*) of similar growth in Burma, and others found in Cochin China and Borneo. In the discussion which followed, an extended criticism was offered by Mr. Thiselton Dyer, who had paid special attention to this order of trees, and who, admitting the soundness of the author's views, considered his exposition of them most valuable. The paper was illustrated by lantern-slides showing the chief peculiarities of structure in the flowers and fruit.

Royal Meteorological Society, December 19.—Mr. R. Inwards, President, in the chair.—Mr. H. Southall read a paper on floods in the West Midlands, in which he gave an interesting account of the great floods which have occurred in the rivers Severn, Wye, Usk, and Avon. He has collected a valuable record of the floods on the Wye at Ross, which he arranges in three classes, viz. (1) primary or highest of all, those of 14 feet 6 inches and above; (2) secondary, those with a height of 12 to 14 feet; and (3) tertiary, those with a height of 10 to 12 feet. The dates of the floods above 14 feet 6 inches are as follows: 1770, November 16 and 18; 1795, February 11 and 12; 1809, January 27; 1824, November 24; 1831, February 10; 1852, February 8 and November 12. The height of the recent flood on November 15, 1894, was 14 feet 3 inches, which was higher than any flood since November 1852. The flood on the Avon at Bath on November 15, 1894, is believed to have been the highest on record.—Mr. R. H. Scott, F.R.S., gave an account of the proceedings of the International Meteorological Committee at Upsala in August last, with special reference to their recommendations on the classification of clouds and the issue of a cloud atlas (see NATURE, December 20).—A paper by Mr. S. C. Knott was also read, giving the results of meteorological observations made at Mojanga, Madagascar, during 1892 to 1894.

## EDINBURGH.

Royal Society, November 27.—Prof. Copeland, Astronomer-Royal for Scotland, Vice-President, in the chair.—Prof. MacKendrick read a paper on observations with the phonograph, with experimental illustrations. He has devoted great attention to the development of the instrument. He uses very large conical metallic resonators, and has succeeded largely in getting rid of the nasal sound of the instrument, so that part-songs and concerted instrumental pieces can be reproduced with considerable accuracy, and can be made audible throughout a very large room. He exhibited, by means of a lantern, a large number of photographs of the surface of the wax drum, pointing out the peculiarities of the record corresponding to various qualities of instrumental or vocal notes and chords.

December 3.—Prof. Geikie, Vice-President, in the chair.—Dr. John Smith communicated notes on a peculiarity in the form of the mammalian tooth. Roughly speaking, the general appearance of the mammalian tooth is that of a cone, flattened to some extent, and twisted about its axis to a greater or less degree, and then bent so as to form a portion of a circle. If this bending takes place to a large extent, it is not easy to recognise the axial twist. The author showed that the characteristic is always present, being easily seen in the strong spiral of the narwhal's tusk, or the remarkably twisted teeth of the *Mesopodon* described by Sir William Turner in the Reports of the *Challenger* expedition, and being almost unrecognisable in the human tooth. The axis of the twist is directed backwards and inwards from the face of the tooth, and it is this characteristic which enables dentists to distinguish teeth from each side of the mouth.—Mr. Gregg Wilson read a paper on the development of the Mullerian duct of amphibians. He contends that this duct does not arise from splitting of the segmental duct, but is developed in the same way as the Mullerian duct of the higher mammals.—Dr. George Hay, Pittsburg, submitted an account of a new method of correcting courses at sea. His apparatus consists of two superposed compass cards, whose north points are set at an angular distance apart which is equal to the magnetic variation. The true course being read off on one, the corresponding point of the other gives the compass course. Simple as this arrangement is, Dr. Hay asserts that he has never known it to be

employed at sea.—Prof. Tait read a note on the constitution of volatile liquids. His equation, deduced from the graph of the *Challenger* results, applies with great accuracy to non-volatile liquids, such as water, at ordinary temperatures and at pressures up to 3000 atmospheres. It does not apply with quite so great accuracy at the lower pressures to such liquids at or near their boiling points, and it is still less accurate in this respect when applied to volatile liquids. Prof. Tait suggests that this may be due to the existence, in the liquid, of dissolved gases or of vapour.—Prof. Tait also read a note on the isothermals of ethylene. His equation enables one to calculate, with great accuracy, the pressure, at a given temperature and volume, in the neighbourhood of the critical point, from Amagat's observations; but the volume, at a temperature and pressure in the neighbourhood of the critical point, given by Amagat's observations, cannot be calculated, with any approach to accuracy, from the equation. This is due to the excessive rapidity with which the difference of the volumes in the liquid and vapourous states diminishes with increase of temperature as the critical point is approximated to.

## PARIS.

Academy of Sciences, December 17.—Annual public meeting.—M. Maurice Levy in the chair.—The proceedings were commenced by an address, delivered by the President. The past year was referred to as a period of slow growth and consolidation of knowledge rather than as being characterised by any very brilliant discoveries. The members and associates deceased during the year—MM. Edmond Fremy, Brown-Séquard, Mallard, Duchartre, Ferdinand de Lesseps, General Favé, M. Hermann von Helmholtz and P. Tebbichef—were referred to appreciatively, and their influence on the progress of science pointed out. The system of prizes given by the Academy was referred to at the conclusion of the address, which was followed by the reading of the awards by M. Berthelot. In Geometry the grand prize for the mathematical sciences was awarded to Dr. Julius Weingarten; honourable mention was accorded to M. C. Guichard. The Bordin prize was adjudged to M. Paul Painlevé (Analytical Mechanics), MM. Liouville and Elliot receiving honourable mention. The Francœur prize was obtained by M. J. Collet; the Poncelet prize by M. H. Laurent, for his mathematical works. In Mechanics the extraordinary prize of 6000 francs was awarded to (1) M. Leblond (2000 fr.), for his works on electricity; (2) Commandant Gosset (2000 fr.), for the determination of the velocity of projectiles by means of sound phenomena; (3) Commandant Jacob (1500 fr.), for his study of the ballistic effects of the new powders; (4) M. Souillaguet (500 fr.), for his "Recueil de Tables du point auxiliaire." The Montyon prize fell to M. Bertrand de Fontviroland, for his works on the resistance of materials. The Plumey prize was equally divided between M. André Le Châtelier and M. J. Auscher. M. Antonne received the Dalmont prize (3000 fr. triennially) for his works on *crystalis*. In connection with the same prize, M. Maurice d'Ocagne was awarded a supplementary prize, M. Pochet exceptionally honourable mention, and M. Willotte very honourable mention. In Astronomy the Lalande prize was adjudged to M. Javelle for his researches on nebulae. The Damoiseau prize, for perfecting methods of calculation of perturbations of minor planets, went to M. Brendel. The Valz prize was awarded to M. Coniel for work on small planets, and the Janssen prize to Prof. George Hale (solar photographic observation). In Statistics the Montyon prize was adjudged to M. Boutin, a supplementary prize to Dr. Faidherbe, and honourable mention to Dr. A. Cartier and Dr. Tastié. In Chemistry the Jecker prize was divided between MM. Barbier, Chabrie, P. Adam, and Meslans. In Mineralogy and Geology the Vaillant prize was not awarded, as no memoir had been presented. In Botany the judges for the Desmazières prize awarded an "encouragement," to M. Sappin-Trouffy. The Montagne prize was accorded to M. Husnot for his publication on Mosses; Brother Joseph Heribaud received a second prize for his "Diatomacées of Auvergne." In Anatomy and Zoology the Thore prize to M. Cuvnot for work on the physiology of insects. The Savigny prize to M. Mayer-Eymar for researches in conchology. The Da Gama Machado prize was reserved, although the Commission gave high praise to work submitted by Dr. L. Phisalix and M. L. Joubin. In Medicine and Surgery the Montyon prize to (1) M. Félizet for a treatise on "inguinal hernia of infancy, (2) M. Laborde for his work on "the physiological

treatment of the whole body." M. Panas for his treatise on "Affections of the eyes." Mentions and minor awards went to MM. Legendre, Broca, Vaquez, Vauquemont, Marcel Landrin, Ferreira, Ernest Martin, Pietra Santa, Voisin, and Lotté. The Barbier prize was awarded to Prof. Henri Labor for his work on scrofulo-tuberculosis, Drs. Arnault and Tscherning receiving honourable mention. The Broussin prize was adjudged to M. Arlong for his work on the *Basillus* of peripneumonia in cattle; the Godard prize was awarded to MM. Melville-Wassermann and N. Halié; the Parkin prize to MM. Bebal and Cheay; the Bellion prize between Dr. Lardier and MM. Em-Baude and Materne, Dr. Kenon receiving honourable mention; the Mege prize to M. Courte; the Lallemand prize to M. Glé, honourable mention to MM. Nabias and P. Janel.—In Physiology, the Montyon was divided between MM. Thialix and Bertrand and M. Raphaël Dubois, honourable mention being given to MM. Morot, Blanc, and Philippot; the Pourat prize fell to M. Hauffmann, a mention being accorded to M. Thirolloy. In Physical Geography, the Gay prize was awarded to M. Martel. General prizes.—The Montyon prize (unreal by industries) was divided between MM. Billard and Lavet; the Cuvier prize was awarded to Mr. John Murray of the *Chilodone* expedition; the Tremont prize was awarded to M. Emile Rivière; the Gegner prize to M. Paul Serret; the Delalande-Guérineau prize to the Marquis de Lillou; the Jerome Ponté prize to Commandant Deffarges; the Tehnarchef prize to M. Pavie; the Houlléguive prize to M. Bigourdan; the Cahours prize to M. Varet and M. Freundler; the Saintour prize to MM. L. Deburaux and M. Dibos; the Laplace prize to M. Edouard Glasser; and the Lavet prize to MM. Glasser, Leprince-Ringuet, Henri Parent, and Le Gervan. The programme of prizes for 1895, 1896, 1897, and 1898 is given in detail so far as yet decided.

BERLIN.

Physiological Society, November 23.—Prof. du Bois Reymond, President, in the chair.—Prof. Zuntz gave an account of his researches on the measurement of the amount of blood in circulation and the work done by the heart. For the horse he found 74 to 72 c.c. of blood per kilo body-weight per second; for the dog, as based on the consumption of oxygen, 78 c.c. These values do not correspond to the marked difference in size of the animals, but may be explained as due to the fact that the dog was experimented upon while fasting and at rest, whereas the horse was not. For a horse in complete rest the value obtained was 50 c.c. For man he estimated the value at 60 c.c. Blood-pressure falls but slightly along the arterial system, and was found to be nearly the same in the carotid and in a small branch of the facial artery. The work done by the human heart he calculated as amounting to about 20,000 kilogram-metres in the twenty-four hours. When the body is working the work done by the heart increases also, so that in the case of the horse the total pumped out now amounted to 600 c.c. per kilo per second, or twelve times as much as during rest. The frequency of the pulse could by work be increased four fold, and the work done by the heart to three its normal amount.—Dr. Cohnstein had carried out further experiments on the transudation of solutions of salts in distilled water, and using mixtures of salts as well as mixtures of colloids and crystalloids, he had observed that an increased transudation of the solids follows upon an increase of external pressure. He applied these results to explain the mode of formation of lymph, which he attributed to transudation as well as to filtration, thus opposing Heidenhain's view that it is due to a distinct secretion. He explained the action of lymphagogues, on the basis of his own experiments, as due to the power these substances possess, when mixed with an albuminous fluid, of confining the diffusion of the external fluid entirely towards the interior of the tube which contains them in solution.

AMSTERDAM.

Academy of Sciences, November 24.—Prof. Van de Sande Bakhuizen in the chair. Prof. J. A. C. Oudemans communicated the results obtained in solving two problems, an astronomical and a geodesical one, namely:—1. In how long a period do stars, the velocities of which in the line of vision are known, lose or gain a magnitude of one? 2. The Astronomical Almanac, December 13, p. 190.—Dr. Van Eenburgh (Baten-

zorg) has examined the essential oils of *Polygala variabilis*, H. B. K., *B. altiliora*, *P. polygala*, Heckel, and *Polygala javana*, and found them to be nearly all methylsalicylate.—Mr. Jan de Vries; on a group of plane curves. This paper contains some theorems on plane curves  $\phi$  of the  $(n + m^{\text{th}}$  order, with  $m$  double points, ( $\Delta$ ), forming the base of a pencil of curves of the  $m^{\text{th}}$  degree.

DIARY OF SOCIETIES.

LONDON.

THURSDAY, DECEMBER 27.

ROYAL INSTITUTION, at 3.—The Manufacture of an Electric Current: Prof. J. A. Fleming, F.R.S.

FRIDAY, DECEMBER 28.

ROYAL GEOGRAPHICAL SOCIETY, at 4.—Holiday Geography: Dr. H. R. Mill.

SATURDAY, DECEMBER 29.

ROYAL INSTITUTION, at 3.—The Current Working of a Chemist: Prof. J. A. Fleming, F.R.S.

SUNDAY, DECEMBER 30.

SUNDAY LECTURE SOCIETY, at 4.—The Action of Light on Bacteria and Fungi: Prof. Marshall Ward, F.R.S.

TUESDAY, JANUARY 1, 1895.

ROYAL INSTITUTION, at 3.—The Working of an Electric Current: Prof. J. A. Fleming, F.R.S.

THURSDAY, JANUARY 3.

ROYAL INSTITUTION, at 3.—The Working of an Electric Current: Prof. J. A. Fleming, F.R.S.

SATURDAY, JANUARY 5.

ROYAL INSTITUTION, at 3.—The Working of an Electric Current: Prof. J. A. Fleming, F.R.S.

CONTENTS.

PAGE

A Standard Treatise on Chemistry. By M. M. Pattison Muir . . . . .	193
Man the Primeval Savage. By Prof. W. Boyd Dawkins, F.R.S. . . . .	194
The Sequence of Studies. By H. G. Wells . . . . .	195
Our Book Shelf:—	
Conway: "Climbing and Exploration in the Karakoram-Himalayas" . . . . .	196
"The Royal Natural History" . . . . .	197
Munro: "Kitchen Boiler Explosions" . . . . .	197
Gordon: "The Island of Madeira, for the Invalid and Naturalist" . . . . .	197
Letters to the Editor:—	
"Acquired Characters."—Right Hon. Sir Edw. Fry, F.R.S. . . . .	197
The Alleged Absoluteness of Motions of Rotation.—A. E. H. Love, F.R.S. . . . .	198
The Antiquity of the "Finger-Print" Method.—Kumagusu Minakata . . . . .	199
Peculiarities of Psychological Research.—Edward T. Dixon; Prof. Karl Pearson . . . . .	200
The Artificial Spectrum Top.—Charles E. Bennham; Prof. G. D. Liveing, F.R.S. . . . .	200
"Solute."—F. G. Donnan . . . . .	200
"The Elements of Quaternions." Lieut.-Colonel H. W. L. Hime . . . . .	201
The Lick Observatory. (Illustrated.) By A. Fowler . . . . .	201
Studies of a Growing Atoll. By Dr. Hugh Robert Mill . . . . .	203
Notes (Illustrated) . . . . .	205
Our Astronomical Column:—	
Advances in Lunar Photography . . . . .	207
Cometary Ephemerides . . . . .	207
Russian Astronomical Observations . . . . .	207
On a Remarkable Earthquake Disturbance observed at Strassburg, Nicolaiew, and Birmingham, on June 3, 1893 (Illustrated.) By C. Davison; Dr. E. von Rebeur Paschwitz . . . . .	208
Explosions in Mines . . . . .	211
The Possibilities of Long-Range Weather Forecasts. By Prof. Cleveland Abbe . . . . .	212
Scientific Serial . . . . .	213
Societies and Academics . . . . .	214
Diary of Societies . . . . .	216

THURSDAY, JANUARY 3, 1895.

## BIOLOGICAL LECTURES AND ADDRESSES.

*Biological Lectures and Addresses delivered by the late Arthur Milnes Marshall, M.A., M.D., D.Sc., F.R.S.*  
 Edited by C. F. Marshall, M.D., B.Sc., F.R.C.S.  
 (London: Nutt, 1894.)

MANY of us remember the pleasure experienced in listening to the vigorous addresses of Prof. Milnes Marshall, whose sudden death, about a year ago, was such a blow to biologists and to all interested in the spread of scientific education. In reading them now, the energy and humour of the speaker are ever present in the memory, giving life to the apt illustrations and clearly expressed thoughts.

The choice of appropriate subjects for the occasion of these addresses shows remarkable discrimination. It is quite clear that the late Prof. Milnes Marshall believed that a single address—if heard at the right point in his career, and delivered with the confidence of this belief—might change the whole attitude of mind with which a student approached his subject.

Lecturing to the Owens College Medical Students' Debating Society, he chose as his subject "Embryology as an aid to Anatomy." In preparing to address a class of students expected to deal with, and to remember, in the course of their daily work, innumerable details which are as yet far from receiving a scientific interpretation, he selected embryology, which "offers an explanation of many otherwise completely unintelligible anatomical facts"; and by the example of the development of the nerves supplying the muscles of the eye, the thoughts of many young anatomists may well have been turned into a direction which was of the most inestimable benefit to their study.

Equal wisdom and foresight were shown in the selection of subjects for addresses to the Members of the Manchester Microscopical Society, viz. "Inheritance" (1888), "The Shapes and Sizes of Animals" (1889), "Some Recent Developments of the Cell Theory" (1890), and "Death" (1893). In the choice of these subjects, and in their treatment, the Members of the Society are shown that the most profound biological problems are to be approached and, perhaps, solved by the study of the most minute detail and the lowest forms of life. The student thus made fully aware of the dignity and possibilities of his subject, will not be likely to forget, in the patient investigation of histological or biological detail, the wide issues which are at stake.

The subjects chosen for presentation to other audiences are just as happy. Sometimes, as in "The Theory of Change of Function," a difficulty in evolution by natural selection is taken as the subject, and the final solution given in the clearest and simplest manner. It would be well if this address were widely known, for the difficulty it deals with is still frequently raised, just as if no explanation had ever been forthcoming. In other cases, wide questions, such as "The Influence of Environment" or "Animal Pedigrees," form the subjects of the addresses.

The addresses abound in humorous and apt illustrations. Thus, on p. 39, in order "to show that, even in our worldly transactions, changes of environment often produce not only direct and immediate changes and readjustments, but also definite and calculable ones," he gives as an example the following:—"Let *a* be a merchant, and *b* his purse: the combination *ab* will at once strike you as a natural and stable one. . . . Now let *c* be a highwayman, and *d* his pistol: the combination *cd* is again recognised as a natural and stable one. Now, bring the compound *ab* into the presence of the compound *cd*, and mark how the stability of the former is shaken. . . . The several elements become rearranged in a manner that finds perfect expression in the formula—

$$ab + cd = a + bcd."$$

Again, in order to illustrate the tendency towards reversion to an ancestral condition, the card house is selected—

"The resulting structure is a far more imposing one than the pack of cards when laid flat on the table, but it is also an eminently unstable one, its instability being directly proportional to the extent to which it departs from its initial condition." (p. 104.)

"The influence of food yolk on development" is compared to "that of capital in human undertakings" (p. 224), the metaphor being worked out in an interesting and amusing manner. Prof. Weismann's views on the absence of death in Protozoa are illustrated on p. 273 as follows:—

"If the original Amœba be called Tom, and the products of fission Dick and Harry, the upshot of the process may be expressed by saying that Tom has disappeared without having died, while Dick and Harry have come into existence without having been born. Nothing has died, there is no corpse to bury, and our ordinary ideas with regard to individuality and identity fail altogether to afford answer to the question—Where is Tom at the end of the process?"

There are a few sentences in the addresses which are perhaps capable of misconstruction. Prof. Milnes Marshall appears to have hesitated to accept the belief in the hereditary transmission of acquired characters, and yet there are some statements which seem to imply this belief. This is the case with the statements that the white man and the negro have been evolved "through the long-continued action of selection and environment" (pp. 247 and 358), that modifications of development have occurred "due chiefly to mechanical causes" (p. 316), that the "larger size of the eggs of fresh-water forms appears to be dependent on the nature of the environment" (p. 313), although in this case it is clearly shown on the following page that environment is believed to act selectively and not directly.

The term "acquired character" is made to bear still further burdens in the way of special interpretations. It was unfortunate so late as 1890 to continue to speak of the distinction in development "between those characters which are really historical and inherited, and those which are *acquired* or spurious additions to the record" (p. 307), or to speak of the view that Amphioxus and the Cyclostomes are "degenerate animals—whose simplicity is *acquired* and deceptive rather than real and ancestral." (p. 335.)

The book is well and clearly printed, and has been extremely well edited. The only printer's error noted was in the title of Mr. Oldfield Thomas' paper on p. 318. E. B. P.

#### TEXT-BOOK OF AGRICULTURE.

*Advanced Agriculture.* By H. J. Webb, Ph.D., B.Sc. (Lond.). 8vo., pp. vi. and 672. London: Longmans, Green, and Co., 1894.

TEXT-BOOKS of agriculture are rapidly increasing in number. The name of the author on the title-page of this is that of the late Principal of the Agricultural College at Aspatria, Cumberland, who, most unfortunately, was unable to complete the work. He was struck down at a comparatively early age, and in the midst of hard work and a successful career. He is most highly spoken of, and deservedly so, in the preface by the editor of the book, Mr. J. Lister, of Aspatria. From such hands we anticipated much and good work, though the task might appear heavy. We regret to say that we have been greatly disappointed.

We are told that—

"This work, though primarily intended for the advanced stage of the Science and Art Departments' Examination in Principles of Agriculture, will also cover the greater part of the syllabus of the Honours stage. Care has, however, been taken not to adhere too rigidly to the syllabus in question, and we trust it may be found equally serviceable for the examination for the diploma in Agriculture of the Highland and Agricultural Society in Scotland, and the senior examination of the Royal Agricultural Society of England."

Even the fact that the book has been prepared mainly to assist students to pass examinations, can hardly excuse some of the statements we meet with. In agricultural geology we are told, among other scraps of information that zeolites are "hydrated silicates of alumina or lime." This is scarcely true. "Diorite consists of plagioclase and hornblende." This is true, but as the meaning of plagioclase is nowhere explained, it does not help the student much. In agricultural physics we learn that "a heavy soil might contain absolutely double the amount of phosphoric that a light soil did, although it would show only the same percentage if it were twice as heavy." We have tried to believe this, but till now we do not understand it. In engineering, a definition of horsepower is given without any mention or suggestion of *time* as a possible factor.

In chemistry, *Redonda* [Redonda] and *Alta Vela* phosphates are said to contain a large quantity of *alum*; leather to contain 4½ to 9 per cent. of *ammonia*, and meat-meal and meat-guano to contain much *ammonia*. This is the more confusing, as in other manures, mentioned on the same page, the percentage of *nitrogen* is correctly given; but this confusion of ammonia with the ammonia equivalent of the contained nitrogen is common throughout. Ammonium chloride is said to contain about 18½ per cent. of water and 32½ per cent. of ammonia. The formula of monocalcic phosphate is correctly given as  $\text{CaH}_2\text{P}_2\text{O}_7$ , and tricalcic phosphate as  $\text{Ca}_3\text{P}_2\text{O}_8$ , and, yet, in one analysis 18.01 per cent. of the former is said to be equal to 2.11 per cent. of the latter, and in another case 19.2 per

cent. of monocalcic phosphate is said to be equal to 30.07 per cent. of tricalcic phosphate made soluble: of course the so-called monocalcic phosphate in these analyses is calcium metaphosphate, formerly known as "biphosphate"; but how can the student know this? Cellulose is described as a white amorphous powder.

In agricultural botany, we are told that "protoplasm generally presents itself as a granular semi-fluid substance with or without a cell-wall." "The corolla, when present, usually consists of green leaves or sepals, sometimes scarcely noticeable." This later statement is, of course, only a misprint: but it is also only an example of several similar serious misprints.

The root residues of crops remaining in the soil are said to "consist very largely of protoplasm." The section on farm crops, however, in which this occurs, is written in a curious style, somewhat difficult to follow.

On looking up information regarding anthrax, we find that "although a disease of the blood, the writer [in this case Mr. H. Thompson] considers it more of a dietetic nature, having seen it produced from steeped brewers' grains allowed to stand till they had reached the acetous stage of fermentation. It is also produced by the hay bacillus, obtained from the fermentation of chopped hay and from mouldy cotton-cakes, more particularly the undecorticated variety. He has also seen it arise in certain undrained lands. Although very fatal to other animals, such as dogs, cats, and poultry, that may have eaten the flesh or blood, yet he considers it neither infectious nor contagious, having never known it to extend beyond the buildings in which it originated. Again, the disease was always traceable to some peculiarity of the feeding, and the writer thinks that it is analogous to an aggravated form of *red water*." And this stuff is set forth as *advanced* agriculture. There are several very startling statements in the chapter on veterinary science: e.g. in retention of the foetus, "different bones belonging to the foetus, such as jaw, scapula, ribs, humerus, and several others, are passed at times through the rectum."

In the chapter on agricultural entomology, we hardly suppose the author is serious when he recommends the use of rape-cake, at the rate of two or three tons per acre, to clear the field of wire-worms.

In part ii. of the book the misstatements are perhaps not quite so numerous or so serious, but they are not absent. In the chapter on permanent pastures, after a notice of the power which leguminous plants, with the aid of the low organisms present in the nodules on their roots, possess of appropriating free nitrogen, we are told that "this fact of the nitrogen-storing power of the leguminous plants explains the action of heavy dressings of nitrogenous manures on permanent pastures encouraging the growth of grasses, especially the coarser ones, at the expense of the clovers." We fancy that this *explanation* of the fact will not satisfy many readers.

The work of Rothamsted is frequently referred to and fully appreciated; but why should Rothamsted be spelt in three different ways in the book? Probably, however, every would-be advanced agriculturist knows that there are not three Rothamsteds.

But we have given enough instances of what are very serious flaws in the book. Much of the matter is exceedingly good and useful; but does not this really add to the



danger of the work in the hands of the learner who is not in a position to sift the wheat from the chaff and the weeds?

We do not think that this book will serve to advance the reputation of its author, nor to advance agriculture. We submit that "advanced agriculture" is not agriculture *plus* a smattering of chemistry, a dip into geology, a pinch of botany, a skim of entomology, a sniff at meteorology, and so on; even if the sciences be correctly expounded. The text-book of agriculture, like that of other subjects, has no doubt to pass through stages of evolution, and we trust it will not long remain at the stage indicated by this book.

#### EWING ON THE STEAM ENGINE.

*The Steam Engine and other Heat Engines.* By Prof. J. A. Ewing, M.A., B.Sc., F.R.S., M.Inst.C.E. (Cambridge: The University Press, 1894.)

ENGINEERING students and others will welcome the present volume as one likely to increase their knowledge of an important branch of engineering, from the pen of an acknowledged master of the science; any work by Prof. Ewing is sure to be read by engineers generally, and treated as a book for constant reference.

As is well known, Prof. Ewing wrote some valuable articles for the "Encyclopædia Britannica" on this subject, and it is an expansion of these articles which constitutes the basis of this work. As a University text-book this volume will fill a great want, treating as it does, from the theoretical side, a subject only descriptively dealt with in the majority of such text-books. As the author remarks: "The endeavour throughout has been to make evident the bearing of theory on practical issues."

The first six chapters may be said to contain the early history of the steam engine, and a scientific treatment of the general behaviour of steam in the cylinder, as well as the general theory of heat engines. The information thus brought together is of a valuable nature, and the references which are made, add considerably to the usefulness of the work. To the thoughtful practical engineer, this portion of the book will form a perfect mine of matter for careful consideration.

The testing of steam engines has of late years become a common occurrence, thanks to Profs. Kennedy, Osborne Reynolds, and many others. Designers and manufacturers of such engines have everything to gain by such experiments; few being, like the late Mr. Willans, capable of carrying out scientifically accurate trials of their own engines. Chapter vi. deals with this important question. Many useful hints are given, and sources of error carefully pointed out. As indicator diagrams play such an important part in the trials of steam engines, it is interesting to note that the Crosby Company's modified form of Richards' Indicator is considered by Prof. Ewing to be one of the best.

Compound expansion comes in for very full and accurate treatment; many sets of indicator diagrams are explained and illustrated, and the difficult matter involved in the combination of such diagrams is lucidly dealt with. Of the advantages of compound expansion in the

use of high-pressure steam, we are told much, and also of the mechanical advantages of such an arrangement. We cannot help pointing out that, in this matter, the practical men on the Clyde were singing the praises of compound engines before the theoretical men would admit of their utility or economy. On valves and valve gears our author has much to say, although we notice nothing remarkable in the chapter. Locomotive engineers do not trust entirely to the drawing-board or calculation in the design of valve gears. It is now the practice to try the proposed gear as a full-size model on the valve gear testing machine, and so to obtain the best results. The latest machine of this kind has been erected in the drawing-office of Messrs. Sharp, Stewart, and Co., the eminent locomotive engineers, of Glasgow. The saving of time is great, and very accurate results are obtained. In fact, in such drawing-offices, the old valve diagrams, with their many curves, are things of the past, and a simple table of leads, cut-offs, suppressions, &c., for the different degrees of expansions, has taken their places.

Chapter ix. treats of the many forms of governors used for regulating the work done in the steam engine, commencing with Watt's simple arrangement, and finishing with the differential or dynamometric governors invented by the late Sir W. Siemens; and further on in the book we find much useful information concerning the work on the crank shaft. Diagrams of crank efforts are given, and the effect of friction and of the inertia of the reciprocating pieces are duly discussed. The balancing of machinery is an all-important subject, in fact the life of any machine depends upon the balancing of its moving parts; for this reason, we are sorry to see that Prof. Ewing has so little to say on this subject generally, and particularly on the balancing of locomotives. If theory is of any help to the locomotive engineer at all, surely it could be best applied in balancing; some engineers balance the whole reciprocating weight, others none; the majority about 30 per cent.: which is right? Prof. Ewing does not help us, but observes that "the final adjustment of the balancing masses is usually a matter of experiment, the locomotive being hung in chains to allow its oscillation to be observed"; this, to say the least of it, is never done in this or any other country.

The production of steam is the subject treated in the following chapter; the illustrations of the different boilers, with the descriptions, are excellent. The only specimens of water-tube boilers illustrated are the Thornycroft and the Babcock and Wilcox, the latter used principally for stationary engines. The Thornycroft boiler is the forerunner of similar types; for instance, the Yarrow and the Clyde among others, all of which are considerably lighter than the ordinary marine boiler. As an example of the locomotive boiler, one of the London and North-Western Railway Company is taken as typical of British practice. As an example of an injector for feeding boilers, an old-fashioned type of Giffard injector is illustrated, but more recent types are described. Mechanical stoking and the use of liquid fuel are also mentioned.

The following chapters conclude the work, occupying some sixty pages with descriptions of forms of steam engines, air, gas, and oil engines. The Willan's central

valve engine is well illustrated, and the description does credit to what is probably the most economical steam engine ever designed. A description is given of rotary engines, but none are illustrated. The "Rota" engine, designed and made by MacEwan Ross, of Glasgow, might have been included with advantage. The locomotive is outlined, and the compound type described; but no information as to tests is given, probably because no trustworthy data can be obtained; and as no British Railway Company, with one possible exception, is likely to build any more compound engines, it seems probable they are not the unqualified success they were originally claimed to be, although the Vaucrain system, with four outside cylinders, appears to be a success in the States. But it must not be forgotten that the American rival is a very uneconomical engine when compared with our own.

N. J. L.

### OUR BOOK SHELF.

*Das Verhältnis der Philosophie zu der empirischen Wissenschaften in der Natur.* By David Wetterhan. (Leipzig: W. Engelmann, 1894.)

THIS is the essay which gained the prize of 1000 marks offered in 1891, by the Philosophical Society of Berlin. It consists of 110 pp., of which about twenty are occupied by notes and abstracts from various writers, in small print.

Naturally, in giving forth his own views, some of which possess considerable originality, the author makes continual and extensive use of the theories of Kant, Schopenhauer, Windt, Bunge, and others; and one noticeable feature about the work is the full share of recognition accorded to English philosophers and scientists, such as Faraday, Herbert Spencer, Darwin, Romanes, and Huxley. The writer well remarks that the limits of scientific knowledge are everywhere and nowhere.

In the earlier pages the author discusses the relation between the physical and the psychical sides of nature. The theory of the conservation of energy has nothing to do with mental processes: it governs the quantitative relations of all processes of nature, but does not explain their qualitative differences. Sensation, consciousness, motor impulses, are not forms of energy, and do not correspond to them, but to the causes of qualitative changes in forms of energy.

The world of psychics cannot be separated from that of physics, and we must look forward to the future progress in the latter science to bring the qualitative changes into connection with the theory of the conservation of energy. The author shows by a very simple example—"Shall I kill that spider, or leave it alone?"—the effect of his will on surrounding nature; and the divergent effects there in which a will result from each of the two alternative modes of procedure.

Memory he believes to be caused by an impulse of a certain kind, producing in the particular arrangement of the smallest portions in the ganglion cells and nerve fibres a modification in the same direction as was produced by the original impulse, and resulting in corresponding physical phenomena. But he acknowledges that, at present, we cannot explain "brain oscillations."

The principle of evolution sheds a light upon the psycho-physical problem: physical development is not the cause but the effect of psychical development, and the modifications in the brain and nervous system throughout the animal kingdom are intelligible as resulting from physical causes, whereas the physical causes, if

they exist, remain hidden. He considers that even in paleontology we can detect traces of this psycho-physical process by the examination and comparison of the cranial capacity of the skulls of extinct reptiles and mammals. As man is the culminating point in mental development amongst mammals, so is the ant amongst insects; but clearly this position has in each case been attained independently, and is independent of the structure of the nervous system. The inheritance of acquired characters is discussed, and the old difficulties presented by a disbelief in it are once more brought forward; and especially the difficulty in the adaptation of terrestrial mammals to a life in water, such as must have occurred in the ancestors of the Cetacea. The author endeavours to show that the principle of progressive psycho-physical development may admit of a vital-mechanical explanation, if the transference of acquired characters, as a consequence of changed functions, is possible for "keimplasma."

The author is apparently a practical man of science, and not a mere arm-chair philosopher; he fully recognises that philosophy must be based upon scientific experiments, and quotes Huxley's words, "The Laboratory is the forecourt of the temple of Philosophy."

*Meteorology, Practical and Applied.* By John William Moore, B.A., M.D., M.Ch., F.R.C.P.I. (London: F. I. Rebman, 1894.)

IT is to be hoped that this little book may meet with the popularity it deserves. Well written and well illustrated, it ought to recommend itself to that numerous class of whom some knowledge of meteorology is now required. The author, a medical practitioner, has evidently, first of all, but by no means exclusively, sought to interest medical officers of health and those who seek a qualification in preventive medicine and its allied branches. Writing for such students, the author has prudently not burdened his work with technical terms, or attempted to discuss with any completeness the general motions of the atmosphere depending upon the application of thermodynamics. Neither does he fall entirely into the popular and pleasing style of writing; though he does seek legitimate interest by exhibiting the many points in which meteorological inquiry bears on social and sanitary science, how it may benefit the agriculturist, protect the traveller, or instruct the physician.

The book is divided into four sections. In the first we find a very full and, considering the source from which it is drawn, probably accurate account of the history and development of the United States Weather Bureau. It seems to have occurred to the author, that if he shows to the reader at an early stage the interest and devotion which the shrewd American gives to this subject, he will convince him that there is something in meteorology after all, beyond the dreary and wearisome accumulation of barometer and thermometer readings. Then we have, of course, the description of the necessary instruments in use, with their corrections. We are glad to see in this section due prominence given to Mr. Aitken's interesting work on atmospheric dust; and in the chapter on evaporation we notice that Mr. Apjohn's formulae are given correctly, which is not the case in some other well-known elementary works. The third section of the book treats of climate and weather, a section that might with advantage have been made fuller; but in reviewing the whole subject of meteorology within moderate compass, it is necessary to curtail somewhere. The last section considers the influence of season and weather on disease. Here the author is apparently on very familiar ground, and the small space devoted to this topic is full of interest and suggestion. There are one or two slips in the text, as, for instance, on page 10, where the oft-repeated

error is once again seen, of mistaking the axis of rotation of the earth for the plane of the equator; but such oversights are easily excused in presence of the collection of a large number of facts, well arranged and tersely expressed. W. L. P.

*The Province of South Australia.* By J. D. Woods, J.P. With a Sketch of the Northern Territory, by H. D. Wilson. Pp. 446. (Adelaide: C. E. Bristow, 1894.)

THIS account of the province of South Australia, from its discovery to the end of 1892 was, the preface informs us, written under the authority of the Government of the Colony. It may therefore be taken as an authoritative work of quite a different and a better kind than the many descriptions of Australia that have appeared during the past few years. The physical features, fauna, flora, climate and meteorology are fully described, and the story of the explorations of the interior of the continent is full of interest. There is a chapter on the agriculture of South Australia, and one on the minerals in which the province is so wonderfully rich. Those familiar with the history of education in South Australia will remember that prior to 1874 the colony did not possess a university. It was in 1872 that an endowment of £20,000, given by Sir W. W. Hughes, was applied to the founding of two professorships one for classics and comparative philology and literature, and the second for English language and literature and mental and moral philosophy. Science was benefited shortly afterwards by a like donation from Sir Thomas Elder, to found a professorship for mathematics and another of natural science. The same benefactor gave £10,000 for the establishment of a medical chair in 1883, and £1000 for evening classes; and the Hon. J. H. Angus gave £6000 for the creation of a chair of chemistry, and £4000 for the establishment of scholarships and exhibitions. Though the Adelaide University was incorporated in 1874, the present University buildings were not opened until 1882. The School of Mines and Industries, as it is officially designated, was opened in 1889, and has steadily increased in influence and usefulness since then.

The chapter on the aborigines of South Australia is perhaps the best in the book, and as the author has had more than forty years' experience with the blacks, he writes upon what he is well qualified to describe. Altogether the volume includes much that has not hitherto appeared in print in a collected form, and therefore deserves to rank with the best books on Australia, its people, and its resources.

*Measurement Conversion Diagrams.* By Robert H. Smith, Professor of Engineering, Mason College, Birmingham. (London: Charles Griffin and Co., Limited, 1895.)

THE scope of this work is described on the title-page as follows:—"Forty-three graphic tables or diagrams for the conversion of measurements of different units, comprising conversions of length, area, volume, weight, stress, density, work; energy in mechanical, thermal, and electrical units; horse-power, and temperature." Only those who are familiar with graphic statics know what can be done by diagrams, but even they will be astonished at the wide range of conversions covered by Prof. Smith's graphic equivalence plates. The diagrams will principally aid the conversion of English and metric measures, and *vice versa*, but they also represent the relations between different systems of English, and of French, measurement. We have always been attracted by the method of expressing equivalents by means of squared paper, and Prof. Smith's graphic tables have greatly increased our admiration of it.

LETTERS TO THE EDITOR.

[The Editor does not hold himself responsible for opinions expressed by his correspondents. Neither can he undertake to return, or to correspond with the writers of, rejected manuscripts intended for this or any other part of NATURE. No notice is taken of anonymous communications.]

The Kinetic Theory of Gases.

I DO not feel as if those who heard me ask some questions at the British Association at Oxford, about the kinetic theory of gases, exactly understood my difficulties. They are those of an onlooker, and so they may be of general interest. As several of them have been fairly satisfactorily answered, it may be worth while stating the present position of such an onlooker as myself.

In the first place, consider the difficulty as to reversibility and as to the number of possible ways in which a system could be started on a reverse path so as to obtain a *given* initial state. This is, I think, completely answered in the way Mr. Larmor gives in his letter on p. 152. As well as I can recollect, Mr. Culverwell and I had been mutually satisfied by this kind of explanation previous to the meeting at Oxford, and it was not then referred to.

The question of reversibility lately started, as I understand it, has reference to the introduction of the postulate of chance in the deduction of the theorem about II. Mr. Burbury, in his recent letter, has indicated a proof of this theorem, in which he explicitly postulates chances, and so far justifies the possibility of proof on these lines. I understand that Mr. Culverwell is so far satisfied, and only asks for more, *i.e.* an extension of this form of proof to other cases than the simple one of colliding spheres.

Secondly, as regards the solar system, &c., I am not yet quite clear why a finite number of particles moving about for an indefinitely long time does not satisfy the conditions of the problem as usually stated, just as well as a large number of bodies for a short time. As to the necessity for *collisions* among the parts of a system, I cannot see why the earth, moon, Jupiter, and sun are not to all intents and purposes of the generalised coordinates in collision at present and always; and I desired to know why any other kind of collision is required for the application of the investigation. I think I now see, through conversations with Mr. Culverwell, where the existing investigations may fail to apply to solar systems. I may explain my position as follows. It was always, I knew, postulated that more than two particles should not be in collision at once, and I therefore asked how this could be an essential part of the investigation when applied to the case of air near the earth subject to gravitation. I did not see why the *earth* was not (so far as the generalised coordinates investigation was concerned) a particle in collision with every particle of the air during every one of their collisions with one another, and consequently violating the postulate requiring only *two* particles to be in collision simultaneously. I now understand that when dealing with gravitation and such like forces, these are supposed to be directed to *fixed* centres, and that in the case of a large particle like the earth this is very nearly true, but that it could not be even approximately true if we had three fairly equal particles acting upon one another simultaneously. This may also explain why the equal partition of energy does not hold in the solar system where the bodies do not act upon one another in pairs, but are all always subject to one another's action. This, as I understand, is also the reason why the direct distance law is not an exception to the equal partition of energy theorem. It also may explain how we can have water and steam in equilibrium with one another, notwithstanding the apparent *uniqueness* of the Boltzmann-Maxwell solution. From experience it would seem that when we can extend the investigation to the case of several bodies in simultaneous collision, we shall find that there are *three* solutions corresponding to the solid, liquid, and gaseous states. At the same time, some of the very general investigations that seem to me, as a physicist, as if they were intended to apply to complex molecules in collision with one another, and with a partition of energy amongst the atoms, appear to violate the postulate of collisions in pairs; for I find it hard to conceive of these molecular systems of atoms as other than systems, the various parts of which are held together by mutual actions, and which must consequently

be considered to be in simultaneous collision with one another. This may be where the spectrum crux fails. Perhaps somebody would be so very kind as to point out where exactly in these generalised coordinate investigations the postulate of collisions in pairs is used, and so save lazy people like me the trouble of hunting it up.

This raises the third point as to how this difficulty about the spectral lines is to be surmounted. I cannot follow either Mr. Bryan's, or what I understood to be Mr. Larmor's view, that any help can be got by supposing spectral lines to be due to electromagnetic vibrations. The example Mr. Bryan gives of smooth solids of revolution is quite beside the point. In this case there is *no interchange of energy* between rotation round the axis of revolution and the other degrees of freedom. This is quite contrary to what we know to be the case in respect of ethereal and molecular energy. We know that radiations cause bodies to become cooler, and therefore there is interchange of energy. This could not be otherwise, as is evident from what we know of the mechanical forces—electric, magnetic, and electromagnetic—that interact between matter and ether. It is rather hard for Mr. Bryan to say that the *onus probandi* lies with physicists to explain exactly how transference takes place; surely the fact that transference does take place is sufficient to prove that a complete theory should take in both sets of coordinates—etherial as well as material—and I should have thought that those formidable arrays of  $dp_1 dp_2 \dots dp_r$ , &c., of coordinate and momenta to the *n*th, with dots between to signify their indefinite number, should include everything of this kind that could possibly be required. Here, however, the postulate of collisions in pairs entirely breaks down, and thus shows a way out of this spectral difficulty. A second way was suggested to me, by whom I forget, at Oxford, namely, that the complicated systems of lines that we see in the spectrum—of iron, for instance—are so connected as to their amplitudes, periods, and phases, as to represent only a single coordinate. Any body who has tried to expand a simple function in Fourier series will easily understand how a very simple motion might produce a fearfully complicated spectrum.

It seems, then, to me that the questions which need solving in our study of the dynamical foundations of thermodynamics at present are (1) how to explain spectra, and (2) how to deal with several bodies in simultaneous collision?

GEO. FRAS. FITZGERALD.

Trinity College, Dublin, December 19, 1894.

The difficulties in the way of harmonising the spectroscopic phenomena of heated gases with the conclusions of the Boltzmann-Maxwell theorem of distribution of kinetic energy, appear to me to have been exaggerated.

The theorem asserts, as a purely dynamical proposition, that a very large number of, say, billiard balls, perfect as to sphericity and elasticity, having been set in haphazard motion in a space limited or interrupted by perfectly elastic rigid surfaces, if the volume of that space be sufficiently large as compared with the mean size of the balls, will, if left to itself, tend to a certain state of density and velocity distribution, and having reached this state, will remain in it permanently. The billiard balls may be replaced by rigid bodies of any form, or indeed by matter which is capable of any changes of shape or motion of the part among themselves, and a corresponding proposition will prevail as a general property holding good in all cases, viz. that if  $m_1, m_2, \dots, m_r$  be the motions of translation of each system as a whole,  $\Sigma m_i^2$  its total kinetic energy, and  $n$  the total number of its degrees of freedom inclusive of the 3 of translation, then in the permanent state

$$\frac{m_i^2}{2} = \frac{E}{2n} \quad \text{for all } i,$$

where  $\bar{m}_i^2$  denotes mean value through of the whole medium.

From this there is a discontinuity in the abstract proposition and that for the basis of physical investigation, e.g. the smallest possible want of perfect elasticity in the billiard balls will appear to effect a complete change in the physical properties of the medium as if each ball became an ellipsoid or tetrahedron, the mean  $\bar{m}_i^2$  being changed per

centage of  $\frac{1}{n}$  for each degree of freedom. It is true or more spaces are at any rate, on a collision, in fact, the number of degrees of freedom in which the balls are free to move.

ultum from T 3 to T 6, and the difficulties introduced by the spectro-scope are founded upon this discontinuity. Doubtless we cannot make  $n$  fractional, but it should be remembered that the dynamical proposition only speaks of an *ultimate* state, and ignores the rate of approach to that state. The continuity of physical properties is maintained by attending to the continuity of change in this rate. This rate I have estimated for a particular case in the new edition of my short treatise on the subject, showing that there may be a *sensible* permanence long before the law of equal partition is established.

And, again, there is yet another point to be considered. The passage from the thermal to the optical properties resembles the passage from mere noise to music. Dynamically it is the passage from irregular, haphazard motion, *heat*, to regular periodic motion, *light*; the former must be decomposed into its equivalent harmonic motions, and the most important terms retained, but there would be no necessary relation between the number of these terms (sensible bright lines) and the number of degrees of freedom of the molecule. H. W. WATSON.

The Horn Expedition to Central Australia.

In your issue of September 27, 1894, occurs a short notice of the work of the Horn scientific expedition to Central Australia. Reference is made therein to the discovery of a "new type of marsupial" by Dr. Stirling. The animal in question was found by Mr. South, a mounted trooper (or rather by his cat, who brought it into the house), at Alice Springs. By him it was presented on our arrival to Dr. Stirling, who had charge of the anthropological work of the expedition, by whom it was kindly handed on to me as officer in charge of the zoological department. The specimen was a male, and being desirous of securing more, I stayed behind the party, and by aid of the blacks procured two more specimens, both of them females. The animal, which lives in holes amongst the rocks and stones, is by no means common, as I had to offer considerable quantities of flour and tobacco to the blacks as a reward for its capture. After a number of them had been out hunting for several days the total result was two more specimens, though as these were females they formed a welcome addition to my zoological collections. As the expression, "a new type of marsupial," gives rise to too great expectations, it may be as well to state that it is merely a new species of the genus *Phascogale*, distinguished, amongst other points, by its remarkably fat tail and by the nature of the striated pads on the soles of its feet. I was able to make drawings of the animal alive, and on showing these to the blacks at Charlotte Waters, some 250 miles to the south of Alice Springs, they were at once greeted with cries of "Amperita," the native name for the animal which they took it to represent. Through the kindness of Mr. Byrne, the head of Charlotte Waters Telegraph Station, I have since been provided with specimens of the "Amperita," which on examination turns out to be the rare form—only as yet, I believe, known from a single specimen—described by Krefft under the name of *Chatoerax cristellanda*, and subsequently placed by Mr. Oldfield Thomas in the genus *Phascogale*.

These two species, and a new one of the genus *Sainthopsis*, which we secured amongst the sand-hills near Lake Amadeus, are the most important finds amongst the marsupials which, owing to the country traversed by us being in the main of a desert description, were by no means plentiful. In this region animals can only be secured in numbers after rain, an experience which, during three and a half months' wandering, did not fall to our lot. However, as one result of Mr. Horn's generous action in equipping the expedition, I hope to be able to give a fairly good general account of the fauna of the central desert region of Australia. Towards the close of the notice referred to, it is said that there is some doubt as to the manner of publication of our results. Mr. Horn's intention is, I believe, to issue a separate volume, the various parts of which will deal with the branches of science represented by the members of the scientific staff as follows:—

Prof. R. Tate (chairman of the scientific staff), geology and botany; Dr. E. C. Stirling, anthropology; Mr. C. Winnecke (leader of the expedition), surveying and meteorology; Prof. Baldwin Spencer, zoology; Mr. J. A. Watt, geology and mineralogy.

The volume will contain an accurate map, compiled by Mr. Winnecke, of the central district drained by the Finke river,

and will, by means of the reproduction of photographs, illustrate some of the more important physiographic features of Central Australia.  
BALDWIN SPENCER.

**Palæontology at the Royal School of Mines.**

IN reading the excellent review of the biography of Sir R. Owen, which appeared in last week's NATURE, I observe an error which, though small, requires correction. It is stated that when Owen surrendered his appointments at the College of Surgeons he was "enabled to accept the lectureship on Palæontology at the Royal School of Mines, in 1857." The records of that Institution will show that Owen never held a lectureship there, nor was he in any way connected with the School.

The large theatre of the Museum of Practical Geology was frequently employed for other purposes than those of the School, by permission of the Director-General; and it was in virtue of such permission from Sir Roderick Murchison that Prof. Owen used the theatre for the delivery of his lectures on Palæontology to the public, in 1857 and subsequently.  
T. H. HUXLEY.

Eastbourne, December 27, 1894.

**Eocene Fossils at Murren.**

I HAVE read with surprise the extracts from the letter which you have received from Dr. Fellenberg on this subject. Of course it has long been known that there are Eocene strata at Murren. But below them lie calcareous rocks coloured on the Swiss map as Malm. These are so described on p. 211 of the "Livret Guide," published by the International Geological Congress which met this autumn at Zurich. During the subsequent excursion, under the able guidance of Prof. Renevier, Prof. Golliez, and M. Lugeon, we were taken to Murren and shown these rocks, and Prof. Golliez gave us the reasons which had led some geologists to regard them as Trias rather than Malm. It was in these calcareous beds that the layer containing nummulites was met with. The train was just starting, and we had to leave, but the find excited so much interest that M. Lugeon returned to Murren the next day, with some of the party, and verified the exact locality.  
JOHN LUBBOCK.

High Elms, Farnborough.

**The Use of the Globe in Crystallography.**

IN your issue of December 20, Mr. Buchanan revives a graphic method of crystallographic calculation which seems to have been used in the early part of the century (*vide* "Zur physischen Krystallonomie, &c.," Grassmann, 1829, p. 37), and claims that by use of the globe and *metaphire* "every problem in the geometry of crystals can be solved with ease and accuracy."

Crystallographic angular measurements are said to be accurate if subject to a probable error of less than two or three minutes, and descriptions of inorganic substances are nowadays habitually published in which the probable errors are of this order. Although no details of Mr. Buchanan's method are given, it seems inconceivable that any graphic process of crystallographic calculation, involving triangulation on a sphere, could be accurately performed without the use of numberless tedious precautions and large and cumbrous apparatus.

It is usually more easy to grasp a good plane diagram of any solid figure than to understand and follow up explanations on the solid figure itself; the use of the latter is liable to lead to inaccuracy of expression and confusion of thought. Thus, when the sphere is used, the real meaning of the points which Mr. Buchanan describes as cataloguing the edges occurring on crystals, is not at once seen; using the plane projection, it is immediately apparent that these points are characteristic, not merely of the edges, but in a much wider sense, of the zones; they are merely the poles of the zone circles.

Further, the positions of the points representing the corners are dependent on the *sizes* of the faces concerned, which, as we teachers of crystallography are at infinite pains to impress on our students, have no crystallographic signification; these points, then, are not *characteristic* of the corners.

Similarly, the rather complicated piece of reasoning respecting "reciprocal inversion forms" simply yields the well-known result that in the cubic system, the octahedron truncates the corners of the cube.

WILLIAM J. POPE.

Central Technical College, South Kensington.

**"The Zoological Record."**

It has long been a matter of regret that the *Zoological Record* is not sold in separate parts; a specialist requiring any one part being required to pay for all the others, though they may be of no more use to him than so much waste paper.

In order to remedy, to some extent, this unfortunate state of things, I am proposing (if sufficient support is forthcoming) to purchase the *Zoological Record* as published, and to issue the separated parts to subscribers. With this view, I would ask all those desiring any part (of the volume just issued, or of past volumes) of the *Zoological Record*, to communicate with me *as soon as possible*, stating *which part* they would be willing to subscribe for.

Although it is, of course, not intended to make a profit out of this scheme, it will nevertheless be necessary to charge slightly more for the separated parts than their proportionate value, as some parts are almost certain to remain unsold.

I am confident that this scheme will not in any way injure the Zoological Society; in fact, although they maintain the contrary, I am sure it would be to their advantage to issue the parts separately, if necessary at a slightly higher rate. At present subscribers are, I believe, mostly libraries and societies, requiring the whole volume. These would, of course, continue to subscribe for all parts, even if they were obtainable separately; while, on the other hand, all specialists who do not subscribe under the present arrangements would be practically certain to purchase those parts dealing with their own subjects, if obtainable at a moderate cost. If the proposed scheme meets with support, it will go a long way towards proving the justice of the foregoing contention, and in that case it will probably be possible to induce the Zoological Society to grant the concession for which many zoologists have for long been agitating.

Royal College of Science, London.

S. PACE.

**Gravitation.**

IN answer to Dr. Lodge's letter, I may state that Newton in his "Opticks" (Query 21) asks if an increase of density of the ether outwards from bodies will not account for gravitation, every body endeavouring to go from the denser parts of the medium towards the rarer; and if such increase of density may not, even at great distances, be effective, provided the elastic force of the medium be sufficiently great.

I do not think a tensile ether is contemplated in this theory of gravitation. Prof. Worthington's effect manifests itself only in a tensile liquid, and this constitutes its suggestiveness in connection with the hypothesis of a tensile ether. I have no such definite ideas to advance as are put forward in the "Opticks."  
J. JOY.

Trinity College, Dublin.

**The Feigning of Death.**

THE curious condition of apparent death, assumed by the English grass snake, which Mr. G. E. Hadow describes (NATURE, December 6, p. 127), is one that I have frequently observed, but have always been puzzled to account for. I hardly think that it has anything to do with simulation, or that it is voluntary, since I have seen snakes so affected when quite undisturbed in their cases. I have also observed precisely the same state in the common Italian snake. In my experience the condition only occurs in fairly hot weather, and when the snake has not fed for some time. This seems to point to a species of fainting fit, and I imagine that it is immediately induced by a disturbance of the cerebral circulation.

R. HARRY VINCENT.

Leytonstone, December 30, 1894.

**Peculiarities of Psychological Research.**

IN reply to Prof. Pearson: (1) His remark about "scientific acumen" was not made *à propos* of M. Richet's experiments, but of those of the S.P.R.; and hardly any stress is laid on M. Richet's results, either by Mr. Gurney or Mr. Podmore. Mr. Gurney, on the contrary, expressly says: "Clearly no definite conclusion could be based on such figures." But if Prof. Pearson has made experiments which are equally striking in the opposite sense, I wish he would publish them, or communicate them to the S.P.R. (2) There was nothing in my letter to indicate that I under-estimated the importance of "abnormal distributions"; but I asked Prof. Pearson to say whether he

hal any reason to suppose such distributions might have occurred in the case in dispute. This he has failed to do—he has evaded the point. 3) Prof. Pearson descends to vague generalities except in regard to Dr. Oliver Lodge, who may be left to defend himself.

With the last paragraph of the letter, however, I heartily concur. There is nothing the S.P.R. would welcome more than intelligent and independent criticism. Only the critic would have to study the evidence first, and the Professor apparently has the "scientific acumen" to see that by doing so he would cut his own throat; for he would, *ipso facto*, become a physical researcher!

HOWARD T. DIXON.  
Cambridge, December 20, 1894.

ON THE AGE OF THE EARTH.

IT has been thought advisable to publish the following documents. On October 12 I put my views before Prof. Fitzgerald and Dr. Larmor. The first paper is a copy of my letter to Dr. Larmor. It has now been edited a little, as originally it was rather hurriedly written. Some long mathematical notes, added on November 1, to prove the legitimacy of my approximate method of calculation, are now omitted, as Mr. Heaviside has given exact solutions, and has found that there is practically no difference between mine and the exact numerical answers. That Mr. Heaviside should have been able, in his letters to me during eleven days, to work out so many problems, all seemingly beyond the highest mathematical analysis, is surely a triumph for his new methods of working. Only for Prof. Fitzgerald's encouragement and sympathy, it is very probable that this document would never have been published.

I have sometimes been asked by friends interested in geology to criticise Lord Kelvin's calculation of the probable age of the earth. I have usually said that it is hopeless to expect that Lord Kelvin should have made an error in calculation. Besides, in every class in mathematical physics in the whole world since 1802 the problem has been put before students, and, as the subject is of enormous interest, if there had been any error it certainly would have been discovered before now.

I dislike very much to consider any quantitative problem set by a geologist. In nearly every case the conditions given are much too vague for the matter to be in any sense satisfactory, and a geologist does not seem to mind a few millions of years in matters relating to time. Therefore I never till about three weeks ago seriously considered the problem of the cooling of the earth except as a mere mathematical problem, as to which definite conditions were given. But the best authorities in geology and palæontology are satisfied with evidences in their sciences of a much greater age than the one hundred million years stated by Lord Kelvin; and if they are right, there must be something wrong in Lord Kelvin's conditions. On the other hand, his calculation is just now being used to discredit the direct evidence of geologists and biologists, and it is on this account that I have considered it my duty to question Lord Kelvin's conditions.

The original object of Lord Kelvin's investigation is usually forgotten. He sought to prove, and proved, that the earth is losing energy at a calculable rate. He said that the loss might be the loss of potential or chemical energy instead of sensible heat, or, as well as heat, although he thought that a large proportion of potential or chemical energy was improbable; and it is only on the assumption that the earth is a cooling body losing energy originally only of the sensible heat form, that his calculation of the age of the earth is based. Not only so, but also his earth is a homogeneous mass of rock such as we have on the surface, with the same conductivity and other heat properties. He starts with the

knowledge that there is an average increase of temperature downwards in the earth of one Fahrenheit degree for every 50 feet. Assuming that the earth, a solid, was once at the uniform temperature of 7000 F., that its surface was suddenly brought to and kept at the temperature 0, and taking  $k$ ,  $c$ ,  $\rho$  being conductivity and  $\rho$  capacity for heat of unit volume, (in year foot units) as 400, he finds that 10<sup>7</sup> years have sufficed to cause the temperature gradient at the surface to be what it is now. He stated that the conditions were sufficiently represented by an infinite uniform mass of matter at 7000 F. with an infinite plane face kept at 0.

At first I preferred to consider a *globe* of 4000 miles radius of constant surface-emissivity to be cooling as if in an enclosure, kept at constant temperature. I made the emissivity infinite, and obtained Lord Kelvin's answer for temperature-gradient near the surface. When the emissivity is taken of a finite value, the time taken to produce the present temperature-gradient is less than Lord Kelvin's answer.

It is interesting to notice that if we take our enclosure to be at a zero of temperature which we can choose as we please, we have a method of using Fourier's expression in certain cases in which the emissivity is not constant. By no method of working does it seem probable that we shall greatly alter Lord Kelvin's answer.

Modification of Lord Kelvin's Conditions.

But, when we depart from homogeneity, when we assume that the interior of the earth may be of better conducting material than the surface rock in which the temperature-gradient is alone measured, we find a very different state of things from that considered by Lord Kelvin. The cooling from a constant temperature of an infinite mass bounded by a cold plane face, a slice of which near the surface is of material different from the rest of the infinite block, is a problem difficult to attack mathematically. But if the slice is thin, or if much time has elapsed, the following artifice leads to a solution.

Imagine an infinite homogeneous block, originally at temperature  $V_1$ , whose surface is kept at 0. If  $x_1$  is sufficiently small and  $t$  great, we may neglect the exponential term, and  $\theta$  being temperature and  $t$  time, and  $x$  the distance from the cold face)

$$\frac{d\theta}{dx} \text{ at } x_1 = V_1 \div \sqrt{\pi k_1 t}; \quad \theta_1 \text{ at } x_1 = V_1 x_1 \div \sqrt{\pi k_1 t}.$$

Rate of flow of heat across unit area at  $x_1 = k_1 V_1 \div \sqrt{\pi k_1 t}$ . I take  $k$  as conductivity, and  $\kappa$  as conductivity divided by capacity for heat of unit volume.

Now take another such homogeneous infinite block of different material, and use the letters with affix 2 instead of 1. Let the time be the same in both. Let the surface slice from  $x_1$  to 0 in the first, and from  $x_2$  to 0 in the second be considered. We can, by taking proper values of  $V_1$  and  $V_2$  and  $x_1$  and  $x_2$ , make the rates of flow of heat equal and the temperatures equal at  $x_1$  and  $x_2$ :

$$V_1 \sqrt{k_1} = V_2 \sqrt{k_2} \text{ and } V_1 x_1 \sqrt{k_1} = V_2 x_2 \sqrt{k_2}$$

Hence  $k_1 \div x_1 = k_2 \div x_2$ . Thus if  $n k_2 = k_1$ , we take  $n x_2 = x_1$ .

Now we can take the slice  $x_2$  to 0 from the second block and let it take the place of the slice  $x_1$  to 0 on the first block. The artificial block so produced will go on cooling, its outside face being kept at 0. But we shall have at the point of junction a sudden multiplication of  $d\theta/dx$ . In fact,  $d\theta/dx$  will be what it used to be towards the interior, but will be  $n$  times as great towards the surface. It is of no consequence what the value of  $k_2$  is, if times are great and slices thin, the only important thing is that  $k_1$  shall be  $n$  times  $k_2$ . The application of the result is obvious:

Let the interior of the earth be a uniform sphere, uniformly heated to 7000 F. Take its  $\kappa$  as  $m$  times what Lord Kelvin took it, then an increase of temperature downwards from the surface of 1 F. degree for every 50  $n$  feet would be produced in  $10^8 m^2 n$  years. Take its  $k$  as  $n$  times what Lord Kelvin takes. Now if we imagine a skin removed and replaced by one of  $1/n$ th of the thickness and  $1/n$ th of the conductivity, that is, take it of Lord Kelvin's conductivity of rock, the surface slope will be 1 in 50, what it is now, and Lord Kelvin's time will be increased in the proportion  $n^2 m$ .

Considering the great differences in conductivity of such bodies as we know, it is quite conceivable in our knowledge and ignorance of the interior of the earth that  $n^2 m$  may be considerable even now, and probably was very considerable in past times. Roughly we may say that Lord Kelvin's age of the earth,  $10^8$  years, ought to be multiplied by two to six times the ratio of the internal conductivity to the conductivity of the skin.

I am not in a position to criticise the arguments from tide phenomena which Lord Kelvin or Mr. Darwin would now put forward on the subject of much internal fluidity of the earth. The argument from precession has been given up. Of course much internal fluidity would practically mean infinite conductivity for our purpose. But there is no doubt of a certain amount of fluidity inside even now, and taking it that the inside of the earth is a honeycomb mass of great rigidity, partly solid and partly fluid, we have reason to believe in very much greater quasi-conductivity inside than of true conductivity in the surface rocks, and if there is even only ten times the conductivity inside, it would practically mean that Lord Kelvin's age of the earth must be multiplied by 56.<sup>1</sup>

If we imagine the earth perfectly conducting inside with a thin covering, say 60 miles thick, of rock, such as we know it on the surface, we must leave Lord Kelvin's infinite mass and study the sphere. Indeed, if we take it that we have now an infinite mass at 7000 F. of infinite conductivity, cooling through rock of from 60 to 70 miles thick with a constant gradient of 1 for every 50 feet, we can imagine that this state of things has existed for an infinite time, and any original distribution of temperature in the rock would settle down to such a state.

Taking, then, an internal sphere of infinite conductivity<sup>2</sup> and working in C.G.S. Centigrade units, its specific heat 0.2, and the conductivity of the rock 0.002, I find that if at the beginning of time there was an increase of 1 Centigrade in 45 feet, and now there is an increase of 1 Centigrade degree in 90 feet, the lapse of time is 28,950 million years, or 290 times Lord Kelvin's age, and the core has cooled from 8000 to 4000 degrees. Or, again, in the last  $10^8$  years the gradient has only diminished by 1/400th of its present value, and the core has only changed from 4010 to 4000 degrees.

I do not know that this speculation is worth much, except to illustrate in another way the augmented answer when we have higher conductivity inside. It would evidently lengthen the time if I assumed that the temperature-gradient was not uniform in the shell, but the exact mathematical calculation is so troublesome that I have not attempted it.<sup>3</sup>

JOHN PERRY.

31 Brunswick Square, London, W.C., October 14.

<sup>1</sup> Observe that, even if we assume that there is the same conductivity inside and outside, inasmuch as the density is greater,  $c$  is greater, say 3 times as great, and even without the assistance of increased conductivity inside, we have 3 times Lord Kelvin's age. I admit that all such speculation as to the value of  $c$  is too vague to be of much importance.

<sup>2</sup> If  $\theta_0$  and  $\theta$  were the internal temperatures at the times  $t_0$  and  $t$ , if  $k$  is the thickness of the crust and  $R$  the radius of the internal sphere, if  $s$  is its specific heat and  $\rho$  its density and  $\kappa$  its conductivity,

$$t - t_0 = \frac{R \rho s \rho \log \frac{\theta_0}{\theta}}{3k}$$

<sup>3</sup> If 0.56 be taken as the conductivity of rock, the times are only a third of what I have given.

In connection with this matter I notice that in Lord Kelvin's very short paper, entitled "The Doctrine of Uniformity in Geology" briefly

October 22, 1894.

The reasoning in my paper was applied either to infinite blocks of cooling material or to a sphere with an internal core which has infinite conductivity. At the time of writing I did not see my way to the consideration of a sphere with a core of finite conductivity and a shell of rock as a covering, but the case is really easy to work when the shell is only a few miles in thickness, as will be seen below.

PROBLEM.—A sphere of radius  $R = 6.38 \times 10^8$  centim. of conductivity  $k = 0.47$  (or 79 times that of surface-rock) and  $k'c = 0.16464$  (or 14 times that of surface-rock), has upon it a shell of rock of thickness  $4 \times 10^5$  centim. (about  $2\frac{1}{2}$  miles). The whole mass was once at a temperature  $V = 4000^\circ$  C., and suddenly the outside of the shell was put to  $0^\circ$  C. and kept at that. Find the time of cooling until the temperature-gradient in the shell has become 1 Centigrade degree in 27.43 centim. (or 1 F. in 50 feet).

Now, if we are allowed to assume that the shell very rapidly acquired and retained a uniform temperature-gradient throughout its thickness, and it is easy to show that this assumption is allowable (or if not, then the discrepancy is in favour of a greater age for the earth), the problem is exactly the same as this:—The above-mentioned sphere has no shell of rock round it, but emits heat to an enclosure of  $0^\circ$  C., the constant emissivity of its surface<sup>1</sup> being  $E = 1.475 \times 10^{-8}$ ; find the time in which the surface-temperature  $v'$  becomes  $146^\circ$  C.

This problem is solved by Fourier, who gives for the temperature at the distance  $r$  from the centre

$$v = \frac{2VER}{k} \sum \frac{\sin er R}{er R} e^{-k'et} e^{R^2}$$

where in the successive terms the values of  $e$  to be taken are the successive roots of the equation

$$e_1 \tan e = 1 - ERk$$

In the present case  $ERk = 20$ , and  $e_1, e_2, e_3, \&c.$ , are nearly  $\pi, 2\pi, 3\pi, \&c.$  I have, however, taken the actual values of  $e_1$  and  $e_2$ —two exponential terms, only, being of importance, and I find that, if  $t = 96 \times 10^8$  years,

$$v' = \frac{1.427}{1st \ term} + \frac{5.05}{2nd \ term} = 148.4;$$

so that the age of cooling to the present temperature-gradient is more than  $96 \times 10^8$  years.

Refuted," read before the Royal Society of Edinburgh in 1865, he finds:—"But the heat which we know, by observation, to be now conducted out of the Earth yearly is so great that if this action had been going on with any approach to uniformity for 20,000 million years, the amount of heat lost out of the Earth would have been about as much as would have, by 100 Cent., a quantity of ordinary surface-rock 100 times the Earth's bulk." (The italics are mine.) In his address on "Geological Dynamics," Part II., published in 1865 (p. 127, vol. II. "Popular Lectures and Addresses"), he calculates the total amount of energy which may once have been possessed by the Earth mass, partly gravitational and partly chemical, as being about 750 times as much heat as would raise the temperature of an equal mass of surface-rock from  $0^\circ$  to  $100^\circ$  Cent. (The italics are mine.) I do not think that these two statements have ever before been put in juxtaposition. Comparing them, we may say that, according to Lord Kelvin's own figures, if the present action had been going on with any approach to uniformity for  $10^8$  years the amount of heat lost by the Earth would have been the 1/5000th part of the whole energy which the whole Earth may once have possessed, or 1/2500th part of what Lord Kelvin gives as an estimate, an over-estimate he calls it (but he says that it is not possible to make one much less vague), of the whole amount of heat at present in the Earth. I mention this because some mathematical physicists believe that Lord Kelvin based his age of the Earth upon a calculation of this total loss. He only used it in opposition to the extreme doctrine of uniformity for the past 20,000 million years (a doctrine which is not now believed in by any geologist), but it lends no support to his calculated age of the Earth.

All through this paper I give  $10^8$  years as Lord Kelvin's age of the Earth. His own words (*Trans. R.S. Edin.*, 1860 (j)) are:—"We must, therefore, allow very wide limits in such an estimate as I have attempted to make: but I think we may with much probability say that the conclusion cannot have taken place less than 20,000,000 years ago, or we should have more underground heat than we actually have [he means a more rapid increase of temperature downwards], nor more than 400,000,000 years ago, or we should not have so much as the least observed underground increment of temperature." Taking the average diffusivity for heat of the Edinburgh experiments, he finds ( $v'$ ) that the present temperature-gradient of 1 Fahr. degree for every 50 feet gives a life of  $10^8$  years.

<sup>1</sup> Because if  $v'$  is the surface-temperature of the sphere and  $\theta$  the thickness of the shell of rock,  $v'/\theta$  is the surface-gradient in the shell and multiplied by conductivity of rock is equal to  $E$ .

If we take  $k$  as 1.5 times that of the surface-rock, and  $\rho$  as 35 times that of the surface-rock, and if the shell has a depth of  $3.272 \times 10^6$  centimetres, about 20 miles, the time of cooling until the temperature-gradient is 1 Cent. degree in 2743 centim. is *more* than  $127 \times 10^7$  years.

I kept no copy of the letter which I sent to Prof. Tait with the foregoing document. In it I explained my difficulty in getting Lord Kelvin to reconsider the internal heat question, and I asked for his advice.

*Excerpt from Letter of P. G. Tait, November 22, 1894.*

... my entire failure to catch the drift of your paper. For I seem to gather that you don't object to Lord Kelvin's mathematics. Why, then, brag in mathematics at all, since it is absolutely obvious that the better conductor the interior in comparison with the skin, the longer ago must it have been when the whole was at 7000° F., the state of the skin being as at present?

I don't suppose Lord Kelvin would care to be troubled with a demonstration of this.

As to the validity, or more properly the *plausibility* of his or your assumptions, I don't suppose anyone will ever be in a position to judge. He took the simple and apparently possible case of uniform conductivity all through—having no data whatever. What if he had assumed, as he was quite entitled to do, that the conductivity diminishes *inversely* with rise of temperature?

But I need not say any more, as I seem to have entirely mis-understood your point.

*Letter to Prof. Tait, November 26, 1894.*

DEAR PROF. TAIT,—I should have been on the whole better satisfied if you had opposed my conclusions. You say I am right, and you ask my object. Surely Lord Kelvin's case is lost, as soon as one shows that there are *possible* conditions as to the internal state of the earth which will give many times the age which is your and his limit. . . . What troubles me is that I cannot see one bit that you have reason on your side, and yet I have been so accustomed to look up to you and Lord Kelvin, that I think I must be more or less of an idiot to doubt when you and he were so "cocksure." The argument from the sun's heat seems to me quite weak. Even a geologist without mathematics can see that the time given by Lord Kelvin will be increased if we assume that in past times the sun radiated energy at a smaller rate than at present, much of its mass being possibly solid and in the meteor form, and the rate may have greatly varied from time to time. This is not only possible but probable, and it is for you and Lord Kelvin to prove a negative.

Then the Tidal Retardation argument! Even if your rate of retardation is correct, the real basis of your calculation is your assumption that a solid earth cannot alter its shape (diminishing rise of potential by a few miles) even in 1000 million years, under the action of forces constantly tending to alter its shape, and yet we see the gradual closing up of passages in a mine, and

the contraction of a sphere into any shape. (A) A sphere of radius  $R$  of uniform density  $\rho$  and specific heat  $c$  is surrounded by a shell of rock of thickness  $t$  and specific capacity for heat per unit volume  $k$ . Take  $T_0$  as the initial temperature at the surface of the sphere.

$$T = R(t, \rho, c, k, T_0)$$

$$\text{If } T = 2743 \text{ centim. } \quad \text{then } \frac{R}{t} = \frac{2743}{2 \times 10^6} = \frac{1}{730} \text{ centim.} \\ \text{If } T = 2743 \text{ centim. } \quad \text{then } \frac{R}{t} = \frac{2743}{2 \times 10^6} = \frac{1}{730} \text{ centim.}$$

(B) The earth is a sphere of radius  $R$  and uniform density  $\rho$  and specific heat  $c$ . It is surrounded by a shell of rock of thickness  $t$  and specific capacity for heat per unit volume  $k$ . Take  $T_0$  as the initial temperature at the surface of the sphere.

Let  $T$  be the temperature at the surface of the sphere after a time  $t$ . Then  $T = R(t, \rho, c, k, T_0)$ . The time  $t$  is the age of the earth.

Let  $T$  be the temperature at the surface of the sphere after a time  $t$ . Then  $T = R(t, \rho, c, k, T_0)$ . The time  $t$  is the age of the earth.

Let  $T$  be the temperature at the surface of the sphere after a time  $t$ . Then  $T = R(t, \rho, c, k, T_0)$ . The time  $t$  is the age of the earth.

we know that wrinkling and faults and other changes of shape are always going on in the solid earth under the action of long-continued forces. I know that solid rock is not like cobbler's wax, but  $10^8$  years is a very long time, and the forces are great!

I had thought these two arguments to be mere supporters of the internal heat one which I took to be the only important one, like a diamond whose pure sparkle was brought into relief by two rubies.

If I were alone in my opinion, I should still have the courage, I think, to write as I do; but as I have already told you, I did not venture to write and speak to Lord Kelvin, or write to you until I found that so many of my friends agreed with me—Fitzgerald, O. Keynolds, Larmor, Henrici, Lodge, Heaviside, and many others. Fitzgerald is the only man to whom I have mentioned my notion about the sun's heat, but he quite agrees with me. I have not put before him my notion about the Tidal Retardation argument. . . .

November 27.

DEAR PROF. PERKY.—I should like to have your answers to the questions:—

(1) What grounds have you for supposing the inner materials of the earth to be better conductors than the skin?

(2) Do you fancy that any of the *advanced* geologists would thank you for  $10^{10}$  years instead of  $10^8$ ? Their least demand is for  $10^{10}$ —for *part* of the mere secondary period!

Yours truly,

P. G. TAIT.

November 29, 1894.

DEAR PROF. TAIT,—It is for Lord Kelvin to prove that there is *not* greater conductivity inside. Nevertheless I will state my grounds:—

(A) In page 6 of the paper sent you I say "I am not in a position to criticise the argument from tide phenomena which Lord Kelvin or Mr. Darwin would now put forward on the subject of much internal fluidity of the earth." The argument from precession has been given up. Of course, much internal fluidity would practically mean infinite conductivity for our purpose. But there is no doubt of a certain amount of fluidity inside, even now, and taking it that the inside of the earth is a honeycomb mass of great rigidity, partly solid and partly fluid, we have reason to believe in very much greater quasi-conductivity inside than of true conductivity in the surface rocks.

(B) Even if we assume perfect solidity, and even neglecting our knowledge of much iron—surely there can be no doubt of the conductivity of rock *increasing* with the temperature. From the analogies with electric conduction, one would say, without any experimenting, that as a metal diminishes in conductivity with increase of temperature, so a salt, a mixture of salts, a rock, may be expected to increase in conductivity with increase of temperature. I presume that Everett's hook is recognised now as giving the most exact information on these subjects. He nowhere suggests that rock diminishes in conductivity with temperature. Every case he gives shows an increase. I have made out the following table from the only quotations which Everett gives from Dr. Robert Weber; only five cases, but probably representative.

Percentage increase for a rise of 100° Centigrade.

	In conductivity	In specific heat.
Micaeous gneiss	48.0	23.6
Mica schist	136.1	24.4
Limite	185.0	35.7
Gneiss	21.4	61.5
Micaeous schist	94.5	35.4
Average	43.1	36.1
Average, leaving out Limite	75	36

Even if the conductivity and specific heat did not alter, inasmuch as the internal density is greater, the volumetric capacity is greater; and if it is three times as great, we have three times Lord Kelvin's age. In fact, the rule given at page 4 of my paper is the same as this.—If the conductivity inside is



$n$  times the conductivity outside; if the specific heat inside is  $s$  times the specific heat outside; if the density inside is  $d$  times the density outside; then Kelvin's age of the earth is increased  $n s d$  times. . . It is not likely that Dr. Weber's rate of increase would be constant to such a temperature as 4000 C.; but the electric analogue allows us to imagine a greater and greater rate of increase at higher temperatures; therefore it is in Lord Kelvin's interest to take Weber's rate. Now at 4000 C. the conductivity would be [leaving out *eurite*, which seems abnormal and too much in my favour], thirty times as great as it is at the surface; the specific heat would be  $14\frac{1}{2}$  times as great, and taking the density as three times, we have, even for a perfectly solid earth an age 1300 times the age given by Lord Kelvin.

2. In answer to your second question, Lord Kelvin completely destroyed the uniformitarian geologists, and not one now exists. It was an excellent thing to do. They are as extinct as the dodo or the great auk.

I have met many advanced geologists, and not one of them demands more than 1,000,000,000 years. Probably Sir Archibald Geikie is the most representative of the geologists who have studied this question, and he never (in recent years) seems to have desired even as much as 1,000,000,000 years. (See his address as President of the British Association.) The biologists have no independent scale of time: they go by geological time. According to Huxley, less than 1,000,000,000 years is enough as the age of life on the earth.

But surely the real question now is not so much what the geologists care about, as—Had Lord Kelvin a right to fix  $10^8$  years, or even  $4 \times 10^8$  years, as the greatest possible age of the earth?

Yours truly,  
JOHN PERRY.

December 6, 1894.

DEAR PROF. TAIT.—Prof. Fitzgerald has pointed out to me that the five rocks given by Everett are not to be found in his 1891 edition. I quoted from his 1886 edition. I therefore wrote to Everett, asking why he had left them out—was there a mistake? He writes to say: "I copied Weber's data from a copy of his paper which was, and may be still, in my possession, having been sent me through the post, probably by the author, or possibly by Dr. Stapf, the geologist of the St. Gothard Tunnel, with whom I had much correspondence in underground temperature. You seem to assume, in writing to Tait, that I picked out samples of Weber's results; but my recollection is that I gave everything without reservation.

"I did not reproduce his results in the 1891 edition, and I cannot remember all my reasons for dropping them. On comparing them with other people's, which I give, they appear to be much too small. There is such a mass of conduction results in my book, that I was on the look-out for something that might be omitted.

"I have just referred to the foreign translations of my book. The German edition, published in 1888, gives only a page of conductivities of solids, and includes among them one of R. Weber's, namely Glimmerschiefer '000733 + '000010  $t$ . The Russian edition, brought out by editors who took tremendous pains in verifying and correcting references, gives my list of Weber's results exactly as it stands in my book, the sign of the temperature coefficient being positive in every case. I do not know of any direct evidence as to the variation of rock conductivity with temperature except R. Weber's, but there is something approaching to direct evidence in the comparison of George Forbes' results with Herschel and Dunn's (see my 1891 edition, pp. 126, 129). Forbes found at  $-10^\circ$  C. the conductivity of white marble to be '00115, black marble '00177. Dunn and Herschel found at the temperature of hot water, marbles, &c., '0047 to '0056 (see Forbes' remark, quoted at p. 129).

"You have built a very lofty edifice on the basis of Weber's results, and extrapolation is proverbially a risky process, but I consider you have established a strong presumption in favour of the increase of rock conductivity with temperature."

I did not know, when writing to you on November 26, that the Rev. M. H. Close, M.A., had (R. Dublin Soc., Feb. 1878) put forward in great detail the reasons which I gave you shortly, against the tidal retardation argument. I thought they were my own. I notice that this gentleman assumes that increased conductivity inside would help Lord Kelvin, and indeed I cannot help thinking that, without mathematics, almost any

body would be of the same opinion—in spite of what you say in your first letter. I know that Lord Kelvin himself did not seem to think me right when—after I had sent him the documents—I talked to him at Cambridge.

I remain, yours truly,  
JOHN PERRY.

Copy of a Letter from Lord Kelvin.

The University, Glasgow, December 13, 1894.

DEAR PERRY,—Many thanks for sending me the printed copy of your letter to Larmor and the other papers, which I found waiting my arrival here on Saturday evening. I have been much interested in them and in the whole question that you raise, as to the effect of greater conductivity and greater thermal capacity in the interior. Your  $n^2 \div m$  theorem is clearly right, and not limited to the case of the upper stratum being infinitely thin. Twenty or thirty kilometres may be as good as infinitely thin for our purposes. But your solution on the supposition of an upper stratum of constant thickness, having smaller conductivity and smaller thermal capacity than the strata below it, is very far from being applicable to the true case in which the qualities depend on the temperature. This is a subject for mathematical investigation which is exceedingly interesting in itself, quite irrespectively of its application to the natural problem of underground heat.

For the natural problem, we must try and find how far Robert Weber's results can be accepted as trustworthy, and I have written to Everett to ask him if he can send me the separate copy of Weber's paper, which it seems was sent to him some time before 1886; but in any case it will be worth while to make farther experiments on the subject, and I see quite a simple way, which I think I must try, to find what deviation from uniformity of conductivity there is in slate, or granite, or marble between ordinary temperatures and a red heat.

For all we know at present, however, I feel that we cannot assume as in any way probable the enormous differences of conductivity and thermal capacity at different depths which you take for your calculations. If you look at Section 11 of "Secular Cooling" ("Math. and Phys. Papers," vol. iii. p. 300), you will see that I refer to the question of thermal conductivities and specific heats at high temperatures. I thought my range from 20 millions to 400 millions was probably wide enough, but it is quite possible that I should have put the superior limit a good deal higher, perhaps 4000 instead of 400.

The subject is intensely interesting; in fact, I would rather know the date of the *Consistentia Statu* than of the Norman Conquest; but it can bring no comfort in respect to demand for time in Palaeontological Geology. Helmholtz, Newcomb, and another, are inexorable in refusing sunlight for more than a score or a very few scores of million years of past time (see "Popular Lectures and Addresses," vol. i. p. 397).

So far as underground heat alone is concerned you are quite right that my estimate was 100 millions, and please remark ("P. L. and A.," vol. ii. p. 87) that that is all Geikie wants; but I should be exceedingly frightened to meet him now with only 20 million in my mouth.

And, lastly, don't despise secular diminution of the earth's moment of momentum. The thing is too obvious to every one who understands dynamics.

Yours always truly,  
KELVIN.

JUPITER.

JUPITER being now near opposition, and having an apparent diameter of 47'.7, is displayed as a very brilliant object in the heavens, and his northerly declination of 23 degrees enables him to remain above the horizon for a period of 16½ hours.

During the few ensuing months, the observation of his belts and spots will enlist a large amount of attention, for there is probably no other planetary object which exhibits a more diversified and variable aspect. One feature of the present observations will be important as enabling comparisons to be made as to the rates of motion of the various white and dark spots in this and preceding oppositions. No doubt many of the surface

markings now existing are identical with those observed some years ago. From 1878 to 1882 the prominent apparition of the red spot incited observers to fully investigate the phenomena of the different formations, and they were found to be very discordant in their rates or velocity. The red spot and equatorial white spots were evidently subject to a marked retardation, causing their rotation periods to increase with the time.

As to the red spot, the slackening rate of motion it exhibited in the earlier years of its presentation, appears not to have been maintained since 1880, for Mr. Marth's adopted period of 9h. 55m. 40.03s. equivalent to a daily rate of 270.27' has correctly represented its mean motion during the last eight years. There have been, it is true, some marked deviations from the mean rate, for in the years from 1880 to 1880 the motion became accelerated and corresponded to a rotation period of about 9h. 55m. 40.2s., but in the three following years it slackened again, and since 1891 the period has been about 9h. 55m. 41.5s.

At the present epoch the spot is extremely feeble in its visible outlines, but on a really good night its elliptical form can be distinctly traced, and it does not appear to have materially changed either in its shape or dimensions since 1870. Its following end is decidedly the plainest, and its southern borders have lately been conjoined with a grey belt in about latitude 30° south. The commingling of the spot and belt has been noticed here on previous occasions, and it is certain that on its southern side the spot exerts very little of the repellent influence so often ascribed to it. On the contrary, the belts on the equatorial side of the spot always run clear, and abruptly bend north to allow of a clear white interval between the spot and belt. The S. border of the spot and S. belt were apparently in touch early in the past autumn, for Mr. Barnard, observing the red spot with the 36-inch refractor of the Lick Observatory, says: "The belt south of it seems to be in contact, if it does not actually overlap it slightly." The same thing was noticed as long ago as October 31, 1865, by the aid of the 16-inch refractor of the Goodsell Observatory, Minnesota, when the observers wrote "the great red spot was seen by us, and the colour was exactly the same as that of the belt just to the south of it, and the two objects merged into one another without the slightest change in intensity of colour."

The spot now arrives at mid-transit two or three minutes after Mr. Marth's zero meridian, as the following observations made here will indicate:

Date	Mid transit of spot	Follows Marth's zero meridian	Long. of spot
	h. m.	h. m.	°
Nov. 25	10 50	4 2	29
26	9 40	1 2	07
27	10 33	3 5	21

It is well known that the perception of a delicate planetary marking depends in a very great measure on the quality of the definition. On an indifferer night the red spot is practically invisible, but with steady air and a sharp image the familiar reddish ellipse, now representing that object, shows up distinctly in the remarkable concavity of the great southern equatorial belt. The latter configuration away after an excellent guide to the position of the spot, but its appearance is not symmetrical, the following side of it being much more strongly developed than the side preceding the spot.

The impending disappearance of the latter has been suggested by several observers, from its loss of tone during the last few years, but there seems to be no tangible reason to suppose that we are on the point of losing this truly singular object. It is indeed utterly impossible to predicate anything definite as to its future history. The facts gleaned during past observation are not of a character to guide us to any reliable conclusion. Its present faintness may be but the prelude to a more

marked manifestation, for variation of tint is certainly one of its leading peculiarities. It is doubtless the same object as the the ellipse seen by Gledhill and Mayer in 1869 and 1870, and quite possibly the same formation was figured by Dawes in 1857 and in subsequent years. At any rate the resemblance of the objects is eminently suggestive, and altogether too striking to be disregarded.

About fifteen years ago the equatorial zone of Jupiter exhibited phenomena proving it to be in a state of considerable activity. There were white and dark spots, wisps of dark material, veins of bright matter, and other irregularities all in condition of rapid change, and imparting a very broken and variegated aspect to the northern side of the great southern equatorial belt. To-day the indications are essentially different. The light tint of the equator seems pretty even, and exhibits few noticeable irregularities. Precisely on the equator there is a dark belt like a narrow pencil line, but it is not now continuous right round the disc. The chief seat of energy appears to have been transferred to the northern side of the great northern equatorial belt.

Dark spots (some of them almost black, like satellite shadows) and white patches, with other details of structure, are plentifully arrayed in the northern equatorial belt. The white spots I observed here in 1885 and 1886, and they have persistently maintained themselves ever since. Their rotation period in 1880 was about eight

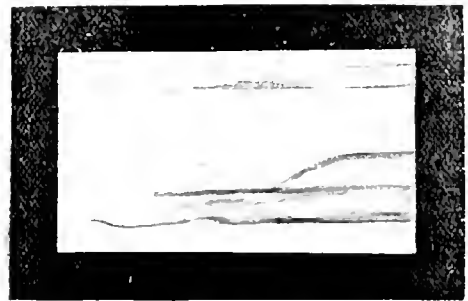

Fig. 1. November 25, 1894, 10-inch refractor, power 250. Region of Red Spot.

seconds less than that of the red spot, but in 1890-91 I found it only 2.0 seconds less. At present the period is still a little less, and there are a number of black spots in the same latitude, and subject to the same drift. One of the most conspicuous of the black spots precedes the red spot about 3h. 20m., and one of the chief white spots precedes the red about 2h. I have secured the following observations of this pair of objects:—

Date	Black spot.		White spot.		
	Mid transit h. m.	Long. °	Mid transit h. m.	Long. °	
Nov. 5	10 57	230.1	Nov. 23	10 0	303.4
15	9 10	238.2	18.4		
17	10 47	237.6	Nov. 5	12 16	286.9
29	10 39	237.7	15	10 31	287.2
Dec. 4	9 42	235.1	25	8 45	287.0
18	11 14	236.5	Dec. 10	8 24	284.2

The northern temperate belt on which in 1880 and 1891 in many rapidly moving black spots appeared, is now in close contiguity with the great northern belt, and blends with it in certain places. A few years ago the two belts were separated by a bright zone.

There is a narrow spotted belt in about latitude 35° north. In 1892 and on subsequent occasions I noticed this belt beaded with numerous dark spots, but I have not made a sufficient number of observations to determine the rotation period. This belt forms a delicate object; it is very narrow, and the spots extremely small. In bad air

it is quite obliterated. Only a few observers appear to have noticed this northerly belt and its beaded aspect, but it has been an interesting feature of the planet during the last two years.

In the southern hemisphere and further south than the red spot, there are some dark condensations and white spots, with a rotation period of about 9h. 55m. 20s.

The S. region of the great N. belt exhibits interruptions in the form of very bright streams of material dividing the belt in an oblique direction relatively to the equator. These appearances show rapid changes from day to day, and I have not yet computed the rotation period satisfactorily, but it is obviously very different to that of the red spot. Five observations of these luminous encroachments on the belt have been secured here, as follow :—

		Mid transit.		Long.
		h.	m.	
November	8	11	0	332° 0
	15	12	31	359° 7
	29	9	47	266° 1
December	4	8	1	174° 1
	19	9	33	325° 8

It is intended to make a closer study of the variable aspect and rate of velocity of these singular formations.

We may depend upon it, from the number of interesting markings displayed on the planet, that there will be no abatement of useful observations during the present apparition. There is always something new to record, and objects previously known require attentive watching with reference to the differences in their rotation periods. Whether the theorem that the longer an object remains visible the slower becomes its velocity is true or not, cannot be definitely said, but the behaviour of the red spot has not altogether supported the idea. A vast amount of new evidence is required as to the phenomena affecting the surface markings of Jupiter; he presents an ample field both for the observer and the theorist.

W. F. DENNING.

NOTES.

SCIENCE is represented in the list of New Year honours by Mr. W. H. White, C.B., F.R.S., the Director of Naval Construction, who has been promoted to a Knight Commandership of the Bath. Two other Fellows of the Royal Society, Dr. J. Russell Reynolds, President of the Royal College of Physicians, and Dr. Eric Erichsen, formerly President of the Royal College of Surgeons, have each had the honour of a Baronetcy conferred upon them.

THE cross of Commander of the Order of the Ernestine House of Saxony, second class, has been conferred upon Dr. Edward S. Holden, Director of the Lick Observatory, for his services to science. This Order was founded in 1690, reorganised in 1833, and is conferred upon persons holding high official positions, either military or civil. At present there are eighteen Commanders of this class in Germany.

THE fund for the proposed statue to the late Dr. Charcot will probably soon be closed; as it is announced that thirty-five thousand francs have been collected, and this is sufficient to warrant the ordering of the statue. In all probability, a statue will be erected to Helmholtz, for it is reported that, at the recent celebration in Berlin, the German Emperor offered to head a subscription list for that purpose with a donation of ten thousand marks.

THE Paris Chemical Society has (says the *Chemist and Druggist*) recently come into possession of a legacy from M. Rigout, formerly of the École des Mines, who bequeathed to

the Society an income of twelve hundred francs per annum, of which a portion is to be set aside for an annual prize to be awarded in connection with inorganic chemistry. M. Rigout declines to allow his name to be attached to this legacy, but asks to have it named the Edouard Rivot prize, in memory of his former Professor. It is worthy of mention that a short time ago M. Silva, late Professor at the School of Arts and Manufactures, left his library and modest fortune to the same Society "out of gratitude for the kindness met with in the French scientific world."

THE death is announced of M. Frederik Johnstrup, Professor of Mineralogy in Copenhagen University, at seventy years of age.

DR. F. KOHLRAUSCH, Professor of Physics in Strassburg University, has been appointed Director of the Imperial Physico-Technical Institute at Berlin, in succession to Helmholtz.

INCREASED facilities for instructing in the science and art of agriculture are gradually being given to the Technical Education Committees in various parts of the country. We are glad to see it announced that Earl Cowper, chairman of the Herefordshire County Council, has offered to place a farm of nearly 300 acres, with residence and buildings, at the disposal of the Council, rent free, for the purpose of providing practical instruction in agriculture, on condition that the County Council stock the farm and work it. Lord Cowper has also undertaken to erect a laboratory and the necessary dormitories. A sub-committee of practical agriculturists has been appointed to consider his lordship's offer and report to the Council upon it.

A NEW society has just been formed in Paris for the purpose of subterranean exploration, to be called "La Société de Spélagologie." Its projector is M. E. A. Martel, whose works, "Les Alimes" and "Les Cévennes," may be familiar to some readers of NATURE. In his papers read before the French Association for the Advancement of Science at Besançon in 1893, M. Martel warmly set forth the claims of underground investigation, and the light that might thereby be thrown upon geology, palæontology, and kindred subjects. Indeed, as readers of the works just mentioned are aware, very interesting discoveries have already been made, notably that of the underground rivers of Bramabiau (Gard) and of Palirac (Lot). Among those who have joined the Société de Spélagologie are several well-known men of science. All information is to be obtained of M. Martel, 8 rue Ménars, Paris.

THE idea of holding International Mathematical Congresses is crystallising into shape. Prof. Vassilief, of Kazan, has suggested an assembly of mathematicians in 1896, in order to definitely decide the organisation of such congresses. The matter was pushed a little further at the Vienna meeting of the Deutsche Mathematiker Vereinigung, in September last, when it was unanimously resolved that the committee of the Mathematical Union should take part in framing the necessary arrangements; and the Mathematical section of the French Association for the Advancement of Science have also expressed their support of the scheme. A circular now informs us that the Editors of the *Interim Share* will be glad to receive the names of mathematicians who are in favour of international meetings of the kind suggested. M. C. A. Laisant's address is 162 Avenue Victor-Hugo, Paris; and that of M. E. Lemoine, 5 rue Littré.

THE *Johns Hopkins University Circular* states that it is proposed to collect the physiological papers and addresses of Prof. Martin, and publish them as one of the memoirs of the Biological Laboratory of the Johns Hopkins University. This plan has been adopted in response to suggestions from a number

of his former pupils, that the long and valuable services of Prof. Martin to the University, and his brilliant contributions to American physiology and biology, should be commemorated by a memorial of some kind. After consultation with a number of his friends, it has been decided that the most appropriate form of memorial will be the publication in a handsome volume of his scientific papers and addresses. It is hoped to raise a fund among his friends sufficiently large to meet the cost of an edition of about 300 copies. One copy will be sent to each person or institution subscribing ten dollars, and, if desired, an extra copy for every additional ten dollars subscribed. As the work will be placed at once in the hands of the printer, it is requested that subscriptions be sent promptly to Prof. W. H. Howell, Johns Hopkins University, Baltimore.

THESE are often hidden meanings in the humorous answers given by schoolboys in the examination room. From a collection of such answers in the *University Correspondent*, we cull a few authenticated specimens. "Parallel straight lines," said one boy, "are those which meet at the far end of infinity." And another sagely remarked that "Things which are impossible are equal to one another." The boy who wrote "A point is that which will not appear any bigger, even if you get a magnifying glass," would have no difficulty in understanding that a star, being but a lucid point, cannot be magnified. A very examiner is familiar with the non-committal answers frequently received, and with which may be classified the cautious statement that "Two straight lines cannot enclose a space, unless they are crooked." But even these words of wisdom are eclipsed by the definitions of kinetic and of potential energy once received. "Kinetic energy," ran the definitions, "is the power of doing work. Potential energy is the power of doing without work." This truth, which has a monetary application, is well worth adding to our contemporary's collection.

A SWARM of bees in December is remarkable enough to be set on record. According to a Long Sutton (Lincolnshire) correspondent of the *Daily Telegraph*, a few days ago there was a swarm of bees on a farm at Spalding, Sutton Crosses.

THESE are the present age is not very favourable to the development of pure science, applied science flourishes like a green bay tree. An instance of this growth is afforded by a note from the Institution of Civil Engineers, with reference to the present incorporation. The Institution, which was established in January 1818 and incorporated by Royal Charter in June 1878, for the general advancement of Mechanical Science, now consists of a society of 690 members.

IMMEDIATELY following the recent very high barometric pressure, which reached 30.53 inches on the west coast of Ireland on December 27, a large disturbance advanced over the northern parts of our islands from the Atlantic, and during the night of the 28th, destructive gales from W. and N.W. were experienced over the whole country, accompanied by snow, thunder, and lightning. In some districts the storms lasted for several days, and were followed by sharp frosts, generally. At Greenwich a wind pressure of 28 lb. on the square foot was registered on Saturday morning, this pressure being one pound less than in the severe storm of the previous week.

In *Natio germanicorum. W. H. H. H. H.* for December 9, Dr. C. Hess discusses the hailstorms of Switzerland for the years 1883-1893, on the basis of the observations regularly published by the Meteorological Office at Zurich. He finds that hail is more frequent in the valleys than on the mountains, the latter at times transforming the hail into sleet or rain.

Near marshes, and in the valleys of the lakes, hail occurs more frequently than over wooded country, while the river valleys which lie in the direction of the paths of the thunderstorms favour the formation of hail. On passing over a cultivated district or a hilly forest, there is, however, a tendency to a decrease in the intensity, and, at times, an entire cessation of the hailstorms.

THE prize offered by the Hon. Ralph Abercromby for the best essay on "Southerly Bursters" (*NATURE*, vol. xlviii. p. 77) has been awarded by the Royal Society, N.S.W., to H. A. Hunt, of the Sydney Observatory, and the paper has been published in vol. xxviii. of the *Journal* of the Society. The essay, which extends to forty-seven large octavo pages, and is illustrated by four photographic plates, contains a short note on "bursters" in New South Wales and other colonies, and gives tabular statements of all that have taken place at Sydney between September 1863 and March 1894. These storms occur very suddenly, and mostly between November and February; a fresh north-easterly wind may change in ten minutes to a gale from the south, doing much damage to vessels that may be unprepared. The storms are always accompanied or preceded with great electrical excitement, and cause a considerable drop in the temperature. The wind velocity used to reach from 60 to 80 miles an hour, and on one occasion attained the rate of over 150 miles in the hour, in a gust. Latterly, however, the wind seldom exceeds 50 miles, and generally ranges between 20 and 40 miles an hour. This result possibly arises either from obstruction to atmospheric disturbance by increased number of buildings, or from less absorption or radiation of heat, owing to greater cultivation of the land. The average annual number of storms is thirty-two. The investigation is the result of much patient research, facilitated by reference to unpublished documents to which access was allowed by the Government Astronomer of the Sydney Observatory.

WE are informed that one of the points in the Report of the Upsala meeting of the International Meteorological Committee, contributed by Mr. Lawrence Kotch to the *American Meteorological Journal*, and reprinted in *NATURE* of December 20, is misleading. It was stated that "a proposition of the Russian Admiral Makaroff, on the necessity of an international convention to arrange for the discussion of the data contained in ships' logs, was not approved." This is erroneous, for we understand that Admiral Makaroff did not ask the Committee to express an opinion upon his scheme, so the subject was not discussed at all.

THE significant name "*Pithecanthropus erectus*" is proposed by Dr. Eug. Dubois, of the Netherlands-Indies Army Service, for some fossil remains recently discovered in the andesitic tufts of Java, as indicating the former existence in that island of an intermediate form between man and the anthropoid apes. The bones, which consist of the upper part of a skull, a very perfect femur, and an upper molar tooth, are elaborately described and figured in a quarto memoir recently published at Batavia.

THE announcement that the Surinam water toads, recently received by the Zoological Society, have commenced to show the curious phenomena of their reproduction, in the Reptile House, has created much interest amongst zoologists. There can be no doubt that one of these living specimens now carries a layer of ova placed in cells in the skin of its back, and that about eighteen days after the deposition of the ova, young tadpoles were visible in some of the cells. Thus the extraordinary facts recorded by Madame Merian, concerning the reproduction of this abnormal Batrachian in the latter part of the last century, and not, we believe, subsequently noticed, have been already partially verified.

DR. ANTON REICHENOW, of the Royal Zoological Museum of Berlin, has just completed a memoir on the birds of German East Africa, which will form a portion of the third volume of Stuhlmann's work, "Mit Emin Pascha in's Herz von Afrika." The memoir gives an account of 728 species of birds which have been recorded up to the present time, by German naturalists and other explorers, as met with within the limits of the German Protectorate. The remaining portions of the same volume, which are in progress under the editorship of Dr. Mobius, will complete the account of the vertebrates. The fourth volume, under the same editorship, will be devoted to the invertebrates, and the fifth, edited by Dr. Engler, to the botany of the German East-African Protectorate. Vol. vi. will give an account of the geography and meteorology, and vol. vii. of the geology and mineralogy of the same country. It may be asked how long we shall have to wait for a similarly complete account of British East Africa?

THE "Zoological Record" for 1893, which has just been published by Messrs. Gurney and Jackson, for the Zoological Society of London, has appeared rather later than usual. Its bulk shows us at once that the quantity of work accomplished by zoologists in 1893 is not inferior in amount to that of the immediately preceding years. Some of the recorders, we may be allowed to point out to Dr. Sharp, commence their "Records" with an interesting account of the principal events that have taken place in their special branches of the subject during the year of record. Others altogether neglect this very desirable piece of information. It would be well to insist that a page or two of introduction, containing matter of this description, for the general information of zoologists, should be prefaced to every section of the "Record." Many readers who do not care to study the special portion, would like to get a general notion of what has been going on.

AN exhaustive bacteriological investigation of the Altona water-supply has been recently published by Dr. Reinsch. Although the results obtained are not specially novel, yet they are of importance as confirming the researches of other investigators. It is pointed out that whilst the layer of slime which forms on the surface of sand-filters plays an important part in the retention of microbes, yet another factor must be most carefully watched if a satisfactory filtrate is to be obtained. This factor is the depth of the column of fine sand through which the water is made to pass. It was first called attention to by Dr. Percy Frankland in 1886, in the course of his examinations of the London water supply; and since that time investigations made at Zurich and elsewhere, have shown that it is not advisable to reduce the layer of sand below 30 c.m. Reinsch states that it should never be less than from 40-60 c.m. high. This investigator also states that to encourage the formation of surface-slime, the filters, after the water is first run on, should be left undisturbed for twelve hours, and that the neglect of this simple precaution exercised an important influence on the filtrate.

SOME vexed points in the developmental history of medusæ have been attacked in a masterly manner by Miss (?) Ida H. Hyde, who publishes a paper on this subject in the *Zeitschrift f. wiss. Zoologie* (Bd. lviii. iv.). The material for her investigations consisted of embryos of three different species of *Aurelia* and *Cyanea*. The formation of the endoderm is shown to vary considerably in different species and even in the same species. In *A. marginalis* the endoderm is formed by multipolar delamination, in *C. arctica* by delamination at the pole of the blastopore. In *A. flavidula* the endoderm sometimes arises by embolic gastrulation, with or without the participation of a few immigrant or delaminated cells, but in other cases arises almost

exclusively from immigrant and delaminated cells, the invaginated element being relatively insignificant. These differences of origin in the same species seem to be determined by local conditions of temperature and salinity of the water. The author regards multipolar delamination as the most primitive of the various processes by which the endodermal digestive chamber is brought about. The development of the *Scyphula* larva is then traced, and the author is able to confirm Goette's account in all essential points. There is a true stomodæum, and the invaginated ectoderm also takes part in the formation of the four septa and of the gastral filaments of the *Scyphostoma*. The points of affinity which have been raised between the Scyphomedusæ and the Anthozoa thus acquire new and substantial support from Miss (?) Hyde's researches.

A NEW periodical, *Archiv für Entwicklungsmechanik der Organismen* (Leipzig: Engelmann), of which the first number lies before us, is intended by the editor, Dr. W. Roux, to provide a medium for the publication of researches upon the causes of the phenomena of organic development, as distinct from the mere normal order of the phenomena themselves. The journal is to furnish an organ for that branch of biology which has been variously termed the "mechanics of development" and "causal or experimental morphology." In the hands of Roux, Driesch, Hertwig, Chabry, Wilson, and others, the methods of this school, which are above all things experimental, have been applied to various problems in development with much success and with the most interesting results. It is therefore to be hoped that the publication of a journal specially devoted to experimental morphology will lead to a considerable increase in the number of investigations in this promising field. In the present number the editor gives an introduction on the objects, methods, and scope of the branch of biology the new *Archiv* represents, and a number of interesting researches are published on the "cytotropism" of isolated blastomeres, on compensatory hypertrophy of organs and regeneration, and on the origin of the forms of joints.

THE young cocoa-trees in one part of the island of Jamaica are suffering from the attacks of a caterpillar. A correspondent calls our attention to a letter in the *Jamaica Gleaner*, in which Mr. W. Fawcett, the Director of Public Gardens and Plantations, regrets that the museum is at present without the services of a curator, who might be able to give some information as to the best means of dealing with the caterpillars, and the remedy he suggests for keeping down the plague is by hand-picking. In this connection, a summary of a report on a plague of caterpillars at Hong Kong, in the current *Kew Bulletin*, is of interest. These caterpillars appeared on pine-trees, and belonged to a large moth (*Metanastria punctata*, Walker). The trees attacked were those of *Pinus sinensis*, Lamb, very largely planted in the island for re-forestry purposes. Active steps were taken by the Government to destroy the pests, by establishing stations where the caterpillars could be received and paid for by weight. The caterpillars were caught by shaking the trees and picking them off the ground. From the report summarised in the *Kew Bulletin*, it appears that the plague lasted two months. The quantity of caterpillars collected weighed nearly thirty-six tons, and a large number of cocoons were also destroyed. Altogether it is estimated that thirty-five million insects were destroyed. Mr. W. J. Tatcher, who drew up the report, says that the methods employed for the extirpation of the scourge were decidedly successful; so that if similar measures are promptly taken at Jamaica, the caterpillars may be kept under.

IN measuring the volume of a solid by immersion in a liquid, it is usual, after withdrawing the solid, to find what volume of liquid is required to re-establish the former level. The well-

known difficulty of identifying the former level is overcome by Sgr. Guglielmo in a manner described in the current *Atti dei Lincei*. He grinds the edges of a beaker, and mounts inside it a pointer of glass or platinum so that its fine point lies just in the plane of the edge. This is accomplished while the mounting-cement is still soft, by inverting the beaker on a plane surface, and thus pressing the point into its place. A burette with an india-rubber tube enables the observer to add or withdraw a known volume of water. In order to measure the volume of a solid, the plane horizontal edge of the beaker is lightly spread with grease or paraffin, and the beaker is filled up until the unevenness in the liquid surface produced by the pointer has just disappeared. A volume of water larger than the solid is then withdrawn, and the latter is immersed. The liquid is then brought up to the point again, and the difference of level in the burette is the volume required. The reflection of the bar of a window or other straight line in the liquid is useful for discovering any deformation of the surface. If the pointer should not be easily wetted, a few drops of soap solution are recommended, or the substitution of petroleum for water.

THE comparison of condensers of small capacity and the measurement of the specific inductive capacity of liquids is of considerable importance. An interesting paper on this subject was read by Prof. Nernst, of Göttingen, before the German Electro-Chemical Society see also *Zeitschrift für Physikalische Chemie*, vol. xiv, p. 622), in which he describes a method for measuring the specific inductive capacity and specific resistance of liquids. The author uses a modification of De Santy's method, in which a telephone is used in place of a galvanometer, alternating currents supplied by a small induction coil being used. The resistances employed in the bridge must necessarily be non-inductive, and also, since the capacities to be compared are very small, of practically evanescent electrostatic capacity. Hence the author uses liquid resistances contained in fine capillary tubes, the electrode at one end consisting of a fine platinum wire, which can be moved along the bore of the tube by means of a micrometer screw, and thus the resistance of the liquid column be varied at pleasure. An air condenser is used as a standard with which to compare the condenser containing the liquid under observation, and when this liquid is not a perfect insulator the telephone cannot be brought to complete silence by altering the resistances. To overcome this difficulty the author places a high resistance shunt on the air condenser, which is adjusted so that complete silence is obtained.

A SYSTEM of two pendulums joined by an elastic thread has been studied by M. Lucien de la Rive, and the results of his experiments are given in the *Journal de Physique*. The masses and the length of the two pendulums were equal, and the elastic threads consisted of pure vulcanised caoutchouc, long enough to make the amount of stretching small in comparison with their length. It was found that there was a periodical transmission of energy from one pendulum to another. On starting one pendulum, and arranging the thread so that it always remained stretched, the other pendulum started swinging with increasing amplitude, until the first was for an instant reduced to rest. After that the second pendulum was gradually reduced to its minimum, which did not, however, attain zero, while the other reached its maximum. This transmission of energy exhibited a fixed period, which could be derived from the ordinary period of each pendulum by multiplying with a number proportional to the length, and inversely proportional to the sectional area of the thread. In the end, the pendulums tend to oscillate like a rigid system, with a constant tension of thread. After ten or twelve oscillations,

the alternation of periods is hardly perceptible. When one pendulum only was attached to a fixed point by an elastic thread, the decrement was observed in order to determine the internal friction of the thread. This internal friction gives rise to an elevation of temperature which has been exhibited by Warburg, who placed india-rubber tubes round glass tubes containing sounding columns of air, and observed the rise of temperature in the caoutchouc. It shows an analogy to that in wires due to electric currents.

ON October 27, as we have recorded in a previous number (p. 18), a disastrous earthquake occurred in Argentina. The exact time is as yet unknown, and it is therefore uncertain whether any connection exists between this earthquake and a remarkable series of pulsations that were registered on the same day in several European observatories. At Rome, a very slight and comparatively rapid movement of the great seismograph (length, 10m., mass, 200 kg.) commenced at 9h. 7m. 35s., p.m. (Greenwich mean time). This lasted until 9h. 40m., when the slow pulsations began to be visible. The first maximum occurred at 9h. 49m. 50s., and the principal one at 9h. 55m. 40s. The amplitude then rapidly diminished, with occasional maxima, the disturbance lasting until about 11 p.m. Pulsations were also recorded at about the same time at the geodynamic observatories of Siena, Ischia, Pavia, and Rocca di Papa. The period of the complete oscillations at the time of their maximum amplitude was found to be 16.7 seconds at Rome, and about 18 seconds at Siena and Rocca di Papa. In the south of Russia, at Charkow and Nicolaiew, horizontal pendulums were strongly disturbed. At the former place, the movement began at 9h. 8m. 36s., p.m., and, for more than an hour, was so great that all traces of the photographic curve disappeared. The large oscillations lasted until 11h. 9m. 48s., and the small ones until 9h. 10m. 54s. a.m. of the following day. At Nicolaiew, the disturbance was first perceptible at 9h. 12m. 6s., p.m., and the curve disappeared almost completely between 9h. 24m. 6s. and 10h. 2m. 6s., the pendulum continuing in oscillation until 9h. 37m. 6s., a.m. of the next day. The magnetographs at Utrecht and Wilhelmshaven also showed traces of the pulsations, at the former place beginning at 9h. 45m. 28s., and reaching a maximum at 9h. 56m. 28s., at the latter beginning at 9h. 55m. 25s. and ending at 10h. 11m. 55s. No disturbances are perceptible on the magnetograms at Lisbon, Perpignan, Paris, Kew, Greenwich, Stonyhurst, Vienna, and St. Petersburg (*Bull. Meteor.*, Suppl. 112).

THE last issue of *Studies from the Yale Psychological Laboratory* contains an interesting record of Dr. Gilbert's researches on the mental and physical development of school-children between the ages of six and seventeen years. On the physical side, statistics are given of increase in (a) weight, (b) height, and (c) lung-capacity. On the psychological side, there are observations on the development of the power of perception and discrimination as exercised upon (a) weights poised in the hand, (b) colour-differences in a series of shades of red, and (c) time-intervals. To these are added observations on the "force of suggestion," in which, by means of a series of loaded blocks (1) of different sizes but the same weight, and (2) of different sizes and different weights (the two being novise correlated), it is shown that visual perception of size very markedly affects weight-discriminations. Reaction time, with and without discrimination and choice, was tested; and observations were made on the influence of fatigue on "voluntary motor ability" as measured by the rapidity of tapping with the key of a specially devised piece of apparatus. In all cases the results, both for boys and girls, are summarised in curves on the graphic method. One of the interesting features to be noticed in these curves is the influence of puberty on mental development, there being a

marked depression in the curves at the age of from thirteen to fourteen years. Another noteworthy piece of work, recorded in the same number, is that by Dr. Scripture and Mr. H. F. Smith, which deals with the highest audible tones. The general result is that the pitch of the highest note varies directly and almost proportionally with the intensity. It is also shown that the limit of audibility is much higher when reached by descent from more rapid inaudible vibrations, *i.e.* proceeding from silence to sound, than it is when reached by ascending from less rapid audible vibrations, *i.e.* proceeding from sound to silence.

THE ninth part of "The Natural History of Plants"—the English edition of Prof. Kerner's admirable "Pflanzenleben"—has been published by Messrs. Blackie and Son.

MESSRS. A. AND C. BLACK have published the third part of "A Dictionary of Birds," by Prof. Alfred Newton, F.R.S. The part extends from "Moa" to "Sheathbill." We propose to review the complete work when the fourth (and last) part has been issued.

"WEBSTER'S PRACTICAL FORESTRY," published by Messrs. Rider and Son, has reached a second edition. We reviewed the work when it first appeared (NATURE, vol. xlix. p. 526), and it is only necessary to add to the remarks then made that the author has enlarged the volume, thus increasing its value as a practical and popular handbook on the rearing and growth of trees.

THE second volume of Mr. Boulenger's "Catalogue of the Snakes in the British Museum," which has just been issued, concludes the account of the Aglyphodont Colubrine Snakes, and gives descriptions of 427 species, which are represented in the collection by 2528 specimens. We understand that the MS. of the third and concluding volume of this important work is nearly ready for press.

THE December number of the *Journal* of the Royal Microscopical Society has just been received. It contains a paper by Mr. F. Chapman, on the Foraminifera of the Gault of Folkestone (part vii.), and a description of a simple method of measuring the refractive indices of mounting and immersion media, by Mr. E. M. Nelson. The invaluable summary of current researches in zoology, botany, microscopy, &c., takes up the chief part of the journal.

WE note the commencement of vol. xxx. of the meteorological publications of the Manila Observatory. The *Bulletin* for the year 1894 is in a large quarto form, which is much more convenient in size than its predecessors. In addition to a good summary of the weather over the Philippine Islands, the work contains hourly observations for Manila, and observations taken twice daily at a number of secondary stations, together with rainfall and other maps.

MESSRS. WHITAKER AND CO. will issue the first number of a new science weekly on January 5. The new journal will embody the combined features of *The Technical World* and *Science and Art*, two periodicals which have hitherto appeared as separate organs. It will appeal to all persons interested in the progress of art, science, and technology from an educational point of view. In addition to current news, the journal will contain articles in all the departments of pure and applied science and art.

A FINE geological map of Alabama, drawn on a scale of an inch to ten miles, has been prepared and issued by the Geological Survey of that State. The map is accompanied by a very useful explanatory chart, showing, in four parallel columns, (1) the names, synonyms, classification, and common fossils of the formations; (2) the thickness, lithological and topographical

characters, area and distribution; (3) useful products; (4) soils, characteristic timber growth, agricultural features. By means of this chart and the coloured map, the geological record of Alabama can be read by any one.

WE have received from Dr. A. von Banchelman, an excerpt paper from vol. vii. of "Mittheilungen aus den deutschen Schutzgebieten," containing some valuable meteorological observations made by Dr. Steinbach, during the year 1893, at Jaluit, an island in the North Pacific. The station is situated in 5° 55' N. lat. and 169° 40' E. long., and is only five feet above mean sea-level. A Richard barograph was sent out by the Deutsche Seewarte in 1892, but the vessel was wrecked on approaching the island; another was supplied, and records were commenced on January 1 last. The observations for 1893 show that the air temperature is exceedingly uniform, the yearly range only amounting to 22°; the absolute maximum was 92°·8 in November, and 70°·7 in September. Cloud is very prevalent, there only being six clear days during the whole year. Rain falls almost daily, there being 343 wet days during 1893, the total fall being 182 inches; the greatest fall in twenty-four hours was 4·5 inches. Thunder-storms are not very frequent; there were only thirty-two in the year in question, but it is noteworthy that the majority occur in the forenoon, to an extent which has, we believe, not been observed at any other station.

THE additions to the Zoological Society's Gardens during the past week include a Bonnet Monkey (*Macaca sinitica*) from India, presented by Mr. J. Hassey; two Red-eared Bulbuls (*Pycnonotus java*) from India, presented by Brigade-Surgeon Lieut.-Colonel E. F. Drake Brockman; a Cape Bucephalus (*Bucephalus capensis*), a Rhomb-marked Snake (*Psemmophylax rhombata*) from South Africa, presented by Mr. J. E. Matcham.

#### OUR ASTRONOMICAL COLUMN.

A NEW SHORT PERIOD VARIABLE.—The possible variability of  $\delta$  Serpentis was suggested some time ago by the Potsdam photometric work, and the variation has now been confirmed by Mr. Vendell (*Astronomical Journal*, No. 3310). Fifty observations made by him between August 5 and November 4 of last year indicate a variation from magnitude 5·0 to 5·7 in a period of not far from 8·7 days. The form of the light-curve appears to resemble that of  $\beta$  Lyrae, though this is not yet certainly established. There appear to be two maxima, one at 2·2 days, and the other at 6·2 days from the principal minimum, while there is a secondary minimum of about magnitude 5·5 at 4·3 days from principal minimum. Mr. Vendell suggests the provisional elements

1894, August 7·6 (G.M.T.) + Sd. 7 E.

The new variable is chiefly of interest in the probable resemblance of its light-curve to that of  $\beta$  Lyrae. Notwithstanding the very detailed investigations of the spectrum changes in the latter variable, which have been recently made at Harvard, Potsdam, Pulkowa, Stonyhurst, and Kensington, the cause of the variability is by no means completely understood. In this case the spectrum is a complicated one, consisting of bright lines as well as dark ones, and the Kensington photographs have shown that there are two distinct sets of the latter. According to the Draper catalogue, however, the spectrum of  $\delta$  Piscium is of the Sirius type, and no mention is made of bright lines. It may be that a complete study of the simpler spectrum of this star will throw some light on the origin of the variability in  $\beta$  Lyrae, and possibly also on the causes which produce other kinds of continuous variability in short periods.

The position of the star for 1900 is

R.A. 18h. 22m., Decl. + 0° 8'.

DELLER'S PRINCIPLE.—The verification of Deller's principle has hitherto depended upon comparisons of the spectroscopically measured velocities in the line of sight of Venus, and of the sun's limb with their known velocities, and upon the

consistency of the measured velocities of stars when due allowance is made for the varying effect of the earth's movement. Dr. H. N. Russell, however, has recently suggested a method (Proc. Roy. Soc. Lond., N. S., 1907) of demonstrating the principle by a laboratory experiment. Imagine two cylinders with axes parallel, in which are arranged vertically two sets of small mirrors, the axes of the cylinders being horizontal. The mirrors are inclined so that a ray of light falling on one is reflected to the back again of the cylinder, and so on, finally being directed to the slit of the spectroscopic. If now the cylinders be set in rapid rotation, in opposite directions, the effects of the mirrors will be to accelerate or retard the velocity of the ray of light according to the directions of movement. Figures are given which indicate that measurable displacements may be obtained by employing cylinders of from 0.25 to 0.7 m. diameter, with ten or twenty mirrors, making from eighty to twenty revolutions per second. With cylinders half a metre in diameter, making eighty revolutions per second, and having twenty mirrors, the equivalent velocity of five kilometres per second in the line of sight is obtained, and with no such instruments there would be no difficulty in observing the effects of such a movement. It is pointed out that Lalande's observations made from seventy to eighty revolutions per second, and if sufficient care be taken in the construction of the cylinders, the experiment does not seem to present any appreciable difficulties.

THE ASTRONOMICAL JOURNAL. This is the title under which the *Journal of the Royal Astronomical Society* will appear in future. The University of Chicago has purchased that journal, and arrangements have been made to carry it on under the editorship of Prof. Hale and his clerks, assisted by Profs. Ames, Campbell, Cook, Fiske, and Waiswiler, and a number of associate editors, with whom are present Germany, Great Britain, France, Italy, the States, etc. The scope of the new publication will be quite similar to that of *The Monthly Notices of the Royal Astronomical Society*, for all problems and investigations of modern physical astronomy will be dealt with. The journal will, in fact, represent the common ground of physics and astronomy, and it should therefore be more widely read by the physicist, as much as by the astronomer. Workers in theoretical physics should be gratified that their interests are progressed sufficiently to need a special organ to be devoted to their interests. *The Astronomical Journal* will be continued to be published, and will appeal to all amateurs, teachers and students of astronomy, and others interested in celestial science. As far as it will be practically the old *Monthly Notices*, and as *The Astronomical Journal* will be the realisation of Prof. Hale's original plan of a periodical for workers in the domain of the Astronomical Society.

THE BINARY STARS. A little pamphlet on elliptical orbits. Mr. H. Park has been published by Mr. Fisher Unwin, and is read and clearly student of astronomy to construct for the first time, with the apparent orbit of a binary star, we can solve the problem, it will serve one useful purpose, that of illustrating the theory of binary stars. It is to be hoped that the same author will also give the theory of formation of binary stars, as it is well known they are able to result from the explosion of a single star. There are many other strange things connected with binary stars, and which no one at all conversant with astronomy would ever have stated. Perhaps the most interesting suggestion of "peculiar equilibrium" that would be a binary star with a circular orbit. "Peculiar equilibrium" is a very old term, but the context seems to suggest that the equilibrium of a star would result from such a condition. It is interesting to see that we have realised that there is a connection between the change between an eclipse of a planet and a star, and that in the solar system there are many cases of a similar kind of existing, as so long that it is not generally considered as a possibility.

THE CLIMATE OF NATAL

NATAL is situated on the east coast of South Africa. The climate is of the temperate zone, owing to a warm current in the Indian Ocean. The climate is very dry on the coast, and the interior is a high plateau, and is very dry. The capital, Pietermaritzburg, is situated on the eastern side of the plateau.

Maritzburg—or Maritzburg, as it is usually called, at fifty miles from the coast—is at 2275 feet above sea-level, and possesses an appreciably mild climate.

The colony is bordered on the west by the Kathlamba or Drakensberg, a mountain chain attaining altitudes which exceed 9600 feet, and separating Natal from the Transvaal, the Orange Free State, and Basuto-land. These mountains form the eastern boundary of the high South African plateau, which is drained by the Orange River and its tributaries.

Natal is scantily populated, containing 18,755 square miles, with 532,000 inhabitants, of whom 38,000 only are Europeans. Most of the latter are English who came by sea and founded Port Durban, but a few are descended from the Dutch Boers who came from the west in 1838-42 and founded Maritzburg. Natal has been an English colony since 1843, when the territory only included 3000 native inhabitants, but their numbers rose rapidly to 100,000 in 1845, and to 400,000 in 1883. They are mostly Zulus in the north, and Kaffirs in the south of the colony.

Much greater progress could have been made in Natal, in trade, agriculture, and manufactures, if it had been connected by roads and railways with the Transvaal and Orange States. The Cape railway, 650 miles long, from Cape Town to Kimberley, with express trains doing the distance in thirty-six hours, has long been constructed, and in 1893 this railway was extended to the Transvaal gold mines at Johannesburg.

In 1880 a railway was constructed from Durban to Maritzburg, but only recently has it been pushed further inland, and it now reaches the confines of the colony. Its further extension to Johannesburg is most important for the future prosperity of Natal. About one and a half years ago a railway was made from Ladysmith in Natal to Harris-smith in the Orange State. Natal is at present short of funds, and this may partly explain why, having made a good start in forest conservancy, the Colonial Government has not had the resolution to persevere in it.

The Cape Colony has had for some time a good forest administration which was organised by a French forest officer, Count Vasselot de Regne, Conservator of Forests in Algiers, and Mr. D. E. Hutchins is now Chief Conservator of Forests at Cape Town. He was trained at Nancy for the Indian forest service, and left it for service at the Cape in 1883. Mr. Fomcade, of the Cape forest service, was employed in Natal for nine months in 1880, and has written a very valuable paper on the Natal forests, but he declined to quit the Cape service permanently for that of Natal, and was succeeded in 1891 as chief forest officer there by Mr. Schoplin, a Baden forest officer.

The work he undertook of organising a forest department in Natal was full of difficulty, especially as the forest revenues were not expected to cover the expenditure for a number of years. Irrespective of the continual clearance of forests for the extension of agriculture, forest fires, unregulated grazing, and wasteful timber felling have so exhausted the Natal forests that the areas still covered with brushwood and forest are widely scattered over the country, and only a small percentage of them is still State property.

From the coast to altitudes of about 975 feet, with an average annual temperature of 67-71°, the forest consists of numerous species belonging to the tropical flora. The woods are not more than 30 to 60 feet high, but something might be made of them, as several species yield valuable timber. Unfortunately nearly all the coast forests are now private property.

In a central zone ranging in altitude between 680 and 3450 feet with an average annual temperature of 59-67°F., extensive tracts are covered with so-called mimosa scrub, formed of several species of *Acacia*; these woods are very thinly stocked, and contain a tall grass undergrowth. The acacias bear plenty of seed, and young growth exists, but is continually being destroyed by the annual grass fires. If only protection could be afforded to these forests against fire, as has been done for the last thirty years in British India, they could be worked profitably with short rotations—twenty-four years, according to Mr. Fomcade; it is, however, probable that most of this area will be cleared for agriculture.

The present area of the coast and acacia forests is estimated at 100,000 acres of State forest, and 1,045,000 acres in private hands.

In the higher zone, from 3450 feet up to 9600 feet, with a temperate climate, and an average annual temperature of 52-59°, the most valuable forests are situated, but they are



scattered over a difficult mountainous region. Of these forests, the State possesses 54,000 acres, and 27,000 acres are in a territory assigned to the indigenous inhabitants of the country. The Government has decided that in the mountains the action of the Forest Department will be restricted to the State forests. They contain many species; *Podocarpus Thunbergii* and *P. elongata*, both known as yellow-wood, are the commonest, and their wood resembles that of the European spruce. At present the great cost of transport prevents the profitable working of yellow-wood. Amongst the remaining species, the two most valuable trees are stink-wood (*Ocotea bullata*), so named on account of the bad odour of freshly-sawn wood, an evergreen lauraceous species with a beautiful brown heart-wood, which is hard and tough; and sneeze-wood, *Pteroxylon utile*, an ally of the horse-chestnut. These woods are also highly esteemed in the Cape Colony, especially for cart and wagon making, and can be worked at a profit even from these remote mountain forests. Unfortunately these two species are only found here and there in the forests, and there is no large supply of them.

In the year 1891-92, the sale of wood by the Natal Forest Department yielded £725, while the expenditure was £1942, partly for establishment and partly for the survey of the forests. Owing to the small area of forests available, and the remote position of the State forests, Mr. Fourcade strongly recommended that plantations should be started near the towns and railways. Past experience with the blue gum (*Eucalyptus globulus*) is favourable for the success of this tree in Natal. At Arambi, near Ootacamund in the Nilgiri Hills in India, this tree attains a height of 107 feet in nineteen years, and yields 5600 cubic feet per acre. This enormous production of 457 cubic feet per acre annually was attained in latitude 11° N. at an altitude of 7426 feet above sea-level.

In the higher latitude of Natal, a similar climate to that of Arambi is found at 2275 feet above sea-level, and, according to Mr. Fourcade, mixtures of *Eucalyptus globulus*, *Sunguifera* and *rostrata* give an even higher yield near Maritzburg than at Arambi. Mr. Schopplin doubts whether this will be the case; but, at any rate, the gum-trees will give a large yield, and if the wood were only fit for fuel a considerable pecuniary return would be obtained. Several of the gum-trees, however, yield splendid timber, and especially *E. rostrata*, the red gum of Southern Australia.

Timber imports into Natal average in value £180,000 a year, so that, as the indigenous forests are small, much subdivided, and unfavourably situated, the State is clearly called upon to plant up a sufficient area of the State lands. Mr. Fourcade states that the land necessary for these plantations can now be purchased cheaply, and Mr. Schopplin commenced planting operations. This useful measure is now abandoned, owing to want of funds, and the plants in the State nurseries will be sold.

Besides *Eucalypti*, several Australian acacias succeed admirably in Natal, especially *A. acuminata* and *m. h. ineri*; their bark is rich in tannin, and a plantation of 1200-1500 acres of these trees has been started by a private company. Near the neighbouring Transvaal gold-fields, Australian trees are being planted on a large scale to supply mine props.

The length of rails in Natal is about 625 miles, and the mountain forests will yield a portion of the necessary railway sleepers. Yellow-wood must be kyanised, as has been done in the Cape Colony, and kyanising works can easily be established in Natal, and wood from gum-tree plantations ought to supply the balance of the sleepers required.

It is evident that Natal cannot possibly prosper without a Forest Department, and the colony will have cause to regret having abandoned the attempt to form one, after such an excellent beginning has been made. The Government wished to retain Mr. Schopplin's services up to March 31, 1894, but would not undertake to employ him after that date. Under these circumstances, he was obliged to resign his appointment last September, in order to return to the Baden Forest Service.

W. R. FISHER.

THE FERTILISATION OF "LORANTHIUS KRAUSSIANUS" AND "L. DREGEI"

THE parasite *Loranthus Kraussianus* grows on the coast here on the tree *Chaetone Meyeri*, and as three of these trees grow within a short distance of my house, I have this season had good opportunity of observing the rather curious mode of its

fertilisation. In the flower bud the corolla segments adhere along their whole length, forming an upright cylinder, of about an inch long, of red and white, thus getting the not inappropriate colonial name of "lighted candles." The flowers grow in close umbels, so close together as to give quite a reddish tinge to the host tree. After a little time five slits appear about half-way up the upright cylindrical corolla, and these slits are about one quarter the length of the cylinder. The anthers occupy almost the extreme tip of the cylinder, and are pressed against each other by the closed tube of the corolla (the cylinder aforesaid), the actual tip being occupied by the capitate stigma. If a needle be inserted into one of the slits of the corolla with a downward movement, as if to seek the nectar at the base, it causes the tube to split with some force, and at the same time the anthers are quickly and forcibly released from their pressure one against the other, and fly downwards violently, scattering practically all the pollen they contain by the one movement; and at the same time the stigma, from being upright, springs to an angle of, say, 40 degrees on one side quite clear of the now split corolla tube. I found by microscopic observations of a number of stigmas just at this stage, that only in a small proportion of cases (I only found one) did any of the triangular pollen actually reach the stigma by the act of explosion, although the style was fairly thickly peppered. These flowers are constantly being visited by large numbers of the commonest coast sunbird (*Cinnyris olivacea*), a very active and hard-working, though not very brightly coloured, member of the sunbirds. A little quiet watching will show the birds at these flowers splitting open flower after flower, and getting head and bill covered with pollen in moving about, undoubtedly fertilising the capitate receptive stigmas in the receptive stage protruding free from the corolla tube of other and older flowers. After seeing them thus at work, the question arose whether without their aid the bursting of the flower happens. The negative evidence was that although I had observed for many hours, I never saw a single flower voluntarily explode; but to check this, I put a net-bag over a small branch containing, say, 80 to 100 healthy flowers. I found that when thus protected hardly a single flower got to a further stage than having the splits on the corolla tube ready for the outside aid of the sunbird to enable them to perform the next function, viz. explosion. Actually none exploded, and, as a consequence, not a single flower within the bag set seed. They seem to be quite sterile without outside help, the anthers dehiscence, but at a level below the capitate stigma, and as the corolla tube is generally upright, the pollen is lost even as a self-fertilising agent. After careful watching, I feel sure sunbirds are the only effective agents in the fertilisation of this plant. At first I never observed bees visiting it, and actually made a note to the effect that they did not do so; but at a later date they came in good numbers. They seemed simply to follow the birds, and take any nectar left by them in the exploded flower, and very seldom, and then, I think, only by a happy chance themselves caused the explosion. I did not observe any other insect visitors, so that it would appear this plant is dependent on *Cinnyris*; and there is an element of irony in it, for from the berries of this plant the boys make bird-lime, and the energetic efforts of these lovely little birds are towards the perpetuation of the means by which they are often made captive. It would be interesting to know how far the different individuals of *L. olivacea* on the one tree are in the position of independent individuals of terrestrial species (pollen from an independent individual being necessary for the most perfect results of cross-fertilisation), or whether the fact of having a common host approximates them in this respect to the position of one plant, and whether to get the best results of cross-fertilisation pollen should be brought not from flowers of a different individual on the same host, but from plants growing on a different tree altogether. To carry on the life-history of this plant, my friend Mr. Harry Millar, of Durban, informs me that the berries when ripe are taken by the little tinker bird (*Pterbetula pusilla*), who eats the *ovarium* of the berry, and rejects the seeds and viscid matter around them, and to clear away the latter hangs the berry with his bill against a tree, where the seeds adhere with the viscid substance and germinate. I may say that Mr. Millar states that in shooting these birds, as specimens, he often finds the head and bill covered with pollen. I am informed that another sunbird *Cinnyris Teretica* visits this plant, but as it is of the same habits as *C. olivacea*, the results of its visits, as far as the plant is concerned, would be the same.

*Isotria medeolae* grows on the coastlands of Natal upon various hosts, most commonly perhaps upon the introduced *Striga*, *Mitrasacme*, and never, so far as I have observed, upon the tree *Clusia*; *M. pumila* infested by *I. medeolae*. While in the bud the petals form a cylindrical tube, and the anthers are pressed against the closed petals, the style being set below the stigma. Subsequently slits appear on the still closed cylinder. My observations show that the plant is abundantly visited by *Cyanopis* sp. and *C. verreauxi* and that both birds insert their long bills into the slit to get nectar secreted at base of tube, exactly as in *I. kranzianus*.

This species, however, instead of the anthers remaining still attached to the filaments when the flower opens, they are broken sharply off, and fly into space with great violence, starting with their pollen as they go. I find that although the pollen is blown so far upward as to reach the base of the stigma, the force appears so much abated that none actually reaches it, the great bulk of the cloud of pollen being thrown down variously to reach the head and back of the visiting bird. Apparently after this dissemination of its pollen (and anthers) the flower still has attractions for the sunbirds, for I have seen them distinctly visiting the burst flowers, and this would of course be necessary if cross-fertilisation or, indeed, fertilisation of any kind took place. And on opening the burst flowers I find in most cases a quantity of nectar, so that probably there is no reason why the flower is open and its anthers gone. I observe this plant repeatedly and at all hours of the day, and never saw it visited by a single insect of any kind; and although aware of the ready evidence of this kind cannot be relied upon, my observations were so frequent that I feel sure any insect visiting the plant as a casual visitor, must be exceedingly rare. I once saw a fly coming upon *I. medeolae* sp. which was also in flower, and several bees, but the bees took not the slightest notice of the flowers of the *I. medeolae*. I should judge from the length of the corolla tube, that if any insect visits this plant, it must be furnished with a long proboscis, for the flower tube from stigma to base is fully two inches long. As in *I. kranzianus* the flowers need outside aid to burst at all, for I have watched them for long periods and in all kinds of weather, and never saw a single flower burst by its own volition. Although apparently entirely dependent on the sunbirds for its propagation, this mode of fertilisation must be very successful, for the plant is very common indeed. In addition to the fact of the flying pollen never reaching the stigma, and self-fertilisation being prevented, the flower seems to be proterandrous, for at a stage of development when a slight touch in the right place causes the flower, the stigma seemed dry and unresponsive. After bursting, the stigma, instead of being in line with the corolla tube, came to one side, though not to such an extreme angle as in *I. kranzianus*, and this deviation from the upright will be of great value to some extent. I have often watched the birds as they were bursting them, and each time causing quite a shower of pollen and anthers to fly, and the force is so great that the pollen is carried to quite a considerable distance. I have seen the force of the force fail to detach the whole flower, and a very pretty and interesting sight. In the present case, however, I believe it is absolutely dependent on the sunbirds for its propagation.

THE GEOLOGICAL SURVEY.  
 In the first united Parliament of Upper and Lower Canada, in 1841, the Natural History Society of Montreal and the Historical Society of Quebec joined in urging the establishment of a Geological Survey upon the Government, with the result that the modest sum of £1,500 sterling was granted for the purpose of beginning such a survey.  
 Mr. Logan, afterwards so well known as Sir William Logan, was the first geologist appointed. He entered upon his duties, in 1843, with the greatest possible zeal, and for more than twenty-five years the history of the Survey and that of its director were the same.  
 The field work of the Geological Survey necessarily began with exploratory trips in which the main features to be dealt with, in a country almost entirely unknown geologically, were ascertained. In many parts, even of the older provinces, such explorations are still requisite, but in most of these provinces it became possible after a time to proceed with the more systematic mapping of definite areas, the map-sheets produced forming parts of a connected whole. When the great western regions were added to the field, these could only be attacked by extended exploratory journeys in which geology and geography went hand in hand. As it is now, the field work of the Survey may be divided under three classes: (1) Reconnaissance surveys; (2) the approximate mapping of large areas on a small scale; (3) finished map-sheets on a larger scale, and forming continuous series. All these three classes of work are in progress concurrently in different districts, while the auxiliary chemical, paleontological, and lithological investigations in the office are kept in touch with the field work, and render it possible to bring this together in a homogeneous form. Were there in existence any complete topographical maps of Canada, approaching in accuracy to those which have been made in older countries, much more geological work could be accomplished with a given amount of money and in a given time, and thus the construction of such maps must be stated yet to be, as it has been from the beginning of the Survey, one of the principal desiderata. There is, however, one other matter which at the present moment must be regarded as even more urgent, and one which might be attained within a short time and at a relatively small cost. This is the construction of a suitable and safe museum building for the preservation and display of the important collection which has grown up as the result of so many years of investigation. The collection is not merely a matter of record, closely connected with all the publications of the Survey, but it is fitted to become also a great educational medium in regard to the mineral resources of the country. With proper accommodation its utility could be vastly increased for all purposes.

MAURICE S. JAMES.

THE GEOLOGICAL SURVEY IN CANADA.

It is a curious fact, and one as far as possible representative of the general condition of literature and of science, it appears that the Geological Survey of the President for the time being holds the position of a man who has the privilege to deliver, to one of the most important and interesting of such matters of the day, and one which is particularly in his own line of activity, the history of the country, and political development of the country. I have never dealt with. It may be said that the history of the country to give a very general and very brief history of what has been accomplished, and what remains to be accomplished, and by various scientific methods, and in the investigation of the natural features, and the development of the natural resources, of the country.

It is a curious fact, and one as far as possible representative of the general condition of literature and of science, it appears that the Geological Survey of the President for the time being holds the position of a man who has the privilege to deliver, to one of the most important and interesting of such matters of the day, and one which is particularly in his own line of activity, the history of the country, and political development of the country. I have never dealt with. It may be said that the history of the country to give a very general and very brief history of what has been accomplished, and what remains to be accomplished, and by various scientific methods, and in the investigation of the natural features, and the development of the natural resources, of the country.

Nothing can be adduced which is more creditable to the system of government in Canada, than the quietly persistent and uninterrupted support accorded to the Geological Survey by every political party; but it remains to provide such a museum building and centre for the work as that referred to, and it may be confidently asserted that nothing would be more favourably received by the general public. This museum should be of a national character, and there is every reason to hope that when it is undertaken, its plan will include provision for all the valuable collections which have been or may be made by the several Government departments, so that it may form in effect a representation of the sources, the history and the various lines of activity of the whole country.

#### METEOROLOGICAL SERVICE AND MAGNETIC OBSERVATORY.

Although the first scientific branch of the Government service established by Canada, it must be noted that several years previous to its inception the Magnetic Observatory had been founded at Toronto. It was established as the result of representations made by the British Association at its meeting in Newcastle in 1838, acting in conjunction with the Royal Society of England, and as a part of a system of magnetic research on sea and in the colonial possessions of Great Britain. The observations were actually begun in 1839. Meteorological observations had been made concurrently with those relating to magnetism, from the time of the establishment of the observatory; but it was not until 1871 that the Canadian Government first made a grant of 5000 dollars for a meteorological service.

In 1876, the issue of daily weather forecasts and storm warnings was begun, and since that time these have become so much a part of the every-day life of the country, that it is unnecessary to enter into any explanation of their character, or to present any plea in their favour. They are equally important and necessary to the farmer as to the navigator, and are, in addition, of value in a hundred other ways.

There are at the present time over four hundred stations in Canada reporting to the central office, of which twenty-nine make daily telegraphic reports, useful primarily in affording data for the weather forecasts. The meteorological service thus developed naturally from the Magnetic Observatory, and both have become merged in a common organisation, the growth of the meteorological work now perhaps overshadowing the original magnetic purpose of the observatory in its immediate interest, though the importance of the magnetic observations has never been lost sight of.

Respecting magnetic charts of the Dominion, much also remains to be done, for though scattered observations of precision have been made, particularly in the west, no systematic attempt at a magnetic survey has been undertaken since that accomplished in an extended journey through the northern parts of the country in 1842 and 1843, by Sir J. H. Lefroy. It is well to remember that the magnetic pole itself is situated within the limits of Canada, and that problems of the greatest importance, both from a purely scientific and from a practical point of view, call for solution by a systematic study of its secular movement, as well as of any changes in intensity and dip by which this may be accompanied. These are all strictly domestic problems, and they should not be left for solution to enterprise from abroad.

#### EXPERIMENTAL FARMS.

This branch of the public service was established as the result of the recommendation of a select committee of the House of Commons appointed in 1884 to inquire into the best means of encouraging and developing the agricultural resources of Canada. The "Experimental Farm System Act" was passed in 1886, and the organisation of the work began in the same year.

It is thus only about eight years since the initial steps in this new scientific enterprise of the Government were taken, but in that time, thanks to the energy and ability of the director and staff of the farms, great progress has been made, and the way has been opened in many directions for still further usefulness. Besides the central farm at Ottawa, which was first undertaken, branch farms have been established for the maritime provinces, Manitoba and the north-west territories, and British Columbia.

If any line can be drawn between that which may be described as strictly practical and that which may be called purely scientific work, it will be found to run through the centre of the field of operations of the experimental farms. An

inspection of the reports already published will show that the work consists largely of submitting actual observations in the field to scientific tests, and in the application in turn of the best results of scientific knowledge to matters of every-day importance on every farm throughout the land.

The following are among the many lines of work undertaken in this service:—

One is the origination of new crosses or hybrids of cereals, fruits, and other useful plants to meet the requirements of the varied climates and conditions of different parts of Canada.

Other branches of the work involving much original research are: the investigation, by chemical analysis, of soils, in their relation to fertilisers, and of grains, grasses, fodder plants and other products of the farm, by which a fundamental knowledge of their respective value and of the best and most profitable methods of their treatment may be arrived at, and the study of insects and parasitic plants injurious or beneficial to vegetation and to stock, such as to enable the pests of the agriculturist to be combated either by methods which may be classed as direct, or by means which are indirect. The latter implies a study of the life-history of the forms to be dealt with, including not only those which are native to the country, but those also which may be from time to time introduced, such as the Colorado potato beetle, the horn fly, and many others. It includes also the study of the best means of counteracting the attacks by all those lower forms of vegetation, known as rust, smut, mould or mildew, that prey upon the plants which are the special care of the farmer.

Even in connection with the familiar and almost world-old operations of butter and cheese making, the results of purely scientific investigations are now being proved to have a great importance. The best mechanical methods of dealing with the milk from which these are made, are not here referred to, but the fact that the nature of the vegetable ferments which act upon this milk and upon the cheese, after it has been produced, are now known to give character to the product; that is to say, the effect of inoculation of the mass with some particular species of ferments is favourable, while the presence of others is deleterious. Thus the results obtained in the whole field of bacteriology are being made contributory to the success of the dairy. Already in Denmark "pure cultures" of certain kinds of ferments are beginning to be regarded as necessary to the success of the butter-maker, and essays of a similar kind are actually in progress here.

It is not possible to refer in detail to the numerous experiments and tests, completed or in progress, of varieties of plants and animals which may be already well known, but of which it is desirable to ascertain those best suited to the actual circumstances of the country. Nor is it possible to enter into questions such as the tests of fertilisers, the testing of the vitality of seeds, or the propagation of trees suited for planting on the plains of the north-west. Though a part of the useful work of the farms, these do not imply original research in the same measure with those subjects already alluded to. Neither is this the time to dwell upon the methods adopted of making the information gained available to the public, such as the publication of special bulletins and reports of progress, the distribution of samples of seed grain (which in 1892 reached the number of 30,000) and of young trees for plantations.

Before concluding this brief review of the several branches of scientific research or work carried on by the Government, allusion must be made to several comparatively late undertakings of this nature begun under the auspices of the Department of Marine and Fisheries.

Under the name of the "Georgian Bay Survey," a hydrographic survey of the Canadian portion of the Great Lakes was begun in 1885, and several excellent charts of the northern part of Lake Huron have already been published.

When the British Association met in Montreal in 1884, a committee of that body, which had for many years been engaged on tidal determinations, interested itself in the extension of such observations to Canadian waters, and a joint committee of the Association and of the Royal Society of Canada was formed, by which the importance of such observations, made systematically and with modern appliances of accuracy, was urged upon the Government. In 1890 a beginning was made in this work, and provision has since been made for its continuation and extension.

Another promising department is the initiation of a scientific study of that most important element in the welfare of the

country, the fisheries. Much has already been done in Canada in the matter of the propagation of food fishes, but much yet remains to be done in investigating the conditions of the fisheries of both salt and fresh waters, and it may now be anticipated that before many years an important basis of fact will have been built up upon this subject.

One important line of inquiry must yet be mentioned in which no systematic beginning has been made, either under the auspices of the Government, or by any society or institution especially devoted to it. This is the field of ethnology, which in Canada is a very extensive one, and which calls for immediate effort, inasmuch as the native races, with which this study is concerned, are either rapidly passing away or are changing from their primitive condition.

Ten years ago, the Council of the British Association was so much impressed with the urgency of investigations of this kind, that it not only appointed a committee to deal with the subject, but has since given each year a substantial grant from its own funds in aid of this work. The Canadian Government for several years supplemented this grant, and eight reports, filled with valuable observations on the western tribes, have so far, as a result of this action, been published in the annual reports of the Association. It has been decided, however, that the functions of the committee, with the grant accorded by the Association, shall cease this year, so that if further progress is to be made, the matter must now be taken up by the Canadian Government. It is earnestly to be desired that the Government may at least contemplate the attachment, either to the Indian Department or to some other department, of a properly qualified ethnologist, by whom these investigations may be continued.

### SOCIETIES AND ACADEMIES.

LONDON.

**Royal Society, December 6, 1894.**—"Experimental Researches on Vegetable Assimilation and Respiration. No. I. On a New Method for Investigating the Carbonic Acid Exchanges of Plants." By F. F. Blackman, B.Sc., Demonstrator of Botany in the University of Cambridge.

This paper consists of a description of a complicated apparatus for the estimation of very small amounts of  $\text{CO}_2$ , which is especially adapted for biological research.

By its aid the evolution of  $\text{CO}_2$  by a single germinating seed, or by a small area of a foliage leaf, can be accurately estimated from hour to hour without a break, for any desired time, while for the same area of leaf the more active absorption of  $\text{CO}_2$  in assimilation can be easily determined for such short periods of time as fifteen minutes, and that at the same time separately for the two surfaces (top and bottom) of the same leaf area. Further, for the purpose of this assimilation, air containing any proportion of  $\text{CO}_2$ , however small, can be supplied continuously to the tissue under investigation. The apparatus is practically in duplicate for the purpose, and strictly comparative double experiments can be performed.

The measurements are carried out in a continuous current of air of known pressure; the actual estimation of the  $\text{CO}_2$  being accomplished by leading this through baryta solution, of which only a small quantity is used in each case, and the whole of it afterwards absorbed in the absorption tube, to which only air free from  $\text{CO}_2$  is otherwise admitted.

The following communication illustrates the applicability of this apparatus to the investigation of minute quantities of carbon dioxide.

**Nov. H. From the Paths of Gaseous Exchange between Aerial Leaves and the Atmosphere.**

*Conclusion.*—(1) That if the amounts of  $\text{CO}_2$  evolved in respiration by the two surfaces of any leaf area be determined, it will be found that there is a very close relation between these amounts and the distribution of the stomata. In those leaves with no stomata on the upper surface, practically no  $\text{CO}_2$  is exhaled from that surface, and all escapes from the lower surface. When stomata occur equally on the two surfaces the amount of  $\text{CO}_2$  exhaled is equal on the two surfaces, and

(2) Similarly with a circulation, no  $\text{CO}_2$  is absorbed by an anastomosing leaf surface, and when stomata occur on both surfaces, then the amount absorbed follows the ratios of stomatal distribution.

(3) But singularly experiments on the assimilation of leaves

with blocked stomata, which have hitherto formed the mainstay of the "cuticular" absorption theory, are completely vitiated by having been performed in super-optimal percentages of  $\text{CO}_2$ . Their interpretation is exactly the reverse of that usually accepted.

(4) The exhalation of  $\text{CO}_2$  in bright light by a leafy shoot in Garreau's well-known experiment, is not the expression of any physiological truth for the leaf, but is only due to the presence of immature parts, or of tissues not sufficiently green, or not fully illuminated. Mature isolated green leaves fully illuminated assimilate the whole of their respiratory  $\text{CO}_2$ , and allow none to escape from them.

December 13, 1894.—"The Influence of the Force of Gravity on the Circulation." By Prof. Leonard Hill, M.B.

The chief results of the research are contained in the following conclusions:—

(1) That the force of gravity must be regarded as a cardinal factor in dealing with the circulation of the blood.

(2) That the important duty of compensating for the simple hydrostatic effects of gravity in changes of position must be ascribed to the splanchnic vaso-motor mechanism.

(3) That the effects of changing the position afford a most delicate test of the condition of the vaso-motor mechanism.

(4) That the amount of compensation depends largely on individual differences.

(5) That the compensation is far more complete in upright animals such as the monkey, than in rabbits, cats, or dogs, and, therefore, is probably far more complete in man.

(6) That in some normal monkeys over-compensation for the hydrostatic effect occurs.

(7) That in the normal monkey and man gravity exerts but little disturbing influence, owing to the perfection of the compensatory mechanism.

(8) That when the power of compensation is damaged by paralysis of the splanchnic vaso-constrictors, induced by severe operative procedures or by injuries to the spinal cord, by asphyxia, or by some poison such as chloroform or curare, then the influence of gravity becomes of vital importance.

(9) That the feet-down position is of far greater moment than the feet-up position, because when the power of compensation is destroyed the blood drains into the abdominal veins, the heart empties, and the cerebral circulation ceases.

(10) That, generally speaking, the feet-up position occasions no ill consequence.

(11) That the horizontal and feet-up positions at once abolish the syncope induced by the feet-down position by causing the force of gravity to act in the same sense as the heart, and thus the cerebral circulation is renewed.

(12) That firmly bandaging the abdomen has the same effect. While the heart remains normal, and so long as the mechanical pressure is applied to the abdominal veins, the blood pressure cannot possibly fall.

(13) That if the heart is affected, as by chloroform or curare poisoning, the restoration of pressure is incomplete, and it is possible that the heart may be stopped altogether by the inrush of a large quantity of blood, caused by too rapid an application of pressure on the abdomen. More work would be thrown upon the heart than, in its impoverished condition, it could perform.

(14) That vagus inhibition and cardiac acceleration are subsidiary compensatory mechanisms in the feet-up and feet-down positions respectively.

(15) That chloroform rapidly paralyses the compensatory vaso-motor mechanism, and damages the heart.

(16) That ether, on the other hand, only paralyses the compensatory vaso-motor mechanism very slowly and when pushed in enormous amounts.

(17) That the vaso-motor paralysis induced by these anaesthetics lasts for some considerable time after the removal of the anaesthetics.

(18) That chloroform can, by destroying the compensation for gravity, kill the animal, if it be placed with the abdomen on a lower level than the heart.

(19) That elevation or compression of the abdomen immediately compensates for the vaso-motor paralysis produced by chloroform.

(20) That compression or elevation of the abdomen, coupled with artificial respiration and with squeezing of the heart through the thoracic walls, is the best means of restoring an

animal from the condition of chloroform collapse. That these results agree entirely with McWilliams', and are opposed to those of the Hyderabad Commission.

(21) That the feet-down position inhibits respiration, and the feet-up position accelerates it.

(22) That these respiratory results probably depend upon the stimulation of sensory nerve endings by changes of tension brought about by the alterations of position, because the results are abolished by dividing the vagi.

(23) That in the feet-down position the respiration is thoracic in type, and the abdomen is retracted; in the feet-up position the respiration is diaphragmatic and the abdomen freely expanded.

(24) That these types of respiration tend to compensate for the effects of gravity on the circulation, for the retraction of the abdomen in the feet-down position mechanically supports the abdominal veins, whilst the thoracic inspirations aspirate blood into the heart. In the feet-up position the full and free expansion of the abdomen withdraws all obstacles to the compensatory dilatation of the abdominal veins.

In the last part of the paper the medical aspects of this research are discussed. It is suggested that emotional syncope is due to paralysis of the splanchnic area, and a case is quoted where compression of the abdomen immediately removed the syncopal condition. The same treatment, or that of elevation of the abdomen, is suggested for conditions of shock, chloroform collapse, and after severe hæmorrhage.

Finally, a parallel is drawn between some of the results of this research in reference to monkeys and those obtained by Dr. George Oliver on man, by measuring the diameter of the radial artery with his ingenious instrument, the arteriometer.

Physical Society, December 14, 1894.—Prof. W. E. Ayrton and Mr. H. C. Haycraft communicated a paper on a students' simple apparatus for determining the mechanical equivalent of heat. Mr. Haycraft, who read the paper, explained that the object at which the authors had aimed was the construction of an apparatus which could be placed in the hands of junior students, and by means of which a result correct within one per cent. could be obtained, without the introduction of troublesome corrections. The method employed is the electrical one, and the measurements to be made are (1) the value of the constant current passed through the resistance, as given by a direct-reading ammeter; (2) the average value of the P.D. between the terminals of the resistance, as given by a direct-reading voltmeter; (3) the mass of water heated plus the water-equivalent of the containing vessel, resistance-coil, and stirrer; (4) the rise of temperature of the water; (5) the time during which the current is passed. Of these the measurements (1) (2) (3) can be effected without the introduction of an error anything like as great as one per cent. The case of (4) and (5) is different. The rise of temperature, to be measured with accuracy, should be fairly considerable, and the same remark applies to the time of heating as measured by an ordinary stop-watch. At the same time, if these two quantities are made unduly great, there will be too great a ratio of heat lost to heat generated during the experiment. The authors consider that, with a given amount of electrical power available, the best conditions will be obtained by making the percentage accuracy of the temperature measurement, the percentage accuracy of the time measurement, and the percentage of generated heat lost by surface cooling equal. Hence they determine the mass of water to be used and the time of heating which may be expected to give the best results. The immersed conductor is a strip of manganin about 0.25 inch wide, 0.03 inch thick, and 5 feet long, which is bent into a series of zig-zags, so as to form a kind of circular gridiron, the successive portions of strip lying all in one plane, and the whole being held rigid by a strip of vulcanised fibre, to which each portion of the strip is sewed. Another precisely similar grid is placed 3 inches below the first, and the two are joined in series, and are mechanically connected together by thin vulcanite pillars. The water is contained in a glass beaker of just sufficient diameter to take the framework of manganin strip. This latter exposes a considerable surface (about 400 sq. cm.) to the water, and is moved bodily up and down during the experiment, thus constituting an efficient stirrer. To allow sufficient freedom of movement, electrical connection is made by means of very flexible leads, each made up of about 210 thin copper wires. The results obtained by students for the heat equivalent of the watt-second have an average deviation from the mean, if several experiments are made, of less than one-half per cent.; and they agree with the best standard determinations within one

per cent. Mr. Griffiths thought it inadvisable to provide junior students with apparatus from which every source of error had been eliminated; they were thus led to underrate the difficulty of an experiment, and the care required to obtain reasonable accuracy. Prof. Carey Foster agreed generally with Mr. Griffiths, and deprecated the use of direct-reading ammeters and voltmeters in experiments of this kind. He thought it preferable that a student should learn to reduce instrumental readings to absolute measure for himself. Prof. S. P. Thompson dissented from the opinions expressed by the two previous speakers, and thought it was an advantage to students to have the use of direct reading instruments. Dr. Sumner described a simple method which he had employed for measuring the mechanical equivalent of heat, and which depended on the heating of a stream of water, as it flowed through a pipe containing the current-conductor. Prof. Rucker was inclined to take an intermediate view of the questions that had been raised. He thought that students should take for granted as little as possible concerning their instruments; but to verify every point, even if practicable, would occupy a great deal of time which might otherwise be more profitably employed. Prof. Ayrton replied, and explained that the calibration of ammeters and voltmeters would be part of the work of a student at another part of his course.—A paper by Prof. Ayrton and Mr. E. A. Medley, entitled "Tests of glow-lamps, and description of the measuring instruments employed," was commenced by Mr. Medley, the latter part of the paper being held over till next meeting. The object of the investigation was to find at what E.M.F. glow-lamps could be most economically run. Too low an E.M.F. gives a low efficiency, and too high an E.M.F. renders the lamps short-lived; so that there must be (for a given lamp) a certain E.M.F. which is more economical to work at than any other. It was also pointed out that, as glow lamps deteriorate and become less efficient with use, it may be an economy to discard a lamp before the filament actually breaks. The lamp is then said to have reached the "smashing point." Accumulators were used to drive the lamps, automatic apparatus being used to keep the E.M.F. constant, and when a lamp filament broke, the fact was automatically recorded on a tell-tale.

Geological Society, December 19, 1894.—Dr. Henry Woodward, F.R.S., President, in the chair.—The Lower Greensand above the Athefield Clay of East Surrey, by Thomas Leighton. This paper embodies the results of the author's examination of the Lower Greensand of East Surrey during the three years 1892-94. The area discussed in the paper extends from Leigh Hill in the west to Tilburstow Hill in the east; and the divisions of the Lower Greensand chiefly referred to are those hitherto known as the Bargate, Sanigate, and Hythe beds. The author stated that the Lower Greensand of East Surrey shows that formation to consist of beds deposited in a marine estuary or narrow sea, not far from land and within the influence of strong currents, extending generally from N.W. to S.E., so that, without palæontological evidence, no correlation of beds here with those exposed at Sandgate and at Hythe is possible. He arrived at this conclusion by following the outcrop of the various chert-beds, which, after Dr. G. J. Hinde (*Phil. Trans. Roy. Soc.* vol. clxxvi, 1885), are accepted as of sponge origin (deep-water deposits), and further by following the outcrop of the pebble-beds, described by Mr. C. J. A. Meyer (*Geol. Mag.* for 1866, p. 15).—On the eastern limits of the Yorkshire and Derbyshire or Midland coalfield, by W. S. Gresley. The author attempted to throw light on the question of the easterly extension of the Yorkshire, Derbyshire, and Nottinghamshire coalfield beneath the newer rocks. He noticed the general trend of the strata, the sizes of other British coalfields, the question of the origin of mountains, stratigraphical considerations, and the faults of the North of England.—On some phases of the structure and peculiarities of the iron ores of the Lake Superior region, by W. S. Gresley. The author has studied heaps of ore brought from the region lying south-west of Lake Superior since 1890. He described certain structural features of the ore-fragments, and discussed the evidences of mechanical movements and chemical alteration exhibited by these fragments.

Chemical Society, December 6, 1894.—Dr. Armstrong, President, in the chair.—The relative behaviour of chemically prepared and of atmospheric nitrogen in the liquid state, by James Dewar, F.R.S.—On the use of the globe in the study of crystallography, by J. V. Buchanan, F.R.S.—A new method of obtaining dihydroxytartaric acid, and the use of

derivatives but yield no acid or basic salts. These derivatives are generally well adapted for determining their molecular weights, and hence the valency of the contained metallic radical. By means of a determination of the vapour density of glucinum acetylacetonate, it is found that glucinum is divalent, and its oxide must be written  $\text{BeO}$ .—On the constitution of the aromatic sulphones, by MM. L. Zorn and H. Brunel.—On the cephalic lobe of the Euphorbiae, by M. Emile G. Racovitzka.—On the development of the kidney and the general cavity in the Cruripedes, by M. A. Gravel.—On the functional differences between normal and enervated muscle, by M. N. Wedensky.—On the biological relations between *Cladophyllum viticolum*, A. Prunet, and the vine, by M. A. Prunet.—On a detailed botanical chart of France, by M. Ch. Flahault.—On a peculiar method of dehiscence of the pollen of the fossil *Dolero-phyllum*, by M. B. Renault.

PARIS.

Academy of Sciences, Dec. 24, 1894. M. Loewy in the chair.—On two invariant numbers in the theory of algebraical surfaces, by M. F. de M. Pictet.—Displacement of carbon by boron or silicon in fused cast-iron, by M. Henri Moissan. Carbon is displaced by boron or silicon in a fused iron carbide or cast-iron in the same way that  $\text{FeS}$  will displace each other from a saturated solution. A saturated equilibrium is set up between the iron carbide on the one hand, and the iron boride or silicide on the other hand.—On the circulation of the lymph in the small lymphatic vessels, by M. L. Ravvier.—On the importance of the lymphatic circulation in with the re-establishment of vineyards, by M. A. Millardet.—The Secretary announced the death of M. Francis Durrin, Director of the Vatican Observatory.

On the elements of the planet 1894 BE, by M. J. J. Baize.—The elements for the planet BE, by M. J. J. Baize.—BE is the most favourably situated, among the planets, for the determination of solar parallax. The planet BE is seen at an angle of  $5^{\circ}$  to the *Equinox*.—Observations of Encke's comet and of the planets JH and L, made at Algiers Observatory, by MM. Rambaud and S. S. —Observations of Encke's comet, made at Lyons Observatory, by M. G. Le Cadet.—Observations of the sun, made at Lyons Observatory during the third quarter of 1894, by M. J. J. Baize.—On the profile of three bodies, M. F. Sisevi's contribution to his paper on this subject dated January 12, 1874. He remarks that a paper of August 27 (*Comptes rendus*, 454), "Sur la transformation des équations canoniques du problème des trois corps," is a reproduction of his 1874 paper.—Remarks on the matter of a priority claim made by M. O. Staude, by M. P. Staedel.—On the solution of numerical equations by means of recurring series, by M. R. Perrin.—On a doctrinal point relative to the theory of multiple integrals, by M. Jules Andrade.

On the capacity for 16 and 18 variables, by M. A. Laffay.—On the dielectric capacity of a line traversed by a current, by M. Vassily.—The capacity per unit of length of a cable traversed by a permanent current has the same sense as in dielectric cases. With rapidly varying currents, it cannot be said that the electric field admits of a potential, hence the dielectric capacity disappears.—Electric potentials in a liquid conductor in uniform movement, by M. G. Goussier.—Vibrations. At speeds of 33 to 323 mm. per second, the uniform movement of a liquid conductor traversing water is not free of uniform section, does not produce any appreciable difference of potential between two points in the liquid.—Experimental researches on radiation at low temperatures, by M. P. P. P. —This is an abstract containing a series of curves showing the variation of radiation with time, and a series of curves showing the variation of the study of atmospheric curves, by M. J. Peyron.—On the metallic sulphides, by M. A. Vial.—Condensations of hexamethylene-amine with cyanogen chloride, and carbonate, by M. Delepine.—On the cyanohydrin, by M. Albert Colson.—On the chromates of iron, by M. Charles Lepierre.—The author has obtained three chromates, of which two only were known before. Their preparation from ferrous or ferric salts, all contain ferric iron, a ferric chromate. They form a series parallel to the ferric chromates of iron. A new reagent allowing the demonstration of the presence of hydrogen dioxide in green plants, by M. A. Rich.—A solution as made containing 0.03 gm. of potassium chromate and two drops of aniline per litre. 5 c.c. of this solution give a violet colouration with two drops of a 5 per cent. solution of oxalic acid only after 20 hours. The colouration is given in the presence of hydroxyl ions from 10 to 30 minutes. The reagent allows the detection of one part of hydroxyl in 1,000,000. The method of treating green plants is given in detail, and a list of a number of plants showing the reaction is added.—On the valency of glucinum (beryllium) and the formula of glucina, by M. Alph. Combes.—Berketones, particularly acetylacetone, form metallic

BOOKS, PAMPHLETS, and SERIALS RECEIVED.

Books.—Woman's Share in Primitive Culture; Dr. O. T. Mason (Macmillan).—Cape of Good Hope; T. Durnan and H. Seligson, Vol. v. (Dunlop).—Standard Methods in Physics and Electricity Criticised, and a Test of Electric Meters proposed; H. A. Naber (Lucker).—Webster's Practical Forestry; A. D. Webster, 2nd edition (Koder).—Puhcancanthropus Erectus, eine Menschenachtliche Uebergangsform aus Java; E. Dubois (Batavia, Landesdruckerei).—A Dictionary of Birds; A. Newton and H. Gadow, Part 3 (Black).—American Spiders and their Spinning Work; Dr. H. C. M. Cook, Vol. 1 (Philadelphia Academy of Natural Sciences).—Zoological Record, 1894, edited by D. Sharp (Ginn).

Pamphlets.—On Gula Lebrnis Spindingsatt; Dr. E. Aberg (Stockholm).—Sur la Transmissibilité de la Fièvre Jaune; Dr. E. Aberg (Stockholm).—Sulle onde elettromagnetiche, &c.; Prof. A. Righi (Bolonia).—Versuch einer Theorie der Electricischen und Optischen Erscheinungen in Bewegten Körpern; Prof. H. A. Lorentz (Leiden, Brill).—Die Form des Himmelsgewölbes; W. F. Ebeling (Bonn).—Blackie's First Stage Mathematics, English and Algebra (Blackie).

Serials.—English Illustrated Magazine, January (7s. Strand).—Good Words, January (5s. 6d. Strand).—Sunday Magazine, January (1s. 6d. Strand).—Journal of the Chemical Society, December (Ginn).—Zeitschrift für Wissenschaften der Chemie, I. Band, 4 Heft (Williams).—L'Annuaire Journal, Décembre (Macmillan).—Mathematical Gazette, No. 3 (Macmillan).—Chambers's Journal, January (Chambers).—Longman's Magazine, January (Longman).

CONTENTS.

	PAGE
Biological Lectures and Addresses. By E. B. P.	217
Text-book of Agriculture	218
Ewing on the Steam-Engine. By N. J. L.	219
Our Book Shelf:—	
Wetterhan: "Das Verhältniss der Philosophie zu der empirischen Wissenschaft von der Natur"	220
Moore: "Meteorology, Practical and Applied."	220
W. E. P.	221
Woods: "The Province of South Australia"	221
Smith: "Measurement Conversion Diagrams"	221
Letters to the Editor:—	
The Kinetic Theory of Gases.—Prof. G. F. Fitzgerald, F.R.S.; Rev. H. W. Watson, F.R.S.	221
The Horn Expedition to Central Australia.—Prof. Baldwin Spencer	222
Paleontology at the Royal School of Mines.—Right Hon. T. H. Huxley, F.R.S.	223
Eocene Fossils at Murren.—Right Hon. Sir John Lubbock, Bart., M.P., F.R.S.	223
The Use of the Globe in Crystallography.—William J. Pope	223
"The Zoological Record."—S. Pace	223
Gravitational.—Dr. J. Joly, F.R.S.	223
The Fading of Death.—R. Harry Vincent	223
Peculiarities of Psychological Research.—Edward T. Dixon	223
On the Age of the Earth. By Prof. John Perry, F.R.S.	224
Jupiter. (Illustrated.) By W. F. Denning	227
Notes	229
Our Astronomical Column:—	
A New Short Period Variable	233
Doppler's Principle	233
The Astrophysical Journal	234
Lithical Orbits	234
Forestry in Natal.—Prof. W. R. Fisher	234
The Fertilisation of <i>Lycanthus kraussianus</i> and <i>L. Dreyer</i> . By Maurice S. Evans	235
Scientific Investigation in Canada. By Dr. G. M. Dawson, C.M.G., F.R.S.	236
Societies and Academies	238
Books, Pamphlets, and Serials Received	240

THURSDAY, JANUARY 10, 1895.

THE ORIGINS OF ART.

*Die Anfänge der Kunst.* By Dr. E. Grosse. 301 pp. 32 figures in the text, and 3 plates. (Freiburg i.B.: Mohr, 1894.)

DR. E. GROSSE, in his book on "The Origins of Art," has struck out a new and very promising line of research. Other authors may have worked to a limited extent at restricted aspects of the subject, or may have theorised to an unlimited extent; but no one has studied the beginnings and evolution of the arts, with such constant reference to what actually occurs, irrespective of what the arm-chair philosopher imagines might have happened.

Dr. Grosse limits its present investigation not only to primitive art, but also to the sociological aspects of the science of art, not because he does not appreciate the other aspects, but because he wished to deal the more thoroughly with this particular problem. His main object appears to be to show, as he expresses it, that "art does not serve only as a pleasant amusement, but for the fulfilling of the most earnest and highest practice of life."

The book contains the following chapters: The aim of the science of art; the method of the science of art; Primitive folk; Art, Decoration, Ornamentation, Representation (sculpture and painting); Dancing, Poetry, Music, and Conclusion. The method adopted is that of comparative ethnography, and our author confines his attention to the lowest and least settled peoples—to the hunter-folk. In order to eliminate as far as possible the secondary factors of race and climate, he studies the condition of each art among the following peoples: Australians, Mincopies (Andamanese), Bushmen, Eskimo, and Fuegians, with occasional references to other peoples.

Each of these chapters is treated in so fresh and suggestive a manner, that one is tempted to quote largely; but a summary of the general conclusions will give a fair idea of the scope of the book. The chapter on dancing is particularly interesting, and the importance of the dance in social evolution is clearly brought out; no one who has witnessed and studied various kinds of savage dances, can fail to feel that they have a significance and value which is entirely lost in the dances of civilised people. "The pleasure of strong and rhythmical movements, the pleasure of imitation, the pleasure of giving vent to the feelings, these factors," writes Dr. Grosse, "give a complete and sufficient explanation of the passion which primitive folk have for dancing." At the same time, he points out that the occasional assembling for social dances induces co-operation among loosely-connected hunter-folk. "It is perhaps along with war the one factor which causes the members of a primitive group to vividly feel their solidarity, and it is at the same time one of the best preparatives for war. It is difficult to over-estimate the value of primitive dances in the culture-development of mankind."

It is found that the artistic creations of the hunter-folk have by no means arisen from purely æsthetic intentions,

but they serve at the same time for some practical object, and frequently this latter appears to be the chief motive. Primitive ornaments are not originally and essentially employed for decoration, but as significant marks and symbols. In other cases the æsthetic intention certainly predominates, but, as a rule, it is only in music that it appears as the sole motive.

Although artistic activity, as such, hardly anywhere occurs at the lowest grades of culture, still it is everywhere recognisable, and essentially of the same character which one finds in the higher grades of culture. Only one art, architecture, is wanting among any of the hunter-folk. Herbert Spencer suggested that the three main groups of poetry—lyric, epic, and dramatic—were evolved in the course of the development of the higher culture from an undifferentiated primitive poetry; but these are already to be found in an independent position of their own at the lowest culture grade.

Primitive art forms are constructed according to the same laws as the highest creations of art, the great æsthetic principles of rhythm, symmetry, opposition, gradation and harmony are employed by the Australians and Eskimo as well as by the Athenians and Florentines. The sensations of primitive art are narrower and coarser, their materials are more scanty, their forms are poorer and more clumsy; but in its essential motives, means, and aims, the art of primitive times is one and the same with the art of all times.

Dr. Grosse does not believe that racial character has a decided determining significance in the development of the art of a people at the lowest grade of culture, but that the individuality of the folk, as well as that of individuals, continuously increases with the course of their development. The uniform character of primitive art is due to a uniform cause, and that culture factor is the uniform character of the condition of life of the hunter-folk, irrespective of race or latitude.

The particular kind of production of a people depends, above all, on the geographical and meteorological conditions under which they live. The hunter-folk have remained hunter-folk—not, indeed, as the older ethnologists believed, because they were from the very beginning condemned to stand still through a faulty disposition, but because the nature of their native country prohibited progress to a higher form of production. Herder and Taine maintain that climate exerts a direct influence on the spirit of a people and the character of their art; but Dr. Grosse claims to have proved that the influence is indirect—the climate commands the art through the production. It is doubtful whether this can also be proved for the art of the higher folk, since people provided with a richer culture have made themselves in their production independent of the influences of climate. The progress of culture emancipates the folk from a slavery to nature to a mastery over nature, and one may dare to assume that this also finds a corresponding expression in the development of art.

There are no peoples without art, and even the lowest and roughest races devote a great part of their time and energy to art; to art, adds Dr. Grosse (perhaps somewhat unjustly), which is looked down upon by civilised nations from the height of their practical and scientific acquirements, and treated mainly as an amusement; but

from the standpoint of modern science it is incomprehensible that, if such an immense amount of energy was diverted from the conservation and development of the social organism and devoted to æsthetic creation and enjoyment, Natural Selection would not step in, and long ago have rejected those peoples who wasted their energy in so unproductive a manner, in favour of other and more practically endowed folk. The conclusion is therefore arrived at that, from the very beginning, primitive art, besides its immediate æsthetic significance, must also possess a practical advantage for the hunter-folk.

The primitive arts operate in very different ways on primitive life. Ornament demands technique above everything. Ornament and the dance play an important part in the intercourse of both sexes, and through their influence on sexual selection probably serve for the improvement of the race. On the other hand, some of the arts increase the power of the social group in its resistance to hostile attacks; for example, certain decoration is employed to frighten opponents; poetry, dancing and music stimulate and encourage the warriors. The most important and beneficent effect which art exercises on the life of the folk consists in the consolidation and broadening of the social relationship. Not all arts effect this to an equal degree. While dancing and poetry seem predestined to this through their innate peculiarity, music is, from the same cause, almost quite excluded from it. But the effect of the two former varies according to the stage of culture of the people; for example, dancing loses its influence as soon as the social groups become too large for them to be united in one dance; and, on the other hand, poetry has to thank the printing-press for its incomparable power. Among the hunter-folk, dancing is the most important social influence; for the Greeks, sculpture embodied the social ideal in the most effective form; in the middle ages, architecture united souls and bodies in the halls of their gigantic domes; in the Renaissance, painting employed a language which is understood by all the cultured peoples of Europe; and in recent times, the reconciling voice of poetry rings amid the clash of arms and the conflict of classes and peoples.

As science enriches and elevates our intellectual life, so art enriches and elevates our emotional life. Art and science are the two most powerful means for the education of the human race. No pastime therefore, but an indispensable social function is art, one of the most effective weapons in the struggle for existence, and consequently it must develop itself always more richly and powerfully through the struggle for existence. Art is a social function, and every social function must serve for the conservation and development of the social organism. But it is wrong to demand of art that it should be moral, or, more correctly, moralising, for then one demands that art shall no longer be art. Art serves social interests best when it serves artistic interests.

From the foregoing account it will be seen that this book deals largely with the sociological aspects of æsthetics; and it is not only a study of primitive art in the widest sense of the term, but it is also a study of some of the factors of social evolution. It is certainly a book which should be translated into English, in order that it may obtain a wider circle of readers.

ALFRED C. HADDON.

#### FORBES'S HANDBOOK OF MONKEYS.

*A Handbook to the Primates.* (Allen's Naturalists' Library.) By H. O. Forbes. Svo. 2 vols. illustrated. London: W. H. Allen and Co., Limited, 1894.)

OF the series of which the present work forms a part, five volumes have now made their appearance, namely, one on Marsupials and Monotremes, one on British Birds, a third on Butterflies, and the two now under consideration; while a sixth, on British Mammals, is now in the press. In the three volumes previously issued, it was found practicable to make use of the original plates (with the addition of a few new ones) from the old "Jardine's Naturalists' Library"; but those in the volume in that series devoted to monkeys were such grotesque caricatures, that both editor and publisher were soon convinced that their reissue was impracticable. Consequently, the plates (twenty-nine in number, in addition to several maps) in Mr. Forbes's volumes have all been prepared from entirely new sketches from the pencil of Mr. Keulemans. Whether the lithographers have been quite as successful with some of these as they might have been, we think is doubtful; the colours in some instances being decidedly too bright, while in others the execution is too coarse, and not sufficiently detailed. As a whole, however, they are very creditable, while some, such as the portrait of the Aye aye, forming the frontispiece to the first volume, are admirable specimens of artistic work.

In a series of volumes like those under consideration, it can scarcely be expected that their respective authors should undertake a detailed study of the skins and skulls of each species they describe, as if they were writing a museum catalogue. Nevertheless, we believe that Mr. Forbes has done this in a large number of cases, and has consequently been able to make some important identifications. He had a specially difficult task before him, for several reasons. In the first place, there is no British Museum catalogue of Primates since the small one published as far back as 1870 by Dr. Gray, which is now, of course, totally out of date; and, secondly, the collection of monkey-skins and skulls in the National Collection is far from being anything near as complete as is desirable. So that, even if the author went through the whole series in the groups most requiring revision, it is improbable that his conclusions would in all cases be unassailable. It may be added that the British Museum collection of monkey-skins consists largely of menagerie-specimens, without properly authenticated localities, or without specified localities at all; the reason of this being the well-known dislike of English naturalists and collectors to shoot monkeys.

As against these drawbacks, Mr. Forbes had some compensating advantages, notably the recent description, by Dr. Forsyth Major, of several new forms of Lemuroids, both recent and fossil. Consequently, his volumes contain descriptions of several forms which are not to be met with in any other collective work on the subject. Not the least interesting among these is the gigantic extinct Lemuroid (*Megaladapis*) of Madagascar, which it is possible may have been still living when that wonderful island was first visited by Europeans.

Mr. Forbes follows the classification now generally



adopted by English zoologists, including the Lemuroids in the Primates, and commencing his description with the latter, from which he ascends to the higher forms. As the volumes only bear the title "Monkeys" on their covers, it will perhaps be a surprise to many of our readers (as it was to ourselves) to find Man included in the second volume. Although we were aware that many zoologists regarded Man merely as a highly-advanced monkey, yet we believe this to be the first occasion in which he has been termed a "monkey" pure and simply. We trust it may be the last.

We do not propose to criticise any of the author's views as to the limits of species or varieties, or enter into any discussion on the thorny path of synonymy and the identification of imperfectly defined species. And we accordingly content ourselves with saying that his descriptions are, for the most part, accurate and well-written, and that these are enlivened, when occasion requires, with interesting notes on the habits of some of the better-known species. We cannot, however, refrain from entering a protest against the "double-barrelled" system of nomenclature (as exemplified in *Tarsius tar. ius*) the author sees fit to employ—to our mind the most inelegant and absurd result of a slavish adherence to priority.

An important feature of the work is the inclusion of all the known forms of fossil Primates. It would, however, have been better had the author consulted a text-book of geology, as we should not then have been told that while Lemuroids are met with in the Quercy Phosphorites and the Hordwell beds of Hampshire, yet (vol. i. p. 111) "in strata of *Oligocene*<sup>1</sup> and older Miocene age no Lemuroid remains have come to light in Europe." We have likewise some doubt as to the alleged Ungulate affinities of the Tertiary Lemuroids referred to on the page last cited; and, indeed, it seems to us incredible that an animal whose position is admittedly in the Primates, can at the same time be allied to such widely different groups as the Ungulates and the Insectivores, although this is stated by the author to be the case. One other criticism, and we have done. On p. 217 of the second volume it is stated that to the genus *Simia* "has been referred a molar tooth found in the Pliocene strata of the Sivalik hills in India. It is considered to belong to an Orang-Utan, *Simia satyrus*." We have the best reasons for believing that the specimen in question is a canine tooth, and likewise that the palæontologist who made the generic determination would be surprised to learn that he had identified it with a living species.

An especial feature of Mr. Forbes's work is the attention paid to the geographical distribution of the various species and groups of monkeys and lemurs; this part of the subject being elaborately treated in a series of tables at the end of the second volume, supplemented by eight coloured maps. The details here given will be extremely valuable to all future students of distributional zoology.

The series of which these volumes form a portion, ought certainly to have an extensive patronage from those who are interested in natural history from a popular point of view; while at least some of the volumes—and Mr. Forbes's among the number—will be almost indispensable to professed students of zoology. R. L.

<sup>1</sup> The italics are our own.

BIRDS OF THE WAVE AND WOODLAND.

*Birds of the Wave and Woodland.* By Phil Robinson, author of "Noah's Ark," &c. Illustrated by Charles Whymper and others. (London: Isbister and Co., 1894.)

MR. ROBINSON is probably the most popular living representative of a school of writers on natural history, dating its origin from the publication, fifty or sixty years ago, of Mr. Broderip's delightful "Zoological Recreations."

Taking birds and beasts as texts for pleasantly discursive essays, in which field-notes, poetry, and folklore rub shoulders with the latest conclusions arrived at by the learned in laboratories and dissecting-rooms, he and his fellows bridge the gap which separates the writings of such disciples of Gilbert White as the late Richard Jefferies, and "a Son of the Marshes," from purely scientific works.

Anything which Mr. Robinson has to say of the animal creation in fur or feather is sure to be pleasant reading; never more so than when he has at his elbow as adviser on such mysteries as "the miracle of migration" the young lady who wrote the preface to "Noah's Ark." A book with his name on the back, and pictures by Mr. Whymper between the covers, is certain to find purchasers and readers to enjoy it. It is a typical Christmas book, prettily got up, printed on good paper, "leaded" with seasonable generosity, beautifully illustrated, and edited, perhaps rather hurriedly, to be in time for the Christmas market. We notice, for instance, that an excellent sketch of partridges in a stubble field figures in the list of illustrations as "grouse." Again, he tells us (p. 93) that "once upon a time rooks were called crows," and that "as the latter had very evil reputations the former suffered for it." He goes on to give a piece of his mind to "the obstinate people in the world who will not understand that it makes any difference whether they use a right name or a wrong one." On his very next page is a capital picture of a couple of scaly-beaked rooks gossiping by the nest in a rookery at bed-time, with the legend beneath, "Crows at Sundown."

The description of the thrush carrying its snails day after day to the same stone for execution, and there "building up in its own way a little shell midden, like those which prehistoric man has left us of oyster-shells and clams to puzzle over," is in his best style. But we cannot help thinking that the cases must be rather exceptional in which the bird, "when driven by stress of weather to the sea-shore, treats the hard-shelled whelks just as it treated the garden snails"?

The pictures seem to us, almost without exception, excellent, and are so important a part of the book that "Birds of the Wave and Woodland," by Charles Whymper and others, illustrated by the pen of Phil Robinson, would have been a scarcely less appropriate title than that which appears on the front page.

The influence of South Kensington is apparent in most of the pictures, and the only serious doubt which suggests itself on putting down a very pleasant book, is whether it might not have been better, somewhere or other, to have acknowledged that many (ten at least) of the best

are copies, in some instances almost photographically exact, of cases in the Natural History Museum?

Mr. Robinson has kept his best wine for the last. He has seldom, if ever, written anything more fresh and charming than the description, in his concluding pages, of the voles and water-hens of the osier bed in which in boyish days he dodged his hated enemy the keeper, slipping once, as he tells us, when suddenly surprised, into the water, and sitting there "like a coot with only head above the surface, and that half hidden by reeds!" The boy is father to the man, and we can pay the writer no higher compliment than to say he has proved himself worthy of his parentage.

T. D. P.

### OUR BOOK SHELF.

*Studies on the Ectoparasitic Trematodes of Japan.* By Seitaro Goto, *Rizakushi*. Published by the Imperial University, Tokyo, Japan, 1894.)

THIS memoir extends to 275 pages, and is illustrated by twenty-seven plates. The species on which these studies were made, were for the most part collected by the author himself, from various parts of the Japanese coast, between the years 1889 and 1892. For the present he omits the Gyrodactylidae, as his investigations of the anatomy of this group are not yet completed. After a brief introduction, in which the method of preparation is described, the details of the anatomy of the several systems, as met with among the species of the ten genera found in Japan, are given; this is followed by some notes on the habitat, powers of locomotion, food and colouration of the several forms, and then we have the systematic portion. By far the greater number of the species were found attached to the gills of fishes, but several live in their oral cavity, and some even on the outer surface of their bodies. In one remarkable instance, that of *Tristomum biparasiticum*, the worm was found always attached to the carapace of a copepod, itself parasitic on the gills of *Thynnus albacora*. The "looping" movements observed by Haswell have been often witnessed by Goto, sometimes they are performed so rapidly in succession as almost to escape observation; lateral movements in some instances were noticed. Whilst the greater number feed on the mucous slime of their hosts, some were undoubtedly blood-suckers. In the systematic description, attention is drawn to the important specific characters to be found in the "hooks" which are often present, near the posterior end of the body. Thirty species belonging to the following ten genera are fully described: Microcotyle, Axine, Octocotyle, Dichliphora, Hexacotyle, Onchocotyle, Calicotyle, Microcotyle, Epibdella, and Tristomum. While none of the genera are new, some of them have amended diagnoses, and the information about the various species included in each is brought wonderfully up to date. Of the thirty species, all are described as new: one, *Dichliphora miris*, was found in the mouth cavity of *Siniperca vulgaris*, taken in the Bay of Naples; all the rest are from Japan. Owing to the often very imperfect descriptions given by previous describers of species, it is possible that some of those described by Goto may on further investigation rank as synonyms, but most of them are strikingly distinctive forms. *Octocotyle*, Diesing, and *Dichliphora*, Diesing, have been combined by many in the genus *Otobothrium*, F. S. Leuckart; but the author gives good reasons why Diesing's genera should be retained, characterising the former genus anew. The author's drawings have been

beautifully lithographed; the plates have been all executed at Japan, and will bear comparison with any similar work done in Europe. A very complete bibliography of the literature cited is appended. We venture to suggest, that it is a duty of all biologists to send copies of their published writings to the Library of the Imperial University of Japan, where they will be used and appreciated.

*Woman's Share in Primitive Culture.* By O. T. Mason, A.M., Ph.D. Pp. 286. (London and New York: Macmillan and Co., 1895.)

ANTHROPOLOGY the science of man—has been sadly neglected in the past, but there are signs that it will be more extensively studied in the future. We believe it was a president of the Anthropological Institute who pointed out, a short time ago, that while such societies as the Zoological, Geological, Linnean, and others were in a flourishing condition, the Institute which has for its object the study of man had only a membership of three or four hundred. This strange state of things is difficult to account for, though probably it is due to some extent to the absence of ethnological material to work upon in the British Isles. It is very well known that, in the United States, the Bureau of Ethnology publishes most elaborate reports upon anthropological topics; but the opportunities for such study in America are far greater than they are here. Prof. Mason is one of the foremost workers in the field of ethnology understood in its widest sense, and he is particularly qualified to trace the story of the part played by woman in the culture of the world. The volume in which he does this is the first of an anthropological series intended for the intelligent reader, but instructive enough to satisfy the student. The author describes the work of woman in all the peaceful arts of life, and shows that the past achievements have had much to do with the life history of civilisation. The book is very well illustrated, and is a desirable acquisition to the library of every one interested in woman's work. A large share of attention is given to women of American races; but as the author is curator of the Department of Ethnology in the U.S. National Museum, this might have been expected.

*A Text-book of Sound.* By E. Catchpool, B.Sc. Pp. 203. (London: W. B. Clive, 1894.)

AS an elementary text-book dealing with the physical processes which cause the sensation of sound, we think this deserves praise. It will certainly give the student the knowledge required before the more elaborate treatises can be read with profit. The author writes as a well informed teacher, and that is equivalent to saying that he writes clearly and accurately. There are numerous books on acoustics, but few cover exactly the same ground as this, or are more suitable introductions to a serious study of the subject.

*Optica.* By Prof. Eugenio Geleick. Pp. 576. (Milano: Ulrico Hoepli, 1895.)

THIS well-constructed manual will compare favourably with the best elementary text-books of optics. It is attractively designed, handy in size, and scientifically arranged. First the phenomena and theory of refraction, reflection, and dispersion are described; optical instruments form the subject of the second part of the book; interference and dispersion the third part, and optical phenomena of the earth's atmosphere, the fourth part. Various interesting notes, and a comprehensive bibliography, conclude the volume. The optics of astronomical instruments are treated much more fully than is usually the case in elementary text-books.

LETTERS TO THE EDITOR.

[The Editor does not hold himself responsible for opinions expressed by his correspondents. Neither can he undertake to return, or to correspond with the writers of, rejected manuscripts intended for this or any other part of NATURE. No notice is taken of anonymous communications.]

On the Liquefaction of Gases—A Claim for Priority.

EVER since the year 1883, I have been almost uninterruptedly engaged in the examination of the behaviour of the so-called permanent gases at very low temperatures. During the first few months I performed my experiments together with the late Prof. Włodzowski; afterwards, during a series of years, I was alone; and more lately, I went through several investigations with Prof. Witkowski. The results of my researches I published in the Polish, French, and German languages, whilst they were going on; in the *Reports of the Cracow Academy*, of the Vienna Academy, in *Wiedemann's Annalen*, and in the *Comptes rendus*. My researches are thus well known to the scientific world, and I may add, without boasting, that they have been acknowledged by learned men of different nationalities; they were also known to Prof. Dewar, who repeated them several times, and always confirmed my results—those, for instance, on the absorption spectrum and the bluish colour of liquid oxygen, and on the liquefaction of ozone.

Prof. Dewar at first duly acknowledged those of my experiments which he repeated, but afterwards he changed his behaviour, and in the lectures which he gave in the Royal Institution, and during which he liquefied large quantities of oxygen and air, he never again mentioned that his experiments were merely repetitions of mine, performed and published several years before. This is, perhaps, the reason why the English public, which attended those lectures, grew convinced that the liquefaction of oxygen, and other so-called permanent gases, has been achieved for the first time by Prof. Dewar; and it may be that the Rumford medal awarded by the Royal Society to Prof. Dewar, for the labours which I was the first both to perform and to publish, is due to those very lectures. That my labours should thus have been passed over in silence, is all the more astonishing, because as soon as the description of my apparatus, serving to liquefy large quantities of oxygen and air, was published in 1890, I sent him a reprint of it from the *Bulletin International de l'Académie de Cracovie*. A brief report of the apparatus is also contained in the *Beiblätter of Wiedemann* (vol. xv. p. 29), under the title, "K. Olszewski: Über das Gieszen des flüssigen Sauerstoffs."

There is here no space for me to enumerate all my investigations as regards the liquefaction and solidification of the gases in question; but I intend shortly to publish in the English language a more complete summary of my works, by which the English public will be enabled to see that only a small part of the researches which were performed by Prof. Dewar ought to be attributed to him. For the present, I will only state that all the so-called permanent gases (hydrogen alone excepted) were liquefied in quantity for the first time by me, and that I determined their critical points and boiling points; that nitrogen, carbon monoxide, nitric oxide, and methane were also solidified, and their freezing points determined. By means of solid nitrogen I obtained the *lowest temperature* that ever has been both obtained and measured, viz.  $-225^{\circ}$ . Many other gases and liquids were frozen, and their freezing points determined for the first time by me. I must finally remark that I also gave public lectures on the subject in Cracow; the first in 1890, during which I obtained, in the presence of over a hundred students, 100 c.cm. of liquid oxygen; the second in July 1891, during the Congress of Polish Naturalists and Physicians, and then I obtained 200 c.cm. of liquid oxygen in the presence of a good many naturalists, and showed its bluish colour and its absorption spectrum. The only reason that I have never hitherto employed a larger quantity of liquid oxygen or air than 200 c.cm. was the circumstance that this quantity was quite sufficient for my experiments; for my apparatus can be enlarged at will without changing anything in its construction. I have very often used large quantities of liquid oxygen and air whilst attempting to liquefy hydrogen, and to determine its critical pressure, as well as to inquire into the optical properties of liquid oxygen, as is proved by the whole series of researches, performed together with Prof. Witkowski.

CHARLES OLSZEWSKI.

University of Cracow, Austria-Hungary, December, 1894.

I HAVE read the letter of Charles Olszewski, and but for your courtesy in drawing my attention to it would have allowed it to pass without notice. Considering the Royal Society, in the year 1878, awarded the Davy medal to Cailletet and Pictet for their achievements of the liquefaction of the so-called permanent gases, it is hardly likely I could put forward in England any claim for such a result. A reference to the *Proceedings of the Royal Institution* between the years 1878 and 1893 will be sufficient to remove the suggestion that the apparatus I use has been copied from the *Cracovie Bulletin* of 1890. The work of the late Prof. Włodzowski has been fully acknowledged in England, and I am not aware of any injustice done to Charles Olszewski on account of the alleged omission of his subsequent investigations from public notice.

JAMES DEWAR.

The Term "Acquired Characters."

I AM afraid that as Sir Edward Fry has endeavoured to show that the explanation, given by Mr. Galton and accepted by me, of the term "acquired characters" is an absurdity when applied to the consideration of the question as to whether those characters can be transmitted by generation, I must proceed to convict Sir Edward of a loose and unwarranted use of language whilst availing himself of the plausible form of strict logical statements. I am a little disappointed with the value of the results hitherto accruing from the intervention of high judicial authority in a scientific discussion.

Sir Edward Fry asked for a definition of the term "acquired characters." From the observations which accompanied his request, it was evident that he wished for a statement of the meaning attached to the term when it is either asserted or denied that the acquired characters of a parent may be inherited by its offspring.

Mr. Francis Galton gave (and I accepted) as a brief explanation of the term the following: "Characters are said to be acquired when they are regularly found in those individuals only who have been subjected to certain special and abnormal conditions." I took the trouble to expand this explanation of the term at considerable length. Whether Sir Edward Fry has understood what was said, or not, is uncertain. Whether he has, or has not, he proceeds to state that this definition excludes the possibility of the inheritance of acquired characters, and renders the inquiry as to whether characters acquired in one generation may be handed on to the next by inheritance impossible! And therefore, according to Sir Edward, the definition is a worthless one for the present purpose. Sir Edward's argument runs: "Characters can only be found regularly either in individuals exposed to conditions which induce them, or in individuals which have inherited them. If then a character appears *only* in those individuals exposed to certain conditions, it does not appear in individuals by inheritance." That is perfectly correct; but where Sir Edward Fry is entirely wrong, is in his illogical assumption that the words "does not appear by inheritance" are equivalent to "is not transmissible by inheritance"; in fact, that "does not" means "never will or can." Surely when Sir Edward takes pains to use such a technical term as "identical proposition," he should remember the difference between "particular" and "universal." Mr. Galton's definition enables the observer to recognise and select for inquiry an acquired character, viz. one which is found in those individuals only which have been subjected to certain special conditions—that is to say, one which is at a given time and place so found. Nothing is said or implied as to future possibilities. It is the purpose of the inquirer to ascertain whether this acquired character can appear in a later generation as a transmitted character. In the specimens examined it *has not* yet so appeared. As Sir Edward justly observes, since it appears *only* in those individuals exposed to certain conditions, it *does not* appear in individuals by inheritance. But that has nothing to do with the question as to whether it *will or can* appear in individuals by inheritance. Accordingly the conclusion reached by Sir Edward Fry, that Mr. Galton's definition of the term "acquired character" reduces the proposition that acquired characters are not transmissible to an identical one, is erroneous, and due to a confusion by Sir Edward of a statement of what is observed at a particular moment with a statement of what must be for all time.

It should be noted that Mr. Galton's words do not furnish, or profess to furnish, a definition by which any character may be assigned to its class as either acquired or inherited. It may

well be doubted whether such a definition can be framed in the present state of knowledge. What Mr. Galton's definition or phrase does accomplish, is to point out *some* characters which may certainly be classed as "acquired" and not "inherited," and from the study of which we may accordingly start in the inquiry as to whether or not the acquired characters of one generation may become inherited in a subsequent generation. "Characters," writes Mr. Galton, "are said to be acquired when, &c." This by no means asserts that there are not other characters which should be regarded as acquired, if we knew fully about their history; for instance, at the very moment when our observation is being made on a group of individuals, some might conceivably be exhibiting a character inherited from the last generation, and other specimens might be exhibiting exactly the same character acquired *de novo*. Such cases (supposing that they ever occur) would not help us at all in the attempt to determine whether acquired characters are transmissible; and the fact that they are not included in Mr. Galton's definition (though their existence is not expressly denied) renders that definition a more practical one, and more useful to the experimental naturalist than a more comprehensive definition which could not be brought to a practical issue.

Lastly, it seems to me that Mr. Galton's definition is precisely what Lamarck pointed to in his "Première loi" and the first sentence of his "Deuxième loi." The reciprocally destructive nature of the propositions contained in those two laws I pointed out, in a former letter, and have not yet had the pleasure of seeing, in reply, any defence of Lamarck's position from one of his adherents. E. RAY LANKESTER.

Oxford, January 4.

#### Boltzmann's Minimum Theorem.

THE remarkable differences of opinion as to what the H theorem is, and how it can be proved, show how necessary is the discussion elicited by my letter on the oversight in Dr. Watson's proof. Each of the four authorities who have replied takes a different view.

Dr. Larmor enforces the view I put forward at the close of my letter, and says that the theorem *is* what I said appeared an *a priori* possibility; and I may here point out that his letter is a complete answer to the argument I used in the *Phil. Mag.* 1890, p. 95, urging that, as there were as many configurations which receded from the permanent state as approached it, there was an *a priori* improbability that a permanent state would ever be reached. This argument was criticised at some length, not really answered, in Messrs. Larmor and Bryan's Report on Thermodynamics (British Association Report, 1891), but the suggestive remarks there given helped me, I think, to arrive (independently) at the complete answer given in Dr. Larmor's recent letter. But my present use of the argument is not that which Dr. Larmor criticises; I now use it as a test of a particular proof of the H-theorem. I say that if that proof does not somewhere or other introduce some assumption about averages, probability, or irreversibility, it cannot be valid.

Mr. Burbury appears to consider that the theorem can only be proved if we assume that some element of the distribution does tend to an average (quite a different position from Dr. Larmor's), and he is as yet unable to state the appropriate assumption except for the case of hard elastic spherical particles colliding or "encountering," for since  $\epsilon$  is constant in his last letter, it seems as if the  $x, y, z$  coordinates are really dummies. Yet Mr. Burbury has already given what purports to be a *general proof* of the theorem for any number of degrees of freedom.

Mr. Bryan thinks that a condition which excludes the reversed motion is implied in Dr. Watson's proof, for he says that in taking unaccented letters  $F$  as proportional to the number of molecules passing from one configuration to another in the reversed motion, I make a less "natural" supposition than Dr. Watson, who takes accented letters  $F'$ . I cannot see what virtue there is in putting accents on or leaving them off, and after a very careful study of Mr. Bryan's letter, I can only think that he has fallen into some confusion owing to the way in which he uses at one time *accented* and at another time *unaccented differentials*, although (as he himself remarks) there is no difference whatever between these accented and unaccented *probabilities*. But even if Mr. Bryan be right, would I be put us any "farther"? What we want is a *proof* that the collisions will make H decrease, and we can hardly be satisfied with a proof

which depends on the previous assumption that the particles do "naturally" tend to move in the desired way.

Dr. Watson meets my reversibility argument by saying that H decreases even in the reversed motion, when the system is confessedly *receding* from its permanent state. No other correspondent agrees with him in this view, which would indeed *take away all physical meaning from the H theorem*, for the decrease of H would then be quite unconnected with the approach to a permanent state. As to the other point, Dr. Watson does not amend his proof himself, but says it is "easy" to do, and so does Mr. Bryan. Yet one has an instinctive distrust of things which are said to be "easily seen," and at all events Dr. Watson's reference to the case in which the theorem is *applied* does not help one in the *proof*, where it is necessary to express *separately* the products of the differentials expressed by the small and capital letters respectively in his "Kinetic Theory."

Mr. Burbury asks why I say the error law has been proved for the case of hard spheres without the use of Boltzmann's Minimum Theorem. I thought Tait had done so (*Trans. R.S.E.* 1886), and at all events I thought the ordinary investigation showed that there was but *one* solution, that of the error law, in that case; but perhaps I am mistaken.

Mr. Bryan says Lorenz gives the clearest account of the assumptions in Boltzmann's theorem. He would earn our gratitude if he would state them in his next letter.

EDW. P. CULVERWELL.

Trinity College, Dublin, December 29, 1894.

#### Aurora of November 23, 1894.

OBSERVATIONS of this aurora, by Mr. James T. Pope, at Dingwall, in the north of Scotland, have been sent to me by Mr. H. Corder, of Bridgwater, a few particulars having also been recorded here of the appearance, which, although the distance of this place from Dingwall falls but very little short of 400 miles, yet showed some very excellent agreements with Mr. Pope's description.

Beginnings of the aurora were seen by Mr. Pope between 6 and 7 p.m., as a glow which brightened gradually along the eastern, and sent up a few faint streamers from the western parts of the horizon towards the north, until 6.30, gradually fading out, after that, till nearly 7 p.m. The glow then gradually reappeared as a bright band, brighter in the east than in its western half, stretched across the sky from east to west, somewhat southward from the zenith. This band of light continued very bright for some time, but faded out gradually towards 7.30, the streamers in the north-west at the same time increasing continually in brightness.

Near Slough the display was first noticed about 7.15 p.m. as a low ill-defined white bow, stretching, at about half the altitude of those stars above the horizon, from under  $\zeta$  to under  $\nu$  Ursæ Majoris (altitudes 19 and 24, azimuths 13 W. and 16 E.) from north). A little later, towards 7.30 p.m., this arc had become a bright narrow band, a degree or two in width, and about 25° long, extending from  $\eta$  Ursæ Majoris in the west (altitude 15, 19 W. of north) to a few degrees under  $\gamma$  and  $\beta$  Ursæ Majoris (altitudes 16 and 10, 2 W. and 6 E. of north) on a slightly downward slope to some degrees eastward from the latter star. It faded out partially about 7.30 p.m., leaving two bright remnants across  $\eta$ , and under  $\beta$  Ursæ Majoris, each about S. long, while a third just similar wisp of light appeared on the same line's far leftward prolongation; this western offshoot of the band continued with the other two short segments till all had faded out at 7.45 or 7.50, marking the arc's considerable but not otherwise traceable extension westwards, across  $\epsilon$ ,  $\zeta$  Herculis (altitudes 17 and 15, 60 and 55 W. from north).

Dingwall is about 390 miles distant from Slough, in the direction 18 or 19° west from north; so that it appears that the strong part of the glow-band seen most brightly in the east from Dingwall, was alone observable here (if we except the light-wisp in Hercules towards the west, at last), in the vapoury sky near the horizon.

Beginning with an average altitude of between 9½° and 12°, or of about 11, at 7.15, the band in growing stronger reached an altitude, at Slough, of 14° or 15 towards 7.30, during about the space of time when it was most distinct, and seen most strongly in the east at Dingwall extending from east to west somewhat southward from the zenith. If its altitude there was at that time about 60, and at Slough about 13°

above the south and north horizons, respectively, of those places, making the considerable corrections needed by the earth's curvature in the 6° of latitude between them, the resulting height of the luminous arch appears to have been about ninety-five miles above a place about fifty miles south of Dingwall. But the times of observation and the altitudes used being only roughly assigned, and only somewhat vaguely comparable together, an uncertainty of, it may be several miles, must no doubt attach itself to this determination.

Two very slender and fugitive streamers only were seen at Slough to rise from the horizon-glow before half-past seven. But between about 7.35 and 7.40 p.m. a dense tuft of them, 8 or 10° wide, rose from a low, faint light-band then visible at about half the altitude of the short arch-segment across  $\zeta$ ,  $\eta$  Urae Majoris, crossing and enclosing that wisp of light, to about half as high again as the wisp's altitude from the horizon. This pillar of light grew faintly red before disappearing, which it did in three or four minutes after springing up, while the rest of the glow and the wisps (the one in Hercules being the last one to be seen) also faded away entirely between 7.45 and 8 p.m. The distinct light-band and the tuft of reddish streamers were the only conspicuously bright phases seen at Slough in the aurora of November 23, between 7.15 and 7.45 p.m., with the exception of the two very faint and slender streamers which rose suddenly to a great height across Ursa Major at about 7.30 p.m.

The base of the pillar-like projection, resting on the faint lower light-bow, was at about 8°, and its summit when highest at about 24° above a part of the north-western horizon between 8 or 10°, and 18° or 20° west from north. Its western side would thus be just vertically over Dingwall, if the lower arch which formed its base was at the same time in the zenith of the latitude of Dingwall; and this, it seems quite probable was actually the case, from the following description of the closing scene, by Mr. Pope, of the aurora's progress after the main belt of light had broken up and dispersed itself, at about 7.30. He writes: "At 7.30 p.m. the glow had almost disappeared, while the streamers at this hour were most intensely bright, and appeared to radiate from a small and distinct part of the sky situated in R.A. 358°, Decl. 43° north. Previous to 7.30, no streamers had been observed to radiate towards the south, but between this time and 8 p.m. streamers were seen radiating from the aforesaid part in all directions. After 8 p.m. the display gradually faded out, and at 8.30 very little trace of it could be seen. The appearance at the apparent radiant point when the display was at its height was most interesting; appearing sometimes as a solid mass of aurora, then suddenly breaking up into fragments, and assuming most curious forms, uniting again, and so on. Not the slightest trace of the display was visible at 10.30 p.m."

The altitudes of 8° and 24° observed at Slough, at the base and top of the dense column of reddish streamers, nearly in the direction (as described above) of Dingwall, must evidently have related as directly and definitely to this fine display of radiation in the north of Scotland, as the foregoing altitudes at Slough of the bright band of light, before 7.30, seemed clearly and obviously to supply good means for determining approximately the band's real height, by comparing them with Mr. Pope's description of his view of the same band at Dingwall.

Making the same needed correction, as before, for the diminution brought about upon the apparent altitudes observed at Slough by the effect of the earth's curvature, we may thus deduce a resulting real height of 75 miles above the earth's surface, approximately, at the bases, and of 193 miles, approximately, above the earth for the summits of the streamers which clustered over the neighbourhood of Dingwall, and produced the magnificent spectacle of the auroral corona in that part of Scotland.

Should notes have been fortunately preserved at any other towns in Scotland at considerable distances from, and especially in lower northern latitudes than Dingwall, of the aspect, times and bearings, or astronomical positions of this short but bright aurora's rather peculiar features of development in its transient display, much better conclusions regarding the real positions and the extent and distribution of the spectacle might, without doubt, be gathered from them, than those above roughly extracted from only very slight descriptions. But the roughly reached results of the heights of the appearance may yet, for the present, not be entirely worthless, on account of the scarcely doubtful identities of the aurora's bright features, which

were recorded most dissimilarly in this rather surprising instance, at two so very extraordinarily far separated places.

A. S. HERSCHEL.

Observatory House, Slough, December 24, 1894.

#### Peculiarities of Psychological Research.

ON page 200 I see that Prof. Karl Pearson suggests that it would be a good exercise for some one with a strictly logical mind and plenty of leisure to criticise "the products of the chief psychological researchers." May I say, as a member of the S.P.R., speaking for myself and fellow-workers, that we ask nothing better than such a studious and searching criticism. One of our main difficulties is that our critics will not take the trouble to study or even read our evidence, but are content to ridicule what they conjecture to be our methods and results from so great an altitude of assured contempt, that we fail to recognise ourselves in their travesty, and are therefore unable to derive much benefit from their utterances.

Thus, for instance, Prof. Karl Pearson, before writing his recent letters, has evidently not taken the trouble to refer even to the abbreviated summary of certain card-drawing experiments contained in Mr. Podmore's little book; otherwise he could hardly make the statements he does concerning the S.P.R. record of them.

He objects to M. Richet's results as giving insufficient odds in favour of telepathy, so that, as he says, it shows want of acumen to adduce them. Would he then regard it as more scientific to suppress them? On the other hand, the enormous odds against chance, shown in Mr. Gurney's trials, he also says, on page 153, show a want of acumen (I don't know why, but I expect because nothing could possibly exhibit anything else on the part of an S.P.R. worker), and that such odds might be otherwise accounted for. Does he then suppose that the odds of, as he reckons them, two thousand million to three are accepted by us as the odds in favour of telepathy? Probably he does, because there is at present no need to be fair to investigators in an unorthodox field; but Mr. Podmore is careful to state the opposite, as follows (footnote to p. 27 of Mr. Podmore's little summary, in the *Contemporary Science Series*, of the evidence for Thought-transference so far as it exists at the present time): "Of course the statement in the text" [viz. that "the probability for some cause other than chance deduced from this result is '9999998'"] "must not be taken as indicating the belief of Mr. Edgeworth, or the writer, or anyone else, that the above figures demonstrate thought-transference as the cause of the results attained. The results may conceivably have been due to some error of observation or of reporting. But the figures are sufficient to prove, what is here claimed for them, that some cause must be sought for the results other than chance." And another quotation may be permitted from Mr. Podmore's preface, which ought to silence irresponsible detractors like Mr. H. G. Wells, and others, who seek to lead the world to suppose that we have some cause at heart other than the simple ascertainment of the truth, whatever it is, and that Mr. Podmore, in particular, is a bigoted upholder of the certainty of telepathy. This is the quotation: "The evidence, of which samples are presented in the following pages, is as yet hardly adequate for the establishment of telepathy as a fact in nature, and leaves much to be desired for the elucidation of the laws under which it operates. Any contribution to the problem . . . will be gladly received. . . ."

Now, I observe that Prof. Karl Pearson has a contribution to the problem, for in NATURE of December 27, 1894, p. 200, he refers to certain experiments of his own, wherein by pure chance he obtained results against which the theory of probability also gave large odds. Would he be good enough to let us have these results more precisely, as recorded at the time and signed by witnesses, so that they may furnish us with an example of the methods of a "real scientific investigator"? It will be very unsatisfactory if we have nothing but his memory to rely on for the facts; and as he well knows, it is necessary to have the whole of a large number of trials before deductions from the theory of probability are legitimately applicable.

I observe, finally, that Prof. Pearson, with plenty of good-nature but some lack of originality, has refurbished Dr. Carpenter's old joke about an "ortho-Crookes" and a "pseudo-Crookes," and has directed it against me. I shall be well content if he never manages to find a keener and more effective weapon.

OLIVER J. LODGE.

Liverpool, December 29, 1894

## THE STUDY OF CLOUDS.

THIS monograph has been long and anxiously expected by all who take an intelligent interest in the advance of meteorology, and recognise the long and

think that moisture condensed into cloud can only be driven or rolled about in a limited number of ways, and hence but few really distinct varieties of cloud can be formed, our author subdivides the process of cloud formation under several heads. The process which he terms "interfret" seems very nearly allied to the Luftwogen of Helmholtz, though there is no mention of this authority in the text. Mr. Ley states that when approximately horizontal currents of air differing in velocity and direction move over one another, an intermingling of the particles will result, accompanied by whirls, ripples, and waves, varying in size and shape according to the velocity and direction of the current. This effect he attributes to friction, and this seems to be the chief difference between him and the German physicist, who sees a more complex problem in the mixing of two fluids of different specific gravities. If the colder current is uppermost, the resulting action is called "interfret"; if the warm moist current is above, then "reversed interfret." To clouds formed by the descent of moist particles through warmer and denser air, the term "inclination" is applied, and the final nomenclature adopted rests on subdivisions of these classes of formations.

An adequate nomenclature of clouds has long been, and we think it may be said, is still, a desideratum. Luke Howard's terms still survive, and after nearly a century's use cannot, and will not, be entirely superseded. Stratus, cumulus, and cirrus have too strong a hold on



FIG. 1.

profound study that the Rev. Clement Ley has made of this subject. It is with great regret that we notice that the preface is signed by a member of his family, and that the zealous and energetic watcher of the clouds has not been able to see his own work through the press.

We have in this book to do emphatically with Mr. Ley's own observations, his own theories of cloud structure, and his own nomenclature. Although the author acknowledges in the preface the valuable assistance that he has received from the works of other writers, it is curious to notice how seldom in the text these authors are referred to by name. One cannot be protesting that it would have added much to the interest, and the instructive character of the book, if Mr. Ley had systematically drawn attention to the work of those who have laboured with successful industry than he has in this department, if he had exhibited the points of difference from, and support given by, other observers, such as Auercomb, Hildebrandsson, Weibull, and a host of other authorities, who seem'sometimes almost ostentatiously ignored, it is seen that Mr. Ley does not care anything approaching a history of the subject, either on the theoretical or on the practical side. Opening with a preliminary chapter on the atmosphere and the movements of vapour-laden air, we have the general principles of cloud formation explained. Although we have been accustomed to



FIG. 2. Clouds, cumulus, and cirrus in light.

the vocabulary to be dislodged, and however much they may be subdivided, they must remain the basis of classification. Mr. Ley therefore retains these terms, but an eye educated by some fifty years of constant study, has

Received for review 27th Dec. 1894. Printed by RICHARD CLAY AND COMPANY, BUNGAY, SUFFOLK.

seen and learnt to recognise many varieties of shape and form, arising possibly from real differences of structure, which require distinctive appellations, and make the description somewhat cumbrous. To quote the entire list of subdivisions would occupy no small space. Leaving out of the question fog, which is itself divided into three classes, we have the clouds of interjet, inversion, and inclination, each subdivided into five different varieties. To this list, large as it is, must be added several additional subdivisions, all presenting marks of dissimilarity, and it is suggested, typical of special states of weather in different portions of the globe. Each of these classes is described at considerable length, and many of them are admirably illustrated, both by coloured plates and photographs. We have recently reproduced (NATURE, vol. xlix. p. 342) some admirable specimens of cloud photography, due to S. Manucci of the Vatican Observatory, illustrative of the distinctive characteristics of cloud formation. Mr. Arthur Clayden has secured some very admirable specimens, worthy to be classed with those of the Italian artist. We give in Figs. 1 and 2 the reproduction of the same cloud (cumulo-nimbus) after an interval of ten minutes, in which the shifting character of clouds is well illustrated. The truthfulness to nature is shown very conspicuously in an evening picture of the same variety of cloud (Fig. 3).

But the important question is, will illustrations, however carefully executed, give to persons of ordinary intelligence that insight into cloud structure which enormous experience has given to Mr. Ley, and enable them to discriminate with facility and certainty between the various classes? The author raises the objection, not as existing in his own mind, but as having been suggested to him by others whose opinion he values, that the classification here presented is too complex. We would respectfully associate ourselves with those who have suggested this doubt. Mr. Ley's contention is, that greater simplicity of description might induce a larger number of observers to contribute something, but that the *value* of the whole mass of such observations would be of small amount, through however long a space of time they were continued. The main value consists in the evidence it affords of the different forces at work in the air, and its consequent trustworthiness as a weather guide, and on this point there will be many different opinions. The same description of cloud does not prognosticate the same weather in all countries, or at all times in the same country. The method and cause of development are as important as the character of the cloud itself. Cumulus may sometimes be the promise of a fine day, or prove the precursor of a shower. A man who "forecasts" by the clouds alone, is in the same position as a man who relies on the indications of a wheel barometer. He simply considers one variable in a very complex result. But Mr. Ley looks forward to a time when every man shall be his own "weather prophet," and when every individual and institution may be provided with weather telegrams and the means of correct and intelligent interpretation. In the multitude of counsellors so created there may be wisdom; there will certainly be confusion.

Waiting for this consummation, it seems most desirable that the same kind of cloud should be called by the same name by all observers; and simply having regard to

the main divisions, it will be admitted on all hands that this amount of progress has not yet been effected. We have then to consider whether this book, valuable as it is, will promote this end, and we are afraid that it will prove an edged-tool to beginners. To the advanced student it can easily be understood that this work is most welcome, but there still seems necessary a simpler system to serve as an introduction for the tyro. Mr. Ley may very well say that he addresses himself only to skilled observers, and to some this will be a sufficient defence, but this skill is not easily acquired, and we look for a graduated system, along which a student may advance confidently and scientifically. Abercromby and Hildebrandsson recognise and would recommend a classification of ten divisions, a system of which we believe the author disapproves. Captain Wilson Barker would, if we understand his arrangement correctly, still further simplify this system, and therefore it does not seem impossible to lead the student along an easy incline in which he would gradually accumulate experience, rather than plunge him at once into the subtleties and pitfalls which Mr. Ley prepares for the beginner.



FIG. 3.—Cumulo-nimbus (evening).

It is easy to understand how difficult a problem was submitted to the International Meteorological Committee when they were asked to adopt and sanction a uniform nomenclature of clouds, and how prudent they were in declining the invitation (NATURE, vol. xxxviii. p. 491).<sup>1</sup> Simply having regard to the fact, that meteorologists are generally agreed that the same cloud forms and cloud structure are to be met with all over the world, it would seem that an International Congress was admirably adapted for the settlement of such a scheme. But it was felt, and the feeling will be still more general after the perusal of Mr. Ley's book, that our knowledge of the physical and structural process of cloud formation is in a progressive state, and therefore final classification impossible. Mr. Ley would probably be the last to consider that his book possesses the element of finality. He has not only learnt and taught much, but he has also learnt, better than most of us, how much more there is to learn.

W. E. P.

<sup>1</sup> This subject is still engaging the attention of an International Congress (See p. 185.)

## SIR CHARLES NEWTON, K.C.B.

THE hand of death has lately fallen heavily on the ranks of the older scholars; and classical archaeology has especial losses to record. Only a few months back, there passed away Heinrich Brunn, the *doyen* and most picturesque representative of German Hellenism; and we in England have now sustained a loss no less severe. Though Newton had of late years become too infirm for active work, and had in fact done little since his retirement in 1835, it is now, when he has gone from among us, that his loss will be most keenly felt. It was not so much in his actual achievements, though these were considerable enough, that his truest claim upon our recollection lay; nor yet in the fact that he had practically opened up a new science for English scholarship; it was more than all in the personality and force of character of the man, which impressed itself on all with whom he came in contact, and the masterful influence which was by no means confined within the limits of his own science. It was to this that he owed his success; and there have been few instances in which a necessity has been so opportunely met by the man most adapted for it. For when Newton joined the Museum in 1840, the study of actual monuments was still in its infancy; Greece itself was very little known, and a pseudo-classicism had been evolved from the mistaken illustration of literary sources with an often inferior Græco-Roman art. Behind him lay the period of learned and ingenious but useless theory; two things were needed to clear away this tangle of ideas—a fuller supply of the best practical material, and a wider scientific method.

At that time the Departments of Antiquities at the Museum, which now are four, were all united in one. The disadvantages which such an arrangement must have entailed are obvious enough, but there was this compensating advantage, that a young man in Newton's position was at the outset enabled to attain a certain familiarity with the wider aspects of his study, and perhaps a breadth of view and sympathy which is more difficult at present. He was thus by his training, as well as by his natural bent, led to a large view of things.

In an address to the Archaeological Institute at Oxford, in 1850, he urges a powerful plea for the comparative method in archaeology and, as the necessary corollary, for enlargement of museums. In this address, which as an archaeological teaching was singularly in advance of its times, the writer has laid down the formulæ upon which the modern science of archaeology may be said to take its stand. A museum must not be a mere collection of disjointed, disconnected phenomena, but the central consulting-room, as it were, to which all scientific questions may be referred for comparison and elucidation. Classical art and archaeology, like all other studies, cannot but lack perspective in isolation: the external conditions, the ethnographical characteristics, the position of the Hellenic race in its relation to the rest of mankind, their art, architecture, life, and thought must be collated and classified with a due regard to the continuity and correlation of things. The archaeologist, in short, "must travel, excavate, collect, arrange, delineate, decipher, transcribe, before he can place his whole subject before his mind. But the plodding drudgery which gathers together his materials must not blind the critical acuteness required for the classification and interpretation; nor should that habitual suspicion which must ever attend the scrutiny and precede the warranty of archaeological evidence give too sceptical a bias to his mind." The key-notes here sounded were kept steadily in mind throughout his whole life. It was but a few years after, that his sojourn in the East, as consul at Mytilene, enabled him to put his ideas into practice, and to initiate for England the "era of the spade."

The discovery with which Newton's name will always be inseparably associated is that of the Mausoleum at Budrum, collections from which now fill almost an entire room at the British Museum. Budrum had been visited by Prof. Donaldson early in the century, and the presentation to the Museum, in 1846, of the twelve slabs removed from the castle of the Knights of St. John, had called renewed attention to this monument. In 1847 Newton published a memoir, in which Donaldson's site was selected as that which probably concealed the ruins—a conjecture which other travellers contemptuously rejected. It was not till 1857 that Newton was enabled to verify his conjecture by actual digging, and the account which he gave of his discovery, in his "Travels and Discoveries in the Levant" (p. 86), is one of the most fascinating episodes in a fascinating book. Even when the site was thus determined beyond all doubt, the difficulties had only begun; the obstacles of Turkish officialism and native greed were enough to have broken the heart of a less indomitable energy; but his own untiring efforts, backed by the friendly assistance of Lord Stratford de Redcliffe at Constantinople, brought the undertaking to a well-merited success.

Lord Stratford was only one out of many friends whom Newton succeeded in enlisting in the cause he had at heart; he had pre-eminently the priceless faculty of inspiring others with his own enthusiasm; possessed of considerable social gifts, he was enabled to make many friendships, which served him in good stead both at home and abroad. If a special grant were required, whether for excavating a promising site, or for enriching the Museum with an important collection, he rarely failed to wring a reluctant consent from a Treasury too apt to neglect any cause which is not sufficiently self-assertive. During most of the period of his keepership he was thus able to maintain or to encourage enterprise or exploration abroad, set on foot by men who had caught the infection of his energy in personal contact with himself. Smith and Porcher at Cyrene, Dennis at Benghazi, Pullan at Priene, Salzmann and Biliotti at Budrum and Rhodes, Wood at Ephesus, and, more recently, Ramsay in Asia Minor, all owed the initiation of their enterprise, or very material support, to Newton at home. Perhaps one of his most solid claims to our gratitude lies in the fact that he was thus instrumental in obtaining no less a sum than £100,000 in special grants for the purchase of collections for the British Museum, over and above the annual sums voted by Parliament. Of these the most important was probably the great Blacas collection in 1867, a transaction which is admirably illustrative of Newton's resourceful self-reliance and power. The French Government (and probably others also) were known to be inclined to treat for the collection, and the English representative had at short notice to determine a sum which should be at once enough to carry the position, and yet not be deemed extravagant. Newton telegraphed on the Friday to Panizzi; next day the trustees of the Museum met, Disraeli came purposely to the meeting, and the historic treasure was ours.

To his energetic guidance the Hellenic Society and the British School at Athens both owe in a large degree their initiation and their present position. It was indeed in such practical initiation, and in the inspiration of others rather than in actual teaching, that Newton's true sphere lay. Yet all who know his writings, and still more those who had the privilege of personal intercourse with him, will acknowledge the debt they owe to his teaching, either direct or indirect. To any one regarding the period over which his activity extended, from a time when archaeological science was, as it were, casting its skin, down to the complete transformation of to-day, to any one who knows the masses of now useless literature which form the cast-off slough, it is really astonishing to turn



to Newton's "Essays on Art and Archæology," and to see how fresh and how living the opinions expressed even more than forty years ago still remain. Though cautious sagacity and a conservative temperament were his prevailing characteristics, yet when the occasion needed he could speak with no uncertain voice; it is a remarkable fact, for instance, that his article on the epoch-making discoveries of Schliemann, written at a time when the attitude of scientific men was still undetermined or opposed, remains to-day, so far as it goes, an admirable exposition of the subject. His attitude on such subjects was specially characteristic of his favourite study—Greek epigraphy—for which a man needs a wide range combined with a patient methodical accuracy. He might, indeed, have said of himself, with his great contemporary, Brunn, "In a critical discussion I would rather err methodically than hit upon the truth without method": a golden watchword for this age of hurry and competition.

NOTES.

PROF. RICHTHOFEN has been elected a Correspondent in the Section de Minéralogie of the Paris Academy of Sciences.

DR. D'ARSONVAL has been appointed to the Chair of Medicine in the Collège de France, in succession to the late Prof. Brown-Séquard.

THE death is announced of Dr. Josef Schroter, Professor of Bacteriology in Breslau University, and distinguished for several important researches in the domain of botany. Among the deaths of other foreign scientific men are: M. Stieltjes, the eminent Professor of Pure Mathematics in the Toulouse University; Dr. C. Studiati, Professor of Physiology in the University of Pisa, and Dr. J. G. Brinton, at Philadelphia. Dr. Brinton was known for his botanical works.

PROF. BLAKE has been appointed by the Government of Baroda to the temporary Directorship of the newly-built State Museum at Baroda, and sails this week for India.

MR. J. E. DURDEN, Demonstrator of Biology at the Royal College of Science, Dublin, has been elected Curator of the Institute of Jamaica.

THE Paris correspondent of the *Lancet* reports that arrangements have been made at the Pasteur Institute for the immediate despatch of tubes of anti-toxic serum to any part of France. It will thus be seen that M. Roux and his assistants have not been idle. Indeed, both the Institute authorities and the public have worked with a will; the latter having, through the *Figaro*, and by means of gifts made directly to the Institute contributed up to December 31, 1894, no less a sum than 611,000 francs (£24 440). This does not include 100,000 francs (£4000) just voted by the Chambers, and which will doubtless become an annual subsidy. The Institute now possesses, for immunising purposes, a stud of 136 horses, a total that will probably be ultimately increased to the maximum of 150. Of these, twenty are kept by the Municipal Council of Paris at a cost of 20,000 francs (£800) a year, for the benefit of the Paris hospitals and poor. At Villeneuve-d'Étang—a property ceded by the State to M. Pasteur in 1886—there are seventy-nine horses cared for by a capable veterinary surgeon and his staff. That the animals flourish under the *régime* of good feeding and periodical bleedings adopted, is proved by the presence in good health at Allort of a sturdy Brittany pony which has hitherto supplied no less than 420 litres of blood.

THERE will be a special technical meeting of the Royal Geographical Society, in the Map Room of the Society, on Tuesday, January 22, at 4 p.m., when Prof. A. W. Rüchker, F.R.S., will read a paper on "Terrestrial Magnetism."

AN Austrian polar expedition is being organised by Herr Julius von Payer, with the view of securing the artistic repre-

sentation of the physical features of the east coast of Greenland. The actual work will begin in latitude 74°, and will extend beyond latitude 77°. It is anticipated that the expedition will be ready to start in June 1896.

THE weather has continued very disturbed over the British Islands during the past week; northerly gales have occurred with considerable frequency on our northern and western coasts, but the conditions have been quieter than of late over the southern portion of the kingdom. Heavy snow has fallen in Scotland, causing serious interruptions to the railway and telegraphic services; snow has also fallen in many other parts of the country. Sharp frosts have occurred in the Midland districts, as well as in the north and east; and on Tuesday the thermometer in the screen registered 19° at Wick, while ten degrees of frost occurred in several parts of the United Kingdom.

THE study of the "ejected blocks" from a volcano is a peculiarly interesting one, for by the careful piecing together of evidence much may be learnt of the internal processes which accompany the outward and visible eruptions. This study has been undertaken by Prof. Johnston-Lavis for Monte Somma, and some recently published papers contain a portion of the results at which he has arrived (*Transactions Edinburgh Geol. Soc.* vi. 314). Of the many varieties of stratified rocks that have been torn off from the walls of the volcanic chimney by the rising lava, those of Tertiary age show the least metamorphism; while in the deeper-derived Cretaceous limestones all stages of metamorphism are to be found. The earliest changes appear to be the carbonisation of any organic matter to form graphite, and the recrystallisation of the calcite in larger grains. Then as interchange of constituents takes place between the limestone and the metamorphosing lava, various lime-silicates appear in a fairly definite order, until finally we have formed that great variety of minerals for which Monte Somma has long been famous. The occurrence of *periclase* (MgO) is of interest in view of the abundance of hydrochloric acid among the gases emanating from Vesuvius, for that mineral is artificially prepared by heating magnesia in hydrochloric acid gas. Many of the minerals formed under these conditions of metamorphism tend to decompose rapidly under more normal conditions, and associations of serpentine, tremolite, brucite, &c., are formed, such as are well known in areas of regional metamorphism.

THE analogy between these Vesuvian blocks and certain Archaean rock-masses is carried to a striking extent in a further paper, in the authorship of which Dr. J. W. Gregory joins with Prof. Johnston-Lavis (*Trans. Roy. Dublin Soc.*, vol. v. ser. ii. No. vii.). Here many specimens are described which show in the most complete manner the association of characters that led to the belief in the organic nature of the Canadian *Eozoon*. The authors consequently suggest that the Eozoon structure in its typical localities was developed in the limestones by the contact metamorphism of the associated crystalline rocks—a view which, they point out, is in harmony with the conclusions arrived at by Prof. Lawson on purely stratigraphical considerations. The disproof of the organic nature of Eozoon may therefore be considered complete.

THE disease of Anbury, or Finger and Toe, is met with wherever the turnip crop is cultivated, but it is probably nowhere more destructive than in the north of England. An experiment bearing on the disease, briefly described in the *Journal* of the Royal Agricultural Society, by Prof. W. Somerville, will therefore interest all agriculturists. The experimenter emphasises the fact that the disease is extremely infectious, and may be easily induced by inoculating a soil perfectly sound with soil from a diseased field. Such diseased soil, however, may be easily disinfected by lime, a fact which points to the patho-

logical phenomena being due to an organism—presumably *Aspergillus glaucus*. This being so, too great care cannot be taken to prevent soil or diseased roots being conveyed from one field which is diseased to another which is sound.

A SOCIETY which has a total of more than eleven thousand governors and members, may fairly be said to be in a flourishing condition. Such is the Royal Agricultural Society; and with so great a membership, it is no wonder that a large amount of important work is carried on under its auspices. The current quarterly *Journal* of the Society has among its contents special articles on the rotation of crops, light railways, and the trials of oil engines at Cambridge. It also contains the annual reports of the consulting chemist, Dr. J. A. Voelcker; the consulting botanist, Mr. W. Carruthers, F.R.S.; and the zoologist, Mr. Cecil Warburton. The report of the Council shows that in the Department of Comparative Pathology and Bacteriology, established at the Royal Veterinary College by the aid of a grant from the Society, the work in the research laboratory has included investigations on tuberculosis, diphtheria, anthrax, and other diseases, and the use of mallein and tuberculin for the detection of glaucers and tubercle in the earliest stage. The further experiments which have been made, have materially strengthened the evidence in favour of both agents as aids to diagnosis in doubtful cases of disease. We note that the Council have elected as an honorary member of the Society, Prof. W. Fleischmann, Director of the Agricultural Institute of the Royal University of Königsberg, in recognition of his distinguished services to European agriculture. The annual country meeting of the Society will be held this year at Darlington; Leicester has been chosen as the place of meeting for next year.

EVERY naturalist is acquainted with the elaborate spring-like mechanism by which the woodpeckers and humming-birds are enabled to protrude their tongues with such rapidity for the capture of insect prey. These remarkable instances of adaptation have been more than once described, and some other special modifications of the avian tongue and its bony supports will be recalled by ornithologists. In a recent number of *Der Zoologische Anzeiger* (Frankfurt, xxvi, November, 1894), Herr Henckling-Peters re-describes these cases after a renewed investigation, and also supplies a quantity of interesting information on the form of the tongue and hyoid apparatus of birds in general. The old idea that the woodpecker transfixes its prey with its sharp-pointed tongue is probably not yet extinct, but Herr Peters offers his opposition to this opinion, and states that the insects are firmly attached to its tongue by the sticky secretion with which its surface is copiously covered. Although the form of the tongue usually corresponds to the shape of the bill, there are exceptions to this in cases, for example, in the waders, waghshers, and hoopoes, which, in spite of their long bills, only possess minute, pointed tongues; in the pelican, indeed, the tongue is altogether rudimentary. In most birds, whose bill consists of two parts, the tongue is dart- or awl-shaped; in others, especially in the雁, vermiform or tubular. In some birds, such as the owl, which swallow their prey entire, the tongue is broad and flattened, like a shovel. In the hedge-sparrow, hatter, woodcock, and others, the tongue is bifid or trilobed at the tip, while in the honey-creeper the tongue is split into a comb-like, webbed form, and is used for actually sipping the nectar from the flowers. In the respective little blue hare, swainson, and many other species, the tongue is thick and fleshy, and of a horny texture, probably to be even suspected of possessing a certain amount of calcification. Herr Peters concludes his paper by referring to a paper by himself on the influence of the form of the tongue in relation to the vibrating powers of

articulation. It is interesting to note that the parrots, the form of whose tongues most closely resembles that of man, are able to imitate his language more nearly than any other birds.

THE first number of the *Botanisches Centralblatt* gives, from the annual report of the Société des touristes du Dauphiné, an account of the various attempts to establish Alpine botanic gardens in the Jura, Tirol, Syria, the Bavarian Alps, Switzerland, &c.

THE number of *Bonnier's Revue Générale de Botanique* for December 15, 1894, contains a biographical sketch of the late Prof. Daehartre, with an enumeration of his contributions to physiological, morphological, and systematic botany, amounting to 240 papers or separate publications.

THE first part is published of the *Jahrbuch für wissenschaftliche Botanik* under the new editor-ship of Prof. Pfeffer and Prof. Strasburger. It contains the following papers:—"Investigations on Bacteria," by Dr. A. Fischer, and "Physiological investigations on the formation of callus in cuttings of woody plants," by Herr H. Titmann.

LORD LILFORD'S "Coloured Figures of British Birds" have now reached their twenty-ninth number, and contain a series of excellently-drawn chromo-lithographs of our native species. Four or five more parts are required to finish the work, which, when arranged, will fill ten or twelve crown-octavo volumes.

THE veteran naturalist, Dr. R. A. Philippi, of Santiago, has just issued an illustrated memoir, in quarto, on the stags of the Andes, which will form part of the "Annals of the National Museum of Chili." Besides the two ordinarily recognised species of the sub-genus *Favosites*—*Cervus chilensis* and *C. antisensis*—Dr. Philippi describes a third species, *Cervus brahyceeros*, from Northern Peru, which appears to be well established.

THE birds of Bulgaria and the adjacent provinces of Turkey have, hitherto, been little investigated by European ornithologists, and are consequently imperfectly known. A good contribution to our knowledge of this subject has just been made by the publication of Reiser's "Ornis Balkanica." The author is Custos of the Museum at Sarajevo, in Bosnia, and has travelled extensively in the Bulgarian provinces.

THE 119th number of the *Biotogia Centrali Americana* of Messrs. Godman and Salvin, which has recently been issued, contains continuations of the "Birds" by Messrs. Salvin and Godman, of the Coleoptera by Dr. D. Sharp and Mr. Champion, of the Hymenoptera by Mr. Cameron, and of the "Butterflies" by Messrs. Godman and Salvin, all illustrated by coloured plates of the highest excellence. Various subjects are in progress, and there can be no doubt that the work, when complete, will give us an account of the zoology of an important region of the New World, executed in a style and with a completeness which has hardly ever been approached by any similar undertaking.

AN important paper on tropical folder grasses appears in the *Kew Bulletin* for November. The object of the paper is "to draw attention to a few grasses that have attained to first rank for folder purposes in the tropics, and to give particulars respecting the conditions under which they have been found to thrive." The information given will be of considerable assistance in selecting grasses suitable for cultivation in tropical countries. It will also show some countries that, while they have been spending time and money in endeavouring to introduce foreign grasses, they have overlooked excellent indigenous grasses close at hand.

MESSRS. BLYTHE AND SON have published a small book entitled "First Stage Mathematics." The contents are limited to the requirements of the Code of the Education Department for mathematics as a specific subject.

THE publication of Mr. Hutchinson's "Archives of Surgery," which has lapsed for six months, is now being resumed. No. 21 will appear in a few days, with additional letterpress as well as nine plates, and this number, which commences vol. vi., will contain a chronology of medicine from the fifteenth to the nineteenth century. The publishers will in future be Messrs. West, Newman, and Co.

A ROUGH list (No. 147) of rare and valuable books for sale, has been issued by Mr. Bernard Quaritch. The list includes a number of important archaeological works, and a few works belonging to the natural sciences. Mr. W. F. Clay has also just issued a list of scientific books, including the works on chemistry lately purchased by him from the library of the late Prince Lucien Buonaparte.

WE have received a copy of *El Obrero*, a fortnightly paper published at Quito, Ecuador, with a summary of meteorological observations made at the astronomical observatory at that place for the month of September. Observations in that locality are very desirable, and we are glad to see that their publication is to be continued, and copies to be distributed to a number of places.

THE Meteorological Office of Argentina has just issued vol. ix. of its *Anales* in two large quarto parts, forming a splendid contribution to the climatology of that part of the globe. The first part, which contains 678 pages, gives the observations and the means deduced from them, for Cordova, during the years 1872-1892; while the second part, which extends to 400 pages, contains an exhaustive discussion of the data, and of the influence of the various elements on each other, e.g. of wind on temperature, &c. It is not possible to give in a brief space any summary of so comprehensive a work. We merely note that the monthly mean temperature varies between 73° in January and 50° in June. The rainfall varies considerably; the mean of a number of years gives about 26 inches. The Director of the Service is G. G. Davis, who is also a member of the International Meteorological Committee, and attended the meeting at Upsala in August last.

*Science Gossip* is now one of the brightest and most diversified monthlies for the lover of science. The January number is remarkably good. Mr. J. T. Carrington, one of the editors, contributes a number of replies he has received to a letter asking for an opinion upon the use of the word "scientist." The word is never allowed knowingly to appear in contributions to NATURE. A twin-elliptic pendulum, exhibited by Mr. Joseph Gould at the Royal Society's soirées last year, is described by the inventor, and seven exceedingly fine figures, drawn by means of the apparatus, are reproduced. There is also a summary of Schiaparelli's views about Mars; and a page of astronomical ephemerides and notes, as well as scientific news, and notes on various branches of natural science. We are glad to see that physical science comes in for a fair share of attention, but there is still room for improvement.

SIX volumes have lately been added to the comprehensive series of reprints, "Ostwald's Klassiker der Exakten Wissenschaften," published by Engelmann, of Leipzig. No. 54 contains J. H. Lambert's paper, published in 1772, on the projection of terrestrial and celestial maps. The following number is also on map projection, and is made up of memoirs by Lagrange (1779) and Gauss (1822). Translations of two papers by Sir Charles Blagden, from the *Philosophical Transactions* for 1788, appear in No. 56. The subject is the effect of various substances in lowering the freezing point of water. Treatises on thermometry find a place in No. 57, which includes five of Fahrenheit's papers, three of Réaumur's, and a paper by Celsius. The volume thus comprises all the important communications con-

nected with the foundation of the three thermometric scales. The classical work of Scheele on the nature of air and of fire is reprinted in No. 58 of the series; and No. 59 contains Otto von Guericke's experiments with Magdeburg hemispheres, carried out in 1672. The quaint illustrations of the original paper give this volume additional interest.

THE additions to the Zoological Society's Gardens during the past week include a Black-eared Marmoset (*Leontideus penicillata*) from South-east Brazil, presented by the Lord Auckland; a Paruline Genet (*Genetta pardina*), a Two-spotted Paradoxure *Nandinia binotata* from West Africa, presented by Lieut. F. E. W. Batt; a Sparrow Hawk (*Accipiter nisus*), British, presented by Mr. A. M. Lees Milne; two Long-nosed Crocodiles (*Crocodilus cataphractes*) from West Africa, presented by Captain F. W. Raisin; a Kobben Island Snake (*Coronella phocarium*) from South Africa, presented by Mr. G. R. Picton Thwaites; two Grey Parrots (*Psittacus erithacus*) from West Africa, deposited.

*Erratum.*—In NATURE of December 13, 1894, p. 157, column two, line one, for "of a" read "near the." The cascade represented in the note serves to show clearly the overhanging ledge of limestone.

#### OUR ASTRO-NOMICAL COLUMN.

THE GREATER NEBULA OF ORION.—The numerous photographs that have been taken by means of portrait lenses during the past few years, go to show that many of the so-called celestial spaces are really filled with filmy nebulosities. Dr. Roberts's classical photograph greatly extended the limits of the old Theta nebula in Orion, but few astronomers would care to say that it represents the great "tumultuous cloud" in its entirety. Indeed, three photographs obtained by Prof. W. H. Pickering in 1889, with a portrait lens, revealed a large zone of nebulosity surrounding the belt and sword handle, and extending towards  $\gamma$  Orionis. The significance of these photographs has perhaps been somewhat overlooked, but attention is again directed to them by a paper communicated by Prof. E. E. Barnard to *Astronomy and Astro-Physics* for December. By means of a lens only 1½ inches in diameter and 3½ inches focus, Prof. Barnard has recently taken two photographs of the Orion constellation (for the lens takes in nearly the whole constellation at one view), with exposures of two hours and one hour fifteen minutes respectively. These pictures show "an enormous curved nebulosity encircling the belt and the great nebula, and covering a large portion of the body of the giant." Without doubt, the nebulous stream which has left its impression upon Prof. Barnard's photographs, is the same as that of which the existence was recorded by Prof. Pickering. The "Great Nebula" in Orion is therefore but a pigmy compared with the greater nebula thus revealed. It is not too much to believe that in a few years the immense band of nebulosity will be shown to be more or less filled with luminous haze, the old nebula being probably but the brightest part of a nebula involving the whole constellation.

THE TRANSIT OF MERCURY.—We have already noted observations of the transit of Mercury on November 10, 1894, made in Europe and America. News has now reached us of successful observations, made under the direction of Mr. J. P. Thomson, at Mr. F. D. G. Stanley's Observatory, Brisbane. The instrument employed was a 6 inch equatorial by Grubb, stopped down to four inches. Times of contact at egress were carefully taken. When the planet had come sufficiently above the horizon to be observable, it had advanced about two-thirds across the solar surface. The whole periphery of Mercury was remarkably clear and well-defined. There was no trace of haze or vaporous aureola around the disc of the planet, but a bright spot was distinctly seen near the centre. At the instant of internal contact at egress there was a faint phenomenon resembling ligament. This, however, was only momentary. When the external contact occurred, the planet's limb tangential with that of the sun was remarkably clear and sharp. There was not a trace of disturbance, and the phase was regarded as a pure

geometrical contact. No trace of the planet's periphery could be seen when it left the solar disc, although it was carefully looked for.

The Government Astronomer at Sydney, Mr. H. C. Russell, states that fifteen photographs were taken of the transit of Mercury. He reports that as the planet crossed the sun it presented the appearance of a round and intensely black disc without any fringe such as has been noticed in former transits, and owing to the unsteady state of the air towards the close of contact, the "black drop" phenomenon took place, preventing clear definition.

AN IMPORTANT ASTEROID.—The minor planet BE 1894 proves to be a very important member of the community to which it belongs. M. Tisserand remarks, in *Comptes rendus* for December 26, that, of all the asteroids, it has the smallest perihelion distance, leaving out of count Brucia (206), of which the elements are very uncertain. When I-E is at its descending node, its distance from the orbit of the earth is only 0.67 the radius of this orbit. On account of this circumstance, the asteroid is most favourably situated for the determination of the solar parallax. The elements given by M. Tisserand are as follows:—

1894 November 4.7 Paris Mean Time.

$m$	23	18	38.5	} Mean Eq. 1894.
$\pi$	357	25	53.5	
$S$	212	36	51.4	
$i$	23	5	5.7	
$\phi$	18	4	8.1	
$\mu$	1002	151		
$\log a$	0	366049		

PROF. ADAMS' COLLECTED MEMOIRS.—A note in the *Observatory* informs us that Prof. R. A. Sampson, formerly Isaac Newton Student at Cambridge, is gradually reducing to order the large quantity of MSS. left by Prof. Adams. The memoirs relating to lunar theory have been completely separated and arranged, and the lectures on Jupiter's satellites are also well advanced. Memoirs on the solution of the infinite determinant, and others on some small matters, have been separated from incidental and preparatory work; but a considerable quantity of matter is still outstanding, so it may be one or two years more before the examination can be completed, and the collected works be ready for publication.

### THE BIRD-WINGED BUTTERFLIES OF THE EAST.

IN the days of Curtis and Stephens, the late Mr. W. C. Hewitson was a diligent collector and observer of British insects of all orders, and likewise an ornithologist, who published several editions of a well-known work on British birds' eggs. But the day came when he was to discover, as he says in one of his own publications, that a butterfly might be beautiful, though it was not a British species; and he became thoroughly infatuated with these beautiful things, to the study and illustration of which he devoted the remainder of his life. And this is how it came about, as he used to relate to those who had the privilege of the acquaintance of a kind old enthusiast, whose work was of immense value to the progress of entomology in its day, though he was unable to sympathise with or to appreciate the vast revolution in modern biology which many men with whom he was intimate and men, too, not much younger than himself, with Darwin, Wallace, and Bates at their head—succeeded in effecting in a comparatively short time.

One day of the days, as it says in the "Thousand and One Nights," he happened to be at Stevens's Auction Rooms, when a lot was put up containing several species of the well-known genus *Alepha*, Hubner, or *Heterocheia*, Boisduval, as it was then called, which replaces our European White Admirals in South America. The butterflies attracted his attention, for at that time it was a novelty to him to see a number of butterflies so closely resembling each other, and yet quite distinct; and he bought the lot. He turned round, and saw Prof. Westwood, who said to him, "What are you buying butterflies?" "Yes, I am," he answered; and thus he commenced the formation of his great collection of butterflies, now in the British Museum, which was fed by the cream of the expeditions of Wallace and

Bates, and remained unrivalled up to the day of his death, in 1878, though there are now several collections in England, France, and Germany which surpass it.

The exact date when this epoch-making event in the history of the study of butterflies occurred, we do not know. It is true that the first paper published by Hewitson on exotic butterflies related to the genus *Heterocheia*, and was published in the *Annals and Magazine of Natural History* in 1847; but in the previous year, Edward Doubleday had commenced his great work on the "Genera of Diurnal Lepidoptera," the letter-press of which was completed after his death by Westwood; and Hewitson executed all the plates, as joint author. It is, therefore, probable that Hewitson had already commenced the formation of his collection before that time, especially as his own great work on exotic butterflies was commenced before the actual completion of the "Genera."

Yet, since the death of Hewitson, new countries have been opened up, and wonderful butterflies have reached Europe, never dreamed of by Hewitson, or which remained unattainable objects of his desire, to the last. Chief among these may be mentioned the butterflies of Central Asia, a *terra incognita* except for Eversmann's and Nordmann's papers, in Hewitson's time; and the butterflies of the Eastern Archipelago, for the older naturalists, and even Wallace and Lorquin, much as they were able to accomplish, only succeeded in sampling some few islands, and many others now known to produce some of the strangest and grandest butterflies in existence, remained unvisited and unexplored.

Chief among the butterflies of these islands are the grand species to which Boisduval applied the generic name of *Ornithoptera*, or bird-winged butterflies, of which only a few, and those not the most remarkable, are found on the mainland of India, the Malay Peninsula, and South China. Many of the species are very closely allied, but others are so different that they can hardly be regarded as congeneric; and it will be well to discuss them by groups.

First of all, we may divide them into the black and yellow species, and those with black and green, orange, or blue males; and each of these two main groups includes a variety of species, which are hardly all congeneric.

Two species only, *O. Priamus* and *O. Helena*, were known to Linné. Several more were figured and described before the end of the last century; but only eight species were described as late as 1836, and though several others were afterwards described, Hewitson's collection only included eighteen, counting several forms which he treated as varieties. Now, however, Mr. Rippon's large work, "*Icones Ornithopterorum*," at present in course of publication, is intended to extend to eighty folio plates. But there is always some difficulty in determining the exact number of species, for these butterflies are variable, and in the numerous islands of the East there are a great number of closely allied local races, and we are hardly in a position at present to determine whether it is best to treat them all as distinct species, or as different forms of two or three, and especially is this the case with the group of *Ornithoptera Priamus*.

It will be best to commence with the black and yellow species, which are found on the Asiatic Continent, and the Malay Islands, and therefore in nearer and more accessible localities than any of the green species, except *O. Brookeana*. They are also found in the Moluccas, &c., but less numerously, being more abundant in the Malay Islands.

Of this group, *Ornithoptera Pompeus*, Cramer, from Java, may be regarded as typical. The males of this and the allied species are of a velvety black, with the nervures more or less bordered with grey, and the spaces between the ends of the veins on the hind margin, bordered with white. The hind wings are of a beautiful golden yellow, intersected with the black veins, and bordered with black along the hind and inner margins. The inner margin forms a fold which conceals the brown scent-bearing scales, and is fringed with long hairs.<sup>1</sup> On the inner margin, the black border projects into the wing in a series of long cones between the nervures. The females are similar, but the grey markings of the fore wings are more extended, and on the hind wings the scent organs are wanting, and there is a row of black spots opposite the cones of the border, which are often connected into a continuous series, as

<sup>1</sup> See, for a fuller description of the scent organs in *Ornithoptera*, Haase, "*Korrespondenzblatt des entomologischen Vereins, Iris zu Dresden*," l. pp. 93-94.

well as with the cones themselves. The fore wings are long and narrow, measuring about five or six inches from tip to tip, and the hind margin is very oblique. The hind wings are rounded and dentated, but form almost a right angle at the anal angle of the hind wings. Behind the head, we often find a red collar in one or both sexes. We have not thought it necessary to figure a species of this group, representatives of which may be seen in almost every collection of butterflies from India and the adjacent islands; but we have given figures of the larva and pupa of *O. pompeus* (Figs. 1, 2). The transformations of all the species of *Ornithoptera* are very similar, as far as they are at present known; the larvæ are rather short and thick, with rows of long fleshy spines, and with the retractile scent-producing and defensive bifid horn on the head, common to all the true *Papilionide*. In the yellow group, these larvæ are generally brown, with a broad pale oblique band about the middle.

The amount of yellow on the hind wings of the butterflies of the *Pompeus* group differs very much. Sometimes we find only a narrow black border, sometimes a very broad one, and sometimes the base is also black, the yellow colouring being restricted to a broad band, or even to a large spot in the centre. Two or three yellow species, found in Malacca, Borneo, &c., of

butterfly, measuring six inches across the fore wings. It is closely allied to several common Indian species, though none of these show more than the very faintest traces of iridescence. But in order to obtain the full effect, it is necessary that *O. Magellanus* should be set flat. If the wings are set sloping, according to the old English method, now being rapidly superseded by the flat setting which has always been in use on the continent, the effect of the iridescence is almost entirely lost. *O. Magellanus* is still a scarce insect in collections.

Among the more abnormally coloured species of this group we may mention *O. Plateni*, Staudinger, from the Island of Palawan, in which the male has two broad golden-yellow blotches on the centre of the hind wings, separated by the upper branch of the subcostal nervure; on the underside, and in the female, this colour fills up a large part of the centre of the hind wings. A still more remarkable species was lately discovered by Mr. Doherty in the Island of Salibobo, or Lirung, one of the Talautse Islands, and was described and figured by Mr. Rippon under the name of *O. Dohertyi*. The male is of an intense silky black above, with a slight greenish glow in certain lights; on the underside is a yellow band, parallel to the hind margin, and ceasing before the inner margin. The female has brown fore wings, with the usual grey markings inclining to reddish; the hind wings are darker, with a small irregular buff patch in the centre, divided by the nervures; on the underside this patch is larger, and the ends of the nervures are bordered with the same colour. These butterflies measure about six inches across the wings.

Next to the golden yellow group of *Ornithoptera*, we may place the splendid *O. Hippolytus*, Cramer, the female of which sometimes measures nearly eight inches across the wings.

It is not very closely allied to any other species. The fore wings resemble those of the last group, but the hind wings in the male are dark smoky brown, with a row of large yellow spots extending all round the wings, except on the side next the body; these are bordered, both outside and inside, by a row of nearly connected large black spots. In the female the yellow markings are more extended, and the base of the wings is black; the lower part is bluish-grey; and over the yellow and grey part of the wing runs a marginal row of large white spots. The fold on the hind wings is filled with long fluffy white hair. This insect is met with in Aboina, and Piepers, the Dutch entomologist, records his having seen a specimen mobbed and driven away by small butterflies, just as small birds will mob and drive away a hawk in Europe.

Mr. Rippon has proposed the name *Pompeoptera* for the foregoing series of species; but the types of *Ornithoptera* are *Papilio Priamus* and *Helena* of Linne, and as the former is fixed as the type of *Troides*, Hubner, by Hubner's inclusion of it in the second volume of his "Sammlung exotischer Schmetterlinge," *Helena* remains as the true type of the genus *Ornithoptera*, as correctly given by Mr. Moore in his "Lepidoptera of Ceylon," though Dr. Scudder, having overlooked both this point and the impropriety of regarding *Helena* as the type of *Troides*, specifies *Priamus* as the type of *Ornithoptera*, and *Helena* as the type of *Troides*.

Next to the golden-yellow species of *Ornithoptera*, we come to the green, blue, and orange section, to which the name of *Troides* should, as we have just seen, be applied, and of which *Papilio Priamus*, Linne, from Amboina and Ceram, is the type. To *O. Priamus* and its allies Mr. Rippon restricts the name of *Ornithoptera*.

The species of *Troides* are all very similar except in size and colour, and we have copied Mr. Rippon's figures of the smallest species, *T. Richmondia*, from Australia (Figs. 3, 4, 5; Fig. 5, 2). This insect varies in size from 4½ to nearly 6 inches in expanse, the female being always the largest; but in most of the other species in the group, the wings expand 6, 7, or even 8 inches in some of the females. The males of this section have velvety black fore wings, with a wide green bar parallel to the costa, and another, more or less extended, at the hinder angle of the wing, running along the inner margin towards the base, and curving upwards along the hind margin. The hind wings are green, with a row of black spots (sometimes reduced to one or two) along the hind margin. There is a long brown patch of raised scales towards the hind margin of the fore wings in the male, which is quite absent in the yellow group (*Ornithoptera*, true). The females are brown butterflies, with two irregular rows of white spots on the fore wings, the innermost very large (though obsolete in some

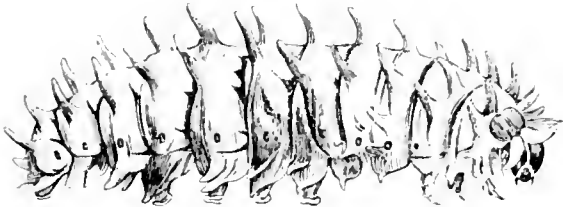

FIG. 1.—Larva of *Ornithoptera Pompeus*, Craw.

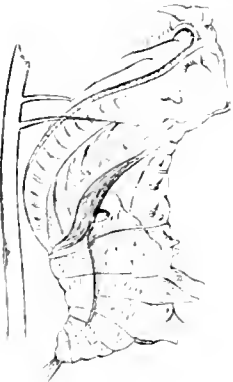

FIG. 2.—Pupa of *Ornithoptera Pompeus*, Craw.

which *O. Amphrysus*, Cramer, is the commonest, are distinguished from the others by having radiating yellow instead of grey lines on the fore wings of the males. Occasionally specimens of the yellow group are met with, with the yellow replaced by deep golden red; but it is not certainly known whether this peculiarity is accidental or specific.

The grandest of all the yellow species, however, is *O. Magellanus*, Felder, a native of the Philippine Islands. If the butterfly is held towards the light, there is nothing to distinguish it from any other yellow *Ornithoptera*; but if you turn your back to the light, and hold the drawer on a level with your eye, you will see a marvellous iridescence of the most delicate pale silvery blue and green glancing over the whole of the hind wings of the insect. There is nothing to compare with it in any other butterfly, not even in *Morpho Sulikowskyi*; the nearest approach to it is in the iridescence over the red spots in some South American *Papilios* (which, though much smaller, are considered to be closely related to *Ornithoptera*), and in the iridescence over the yellow on the wings of some South American butterflies belonging to the genus *Euselasia*, Hubner. But these latter belong to a different family (*Lemoniide*), and are small butterflies, not exceeding an inch and a half in expanse, whereas *O. Magellanus* is a grand black and golden-yellow

species), and with the hind wings pale beyond the middle, and crossed by a row of black spots; the pale part of the wing is whitish within them, and brownish, or yellow, beyond. The sides of the thorax are generally bright scarlet under the wings, and the abdomen is generally yellow in the males, and brown in the females. These green species are not found in the Malay islands, but throughout all the Moluccan and Papuan islands, as far as Australia; though many of the most remarkable are very restricted in their range, being confined to one or two small islands.

Sometimes, as in the male of *T. rufina*, Felder, a narrow green stripe runs along the median nerve and its branches, in the male. In certain lights the green of the fore wings exhibits very remarkable changes of colour to yellow, coppery-red, or blue; the coppery-red is most conspicuous in *T. Pezarus*, Felder, from New Guinea, and the blue in *T. Eumelus*, Rippon, from the Aru Islands.



FIG. 1. *T. Eumelus* (male), two varieties.

low bushes; and he also obtained the larva, which is black, with carmine tentacles, and fleshy spines, the latter tipped with black; about the middle of the body is an oblique white stripe. It feeds on a species of *Aristolochia*, sometimes quite close to the ground.

From *T. Urvilleanus*, we may pass on to other remarkable species. One is *T. Crasus*, Wallace, from the island of Batchian in the Moluccas. Here the green or blue of the species we have already mentioned is replaced by a brilliant golden orange, shading into green in certain lights. Mr. Rippon treats *T. Crasus* and *Urvilleanus* as a separate section (*Prionoptera*) of *Ornithoptera* (which name he retains for the *Prionus*-group); but they can hardly be considered sufficiently distinct from the others to rank as a separate genus, as he himself admits.

After *T. Crasus* we may place *T. Lydius*, Felder, which replaces that species in the island of Gilolo or Halmahera, one of the Northern Moluccas, not far from Batchian. Here the subcostal band on the wings of the male is of a very deep coppery-red; but both in this species and in *T. Crasus*, the only other mark on the fore wings, except a short dash at the base of the inner margin, is the very large oval brown sexual blotch. The hind wings are of a rather paler colour than the band of the fore wings, and varied with yellow. The female of *T. Crasus* does not differ much from the ordinary females of the *Prionus*-group, but that of *T. Lydius* is black, with the cell, and two



FIG. 2. *T. Lydius* (female).

complete rows of long spots, concave at the extremity, and the inner row very large, between the nervures beyond the cell. The hind wings are of a yellowish-brown, with the base, nervures, a submarginal row of mostly connected spots, and another on the hind margin, black.

From the genus *Troides*, we pass on to another splendid group, *Aethoptera* (Rippon), in which the male has apparently no masses of raised scent producing scales on the wings, and the hind wings are very long. Intermediate between *Troides Crasus* and *Aethoptera Victoria*, the type of *Aethoptera*, stands *A. (?) Titivum* (De Haan), from New Guinea, a butterfly which remained unique in the Leyden Museum for fifty years. The fore wings of the male, which are seven inches in expanse, are black, with three changing green and yellow bands, two united at the base, the first running narrowly along the subcostal nervure, and much widened before reaching the apex of the wing; the second, broader at the base, extending along the lower part of the cell, and growing broader beyond as it curves towards the hind margin; the third runs along the inner margin, nearly to the hinder angle of the wing. The hind wings are varied with green and golden-yellow, and are narrowly bordered with black. There are three black spots on the hind wings on the upper side, and more beneath, as well as on the hinder part of the fore wings; the abdomen is yellow, with some black spots above on the sides, towards the extremity.

*T. Eumelus* leads us on to *T. Urvilleanus*, Guerin-Ménéville, from New Ireland, from whence several specimens were obtained during the voyage of the *Cornelle* and the *Astrolabe* between 1829 and 1836, but no more were brought to Europe for fifty years. They were named after the famous French Admiral, Dumont d'Urville, a worthy successor of our own Captain Cook; and who subsequently perished, with his wife and only son, in the great accident on the Versailles Railway, on May 8, 1842, one of the most terrible and fatal of all on record.

In the male of *T. Urvilleanus*, all the portions of the wings which are green in other species, are of a deep blue; but with an increase or opalescence in various lights, showing green or coppery. *T. Urvilleanus* has lately been found in New Guinea, New Ireland, Duke of York Island, and the Solomon Islands. The butterfly does not appear to be difficult to capture, as Mr. Gervase F. Mathew, R.N., frequently found them descend to

The female is not certainly known, for it is doubtful whether the insect which has been regarded as such may not be that of another species.

*Etheoptera Victoria* (Gray), the type of its genus, is likewise a species of which little was known for many years. A single female, damaged by shot, was brought back by Macgillivray from the voyage of the *Herald*, and remained unique in the collection of the British Museum for more than thirty years, when several specimens were obtained by Mr. C. M. Woodford in the Solomon Islands. The true *E. Victoria* proves to come from the island of Guadalcanar, and the male measures six inches across the fore wings, which are long, narrow, and rather pointed. It is black, with a wide green and yellow space for one-third of the distance from the base, and another blotch of the same colour near the costa before the apex, divided by the veins. The hind wings are very concave at the anal angle, and are green, bordered outside by a yellow band, on which stand three orange spots (also visible below, where they have black spots between and beyond them), and beyond this is a narrow

*Ornithoptera* which is tailed. The only species, *S. Paradisea*, Standinger, was captured by natives in the Finisterre Mountains in New Guinea, at a height of 500 metres. The male (Fig. 6) measures five inches across the fore wings, which are black, with two broad green bands glossed with golden yellow, one below the costa, and the other between the cell and the submedian nervure, and curved upwards, opposite the hinder angle of the wing, to beyond the middle of the hind margin. The hind wings are remarkably short, not more than three-fifths of the length of the inner margin of the fore wings, but they are very long and narrow, with the hind margin almost straight, and a tail quite as long as the wing is broad, at the outer angle; the inner margin is lobate. The hind wings are green, more suffused with orange-yellow than the fore wings, and narrowly bordered outside with black, but with the base and inner margin very broadly black.

The females are larger, and exhibit nothing unusual in form or colouring, being black, with two more or less developed rows of white spots on the fore wings, large towards the costa, and diminishing towards the hinder angle, where they converge; on the hind wings is a pale submarginal band, extending over the lower half of the wing, but much narrowed towards the costa; the outer part is yellow, shading within to bluish-grey and whitish; across it runs a row of black spots.

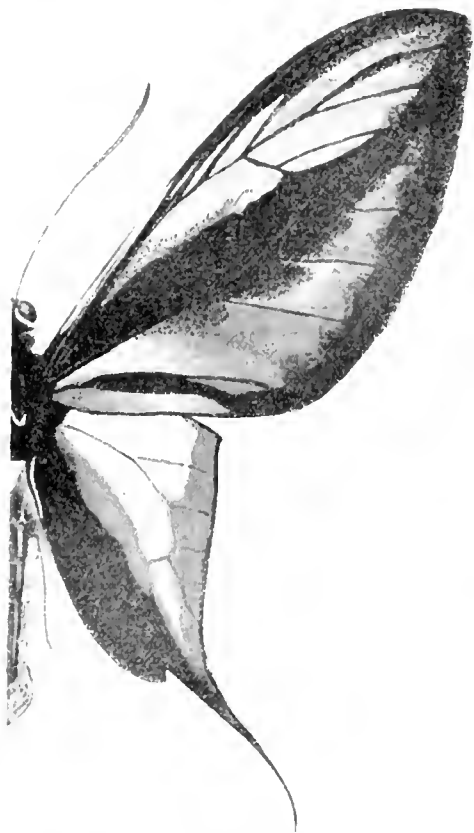

FIG. 6.—*Schoenbergia Paradisea*, Standinger (male).

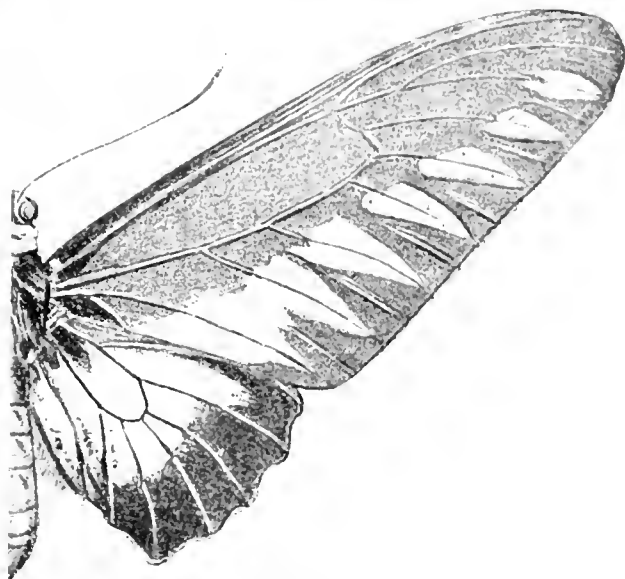

FIG. 7.—*Trogonoptera Brookeana*, Wallace (male).

This is the only known species of the group with tails on the hind wings; but this seems to be a tendency in some Papuan *Lepidoptera*. Thus the true Atlas Moths belonging to the East Indian and South American genus *Attacus*, Linné, are all tail-less; but there is a closely-allied genus (*Cosmocerca*, Butler) found in New Ireland and at Cape York, which has very long tails; in fact, these moths are probably the largest tailed *Lepidoptera* known.

We have one more Eastern genus to mention, which we have left till last because it occupies a rather isolated position, and would have interrupted the sequence of our genera. This is *Trogonoptera*, Rippon, the type of which is *T. Brookeana*, Wallace, which was discovered in Sarawak, Borneo, by Dr. A. R. Wallace, and named after Rajah Brooke (Fig. 7). It is the only green *Ornithoptera* which inhabits the mainland of Asia (the Malay Peninsula) and the adjacent islands of Sumatra and Borneo. It measures from six to eight inches across the wings, which are black, the fore wings very long, with the hind margin very oblique, and the hind wings short, rounded, and dentated. The front of the thorax and the sides below the wings are crimson. The fore wings have a row of large green submarginal triangles, with the pointed ends resting on the hind margin, and each triangle intersected by a nervure; on the hind wings the whole centre is green. In the female, the green is much more glossed with brassy, and is bordered within with blue,

black border. The female is a black butterfly, with much broader wings, seven inches in expanse. There is a row of large white spots, and another of submarginal spots on all the wings; on the fore wings a yellow band, white at the extremity, runs along the cell, and another along the inner margin; on the costa of the hind wings is a yellow band. The larva is dark brown, with long carmine fleshy spines; the retractile fork is yellow.

In the island of Malaya is found the closely-allied *O. Regina*, Salvin, a larger insect, the male of which has more black on the hind wings, and three orange spots surrounded with green on the orange part of the wing, instead of the yellow band.

These butterflies, as well as *Troides Urvillanus*, frequent the sweet-smelling white flowers of *Cerbera Odollam*, a plant allied to the Oleander, which is common throughout the East Indies and Polynesia.

The next genus, *Schoenbergia*, Pagenstecher, is in some respects the most remarkable of all, as it is the only one allied to

which is rarely the case in the male, and the green markings, which disappear towards the costa in the male, are there in the female replaced by long bluish grey streaks between the nervures. An interesting account of the habits of this species, as noticed by various observers, is given by Mr. Rippon in his "*Icones Ophipterorum*."

One other species of this genus is known: *T. Tzucana*, Staudinger, from Palawan, an island about a hundred miles from the north coast of Borneo. Here the brassy-green spots of the fore wings of the male are shorter and more subconical, instead of forming long isosceles triangles, and there is only a row of connected green spots across the hind wings, bordered within with blue; the base of the wings is also marked with rich blue across the nervures, and along the edge of the fold of the hind wings.

Some idea of the market value of conspicuous insects, before they are sent over in numbers, may be gathered from the circumstance that a specimen of this butterfly recently sold for £15 at Stevens's auction rooms.

This is the last genus included in *Ophiptera* which is met with in the East, but the two largest West African butterflies are likewise considered to belong to this group, and may receive a passing notice here. One of these is the famous *Dryops Antina luc.*, which was brought by Smeathman from Sierra Leone, and figured by Drury in 1782, and afterwards, by Donovan in his "*Naturalists' Repository*," but of which no second specimen was seen in Europe till 1854. It is an insect with very long and narrow wings, from seven to nearly nine inches in expanse, and much resembles some gigantic species of the very characteristic African genus *A. luc.* It is black, with large tawny spots and markings towards the base of the fore wings, the greater part of the hind wings is tawny, with a row of black submarginal spots. It has been suggested that this insect possibly mimics an extinct *Arcia*, for the largest known species of that genus are not much more than half the size of *D. Antina luc.* The female is considerably smaller than the male (a rather unusual character in butterflies), and has much shorter wings. There are two specimens in the Hewitson Collection in the British Museum, and it was one of these that Mr. Hewitson used to say cost him £500. The real explanation is probably that he spent that amount in sending out agents to collect butterflies in Africa, with special instructions to look for *D. Antina luc.* O. late years, many specimens have been brought to Europe, and the butterfly can now be bought at a comparatively reasonable price.

The other West African butterfly now recognised as belonging to the *Ophiptera* group, but for which a new genus will probably be created before long, was described by Hewitson under the name of *Euphile Zabm. luc.* It measures about seven inches across the wings, which are broader and more rounded than in the typical Eastern butterflies of this group. The male is of a rather pale blue, with black borders, slightly spotted with blue on the hind wings, and with black marginal lines between the nervures, and a black costa on the fore wings. The male is fairly common in collections, but the female, which is of a dull yellowish grey instead of blue, is still very rare.

It is curious that, like the gorilla and chimpanzee, the nearest relatives of these two great West African butterflies (if we except *Euphile Zabm. luc.*, White, a West African butterfly which has some resemblance to *D. Antina luc.*, though it is much smaller and redder), are to be looked for in the islands of the Eastern Archipelago.

W. F. KIRBY.

#### A NEW ELEMENT IN THE NITROGEN GROUP.

A NEW element appears to have been discovered by Dr. Bayer in the residual liquors derived from the older processes for the extraction of alumina from red bauxite, and an account of it is communicated to the current issue of the *Zeitschrift für Analytische Chemie*. The liquors in question consist chiefly of sulphate and carbonate of sodium, but there are also present considerable quantities of chromic and vanadic acids, and smaller quantities of molybdic, silicic, arsenic, phosphoric, and tungstic acids, together with alumina, magnesia, and lime, and an acid of the new element. In order to isolate the latter, the vanadium and chromium are first removed, the former as the difficultly soluble ammonium vanadate, and the latter as hydrated sesquioxide. The filtered liquid is then saturated with sulphuretted hydrogen, and the sulphides, all of

which are soluble in the alkaline liquid, are precipitated by hydrochloric acid. This precipitate exhibits a deep brown colour, due to the new element. When dried it presents a brown earthy appearance, and burns readily with evolution of sulphur dioxide and formation of a bright brown powder. Concentrated nitric acid instantly causes ignition, and formation of a deep brown solution, from which a small quantity of a yellow precipitate of a compound of molybdic and arsenic acids is deposited. The brown liquid contains no tin, antimony, or tellurium, but still retains traces of vanadium, molybdenum, and selenium. These elements are best removed by calcination of the sulphides immediately after their precipitation with hydrochloric acid when selenium is volatilised, treatment of the residue with ammonia and ammonium nitrate, which precipitate the last traces of vanadium as ammonium vanadate, and concentration of the filtered liquid which causes deposition of ammonium molybdate. During the concentration two distinct crops of different crystals are obtained, the first and most sparingly soluble being cubic crystals of an olive-brown colour, and the second the much more soluble ammonium molybdate. The olive-brown cubic crystals contain the new element, together with a little molybdenum. The latter is readily removed by dissolving the crystals in dilute hydrochloric acid, and passing a current of sulphuretted hydrogen through the liquid heated to about 70°. The new element is not precipitated by sulphuretted hydrogen in an acid solution. The filtered liquid is then allowed to evaporate in the air. At first it is bluish-violet in colour, and contains the new element in a low state of oxidation; subsequently it becomes oxidised, and the colour changes to lemon yellow. The oxide in the latter stage possesses marked acid proclivities, and probably corresponds to the formula  $R_2O_5$ . The acid itself is soluble in water, from which it is deposited in yellow crystals, which at a red heat fuse to a brownish yellow mass. Ammonia transforms the acid into a crystalline powder of olive colour, presumably an ammonium salt, which readily dissolves in hot water and crystallises from the solution in cubes on cooling. The solution is olive green and is precipitated by strong ammonia. The solution of the acid after reduction with sulphuretted hydrogen in presence of hydrochloric acid yields with ammonia a voluminous deep violet-brown precipitate, which rapidly becomes crystalline. The precipitation is not complete, hence the supernatant liquid is coloured violet. Caustic soda and sodium carbonate likewise incompletely precipitate it, owing to solubility of the precipitate in excess of the reagent with formation of a soluble salt. Chlorides of barium and calcium produce greyish-violet precipitates of the salts of those metals.

An especially interesting reaction is that with ammonium sulphide, with which the highly oxidised yellow solution of the acid yields a deep cherry red colouration, due to a sulfo-salt. Acids precipitate from this solution a sulphide of the colour of iron rust. Silver nitrate produces a green precipitate of the silver salt, soluble both in nitric acid and in ammonia, and if the solution in the latter solvent is effected at a moderately elevated temperature the silver salt is deposited in crystals upon cooling. Magnesia mixture gives after standing a few minutes a green precipitate analogous to ammonium magnesium phosphate, and owing to the slowness of the precipitation the latter occurs in the form of relatively large crystals; moreover, the precipitation is complete after a short time, for the liquid which at first is green becomes colourless. A yellow precipitate is likewise afforded with a nitric acid solution of ammonium molybdate, as in the case of phosphoric acid. The chlorides of the new element appear to be volatile, for very considerable loss occurs on attempting to remove by ignition any admixed ammonium salts, for instance from the solution obtained after removal of the vanadium as previously described. A yellow sublimate is produced having all the characters of a chloride of the new element, and which is readily soluble in water.

A sufficient quantity of the new element in the form of any of its compounds has not yet been accumulated to enable exact quantitative analyses to be carried out, but Dr. Bayer hopes shortly to have obtained the amount requisite for this purpose and for the determination of the atomic weight of the element. There appears to be little room for doubt that it will prove to be one of the missing elements predicted by Prof. Mendeléeff in the nitrogen-phosphorus group. It exhibits characteristic spectroscopic lines in the green, blue, and violet.

A. E. TUTTON.



SCIENCE IN THE MAGAZINES.

A FULLY illustrated description of Mr. Maxim's experiments in aerial navigation is contributed to the *Century* by Mr. Maxim himself. The account of the new flying machine and its various parts is the best we have seen. The total result of Mr. Maxim's experiments is now fairly well known. It has been proved that a machine, carrying its own engine, fuel, and passengers, can be made powerful and light enough to lift itself in the air. The experiments also prove that an aeroplane will lift a great deal more than a balloon of the same weight, and that it may be driven through the air at a very high velocity, and with an expenditure of power very much less than that required to drive a balloon at even a moderate pace. In addition to this, they have clearly shown that a well-made screw propeller obtains sufficient grip on the air to propel a machine at almost any speed, and that the greater the speed the higher the efficiency of the screw. These results have certainly forwarded the problem of aerial navigation. The *Century* also contains an article on customs, fete's, and celebrations in American Colleges for Women; and, in the same magazine, a brief description is given of the new anti-toxin treatment of diphtheria.

In the *National*, Mr. Stanley Lane-Poole pays tribute to the memory of the late Sir Charles Newton. (A notice of some of the researches of this distinguished archaeologist will be found on p. 250.) Prof. Foxwell replies, on behalf of professed economists, to Lord Farrer's article in the October number of the same review, upon the Standard of Value. Towards the end of a contribution on the present state of the Royal Navy, Mr. W. Laird Clowes expresses himself upon the subject of the education of naval officers. Referring to the training of a naval officer, he remarks: "A century ago . . . it was not necessary that he should know anything of chemistry, of engineering, of hydraulics, of pneumatics, of electricity, and of half a dozen other subjects concerning which he must now know more than a little. . . . But at present, if an officer goes to sea, he has to suspend, in a great measure, the progress of his education. Theory is at the base of nearly all of it, and the theory is just as requisite as the practical experience, and, indeed, in some matters, even more so. . . . The seaman is in process of becoming the engineer; every year he becomes more and more the engineer; and I am certain that a much briefer experience of the sea than was formerly needed is now required towards the formation of a good officer. *Per contra*, he who would be a good officer requires very many things which are more easily obtainable at Portsmouth than in mid-Atlantic. We may regret the change, but we must not shut our eyes to facts. And I think the sooner the change is fully recognised, and the whole scheme of the education of naval officers is radically altered, the better will it be for the service." Mr. Clowes, however, does not seem to have sufficiently taken into account the difference between the duties of the navigating officers of the navy, and the engineers. Naval engineers at the present time receive admirable training in both the theory and the practice of the machinery with which a modern battleship is equipped. Does Mr. Clowes hold that navigating officers should receive the same kind of training? The statement that the seaman is in process of becoming the engineer, will hardly be accepted literally by those acquainted with the naval service. The engineers and engine-room artificers are fast becoming the most important men on board, but the distinction between them and the navigating staff is as hard and fast as ever it was.

In the *New Review* are some verses having a singularly strange and appropriate rhythm, by the late R. L. Stevenson, in which he has expressed his keen sense of the struggle for existence; and we find in the critical article upon this last among the many losses of 1894, by Mr. Archer, how profoundly modern scientific thought had affected his philosophy. There is also the first instalment of an eccentric story by Mr. H. G. Wells, in which, after certain rather paradoxical dealings with the four dimensions, a "Time Traveller" starts into futurity upon a *Time Machine*. What he found there remains to be told in a subsequent number, but there certainly seems scope for the scientific imagination in such a story.

A paper on "Feeling of Beauty in Animals," in *Chambers's Journal*, will interest students of nature. So long ago as 1866 a letter was published in the *Athenæum* under the same title, and attracted the notice of Charles Darwin. Birds offer, perhaps, the best proofs of a feeling for beauty exterior to themselves. There are the Bower Birds of Australia, and the Gardener Bower

Bird of New Guinea, each of which decorates its bower with various objects. The Hammerkop or Hammerhead also nourishes æsthetic tastes, and other instances of birds showing a decided taste for ornament are described in the article referred to.

A passing notice will suffice for the remaining articles on scientific subjects in the magazines received by us. Some interesting reminiscences of the late Oliver Wendell Holmes as professor of anatomy, are given by Dr. T. Dwight in *Science*. *Good Words*—the first number of a new series—contains the first part of a paper on Sir Isaac Newton, by Sir Robert Ball; and some speculations by the Rev. Canon Scott on the physiological consequences that would have resulted if the earth rotated from east to west instead of west to east. Mr. Grant Allen writes another "Moorland Myll," in the *English Illustrated*. To the *Humanitarian*, St. George Mivart contributes the concluding part of his popular exposition of the doctrine of heredity. We are glad to note that the second number of the *Photographic Quarterly Review* contains several scientific articles, each of which will help to familiarise photographers with scientific phrases. The *Contemporary* has an article on the London County Council, by Mr. Sydney Webb, in which the work of the Technical Education Board is incidentally referred to. In addition to the magazines and reviews named in the foregoing, we have received the *Fortnightly*, *Langman's*, *Corahill*, and the *Sunday Magazine*; but in none of these is science given a place.

SEASONAL CHANGES ON MARS.

FOR the substantiation of changes on the surface of Mars, it is of paramount importance that the drawings to be compared should all have been made by the same person at the same telescope, under as nearly as possible the same atmospheric conditions. So much, at least, is fulfilled by the drawings referred to in this paper. For they were all made by Mr. Lowell at the same instrument, under the same general atmospheric conditions. Even the different eye-pieces used vary chiefly in a manner to minimise, if anything, and so emphasise the differences observed. For with increasing image the higher power used tends to decrease the contrast. The result is that it largely offsets the difference in contrast due to nearer approach, and leaves simply a case of magnification, with the values untouched.

Since, furthermore, the drawings were all made in the months preceding and following one opposition, secular changes are practically out of the question; and any changes that appear, are presumably of a seasonal character. They constitute of themselves a kinematical as opposed to a statical study of the planet's surface.

The resulting phenomena are much more evident than might be supposed; indeed, they are quite unmistakable. As for their importance, it need only be said that deduction from them furnishes, in the first place, strong inference that Mars is a very living world subject to an annual cycle of surface growth, activity, and decay; showing, in the second place, that this Martian yearly round of life must differ in certain interesting particulars from that which forms our terrestrial experience.

The phenomena evidently make part of a definite chain of changes of annual development. So consequent and, in their broad characteristics, apparently so regular are these changes, that it is not difficult to find corroboration of what appears to be their general scheme in drawings made at previous oppositions. In consequence it will be possible in future to foretell, to some extent, the aspect of any part of the planet at any given time.

The changes in appearance presented by the planet described by Mr. Lowell, refer primarily not to the melting of the polar snows, except as such melting forms the necessary preliminary to what follows; but to the subsequent changes in appearance of the surface itself. To their exposition, however, the polar phenomena become inseparable adjuncts, since they are inevitable auxiliaries to the result.

With the familiar melting of the polar snow-cap, therefore, this account properly begins, since with it begins the yearly round of the planet's life. With the melting of the Earth's Arctic or Antarctic cap might, similarly, be said to begin the

1 Abstract of a paper by Mr. Percival Lowell in *Astronomy*, a *Journal of Physics*, for December.

Earth's annual activity. But there appears to be one important inference here at the very outset between the two planets. In the case of the Earth, the relation of the melting of its polar snows to the awakening of surface activity is chiefly one of *post hoc*—simply; in the case of Mars, it seems to be one of *propter hoc* as well. For unlike the Earth, which has water to spare, Mars is apparently in straits for the article, and has to draw on its polar reservoir for its annual supply. To the melting of its polar cap, and to the transference of the water thus annually set free to go its rounds, seems to depend all the phenomena upon the surface of the planet.

The observations upon which this deduction is based extend over a period of more than five months; from the last day of May, 1894, to the 7th of November. They cover the regions from the south pole to about latitude thirty degrees north. It is probable that analogous changes to those recorded, differing, however, in certain marked particulars, occur six Martian months later in the planet's northern hemisphere. For though it is likely that the general system is one for the whole planet, it is also likely that the distribution of the planet's surface details alters the action to some extent.

In order to appreciate the meaning of the changes, it should be borne in mind that the vernal equinox of Mars' southern hemisphere occurred on April 7, 1894; the summer solstice of the same hemisphere on August 31; and that its autumnal equinox will take place on February 7.

On the 31st of last May, therefore, it was toward the end of April on Mars. The south polar cap was then very large, upwards of 45° across, and already in active process of melting. The tilt of the planet's axis towards the Earth enabled it to be well seen, and disclosed the fact that it was bordered persistently by a dark band, broader in some places than in others, but keeping pace with the snow's retreat. The average breadth of the dark band was, in June, 220 miles. It was the darkest marking on the disc, and was blue.

As the season advanced and the snow cap diminished, its dark girdle diminished in breadth, with fluctuations dependent, doubtless, on the draining capacity of the ground. In August it showed as a slender dark thread.

This formation was water, beyond a doubt; for it was of the colour of water, it faithfully followed the melting of the snow, and it subsequently vanished—three independent facts mutually confirmatory to this conclusion.

That it was the darkest blue marking on the disc, implies that it was the deepest body of water on the planet. That it subsequently entirely drained off, implies that its depth could not have been very great. Both facts together make a first presumption in favour of its being not only the chief body of water on the planet, but the only one of any size.

This polar sea plays *leucæ mæthina* to all that follows.

So soon as the melting of the snow was well under way, long straits of deeper tint than their surroundings made their appearance in the midst of the dark areas. They were already there on the last day of May. The most conspicuous of them lay between Nechus and Hellas in the Mare Australe, and thence through the Mare Erythreum to the Hour-glass Sea (Syrtis Major). The next most conspicuous one came down between Hecates and Anomæ. Although these straits were very distinguishable darker than the rest of the seas through which they ran, the seas themselves were then at their darkest. The fact that these straits ran through the seas, suffices to raise a second doubt whether the seas be seas. The subsequent behaviour of the so-called canals renders their aquatic character still more doubtful.

At the initial stage of the Martian Nile-like inundation, the seas were at their darkest. This is probably due both to the fact that some water had already found its way down from the pole, and also to the fact that moisture had been deposited there on the water's journey up, and had quickened the vegetation of those relatively amphibious lands.

For some time the dark areas remained largely unchanged in appearance, that is, during the earlier and most extensive part of the melting of the snow-caps. After this, their history became one long chronicle of living up. Their lighter parts grew lighter, and their darker ones darker. For even to start with, they were composed of every grade of tint. Indeed, one of the most significant features about them was that at this epoch it was impossible to fix any definite boundaries to the south temperate chain of islands. The light areas and the dark ones merged indistinguishably into each other. Viewed from

the standpoint of maps of Mars, the landmarks of this whole region lay obliterated by a deluge; not directly, but indirectly. Probably the region was in various stages of vegetal fertility in consequence of a comparatively small body of water then inundating it. The colour of the dark areas was then, and is now, to my eye, a bluish-green; quite unmistakably so. This tint gradually faded out to give place to orange-yellow.

The first marked sign of change was the reappearance of Hesperia; this took place in July. It was not till the end of October, on the 30th, that Atlantis was caught sight of. About the same time the straits between the islands, Zanthus, Scamander, Ascanias and Sinois, came out saliently dark, a darkness due to contrast.

Meanwhile the history of Hesperia continued to be instructive. From having been invisible in June, and conspicuous in August, it returned in October to a mid-position between the two. Vacillating as these fluctuations may seem at first sight, they will all be found to be due to one progressive change in the same direction, a change that showed itself first in Hesperia itself, and then in the regions round about it. From June to August, Hesperia changed from a previous blue green, indistinguishable from its surroundings, to yellow, the parts adjacent remaining much as before. In consequence the peninsula stood out in marked contrast to the still deep blue-green regions by its side. Later the surroundings themselves faded, and their change had the effect of once more partially obliterating Hesperia.

While Hesperia was thus causing itself to be noticed, all the rest of the south temperate zone, as we may call it for identification's sake, was unobtrusively pursuing the same course. Whereas in June all that part of the disc comprising the two Thyle, Argyre II, and like latitudes was chiefly blue-green, by October it had become chiefly yellow. The separate identity of these islands became then for the first time apparent. Still farther south, what had been first snow and then water turned to yellow land. This metamorphosis went on till, on October 13, the remains of the snow-cap entirely, or practically entirely, disappeared—the first complete disappearance of it on record. After this event the whole south polar region was one yellow stretch.

Toward the end of October a strange and, for observational purposes, distressing phenomenon took place. What remained of the more southern dark regions proceeded unexpectedly to fade in tint throughout. This was first noticeable in the Cimmerium Sea; then in the Sea of the Sirens, and in November in the Mare Erythreum about the Lake of the Sun. This fading steadily progressed until it got so far that in 1894 seeing the markings were almost imperceptible, and the planet presented a nearly uniform yellow disc.

Now, this fading out of the dark areas is a highly significant fact, with a direct bearing upon their constitution. For it is not simply that portions of the planet's surface have changed tint, but that, taking the disc in its entirety, the amount of the blue-green upon it has diminished, and that of the orange-yellow proportionately increased. Mars appears more Martian than he did in June. Now, if the blue-green areas represent water, where has this water gone? Nowhere on the visible disc. That is certain. For in that case the amount of the dark areas should not be perceptibly lessened—which it is. Nor can it all very well have gone to that part of the planet that is hidden from view. For Schiaparelli's observations in 1882 go to show that the northern snow-cap forms late—one month after the vernal equinox of the northern hemisphere on that year. Since, therefore, the water fails to prove an *ad hoc* presumption in instantly raised in favour of the alternate hypothesis, that the blue-green areas represent vegetation, fertilised by a comparatively small amount of water whose direct presence or absence is not very perceptible to us, but whose indirect effects are. For vegetation might change from green to yellow without requiring any corresponding inverse change elsewhere.

Now, though the passage of the water may not be traced by its amount, there is a further change which has lately appeared on the disc which hints at what has become of it. The canals have darkened. What is more, their darkening has pursued a perfectly definite course, proceeding steadily from south to north.

The following observations show, first, that the canals are not equally visible at all times; and secondly, that their invisibility is a matter of the Martian seasons.

In June the canals were very faint markings indeed. The least faint were those in the Solis Lacus region. As the planet

approached us, they all became naturally easier to make out; but until October no change apparently occurred in any of them, except those in the region about the Lake of the Sun. These by September were already dark. In October they began to show symptoms of growing lighter again. At the next presentation, in November, they showed further signs of change, though not differing as yet very unmistakably in tint. Meanwhile, when the Sinus Titanum region came round in November, I found that its canals had begun likewise to darken. The canals were not only darker relatively to the Mare Cimmerium and the Mare Sirenum than they had been, but actually darker themselves. In the next few nights the more northern canals about Ceranus had followed suit. They had darkened relatively to the southern ones about the Lake of the Sun.

Now, on looking at a map of Mars, it will be seen that the Solis Lacus region is that part of the continental areas which lies nearest the south pole. Similarly, that the region about Sinus Titanum is the next farthest south. The matter of latitude therefore affects the point.

The canals and so-called lakes share, therefore, in the annual metamorphosis, with a season change dependent in a general way upon their latitudes. A wave of deepening tint passes successively through the blue-green regions from south to north, tuned to the seasonal wave that travels from pole to pole. From being pale in winter, their colour comes with the spring, deepens through the summer, and dies out again in the autumn. In any given locality the change comes early or late, in proportion as the place lies, other things equal, distant from the pole.

That this change of tint is due indirectly to water, and directly to the vegetation that water induces, seems probable. For just as there is great difficulty in disposing of the water on the first supposition, so the second would lead us to expect just the phenomena observed. It may therefore be concluded that the formations known as the seas of Mars are probably midway in evolution between the seas of Earth and the seas of the Moon. That is to say, they are not barren ocean beds, but are in that half-way stage of the process when their low-level helos them catch what water still voyages upon the planet's surface, though they have long since parted with their own.

Throughout all these interesting changes that follow the seasons across the face of Mars, there is but one feature approaching permanence—the great continental areas. Except for a possible variation in brightness here and there, this great area has remained unchanged. Like the reddish desert regions of our Earth, its colour and immutability point to like character for cause. It does not change because it is already past such possibility. It is one vast desert waste.

#### UNIVERSITY AND EDUCATIONAL INTELLIGENCE.

A NEW post has been created under the Education Department for the purpose of obtaining special information and issuing special reports, from time to time, in relation to educational work at home and abroad. The frequent demand for fuller information on many educational subjects, and the great increase of purely administrative work, both at the Education Department in Whitehall and at the Science and Art Department, have made it desirable to have a separate officer in charge of a small additional branch for the above-named purpose, who will be designated "Director of Special Inquiries and Reports." This appointment has been accepted by Mr. M. E. Sidler, Student of Christ Church, and Secretary of the University Extension Delegation at Oxford.

THE Technical Education Board of the London County Council will be prepared early in July, 1895, to award not more than five Senior County Scholarships of the annual value of £60 in addition to the payment of college fees, tenable for three years, and subject to annual renewal. The scholarships are intended to provide the means of obtaining advanced technical training in a university, university college, or technical institute of university rank for students (young men or women) of exceptional ability who would otherwise find it impossible to secure such training. Candidates must, as a rule, be under nineteen years of age on September 1, 1895, but the Board is prepared to consider very special cases in which the candidates are above that age. The scholarships are offered with the view of encouraging the study of science or art, with

special reference to industrial requirements, and will be tenable at such institutions giving appropriate instruction within the statutory definition of technical instruction as may be selected by the scholars and approved by the Board. In the selection of scholars the Board will have regard, in the first instance, to the past achievements of the candidates, but the Board reserves the right to require any or all of the candidates to undertake an examination if it think fit. No candidate will be eligible whose parents have an income from all sources of more than £400 per annum.

SINCE November 1893, the Technical Education Board of the London County Council have awarded 721 Junior County Scholarships, each of the value of £20 and two years' free schooling. More than three thousand candidates presented themselves in competition for the scholarships, which are restricted to children whose parents are in receipt of not more than £150 a year. A detailed analysis of the occupations of the persons whose children competed for these scholarships is given in the *London Technical Education Gazette*. It indicates that the highest percentage of candidates who received scholarships is to be found in the leather trades, and next to these in the printing trades and jewellery and fine instrument trades. After these come the artistic trades and crafts, but the most remarkable feature is the comparatively poor results obtained by the children of clerks, agents and warehousemen, and the very poor success achieved by the professional classes. The time is not far distant when the scholarships granted by the Board will amount to the value of £30,000 per annum.

#### SCIENTIFIC SERIALS.

*The Mathematical Gazette*, No. 3, December, 1894.—The eccentric circle of Boscovich. In this continuation the editor considers a special case in which the centre of the eccentric circle lies on the straight line whose points of intersection with the conic are required. He then discusses the method as one of transformation, and finally points out a connection between reversion and perspective projection.—Dr. Mackay, in Greek Geometers before Euclid, writes upon Pythagoras and the Italic school.—Cajori's "History of Mathematics" is an all too short notice, by Dr. G. B. Halsted, of a book that has come in for a fair amount of praise and blame. There are some very interesting problems, solutions of examination questions, and questions for solution.—Prof. A. Lodge supplies an addition to his previous article on approximations and reductions.—We note, with pleasure, that in future the *Gazette* is to be enlarged to twelve pages. This additional space will greatly help to increase the use of this journal, which has so quickly made its way in school circles.

*Bulletin of the American Mathematical Society* (2nd series, vol. i, No. 3, December, 1894).—The group of Holoedric Transformation into it-self of a given group, by Prof. E. H. Moore, is a paper read before the Society at its November meeting. The remaining article is by Dr. G. A. Miller, on the non-primitive substitution-groups of degree ten. A list of these was given in the *Quarterly Journal of Mathematics*, vol. xxvii, pp. 40-42. A result of the article before us is that the following six groups should be deleted from that list, viz. 200<sub>2</sub>, 200<sub>7</sub>, 200<sub>8</sub>, 100<sub>3</sub>, 50<sub>3</sub>, 50<sub>5</sub>.—In the *Briefter Notizen* short accounts are given of H. Hertz, "Gesammelte Werke," Band iii. This volume, the first one as yet issued, contains a memoir on the principles of theoretical machines and mathematical physics, which was composed during the last three years of the author's life. The next notice gives a sketch of a new edition of Grassmann's mathematical works. It is to be hoped that, as was recently suggested in NATURE by Prof. Genese, a translation into English of the *Ausführungslehre* may soon be made, for the convenience of many students in this country. The other notices summarise the contents of the *Jahresberichte der Deutschen Mathematiker-Vereinigung* (vol. iii, 1893), of the *Proceedings of the American Association*—for the forty-second meeting, held at Madison, Wis. (August, 1893); of "Le Livret de l'étudiant de Paris" (Paris, 1894).—The *Notes* comprise accounts of the November meetings of the American and London Mathematical Societies. By the way, the reporter, who is a member of the latter Society, gives one of the names of the Council incorrectly. There is also an ac-

count of the meeting, in September last, at Vienna, of the German Mathematical Association. The Bulletin well maintains its position, and closes with its useful lists of new publications.

SOCIETIES AND ACADEMIES.

LONDON.

Mathematical Society, Dec. 13, 1894. Major Macmahon, F.R.S., President, and subsequently M. A. E. H. Love, F.R.S., Vice-President, in the chair.—The following communications were made:—On Maxwell's law of partition of energy, by Mr. G. H. Bryan. In his recent report to the British Association, the author had shown that if a large number of dynamical systems of any kind be taken, all similar in every respect, it is always possible to distribute their coordinates and momenta so that the distribution shall remain permanent, and shall satisfy Maxwell's law of partition of energy. By this is meant that if the kinetic energy of each system be reduced to a sum of squares, the mean values of these squares are equal. But the author had doubted whether it was possible in any case to infer that the time average of the squares forming the kinetic energy of a single system were equal. In the present paper the connection between time averages, and averages taken over a large number of similar systems, is examined more fully by means of an artifice suggested by Prof. Boltzmann's paper "On the application of the determinantal relation to the theory of polyatomic gases" (published as an appendix to Mr. Bryan's report). Instead of a vessel containing gas (as taken by Prof. Boltzmann), any single dynamical system is taken whose coordinates and momenta return to their original values after a long time T. If the time be divided into an infinitely large number (n) of infinitely short intervals (t), we can derive a stationary distribution by taking n systems and starting them, the first at time 0, the second at time t, the third at time 2t, and so on, giving every system the same coordinates and momenta at the time of starting it. At the end of the time T, we shall have the systems distributed according to a permanent or stationary law, and at any subsequent instant the mean value of any function of the coordinates and momenta for the different systems will be equal to the time average of the corresponding function for the original single system. It, however, we begin with a number of systems distributed according to a permanent law, we cannot pass back to the original single system unless we can show that the law of permanent distribution is unique. Now in any simple test case, such as that afforded by rigid bodies movable about fixed points or particles moving in planes after the manner of a Lissajous curve tracer, a stationary distribution exists satisfying Maxwell's Law of Partition, but other stationary distributions are possible which do not satisfy the law. Hence the author concludes that the time averages of the squares into which the kinetic energy of a single system can be divided, are not in general equal, at any rate independently of initial circumstances.—On Spherical Catenary, by Prof. A. G. Greenhill, F.R.S. The pseudo-elliptic integrals developed in the Proc. L.M.S. (xiv.) are applied in this paper to the construction of movable cases of the spherical catenary, given by the relation

$$\int \frac{\Lambda^2}{(1-\epsilon^2)\sqrt{Z}}$$

where

$$Z = (1-\epsilon^2)(h^2 - \Lambda^2),$$

connecting  $\psi$  the azimuth, and  $\Lambda = r \cos \theta$ , where  $\theta$  denotes the angular distance from the fixed point of the sphere, the tension being  $m = h^2(1-\epsilon^2)$  (ibid., (Civ.), 57). Putting

$$u = \int \frac{\Lambda^2}{\sqrt{Z}}$$

and

$$x = \int \frac{\Lambda^2}{(1-\epsilon^2)\sqrt{Z}} \Lambda^2 d\Lambda,$$

then  $x$  can be identified with the standard form of the pseudo-elliptic of the third kind, of order  $n$ ,

$$1 = \int \frac{\rho^2 \epsilon - \sigma}{\sigma \sqrt{Z}} \Sigma \rho^2,$$

where

$$S = 4(x + x')^2 - (y + 1)s + 4x'^2$$

by putting

$$x = \frac{1}{\mu}, \rho = \frac{1}{2} \left( \frac{M\rho}{\mu} + \Lambda \right), \Lambda = M(y + 1), h^2 = \Lambda^2 - 2y - 1.$$

where

$$M^2 = -\frac{y' + 1}{2x'}$$

and  $x, y$  are Halphen's functions, defined in his "Fonctions Elliptiques," I. p. 102. If  $u = a$  when  $z = 1$ , and  $u = b$  when  $z = -1$ , then  $u = \frac{1}{2}(a - b)$  when  $z = k$ ;  $a$  and  $b$  are each of the form  $f \omega_3$ , a fraction of the imaginary period  $\omega_3$ . Also

$$M^2 p(a + b) = -\frac{1}{2}(1 - h^2) - \frac{1}{2}\Lambda^2,$$

or  $12p(a + b) = 8x - (y + 1)^2$ , so that  $\sigma = 0$ , and

$$a + b = \frac{4\omega_3}{\mu}.$$

Thus, for instance, when

$$a + b = \omega_3, \Lambda = h^2 - 1, \rho = \frac{1}{2}\Lambda;$$

and the corresponding spherical catenary is given by

$$(1 - z^2)^{\frac{1}{2}} e^{\Lambda z} = \sqrt{\frac{h-1}{2}} \sqrt{z^2 - (h+1)z + 1} + i \sqrt{\frac{h+1}{2}} \sqrt{z^2 + (h-1)z + 1}.$$

With

$$\mu = 3, a + b = 4\omega_3, \Lambda^2 = h^2 - 1, \rho = \frac{1}{2}\Lambda;$$

and

$$(1 - z^2)^{\frac{1}{2}} e^{2\Lambda z} = \Lambda z^3 + hz^2 - 2z + i(hz + 1)\sqrt{Z}.$$

With

$$\mu = 5, a + b = 4\omega_3,$$

then  $\rho = \frac{1}{2}\Lambda$ , suppose:

$$M^2 = \frac{1}{2c}, \rho = \frac{1}{2}(3 - c)M;$$

and

$$(1 - z^2)^{\frac{1}{2}} e^{\Lambda z} = \Pi z^3 + \dots + \Pi_1 + i(1z^3 + \dots + 1z_3)\sqrt{Z},$$

where

$$\Pi = 2 - 5c + c^2 M, 1 = \frac{2}{c} \epsilon h, \&c.$$

With

$$a + b = \frac{1}{2}\omega_3$$

the calculation is rather more complicated, as this case must be derived from  $\mu = 3$ ; but the result is of the form

$$(1 - z^2)^{\frac{1}{2}} e^{2\Lambda z} = (\Pi_2 - \Pi_1)\sqrt{(z_1 - z_2)(z - z_0)} + i(L_1 - 1)\sqrt{(z - z_2)(z - z_1)},$$

with

$$z_0 = z_2, z_1 = z - z_0, z_0, z_1, z_2, z_3$$

denoting the roots of the quartic  $Z = 0$ .—The Transformation of Elliptic Functions, by Prof. A. G. Greenhill, F.R.S. The function  $z_n$ , introduced by Prof. Klein in his paper on the transformation of elliptic functions (Proc. L.M.S. xi. p. 151), and developed in Klein and Fricke's "Modulfunktionen," ii. part v., is shown here to be connected with Halphen's  $\gamma$  function by the relation

$$\rho(z - 1)z_n = \Lambda^n \gamma_n,$$

for a transformation of the  $n$ th order; and for an odd value of  $n$ ,

$$\Lambda^{n-1} = \frac{\gamma_n - \gamma_{n-1}}{\gamma_n - \gamma_{n-2}}, \rho = 1, 2, 3, \dots, \frac{n-1}{2};$$

in this manner the relation  $\gamma_n = 0$  is satisfied.

The bi-quadratic relations satisfied by the function  $z$  are now derived from Halphen's formula

$$\gamma_{m+1}\gamma_{n-1} - \gamma_{m+1}\gamma_{n-1} - \gamma_{m-1}\gamma_{n+1} - \gamma_{m-1}\gamma_{n+1} = 2m^2$$

The relation  $\gamma_n = 0$  is treated as the equation of a curve with coordinates  $x$  and  $y$ ; and when  $x$  and  $y$  can be expressed as functions of a parameter  $c$ , the quantities  $\gamma_n$  and  $\gamma_{n-1}$  can also be expressed as functions of this parameter. For instance,  $\gamma_{13} = 0$  reduces to the quadratic in  $\rho$

$$\rho^2 - (\tau - c^2 - c^3)\rho - c(1 - \tau)^2 = 0$$

by means of the substitutions

$$x = y(1 - \tau), \quad y = \left( \frac{1 - \tau}{c} \right), \quad \tau = c^2 - 1;$$

and now in Klein's Modular Equation of the Thirteenth Order, given in the *Proc. L.M.S.* ix. p. 126, it is found that

$$\tau = \frac{1 - c - 4c^2 - c^3}{c(1 + c)} = \frac{1}{1 + c} - \frac{c - 3}{c}$$

When one root  $\tau_0$  of this modular equation is given by

$$\tau_0 = \frac{13c(1 - c)}{1 - c - 4c^2 - c^3} = 1 + \frac{13}{c} - \frac{13}{c^3}$$

the remaining 13 roots, typified by  $\tau_\alpha$ , are given by

$$\tau_\alpha = \frac{\left( 1 + \sum_{\beta=1}^{12} \epsilon^{13\beta} \right)^2}{c + \frac{1}{1 + c} - c - 3}, \quad \epsilon = e^{2\pi i/13},$$

where  $\alpha = 1, 2, 3, 4, 5, 6; \beta = 0, 1, 2, \dots, 12$ ,

(Klein, *Math. Ann.* xvii. p. 507).

It has been shown in the *Proc. L.M.S.* xxv. p. 252, that

$$\lambda = \frac{c^2}{y^2}$$

and now, putting

$$\begin{aligned} (\sigma_1)^{13} &= \frac{c^2}{x^{13}y^{13}}, & (\sigma_2)^{13} &= \frac{c^2}{(xy)^{13}}, & (\sigma_3)^{13} &= \frac{c^2}{y^{13}x^{13}}, \\ (\sigma_4)^{13} &= \frac{c^2}{(yx)^{13}}, & (\sigma_5)^{13} &= \frac{c^2}{(xy)^{13}}, & (\sigma_6)^{13} &= \frac{c^2}{x^{13}y^{13}} \end{aligned}$$

all functions of  $c$  and  $\sqrt[13]{C}$ , where

$$C = 1 + 4c + 6c^2 + 2c^3 + c^4 - 2c^5 - c^6$$

The solution in the same manner of the Modular Equation of the Seventh Order has already been given in the *Proc. L.M.S.* xxv. p. 224; while the Fifth Order introduces Klein's icosahedron function. A similar procedure will serve for the Eleventh Order. On certain definite theta-function integrals, by Prof. L. J. Rogers.—On a class of groups defined by congruences (second paper), by Prof. W. Burnside, F.R.S.—Electrical vibrations in condensing systems, by Dr. J. Larmor, F.R.S. It is only by the introduction of considerable capacity that the vibrations of electrical systems of simple geometrical form can assume a character at all simple and steady; for this reason it is of practical importance to be able to estimate the periods of vibrations in the dielectric plates of condensers. It is shown that the modes and periods for such a plate are precisely the same as those of the acoustical vibrations of a plate of air of the same form and the same law of thickness, enclosed on both faces, and also round its edge, by rigid walls, the only difference being that the velocity of electric propagation replaces the velocity of sound. For example, if the condenser is a spherical one, the periods of the free vibrations are equal to the time required for an electric pulse to travel round its circumference, divided by  $(m^2 + m')$ , where  $m$  is any integer; and this result will also practically hold good for a condenser of this form which is not a complete sphere, but has a hole through it at the point opposite to the place where the inner coating is connected with the exciter. The periods for a flat condenser of uniform thickness correspond to the well-known ones of standing water-waves in a cylindrical vessel of the same form of contour. If a condenser is divided by cutting across its conducting coats, as is done in the ordinary guard-ring, the separate parts will vibrate without interfering with each others periods. Various other cases are treated; for example, the propagation of electric waves in a compound

plate composed, say, of air above and a liquid below.—On the integration of Allegré's integral, by Mr. A. E. Daniels.—On the complex number formed by two quaternary matrices, by Dr. G. G. Morrice.

Linnean Society, December 20, 1894.—Mr. C. B. Clarke, F.R.S., President, in the chair.—Mr. W. B. Hemsley exhibited a series of specimens and figures illustrating parasitism of *Loranthus aphyllus* and other plants, from the Herbarium, Kew.—Mr. J. E. Harting exhibited a specimen of a small Siberian warbler, *Phylloscopus uferianus*, which had been obtained near Beverley, Yorkshire, in October last, and made some remarks on its haunts, habits, and migration, and upon the previous instances which had been noted of its accidental occurrence in the British Islands.—Mr. H. M. Bernard gave the substance of a paper on the spinning glands in *Phryna*, not previously known, and described their position and their morphological importance in Arachnidan phylogeny. The penis was described as a pair of rudimentary filamentous appendages of the genital segment, and consequently of importance as bearing further testimony to the view that the limbs on the abdomen of the ancestral form were not plates as in *Limulus*, but appendages like those on the thorax. The presence of these limbs explains the curious genital operculum of the *Pedipalpi*, which is not a primitive feature derived from Eurypterine ancestors, as some would maintain, but a purely secondary specialisation acquired within the Arachnid phylum.—A paper was then read by Mr. Percy Groom, entitled "Contributions to the knowledge of Monocotyledonous saphrophytes," or plants which are dependent for their existence on the presence in the substratum of decaying organic matter. He observed that, like parasites, they may be divided into those which possess chlorophyll (*hemisaphrophytes*) and those which have none (*holosaphrophytes*). Hitherto very few experiments, he said, had been made on *hemisaphrophytes*, and hence our acquaintance with them was largely speculative. The remarks which he had now to offer referred almost entirely to *holosaphrophytes*, or at least to plants with very little trace of chlorophyll. After an interesting discussion, in which Sir D. Brandis, Mr. H. N. Ridley, and others took part, the Society adjourned to January 17.

PARIS.

Academy of Sciences, December 31, 1894.—M. Lœwy in the chair.—A study of graphites from iron, by M. Henri Moissan. At the ordinary pressure, the graphite is purer when formed at a higher temperature. The graphite produced at the highest temperature is the most stable in presence of nitric acid and potassium chlorate. Under pressure, the crystals and masses of graphite appear to have suffered incipient fusion. During the solution of the cast-iron by acids, hydroxy compounds are formed, which resist a dull red heat, but burn like the graphite itself.—Report was made favourably on a memoir by M. Kôrner, to be printed in the *Recueil des Mémoires des Savants Étrangers*, under the title "On the existence of integrals in any differential system, and on the reduction of such a system to a completely integrable linear form of the first order."—On the radial velocity of  $\zeta$  Hercules, by M. H. Deslandres. A spectrophotographic determination in which the line displacements are measured on photographs taken with comparison spectra on each side of the star spectrum. The mean value of the radial velocity of this star is 70 km., as determined by M. Belopolsky; the author confirms this exceptional value, finding 60.41, a second observer finds the velocity 62.97.—On the determination of the number of roots common to a system of simultaneous equations, and on the calculation of the sum of the values of a function in these points, by M. Walther Dyck.—On the solution of numerical equations by means of recurring series, by M. R. Ferrin.—On definite integrals of divisors, by M. N. Bougaief.—On certain conditions to be realised for the measurement of electrical resistances by means of alternating currents and the telephone, by M. R. Colson.—On the sulphides of nickel and cobalt, by M. A. Villiers. This is a study of the conditions of precipitation of nickel and cobalt sulphides, and of the means whereby the precipitation may be wholly or partly prevented.—On calcium ethoxide, by M. de Forcrand. Calcium carbide,  $C_2Ca$ , gives with ethyl alcohol compounds of the type  $nCaO + nC_2H_6O$ , and not an ethoxide. The compounds obtained are (1)  $3CaO \cdot 4C_2H_6O$  and (2)  $CaO \cdot C_2H_6O$ . At the same time gas is disengaged, consisting chiefly of acetylene (80 per cent), and an easily liquefied ethylenic hydrocarbon (10 per

cent.).—On  $\beta$ -yveinchonine, by MM. E. Jungfleisch and E. Leger. The preparation and properties of this compound are given in detail, and thirteen of its salts are described.  $\beta$ -oxyinchonine is an energetic diacid base; it turns litmus blue, and reddens phenolphthalein.—Action of chlorine on the secondary alcohols, by M. A. Bochet. The action of chlorine on alcohols of the type R.CHOH.CH<sub>2</sub>, yields ketones of the form R.CO.CCl<sub>2</sub>, the radical R being also chlorinated to the extent characteristic of the radical.—On the industrial preparation and physiological properties of the oxalate and of the crystallised salts of nicotine, by MM. H. Parenty and E. Grasset. The mortal dose of pure nicotine is 20–21 mgm. per kilogram weight of animal. The fatal dose in the combined state is much larger. An animal slowly accustomed to the action of the poison can support daily a dose greater than that fatal in ordinary cases.—On fine tar, by M. Adolphe Renard.—Remarks on the muscles and bones of the hind limb of *Hatteria punctata*, by M. A. Perin.—Comparative study of the lobed and reticulated Rhizopoda of fresh water, by M. Félix Le Dantec.—On the rests of *Vespariana*, L., of appearance of the earlier cells, by M. Charles Janet.—The fragments of the uppermost stratum of Ubaye, by MM. E. Thuy and W. Kilian.—On the conditions of propagation of typhoid fever, cholera, and exanthematous typhus, by M. Renard.

NEW SOUTH WALES.

Linnean Society, November 28, 1894.—The President, Prof. David, in the chair.—Re-description of *Aspidites ramsayi*, Macl., by Edgar R. White.—A review of the fossil jaws of the *Megapoda* in the Queensland Museum, by C. W. De Vis. The very fine collection of over eleven hundred dissociated jaws or portions of jaws in the Queensland Museum has been studied in the light of a knowledge of the nature and range of the variations, individual and specific, presented by the skulls of 470 individuals referable to sixteen existing species. The following species were described as new: *Palaorchestes parvus*, *Sthenurus pates*, *S. area*, *Halmaturus ramsayi*, *H. thor*, *H. dryas*, *H. cin*, *H. mira*, *H. siva*, *H. wshuu*, *Macropus magister*, *M. gan*, and *M. fians*.—Notes on some Land Planarians collected by Thos. Steel, Esq., on the Blue Mountains, N.S.W., by Dr. A. Dendy.—On a British bivalve nodose found in Australia and Tasmania, with its distribution; and on a new sub-genus of *Archid*, by J. Bazier.—*Cryptodon flexuosa*, Montagu, was recorded for the first time from Port Stephens, N.S.W., and Esperance Bay, Tasmania.—The name *Solantera*, Fischer 1880, being preoccupied by Duchassaing and Michelotti (1846), it was proposed to replace it by *Rossetaria*.—Description of a new Australian eel, by J. Douglas Ogilby.—*Gymnothorax gronowii*, sp. n., from Port Jackson, appeared to be closely allied to the Atlantic species *G. ocellatus*.—On a new Typhlophos previously confounded with *T. anguinosus*, Peters, by G. A. Boulenger, F.R.S. Botanical notes from the Technological Museum (part iii), by J. H. Maiden and R. T. Baker. The writers gave a list, with localities, of plants new to New South Wales; also notes on some rare or little known plants indigenous to the colony.—On a new species of *Enteropneusta* from the coast of New South Wales, by James P. Hill. The name *Pygospio australiensis* was proposed for the first described Australian species of Enteropneusta. It is peculiarly characterised externally by the great development of the genital wings which completely hide the gill area, and extend far into the hepatic region, and by the presence of two longitudinal subdermal stripes overlying the two ciliated bands of the arescine. In the mode of formation of its proboscis pore, it appears to be the most variable of all *Enteropneusta* hitherto described. The most interesting points in its internal anatomy are the presence of a median longitudinal infolding of the ventral wall of the heart bladder into the cavity of the same, the presence of a transverse vessel between the different proboscis vessels, and the much branched condition of the gonals. On a Platypus embryo from the intrauterine egg, by J. P. Hill and C. J. Martin. The embryo described was taken from one of two eggs just ready to be laid. The eggs measured 18 mm. by 13.5 mm., and were somewhat larger than the eggs described by Caldwell. The embryo more nearly resembled that of the Virginian species (*Didelphys*) of twenty-three hours, described by Seale, than any other embryo known to the authors. The Platypus embryo is, however, much longer.

BOOKS, PAMPHLET, and SERIALS RECEIVED.

BOOKS.—A Monograph of the Mycetozoa: A. Lister (London, Brit. Mus.).—Reisen in den Molukken. Prof. K. Martin, 2 Vols. Text and Plates (Leiden, Brill)—Harvard College, by an Oronian: Dr. G. B. Hill (Macmillan).—Annuaire, 1895, par le Bureau des Longitudes (Paris, Gauthier-Villars).—La Fabrication des Eaux-de-Vie: L. Jacquet (Paris, Gauthier-Villars).  
PAMPHLET.—An Essay on Southerly Busters: H. A. Hunt  
SERIALS.—Natural Science, January (Rait).—Astronomy & Astro-Physics, December (Wesley).—Journal of the Royal Microscopical Society, December (Williams).—Bulletin de l'Académie Impériale des Sciences de St Pétersbourg, September, October, November (St. Pétersbourg).—Bulletin of the American Mathematical Society, December (New York, Macmillan).—Humanitarian, January (Hutchinson).—Century Magazine, January (Unwin).—Contemporary Review, January (Lester).—Natural History of Plants, Part 9, Kerner and Oliver (Blackie).—Fortnightly Review, January (Chapman).—Seances de la Société Française de Physique, 1894. 2. Série (Paris).—School Review, December (Hamilton, New York).—Zeitschrift für Physikalische Chemie, xv. Band, 4. Heft (Leipzig, Engelmann).—New Review, January (Heinemann).—Bulletin de la Société de Géographie, 3. Trimestre 1894 (Paris).—Geological Magazine, January (Dolan).—Mind, January (Williams).—National Review, January (Arnold).—Cornhill Magazine, January (Smith, Elder).—Journal of the Royal Agricultural Society of England, Third Series, Vol. v. Part 4, No. 20 (Murray).—Annals of Scottish Natural History, January (Edinburgh, Douglas).—Internationales Archiv für Ethnographie, Band vii. Heft 5 and 6, and Supplement zu Band vii (Leiden, Brill).—Quarterly Journal of Microscopical Science, December (Churchill).—Essex Naturalist, Nos. 6–10, Vol. vii (Chelmsford, Durrant).—Scholar's Magazine, January (S. Low).—Philosophic Quarterly Review, No. 2 (Putnam).—Memoirs and Proceedings of the Manchester Literary and Philosophical Society, Fourth Series, V. 1. 3, No. 4 (Manchester).—Science Progress, January (Scientific Press).—Round the World, Part 1 (Newnes).—Medical Magazine, January (445 Strand).

CONTENTS.

PAGE

The Origins of Art. By Prof. A. C. Haddon . . . 241  
 Forbes's Handbook of Monkeys By R. L. . . . 242  
 Birds of the Wave and Woodland. By T. D. P. . . . 243  
 Our Book Shelf:—  
 Goto: "Studies on the Ectoparasitic Trematodes of Japan" . . . . . 244  
 Mason: "Woman's Share in Primitive Culture" . . . 244  
 Catchpool: "A Text-book of Sound" . . . . . 244  
 Geleick: "Ottica" . . . . . 244  
 Letters to the Editor:—  
 On the Liquefaction of Gases—A Claim for Priority.—Prof. Charles Olszewski; Prof. J. Dewar, F.R.S. . . . . 245  
 The Term "Acquired Characters."—Prof. E. Ray Lankester, F.R.S. . . . . 245  
 Boltzmann's Minimum Theorem. Edw. P. Culverwell . . . . . 246  
 Aurora of November 23, 1894.—Prof. A. S. Herschel, F.R.S. . . . . 246  
 Peculiarities of Psychological Research.—Prof. Oliver J. Lodge, F.R.S. . . . . 247  
 The Study of Cloud, (Illustrated.) By W. E. P. . . 248  
 Sir Charles Newton, K.C.B. . . . . 250  
 Notes . . . . . 251  
 Our Astronomical Column:—  
 The Greater Nebula of Orion . . . . . 253  
 The Transit of Mercury . . . . . 253  
 An Important Asteroid . . . . . 254  
 Prof. Adams' Collected Memoirs . . . . . 254  
 The Bird-Winged Butterflies of the East. (Illustrated.) By W. F. Kirby . . . . . 254  
 A New Element in the Nitrogen Group. By A. E. Tutton . . . . . 258  
 Science in the Magazines . . . . . 259  
 Seasonal Changes on Mars . . . . . 259  
 University and Educational Intelligence . . . . 261  
 Scientific Serials . . . . . 261  
 Societies and Academies . . . . . 262  
 Books, Pamphlet, and Serials Received . . . . . 261

THURSDAY, JANUARY 17, 1895.

## EPIGENESIS OR EVOLUTION.

*Zeit- und Streitfragen der Biologie.* Von Prof. Dr. Oscar Hertwig. Heft 1: Praformation oder Epigenese? Grundzüge einer Entwicklungs-theorie der Organismen. (Jena: Gustav Fischer, 1894.)

THE theory of preformation, or rather let us say pre-determination, as revived at the close of the nineteenth century, is much more formidable than its prototype of the eighteenth century. Not only is it stripped of all its earlier crudities, such as the doctrine of *emboîtement*, but it is supported by a mass of evidence accumulated by the researches of the last quarter of a century. Its fundamental assumption, that of the existence of minute, qualitatively unlike, ultimate particles of living matter, is strengthened, if not supported, by the analogy of the atomic theory, and the observed phenomena of mitosis accompanying the maturation of the ovum and spermatozoon, and the subsequent acts of impregnation and segmentation have been skilfully blended with the fundamental assumption in such a way that they are made to seem to be a proof of it. This strong position is now assailed by Dr. Oscar Hertwig, who is in many respects peculiarly well fitted to the task. He is the master of a simple, lucid and logical style, he has himself been, in conjunction with his brother, a pioneer in many of the discoveries on which the doctrine of predetermination is founded, and he has recently set himself to the task of verifying the experiments of Roux and others, and of examining the evidence which they afford for or against the doctrine which he attacks. His answer is unequivocal. The phenomena of development are to be explained on epigenetic, not on evolutionary grounds, and the latter hypothesis is contradicted by a number of well-ascertained facts.

In an introductory chapter Dr. Hertwig refers to and accepts Roux's definition of development, evolution, and epigenesis, which may be repeated here, as they give precision to terms which are often loosely used or little understood. By "development" is meant the origin of perceptible heterogeneity. Epigenesis means, not merely the formal increase of perceptible heterogeneity in a substance apparently similar but possibly extremely complex, but a real increase of pre-existing heterogeneity. Evolution means, the becoming perceptible of pre-existing latent imperceptible differences. Dr. Hertwig goes on to describe the positions taken up by Weismann and Roux, and deals particularly with the former, who, as he shows, regards the germ as a veritable microcosm, in which every separate variable part which appears in the course of the whole ontogeny is represented by a living article; on the characters of these particles the characters of the parts of the adult organism, whether composed of one cell or many, depend. The sum of these particles forms the germ-plasm. Agreeing with Weismann that a theory of heredity must be founded on and brought into harmony with the cell theory (and therefore rejecting the opposite view of Nageli), Dr. Hertwig proceeds to attack Weismann's fundamental

assumptions. As he rightly says, the foundation and corner-stone of Weismann's theory is the assumption of differential or anisocleronomic<sup>1</sup> division of the cell nucleus. All-important as this assumption is, there is no foundation of fact to be found for it in all Weismann's work. Instead we find purely dialectical argument, and more than this, we find that Weismann has attributed the most opposite characters to his "idioplasm," declaring it, in one place, to be stable and unchangeable, in another to be labile and changeable. But, Hertwig points out, the facts are directly opposed to the assumption of anisocleronomic division of the germ substance. In the Protozoa the division is clearly isocleronomic, and we know of no instance among them in which the act of division, as such, is a means of producing new species. Moreover, the numerous cases (e.g. *Podophrya gemmipara*) of complicated life histories among Protozoa show that the dissimilarity which may at first obtain between the two products of cell division is no indication of permanent and essential difference. The case of the lowest multicellular organisms is adduced as showing that in these also the cell division is isocleronomic, for each cell of which the soma of many of these organisms is composed, retains the power of giving rise to the whole organism. The phenomena of regeneration and heteromorphosis afford evidence that there are in the tissues of many highly differentiated organisms cells, or groups of cells, which retain, in a high degree, the power of giving rise to new and complicated structures, and this is particularly exemplified in cases of heteromorphosis, which is to be distinguished from regeneration by the fact that, in the former case, lost organs are replaced by organs which differ in form and function from those which were lost, or organs are, as a result of special conditions, produced in abnormal positions on the body. Under this head of phenomena of heteromorphosis, Dr. Hertwig groups the extraordinary phenomena which have been brought to light by his own researches and those of Driesch and E. B. Wilson on the segmenting ova of such different animals as frogs, echinids, and amphioxus, and these observations have been extended, since the publication of Dr. Hertwig's book, by the researches of Prof. Raffaelo Zoja on the developing ova of coelenterates. Briefly stated, the results of these experiments are as follows: In the case of echinids, amphioxus, and coelenterates, the first two, four, or even eight blastomeres may, by suitable means, be isolated without impairing their vitality. Each blastomere, instead of giving rise to an incomplete embryo, or a portion of an embryo, begins the developmental course afresh, as it were, and produces an embryo perfect in all its parts, but one-half, one-fourth, or one-eighth the size, as the case may be, of the normal embryo. In the case of the frog it was not possible to isolate the blastomeres; but Hertwig was able, by pressure, to so alter the segmentation, that the normal relations of the blastomeres, one to another, were completely changed, and yet a perfectly normal embryo resulted. Unquestionably this proves that, in the first stages of segmentation, at any rate, the division of the germ substance is not differen-

<sup>1</sup> The German words "erbgleich" and "erbgänglich" being untranslatable into English, I have coined the equivalents "isocleronomic" and "anisocleronomic" from the Greek *κλῆρονόμος* an heir.—G. C. B.

trial but integral, not qualitative but quantitative, and this undermines the most important of Weismann's positions.

Very important are Dr. Hertwig's criticisms on the doctrine of determinants, so sharply and clearly defined by Weismann. This doctrine is inseparably connected with that of the anisocleronomic division of the germ-plasm, and it might appear that if the latter is disproved, it is unnecessary to enter into a detailed criticism of what depends upon it. But the criticism is not without its utility, since, Dr. Hertwig shows us, the conception of determinants is only an extreme instance of a false conception of causality common in current biological literature. Weismann has supposed that the ultimate vital particles, which he calls biophors, are grouped in the germ-plasm into "determinants," and that every smallest cell-group in the adult organism which has definite characteristics and a definite situation is represented in the germ-plasm, both of ovum and spermatozoon, by a definite determinant. These last are so arranged in the germ-plasm, and are endowed with such special forces, that they are able, in the course of ontogeny, to move at the right time into the right place—this movement being effected by the almost purposive anisocleronomic division of the germ-plasm. This very definite idea is founded on an erroneous conception of the relations between primordium (Anlage) and primordial product, which are supposed to stand in relation to one another as cause and effect. More or less unconsciously, the biologist commonly assumes that, because a given animal proceeds of necessity from a given egg, there is an identity between primordium and primordial product: so much so, that the developing organism is often spoken of as if it were a self-contained system of forces, a sort of organic perpetuum mobile. He overlooks the fact that for the fulfilment of the developmental processes many other conditions are necessary, without which the primordium could never arrive at the condition of its final product. Between the two there is clearly no identity, and it is false and mischievous to suppose, as the older evolutionists did, and the new evolutionists are again trying to make us believe, that the perceptible heterogeneity of the last stage of the developmental process is only the final expression of an invisible corresponding heterogeneity of the first stage. Throughout the whole of the ontogeny there is an exchange of material taking place, the adult has arrived not only to its bulk, but to its complexity as the result of metabolism; inorganic material is perpetually changed into organic, and serves for the growth and development of the primordia. It is true that the form changes are constant and invariable for the species, from a certain kind of germ a certain kind of animal is invariably produced, but is not this largely because, in the ordinary course of events, the ovicel is always subject to similar conditions of assimilation and excretion, and to similar conditions of gravity, light, temperature, &c.? Throughout the course of organic development things which were external are transformed into things internal, and the primordium grows and is changed at the expense of the environment. In this respecting our attention the fact that an organism is above all things metabolic, that its growth and changes are the result of its metabolic

activity, and that its ultimate mass is the result of assimilation, of the taking up and making an integral part of itself of matter which was previously apart and different from itself. Dr. Hertwig does a real service to biology. He forces us back to the consideration that physiology and morphology are not two separate and independent lines of study, but that they are so closely interdependent that no generalisations can be made on the evidence of one kind of observation alone: they must be supported by equally cogent arguments from the other side. The theories of the evolutionists are essentially morphological, and in this they resemble the theories of the last century, that they take no account of one of the most wonderful of all vital phenomena, that of metabolism, but strive to find an explanation of the ultimate perceptible differences in form by asserting that the differences were always there, and have only expanded so as to become perceptible. Weismann's attempt to deal with this question by assigning the power of change as the result of metabolism to the biophors, does not really offer more than a purely formal explanation of the question, for what he predicates of the biophors may very well be predicated of the whole cell. Our ideas of increase of complexity as the result of metabolism are made none the clearer by shifting the responsibility of the change, if one may express oneself so, to subordinate parts.

It is indeed apparent, on reflection, that the characters of the perfected organism are not and cannot be the characters of a single cell or even of a cell fusion such as the oosperm—and the converse of this is true that the characters of a cell cannot be the characters of the perfected organism. For what is a perfected metazoon or metaphyte but an aggregation of cells of most numerous and unlike characters? The characteristics of the perfected organism are the result of the correlation of all its parts, of the relations of cell to cell and of groups of cells to groups of cells: and are we to attribute to a single cell which has no relations characters which are essentially the results of the relations of innumerable cells one to another? Of the importance of the correlation of the parts of the perfected organism we can have no doubt, nor can we escape from the corollary that the characteristics of the organism reside not so much in the cells themselves as in the aggregation and interdependence of the cells, and if we may demur to the suggestion of the *colonial* character of the metazoa which is contained in the sentence, we must at least admit much of the truth of Hertwig's statement (p. 85):

"That the ovum is an organism which multiplies itself by division into many organisms similar to itself, and that it is through the reciprocal action (*Wechselwirkung*) of all these many elementary organisms at each stage of the development that the organism as a whole is gradually and progressively established."

Dr. Hertwig institutes the comparison which was made long ago by Herbert Spencer, between an organism and a human society, and it is worth while mentioning his illustration as showing his conception of the relations of the cell to the organism. The organisation of a complex human society, he says, is something new, and not to be thought of as existing beforehand in the organisation of an individual man. It is nevertheless founded in



human nature, but we cannot in gross, mechanical fashion seek for the organisation of a society in the primitive nature of man. In a like manner the character of the perfected organism is founded on the nature of the cells which compose it, but it contains in itself a new element, a heterogeneity due to correlation and reciprocity, which is limited by the specific nature of the cell substance, but is not to be sought for as a specific constituent of the substance of any individual cell. Starting from this point of view, we may consider Dr. Hertwig's own doctrines which he sets forth in the second part of his work entitled "*Gedanken zu einer Entwicklungstheorie der Organismen.*" Whereas Weismann seeks the cause of the orderly development of the primordium in the primordial substance itself, Hertwig considers that the development of the primordium is dependent on conditions or causes which lie outside of the primordial substance of the ovicell, but are none the less produced in regular succession during the process of ontogeny. Such are, in the first instance, the reciprocal relations in which cells stand one to another in increasing degrees of complexity, whilst they increase in number by division; and in the second place, the action of the external environment on the organism. The argument in support of this proposition is given in so condensed a form that it is almost impossible to give any part or abstract of it without giving the whole. The following sentence is so important that it may be quoted at length, and the reader should refer to the work itself for the rest of the argument and the conclusion:—

"One of the most important and essential causes of the appearance of heterogeneity in the course of development is to be found in the specific power of the ovicell, to multiply itself by division. From this fact alone, that the nuclear substance is able, in the course of most manifold chemical processes, to assimilate, step by step, matter from the reserve material stored up in the egg, and oxygen from the surrounding atmosphere, it is able at the same time to evoke an ever-increasing heterogeneity. The increase of mass of the nuclear substance involves its progressive division into 2, 4, 8, 16 parts, and so forth. But the division is again the cause of a constantly changing spatial distribution of the substance. The 2, 4, 8, 16 and following nuclei which arise by division give way to one another in opposite directions, and attain to new positions at definite distances from one another within the limits of the egg. Whilst all the material particles of the ovum were at first arranged round the fertilised nucleus as a single centre of force, they are now grouped around as many individual centres as there are new nuclei, and they segregate themselves around these as cells. It is therefore clear that the ovum as an unicellular organism, when compared with the ovum as a multicellular organism, has altered its quality to an important extent, and that merely by the process of isochronomic division."

This is what Hertwig calls the function of growth as a form-producing principle. The other principles which he invokes are the relations of the cells to external conditions, or the function of their position, and finally the reciprocal influence of the parts of the whole on one another and on the whole, or the function of correlation. It is not to be denied that these are principles of considerable importance, and it may be said that their importance has never quite been lost sight of, but they do not bring us any nearer to the explanation of the totally different

reaction of apparently similar substances to the same stimuli. What we want to know is why, when we place under a hen her own eggs and those of a duck, and so expose them to identical conditions, chickens and ducklings are hatched as unlike one another as may be. The answer given, "the difference can be due to nothing else than to the different nature the different micellar structure) of the substance," is unsatisfactory, in that it is only a restatement of the fact, and is not an explanation at all. In attempting to give a more definite account of the different natures of the egg substance, Hertwig is obliged to take his stand upon much the same ground as the evolutionists. "In the hen's egg the species is present as fully as in the hen, and the hen's egg is as different from the frog's egg as the hen is from the frog." He is compelled to agree with the evolutionists in assuming the existence of a specific, and even of a very highly organised primordial substance as a basis of developmental processes, but he claims that his concept of this substance is different from and better than theirs, in that he ascribes to the primordial substance or germ-plasm characters which are congruous with the concept and character of a cell, and does not ascribe to it the innumerable characteristics which are only evoked through the union of many cells and the concomitant action of external conditions. The distinction appears to be a slight one, yet on careful consideration it assumes more important dimensions. Hertwig, if I interpret him rightly, conceives of the germ-plasm as a substance of many and definite potentialities. He does not attribute this potentiality to one part, and that to another part of the germ-plasm, but argues that as a result of multiplication by division the relations of the cells with their contained germ-plasm are continually undergoing change, both with regard to one another and to the environment. In consequence of the different conditions thus induced, this potentiality is evoked in the germ-plasm of one cell, that in the germ-plasm of another, and so on in ever-increasing grades of complexity. The differentiation of any cell is the result of its position, which determines which of its many potentialities shall be called into action. It is the reaction of the living substance to the stimulus which evokes a particular potentiality, which brings about its form changes, and it may be supposed that a profound form change following on constant action in one direction incapacitates the cell in question for the performance of any of the many other duties for which it was primitively fitted. This conception is epigenetic in that it admits the coming into being of a new heterogeneity which was not pre-existent in the ovum as such; that which was present was a capacity for certain kinds of heterogeneity. Very different is the conception of the evolutionists, who define the exact potentialities of the germ-plasm, and assign each to a given material particle or group of particles. The heterogeneity is already present; thenceforward there is no room for the increase of complexity in response to external stimuli. Dr. Hertwig rightly says that Weismann's explanation amounts to nothing more than a renunciation of an explanation. His doctrine of determinants leads us into an invisible world in which there is no foothold for research. For this reason, if for no other, we should welcome Dr. Oscar Hertwig's invitation to return to the paths

of epigenesis. A theory which has a formal answer for every question, which regards everything that we can see and lay hold of as predetermined and unalterable, which relegates the causes of phenomena to the unseen and unknowable—such a theory, if accepted as true, does not stimulate, but stifles inquiry. Fortunately it has had the opposite result. It has not been accepted, and it has developed an attack of a brilliant and overwhelming character. All the best arguments which Dr. Hertwig can bring against the theory of predetermination are derived, not from simple observation, but from experiment. A few simply conceived interferences with the normal course of the segmentation of the ovum have sufficed to strike down the doctrine of determinants. May we not hope that an extension of these methods may illuminate the regions which are still hidden from us? After all his attempts to supply an acceptable alternative to Weismann's scheme, Dr. O. Hertwig makes a partial confession of failure. To many his failure will seem complete, and it must be so since the evidence derived from experiment is as yet wholly inadequate. But his attempts indicate the paths along which research may be conducted, and he is very right when he claims, in conclusion, that it is the great merit of his conception of the developmental processes, that it opens the gates once more to research, with some brighter hope of results than the formal theory of predetermination afforded us.

G. C. BOURNE.

#### COAL-DUST AND COLLIERY EXPLOSIONS.

*Coal-Dust an Explosive Agent, as shown by an Examination of the Camerton Explosion.* By Donald M. D. Stuart. London: Office of the *Colliery Manager*, and E. and F. N. Spon.

IT is significant of the conservatism—not always wholly disinterested—that surrounds an old-established industry that, in spite of all that has been written and said on the action of coal-dust as an explosive agent during the last twenty years, we should still find people persistently clinging to the belief that the only possible cause of a colliery explosion *must* be fire-damp. It would be amusing, were the matter less serious, to note the extraordinary hypotheses and absurd surmises to which the believers in this time-honoured doctrine are occasionally driven in order to account for the existence of fire-damp in places where the common testimony of unbiassed people affords no proof of its presence. The hard logic of facts is, however, surely, even if slowly, undermining the mass of prejudice with which this question has been surrounded, and we may hope that before the close of the century the action of the Legislature will compel these people, whose obstinate unbelief jeopardises men's lives, to give practical heed, even more directly than at present, to the teachings of intelligent observation and inspection. The causes and conditions which lead to a colliery explosion are now so well understood that such a catastrophe ought to be no longer possible. If it does occur, we must lay the blame on the management and discipline of the mine, and it should not be difficult, under these circumstances, to fix the responsibility.

The master of a vessel who carelessly navigates his ship, is liable to have his certificate dealt with in a very summary fashion. It does not avail him to plead that his crew are picked from a class that is proverbially reckless and foolhardy, and that his "look-out," therefore, was probably in fault. The Assessors take it for granted that he has a proper knowledge of his business, and they hold him responsible for the discipline on his vessel. Public opinion demands that a mine-manager should be treated in a similar manner. How difficult it is for the law, in spite of the length of its arm, to get at a manager who has been guilty of culpable carelessness, has been shown in more than one inquiry that could be named.

As an illustration of the mental attitude to which we allude, we may refer to a recent report on the cause of the explosion at the Albion Colliery, South Wales, in June last. All the circumstances connected with that explosion seemed to indicate that it was due to the same cause as that which accounted for the explosions at the Park Slip, Apedale, and Malago Collieries, viz. the presence of coal-dust, and this conclusion was confirmed by the report of the inspectors appointed by the Home Office to inspect the colliery.

In a report prepared for the colliery proprietors by six engineers, we find that these gentlemen are unanimously of opinion that the disaster was caused by an outburst of fire-damp, and they have great satisfaction in stating that no blame in the matter can be attributed to any of the officials or employé's. There is no wonder, in view of this conflict of testimony, that the men of the Rhondda district should have demanded a fresh inquiry by the Government into the cause of the disaster.

The changes of opinion among "practical" men on this question of coal-dust are very suggestive, and strikingly exemplify the course through which a new truth has to run when it is in conflict with the settled conviction of interested persons. Like the course of true love, it does not run at all smooth under these circumstances. The idea that coal-dust could be the cause of a colliery explosion was, in the outset, scouted as absurd. Then, as facts multiplied, the dust was allowed to have a share in the catastrophe: it aggravated the violence of a fire-damp explosion. Next, the proportion of the fire-damp became smaller by degrees, until it reached the vanishing-point. Now we have reached the stage that all dusts are not explosive, and the colliery manager is satisfied that his dust is not as other men's dust. Even in the case of those who were more receptive of the teaching of experiment and of trained observation, the recognition of the real facts has had to run the conventional course. First they were not true, then they were not new, and we knew of them before; for did not Faraday and Lyell tell us all about the matter in the Haswell report? In a question of this kind, colliery management ought to be in advance of public opinion. That it has not always been so in the past, the history of coal-mining shows only too plainly. It was the shock to public sentiment, caused by a succession of disastrous explosions, which occurred in the early part of this century, that indirectly brought about a revolution in the art of coal-getting. People in the colliery districts, who were witnesses of the terrible loss

of human life, and of the misery and destitution that followed it, asked their fellows if this ought to be part of the price to be paid for coal, and the answer was given in no uncertain tones. Government inspection was insisted upon, and, in spite of persistent opposition, eventually obtained. In the outset, the character of the inspection was not always what it should be; but, little by little, this has improved. We have a better trained class of men sent out by the Home Office now than formerly, and their hands have been gradually strengthened by the Legislature, although, perhaps, not to the extent that is desirable.

Statistics show that this intelligent inspection is gradually making its influence felt. Tested by the ratio of fatalities to number of men employed, and to amount of material raised, there is a slow but decided improvement. Of course, even under the most ideal system of inspection, coal-mining will continue to be a hazardous occupation; but this at least we may hope, that the steady sacrifice of 1000 victims a year, which that ruthless potentate, Old King Coal, seems to demand, shall not continue to be augmented by catastrophes that ought to be considered as preventable.

Mr. Stuart's book is to be welcome, therefore, as adding one more link to the chain of evidence which establishes the fact that coal-dust may be the most important and, at times, even the only agent in bringing about a colliery explosion. About a year ago an explosion occurred at the Camerton Collieries in Somersetshire, the significant feature of which was that it took place in a mine wholly free from fire-damp. All the circumstances connected with this explosion were brought to the knowledge of Mr. Chamberlain's Commission by Mr. Garthwaite, the general manager, and were fully inquired into by H.M.'s inspectors. Mr. Stuart's examination was made independently of the official investigation, and it is satisfactory to note that as regards the main conclusion there is absolute unanimity on all sides. There can be no possible doubt, therefore, that the explosion of November 14, 1893, at the New Collieries, Camerton Court, was due to coal-dust, and to coal-dust alone, initiated by a gunpowder shot, and most probably by what is technically known as a "blown-out shot." Mr. Stuart's examination showed that there were no "extraordinary circumstances" present: the shot-firing was an ordinary operation, the presence of coal-dust was a normal circumstance, and the work was being done by a competent man. "The angle and declivity of the hole were such, that if the gunpowder were expelled, it would directly strike the dust; but it was so placed in the judgment of an experienced miner. . . . In the presence of this explosion, therefore, conjecture upon the supposed innocuousness of a gunpowder shot in a dry and dusty non-gaseous mine is at an end."

Whilst we wholly agree with Mr. Stuart in this conclusion, we are not altogether at one with him in regard to his explanation of the chemical process of a coal-dust explosion. Mr. Stuart appears to be of opinion that a coal-dust explosion is in reality only another form of a gas explosion. The action of the heated products of the exploded gunpowder is, he assumes, to cause the dust to experience a kind of destructive distillation whereby

hydrogen and gaseous hydrocarbons are formed, which at the high temperature combine explosively with the oxygen of the air of the mine. Whether there is any necessity to invoke this distillatory process as an explanation of the phenomena, is extremely doubtful. Without expressing any final opinion on this point, it may be pointed out that no definite relation between the bituminous character of the dust and its "sensitiveness" as an explosive agent has been established. The dry mines of South Wales, where some of the most formidable explosions of recent times have occurred, yield a dust which is relatively rich in carbon, and which affords no very large quantity of gas on distillation.

We would commend this book to the thoughtful attention of every colliery manager, with, however, the reservation that Mr. Stuart's theories are not to be accepted as of the same value as his facts. So long as he confines himself to the orderly arrangement and analysis of these facts he is on perfectly safe ground. The weakest portion of the book is that in which the author seeks to elucidate the chemical and physical phenomena of a coal-dust explosion, by the application of imperfect thermal data and of irrelevant chemical observations.

#### THE MODE OF LIFE OF MARINE ANIMALS.

*Die Lebensweise der Meeresthiere. Beobachtungen über das Leben der geologisch-wichtigen Thiere.* Von

Johannes Walther. Zweiter Theil einer Einleitung in die Geologie als historische Wissenschaft. (Jena: Gustav Fischer, 1893.)

THIS is the second part of Prof. Walther's projected extensive geological treatise, the first part of which—on the Bionomy of the Sea—appeared some time ago. Of the three titles given, the second, or subsidiary one, seems best to describe the scope of the present book. It is not, as might be supposed from the primary title, a treatise on the physiology of marine animals—would that it were! that is still a great desideratum in biology—but is rather some observations on certain points in the life-relations, or mode of occurrence, of certain marine animals, viz. those which are of importance to the geologist [and no less to the biologist] as being the present-day representatives of former animals now preserved as fossils. Walther's idea is that we must study the relations of organisms to their environment at the present day, before drawing deductions from fossil remains as to the physical conditions of past geological periods. His object is to lay a sound foundation of fact, as to the mode of occurrence of particular sets of animals, upon which to base an account of the history or development of the events chronicled in the rocks. The idea is a sound enough one, if not very original—it must surely have been present, consciously or not, in the minds of various geological and biological writers and the conclusions arrived at, if really based upon a sufficiently large accumulation of statistics, will no doubt be a valuable guide to the geologist in forming his opinions. The book, if very complete in its series of facts, would also be a useful reference work to the zoologist; but it may be doubted, on an examination of the lists given by

Walther, whether they are a sufficiently exhaustive compilation to inspire thorough confidence.

For example, the information as to the geographical distribution of species is rather unequal, being detailed in some cases, and decidedly meagre in others, as when for *Lageni sulcata* is given only "im Mittelmeer," and when for *Crinia anomala* the only north-west European locality is the Clyde! While, on the other hand, such minute local detail is given as that *Globigerina bulloides* is not uncommon in the brackish water of the Dee from Chester to Hilbre Island. A number of detailed criticisms of this kind might be made, such as the extraordinary entry "*Lito* 1, 450 faths," when several species of the genus are found in quite shallow water. But probably enough has been said to show that the lists are by no means complete.

The plan of the book is, briefly, as follows: first, the gaps in the palæontological record, and their causes, are discussed: then the following groups are treated in succession: Foraminifera, Radiolaria, Spongia, Anthozoa, Crinoidea, Asteroidea, Echinoidea, Holothuroidea, Bryozoa, Brachiopoda, Lamellibranchiata, Gastropoda, Cephalopoda, and Crustacea. A few general questions are discussed. The author alludes to the well-known fact that some of the most abundant groups in the sea are almost unrepresented in the fossil series, and that even amongst animals with hard parts the fossils of a particular bed might inadequately represent what had been the living assemblage at that spot. He quotes Edward Forbes' account of the natural history of a shell-bed off the north-west of the Isle of Man, and his later observations in the Egean Sea, to show that even the fresh dead remains of organisms on the sea-floor do not always correctly show the relative abundance of the living species.

In each group, after a short account of the characters, mode of occurrence, &c., there follows a list of genera and species, with an indication of the distribution and range in depth, compiled from *Challenger* reports, monographs, and other sources; but there is a want of correlation and digestion of the facts, the nomenclature is not up to date, and the same species sometimes occurs several times under different names: e.g. on p. 308, *Ophiothrix fragilis* appears three times under the names *Ophiocoma rosula*, *Ophiothrix fragilis*, and *Ophiothrix rosula*, with a different range in depth each time. Occasionally an animal is found in the wrong group altogether, as a Holothurian amongst the Asterids, and an Ascidian in the Gastropods. However, Prof. Walther has brought together a considerable amount of material which those who are interested in the distribution of animals in the sea, and the association of species to form "faunas" characteristic of particular regions, will have to utilise. For this the marine zoologists and the geologists will no doubt be grateful, and will, with profit, consult the lists; but I fear they will also sometimes regret that the author had not taken more pains to digest his facts and to correct his proofs. Many old pieces of interesting information are given, but there is still room in some book on marine faunas for a detailed account of characteristic assemblage of animals with as full a description as can be given of their physical surroundings and their variations.

W. A. H.

### OUR BOOK SHELF.

*Elementary Qualitative Chemical Analysis.* By Prof. Frank Clowes, D.Sc., and J. B. Coleman. Pp. 180. (London: J. and A. Churchill, 1894.)

*Tables and Directions for the Qualitative Chemical Analysis of Moderately Complex Mixtures of Salts.* By M. M. Pattison Muir, M.A. Pp. 44. (London: Longmans, Green, and Co., 1895.)

*Laboratory Exercise Book for Chemical Students.* By E. Francis, F.C.S. (London: Blackie and Son.)

THE first of these books is an abridgement of Prof. Clowes' text-book on qualitative analysis, adapted for use in the laboratories of schools and colleges. For the most part, the book is like a host of others of the same kind. It differs from many of them, however, in the fact that the first fifty pages is devoted to instructions on the preparation of apparatus, to experiments illustrating the preparation and properties of certain gases and liquids, to descriptions of analytical operations, and directions for the performance of ordinary processes of chemical manipulation. Work of this character forms by far the best introduction to a course of practical chemistry, and it has an educational value, which is more than can be said for mere test-tubing. On account of this and one or two other notable features, the book will probably take a permanent place among laboratory guides.

"These tables and directions" (writes Mr. Pattison Muir) "are intended for the guidance of students who are acquainted with the principles of qualitative analysis, and who are able to make a qualitative analysis of a simple salt, and of a mixture of salts containing not more than a single metal in any one group, and three or four of the common acids." The student who has passed through an elementary course of practical chemistry is frequently puzzled how to conduct an analysis of moderately complex mixtures of salts and the commoner metals and acids, or an analysis of metals and alloys. Mr. Muir's book tells exactly what to do in such cases. By following the directions given, it would hardly be possible for the young analyst to go wrong. The processes described are easily carried out, and are concisely stated. A point worth noting is that the formulæ of solids are printed in heavy type; of liquids or substances in solution, in ordinary type; and of gases, in italics. This method of indicating the physical states of substances certainly possesses advantages. Altogether the book is a handy and trustworthy manual for analytical chemists.

The exercise book arranged by Mr. Francis has apparently been designed to take the place of the laboratory note-book. It opens with a few exercises in practical chemistry, the experiments being briefly, sometimes too briefly, described; and blank spaces are left for the entry of results. Then come a set of analytical tables, and a number of blank forms in which all the steps in the analysis of a mixture of two simple salts are indicated, spaces being left for the student to fill up with his inferences. The average student of practical chemistry works like a machine now, and we have no doubt that these tables will be after his own heart, for they only leave him to fill in his observations as if he were answering the questions in a census paper. The book may serve to drill the student into carrying out his tests in the proper order, but it will not benefit him mentally.

*Elements of Astronomy.* By G. W. Parker, M.A. (London: Longmans, Green, and Co., 1894.)

THIS is one of the books in which astronomy seems to be regarded as a subject which is to be studied much in the same way as one would take up an additional book of Euclid. It abounds in definitions, propositions, and

corollaries; the diagrams of instruments scarcely give any ideas of what they are intended to represent; and the descriptive part of the subject might have been omitted without much sacrifice. The ground covered is that which is ordinarily understood by an elementary treatment of mathematical astronomy, dealing chiefly with the considerations relating to the positions, movements, dimensions, and distances of the various heavenly bodies, but includes also some very scanty references to their telescopic appearances. On the whole, the various points are clearly, though shortly, explained, but there is much to suggest that the author would be all the better for some little observatory practice; for example, his method of determining the angular value of a micrometer by means of the sun (p. 48) is scarcely practicable, and a sun-spot 13,000 miles long is by no means to be classed as one of the largest spots (p. 68). It may be pointed out, also, that a single observer, by observing at intervals of twelve hours, gets better results for the parallax of Mars than two working in the way indicated on p. 115. A ship's mean time at sea, too, is usually determined by one observation near the prime-vertical, and not by the method of equal altitudes.

In less than a dozen pages the author attempts to give an idea of the classification of the stars, and of "the principal discoveries which have been made in modern times, chiefly by means of spectroscopic analysis, with their nature and physical condition" (p. 203). The omission of the solar prominences in an account of the phenomena of a solar eclipse, is a good indication of the very feeble character of this chapter.

The book is intended specially for students preparing for University examinations, and by such it may be found useful.

LETTERS TO THE EDITOR.

{The Editor does not hold himself responsible for opinions expressed by his correspondents. Neither can he undertake to return, or to correspond with the writers of, rejected manuscripts intended for this or any other part of NATURE. No notice is taken of anonymous communications.}

Exploration at Ruwenzori.

PERHAPS it may interest your readers to give a short account of Ruwenzori, where I have now spent four months. The mountain is a very difficult one to study, on account of the difficulty of reaching the most interesting part. Taking a sort of botanical section from the shore of the Albert Edward Nyanza, one finds first a series of grassy plains covered with *Andropogon* some two feet high, and in certain months supporting large herds of elephants, Kudu, and Lurwali antelopes. This is in part the old level of the lake, and in part gravel and sand brought by the numerous rivers; in places it is dotted by *Acacia* and the tree *Euphorbia*, which has something of the appearance of an enormous chandelier. After leaving this plain, one comes to a series of small hills from 4000 to 5000 feet in height, which have been apparently cut out of the mountain by the numerous rivers and streams. Some of these are covered with patches of cultivation, banana plantations, &c.; usually these are hidden from the main road. When one reaches the mountain proper, one finds up to 7000 feet a steep ascent covered with grass and small shrubs, usually three to four feet high. The valleys in this part are usually very steep V-shaped trenches, and cultivation is abundant everywhere, sometimes over 7000 feet, and in the Wakonija country the edible *Arium* is grown up to 7400 feet or more. This height, 7000 to 8000 feet, marks the beginning of the forest. It is composed of deciduous trees, sometimes with a very thick undergrowth; sometimes it is pretty open, with a profusion of fern and moss on the old trunks, and creepers in some places. I have found tree ferns and *Begonia*, but usually the flowers are rather pale in colour, or quite inconspicuous. At 8000 feet another distinct change takes place, and a wilderness of decaying young and mature bamboos replaces the trees. Here and there these are hung with creepers, but the predominant feature is the wetness of everything. Moss covers almost every trunk below, and amongst

the roots are only very watery plants, such as *Urticaceæ*. At 9600 feet another change takes place; bamboos disappear completely, and tree heather takes its place. In a dry part of the mountain one finds a charming little violet, a *Cardamine*, *Galium*, *Epilobium*, *Rubus*, &c. In wetter places one finds a regular peat-moss with *Sphagnum*, beautiful orchids, and short heather; in another place one will find enormous trees of heather, usually gnarled and twisted in growth—tree *Senecios*, tree *Hypericums*, &c. This region seems to extend to the snow (which, I am sorry to say, I have not been able to reach). On my highest attempt, I could see the heather trees apparently higher than the snow. On another attempt to get to the summit, I found what seems to me *Achemilla alpina*! One feature of the mountain is the extreme scarcity of animals and birds. In the lower forest there are bushbuck, baboons, and two other sorts of monkeys; one the magnificent black and white-furred kind from which grenadiers' shakos were made, and another with short slatey fur, which is new to me.

Perhaps the commonest birds are the sunbirds; one green, yellow, and crimson, I have seen above 10,000 feet, and I have also seen (though I am almost afraid to say it) a robin, and a goldfinch.

As to the geology of the mountain, I do not care to risk an opinion at present, but I have taken many specimens which I hope may solve some of the questions. I think glaciers must have extended seven to eight miles down two of the valleys, but there was no evidence to my mind of any extensive glaciation. I think I am right in saying that the Salt Lake is nothing but an extinct volcanic crater, and in several places along the east side of the mountain there are others, or a small chain of volcanoes; usually the chain radiates from the centre of the mountain.

I hope to start to-morrow for Ujiji, my object being to see whether a practicable route exists from Tanganyika to the Albert Edward Nyanza. I only hope I shall be able to bring my collections safely home.

G. F. SCOTT ELLIOT.

Salt Lake, Ruwenzori, August 2, 1894.

The Alleged Absoluteness of Motions of Rotation.

I MUST confess that discussions upon mathematical metaphysics appear to me to be somewhat unpractical. They are suggestive of the case upon which Serjeant Snubbin was engaged, which related to a right of way "leading from some place which nobody ever came from, to some other place which nobody ever went to." Nevertheless, I propose to offer some remarks upon this subject.

That absolute motions of translation and rotation exist appears to me too clear for argument; but whether our senses are capable of taking cognisance of them and reducing them to exact measurement, is quite another matter. The view advocated by Prof. Greenhill appears to be that motions of rotation are determinate—that is to say, they are capable of exact measurement within the limits of experimental error; whereas the contrary is the case with motions of translation. Mr. Love, on the other hand, holds that neither kind of motion is determinate in the above sense. Now a knowledge of the absolute value of the velocity of translation of any object involves a knowledge of the magnitude and direction of the sun's velocity in space; and until the latter has been determined, which has not yet been done, the former is necessarily unknown. It therefore follows that all motions of translation of which our senses are capable of taking cognisance are relative.

On the other hand, the motion of rotation of any object is independent of the motion of translation of the sun or any other body. If, therefore, it were in our power to construct a system of axes which either move parallel to themselves or whose angular motion is known, it would be possible to determine the absolute value of the angular velocity of any object. But even if it were possible to devise an experiment by which such a system of axes could be obtained, our results would only be accurate within the limits of experimental error. It may, therefore, be well to point out that, without inventing any new experiment, the angular velocity of any object may be accurately determined within the limits of experimental error in the following manner.

Select two stars, X and Y, whose proper motions are so minute that they have never been detected by the most refined observations. Through the sun and the two stars draw a plane, S X Y, and through the sun draw a line, S Z, perpendicular to

this plane; and let the motion be referred to S X, S Z, and a line perpendicular to them as axes. Now in consequence of the proper motions of the sun and the two stars, these lines will not constitute a system of axes which are either fixed in space or which move parallel to themselves; cease, finally, if these lines be taken as axes of reference the observed (or calculated) value of the motion of rotation of any object will necessarily be relative to these axes, and its *absolute* value cannot be determined without ascertaining the angular motion of the axes of reference. But since the two stars have been specially selected from amongst those whose proper motions have eluded detection, the angular motions of the axes will be so small compared with ordinary standards that the error caused by neglecting them will lie within the limits of experimental error. If, for example, we were to endeavour to calculate by the above method, or some similar one, the *absolute* angular velocities of the hands of a clock, or of a fly-wheel, the value which we should thereby obtain would be as exact as the existing state of mechanical and instrumental appliances admits.

A series of observations extending over several thousand years might of course reveal a proper motion of any two selected stars; but in the case of angular motions whose periods do not extend much beyond a century, the above method leads to results which are for most practical purposes exact.

I am therefore disposed to think that all motions of rotation of which our senses are capable of taking cognisance are *relative* rather than the exception of certain astronomical motions of very long periods, the *absolute* value of any motion of rotation which can be observed may be accurately determined within the limits of experimental error. A. B. BASSET.

Eleborough Hall, Holyport, Berks.

THE gist of Mr. Love's long letter, on pp. 198-9, seems to be that since the specification of a force or a motion depends upon the choice of axes, therefore the force or motion itself is similarly dependent. A slight extension of the same principle would make a velocity—say the velocity of light—depend upon whether it was to be expressed in miles per second or in centimetres per hour; and no extension at all is necessary to make it depend on whether it is referred to Grombridge 1830, or to some more quiescent body, if indeed the term quiescence may be allowed henceforth to have any meaning.

Tycho Brahe is said to have held that there was only a question of language between the Copernican and the Ptolemaic systems; but, with the exception of a semi-ironical Church compromise attributed to Descartes, he has been unfortunate in not finding a disciple of importance until the present moment.

It appears now to be equally true to say that the earth rises to meet a stone, as to say that a stone falls to meet the earth; and considerations of energy are of no consequence!

I just want to add one word of my own on the subject, to the effect that whereas the *rotation* of a body in an infinite homogeneous stagnant ocean would be unmeaning and unascertainable, except by reference to boundaries or other bodies, yet it does not follow that the *velocity* of a body through such an ocean would be either unmeaning, unascertainable, or unascertainable by experiment. It may be replied that such motion would still be relative to something; and to that I say by all means, but it is not relative to other bodies such as are competent to fix *rotation*, which is what Mr. Love is contending for.

As to the other question, about absoluteness of rotation, I shall be much interested in seeing what Prof. Greenhill, and with him Profs. Mach and Karl Pearson, have to say on the point. OLIVER J. LODGE.

Liverpool, December 20, 1894.

### The Quarrying of Granite in India.

At Bangalore, in Southern India, the quarrying of granite slabs by means of wood fire has been brought to such perfection, that an account of the method may not be out of place. The rock is a grey gneiss of granite of very irregular composition through unequal segregation of hornblende and the presence of numerous felspathic veins. But it is otherwise very compact, and forms solid masses uninterrupted by cracks for several hundred feet. Only near the surface the rock is found split parallel to the surface. In one quarry there is thus, for instance, a 4 feet thick horizontal layer of rather weathered rock,

underneath this another layer of fresh rock 3 feet thick; but below this the rock is entirely fresh, and not split. These layers are probably due to the variations of temperature, daily and seasonal.

The undisturbed rock is quarried by means of fire, and it is remarkable what large plates may be detached. I saw one plate of 60 feet greatest length, and 40 feet greatest width, and half a foot thickness. This thickness varied only one inch over the greater part of the area. The whole plate had been detached in one piece by means of wood-fire. Afterwards the plate was cut with blunt chisels into strips of 2½ feet width. So easily are these strips and slabs obtained, that it is quite common to see palisades of them used instead of boundary walls, and also to see them used as posts for huts, for telegraphs, and for railings and posts in gardens.

In one case, I observed the operation of burning over an area. A narrow line of wood-fire, perhaps 7 feet long, was gradually elongated, and at the same time moved forward over the tolerably even surface of solid rock. The line of fire was produced by dry logs of light wood, which were left burning in their position until strokes with a hammer indicated that the rock in front of the fire had become detached from the main mass underneath. The burning wood was then pushed forward a few inches, and left until the hammer again indicated that the slit had extended. Thus the fire was moved on, and at the same time the length of the line of fire was increased and made to be convex on the side of the fresh rock. The maximum length of the arc amounted to about 25 feet. It was only on this advancing line of fire that any heating took place, the portion which had been traversed being left to itself. This latter portion was covered with the ashes left by the wood, and with thin splinters which had been burst off. These splinters were only of about ¼ inch thickness, and a few inches across. They were quite independent of the general splitting of the rock, which was all the time going on at a depth of about five inches from the surface. The burning lasted eight hours, and the line of fire advanced at the average rate of nearly 6 feet an hour. The area actually passed over by the line of fire was 460 square feet, but as the crack extended about 3 feet on either side beyond the fire, the area of the entire slab which was set free measured about 740 square feet. All this was done with, may be, about 15 cwt. of wood. Taking the average thickness of the stone at 5 inches, and its specific gravity as 2.62, the result is 30 lbs. of stone quarried with 1 lb. of wood.

The old quarries have sloping sides formed of steps left by each successively split plate, each new plate extending to within about 2 feet of the step left by the preceding plate. Many plates are taken out in an inclined position, and as the directions of inclination differ, it follows that the action of the fire is quite independent of the original surface of the rock, and also of the direction of lamination and of the numerous veins in the rock. The action of the fire is thus very similar to that action which produces dykes and faults on a large scale, more or less independent of the nature of the rocks which are passed through.

The great uniformity of the thickness of the slabs formed by the above process is probably due to a regulating influence of the pre-existing crack. When the action of the fire is somewhat slower, it takes longer for the heat to penetrate down to the crack; when the action is quicker, there will be enough expansion produced in the upper layers, and the lower layers transmit the tension to the plane of the crack. Perhaps it will be possible some day to measure the temperature of the heated rock, when a certain agreement ought to be found between the tensile strength of the rock and the strain which the expansion by the heat produces in the so-far elastic rock.

Bangalore, December 19, 1894.

H. WARTH.

### Storm Statistics at Bidston.

THE Liverpool Observatory, erected at Bidston, on the Cheshire side of the estuary of the Mersey, stands on a slight eminence about 200 feet above the sea-level. The ascent is tolerably steep on each side except from the south, and with the Irish Sea on the north, and the rivers Mersey and Dee on the east and west sides respectively, there is nothing to obstruct or diminish the force of a passing storm. Self-recording anemometers of the Robinson and Osler types have been in position since 1867, and it is from the records of these instruments that

these statistics have been prepared. How far these records are absolutely correct is beside the present question; all the data have been obtained with the same instruments, and are strictly comparable between themselves.

It has been the custom at the observatory to treat as storms or gales, all occasions in which the Robinson anemometer recorded the horizontal velocity of the atmosphere as equal to or exceeding fifty miles an hour. The total number of instances in the twenty-eight years under consideration is 321, or an average slightly below one a month. It will frequently happen in stormy periods that the critical velocity will be registered, and be followed by a partial lull in the storm, to be succeeded by gusts of greater force. If these periods of comparative calm have lasted for about twenty-four hours, the disturbance would count as two storms, although probably both are parts of the same atmospheric disturbance.

The greatest number recorded in a year is in 1868, when no less than twenty-eight gales were reported; and the least occurs in 1880, when there were only two, and these neither long in continuance nor great in violence. It is not without significance—though, of course, it is not intended to insist upon the coincidence—that when the number of storms is plotted as an ordinate with the time for abscissa, a rough curve can be drawn among them giving maxima at practically equal intervals of five years, from 1868, with minima at intermediate dates. Or, if we take the sums of the maximum years 1868, 1873, 1878, &c., it is found that in the six we have records of eighty-three storms; while in the six years of minimum, 1871, 1875, 1880, &c., we have only thirty-seven.

It is scarcely necessary to refer to the direction in which storms approach the observatory, after what has been said of its geographical position. Roughly, they are all from the west, with slight deflections to the north and south. As a matter of fact, only five have deviated from this rule, and they have been either east or south-east, and have been comparatively slight in their character.

The time scale on which the velocities have been registered is not a very open one. The recording drum moves through rather less than one inch in an hour, and the habit has been to read and record the distance travelled from the commencement of one hour to the beginning of the next. The maximum hourly velocity is, therefore, not to be understood as the greatest in any sixty consecutive minutes, but as the greatest in one whole hour as marked by the clock. In this sense the following table, which exhibits the number of times the greatest hourly velocity has exceeded noticeable amounts, is to be understood:—

Recorded hourly velocity in miles.	No. of instances
50-60 ... ..	220
60-70 ... ..	68
70-80 ... ..	21
80-90 ... ..	10
Exceeding 90 ... ..	2

Here again, curiously enough, we find some slight evidence in favour of a five-year period. Not only do the two instances of the greatest velocity recorded in the observatory occur in years already noticed as those of maximum disturbance, but the average velocity of all storms in the years 1868, 1873, &c., is 59.2 miles, as compared with 57.9 miles in the years of minimum number.

Intimately connected with velocity, though probably a less accurate measure of the true force of a storm, is the pressure recorded per square foot. Here Bilston has long held a record for the British Isles, having placed to its credit a pressure of ninety pounds on March 9, 1871. The accuracy of this measure has often been questioned, and probably it is too great owing to the momentum in the moving parts of the machinery, but it is certainly the record of a far greater pressure than has ever been witnessed since. Considering over what small areas these excessive pressures are exercised, and the great variation that exists from moment to moment in the velocity of the wind when a storm is raging, it is not an impossible amount, but it would certainly be misleading to conclude that such a pressure was a measure of the force of the wind a few feet, or even a few inches, away from the pressure-plate. The hourly velocity on the occasion when this pressure was registered has frequently been exceeded, without reproducing similar pressures. Herein is represented the great difficulty in determining a simple relation between pressure and velocity, or, rather, the square of the velocity; for one may regard Hutton's law of wind-pressure on

a given obstructing surface as satisfactorily proved. The fact of such accidents as that referred to destroys any value that can be drawn from averages, but as a mere matter of figures, it appears that the average maximum hourly velocity for all storms is 58.4 miles, and the mean of the maximum pressures 37.6 lbs. This would require the factor for multiplying the square of the velocity in miles, to obtain the pressure per square foot, to be greater than one-tenth, which is evidently and necessarily erroneous, since we are comparing the accidental momentary pressure with the average velocity obtained throughout the entire hour. Taking the extreme pressures for what they are worth, the numbers come out as follows:—

Pressure in lbs. on sq. ft.	Number of instances.
20-30 ... ..	132
30-40 ... ..	111
40-50 ... ..	50
50-60 ... ..	11
60-70 ... ..	12

On two occasions the pressure registered was greater than 70 lbs. to the square foot, and on three did not reach twenty. Since the extreme pressures are in a sense accidental, and do not represent with any accuracy the force of a storm, it does not seem desirable to determine the relative pressures in what have been called years of maximum and minimum storm occurrence. But the general features are again borne out. The explanation here is probably that the greater the number of storms the greater the chance of finding a high pressure. It seems more profitable to inquire what is the average length of a storm, how long may a violent disturbance be expected to last. This question is unfortunately complicated by the fact already alluded to, that a storm may subside for a few hours and then reappear with its original violence. If the interruption is only for an hour or two, as already explained, the depression is considered as one, but only those hours are counted in which the registered velocity exceeds fifty miles. There are only two instances in which this amount of violence has been maintained for thirty consecutive hours, viz. in February, 1868, and again last February. The total number of stormy hours in the twenty-eight years is 1732, giving an average of 5.4 hours for each storm. Our local disturbances are therefore not of long duration.

An examination of the dates when gusty weather is most prevalent, goes neither to substantiate the ancient myth of the equinoctial gales, nor to uphold the evil supremacy which has long been assigned to the winds of March. Since no attempt has been made to equalise the lengths of the months, February has been somewhat unfairly treated in the following table; but notwithstanding this handicap, it possesses the unenviable privilege of compressing within its shortened limits more tempestuous weather than any other month.

Month.	No. of storms.	No. of stormy hours.
January ... ..	47	250
February ... ..	42	281
March ... ..	47	238
April ... ..	14	63
May ... ..	7	27
June ... ..	3	19
July ... ..	7	21
August ... ..	17	65
September ... ..	16	77
October ... ..	26	180
November ... ..	44	254
December ... ..	51	247
Total ... ..	321	1732

Of course one would expect to find the greatest number of storms in the winter; but that three-fourths of the whole should be compressed within five months of the year, is a greater disproportion than was expected. The variations of the barometer during these storms, and the dependence of this variation upon the direction of the wind, are of considerable interest, but may not very well be entered upon here while treating simply of numerical statistics.

WILLIAM E. PLUMMER.

Peculiarities of Psychical Research.

MR. DIXON asks in his first letter: Could an abnormal distribution of the cards affect the result, if certain precautions were taken? In his second letter he says there was nothing in his first letter to indicate that he under-estimated the import-

ance of "abnormal distributions." Well and good, if the S.P.R. have not underestimated the importance of examining the actual distribution of cards cut and of cards guessed, they will have kept a record of each card cut and each card guessed, card for card. If they have not done so, then their experiment is scientifically of no value; if they have done so, then the analysis of the distributions of the cards cut and the cards guessed ought to have accompanied any publication of these experiments. It is an obvious, but by no means sufficient, condition for a proper experiment. If the Secretary of the S.P.R. will place in my hands the actual analyses of the cards cut and the cards guessed made by a competent mathematician, then the publication in their *Publication* of the card guesses, and proving that they did at that time fully consider the point, and take this obvious precaution against deception, my estimation of the "scientific acumen" of the S.P.R. will at any rate on this point be mollified.

I, of course, do not refer to my friend Prof. Edgeworth's investigations, which do not touch the question of the distributions of cards cut and cards guessed. KARL PEARSON.

My attention to Prof. Lodge's method of "silencing" was in your issue of January 10. It bears very closely upon this question of the effect of psychical research upon the investigator's reasoning. He prefaces the preface of Mr. Podmore's book to show that the gentleman is not a "bigoted upholder of the certainty of telepathy," and the casual reader would scarcely guess that, in truth, I never asserted that he was. I complained of the very air of open-mindedness in that preface to which Prof. Lodge's citation witnesses, and showed by an instance, that in the body of the book question-begging occurred which was all the more dangerous on account of the liberal tone of the opening portion. I made no objection to the irrational prosecution of psychical research—only to its public recognition before it has produced more definite results than it has done so far. So much for the "silencing." It shows either that Prof. Lodge has not read my review, or that he has misunderstood it; and in either case it enforces my contention that these investigators are over-hasty. The phrase "irresponsible detractor," points in the same direction. H. G. WELLS.

**The Suspended Animation of Snakes.**

NATURE of December 6, p. 128, Mr. G. E. Hadow asks whether the snakes feign death for protective purposes, with intent to deceive, or whether the strange action is the result of a general nervous inhibition, produced reflexly by the action of fright, which would render it more or less analogous to a fainting fit. He and others of your readers will be interested in an additional observation that, in a measure, answers his question. The snake, a "hog-nose," "spreading adder," or "flowing viper," *Helicovera fuscicornis*, upon which Dr. L. C. G. has based his note in NATURE, November 29, p. 107, the origin of the discussion, was presented to me about five months ago. While in my possession it has repeatedly verified Dr. Long's statements; and, besides, it has proved that it does not depend upon the front alone. The latter is preceded by another action that apparently has not been published hitherto. After being teased a little, the animal, vigorously bending from side to side, the dorsal scapula raised and the vent slightly protruded, begins to squat itself over the back with urine and excrement, the odor of which is so excessively nauseous that observation is thereby driven back, the better satisfied if they escape without entering in their faces. If the teasing stops with this, the snake glides away to hide; but if still more worried, it assumes the condition that end in the trance-like condition, lasting on an average of half an hour, or until the creature feels that it may safely revive. The specimen still lives, and, on being held in a high hat on prolonged acquaintance. Much handling, and familiarity with annoyance have little effect on its behavior, or its disposition to take advantage of the peculiarities. In the inception of the habit these actions most likely were due to terror; possibly the trance was a reflex function, however, their utility may have been discovered, it is evident at the present time that confidence in them as a means of securing immunity from torment includes the practice on occasion when the avoidance of actual fright is hardly possible. At such times it would be difficult to convince witnesses that the snake is not intelligently employing what I know to be its best method of protection.

London, Eng., Mass., Dec. 27, 1894. S. GARMAN.

I do not think that Mr. Vincent can be right in supposing that the suspended animation of grass snakes has nothing to do with simulation. I have never observed it in the case of a snake when unmolested in a glass case (as he has), though I have kept hundreds so, but noticed it first when catching snakes in the New Forest. After much struggling and the usual offensive methods of defence had proved vain, one has, in several instances, suddenly hung limp and apparently lifeless on my hand. It could hardly be a faint or anything but death-feigning, for as soon as I put it on the ground, or allowed it no longer to feel my hand, it recovered at once, and was off like a shot. I took particular pains to test this, as I was much surprised at the circumstance, which I did not remember having seen mentioned in any book. In all cases it was a *desperate resort*, the ejection of food and the effusion of smell having preceded. W. KENNEDY.

**"Finger-Print" Method.**

IN my letter on the subject (NATURE, December 27, 1894, p. 199), I have introduced my assertion of the old Japanese usage of the "thumb-stamps" on legal papers, with a qualifying clause—"although at present I have no record to refer to." Continuing in my search, I have come across a passage which gives confirmation to the statement. It is in the *Fisoku Gwahin*, No. 50, p. 6, Tokyo, February 10, 1893, where the details of the bastinado inflicted on criminals during the *ancien régime* are given, and reads as follows:—"When the criminals' guilt was ascertained, and they signed with 'thumb-stamps' on papers in the Court, they were sent to prison with the magistrate's words, 'Sentence shall follow,' which they used to understand as the signal of the approach of the day of punishment." December 31, 1894. KUMAGUSU MINAKATA.

**A White Rainbow.**

THE white rainbow is so rare as to deserve noting. One was visible at Westnewton, Aspatia, for more than half an hour on Saturday, January 5. The band was much broader than in the ordinary bow, and the arc was formed in the upper intermediate cloud drift. This drift consisted of a light pallium of irregular cirro cumulus. It is important to observe that cumulus was forming, from above, at the time; i.e. the cirro cumulus was melting and descending into ordinary cumulus. A patch of this cumulus formed (under observation) and crossed beneath the bow. It then became coterminous with the western section of the arc, which blended with the cloud, and was of similar tint. Hard, dry frost continued and lasted till January 13. Barometer steady at time.

SAMUEL BARBER.

Westnewton, Aspatia, January 9.

P.S.—Connote with the above the condition of the weather on the Continent; also violent thunderstorms on following day in Cornwall; also snowstorms in Cumberland and Scotland within few days.—S. B.

**AMERICAN TOPOGRAPHY.**

WE have it on the authority of Prof. Gannett that, at the present rate of progress, the series of topographical maps of the United States, which was commenced in 1882, will require no less than fifty years for completion, and that the cost of this great undertaking will not fall far short of twenty million dollars. The map is primarily intended to meet the needs of the geologists of the Survey; but it has been thought economical to make such arrangements that the resulting map may be adequate to serve all purposes for which general topographic maps are used. Its scope is limited to the representation of the larger natural features, and the artificial features which are of general or public interest, to the exclusion of those which are purely of a private character, and therefore liable to rapid changes.

In the vast area covered by the United States, there is a great diversity both of natural and cultural features, and the extent of the survey and the scales of the maps

United States Geological Survey. A Manual of Topographic Methods. By Henry Gannett, Chief Topographer. (Washington: Government Printing Office, 1895.)



are varied accordingly. The scales adopted at the commencement of the work were 1:62,500, 1:125,000, and 1:250,000; or very nearly 1, 2, and 4 miles to the inch respectively. With the progress of industrial development, the maps came to be in great demand in connection with all sorts of enterprises in which the nature of the ground required consideration, as in the projection of railways, water-works, drainages, and the like. Maps on a larger scale, and showing more detail, have in many instances become necessary, so that it has been determined to altogether discontinue the four miles to the inch map, but only to make new maps of the areas already represented on this scale in cases where they are specially required. It is believed that on the scales of one and two miles to the inch, it is possible to represent with faithfulness all necessary details.

The relief of the maps is represented by contours, or lines of equal elevation; in the larger scale maps the intervals range from 5 to 50 feet, and in the smaller ones from 10 to 100 feet, according to the nature of the area mapped. For the now discarded scale the intervals are from 200 to 250 feet.

The methods adopted in the preparation of these maps form the subject of the twenty-second monograph of the United States Geological Survey, which constitutes an excellent manual of topography. It is not intended as an elementary treatise on surveying, nor as a general treatise on topographic work, "although it may, to a certain extent, supply the existing need of such a work." It is primarily intended for the information of the men actually engaged upon the survey; but we believe that it will have a much larger field of usefulness.

We may look upon this manual as consisting of two essential parts: first, that dealing with the methods employed in the surveys; second, that giving a brief account of the origin of the various topographical features. The latter part we hope to refer to on another occasion, and for the present it is sufficient to say that its object is to act as a guide to correct delineation in filling in the details of the sketching.

A map, whatever its character, is defined as a sketch, corrected by locations. "The work of making locations is geometric, while that of sketching is artistic, and however numerous the locations may be, they form no part of the map itself, but serve only to correct the sketch, while the sketch supplies all the material for the map." Hence, the education of the topographer, as Prof. Gannett tells us, should consist of two parts, the mathematical and the artistic. "The first may be acquired from books, and this book knowledge must be supplemented by practice in the field. The second, if not inherited, can be acquired only by long experience in the field, and by many can be acquired only imperfectly. In fact, the sketching makes the map, and therefore, the sketching upon the Geological Survey is executed by the best topographer in the party, usually its chief, whenever practicable to do so.

In making a map, four principal operations are involved. (1) Astronomical observations for locating the map upon the earth's surface; (2) the horizontal location of points; (3) the measurement of heights; 4) the sketching of the map.

With regard to the methods now employed, "it is to be understood that they are not fixed, but are subject to change and development, and that this manual describes the stage of development reached at present." Five principal instruments have been employed in the Survey: theodolites of a powerful and compact form, for use in the primary triangulation; plane tables of the best type with telescopic alidades, for secondary triangulation and height measurements; plane tables of simple form with sighted alidades, used for traversing and minor triangulations; "odometers," for measuring distances; aneroids, for the measurement of details of heights.

All these instruments are described with sufficient fulness, while other instruments, such as transits, chains, tapes, and telemeters, which are commonly figured and described in all works on surveying, receive no special attention.

A single instrument of a very convenient form suffices for the astronomical determinations of position. This is a combined transit and zenith telescope, and consists of an ordinary transit instrument provided with a zenith micrometer eye-piece, and resting on a graduated circular base in such a way that the whole instrument can be made to revolve when using it as a zenith telescope. The telescope has an aperture of two and a half inches, and a focal length of twenty-seven inches. We are not acquainted with any other instrument so convenient for the double purpose of finding latitudes and longitudes with accuracy. Examples of the observations made with the instrument are given, and these, with the various steps in the reductions, form an admirable guide to the astronomical work.

Triangulation is employed in preference to primary traversing wherever the country presents sufficient relief for the purpose, as it is more accurate and cheaper. The initial step in this process is, of course, the measurement of a base line, and in our British survey this was accomplished by Colby's compensation bars. This method of measurement was also employed in the United States up to 1887, when it was decided to adopt a system of measurement by steel tapes. The tape in use has a length of 300 feet, and it is claimed that it is easy to obtain the required degree of accuracy in a far shorter time and at much less expense. A special apparatus for using this tape has been devised, and full instructions for its use and reduction to standard are given.

The description of the base-line measurement is naturally followed by hints as to the selection of stations and the erection of signals for triangulation. A very convenient form of observing tower, or combined instrument support and signal, for use when surrounding objects have to be overlooked, is figured and described. We learn that vernier theodolites have now been discarded in favour of others in which the circles are read by micrometer microscopes, although the circles are only 8 inches in diameter. An excellent and concise account is given of the various errors to which angular measurements are liable, and of the methods of eliminating them from the final results. Some of these errors are instrumental, others personal; and in this connection, Prof. Gannett remarks that, "after learning how to make good observations, the observer should place the utmost confidence in them, and never yield to the temptation of changing them because they disagree with some preceding observations. Such discrepancies are in general an indication of good, rather than poor, work."

In some districts it is almost impossible to carry on a triangulation, and in such cases primary traverse lines are resorted to, these simply differing from ordinary traverse lines in being more elaborately and carefully executed. These traverse lines, it may be said, consist of a series of measurements of distance and directions, and when they are intended to replace the triangulation, they are made with the steel tape, to which reference has already been made, and theodolites.

The account of the secondary triangulation is remarkable chiefly for the great prominence given to the plane table. Speaking of this, Prof. Gannett says that "much misapprehension exists, especially in this country [the United States], regarding the character and application of this instrument. This arises, apparently, from the fact that it is little known. For making a map the plane table is a universal instrument. It is applicable to all kinds of country, to all methods of work, and to all scales. For making a map it is the most simple, direct, and economic instrument; its use renders possible the making of the

map directly from the country as copy, and renders unnecessary the making of elaborate notes, sketches, photographs, &c., which is not only more expensive, but produces inferior results." As the instrument is perhaps not widely known in our own country, we may say that it consists of a drawing-board mounted on a tripod in such a way that it can be levelled, turned in azimuth, and clamped in any position. At the centre of the board is pivoted the alidade, consisting of a ruler with a graduated bevelled edge, to which is attached a pair of sights for rough work, or a telescope for work of a higher class. A small graduated arc is provided in the better-class instrument for the measurement of vertical angles, but the horizontal directions are plotted directly, by means of the alidade, on a sheet of paper stretched on the board. The edge of the board is set in the same direction when the instrument is in use at different points in the area being mapped, and horizontal locations are thus readily determined by intersections.

#### LIFE AT THE ZOO.

A SIGN of the increasing interest shown by the outside world in all questions concerning life, and more especially animal life, is evidenced by the far greater number of books published every year on popular natural history.

The past year witnessed the commencement of several large works, such as the "Royal Natural History," edited by Mr. Lydekker; the republication of "Jardine's Naturalists' Library," edited by Dr. R. B. Sharpe; and the "Cambridge Natural History," of which, so far, only one volume has appeared. Besides these there have been issued a number of smaller works not extending over so wide a ground.

The present volume consists of a number of short articles on various natural history topics more or less directly connected with the Zoological Society's Gardens, illustrated with reproductions of some of Gambier Bolton's successful photographs of the animals found there. A

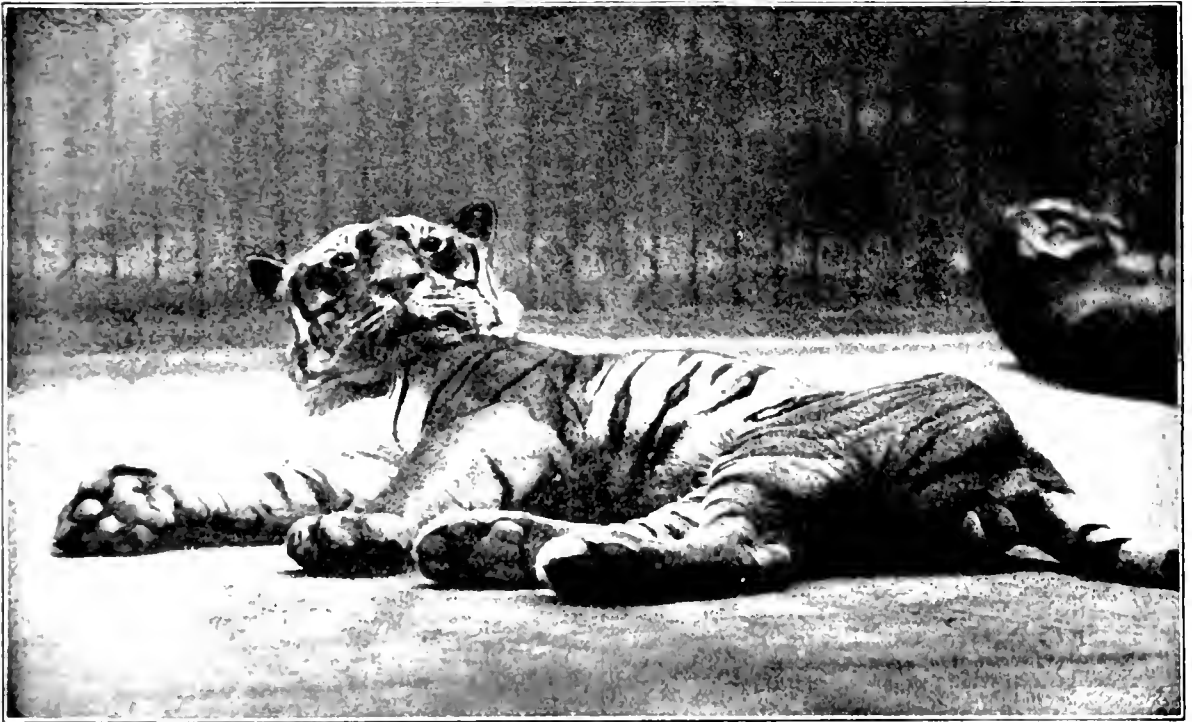

FIG. 1. Tiger lying down.

The simple form of plane table is now exclusively used by the surveyor in the ordinary traverse work. Distance measurements in this class of work are made in the usual way by counting the revolutions of a wheel, an "odometer" being used for this purpose.

The manual abounds in practical hints on the various points connected with surveying, and concludes with a brief account of the office work which is so important a supplement to work in the field.

The numerous appendices consist of tables to be used in the various computations, and are complete enough to include even a table of logarithms.

It is not too much to say that Prof. Gannett has produced a manual which will be of interest to many not actually engaged in surveying, while at the same time it forms a very valuable supplement to the ordinary works on the subject.

A. FOWLER.

considerable number of these sketches have already appeared before in the pages of the *Spectator*, but many chapters have been added, and the whole forms a very agreeable *repertoire* of gossip, with, in some cases, pretensions to higher things in the shape of accounts of experiments on the aesthetics of the animal world.

One of the most interesting of the articles directly connected with the Zoo is that on "Elephant Life in England." The number of elephants now in Europe, chiefly in circuses and menageries, is considerable. Mr. Cornish gives it at about 120, of which England possesses about thirty-four. With some half-dozen exceptions, all these elephants belong to the Indian species, and are mostly imported from Burma, where they are bred in a half wild state. The African elephant, according to our

Life at the Zoo. Notes and Traditions of the Regent's Park Gardens. By C. Cornish, Esq. (London: Seeley and Co., 1895.)

author, does not appear to possess quite so even a temper or so docile a nature as the Indian species, but still, judging from what has been done with them in our Zoological Gardens, there seems to be no reason why they should not be caught and tamed exactly in the same manner as their Indian relatives. Indeed, a few years ago an officer, in the service of the German colony of East Africa, made a special tour in India for the purpose of investigating whether it would be possible to introduce the *keddah* system into East Africa. Whether this enterprise has ever come to anything, does not appear to have transpired. It is also known that the subject occupied the attention of General Gordon shortly before his death.

In an article on the Wild Cats of the Zoo, Mr. Cornish discusses the origin of our domestic tabby. Besides the European Wild Cat (*Felis catus*), which now appears to be increasing slightly in numbers in Scotland, owing, doubtless, to the increased reservation of so much of the area of that country for deer-forests, he suggests the Chaus Cat of India and Northern Africa as a possible ancestor of our domestic form. There are, however, two other species, which both seem in many respects to have greater claims. One of these is the Cat of North Africa (*Felis caffra* or *maniculata*), a species held in veneration by the ancient Egyptians, large quantities of the mummified remains of which have been imported to this country for manure. An argument in support of the opinion that this is the true ancestor of the domestic cat, is the fact that the sole of the hind-foot of this species, like that of most varieties of domestic cats, is black, and not spotted, as in the European Wild Cat (*Felis catus*).

Another possible candidate for the ancestry of the domestic cat is the Waved Cat (*Felis tigrinata*); this cat has been obtained in various parts of India, but is never very common. It resembles very closely the Indian domestic breed. It is, however, more than probable that whatever the origin of the domestic cat may have been, it has interbred with the wild cats of the various countries to which it has been conveyed by man. This has certainly been the case in India, where hybrids between the native domestic cats and both the Jungle Cat (*Felis chaus*) and the Leopard Cat (*Felis bengalensis*) are fairly well known.

A plea for the repeal of the absurd and oppressive Act of Parliament that prohibits the use of dogs for draught purposes, forms another short essay. This Act was based entirely on the *a priori* and ridiculous argument that dogs "were not created" for such a purpose. Mr. Cornish shows that on the Continent, where dogs are freely used in this way, no ill effects ensue to them, and that their employment is an enormous boon to the poorer classes, who are unable to afford horses.

Several chapters of this work are devoted to the inhabitants of the Reptile House at the Zoo, and among them is specially mentioned the Heloderm, the only known poisonous lizard in existence. A recent memoir by Dr. Shufeldt (*P.Z.S.* 1890, p. 148) has supplied a good

deal of information respecting the anatomy of this lizard. The large poison glands are shown to lie on either side of the lower jaw, their ducts opening into the floor of the mouth, whence it is surmised that the poisonous secretion finds its way along the grooved teeth of the mandible to the inflicted wound. It is a curious fact that although some of the teeth of the upper jaw of this Lizard are also grooved, no trace of any poison gland has been found here. An interesting account of the effects of the bite of the Heloderm on the human subject has been already recorded in our pages (*NATURE*, vol. xxvii. p. 154), and

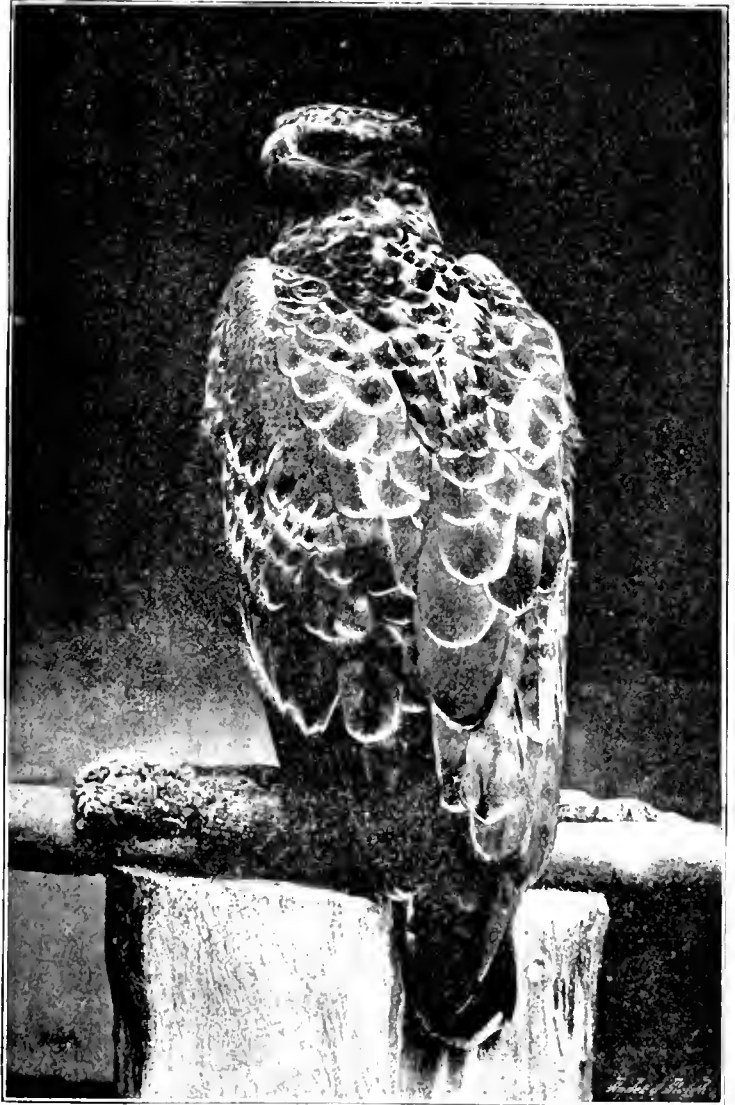

FIG. 2. - The Martial Hawk Eagle.

it has been shown that its effects on man, though painful at the time, are not of a serious nature.

One of the very few statements in this work with which we are unable to agree, is to be found in the account of the diving birds at the Zoo. With regard to the Penguin, Mr. Cornish says: "It cannot fly in the air; it cannot walk, but hops as if its feet were tied together; it cannot even swim." If Mr. Cornish will turn to the account of the expedition of the Dundee whalers to the Antarctic Seas, given in the *Scottish*

*Geographical Magazine* for February 1894, he will find the following passage: "On one occasion, in the north of the Erebus-and-Terror Gulf, we saw large schools, numbering 300 to 500, of the common black-throated Penguin, swimming together; the movements of each school being controlled by a single individual of larger size, which followed in the rear." It is quite possible that this error may have arisen through the fact that, as a rule, the Penguins, when allowed, in the Zoological Gardens, to enter their tank, dive straight off the board leading into the water, and remain under water until all the fishes in the tank are caught and devoured. After that they usually betake themselves straight back to the board. But that they can swim duck fashion, when they wish to do so, admits of no doubt whatever.

The volume is illustrated by a series of Gambier Bolton's photographs, which are certainly the best ever taken of "Life at the Zoo." Of these we are kindly permitted to reproduce two. One of them represents the Tiger "listening to soft music," and forms part of a series made to illustrate "Aesthetics at the Zoo." The other shows the Martial Hawk Eagle, a rather rare bird from South Africa. On the whole, we can cordially recommend this volume for readers of the lighter literature of Natural History, and even as containing a certain amount of novel information on "Life at the Zoo."

#### INTERCOLONIAL ASTRONOMY AND METEOROLOGY.

WE learn from Mr. K. L. J. Ellery, F.R.S., that a conference representing the three colonies of New South Wales, South Australia, and Victoria, met at the Observatory, Melbourne, on October 20. Mr. H. C. Russell, F.R.S., from Sydney, and Sir Charles Todd, F.R.S., from Adelaide, were present.

1. As regards Australian standard time, it was resolved to advise the respective Governments to adopt for that purpose the time of the meridian of 150° E.

It was also agreed to advise that the changes from one hour zone to another shall take place at the eastern and western boundaries of the several colonies.

(2) A proposal, by Sir C. Todd, was adopted to the effect that the three observatories should co-operate in a special series of observations for determination of colatitude, and for testing the applicability of the present refraction table to astronomical work at the various observatories.

3. It was resolved, at Mr. Russell's suggestion, to carry out systematic cloud photography at each observatory, as an aid to weather forecasting.

4. As to agricultural forecasts, it was agreed to: "That in each of the colonies represented a forecast of the weather shall be sent to all the principal telegraph stations each day, except Sunday; Saturday's forecast being for 24 hours, and that forms to contain a week's forecasts be used, which it is proposed shall be posted on a special board at the station receiving forecasts."

5. It was resolved that the storm signals to be used be the same as used in England.

6. On the suggestion of Mr. Russell, it was agreed that further determination of the differences of longitude of Adelaide, Melbourne, and Sydney, should be carried out, and that periods when there was high atmospheric pressure at one place, and low at another, be selected for the operations, with the view of ascertaining if large differences of atmospheric pressure between the eastern and western stations had any influence on the longitude results. Mr. Russell undertook to draw up a programme for this undertaking.

#### NOTES.

ENGLISH geologists will be gratified to learn that the veteran Prof. Prestwich has been elected a Vice-President of the Geological Society of France. It is, we believe, the second time only that this honour has been conferred on one who was not a French subject. The Council of the Geological Society of London has formally offered to Prof. Prestwich its congratulations on the distinction thus received.

M. MASCART has succeeded M. Tisserand as President of the Paris Société d'Encouragement.

THE death is announced of Prof. Karl v. Haushofer, Director of the Technische Hochschule at Munich, and Professor of Mineralogy in the University of that city.

DR. G. M. DAWSON, C.M.G., F.R.S., has been appointed Director of the Geographical Survey of Canada, in succession to Dr. A. R. C. Selwyn, who has been superannuated.

WE regret to note that the Duke of Argyll was attacked by sudden indisposition while addressing a meeting at Glasgow on Tuesday evening. His condition at first gave rise to serious concern, and it was not till a late hour that he recovered sufficiently to be conveyed to the residence of Lord Kelvin, where he is staying.

AT Fishmongers' Hall, this evening, the Marquis of Lorne will present the prizes and certificates obtained by students in connection with the City and Guilds of London Institute.

THE twenty-second annual dinner of the old students of the Royal School of Mines will be held on Friday, January 25, at the Criterion Restaurant. A number of distinguished visitors are expected to be present, and arrangements have been made for a large gathering of associates and old students.

THE annual meeting of the People's Palace Chemical Society will be held on Thursday, January 24, when Dr. T. E. Thorpe, F.R.S., will give an address on "Some causes and conditions of chemical change." The chair will be taken by Prof. Tilden at 8 p.m. Tickets may be obtained by application to the hon. sec., Mr. Thomas Yetton.

THE Association for the Improvement of Geometrical Teaching will hold a general meeting at University College, Gower Street, next Saturday. In the morning, the report of the council will be read, and the new officers will be proposed for election. During the day, papers will be read on "Algebra in Schools," "The Association's Syllabus of Geometrical Conics," "The Conics of Apollonius," and "Notes on Mensuration."

THE forty-eighth annual general meeting of the Institution of Mechanical Engineers will be held on Thursday evening, January 31, and Friday evening, February 1. The annual report of the Council will then be presented, and the election of the President, Vice-Presidents, and Members of Council will take place. The following papers will also be read and discussed, as far as time permits:—"The Determination of the Dryness of Steam," by Prof. W. Cawthorne Unwin, F.R.S.; "Comparison between Governing by Throttling and by Variable Expansion," by Captain H. Kiall Sankey.

THE freshwater biological station, which was established at Flein three years ago through the efforts of Dr. Otto Zacharias, seems to be assuming quite an international character. From a recent report of the director, we learn that nine investigators worked at the station during the summer semester of last year, and of these four were German, two English, two French, and one Russian. Much interesting work seems to have been

accomplished, the results of which have been partially published in the *Forschungsberichte* of the station, while others are already in the press.

THE death of Mr. Thomas Andrews at Guildford (says the *Times*) removes one of the best-known and most successful pisciculturists of the day. His breeding ponds at Haslemere, on the borders of Surrey and Hants, are perhaps, next to Sir James Maitland's famous establishment at Howietown, near Stirling, the most important trout-rearing fishery in the kingdom. The series of ponds are picturesquely situated on the side of a hill, and were all planned under the immediate direction of the late owner, who was a keen observer and an enthusiastic naturalist. They afforded every facility for studying the various points in connection with the artificial cultivation of trout. Mr. Andrews had brought this particular branch of pisciculture (to which he had devoted many years of his life) to a very high state of perfection. The distribution of ova and fish from the Surrey ponds was not merely confined to our home waters. At various times consignments were despatched to foreign countries, Ceylon, Buenos Ayres, Mauritius, and elsewhere. Mr. Andrews contributed many important papers on fishery matters to various periodicals.

THE St. Petersburg Academy of Sciences has recently made some changes in the system of publishing papers communicated to it. In September 1894, it commenced the publication of a monthly number, under the title *Bulletin de l'Académie Impériale des Sciences*, which serves as the organ of the three classes of the Academy. This *Bulletin* is intended to include the *procès-verbaux* of the meetings, annual reports on scientific researches, reports on prizes conferred by the Academy, notes on the work of the museums, &c. In addition to notices of this kind, the *Bulletin* will contain short scientific papers. The *Mémoires de l'Académie Impériale des Sciences* will form in future the second means of publication. It will be divided into two independent series, dealing respectively with the physico-mathematical section of the Academy's papers, and the historical and philological section. The publication of the *Mélanges, tirés du Bulletin*, has been discontinued.

SOME very low temperatures were reported to the Meteorological Office during the recent frost. At Braemar, in the east of Scotland, the sheltered thermometer fell below zero on four consecutive days, the lowest value being  $-5^{\circ}$  on the 9th instant. At Hillington, in the east of England, the lowest reading was  $2^{\circ}$  on the 12th instant; in other districts the minima varied considerably, being  $8^{\circ}$  or  $9^{\circ}$  in the north of Scotland and the north-east and midland parts of England. This severe weather came to a sudden termination on the night of the 12th-13th instant, owing to the approach of a serious disturbance from the Atlantic, which arrived off the Irish coast on Saturday, and remained comparatively stationary during Sunday and Monday. Strong easterly gales were experienced on the Scotch coasts, and very strong winds in other places. The gale was accompanied by a very high sea on our north and east coasts, and, as usual with easterly gales, many shipping casualties occurred.

WE learn from an article in *Das Wetter*, that a permanent meteorological station has been established by the Danish authorities at Angmagssalik, on the east coast of Greenland (Lat.  $65^{\circ} 37' N.$ , Long.  $37^{\circ} 16' W.$ ), and has been provided with self-recording instruments, in addition to the usual ones. This station will be of much importance, as it forms a link between those on the west coast of Greenland and the stations in Iceland, and as it is between Iceland and Greenland that the centre of the Icelandic barometric low-pressure lies, the varying position of which exercises a great influence on the weather

conditions of Europe. It is known, from a year's observations made there by Holm ten years ago, that the climate is very rough and stormy; during the year in question the mean temperature was  $5^{\circ}$  below the freezing point, while the minimum reached  $-13^{\circ}$  of Fahrenheit's scale. Meteorologists may well be grateful to men who have undertaken to make observations in a place where, in all probability, they will be cut off from all other human intercourse for some years. Dr. Naasen only succeeded, after considerable difficulty, in reaching Lat.  $63^{\circ} 1'$  along this coast in the year 1888.

IT will be news to most people that dealers in drugs, both wholesale and retail, cannot legally use kilogramme weights, or any of the metric system of weights and measures, for the export trade, though orders received from continental countries are given in that system. A short draft Bill has been prepared to amend the law, and will be presented to Parliament in the coming session. The chief clause reads as follows:—"That, on and after the passing of this Act, wherever the world trade occurs in the Weights and Measures Acts of 1878 and 1889, it shall be so construed as not to prohibit or penalise the use of metric weights and measures, verified by the Board of Trade or local authorities, by export traders." The Acts of 1876 and 1889 have been disregarded by many traders, but the London County Council having recently intimated that they must enforce the law, the passing of an amendment such as that proposed has become necessary.

ON Tuesday, January 8, a paper was read before the Anthropological Institute, on the Samoyad race, by Mr. Arthur Montefiore. After dealing in some detail with the geographical distribution of the various branches of the Samoyads, Mr. Montefiore proceeded to give evidence of their affinity with the Finns, and, following Castelnau, placed them in the group which that authority called Ural-Altaic. The evidence consisted partly of physical measurements and characteristics, partly of similarity in ideas, habits and customs, and partly of identity in language. It was shown in the course of the paper that the language of the Samoyads is highly agglutinative and so inflectional as to form a link, as it were, between the Mongol and Indo-Germanic groups. After dealing with the myths and conceptions of deity held by this curious race, Mr. Montefiore read a number of notes made by Mr. Frederick G. Jackson (the leader of the Jackson-Harmsworth Polar expedition) during his sojourn among the Samoyads in the autumn and winter of 1893-94, and his subsequent journey across the Great Tundra between the Kara Sea and the Pechora River. Mr. Jackson's notes were very full, and contained some remarkable evidence of the completeness with which the Samoyad has adapted himself to the rigorous requirements of his environment. A number of Samoyad implements and other articles (including a highly curious Samoyad doll and some calculating sticks) were exhibited, together with a series of lantern slides from photographs, which are necessarily new to English students of anthropology.

DOES atmospheric dust exercise any perceptible influence on the intensity of the sun's rays transmitted through it? is the question which Prof. A. Bartoli answers in the *Nuovo Cimento*. He studied the effect of different thicknesses of air upon the sun's heat by measuring the heating power of the sun at various altitudes with the pyrheliometer, after the great eruption of Etna in July 1892. On July 25, the air was filled with an impalpable dust, which fell very gently, and gave to the sun a slight reddish tinge. There were no clouds, and there was a dead calm. By comparing the absorptive influence of the air under these conditions with that in a clear atmosphere, Prof. Bartoli found that 28 per cent. of the heat transmitted by the pure air was intercepted by the volcanic dust.

A FURTHER statement of M. Raoul Pictet's fascinating experiments at very low temperatures is published in the *Comptes rendus*. The object of the experiments was to test the power of cotton-wool and other bad conductors to prevent the passage of heat by thermal radiation. Copper cylinders were cooled down to  $-172^{\circ}\text{C}$ . and packed in layers of cotton-wool of various thicknesses. It was found that the cylinders rose to about  $-80^{\circ}\text{C}$ . very rapidly, and that the rate of warming was the same whether the cylinders were naked or packed in cotton-wool of 20 inches thick. The "bad conductor" behaved, in fact, like a perfect conductor transparent to heat radiation. Above  $-80^{\circ}\text{C}$ . the influence of the packing began to make itself felt, the rate of warming varying with the thickness of the layer.

IN the current number of *Nature* (8,000), Captain Marshall-Hall urges the importance of a fuller study of existing glaciers, as the necessary basis for any attempt at setting in order the chaos of opinion on the nature and causes of the Glacial period. He gives an account of the steps recently taken by the Alpine Club and the Glacier Committee of the International Geological Congress towards drawing up a systematic statement of the methods of observation, for the use of those who can visit and examine modern glaciers in any part of the world. For fuller details, readers are referred to papers in the *Alpine Journal* of February 1894, and November 1894; but a number of subjects for careful observation are suggested, and some necessary precautions mentioned. It is very satisfactory to see that the members of the Alpine Club, if primarily climbers, are able incidentally to do useful service to Geology.

IN the last number of the *Record* of the Geological Survey of India, Dr. Noetting announces an interesting discovery from Baluchistan. Certain beds which Mr. Oldham had recently described as intermediate between Cretaceous and Tertiary he finds really belong to the *Danian*—a stage to which the English chalk nowhere reaches (except perhaps in Norfolk), but which forms the summit of the Cretaceous in various parts of Europe. In examining the Echinoids from the Baluchistan beds, Dr. Noetting found a striking resemblance to those from the Danian beds in the Pyrenees. That the Pyrenean fauna should resemble that of such a distant region more than the nearer ones of Northern Europe, is another of the many pieces of evidence of ancient life provinces—not improbably climatic in this case—but a climatic as geological research is extended into distant parts of the world. It must be coupled with the further fact that the Baluchistan Echinoids have little in common with those of the same age in Southern India.

THE last number of the *Comptes rendus* contains a paper by E. Colson, on the conditions which have to be fulfilled in order to obtain correct results when measuring liquid resistances with alternating currents in a telephone. The author, while working on the propagation of electrical waves of slow period, obtained results which have an important bearing on the above method of measuring liquid resistances. The results obtained depend on the supposition that, even in the case of alternating currents in liquid resistance, Ohm's law holds. However, this law does not hold good in the case of the propagation of waves of high potential, such as are furnished by the secondary of an induction coil in high resistances, such as threads saturated with a solution of calcium chloride, or capillary tubes filled with water. The author gives a series of tests which, when applied to any given arrangement of conductors, will show whether the above effect will have any influence on the result.

M. B. D. PEPPER has contributed a paper to the *American Journal of Science*, vol. xlvii, p. 312, on the thermo-electric properties of platinum and manganin. Since platinum and

manganin wires are often used in potentiometers and slide wire Wheatstone's Bridges, the thermo-electric properties of these metals are of considerable interest. The author has primarily determined the electromotive force of the above metals and copper, since this is the most interesting case from a practical point of view. He finds that after the manganin wire has been well annealed, the thermo-electric phenomena are quite regular. While the mean electromotive force for a difference of  $10^{\circ}\text{C}$ . between the hot and cold junctions of a copper manganin couple is about 5.5 microvolts, in the case of a platinum-copper couple the mean electromotive force for the same difference of temperature is about 170 microvolts. Incidentally the author has examined the thermo-electromotive force of couples consisting of different samples of commercial copper, and he finds that two specimens of annealed copper wire bought from different makers hardly ever yielded more than one or two C.G.S. units of E.M.F. per degree Centigrade.

A FEW particulars concerning the earthquake felt in Nicaragua and Honduras in November 1894, have been sent to us from Managua, by Mr. J. Crawford. Shocks were felt for twenty seconds at Managua, about 9h. 36m., and another series, lasting about thirty seconds, at eleven in the evening of November 19. Mr. Crawford has been able to trace the course of the waves for about 120 miles to the north-west and south-east of the city. At Managua, the undulations were short and rapid; they were stronger at the city of Masaya—twelve miles to the eastward, and still stronger at Granada—about twenty-four miles eastward. In the latter place, houses were thrown down by the vibrations, and also at Chinandega—seventy miles west of Managua, though at Managua itself the shocks were not of sufficient severity to fracture any of the walls of the houses, or displace any of the tiles on the roofs. It is remarkable that the earthquakes were most violent both east and west of the city.

MR. J. C. SHENSTONE has taken a census of remarkable oak trees in Essex, and he gives, in the *Essex Naturalist*, descriptions and illustrations of noteworthy specimens found by him; together with notes on a few oak trees outside the county. The five trees with the largest trunks in Great Britain, stated in "Loulton's Arboreum," are: Cowthorpe Oak, Yorkshire, 78 feet; Merton Oak, Norfolk, 63 feet; Hempstead Oak, Essex, 53 feet; Grimstone Oak, Surrey, 48 feet; Salsey Oak, Northampton, 46 feet. Among trees having the widest stretch of boughs, are the Worksop Oak, 180 feet; and the Oakley Oak, 110 feet. All these trees are not, however, standing at the present time. The Hempstead Oak fell about twenty-five years ago, and a mutilated and decayed trunk is all that remains of this forest giant. A fine tree, thirty-one feet in circumference, exists in the park at Dunbury Palace. The inside of the bole was completely burnt out more than sixty years ago, but the tree has continued to grow, and will probably yet survive many years. Several of the trees mentioned are said to be from five hundred to a thousand years old, but there is not sufficient evidence to decide the point at all accurately.

BRITISH ornithologists have long been aware that the increase and extension of range of the starling presents some interesting and phenomenal facts. They will therefore follow with interest a paper on the increase and distribution of the bird in Scotland, contributed by Mr. J. A. Harvie-Brown to the *Annals of Scottish Natural History* for January. By looking up old records dating back to the end of last century, and by collecting information through a special circular, it has been possible to give a consecutive statement of the steps of advance. The account, and the map accompanying it, show that, as regards Scotland, the starling is almost omnipresent. The statistics

indicate "that two great centres of habitation have influenced the dispersal of the species: an earlier one in the Shetlands, Orkney, and the Outer Hebrides, and north coasts and north-east of Caithness, from north-east towards south-west; and a later one, entering Scotland in the south and passing north through the south and central districts of Scotland. Moray appears to have drawn its supplies from the northward, in comparatively recent years; but the districts to the south of the Grampians mostly, if not entirely, from the southwards. . . . It might not, perhaps, be too rash to predict that the day may yet arrive when the starling having increased still more prodigiously, and every crevice and cranny having become populated by these cosmopolites, a great struggle for existence even amongst themselves may become necessary to preserve the balance of nature. Before this can take place, however, the probability exists that some other weaker species may have to go to the wall. Indeed, there are already indications of such a fact in at least one instance and locality—by sheer force of numbers."

In the eighth annual report of the Liverpool Marine Biology Committee, edited by Prof. Herdman, there is an interesting account of the work carried on during the past year at the biological station at Port Erin. A number of important additions to the fauna already known in that neighbourhood are recorded, including *Dicoryne conferta*, *Crista ramosa*, *Amphicolon fritillaria*, and some forms of Copepoda new to science, *Pseudocyclops stephoides* and several species of the genus *Ectinosoma*. Many observations have been made on the submarine deposits of the Irish Sea, and a preliminary general account is given in the report. The bottom, down to the depth of 10 fathoms, is chiefly covered with sand; at a greater depth, between 10 and 20 fathoms, there is a large admixture of mud; from 20 to 50 fathoms the bottom deposits are greatly varied, and here the richest fauna occurs; below 50 fathoms is found a bluish-grey tenacious mud, with a peculiar and characteristic fauna. Prof. Herdman very justly points out the importance of a thorough investigation of the submarine deposits round our coast; he regards the nature of these deposits as probably the most important of the various factors that determine the distribution of animals over the sea-bottom within one zoological area. "In practically the same water, identical in temperature, salinity, and transparency, at the same depth, with, so far as one can see, all the other surrounding conditions the same, the fauna varies from place to place with changes in the bottom—mud, sand, nullipores, and shell-beds, all have their characteristic assemblages of animals." The concluding part of the report contains a short account of a plan for the distribution of drift-bottles in order to obtain information with regard to the currents in the Irish Sea which affect small floating bodies; this experiment is based upon the plan employed by Prince Monaco in the Atlantic a few years ago. The observations made on the course of the drift-bottles up to the present have already been described in our columns by Prof. Herdman (NATURE, December 13, 1894, p. 151).

WITH the January *Journal* of the Chemical Society, we have received a supplementary number, containing title-pages, contents, and indexes of volumes lxxv. and lxxvi. (parts i. and ii.) of the *Journal*.

THE resolutions accepted by the International Congress of Hygiene and Demography, held at Budapest in September last, have just been published in the form of a pamphlet. They are printed in four languages—Hungarian, French, German, and English.

THE first part of a new catalogue of entomological works offered for sale, has been issued by R. Friedländer and Son,

Berlin. The list, which is No. 416 of the "Bücher-Verzeichnis," published by Friedländer, is devoted to fossil insects, Coleoptera, and miscellaneous works on entomology.

WE regret to announce that, owing to the death of Father Denza, the publication of the *Bollettino Mensuale*, issued by the Moncalieri Observatory for the last fourteen years, is to be discontinued, and that the Italian Meteorological Society is to be dissolved. We hope that some other pioneer of Italian meteorology will take up the good work left by Father Denza.

THE publication of "The Cambridge Natural History" will shortly be commenced by Messrs. Macmillan and Co. The first volume to appear will contain "Molluscs," by the Rev. A. H. Cooke; "Brachiopods (Recent)," by Mr. A. E. Shipley; and "Brachiopods (Fossil)," by Mr. F. R. C. Reed. This will be followed, in the course of a few months, by two other volumes in the same series, on "Insects," by Dr. David Sharp, F.R.S. The whole series, which will include ten volumes, fully illustrated, is intended, in the first instance, for those who have not had any special scientific training; but an attempt will be made to combine popular treatment and popular language with the most modern results of scientific research.

REFERRING to the announcement that ten Surinam water-toads had been received at the Zoological Society's Gardens (NATURE, p. 85), Dr. C. Kerbert, the Director of the Koninklijk Zoologisch Genootschap, informs us that a number of these interesting animals were received at Amsterdam in October 1893, and are still living.

THE Royal Horticultural Society has been established for ninety years, and there are at present three thousand Fellows on its roll. It works in various ways "for the improvement of horticulture in all its branches, ornamental as well as useful." The *Journal* of the Society usually contains much valuable information on scientific and practical gardening. In the January issue, there are a number of papers read at a conference on trees, and others read at a conference on British-grown fruit. Perhaps the most important section of the Society is the strong Scientific Committee appointed to examine and report upon instances, submitted by the Fellows, of diseases and injuries of plants, caused by insects or otherwise. The Committee give their advice on all matters connected with the prevention or cure of disease, and are glad to receive specimens of malformation, or other subjects of horticultural or botanical interest.

A DEFINITE and trustworthy answer appears at last to be given to the long-standing question of the closely approximating atomic weights of nickel and cobalt, in a communication from Prof. Winkler to the *Zeitschrift für Anorganische Chemie*. The great difficulty in deciding the actual values of the atomic constants of these interesting metals has been largely owing to the fact that the methods of analysis hitherto adopted have not been free from all source of error. During the last few years, however, very considerable progress has been made in the chemistry of the compounds of nickel and cobalt, and the sources of error are now more correctly appreciated, and consequently more amenable to elimination. It is inconceivable, in the light of the ample verification which the periodic generalisation associated with the names of Newlands and Mendeleeff has received since its inception, by the subsequent accumulation of experimental facts, that the atoms of nickel and cobalt can both be endowed with the same relative weight, as was for so long supposed to be the case. A short time ago, Prof. Winkler carried out a series of analyses of the chlorides, prepared from the electrolytically deposited metals, and obtained the numbers Ni = 58.90 and Co = 59.67. Having, however, still some doubts as to the absolute accuracy of the decimal places, owing to the possibility of a minute source of error in the preparation of pure neutral

chlorides, another series of experiments have been carried out by a method which Prof. Winkler states is in his opinion and there can be none higher as regards work with the two metals in question quite unimpeachable. The older method is based upon the electrolytic determination of the metals were found to lead to an error in the case of cobalt, owing to the fact that a small quantity of the hydrated oxide  $\text{Co}_2\text{O}_3 \cdot 2\text{H}_2\text{O}$  is contained in the deposit upon the platinum electrode, while in the case of nickel no oxidation whatever occurs. This discovery was a consequence upon another, namely, that a solution of iodine in potassium iodide of decinormal strength is capable of instantly dissolving the deposited metal from the platinum terminal without in the slightest attacking the latter, producing a solution of the iodide of the metal. In the case of nickel the platinum is left perfectly clean, while deposited cobalt invariably leaves a stain due to about half per cent. of oxide. The electrolytically-deposited cobalt employed by Prof. Winkler was therefore all reduced in pure hydrogen before use; when subsequently dissolved in the iodine solution, no trace of oxide was ever left. The method of analysis consisted in determining, by titration with pure sodium thiosulphate, the excess of iodine left after solution of the pure metal's to form the iodides. Two complete series of analyses, each consisting of a considerable number of individual determinations, were carried out with an interval of some months, in order to employ metals from totally independent mineral deposits. The results are most concordant, and lead to the following numbers, Ni = 58.72 and Co = 59.37, when Ni = 1 and Co = 129.53. The atomic weight of cobalt must therefore be accepted as at least half a unit higher than that of nickel, a result likewise in accordance with the work of Prof. Winkler published a short time ago.

OUR ASTRONOMICAL COLUMN.

3011. III.—Further particulars of Dr. Balapolyky's spectroscopic study of this variable star (NATURE, November 1, 1894, p. 21) are given in the *Bulletin* of the St. Petersburg Academy of Sciences, November, 1894, and some of his numerical results are slightly changed. He has shown for the first time that orbital movement is as closely associated with this class of the period variable stars as with those of the Algol class, in which the minima are produced by eclipses. Although the spectrum of  $\delta$  Cephei is described as of Vogel's Class II., it is considered that it differs from that of the sun in many respects. One of the lines which are narrow and feeble in the sun being very strong in the star, and vice versa. There does not appear to be any change in the character of the spectrum, either than a variation of intensity, as the light of the star changes.

The displacements of the lines with respect to the comparison spectra of iron and hydrogen indicate that the star has an orbital movement in a period corresponding to that of the light changes, 11.76 days, and that the eccentricity of the orbit is 0.74. The form of the curve of velocities which is given, indicates that the inclination of the orbit must be very nearly directed toward the earth, and the system is approaching the earth with a velocity of about 12 English miles per second. With reference to the centre of movement, the maximum velocities of approach and recession are about 13 English miles per second, the star receding for about a day after minimum, approaching for nearly a day more, and receding until minimum again. Perseus is at the point of the orbit farthest removed from earth at minimum, about a day after minimum.

The apparent semi-diameter is about 81820 English miles, or about the whole diameter of the sun more than twice the sun's diameter. We are not aware that any attempt has been made to determine the parallax of this star, but as it has a very high proper motion, it is possible that it may be relatively near to us.

It is worth noting that the time of total eclipse is a day after the minimum of the light curve, 11.76 days. It seems to be probable that the variation may be due to eclipsing. There is no reason to believe that further work may be done. There is a possibility of error, and that perfection may really coincide

with the minimum. As the light changes appear to be going on continuously throughout the period, it is clear that the eclipsing cannot be of the simple kind with which we are familiar in the case of Algol.

THE VATICAN OBSERVATORY.—A day after the death of Father Denza, we received the fourth volume of the "Pubblicazioni della Specola Vaticana." Every annual report of the work done at the Vatican Observatory is more voluminous than the one preceding it. The volume which came to us last month, and to which Father Denza's death gives a melancholy interest, runs into more than six hundred pages, and is illustrated by forty-two plates. Among these are illustrations of the Dumb-bell nebula in Vulpecula, the Pleiades nebula, the Orion nebula after exposures of thirty minutes and of nine hours, two photographs of the eclipse of April 1893, a photograph of the sun with the big spot of August 1893, together with two enlarged pictures of the spot, and a map showing the direction of motion of the meteors observed on August 10-11 of the same year. Papers on the subjects of the illustrations make up the greater part of the astronomical section of the report. Altogether, ten photographs were taken at Rome during the eclipse of April 1893, and contact observations were also made. The numerous meteor-observations made under Father Denza's direction in Italy, in August and November 1893, are catalogued and commented upon. It is to be hoped that the system of meteor-observation which the late Director instituted will not be allowed to lapse. In celestial photography we note that in addition to the work for the photographic chart and catalogue, 248 photographs were taken of various celestial objects, 150 being photographs of the sun. But the astronomical results by no means represent the total work carried out at the observatory. Meteorology and terrestrial physics come in for a large share of attention. To us it seems that the only thing wanting to make the Vatican Observatory a true astro-physical observatory is a section for spectroscopic investigations.

Many astronomers will be interested to know that a full and appreciative notice of Father Denza's life and work has been written by P. Armani, of the Collegio dei S.S. Biagio e Carlo. Another full notice appeared in *Cosmos* of December 22.

AN INDISPENSABLE ANNUAIRE.—This year is the centenary of the creation of the Bureau des Longitudes, the invaluable *Annuaire* of which has been received for 1895. It is quite unnecessary to remind astronomers of the merits of this veritable *ide ne uni*, for they know its usefulness better perhaps than workers in the other branches of physical science to which it appeals. A few changes have been made since the previous issue. M. Berthelot has completely revised and corrected the tables relating to thermo-chemistry. M. Moureaux has inserted in the tables of the magnetic elements in France, the values determined directly by him in 1894, at nearly six hundred places. Prof. Glasenapp has added five new stars to his table of the elements of the orbits of double stars. The list of comets has been brought up to the end of 1893, and that of minor planets up to November 1894. There are five articles in the volume, the subjects and authors being: Lunar atmospheric waves, by M. Bouquet de la Grye; the Geodetic Congress at Innsbruck, by M. Tisserand; the Observatory on Mont Blanc, by M. Janssen; photographic photometry, by the same author; and a report on the proposition to unify the astronomical and civil days, by M. Poincaré (see the next note).

THE UNIFICATION OF CIVIL AND ASTRONOMICAL DAYS.—It will be remembered that in 1893, the Astronomical and Physical Society of Toronto invited replies from astronomers to the question: "Is it desirable, all interests considered, that on and after the first day of January 1901, the Astronomical Day should everywhere begin at mean midnight?" The result of the voting was noted in NATURE, April 5, 1894, p. 542; and to this may now be added the following resolution adopted by the Bureau des Longitudes upon the question (*Annuaire* for 1895): "The Bureau des Longitudes is favourable, in principle, to the reform proposed by the Canadian Institute to change the time from which to reckon the astronomical day. The Bureau thinks that this reform, as has been observed by the Lords of the Admiralty, will be of little avail unless an understanding is come to between the Governments publishing the principal ephemerides. Finally, considering that the unification will not really be complete until the civil hour is reckoned from 0 to 24 hours, as is the case in Italy, the Bureau is of the opinion that this reform ought to be realised as soon as possible."



## THE FOUNDATIONS OF DYNAMICS.

THIS posthumous volume of Hertz's works, edited by Prof. Lenard, with a preface by von Helmholtz, has a doubly melancholy interest. It is the last work of Hertz upon which he was engaged until a few days before his death, and it contains a preface which is almost the last work of von Helmholtz. The pupil died shortly before his master, and by the departure of such a pupil and of such a master, science, and with science mankind, have lost many prospects of advances in the near future.

In his preface, von Helmholtz pays a touching tribute to the genius of his favourite pupil, from whom he hoped most, and who had drunk most deeply of his master's thoughts. In 1878 their intimacy began. At that time difficulties connected with various electrical theories of action at a distance were occupying his thoughts, and he offered a prize for the best essay on induction in non-inductively wound coils. Weber's theory would have involved an inertia of the electric current distinct from the magnetic inertia. The question is still interesting in connection with discharges between two charged conductors, one of which completely surrounds the other when a dielectric between them is suddenly made conductive. There is then no magnetic force. Is there *no* inertia? Can a medium become *suddenly* conducting? Is a conducting medium homogeneous? Is there inertia of ionic charges which represent the non-homogeneity of the medium? These questions still require answering; but in the seventies, in Germany, Maxwell's idea of magnetic force accompanying displacement currents was not generally received, and Helmholtz's question as to the induction in non-inductively wound coils really had reference to these displacements. Hertz won the prize by showing that at most only 1/20th or 1/30th of the extra-current could be due to electric inertia. By subsequent experiments on the possible effect of centrifugal force on the current in rapidly rotating plates, he reduced this estimate to a very much smaller value. Mr. Larmor has suggested that any centrifugal force may be balanced by a tension in the length of the current, much in the same way that the tension of a running rope will balance centrifugal force in the curves round which it may be running. In every way the subject deserves further investigation, for it is intimately connected with the most fundamental questions as to the nature of electricity and its connection with matter.

The next thing to which Hertz devoted himself was a prize problem proposed, at von Helmholtz's suggestion, by the Berlin Academy. The problem was to investigate Maxwell's postulate that changing electric displacement was an electric current. This was the bud from which Hertz's great work sprang. Of it von Helmholtz says: "It is a pity we do not possess more such histories of the inner psychological development of knowledge. Its author deserves our sincerest thanks for letting us see so deeply into the inmost working of his thoughts, and for recording even his temporary mistakes. By this work Hertz has settled for ever the question as to electromagnetic actions being propagated by a medium, and the only outstanding question of the kind is as to gravitation, which we do not yet know how to logically explain as other than a pure action at a distance." It thus appears that von Helmholtz to the last was unconvinced as to the probability of any hypothesis like Le Sage's or Osborne Reynolds's. He seems, on the other hand, to have been satisfied with the possibility of chemical actions being explained either by electromagnetic actions or by actions not at a distance. This latter term, of course, requires explanation as to what "at a distance" means. Any actions other than those of absolutely rigid bodies, such, for instance, as the fairly well-established forces of attraction of gaseous molecules for one another, and some of which can hardly be explained either by electricity, magnetism, or gravitation, seem to be actions at a distance that require explanation just as much as gravitation.

Following this short history of the work of his pupil which, coming from such a master, must have a permanent interest to all, von Helmholtz gives a *résumé* of the last work of Hertz. In it there is attempted a continuously elaborated presentation of a complete and self-dependent system of mechanics, in which each particular application of this science is deduced from a single fundamental law which can of course be itself only assumed as a plausible hypothesis. In order to explain how

<sup>1</sup> 'The Principles of Dynamics, developed on new lines:—Hertz's Collected Works,' vol. iii. Pp. 310. (Leipzig: Barth, 1894)

this is required, von Helmholtz gives a short history of the development of the science of mechanics. The first developments arose from the study of the equilibrium and motion of solid bodies in direct contacts with one another, such as the simple machines, the lever, the inclined plane, the pulley. The law of virtual velocities gives the most fundamental general solution of all such problems. Galileo subsequently developed the knowledge of inertia and of moving force as an accelerating agent. It was, however, conceived by him as a succession of blows. Newton was the first who arrived at the notion of force acting at a distance, and its more accurate determination by the principle of action and reaction. It is well known how strenuously he and his contemporaries resisted this idea of pure action at a distance. From this men developed the methods of treating all problems of conservation forces with constant connections whose most general solution is given by D'Alembert's principle. All the general principles of dynamics have been developed from Newton's hypothesis of permanent forces between material points and permanent connections between them. It was subsequently found that these laws held even when these foundations could not be proved, and it was thence deduced that all the laws of nature agreed with certain general characteristics of Newton's conservative forces of attraction, although it was not found possible to deduce all these generalisations from one common fundamental principle. Hertz has devoted himself to discovering such a fundamental principle for mechanics, from which all the laws of mechanics hitherto known as universally valid can be deduced; and he has carried out this with great acuteness, and by means of a very remarkable presentation of a peculiarly general kinematic conception. In working it out, he returns to the oldest mechanical theories, and supposes all actions to be by means of rigid connections. Of course he has to assume that there are innumerable imperceptible masses and invisible motions of these, in order to explain the apparent actions upon one another of bodies that are not in immediate contact. Though he has not given examples of how this may be the case, he evidently builds his expectation of being thus able to explain natural actions upon the existence of cyclical systems, rollers, &c., with invisible motions. The justification of such an assumption can only be obtained by its success. Von Helmholtz concludes this interesting preface by remarking how English physicists have so often based their work on dynamical and geometrical suppositions, as for example Lord Kelvin and his vortex atoms, Maxwell and his cells with rotating contents. These physicists, he says, "have clearly been more satisfactorily helped by such illustrations, than by the mere most general representations of the facts and their laws as given by the system of physical differential equations. I must confess that I have restricted myself to this latter method of investigation, and have felt most confidence therein: and indeed I might not have arrived at any important results by the methods which eminent physicists such as the three mentioned have employed."

Although so far it seems as if there were very little to choose between the old methods of supposing that natural actions can be explained by conservative forces between molecules and by systems of rigid connections, Hertz in his introduction shows that he is dissatisfied with the hypotheses, of these forces as entities, while von Helmholtz, by his silence, seems to hold the view that the old method was good enough for him. Hertz's method has, however, the advantage of turning our attention to something definite to be investigated and invented, namely, the structure of these rigid connections. It is apparently very closely related to Osborne Reynolds's and "Waterdale's" suggestions as to the structure of the ether, namely, that it consists of perfectly rigid particles in almost complete juxtaposition which, whether by their smoothness or by their rolling upon one another, waste no energy in internal heat motions.

In his own preface, Hertz says that he has culled many things from many minds, nothing particular in his work is new; what he presents as new is the arrangement and collocation of the whole, and the logical, or rather philosophical, aspect thereby attained.

To these prefaces there follows a long introduction, in which Hertz reviews and criticises the present foundations of dynamics. The great road by which this domain is now entered is one that was laid by Archimedes, Galileo, Newton, and Lagrange. It is founded on our notions of space, time, force, and mass. Force is introduced prior to motion, as the independent cause thereof. Galileo's notion of inertia only involved space, time, and mass.

Newton first in all four notions. To this D'Alembert's principle gave the analytical method of treating generally connected systems. May not all be deduction. Here Hertz introduces a likeness, as to the so-called forces of inertia. From his discussing the case of a solid subject to centrifugal acceleration by means of a string, the question is much more intricate than if he had taken the case of a body falling freely under gravity, where the force is applied directly by the earth to each part of the body, and not, as in the case of the string, distributed to each part by stresses in the solid. Hertz seems to consider that there is some outstanding confusion in applying the principle of equality of action and reaction, and appears to hold that by this principle the action on the body requires some reaction on the body whose acceleration is the effect of the force. He does not seem fully to appreciate that action and reaction are always on *different* bodies. From his consideration of this, and from a general review of our conception of force, he concludes that there is something mysterious about it, that its nature is a problem in physics, like the nature of electricity. We have a quite distinct conception of velocity; why not of force? He concludes that the mystery is not due to our not having enough to associate with the word, but to our trying to put too much more. These objections, however, do not invalidate in any way the objections that have been made; they only require to be set off as a real foundation for our dynamics. He goes on to describe his method of filling nature with forces of which, being equally between molecules, we can have no direct experience. A body at rest on a table is acted on by gravitation, he states, not by magnetic, electromagnetic, electric, and other forces. Some of these would drag it to pieces if unbalanced by a mystery of others. Is this a sound view of nature? How can we get some more attractive one?

Another view may be elaborated by making our fundamental quantities, time, mass, and energy. There is no book which in this view of nature is fully and consistently worked out. At least none that Hertz was acquainted with. He sketches what might proceed. Besides the postulate of the conservation of energy we require some definition of potential energy and experimental relations connecting it with space, and in addition we have a choice of relations with kinetic energy, of which Hertz suggests the choice of the integral form of Hamilton's principle known as that of least action. This is, no doubt, a more legitimate use as a fundamental postulate, but it only implicitly involves the idea of force, which then comes in merely as a definition. To this method, which certainly has several great advantages, Hertz makes a number of objections. In the first place he objects that it requires the equations of motion to be integral equations, and we know such actions depending on one hard body on another cannot be so expressed. We must, in order to specify the subsequent motion, determine the direction round the normal axis through the point of contact, and this cannot be specified except in terms of the position of the motions; and yet we can hardly dispute that such a thing is possible in nature. If we treat it as the limits of freedom of motion, we introduce the whole of the difficulties of force, and the regular heat actions which have not yet been fully made amenable to accurate dynamical treatment. Again, difficulties arise in the application of this method. There is great difficulty in specifying energy itself. How can it be satisfactorily measured without returning to the first method, and introducing the notion of force? Some have conceived of energy as a sort of fluid, but when we try to form concrete conceptions of what it is, and, we get involved in perplexities. The very existence of the form of energy is a very serious difficulty. Again, it is doubtful whether it can be sound to consider the integral form of action as a *fundamental* principle. It makes the present method of the future. It sets the problem to nature to make a certain integral the minimum.

A good many of the objections could be got over by making all energy kinetic, which is what Hertz himself practically does in his own method.

The third method begins by assuming only three fundamental quantities, time, space, and mass, and then, as non-fundamental, force and energy. In this method we learn how nature works, we already postulate the invisible moving structures of nature. We postulate these in the atoms and molecules of matter. Hertz, in an allusion to the workings of an jetting stream, where the masses and motions are producing the effects of matter, as we perceive, and what we call force and energy

are due to the actions of these invisible structures, which he implicitly identifies with the ether.

We must, however, assume certain connections between the three quantities, time, space, and mass. Between time and mass there is no direct connection. Space and mass, Hertz considers, are connected by the existence of a given mass at each point of space. He cannot mean here to assume a complete plenum, which would make serious difficulties in the way of the working of what he subsequently assumes to be a structure of rigid bodies; he must include a vanishingly small density at some points, though perhaps he may have had in view the filling of the interstices between his rigid bodies with a fluid. Any way, he goes on to say that some connection is required between all three quantities, and for this purpose he postulates his great fundamental single law of motion, which he considers is an extension to systems of Newton's first law of motion for a single body: it is that a system, which is unconnected with any others, moves with constant swiftness along one of its straightest paths. "Systema omne liberum perseverare in statu quo quiescendi vel movendi uniformiter in directissimam." In order to understand what Hertz here means by the path of a system, and by its being straight or curved, requires further explanation; but from this principle, which is capable of analytical representation, and from the assumption that the connections of a system are all rigid, he deduces all the fundamental principles, conservation of areas, momentum, energy, least action, &c. In considering the motion of any part of a system, we find that we may conveniently introduce certain actions of the other parts of the system upon it which are measured by forces, which thus come in as mere definitions. He does not seem to investigate anywhere the question as to the danger of his rigid connections becoming tangled. Analytically a postulate that the points of two different bodies that act on one another are in contact is easily expressed, but it does not follow that when we come to invent actual rigid connections to produce the observed effects, they will do so for any length of time without jamming. It is a seductive theory that gravitation or electrical actions may be due to vortex filaments ending on atoms; but the tangling of the filaments is a very serious difficulty that has not been satisfactorily got over. Hertz does not seem to feel this as a serious difficulty, but he does notice an obvious objection that is sure to be raised, namely, that rigidity in itself postulates forces. To this he replies that rigidity in itself is merely a matter of definition and of fact. How is our view of the fact that two points are at a constant distance apart, improved by saying that there is a force between them? As, however, real bodies are only imperfectly rigid, Hertz concedes that it may be that when we learn more about these invisible connections, they may turn out not to be absolutely rigid. It is a matter for further investigation. This very same view might have been urged, and has been urged already with reference to actions like gravity. The law of gravity can be perfectly well described without any reference to the notion of force. We may say, every element of matter moves towards every other element in the universe with an acceleration inversely proportional to the square of their distances apart. We can describe the law kinetically, just as Hertz proposes to describe the law of motion of parts of a rigid body. There is no *necessity*, however convenient it may be, to introduce the notion of force; the other bodies in the universe are a sufficient cause for motion of each, without postulating an entity, force. The principal reason for introducing this notion was to account for a body acting where it was not; force was invented to get over this; the body produced force, and this force existed where the body did not, and there acted on other bodies. This whole difficulty seems, however, to be partly due to want of distinct ideas connected with the question of where a body is. We are so accustomed to consider a body as having a definite boundary, that we think there is a definite boundary in reality. All we know of the atoms and molecules, however, would lead us to conclude that round the centre of each there is a very complexly structured region which may or may not change abruptly in structure, but which often extends to considerable distances from the atom, so that it is practically impossible to state absolutely where the atom ends and where the empty space begins. With this view of matter there is no serious reason why we may not rightly consider each atom as existing everywhere that it acts, that is, throughout the whole of space, for its action in causing gravitational accelera-

tions exists, so far as we know, throughout space. A view of this kind entirely gets over any difficulty of a body acting where it is not; for all bodies are everywhere, and if we consider matter to be the cause of motion of other matter, there seems no very imperious necessity for imagining another cause which we call force.

There are two assumptions that Hertz makes which he considers can only be proved by their success. One is that all the connections in nature can be represented by linear differential equations. There are plenty of cases imaginable in which this would not be true, as, for example, connections depending on the curvature of the path. The other assumption is that forces can be represented by force functions. This, again, may not be a complete representation of nature.

Following this introduction comes the book itself, which is divided into two parts. The first part is purely kinematical, the second deals with the deductions from Hertz's fundamental postulate of motion in the straightest possible path.

The first part begins by explaining what is meant by the path of a system of points. To get at this we calculate the mean square of the displacements of a system of points when they are displaced: the square root of this, Hertz calls the displacement of the system of points. If there is a mass at each point, then the displacement of the system is the square root of the mean squares of the displacements of the points, each multiplied by the mass at it. Thus, if  $s$  be the displacement of the system, and  $s_1, s_2, \dots$ , the displacements of each point of masses  $m_1, m_2, \dots$ . Then

$$(m_1 + m_2 + \dots) s^2 = m_1 s_1^2 + m_2 s_2^2 + \dots$$

By taking  $s_1, s_2, \dots$ , as the displacements in the element of time, we evidently get a similar expression for the velocity of the system, and for its acceleration. The mean square of the velocity of the parts of a system is well known in connection with the principle of least action. Further than this, however, Hertz defines the angle between two displacements. This is defined by the equation

$$(m_1 + m_2 + \dots) s s' \cos \epsilon = (m_1 s_1 s_1' \cos \alpha_1 + m_2 s_2 s_2' \cos \alpha_2 + \dots)$$

$s$  and  $s'$  being the two displacements of the system as calculated above, and  $s_1, s_2, \dots$ , the two displacements of each point and  $\alpha_1, \alpha_2, \dots$ , the angles between these latter, then  $\epsilon$  is the angle between  $s$  and  $s'$ . Hertz remarks that these can all be very interestingly expressed in terms of space of multiple dimensions, in which analytical diagrams are supposed to be drawn. This, however, represents the real by the unattainable. There follow, then, several chapters expressing these displacements in terms of various systems of coordinates, and discussions as to the conditions that the connections of a system should fulfil in order that they may be represented by equations not involving differentials. The curvature of the path is here studied. It is defined as  $c = \frac{d^2 \epsilon}{ds^2}$ , and from this it follows that, representing

$\frac{d^2 x}{ds^2}$  by  $x''$ , and

$$(m_1 + m_2 + \dots) x'' = \sum_1 (m_1 x_1'' + y_1'' + z_1'')$$

The problem then of making the path of the system straightest, is to make  $c$  a minimum consistently with the connections of the system. Now, in accordance with his assumption that the connections of the system are linear differential equations of the form

$$\sum_1 P_1 x_1' = 0,$$

whose differentiation gives

$$\sum_1 P_1 x_1'' + \sum_1 \frac{dP_1}{dx_2} x_1' x_2' = 0,$$

we are to determine the minimum value of

$$c^2 = \sum_1 \frac{m_1}{m} x_1''^2,$$

when

$$m = m_1 + m_2 + \dots$$

In determining the variations of these, we must recollect that the positions and direction of displacement, i.e. the first differentials of the system, are supposed given, and that it is only the second differentials that can be varied in order to make  $c$  a minimum. Calling, then, a system of indeterminate co-

efficient  $\lambda, \mu, \dots$ , corresponding to the equations of condition, we evidently get a system of equations of the form

$$\sum_1 \lambda_1 P_1 = 0,$$

which are sufficient to determine the second differentials required.

From this form of result one can see how the ordinary equations of motion are derivable from the conception of the straightest path, and how, when dealing with part of a system, these indeterminate coefficients introduce what are equivalent to forces. This method of deducing the equations of motion lends itself particularly well to the deduction of the principles of least action, and the other general methods in dynamics. So far, he deals with free systems subject only to internal constraints. It is here he investigates how to deal with parts of systems that he requires to consider the nature of the constraints joining one part to another. For this purpose he defines two systems as coupled when coordinates can be so chosen that one or more of them are the same for both systems. Force is then defined as the action one system has on another. Now, when a coordinate is the same for two systems, one of the equations of condition is  $\dot{p} = p'$ ,  $\dot{p}$  and  $p'$  being coordinates of the coupled systems, and for this equation the coefficient  $P$  becomes the same in the two systems, being unity for each, so that the equations of motion involve the indeterminate coefficient  $\lambda$  corresponding to this equation equally with reference to each system. It is thus that the equality of action and reaction appears, being thus bound up with the constant equality of the common coordinate. This seems to be where the assumption that the connections are rigid is introduced. When rigid bodies act upon one another by non-slipping contact, certainly the coordinates of the point of contact are common to the two systems. It is also quite evident that if we assume rigid bodies acting upon one another by contact only, we can have no potential energy, and all necessity for talking about the forces disappears. In Hertz's system there are no forces like Newton's acting between bodies which have no common coordinate, like the earth and the sun. We would have to invent connections to explain the motion before we could be certain that action and reaction are equal in this case.

The proof of the principle of virtual velocities by substituting for the forces between parts of a system a number of pulleys which produce the same effects, is quite analogous to Hertz's supposition that the actual connections are by rigid bodies. It is not, however, liable to the objection that the connections may become tangled, for it is only applied to the case of infinitesimal virtual displacements, while Hertz postulates the possibility of his connections existing as the real ones for all time, and throughout all finite displacements of the system.

The work considers many other matters, and shows how all the general methods in dynamics are deducible from his fundamental postulate of the straightest path. It includes discussions on how best to deal with systems whose connections do not involve differentials, how to treat cyclical coordinates, and many other matters. It is most philosophical and condensed, and gives one of the most—if not the most—philosophical presentations of dynamics that has been published. It is worthy of its author: what more can be said?  
G. F. FITZGERALD.

### PSEUDO-SATELLITES OF JUPITER IN THE SEVENTEENTH CENTURY.

IN the New York *Nation* for January 11, 1894, Dr. D. C. Gilman, President of the Johns Hopkins University, called attention to an interesting letter from John Winthrop, jun., to Sir Robert Moray, concerning the satellites of Jupiter. In this letter, which was written from Hartford, Connecticut, on January 27, 1663, Winthrop described an observation of Jupiter which he had made on the night of the previous 6th of August, when he had very distinctly seen five satellites about that planet. He was naturally "not without some consideration whether that fifth might not be some fixed star with which Jupiter might at that time be in near conjunction," and expressed the wish that more frequent observations might be made upon that planet with a view to ascertaining whether it is not impossible to discern a fixed star, when it is so near to the planet as to appear "within the periphery of that single *intuitus* by a tube which taketh in the body of Jupiter," and if

whether it's star is not a new satellite. He further proceeds: "I am loath to mention this as an inquiry whether any such number of Satellites or moons hath been scene by any astronomer or Mr. Roke [Hooke] or any mathematicians or other gentlemen that have good tubes and often have the curiosity to view the planet, for possibly it may be new to me which hath been more usually knowne by others, though the truth of such a thinge is not new to my selfe, for I remember I met with the like narration many years since in a little book intituled Philosophia Naturalis per Joh. Phocyliden, though I thought that was but a mistake of some fixed stars." Now that Prof. Barnard has discovered a genuine fifth satellite of Jupiter after the lapse of nearly three centuries since Galileo's telescope detected the Medicean stars, a greater interest is given to those imaginary satellites which from time to time have claimed a place in the solar system. In a paper in the Johns Hopkins University *Circular* for last May (referred to in *Nature*, vol. I, No. 1283, p. 113; Mr. Frank H. Clitz has given a probable identification of Winthrop's supposed satellite with P. A. C. 6448. In a post-script to his article it is pointed out that the work to which Winthrop refers is presumably the *Philosophia Naturalis, seu Physica Vetus-Nova* of Johann Hevelius, born at Holwaden in Friesland in 1618; died at Franeker, February 13, 1651. As President Gilman's suggestion, I have followed in this case, and have succeeded in examining the work in question. I find that it contains more than a casual reference to additional satellites of Jupiter; in fact, a whole chapter is devoted to a discuss on of certain observations, which seems to be sufficiently interesting to deserve a special notice.

Hevelius' treatise was published at Franeker in 1651, shortly after the death of the author. On the title-page it is described as written "Ab Eximio Viro JOH. PHOCYLIDE HOLWARDA/CI A. M. Med. Doct. & Philosophæ, dum viveret, Profess. Ordinariò." There is also a portrait. The third of the three parts into which the book is divided is entitled "Physica Cœlestis," and it is doubtless this portion of the *Philosophia* which Winthrop had in mind when writing his letter to Sir Robert Moray. It is not Phocylides himself who claims to have discovered new moons of Jupiter; nor does he believe in their existence. On the contrary, he treats the supposed observations with the severest disapprobation; and while in general he is enthusiastic over the revelations which the telescope had already made and was daily making, this particular discovery, which he regards as spurious, rouses him to the most strenuous exertions in order to effect its refutation. The discoverer, by the name Antonius Maria Schyrleus de Rheita, stated that he had seen, not one, but five new satellites of Jupiter, all farther removed from the planet than the four Galilean moons, and revolving in a contrary direction. Phocylides' account of the matter may be briefly summarised as follows: First he refers to five stars near a certain known star of the fourth magnitude. They are "intra duodecimum & decimum quintum Piscium gradum" (p. 205) "versus sinistram secundum Signorum successione[m]" (p. 205 and p. 284.)

These stars, he continues, have given rise to no little controversy among learned and experienced astronomers (astrologos), whether they are fixed stars or erratic, and, more particularly, whether they are companions (comitones) of Jupiter. The discussion of this point is then postponed. Chapter xvi. treats of the number of the planets and their division in kind. Both satellites and planets proper are included in the term "planete." After rejecting the sun from his ancient place among the seven planets, and adding to their number the two *stellæ* near Saturn and the four about Jupiter, discovered in the present century by the aid of new and admirable instruments, such as Telescopium, specula, and others of the same sort, he adds the Earth to the twelve hitherto contained. It is thus certain, he says, that there are at least thirteen planets, since it is not yet known whether Mars, Venus, and Mercury have any *comitones* revolving about them. "But as to the five other comitones which P. Anon. Mar. d. Eberh. boasts that he has observed and called Urbanæ a-staræ, learned men are justly in doubt whether they should be referred to the fixed or to the wandering stars." Nothing further is added at this place, but he proceeds to divide the thirteen planets into primary and secondary. The former (six in number) are named in order from Mercury to Saturn, with the Earth in the Sun's former place. The latter are Saturn's two, and Jupiter's four satellites. The seventh is the Moon. Anyone who doubts this, he adds, will be convinced by what is

soon to be said, as well as by the considerations contained in the chapter "De Lunæ corpore & motu." After several interesting chapters, including one on Saturn and his laterones, and another on Jupiter and the Medicean stars, we come to chapter xxi., entitled "De Pseudo-Jovialibus: & priorum consuetaria." Phocylides' attitude is at once disclosed. He refers to the pseudo-discoverer as "quidam Antonius Maria de Rheita, (homo in Papatu arrogans, invidiosus, jactanciosus præceps & fatuus, aliorum gloriam pro propria injusè & cum pudoris oblivione captans & vindicans)."

The discovery was alleged to have been made at Cologne near the end of the year 1642, and was announced in a letter to Puteanus. But it so happened that Hevelius had noticed and described these very stars several months previously. His observations were made in August 1642 and the succeeding months, and Phocylides regards the claims of Rheita to have been the first to discover them as "fœdum mendacium," as, by his own admission, he did not observe them before the end of the year. The identity of Rheita's pseudo-joviales with these fixed stars is shown by a comparison of the actual positions of Jupiter on the dates when the observations were made. Our author points out that on December 29, the day of Rheita's discovery, Jupiter occupied the same position as on the previous 4th of September, when Hevelius observed him and noticed the five stars. This position is defined by Phocylides in the words, "decimo tertio gradu Piscium, cum quindecim minutis." Again, Hevelius saw Jupiter on August 28 "in decimo quarto gradu Piscium, cum quindecim minutis," where Rheita observed him on January 4 of the following year (1643). The new circum-joviales are then, says Phocylides, none other than the stars recently discovered in Aquarius. They do not move round Jupiter, as they would do if they were secondary planets, and are therefore fixed stars, "manebuntque fixæ usque ad sæculi consummationem." They were observed by Hevelius to remain stationary, while Jupiter left them behind him. Phocylides challenges any doubter to look for these stars himself, when all five will be found in their original position and at the same distances one from another. He concludes with the words (p. 280): "Hallucinatur itaque errare & invidiosus gloria Rheita se ipsam stultus."

The following will throw further light on Rheita's tendency to form hasty conclusions. According to Phocylides he declared that he had observed three of the Medicean stars to be in a straight line, but the truth "tantam obnoxiæ latitudinem, quæ, si ex centro Jovis Eccentricum ad illum excurrentem metamur, ad quindecim gradus exerescat." This, says our author, is contradictory to the observations of all "mathematicians," who unanimously agree that the Medicean stars never recede from Jupiter in latitude more than three minutes, whether to the north or to the south. He then states that this fourth star, so far from being a true Galilean satellite, was not even a pseudo-jovial, but another fixed star. Gasendi observed the satellites on the same night, and saw all four in a straight line, the second slightly to the north; but they were differently disposed with regard to Jupiter. In all probability, Phocylides concludes, the first (innermost) satellite was obscured by the planet, if, as is likely, the observations were not made at precisely the same hour; for Jovial Mercury (as he is called) runs his course round Jupiter in a few hours more than a whole day. Phocylides supposes that, as Rheita was well aware that there were four satellites, he mistook this fixed star for the fourth satellite.

The existence of Rheita's new satellites was opposed by Gasendi in his "Jadicium de novem stellis circa Joveam visis" (see Delambre, "His. de l'Ast. Mod.," ii. p. 354), and by Hevelius in his "Selenographia," i. p. 437). Lobkowitzius intended Rheita against Gasendi ("Phocylides," p. 295). Delambre devotes several pages to Rheita, or Schyrle, and gives some account of his work "Oculus Enoch et Eth. sive Radius solere mysticus," Antwerp, 1645. In this book, according to Delambre, he admits that he has not succeeded in observing his satellites again, but asserts anew that he noticed changes in their mutual distances. He explains their disappearance by connecting them with variable stars, which he supposes to have large orbits and long revolutions. He believed, moreover, that the spots of the sun were planetæ, and that the sun itself rotate but once in a year.

Phocylides also mentions circum-martiales and circum-saturnales, which, no less than the circum-joviales, must be held to be fixed stars.

It will thus be seen that Winthrop was right in remembering

Phocylides' treatise as a work in which the discovery of new satellites was mentioned. But apparently he did not remember very accurately the position assumed by the author, for the book contains but little to encourage an observer in the belief that he has discovered new satellites.

It is perhaps worth noticing that the *Philosophia* was published less than fourteen years before the date of Winthrop's letter; it must therefore have been quite a new book when Winthrop perused it, as he says, "many years since."

CHARLES W. L. JOHNSON.

UNIVERSITY AND EDUCATIONAL INTELLIGENCE.

OXFORD.—Prof. J. Bardon Sanderson has been appointed Regius Professor of Medicine in succession to Sir Henry W. Acland, whose resignation was announced last Term. In accepting the Regius Professorship, Prof. Sanderson vacates the Waynflete Chair of Physiology, which is more valuable in a pecuniary sense. It is naturally a matter of regret that he should formally sever his connection with the school of Physiology which he may be said to have created in Oxford, but it is recognised that no better appointment could have been made to the headship of the Medical School which he has done so much to encourage, and whose interests he will have further opportunities of promoting in his new position.

At a meeting of the Royal Statistical Society held on Tuesday, a paper was read, by Mr. L. L. Price, on "The Colleges of Oxford and Agricultural Depression." The accounts of the Oxford and Cambridge Colleges have been published year by year for some time past, and in Mr. Price's paper the accounts of the Oxford Colleges for the years 1883-93 were brought under review. The gross external receipts of the Colleges were in 1893 some £11,000 less than in 1883, and the net external receipts some £13,000. Though the external receipts are not entirely derived from agricultural estates, it seems within the facts to regard agricultural depression as responsible for a loss of upwards of £60,000 of income in 1893. Turning to the effects of the depression upon the emoluments of the Heads, Fellows, Scholars, and Exhibitioners, to which the College revenues are mainly devoted, it appears that these effects have been mitigated by the circumstances that the external receipts are not exclusively agricultural, and that the emoluments are also partly derived from internal receipts and from Trusts. Still the emoluments of the Heads have fallen from £22,811 to £20,905, and of the Fellows from £83,820 to £74,749. The emoluments of the Scholars and Exhibitioners have however increased from £44,776 to £48,378, and their number has grown by upwards of ninety; and if the increased contributions made by the Colleges to the University are taken into consideration, the fall in the total payments is only about 5 per cent. But there are Colleges, where diminutions have occurred of more than 25 per cent. in the emoluments of the Fellows, and the figures generally are altered considerably for the worse by eliminating a few prosperous Colleges.

CAMBRIDGE.—Mr. A. Hutchinson, Fellow of Pembroke College, has been appointed Demonstrator of Mineralogy and Assistant-Curator of the Museum, in place of Mr. Solly, who has retired.

The Downing Professor of Medicine (Dr. Bradbury) announces that the newly-organised Museum of *Materia Medica* and the Pharmacological Laboratory are now open daily to students of medicine, and that demonstrations will be given therein by Mr. Marshall, the assistant to the Professor.

Dr. Gaskell, F.R.S., has been appointed an additional member of the Board for Biology and Geology.

THE Royal Agricultural Society has now issued its revised regulations and syllabus for the society's senior examinations, framed in accordance with the important modifications recently decided upon. The council have resolved to place annually at the disposal of their education committee five life memberships of the society, to be awarded to the five candidates who stand highest on the list of winners of first-class certificates, and who obtain not less than two-thirds of the maximum number of marks. The gold medal of the society will be bestowed upon the candidate who stands highest on the list of winners of life memberships, provided that he has obtained not less than three-fourths of the maximum number of marks, and silver medals

upon the other winners of life memberships, including the candidate at the head of the list, if he does not reach the standard required for a gold medal.

THE Association of Head Masters held its first meeting as an incorporated body on Thursday last. One of the items of the agenda was a paper in which Mr. Stuart described the usual practice of teaching science, and said most of them were satisfied that such a system had no educational value at all. All experiments must be capable of being performed and the observations made by the students. The experiments must be chiefly quantitative and especially at first. Books and lecture demonstrations must be avoided. He thought that a good grounding in science might be given by doing practical work in an ordinary class-room, upon common tables, with home-made apparatus. The following resolutions were afterwards passed by the meeting:—

(a) "That the association is of opinion that examining bodies should encourage a more rational method of teaching science, by framing the syllabuses in such a manner that the practical work required may be strictly illustrative of the theoretical instruction given."

(b) "That it be referred to the general committee to appoint a small sub-committee, so that a report may be presented to the next summer general meeting containing detailed suggestions which it is proposed to make to examining bodies concerning examinations in science."

THE Research Scholarship given by her Majesty's Commissioners for the Exhibition of 1851, to Mr. Edward Taylor Jones, of the University College of North Wales, in 1892, has been renewed for a third year. Such renewal is only made in cases of exceptional merit, where valuable scientific results are likely to be obtained by a continuance of the scholar's research work. Mr. Jones has just completed, at the University of Berlin, an experimental investigation solving an important problem in magnetism. An account of the research has been communicated to her Majesty's Commissioners, and will shortly be published.

THE Professorship of Mathematics in the Government Training College, Ireland, vacant by the retirement of Principal Corbett, has been filled by the appointment of Mr. Dilworth, of Trinity College, Dublin.

SOCIETIES AND ACADEMIES.

PARIS.

Academy of Sciences, January 7.—M. Marey in the chair.—A list of the present members, foreign associates, and correspondents of the Academy is given.—M. A. Cornu was elected Vice-President for 1895.—Pre-arcation, in the electric furnace, of *graphites fusonnants*, by M. Henri Moissan. For all varieties of graphite prepared by intense heat, the temperature of intumescence after soaking in nitric acid is about 165–175° C. They resemble natural graphites in this and other respects, hence the probability that the latter have been produced at a very high temperature under moderate pressures in masses of iron which have since disappeared.—The vasomotor nerves of the veins, by M. L. Kanvier. From the results of experiments quoted, the author concludes that veins as well as arteries are supplied with vasomotor nerves.—On the first scientific voyages of the *Princess Alice*, by Prince Albert I. of Monaco.—An addition to Le Verrier's theory of the movement of Saturn and rectification of the Tables, by M. A. Gullot.—On the approximate development of the perturbation function, by M. N. Coculesco.—On roots common to several equations, by M. Walter Byek.—On the theory of a system of differential equations, by M. A. J. Stodolkievitz.—On the theory of exchangeable substitutions, by M. Demecky.—On the absolute value of the magnetic elements on January 1, 1895, by M. Th. Moureaux. The values are given for (A) Parc Saint-Maur, Long. 0° 9' 23" E. and Lat. 48° 48' 34" N.; (B) Perpignan, Long. 0° 32' 45" E. and Lat. 42° 42' 8" N.

Elements.	Abs. values Jan. 1, 1895.		Secular variation in 124.	
Declination ...	(A) 15° 12' 7"	(B) 4° 3' 4"	(A) -5' 3"	(B) -5' 0"
Inclination ...	65° 49'	60° 9'	-1'	-0' 3"
Horizontal component ...	0' 15641	0' 22345	+0' 00017	+0' 00025
Vertical component ...	0' 42277	0' 58261	-0' 00003	+0' 00021
Total force ...	0' 46167	0' 44911	+0' 00005	+0' 00031

Use of the critical temperature of liquids for the recognition of their purity, by M. A. N. Picot. A convenient method of determining the critical points of liquids is described. Any impurity causes a difference in the critical temperatures in the same sense as the difference produced in the boiling points, but in the former case the difference is of far greater magnitude than in the latter. On the qualitative separation of nickel and cobalt, by M. A. N. Picot. The author avails himself of the property of ammonium nitrate in preventing the precipitation of nickel sulphide while allowing the complete precipitation of cobalt sulphide. Tartaric acid is added to the clear solution of the two metals, then soda or potash in large excess and hydrogen sulphide is passed. The nickel passes into the filtrate as a nearly black solution, mere traces give a brown tinge. The method is not quantitative.—See 2 points in the spermatogenesis of the Selachians, by M. Arnold Sabatier.—On the genesis of intestinal epithelium, by M. F. Hennel-Royale. Observations confirm the author's views that: 1. The connective tissue continues more or less, during life, to be the matrix giving rise to the elements of other tissues, that is a post-embryonic blastoderm. 2. Epithelial tissues, in most cases, the forms limiting the free surfaces of the connective tissue.—Physiological researches on the Lamellobranchia, *Gen. et. Sp.*, by M. Picot.—On some lakes in the Alps and Pyenees, by M. A. Delebecque. The leptas and albitals of most of the important mountain lakes are given.

BERLIN.

Physical Society, November 30, 1894.—Prof. von Bezold, President, in the chair.—Dr. Aschknass described his experiments on the influence of electric waves on the galvanic resistance of metallic conductors. Gratings made of tinfoil when placed near a Hertz's exciter showed a diminished resistance which was quite independent of the action of light due to the primary sparks, and was persistent after the cessation of the electric oscillations, but could then be restored to its original value by mere mechanical percussion. A series of experiments proved that it is really the electric waves which altered the resistance of the grating, and the results were extended to other metallic conductors. The speaker drew attention to analogous observations made by English and Swiss physicists who had found that filings of iron and other metals enclosed in glass tubes had their resistances altered by electric sparks discharged in their neighbourhood. In their case, also, the original resistance was restored by mechanical vibration.—Dr. Gross spoke on the electrolysis of a solution of mixed nitrate and sulphate of silver to which a little nitric acid had been added. Silver was deposited on the cathode, and a black substance on the anode; the latter he had not as yet obtained free from silver, but it did not contain any sulphur, although 60 per cent. of sulphuric acid had disappeared from the solution.

Physiological Society, December 7.—Prof. du Bois Reymond, President, in the chair.—Prof. L. Lewin gave an account of some experiments made with an alkaloid obtained from a North Mexican cactus called "Peyotl." It is well known that this cactus has an intoxicating action, and in larger doses produces coma and a state of nervous excitation accompanied by a so-called "power of prophesying," similarly attributed to the religious exhibitions of the temple at Delphi. Small doses of the alkaloid when given to frogs produced tetanic cramps and a greatly increased reflex irritability, analogous to "tychning," but with this difference, that by carefully apportioning the dose the cramps were permanent for several days. Similar results were obtained with rabbits, and Prof. Lewin regarded the new alkaloid as specially adapted to further the study of the nature of the "peyotl" in rabbits it was noticed that during each paroxysm of tetanus the blood-vessels of the ears were widely dilated. The speaker had also found alkaloids with powerful action on many species of *Cactas hitherto regarded as harmless by botanical writers, and highly resembling caffeine.*—Dr. G. Joachim had investigated physiographically the effect of suspension by the head on the circulation, and in the case of a number of invalids, of whom some were suffering from heart-disease, had observed only a very increased frequency of the pulse, which is probably, in most cases, attributable to psychic excitation.—Prof. Gal commented on the results of an investigation, made by a new method by M. S. Clark, of Cleveland, on the terminations of motor nerves in insects, which had shown an analation to the motor fibre from a single cell here leaves the mouth of Hemic, and is distributed to the capillaries of the musculature, where it is medullated in the same way spread out over the muscle itself.

BOOKS, PAMPHLETS, and SERIALS RECEIVED.

Books.—*Logie*, by Dr. C. Sigwart, translated by H. Dendy, 2 Vols., 2nd edition (Sonnenschein).—*Les Abimes*, by F. A. Martel (Paris, Delagrave).—*Essays on Rural Hygiene*, by Dr. G. V. Poore, 2nd edition (Longmans).—*Annuaire de l'Academie Royale des Sciences*, 86<sup>e</sup> annee, de Belgique, 1895 (Bruxelles).—*Astronomische Chronologie*, by Dr. W. F. Wislizenus (Leipzig, Teubner).—*Handbuch der Theorie der Linearen Differentialgleichungen*, by Dr. L. Schlesinger, Erster Band (Leipzig, Teubner).—*Laboratory Exercises in Botany*, by Prof. T. S. Briston (Philadelphia, Saunders).—*Smithsonian Report*, 1894 (Washington).—*Geological Survey, Alabama, Report on the Geology of the Coastal Plain of Alabama* (Montgomery, Alabama).—*Tables and Directions for the Qualitative Chemical Analysis of Moderately Complex Mixtures of Salts*, by M. M. P. Muir (Longmans).

PAMPHLETS.—*Fifth Annual Report of the Liverpool Marine Biology Committee and their Biological Station at Port Erin*, by Prof. Herdman (Liverpool, Dobbs).—*On the Search for Coal in the South-East of England*, by W. J. Harrison (Birmingham).—*Eine Discussion der Kraft der Chemischen Dynamik*, by Dr. L. Stettinheimer (Frankfurt a.M., Beckhold).—*The Varieties of the Human Species*, by Prof. G. Sergi (Washington).—*Royal Horticultural Society Report for 1894-5* (Victoria Street).—*Idem*, Arrangements for 1895 (Victoria Street).

SERIALS.—*Geographical Journal*, January (Stanford).—*American Journal of Science*, January (New Haven).—*Gazzetta Chimica Italiana*, Ann. LVII, 1<sup>a</sup> Fasc. VI (Roma).—*Proceedings of the Physical Society of London*, January (Taylor).—*Journal of the Chemical Society*, January (Gurney).—*Idem*, Supplementary Number (Gurney).—*Record of Technical and Secondary Education*, January (Macmillan).—*Revue sur Petrographie der Ostlichen Centralalpen speziell des Gross-Venedigergebietes*, by Dr. L. Weinschenk, Teil II (München).—*Morphologisches Jahrbuch*, 22 Band, 2. Heft (Leipzig, F. Teubner).—*Journal of the Franklin Institute*, January (Philadelphia).—*Journal of the Royal Horticultural Society*, January (Victoria Street).—*Engineering Magazine*, January (Tucker).

CONTENTS.

PAGE

Epigenesis or Evolution. By G. C. Bourne . . . . .	265
Coal-Dust and Colliery Explosions . . . . .	268
The Mode of Life of Marine Animals. By W. A. H. . . . .	269
Our Book Shelf:—	
Clowes: "Elementary Qualitative Chemical Analysis" . . . . .	270
Muir: "Tables and Directions for the Qualitative Chemical Analysis of Moderately Complex Mixtures of Salts" . . . . .	270
Francis: "Laboratory Exercise Book for Chemical Students" . . . . .	270
Parker: "Elements of Astronomy" . . . . .	270
Letters to the Editor:—	
Exploration at Ruwenzori.—G. F. Scott Elliot . . . . .	271
The Alleged Absoluteness of Motions of Rotation.—A. B. Basset, F.R.S.; Prof. Oliver J. Lodge, F.R.S. . . . .	271
The Quarrying of Granite in India. Dr. H. Warth . . . . .	272
Storm Statistics at Bidston.—William E. Plummer . . . . .	272
Peculiarities of Psychical Research.—Prof. Karl Pearson; H. G. Wells . . . . .	273
The Suspended Animation of Snakes.—S. Garman; W. Kennedy . . . . .	274
" Finger-Print " Method.—Kumagusu Minakata . . . . .	274
A White Rainbow.—Rev. Samuel Barber . . . . .	274
American Topography. By A. Fowler . . . . .	274
Life at the Zoo. ( <i>Illustrated</i> ) . . . . .	276
Intercolonial Astronomy and Meteorology . . . . .	278
Notes . . . . .	278
Our Astronomical Column:—	
δ Cephei . . . . .	282
The Vatican Observatory . . . . .	282
An Indispensable Annuaire . . . . .	282
The Unification of Civil and Astronomical Days . . . . .	282
The Foundations of Dynamics. By Prof. G. F. Fitzgerald, F.R.S. . . . .	283
Pseudo-Satellites of Jupiter in the Seventeenth Century. By Charles W. L. Johnson . . . . .	285
University and Educational Intelligence . . . . .	287
Societies and Academies . . . . .	287
Books, Pamphlets, and Serials Received . . . . .	288

THURSDAY, JANUARY 24, 1895.

## A BAD METHOD IN TEXT-BOOKS.

*Lehrbuch der Vergleichenden Anatomie.* Von Arnold Lang, o. Professor der Zoologie und vergleichend-Anatomie, Zurich. 4te Abtheilung: Echinodermen und Enteropneusten. (Jena: Fischer, 1894.)

PROF. ARNOLD LANG completes, by the publication of this fourth part, his treatise on the comparative anatomy of Invertebrata. As the successive parts of this work have appeared, the author has changed to a considerable degree the limits of space which he appears originally to have contemplated, and has consequently treated those groups reserved for later volumes at greater length than that which he permitted himself to occupy in the first part of the work. We note that he now proposes to rectify this inequality by the production of new editions of the earlier part of the treatise.

Prof. Lang remarks in an interesting "Nachwort," that "man hat es vielfach getadelt"—that is to say, "complaints have been very generally made"—that the names of authors are not cited in the discussions which constitute the text of his work. I confess that I am most emphatically in agreement with those who have "getadelt"; and I do not think that Prof. Arnold Lang's contention is either correct in itself or sufficient (if it were correct), when he asserts that the book would have been double the size it is, had he given an impartial account of the historical development of the knowledge of the facts which he describes, with reference to the names of the most important authors. There are, it seems to me, three good reasons for adopting the method to which Prof. Lang objects. Firstly, such a method (namely, a historical method not carried beyond the citation of the works of the chief contributors to surviving doctrine) is the most natural for the mind of the student to follow, and gives him the truest appreciation of the present condition of knowledge on any topic, and of its probable future development; secondly, such a citation of the names of really surviving authorities—that is to say, of authors whose work is at this moment admitted as being the original and approved source of observational record, or theoretical conception still holding its ground—is, as a mere matter of bibliographical reference, of far more service to the student than an indiscriminate list of memoirs at the end of a chapter (such as Prof. Lang gives) without any indication of the contents of the memoirs named; thirdly, that such a citation is the bare justice to his predecessors and contemporaries which every teacher of zoology (or other advancing science) should feel bound to accord, and I should, I venture to say, gladly and scrupulously take trouble to ensure for those whose original work he has appropriated and accepted.

I confess that I feel sensible of something ungenerous and even unfair when I read the long and careful statements as to the skeletal and other systems of the Echinoderms (300 pages), illustrated by admirable copies of other naturalists' drawings, made in the present volume by Prof. Lang, without citing in his text a single name

of those to whom he and the world in general are indebted for all this knowledge. After all, it may well be questioned whether any man of science is justified in making statements, even in a text-book, as though he himself had investigated and was responsible for the accuracy of these statements in virtue of his own observations on the objects described, when all the time he is simply stating what this man and that man have seen, and he has not seen, though he omits to mention the name of any of those to whom he is indebted. When such a method is adopted, one is quite unable to distinguish the individual opinions of the author from the mass of second-hand information which he pours out. A very simple introduction of the phrases, "as was first shown by X," or "according to the observations of Y," or again, "an observation which I can confirm, as it has been called in question," would alter the whole significance of Prof. Lang's discourse, and make it not only much more valuable, but much more interesting. At the same time, let me hasten to say that every one will at once accept Prof. Lang's statement, that his object in ignoring the names of zoologists has been to secure brevity. My contention is that the end has not justified the means.

Take, for instance, the so-called "apical" nervous system of the Crinoids. The discovery of this remarkable and altogether improbable nervous system by that staunch and unwearied naturalist, Dr. W. B. Carpenter, in his old age, is one of the most delightful episodes in the history of comparative anatomy. He made the discovery after he was seventy years of age, and no one believed that his interpretation of his observations was correct when he first announced it. Old as he was, he lived to see his discovery confirmed and accepted on all sides. This extraordinary nervous system is described at some length, and explained by figures in Prof. Lang's book; yet the name of Dr. Carpenter is not once mentioned in connection with it, and the figures given (p. 966) are taken from and ascribed to Beyrich (!) and Carpenter's son Herbert, who merely worked out, long after his father's complete publication, some details of the old man's discovery. On the other hand, the mere accident that the cœca of the lantern-membrane, discovered by Prof. Charles Stewart in the Cidaridæ, have no special name, results in a recognition of his interesting discovery by the title of the "Stewartschen Organen."

The unsatisfactory character of Prof. Lang's method, if we regard his book as one for reference and assistance in tracing the more recent discoveries, is well exhibited in the section of little more than one page (pp. 1036, 1037) on the axial organ of Echinoderms (dorsal organ, heart, pseudo heart, renal organ, plastidogenous gland, ovoid gland, lymph gland). Here the space assigned by the author seems to be singularly out of proportion to that given to other topics, and we get not only the very scantiest description of the axial organ in Asterids, Ophiurids, Echinoids, and Crinoids, but no indication or reference *whatever* to ampler sources of information. Since this is really one of the critical subjects of recent investigation in Echinoderm anatomy, it is to be regretted that Prof. Lang says so little about it.

Whatever faults one may find with Prof. Lang's book, there is no doubt that it also has merits, and will be

found to contain a survey of Echinoderm morphology more extensive than that accorded to the morphology of other groups by the same author, as well as some useful original diagrams, such as that of Pentremites, on p. 968.

E. RAY LANKESTER.

### THE STUDY OF ROCKS.

*Lehrbuch der Petrographie.* Von Dr. Ferdinand Zirkel, Ord. Professor der Mineralogie und Geognosie an der Universität Leipzig. Zweite gänzlich neu verfasste Auflage. Three vols. 8vo. Pp. 2619. (Leipzig: Engelmann, 1893-94.)

THE appearance of a second edition of Prof. Zirkel's admirable "*Lehrbuch der Petrographie*" is an event of no little importance in the history of geological science. The part played by the author of this work in developing the methods of microscopic analysis, as applied to rocks, is too well known to require recapitulation in this place, and the long series of petrographical memoirs with which he has enriched geological literature—dealing with the rocks of the North American as well as with those of the European continent—are familiar to all students. While a great number of works treating of the microscopic study of rocks (including the author's own "*Die mikroskopische Beschaffenheit der Mineralien und Gesteine*") have appeared during the twenty-eight years which have elapsed since the first edition of the "*Petrographie*" was published, there is not one among them that quite occupies the place of that excellent treatise—with its wealth of information on the history and development of petrographical nomenclature.

The rapidity of growth of this branch of geological science during the past thirty years, is brought out in a very striking manner by a comparison of the first and second editions of this standard work. The first edition consisted of two thin volumes with an aggregate of 1241 pages; the second edition forms three bulky volumes with 2019 pages. But this is not all; it is evident to any one who peruses these volumes, that, in spite of the employment of more than double the number of enlarged pages, with much small type introduced, the author has found it impossible to discuss in all their aspects the views of previous authors with the completeness and comprehensiveness that were so remarkable in the first edition of the book. The student may be satisfied that Prof. Zirkel has overlooked little or nothing of importance in the literature of his subject; but, not infrequently, it will be noticed that in his attempt to deal as concisely as possible with this vast mass of literature, he has made statements with respect to the views of the authors quoted, which are—truly borne out by a reference to the memoirs themselves. While, therefore, this new edition will be invaluable in supplying ample references to petrographical literature, it will not in any way obviate the necessity of consulting the original memoirs.

As indicating the failure with which the subject is now treated, we may mention that the number of pages dealing with "*General Petrography*" has increased from 171 to 634. The account given of the optical properties of minerals and of the structure of rocks, as made out by the aid of the microscope, is naturally responsible for a large part of this increase; the description of the

common rock-forming minerals, which was comprised in forty pages in the first edition, now requiring no less than 291 pages. The greatest defect in this part of the work will be found in the absence of illustrations. Of this the author is fully sensible, as will be seen from a reference to his preface: but, as he justly pleads, the addition of illustrations could not fail to add to the bulk and cost of a book that has already grown to encyclopædic dimensions.

Every student of geology will naturally examine the work with the desire to learn what are the present views of so great an authority as Prof. Zirkel on the vexed subject of rock-classification and nomenclature. In the first edition of the book, our author, following the plan of most German writers upon the subject, attempted to class rocks according to their structure and mineralogical constitution, quite irrespectively of their origin, into simple crystalline rocks (ice, rock-salt, quartz-rock, limestone, &c.), compound crystalline rocks of granular and schistose character respectively, and elastic, or fragmental, rocks. In the second edition, he departs from this method, and commences the descriptive portion of the book with an account of the "*Massige eruptive Erstarrungsgesteine*," which occupies no less than 1292 pages. This is followed by an account of the "*Krystallinische Schiefer*" (275 pp.), the "*Krystallinische oder nicht-klastische Sedimentgesteine*" (230 pp.), and the "*Klastischen Gesteine*" (125 pp.). It will thus be seen that the primitive classification into crystalline (simple and compound) rocks and elastic rocks, has been abandoned for one in which account is taken of their mode of origin.

In dealing with the great class of igneous rocks, Prof. Zirkel has also introduced some modifications of his original method. In 1866, he grouped these rocks, according to the nature of the aluminous-alkaline silicate present in them, into Orthoclase-rocks, Oligoclase-rocks, Nepheline and Leucite-rocks, Labradorite-rocks, Anorthite-rocks, and rocks without feldspathic constituents. The obvious objections to this classification were: (1) That many rocks contain several distinct species of feldspar, notably in their porphyritic constituents, and in their groundmass respectively; and (2) that geologists possess no simple, infallible, and easily applied test for ascertaining the exact species of feldspars present in rocks. In 1873 (in his "*Mikroskopische Beschaffenheit der Mineralien und Gesteine*"), Prof. Zirkel abandoned this classification for the simpler division of feldspar-bearing rocks into Orthoclastic and Plagioclastic. This classification, which is facilitated by the general presence of twin striation as an easily recognised distinction of the plagioclases, has now been very generally adopted by petrographers. In the work before us, however, the author divides the feldspar-bearing igneous rocks into two series, distinguished by the predominance of an "alkali feldspar" or of a "soda-lime feldspar" respectively. It does not appear to us that anything is gained by this new departure, which will compensate for the admitted difficulty of applying the test for the discrimination of the two classes. Another change in classification which will interest English readers is that, while the separation of volcanic rocks into two series, the pre-tertiary (palæo-volcanic) and



post-tertiary (neo-volcanic) is maintained, the Plutonic rocks are admitted to be of all ages.

Geologists will, alas, look in vain in this work for any indication that they may hope for a speedy termination of the terrible confusion that has so long prevailed with respect to petrographical nomenclature. On the contrary, they will find that in addition to having to reckon with the schools of Paris and Heidelberg, as they have done in the past, they will now have to take account of a third—that of Leipzig! With some of Prof. Zirkel's criticisms of contemporary paleontological literature, English and American geologists will heartily sympathise. The employment of such terms as granitite, granophyre, &c., with significations different from those given to them by the authors of the names, cannot but lead to almost endless confusion, and we are glad to see that the authority of Prof. Zirkel is thrown into the scale against such principles of nomenclature being adopted; but in other cases we cannot but think that his objections to the nomenclature of other authors are not likely to be sustained by future workers in this branch of science.

Whether the confusion that now exists can be removed by any friendly discussion between the representatives of rival schools—such as those of the international committee proposed at the late Geological Congress at Zurich—time alone can show. If this be impossible, and writers in France and Germany, respectively, continue to ignore the terminology employed in other countries than their own, then it appears to us that, if science is to maintain her cosmopolitan character, only one method of escape is possible. We must follow the example of the other natural-history sciences in adopting the test of *priority* as absolute and final in our terminology of rocks. That many inconveniences must result from such a course may be readily admitted; and it will not be easy to fix upon the Linnaeus of our science—or to decide upon the date at which exact petrographical literature may be supposed to have commenced. But almost any trouble and difficulty of this kind is worth encountering, if we may hope that geologists in the future will, in speaking of rocks, attain that great desideratum of “one thing—one name.”

In the meanwhile, we are not ungrateful to the author of the work before us for the enormous labour and pains he has taken in wading through the great mass of petrographical literature; in furnishing us with correct statements concerning the origin and history of terms; and in placing on record the decisions he has arrived at upon many of the difficult problems that confront us. The “Lehrbuch der Petrographie” has always been a standard work of reference; and, in its new form, it has become more indispensable than ever. J. W. J.

OUR BOOK SHELF.

*Pithecanthropus Erectus, eine Menschenähnliche Uebergangsform aus Java.* By E. Dubois. 4to, pp. 40, illustrated (Batavia, 1894.)

JAVA, from its geographical situation, being just one of those countries where the remains of a connecting form between man and the higher apes would be extremely likely to occur, zoologists have naturally been attracted by the title of the work before us, which proclaims in no

uncertain tones that such a missing link has actually been discovered. A feeling of disappointment will, however, probably come over the student, when he finds how imperfect are the remains on the evidence of which this startling announcement is made; and when he has submitted them to a critical examination, he will probably have little difficulty in concluding that they do not belong to a wild animal at all. The specimens described are three in number, and were discovered in strata of presumed Pleistocene age near a spot called Trinil. The first of these is a last upper molar tooth, found during the drying-up of a river-bed in the autumn of 1891. A month later, the roof of a large cranium was discovered in the same bed, at a distance of only about a yard from the spot where the tooth laid. Finally, in August 1892, at a distance of some sixteen yards higher up the stream, a left femur was disinterred, which is stated to present much more human resemblances than either of the other two specimens. The bed from which this bone was derived is stated to have been the same as that from which the other two specimens were obtained. The author is confident that all are referable to a single animal; and we are content to accept this view.

Especial stress is laid on the femur as indicative of human affinities; and here again we are in agreement with the author, only we would go one step further, and say that it actually is human. As is pointed out in the text, this bone has a large exostosis below the lesser trochanter; and we believe that such slight differences as it shows from normal human femora, are due to this diseased condition. With regard to the skull, which shows a marked human facies, but an extremely small development of the brain-cavity, the absence of ridges on the calvarium clearly shows that it can belong to no wild anthropoid; and there appears every reason to regard it as that of a microcephalous idiot, of an unusually elongated type. The molar, so far as we can see from the figure, may likewise perfectly well be human.

Haeckel's "*Pithecanthropus*" may, therefore, be relegated to the position of an hypothetical unknown creature for which it was originally proposed; while the specific name "*erectus*" must become a synonym of the frequently misapplied "*sapiens*." R. L.

*The Planet Earth. An Astronomical Introduction to Geography.* By R. A. Gregory, F.R.A.S. (London: Macmillan and Co., 1894.)

It is, perhaps, one of the consequences of the antiquity of astronomy that it is not now usually presented to the youthful mind in a thoroughly scientific manner. The established truths of the science, in so far as they concern the earth's place as a planet, though once so astounding to mankind, are now so commonplace that the educational advantages of a study of the phenomena which brought them to light are frequently overlooked altogether. As in the case of geography, information rather than education appears to be the principal aim of astronomical teaching when it is not carried beyond the elementary stage which it reaches in schools; although, when properly handled, there is no subject better calculated to lead the mind into a scientific groove.

We therefore cordially welcome this attempt to indicate the lines which should be followed for a profitable study of that portion of astronomy which deals with the earth as a planet. The bald statements as to the earth's dimensions and movements, so frequently appearing in the text-books of geography, furnish the sole astronomical knowledge which many acquire; but they are, as Mr Gregory remarks, quite inadequate. The design of the little book before us, is first to direct the students' attention to observations which they may generally make for themselves, and then to show how such phenomena can be accounted for. Thus,

In the first chapter, a concise account is given of the means of finding and identifying stars, sufficient to make possible an intelligent observation of the diurnal motion of the celestial sphere; and in the next chapter, it is shown that the observations can be explained by regarding the earth as a spinning globe. The same method is followed throughout.

On the whole, the subject-matter has been judiciously selected, but a slight want of proportion is shown in introducing explanations of the phases of Mercury and Venus, while those of the moon are not referred to at all. The chapter on the determination of the size of the earth would have been a little more educational if the description of the methods employed had been accompanied by hints as to the amount of playground surveying which is possible by the use of a protractor and foot-rule.

The book forms an admirable introduction to astronomy, which stands a fair chance of fulfilling the author's hope "that this little book will help to revive the observational astronomy of pre-telescopic times." This branch of astronomical knowledge is certainly not without danger of being neglected in favour of the fascinating and rapidly-advancing study of the results obtained by the use of the camera and spectroscope. The explanations are models of clearness and accuracy, and the diagrams illustrating them are excellent. Many of them are new, and involve original ideas of the author; as, for instance, a diagram illustrating the sun's apparent path in winter and summer, and another showing the principle of Foucault's pendulum by a lecture experiment. Teachers of geography and physiography will do well to make themselves familiar with Mr. Gregory's methods.

### LETTERS TO THE EDITOR.

[The Editor does not hold himself responsible for opinions expressed by his correspondents. Neither can he undertake to return, or to correspond with the writers of, rejected manuscripts intended for this or any other part of NATURE. No notice is taken of anonymous communications.]

#### The Hodgkins Prizes.

THE time for the reception of treatises or essays offered in competition for the Hodgkins Fund Prizes of 10,000 dols., of 2000 dols., and of 1000 dols., respectively, closed on December 31, 1894, and all papers so offered are now in the hands of the Committee of Award.

In view of the very large number of competitors, of the delay which will be necessarily caused by the intended careful examination, and of the further time which may be required to constitute a European Advisory Committee, if one be appointed, it is announced that authors are now at liberty to publish these treatises or essays without prejudice to their interest as competitors.

S. P. LANGLEY.

Washington, January 10.

#### The Artificial Spectrum Top.

AT the present time is exciting a good deal of interest at the present moment, perhaps I may be allowed to record some experiments which I have made with a view of arriving at a solution of the colour problem which it sets. I have observed the colours produced by the white light of the positive pole of the electric arc, and also by monochromatic light produced by means of my colour comparison. The top was rotated on a horizontal axis at any desired speed by means of an electromotor. The following colours were observed (No. 1, No. 2, No. 3, and No. 4 are the triple lines in order from the centre of rotation):

#### White light.

- No. 1. Crimson.
- No. 2. Olive green.
- No. 3. Grey (lightly violet).
- No. 4. Dark violet.

(When the yellow light of gas is used, the above results would be modified.)

NO. 1317, VOL. 51.]

#### Red (Magnesium).

- No. 1. Red.
- No. 2. Lighter red.
- No. 3. Very light olive green.
- No. 4. Darker olive green.

#### Green (Magnesium).

- No. 1. Bluish-green.
- No. 2. Lighter bluish-green.
- No. 3. Same as No. 2.
- No. 4. Ruddy black.

#### Blue (near $\lambda$ of the lithium).

- No. 1. Grass green.
- No. 2. Lighter grass green.
- No. 3. Same as No. 2.
- No. 4. Ruddy black.

#### Violet (all the violet of the spectrum).

- No. 1, 2, and 3. Light violet.
- No. 4. Darker violet with a suspicion of red.

When a red a little below the red lithium line was employed, all the groups appeared dark red, and as in the sensation theory this part and the violet are simple sensations, the results obtained in these fast, were to be expected.

The next two series are interesting, observations being made in white light compounded by the mixture of two simple colours.

#### Mixture of red and green to make white.

- No. 1. Indigo-blue.
- No. 2. Reddish orange.
- No. 3. Same as No. 2.
- No. 4. Darker orange.

#### Mixture of yellow and blue to make white.

- No. 1. Sky blue.
- No. 2. Sage green.
- No. 3. Same as No. 2.
- No. 4. Bluish-black (perhaps black).

These results were confirmed by an independent observer. When the rotation was reversed the same order of colours was observed, but in the reversed order. These observations seem to confirm the original opinion I had formed regarding these phenomena.

Bearing in mind that none of the observed colours in the lines are pure colours, but mixed with a certain quantity of white, and are seen on a more or less dark ground, then if the order of persistency of the three colour sensations be violet (blue), green, red, the results would be as given above. Should this be so, the velocity of rotation must alter the position of the colours seen in white light, the violet being the last to be seen on No. 1 when rotated more rapidly, and this is the case. The effect of contrast also has to be taken into account.

I have made a good many more experiments under varying conditions of position and dimensions of lines and proportions of black to white; and it seems possible that this toy, when modified, may be adapted to give valuable information as regards certain problems in colour vision.

W. DE W. ABNEY.

WE have recently made a few experiments bearing on the phenomena exhibited by Mr. C. E. Benham's artificial spectrum top (see NATURE, November 29, 1894, p. 113), and the explanation of them suggested by Prof. Living (NATURE, December 13, 1894, p. 167), and have obtained results which we believe to be novel and of some scientific interest.

In the first place, if Prof. Living's explanation be correct, there seems to be no reason why the same effects should not be obtained with broad bands instead of lines, the bands being drawn in precisely the same manner as the lines upon the white half of the disc.

It appeared to us of some importance to determine if this were really the case, as we thought the effects obtained with Mr. Benham's top might possibly be due to irradiation being different in amount for the different colours, while the change in colour with reversion in direction of rotation was presumably due to the black lines succeeding, upon a given part of the retina, a previously white ground in the one case and a previously black one in the other.

If this were so, by using broad bands instead of lines, one would expect to get a coloured line at each border, while the central portion remained uncoloured. Prof. Living's theory would lead one to expect a uniformly coloured band.

Accordingly, we prepared a disc, one half of which was blackened and the other half left white, as in Mr. Benham's top, and on the white half were described three black circular bands about one centimetre broad, with radii of about 4.7 and 10 centimetres respectively, and each with an arc of 45°. The outer band was described in an opposite sense to the two inner bands, that is to say, in such a manner that if the disc was rotating so that the order of succession for the two inner bands was black field, bands, white field, for the outer band it was white, bands, black. The disc was rotated by attaching it to the spindle of an electromotor, the speed of which could be graduated by friction against the spindle.

On rotating the disc at a slow speed, in such a direction that the order of succession for the two inner bands was black, bands, white, the following results were obtained:—The two inner bands were each bounded on both inner and outer edges by a bright red line, fading off towards the centre in a dark, somewhat reddish, ground, which became less coloured and darker as it approached the centre. The outer band presented a marked contrast to these two; the whole extent of the band itself was black, entirely free from colour, but on the white ground on both borders of the band, and apparently outside it, there appeared a brilliant coloured band, varying in colour from blue to green. On reversing the direction of rotation, the appearances were exactly reversed; the inner bands now became black bordered by green, and the outer band reddish black lined by bright red.

We do not contend that this experiment proves that the effect is one of irradiation, for it might easily be supposed that the heightened effect at the border is one of contrast with the surrounding whiter coloured field. Our next experiment, on the effect of change in the speed of rotation, also tends to negative the idea that the colours are due to irradiation, as there is no reason to think that if irradiation were the cause, there would be a change in colour with a change in the speed of rotation, as was found to be the case.

To test the effect of change in the speed of rotation, a disc of one of Mr. Benham's tops was detached, fixed to the spindle of the electromotor, and rotated in such a direction as to cause the three central bands to appear red with a slow speed of rotation. On gradually increasing the speed, a remarkable series of changes in appearance presented itself. The bright blood-red of the three inner lines gradually grew darker and duller, and then passing rapidly through a transition, the shades of which we were unable to observe, gave place to a most vivid green, which in turn, with still increasing speed, passed through another transition stage into blue, deepening into a full violet at the greatest speed we could obtain. On causing the motor to slow down, the same changes in an inverse order from violet to red were observed. These changes in colour *with the same direction of rotation* are very remarkable, and seem to us to be in direct opposition to Mr. Benham's explanation supplied with the top; for if the colours are due to a certain percentage of the etherial vibrations being cut off, this percentage will remain the same for all speeds, and there is no reason apparent why there should be a change in colour with difference in speed. Neither are they easily explainable on Prof. Living's theory that red is the first colour to appear, and blue the last to disappear; also, the green we got at the intermediate rate was certainly not a neutral grey or green, but a pure vivid green. Probably other observers have not used a greater speed than that of the first transition stage from red to green, which has a kind of neutral green tint.

An experiment was next made with a disc constructed similarly to that of Mr. Benham, but having white lines drawn on the black semicircle instead of black lines on the white part. On rotating this disc so that *white* lines on *black* ground succeeded the black surface, with slow rotation the colour obtained was red, but a different kind of red to the deep blood-red given by Mr. Benham's top in the case of *black* lines on a *white* ground also following a black surface, *viz.* a very bright red, evidently not saturated. With higher speeds there followed a light green and light blue, both evidently containing white. The difference in hue of the two series of colours seems obviously that in the case of the white-lined disc the colours are mixed with white, and in that of the black-lined are mixed with black.

Throughout the series of experiments we have tried to eliminate

psychical errors as much as possible, by experimenting on persons unacquainted with the expected results.

Belfast, January 15. J. M. FINNEGAN.  
B. MOORE.

The Kinetic Theory of Gases.

THE difficulty of reconciling line spectra with the kinetic theory of gases, has been referred to by Prof. Fitzgerald (NATURE, January 3, p. 221). The following considerations show that it is possible under certain suppositions to have a number of spectral rays with a very restricted number of degrees of freedom. Most of us, I believe, now accept a definite atomic charge of electricity, and if each charge is imagined to be capable of moving along the surface of an atom, it would represent two degrees of freedom. If a molecule is capable of sending out a homogeneous vibration, it means that there must be a definite position of equilibrium of the "electron." If there are several such positions, the vibrations may take place in several periods. Any one molecule may perform for a certain time a simple periodic oscillation about one position of equilibrium, and owing to some impact the electron may be knocked over into a new position. The vibrations under these circumstances would not be quite homogeneous, but if the electron oscillates about any one position sufficiently long to perform a few thousand oscillations, we should hardly notice the want of homogeneity. Each electron at a given time would only send out vibrations which in our instruments would appear as homogeneous. Each molecule could thus successively give rise to a number of spectral rays, and at any one time the electron in the different molecules would, by the laws of probability, be distributed over all possible positions of equilibrium, so that we should always see all the vibrations which any one molecule of the gas is capable of sending out. The probability of an electron oscillating about one of its positions of equilibrium need not be the same in all cases. Hence a line may be weak not because the vibration has a smaller amplitude, but because fewer molecules give rise to it. The fact that the vibrations of a gas are not quite homogeneous, is borne out by experiment. If impacts become more frequent by increased pressure, we should expect from the above views that the time during which an electron performs a certain oscillation is shortened; hence the line should widen, which is the case. I have spoken, for the sake of simplicity, as if an electron vibrating about one position of equilibrium could only do so in one period. If the forces called into play, by a displacement, depend on the direction of the displacement, there would be two possible frequencies. If the surface is nearly symmetrical, we should have double lines.

The only weight I attach to these speculations lies in the illustration it affords that a number of spectral lines does not necessarily mean an equal number of degrees of freedom. In the existence of the "electron" I firmly believe; and this necessarily implies a very restricted number of variables

ARTHUR SCHUSTER.

"Acquired Characters."

IT would appear that Prof. Lankester has not thought it worth while to read all the letters that have appeared in NATURE on the question raised by Sir Edward Fry, unless it is to be inferred from his remarks that he confines himself to the consideration of the arguments of those who have a place on the scientific Olympus of the Royal Society. In my letter, published December 6, I defended Lamarck's laws against the accusation that they were reciprocally destructive. Prof. Lankester reiterates his accusation without any further support. But this is not the whole question. In his last letter he suggests that acquired characters corresponding to Mr. Galton's definition should be taken, and an investigation made as to whether they are inherited or not in later generations. But in his former letter (November 29) he suggested very distinctly and deliberately that such an investigation was unnecessary, because the question was already settled. He has already condemned the heretic, and now consents to his trial. His words were—"Since the old character had not become fixed and congenital after many thousands of successive generations of individuals had developed it in response to environment, but gave place to a new character when new conditions operated on an individual, why should we suppose that the new character is likely to become fixed after a much shorter time of responsive existence?" To apply this

once more to the case of pigment in relation to light. For thousands of generations no pigment has been developed, say, on the lower side of a flat fish, no light having fallen on it. The skin is experimentally exposed to light, and pigment appears; therefore the acquired character of a sense of pigment, after thousands of generations, has produced no hereditary change, has not altered the potentialities of the tissue. The argument is fallacious, because the question of how much pigment is entirely ignored, and also the question how long the development of pigment experimentally takes. The force of the argument is entirely on the other side. Assume in this case, as Prof. Lankester does in his general argument, that the old character, the absence of pigment, is an acquired character. Then experiment has shown that this character is inherited: that is to say, the action of light obviously overcomes a resistance in producing pigment, and after years does not produce as much as on the upper side is present from the beginning. This resistance can be nothing else than heredity, the inheritance of a tendency to pigmentlessness. Therefore the acquired character is inherited. It is unalienable and indisputable that the argument propounded by Prof. Lankester proves the inheritance of acquired characters, if it is properly applied in accordance with the facts. This is on the assumption that the "old characters" are acquired. If they are not acquired, the argument has no force at all. The facts allow us to say that the tendency to pigmentlessness, or the resistance to the development of pigment on the lower side of a flounder, is certainly inherited, but whether or not it is due to the absence of light during many successive generations we do not know. As Sir Edward Fry says, if we by definition confine the term "acquired character" within the limits of an individual history, then of course an acquired character can never be inherited. The question is whether the conditions which produce a change in the individual can affect the offspring? The experimental investigation must take the following course. Suppose a given amount of stimulation X to act upon individuals in successive generations, producing in the first generation a result *a*. Then the question is if X remains the same, does *a* remain constant or not? If there is no inherited effect, then *a* must remain constant in all succeeding generations. If *a* increases by some amount, however small, and becomes *a*+*a*, then *a* is not acquired by the individual, but inherited, and it is clear that the result will go on increasing to *a*+2*a*, *a*+3*a*, and so on to *a*+*n**a*, where *n* represents the number of generations. In my own opinion, there is evidence that something of this kind does occur, though definite investigations are much to be desired.

Plymouth, January 11. J. T. CUNNINGHAM.

A one who has been reading the discussion in your pages on the meaning of the term "acquired characters," I may perhaps be permitted to direct attention to the history of the term. It was first used with reference not to species but to individuals. Every character of an individual is either derived from the fertilised ovum or acquired during life. This was obvious, and the question arose: could acquired characters be transmitted? As long as the term is applied to an individual, it has that kind of precision which is desirable in all scientific terminology, namely, that it perfectly explains itself.

JOHN CLIFLAND.

Chinese Theories of the Origin of Amber.

In my letter on "Some Oriental Beliefs about Bees and Wasps" (NATURE, vol. I, p. 39, May 10, 1894), I have traced the origin of the Chinese belief in the production of amber from bees into the presence in amber of hymenopterous remains. Apparently developed from this belief, there is another misconception recorded by Li Hsi, killed 399 A.D., whose passage on the subject reads: "In 'Ssu-chen-chin' it is said, the remains of bees, flies, and other insects, after remaining underground for one hundred years, are turned into *Pi* (*pien*)" (Fenching), which is truly not amber. Notwithstanding this statement, the Chinese have produced *Pachyma*, but no amber; whereas Ying and others have produced amber, but no *Pachyma*. Another theory of the origin of amber is by burning honey-combs. Which is true of the two theories is not yet decided.

Of all Chinese theories propounded, the most plausible for the origin

1. Hsiang-shan, De K. I. N. S. (1610), p. 100, vol. 10, p. 100.

of amber, the most veracious one is given in Li Shi-Chin's work,<sup>3</sup> thus: "Amber originates in the resin of pines; when the pines, with their branches and knots luxuriantly growing, were heated by the sun, the resin came out of the wood; it coagulated after days and sunk underground, and after undergoing subterranean changes, left behind the lustrous substance [which is amber]. In this condition still it has in it the tenacity of resin, so that when it is rubbed and warmed between the palms, it can pick up particles of dust. Those insects in its enclosure had cohered with it before its sinking underground."

Besides the resin of pines, the exudation from the "Fung" (*Liquidambar Maximowiczii*) is asserted by Kan Pao-Shing (lived in the tenth century A.D.) to be a nascent form of amber,<sup>4</sup> the opinion well coinciding with the Western idea that has given to styrax the name "Liquidambar."

In "Shi shwoh" (written in the fifth century A.D.) amber is said to be formed from the subterranean metamorphosis of the gum of peach trees,<sup>5</sup> which reminds us of the simile, "Like gum from the cherry," used by Pliny in his exposition of the resinous origin of amber.<sup>6</sup>

Some other theories are full of absurdity. One of these holds that the dragon's blood buried underground turns to amber, and the demon's to agate.<sup>7</sup> Also, the etymological origin of "Hu peh," the Chinese name for amber, is involved in myth. In ancient times this word was written in two letters, together signifying "Tiger's Soul," which is explained in this way: "At night the tiger applies its one eye for illumination, and another for vision. When it is shot with arrow the light of the eye, which is the tiger's soul, sinks underground, and turns into a white stone. . . . Amber resembles this stone; hence the name."<sup>8</sup>

According to "Hwai-nan-tze" (written in the second century B.C.), "the dodder is the outgrowth of amber."<sup>9</sup> Almost inexplicable as this story may appear, I have found certain clues to its elucidation. Kai Yu (lived in the second century A.D.) gives "Nuo-lo" (i.e. *Usnea longissima*)<sup>10</sup> as a synonym of "Tusze" (i.e. the dodder).<sup>11</sup> From this it is evident that the early Chinese have confounded *Usnea* with dodder—the confusion caused by the superficial resemblance and similar habitats of the two plants.<sup>12</sup> Now, there is a Chinese belief recorded about 240 B.C., that *Zu* (*Zu* *caecis* is the root of dodder,<sup>13</sup> which has doubtless grown out of the common occurrence upon and under the pines of the *Usnea* and *Pachyma*. And as this *Pachyma* had been held as an intermediary phase through which resins were to pass into amber (see above), it would seem that the story which affirms the dodder to be the outgrowth of amber, was not inconsistent with the understanding of the early Chinese theorists.

KUMAGASU MINAKATA.

January 11.

Rhynchodemus Terrestris in Germany.

IN NATURE of October 25, 1894 (p. 617), Mr. Scharff mentioned *Rhynchodemus terrestris*, as stated, in Germany, near Würzburg, by Semper. It would seem that the worm was exceedingly rare. But I found it repeatedly at several points of Saxony and Thuringia, in the mountains and in the plain, in leaved and fir wood, under moss or dead leaves. Sufficient attention would detect it without doubt in many regions. Recently Mr. Ehrmann found several specimens feeding on a dead *Artemisia vulgaris*.

H. SEMPER.

Leipzig.

The "Proceedings of the Chemical Society."

THE title-page and index of this periodical have just come to hand, and on the title-page occur the words, "Edited by the Secretaries." It appears to me right that authors should know

<sup>3</sup> "Pai-nan-king-muh," 177, art. "Hu peh."

<sup>4</sup> Ibid., p. 177.

<sup>5</sup> "Encyclopedia of Plants," 15, p. 72.

<sup>6</sup> "Ewin-Cong-Shih," "Wai-yang," 181, 182, 183, 184.

<sup>7</sup> "Natural History," English translation, Peking Edition, vol. vi, p. 109.

<sup>8</sup> "Ewin-Cong-Shih," 177.

<sup>9</sup> "Pai-nan-king-muh," 177, art. "Hu peh."

<sup>10</sup> "Ewin-Cong-Shih," 177.

<sup>11</sup> "Encyclopedia of Plants," Dr. M. Miyashita's article on the *Schizanthus* type.

<sup>12</sup> "Natural History," Tokyo Edition, 1894, p. 109.

<sup>13</sup> "Natural History," Tokyo edition, A.D., 1894, p. 109. Kan Yu's

theory has appeared to have well distinguished the two plants. The

word "Nuo-lo" is given up on the dodder and the dodder upon trees." "Pai-

nan-king-muh," 177, art. "Hu peh."

The precise significance of these words, as lately determined by the Council of the Society.

Two courses appeared to be open: either to submit proofs to the authors of the abstracts of their papers sent to the Society, if any substantial (*i.e.* more than typographical) alteration had been made; in which case, the authors themselves would naturally bear the responsibility of their statements; or to throw the whole responsibility on the Editors, leaving them to make any excisions or alterations they may choose in the abstracts sent to them; or indeed, if they so think fit, entirely to rewrite them. The Council, in order to secure rapid publication, have chosen the latter alternative; and it should be understood that the abstracts are now "official"—*i.e.* the responsibility for all statements put forth rests solely on the Editors of the *Proceedings*.

WILLIAM RAMSAY.

University College, London, W.C., January 14.

Philosophy and Natural Science.

WHILST feeling obliged to your reviewer's appreciation of my essay (p. 220), I am bound to rectify some very glaring discrepancies.

(1) As plainly stated in my preface, my essay has *not* obtained the Philosophical Society's prize, but only an "honourable recognition," and two fifths of the prize sum.

(2) Eighth line from bottom (p. 220), for "physical," read "*psychical*," as said in my paper (p. 30).

(3) Your reviewer makes me say: "Physical development is not the cause, but the effect of psychical development"; whereas, I have expressly *combated* this view of Wundt's (p. 32).

(4) Neither did I say: "The modifications in the brain and nervous system throughout the animal kingdom are intelligible as resulting from psychical causes . . ." but only (p. 32) that *in many cases* the beginnings of modifications are intelligible from the psychical side—*e.g.* the modifications of many organs—resulting from sexual selection.

(5) Lastly, far from saying that the high mental position of man, on the one hand, and of ants on the other, "is independent of the structure of the nervous system," my sentence (p. 34) is: "Here, where the organic substratum (*i.e.* the brain) in both types differs even in its principal morphological features, it is most evident how occult are the processes which constitute the proper material side of psychical phenomena."

Freiburg, Badenia, January 5. DAVID WETTERHAN.

(1) THE facts are that the Philosophical Society of Berlin offered a prize of 1000 marks for an essay on "The relation of philosophy to the empirical knowledge of nature."

The essay reviewed, only obtained 400 marks of this prize, and an honourable mention. In a hasty glance at the preface I overlooked the words "ein Antheil von vierhundert Mark," which occur in the next line to "der als Preis ausgesetzten Summe," which caught my eye.

(2) This is evidently a slip of the pen, which I regret was overlooked in proof.

(3) In my notes, jotted down as I read the pamphlet, I put Wundt's words in quotation marks, intending to point out Mr. Wetterhan's opposition thereto; but in writing the review, I unfortunately omitted the commas, and, I regret, entirely misrepresented the author's views. Perhaps I may quote from p. 32 of the pamphlet: "Man durfte Wundt's Satz, 'dass die physische Entwicklung nicht die Ursache, sondern vielmehr die Wirkung der psychischen Entwicklung ist,' zu weitgehend, und auch in seinen Konsequenzen bedencklich finden." We are then referred to page 46, where we read: "Der Ausföhrung dagegen, welche Wundt (s.o. p. 32) jenem Prinzipie gegeben hat, vermag ich kaum eher beizustimmen, als der verwandten Ideen Schopenhauer's."

(4) It appears to me that the passage will bear the construction which I put upon it; though perhaps "throughout" the animal series is too inclusive as a rendering of "der Tierreihen."

(5) The author had been discussing the similarity of habits and instincts in ants and termites, and then remarks that there is a distinct agreement in the mental functions ("von geistigen, ja gemüthlichen Funktionen") of bees with those of the higher

animals. He refers to Darwin's opinion that the small brain of a bee is a more wonderful thing than the brain of a Man; and I think I was entitled to make the obviously true remark that this "mental development is independent of the structure of the nervous system." I was not quoting Mr. Wetterhan's words, but giving the general sense of the passage.

In conclusion, I must express my regret that the condensation of some of the author's remarks should have resulted in a confused expression of his views.

THE REVIEWER.

SOME EARLY TERRESTRIAL MAGNETIC DISCOVERIES PERTAINING TO ENGLAND.

IT should be a source of considerable pride to British men of science that so many of the discoveries in terrestrial magnetism have been made in England. And yet, owing to the absence of a complete and carefully written history of the development of this science, probably few could enumerate all the achievements in this subject by Englishmen.

In February 1893 the writer had the good fortune to light upon a book,<sup>1</sup> by Will Whiston, containing matter pertaining to the terrestrial magnetism of England, which appears to have been entirely overlooked by prominent terrestrial magneticians. Owing to pressure of work, this interesting book, of which a copy was found in the Royal Library of Berlin, could not be subjected to a critical examination until the early part of 1894, when the writer called the attention of prominent Berlin investigators, such as Prof. Hellmann and Dr. Eschenhagen, to it.<sup>2</sup> In the meantime, Dr. W. Felgentraeger, Assistant at the Göttingen Magnetic Observatory, made an independent discovery of Whiston's book, and carefully worked up part of the material contained therein.<sup>3</sup> The writer has since found time to complete his examination of Whiston's contribution, and has embodied his results in a paper<sup>4</sup> presented by Prof. Cleveland Abbe before the Philosophical Society of Washington on November 10, 1894. In the following these results will be briefly sketched.

As will appear from the title of Whiston's work, the chief object was the exposition of a method for determining the longitude and latitude by means of the magnetic dip-needle, *i.e.* by means of the angle which a magnetic needle mounted on a horizontal axis, when placed in the vertical plane of passing through the magnetic meridian, makes with the plane of the horizon. It will be recalled that at that time great prizes had been offered by the English Parliament for an easy and trustworthy method of determining longitude at sea. From the very birth of terrestrial magnetism we find methods proposed for determining longitude by means of magnetic observations, and, like the problem of perpetual motion, these magnetic methods were revived every once in a while until the beginning of the nineteenth century. Owing to the irregular distribution of magnetism within the earth's surface, and on account of the many fluctuations terrestrial magnetism is subject to, these magnetic attempts to determine geographical position have been doomed to failure. They, nevertheless, have done much to promote the science of terrestrial magnetism. A striking instance of this is the book of Whiston's. The prime object of the book has failed of

<sup>1</sup> "The Longitude and Latitude found by the Inclinary or Dipping Needle; wherein the Laws of Magnetism are also discover'd. To which is prefix'd an Historical Preface; and to which is subjoin'd Mr. Robert Norman's New Attractive, or Account of the first Invention of the Dipping Needle." By Will Whiston, M.A., sometime Professor of Mathematics in the University of Cambridge. (London, 1721.) 8vo, xxviii. 175, iv. and 134 p. 2 charts and 2 cuts.

<sup>2</sup> See remarks in *Physical Review*, vol. ii, No. 1, p. 72.  
<sup>3</sup> "Die Isoklinen-Karte von Whiston und die sekundäre Aenderung der magnetischen Inklination im östlichen England." Von W. Felgentraeger. Report from *Nachrichten der K. Gesell. der Wiss. zu Göttingen Math. Phys. Klasse*, 1894, No. 2, 8vo, 22 pp.

<sup>4</sup> Entitled "The Earliest Inclines and Observations of Magnetic Force." (*Bull. Phil. Soc., Wash.*, vol. xii, pp. 327-41.)

its purpose, yet the incidental discoveries, the importance of which the author himself did not fully appreciate, may perpetuate the name of Whiston for ever. It is most remarkable that his contributions have been, apparently, entirely overlooked.

Whiston, who, as stated in the title of his book, was at one time Professor of Mathematics at Cambridge, being Sir Isaac Newton's successor, was banished not long after assuming the chair, on account of heresy—he was a Unitarian. He was led to pursue the longitude problem magnetically through Halley's famous Isogonic Chart of 1700,<sup>6</sup> which came under his notice. As is well known, this chart of Halley's, giving the lines of equal magnetic declination, *i.e.*, these lines on the earth's surface connecting all the places at which a magnetic needle swung horizontally has the same bearing, is the earliest published chart of its kind. In consequence, these lines have likewise been termed the "Halleyan Lines." Since then Halley's method has been effectually applied to the representation of other terrestrial phenomena, *e.g.*, distribution of temperature ("Humboldt's Isotherms," 1817). Wilcke is credited as first applying Halley's method to the representation of the distribution of the magnetic *inclination*, and Wilcke's isoclinics are therefore referred to occasionally as the "Wilckean Lines." Wilcke published his chart, covering the greater portion of the earth, in 1768.<sup>7</sup> It appears, however, that the credit of first drawing the isoclinics should be accorded to Whiston. Wilcke nowhere states in the article cited that he for the first time has drawn the lines of equal magnetic inclination, and it is, moreover, reasonable to suppose, by his reference to Whiston's book, that he was familiar with its contents.

Whiston was led to drawing the isoclinics upon finding that the "Halleyan Lines," through "the Quickness of the Mutation of those Lines and their different Position in the rest of the World," could not be satisfactorily used for the determination of longitude. He therefore began to consider the "lines of equal dip," thinking they would answer his purpose better. To this end he collected all observations of dip made up to his time, and with their assistance drew, as far as then possible, the "lines of equal dip" upon Mr. Molyneux's terrestrial globe. Furthermore, to practically test his method, he made dip observations himself in 1719 and 1720 in various portions of England, and with their aid drew and published the *first isoclinics*, to be sure for only a small portion of the earth, *viz.* for southern England and north-western France. These isoclinics were laid down on two small charts (114 × 182 cm.), and are given opposite p. xxviii. of his book. The first chart is the result of dip observations made in 1719 with a needle 12 inches long; the second<sup>8</sup> is based upon more numerous observations made in 1720 with a 47½-inch needle. The result, with the two needles differ, on the average, by about 1°, the long needle giving the larger value. To counteract the error due to flexure of the long needle, Whiston placed a small "Pole of brass circular Wire," which required shifting to and fro according to dip, on the north end of the needle. Whiston believed that the longer the needle, the better the result if the needle be poised as stated. It is needless to say that experience has not borne him out in this respect. Owing

to the large discrepancy between the results of the two needles, it might appear, then, that but little value can be attached to these Whistonian isoclinics. The writer finds, however, in his paper that the mean of the two results can doubtless be accepted as being within 1° of the truth. Moreover, while the *absolute* value may be impaired to the extent mentioned, the *relative* value remains intact, as the effect of the constant instrumental error would be almost entirely eliminated when considering the *relative* distribution of the dip over England. It is this latter fact that may give a value to these early isoclinics. Thus in 1720, according to Whiston, the isoclinics over England ran approximately from west-north-west to east-south-east, while to-day they go roughly from west-south-west to east-north-east. In the accompanying sketch, the mean isoclinics are shown by full lines for the epochs 1720, 1837, 1860, and 1886, as drawn by Dr. Felgentraeger in the paper cited.<sup>3</sup> It will be seen that between 1720 to about 1837 they shifted from year to year, *anti-clockwise*; they are now moving *clockwise*. Sabine,<sup>10</sup> I believe, was the first to call attention to this reversal of motion. It is hoped that this matter will receive further investigation.

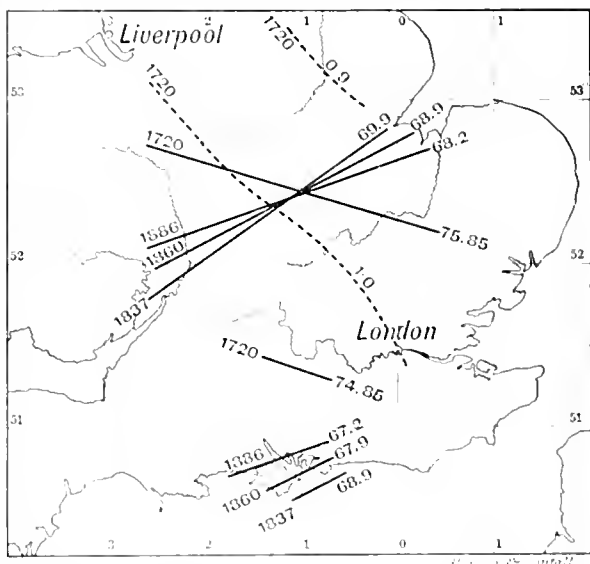

Whiston comes in, however, for a still greater share in the early terrestrial magnetic discoveries. He invents, namely, a new and indirect method of determining the dip the vibration method. He swings a magnetic needle horizontally, and determines the time of one horizontal vibration. He then swings the *same* needle mounted as a dip-needle, and again determines the time of one vibration. From the two times of vibration it is a simple matter to compute the prevailing dip. Whiston proposes this method as an approximate check upon the direct method where the angle of dip is measured at once. For example, Whiston found at London the time of one horizontal vibration of his long needle 120 from the magnetic meridian to be 60½ seconds, which reduced to the magnetic meridian gives 126 seconds. The time of one vibration of the same needle, mounted as dip needle, was found to be 22 seconds. If F is the total magnetic force, we then have the following relation:

$$F : F \cos \text{Dip} :: (126) : (22), \text{ or Dip } = 74 \frac{1}{2}^\circ.$$

Now, the mean of the results of the direct measurements with the 12-inch needle (73½°), and of the 47½-inch

<sup>10</sup> Sabine, *Ann. Mag. Nat. Hist.*, vol. xvi, p. 111: "The angle of intersection of the meridian and isocline has been diminishing up to about 1749, when a reversal took place, and the angle is now increasing."

<sup>6</sup> Whiston, *Method of Determining Longitude by the Variation of Whiston's Dip*, p. 10. <sup>7</sup> Wilcke, *Method of Determining Longitude by the Variation of Whiston's Dip*, p. 10. <sup>8</sup> Whiston, *Method of Determining Longitude by the Variation of Whiston's Dip*, p. 10. <sup>9</sup> Whiston, *Method of Determining Longitude by the Variation of Whiston's Dip*, p. 10. <sup>10</sup> Whiston, *Method of Determining Longitude by the Variation of Whiston's Dip*, p. 10.

needle ( $75\frac{1}{2}^\circ$ ), is  $74^\circ 28'$ . Hence the agreement is quite satisfactory. We can probably say that the magnetic dip in London in 1720 was  $74.5 \pm 0.5$ .

The invention of this new method of determining dip, led to still more important results. In making the dip observations with the long needle in 1720, for the purpose of his second chart, he at the same time observed the time of one horizontal vibration of the same needle, with the express purpose of determining the distribution of the force. These vibration-times are tabulated on his second chart.<sup>11</sup> From them the distribution of relative intensity can be determined. *These observations of Whiston's are undoubtedly the earliest relative terrestrial magnetic force observations ever made.* It is usually believed that the earliest relative intensity observations are the defective ones of Mallet (1769), or the more successful ones, but lost in shipwreck, of Lamanon (1785-87). The absolute value of these Whistonian intensity observations can, of course, not be checked; however, the relative value admits of some control. Thus the writer in his paper has reduced the observations, taking the value of the horizontal force at London as unity, and, with the aid of the reduced values, has roughly sketched the isodynamics (the broken lines in the figure, as prevailing over southern England in 1720. It will be seen that these lines of equal magnetic horizontal force have the same general trend as the isoclinics, as, indeed, they roughly should. Again, taking two stations (London and Saltfleet), which are practically in the same meridian and are distant from each other  $2^\circ$  in latitude, through which, consequently, the same isodynamic would not be likely to pass, it is found that the difference of the vibration-times— $60\frac{1}{2}$  and  $66$ -seconds respectively, is in the right sense, *i.e.*, since the force varies inversely as the squares of the vibration-times, the more northerly station, Saltfleet, gives the smaller horizontal force, as it should. To be sure these early intensity observations are affected with a large probable error; they may, however, not deserve to be assigned to utter oblivion.

Upon the presentation of the writer's paper before the Washington Philosophical Society, Prof. Abbe became interested in the matter, and kindly called the author's attention to a later book<sup>12</sup> of Whiston's, a copy of which was likewise found in the Royal Library of Berlin. Whiston, in this book, gives an account of dip-observations made in various portions of the earth, with the aid of most liberal means furnished by King George and others, for the purpose of testing his magnetic method of determining geographical position. He sent "four several Dipping-Needles to Sea," and "with proper Instructions to the Masters of the Vessels" to observe the dip with both methods (direct and indirect), "to discover the State of Magnetism in the several parts of the Globe." Thus Captain James Jolly set out in July, 1722, for Archangel with one of Whiston's dipping-needles. Owing to a defect of the instrument he could observe only horizontal vibrations. Whiston says (p. 84), "he made me twenty-eight very good Horizontal Observations from the Latitude of  $65$  quite to Archangel." . . . "In

this Space the Needle altered its Velocity very greatly, as I expected it would: And 5 Vibrations which at first were perform'd in about 280, beyond the North Cape, came to 250; till towards Archangel it gradually returned to about 177." The first figure, 280, is probably a misprint, and should be 180. *These observations are the first to show the truth of the law that horizontal intensity decreases in approaching the magnetic pole.* Humboldt has credited Lamanon (1785-87) with the discovery of this law; it was not, however, firmly established until Humboldt's observations of 1798-1803. Furthermore, Captain Othniel Beal set out about the same time as Captain Jolly for Boston. From thence he sailed to Barbados, and thence to Charlestown, South Carolina. At all these places and at sea he made dip observations with both methods. A dip of  $68^\circ 22'$  is given for Boston, and of  $44\frac{1}{2}$  for Barbados, on p. 92. *These two dips precede by fifty-eight years any dip that has hitherto become known in the United States.* The vibration-times are unfortunately not given. A third dip instrument was sent with Captain Tempest to Antigua and St. Christopher's, a fourth sent with Captain Michel to Hamburg. The results with the last two instruments had not yet been all received at the writing of the book. Whiston does not give the actual observations, but says, on p. 90, "The original Journals are all in the Hands of my great Friend and patron, Samuel Molyneux, Esq., Secretary to his Royal Highness the Prince of Wales, and Fellow of the Royal Society: which Journals, when I have compleated the rest of the Observations I hope to procure, I intend to publish entire, for the more full Satisfaction of the curious." It seems that Whiston never published these records. It is hoped that the present article will induce some one to look them up. They may possibly be a valuable find.

In conclusion, let us sum up Whiston's achievements.

- (1) Whiston drew the first isoclinics (1719-20).
- (2) He invented the vibration method of determining the dip.
- (3) He made the first relative terrestrial magnetic intensity observations (1720).
- (4) The first intensity observations (1722), revealing the law of decrease of horizontal terrestrial magnetic force with approach towards magnetic pole, were made under his instructions. L. A. BAUER.

THE TEACHING UNIVERSITY FOR LONDON.

DURING the last week very satisfactory progress has been made towards the reorganisation of the University of London as a teaching as well as an examining body. In the first place, King's College has been brought into line with the other teaching institutions of the metropolis by expressing a general assent to the recommendations of the Gresham Commission, coupled with the proviso that any Statutory Commission appointed to give effect to the Gresham Commissioners' recommendations should have power to make such modifications in the scheme as may seem to them expedient after consultation with the bodies affected—a proviso already insisted on by every teaching institution that has expressed its general approval of the scheme.

The adhesion of King's College to the views of the other teaching institutions mentioned in the Report of the Gresham Commission, was made known on the eve of the reception by Lord Rosebery of the deputation of delegates from the London colleges, and made it possible for these to present their case with the strength derived from complete accord.

On Tuesday last, Lord Rosebery received two deputations—one in the morning in favour of the Gresham scheme, in which representatives of the Senate, the

<sup>11</sup> The only thing that Whiston says with respect to the method employed, is the following Passage on page 112, viz. "The Difference of this Strength of the Magnetic Power, from its Direction, is most visible in my Second Map hereto prefix'd. Where I have all along set down the 'Seconds,' wherein my Needle perform'd a single horizontal Vibration, at about 120 Degrees from the Magnetic Meridian, in most Places, whose Squares, when Allowance has been made for the different Obliquity of the several Directions, as to our Horizon, will give us the different Strength of that Magnetic Power at those several Places;—so does the angle of dip give us the different Direction of the same power there. Now, at first Sight, the former there, appears to be irregular, and the latter regular; as is the Case also of our Terrella." Why Whiston should have observed the vibration time 120, from the magnetic meridian, instead of across the magnetic meridian, the writer has not been able to ascertain. Whiston does not appear to have made any further use of his observations.

<sup>12</sup> "The Calculation of Solar Eclipses with-out Parallaxes. . . . with an Account of some late Observations made with Dipping Needles, in order to discover the Longitude and Latitude at Sea." (London, 1724.)

Annual Committee of Convocation, and the Committee of Graduates of the University of London; the Royal Colleges of Physicians and Surgeons; University College; King's College; Bedford College; the Medical Schools; the Theological Colleges; and the Association for Promoting a Profes-orial University for London took part, and, second in the afternoon, composed solely of members of Convocation opposed to the scheme.

Lord Rosebery's replies show that personally he is anxious to give effect to the Commissioners' recommendations. To the first deputation he said that the Government attach great importance to the Report of the Commission, and are fully sensible of the fact that the present time seems to offer a favourable opportunity, and one that ought not to be postponed, for the appointment of a Statutory Commission in the sense desired by those who had addressed him; while to the second, he made it clear that the opinions of the Government point in the direction of the appointment of a Statutory Commission, which would be able to receive full representations from any interests involved, and thereby be enabled to arrive at a scheme not unsatisfactory both to the present University and to the Empire at large.

Lastly, on Tuesday evening, Convocation of the University of London met, and for the first time came face to face with the question of approval or disapproval of the Commissioners' recommendations. As pointed out in a previous article (vol. I, p. 269), the power of veto possessed by Convocation under the Charter lent considerable importance to the decision arrived at, since an adverse vote might seriously retard the reorganisation of the existing University. In view of this contingency, it is highly satisfactory to record that Convocation, the vast of the bodies to which the scheme has been submitted, by 157 votes to 133 resolved—"That Convocation, while desiring to express generally its approval of the proposals contained in the Report of the Royal Commission, is of opinion that power ought to be given to the Statutory Commission to vary the details of the scheme, and that it ought to be made an instruction to the Commissioners, before framing the statutes and regulations, to confer with duly accredited representatives of the Senate and of Convocation as to the modifications which may be desirable;" a previous resolution affirming that there should be one University in London, and not two, being carried by a slightly larger majority, namely, 206 votes to 175. These majorities may not be large, but they may be fairly taken to proportionately represent the opinion of the 7000 members of Convocation, since so far as any expression of opinion has been elicited by the various parties, 1105 members have expressed general approval of the Commissioners' recommendations, while 1000 have indicated their view any teaching University for London ought to be constituted apart from the existing University. It may be earnestly hoped that with this vote the long controversy within the University has come to an end, and that all parties will now unite in the endeavour to make the new University worthy of the capital of the Empire. W. PALMER WYNNE.

#### NOTES.

We are informed that Mr. C. E. S. O. Elliot has arrived at Arnyre, in the Shire Highlands, on his way home. His route from Bowenari has been by Kogake and Crundi, to the extreme north of Tangayija, which was traversed in Arab dress to Awogari. Thence he followed the usual route by a Saveron Road to Lake Nyasa in the Upper Shire.

FRONZ L. WALTER, Professor of Physics in Freiburg University, has been appointed Prof. K. P.'s successor in that University.

M. HAUTEFEUILLE, Professor of Mineralogy at the Sorbonne, has been elected a member of the Section de Minéralogie of the Paris Academy of Sciences.

DR. S. NAWASCHIN has been appointed Professor of Botany and Director of the Botanic Garden at Kiew, Russia.

THE death is recorded, at Berne, on December 13, of Dr. F. A. FLUCKIGER, well known for his researches in pharmacological botany, at the age of sixty-six.

DR. MURRAY THOMSON died on the 13th inst., in his sixty-first year. He was a Fellow of the Royal Society of Edinburgh and a Fellow of the University of Calcutta. For some years he was Professor of Experimental Science in the Government Engineering College, Roorkee, and chemical examiner for the Government in the North-Western Provinces of India. He was also the author of several medical and chemical treatises.

THE *Times* correspondent at Teheran reports that the town of Kuchan, which was destroyed by an earthquake fourteen months ago, and immediately rebuilt, was again destroyed on January 17. The extent of the damage and the loss of life are not yet known. Earthquake shocks were also felt at Meshed, but no damage was done.

WE learn that a general survey of the tides and currents on the Canadian coast is now being commenced by the Canadian Department of Marine and Fisheries. It cannot fail to be of great use to navigation, and of especial interest to science, as the districts will include the phenomenal one of the Bay of Fundy with its 70 feet rise of tide, with which we have nothing to compare in magnitude in the British Isles.

THE Königliche Gesellschaft der Wissenschaften of Göttingen are organising a conference of delegates of scientific societies and academies, for the consideration of the relations between the variations in the intensity of gravity and the geological constitution of the earth's crust. It is intended that the congress shall take place at Innsbruck on September 5, where and when the International Geodetic Association will hold a meeting.

THE first number of the new series of *Science* has now reached us. To the editorial committee announced in our issue of December 20, should be added President T. C. Mendenhall of the Worcester Polytechnic Institute (Physics), Prof. R. H. Thurston of Cornell University (Engineering), Prof. Le Conte of the University of California (Geology), and Prof. H. F. Osborn of Columbia College (General Biology). The editorial committee, composed of the American men of science best known in England, and the contents of the first number, promise a journal that will adequately represent the progress of science in America. If in a multitude of counsellors there is wisdom, the journal should greatly advance scientific knowledge; not, however, by publishing memoirs and papers for specialists, but by promoting intercourse between students of all branches of nature.

ON Friday, the 11th inst., the Physical Society of London, in response to an invitation from Prof. Carey Foster, visited the new physical laboratories of University College. Before the commencement of the regular meeting in the lecture theatre (a report of which will be found in another column), the large number of members present went over the laboratories and practical classrooms. There are three large rooms solidly built on the ground, and devoted to the use of the more advanced students, and of those engaged in original research. They are in a separate building apart from the main structure, and were specially built for physical work. Above one of them is the optical room, while within the main building there are two



large basement rooms, one used chiefly for electrical and magnetic measurements, and one reserved for the practical classes. On the floor above are the lecture theatre and smaller classroom, apparatus room, chemical room, &c. The laboratories are lighted in the main with electric light, the direct current, supplied by the St. Pancras Vestry, being also used to charge a set of about fifty accumulators. A collection of apparatus was on view, more especially that designed for educational experiments, and used by students in the practical classes. Some of the pieces shown were of historical interest, among them being various instruments designed and used by Ritchie, who was formerly Professor of Natural Philosophy in the College.

ON Thursday last, January 17, the French Society of Aerial Navigation inaugurated the lectures to be delivered to the pupils of the newly-established school of aeronautics. During an address, Prof. Cornu, who was in the chair, said that he was glad that the Academy of Sciences had always exhibited an interest in aerial navigation. In 1782, a programme was drawn up of experiments to be conducted with the help of balloons. In 1794, there was established at Meudon the first aeronautical school, and the first captive balloons were made. In 1802, Gay-Lussac and Biot made the first scientific ascents, which remained almost unequalled until sixty years afterwards, when Glaisher took his aerial travels. The first dirigible balloon was constructed in 1870. Later, Paul Bert investigated the condition of human life at high altitudes. With these facts before them, the pupils of the French aeronautical school were reminded that their efforts would always be supported by the Academy. Aeronautics had been always popular in France, and had rendered good services to science and to the country.

SOME forgotten pages of photographic history were brought before the Brixton Camera Club, by Mr. W. H. Harrison, on January 15. It was pointed out that the many photographic researches of Foucault have been so completely overlooked that in scarcely any recent photographic history is mention to be found of more than his name, if so much as that. Foucault's early experiments in photographing the spectrum upon daguerreotype plates are interesting, and his results were not complicated by the presence of collodion, gelatine, or other colloids. In those early days photographers were so anxious to improve processes and to quicken them for purposes of portraiture, that perhaps these researches in the higher branches of photography interested them little, and soon afterwards were forgotten entirely, so that the name of Foucault as a pioneer of photography has practically passed out of the literature of the subject for nearly a generation. H. Bayard, the first to exhibit a selection of photographs to the general public, in July 1839, has also been much neglected in modern photographic literature. By means of his process, direct positives could be obtained without the intervention of a negative. Bayard's process seems likely to initiate useful modifications at the present time, in the easy production of reversed negatives. Sometimes it is now facetiously said that the best place for backings to prevent halation is on the front of the plate, meaning the use of a thick coating of emulsion: perhaps on Bayard's principle something of the kind may hereafter be done in a more literal sense. It should be remembered that there are two kinds of halation, and that one of them is due to reflection among the particles of silver haloid in the film itself. Perhaps something of especial benefit in astronomical photography may hereafter be evolved from Bayard's principle. Who knows but that it may hereafter lead to the production of a new class of dry plates which can be freely exposed to light, and, when required for use, sensitised by an alcoholic or other volatile liquid containing a haloid salt, to enable the re-drying to be effected quickly?

DR. A. MACDONALD, of the U.S. Bureau of Education, has sent us a number of statistics, showing the sensibility to pain, by pressure, in hands of individuals of different classes, sexes, and nationalities. So far as they go, the results indicate that the majority of people are more sensitive to pain in their left hand than in the right. Women appear to be more sensitive to pain than men, but of course it does not necessarily follow that women cannot endure more pain than men. American professional men are more sensitive to pain than American business men, and also than English or German professional men. The labouring classes are much less sensitive to pain than the non-labouring classes, and the women of the lower classes are much less sensitive to pain than those of the better classes. The general conclusion is that the more developed the nervous system, the more sensitive it is to pain. It is worth remark that, while the thickness of tissue on the hand has some influence, it has by no means so much as one might suppose, *a priori*: for many with thin hands require much pressure before experiencing any pain.

AN auriferous quartz vein has been met with near Douglas in the Isle of Man. This seems to be the first recorded discovery of gold in that island, though, in view of its presence in the very similar districts of Merioneth and Wicklow, it is not in any way surprising.

*Electrical Discovery* is the title of a new fortnightly journal, in which it is intended to publish information on electrical patents filed in the British Patent Office. The *Official Journal* furnishes short abstracts of such inventions, but these do not appear until after the period for opposing the grants of the patents has expired. The new journal is designed to supply the need, by giving electricians early abstracts of all patent specifications and amendments relating to electricity. Digests and reports of patent cases of interest to electricians will also be included, and an index of articles on electrical subjects.

A FEW years ago it was practicable for persons of moderate income to subscribe to all the periodicals devoted to engineering and allied sciences, and to keep abreast with the contents. Now the number of such journals is so great, and so many are the memoirs and works bearing on engineering, that engineers, like the rest of us, are feeling the need of an index of their literature. Suggestions for the construction of such an index are given by Prof. G. D. Stephenson in the *Transactions* of the American Institute of Electrical Engineers for November 1894, and the following number contains a report of a long discussion on the subject. It is a satisfactory sign of the development of the scientific side of engineering, that electrical, mechanical, hydraulic, civil, and mining engineers want an index to their literature.

THE great Andalusian earthquake of December 25, 1884, as is now well known, produced slight disturbances of the magnetic curves at Lisbon, Parc St. Maur, Greenwich, and Wilhelmshaven. Two astronomical clocks were also stopped at the observatory of San Fernando, near Cadiz. From the times so recorded, the French Commission appointed to study the earthquake obtained values which seemed to show that the velocity of the earthquake wave diminished as it radiated outwards. In two recent papers (*R. Acad. des Lincei, Rend.* iii. 1894, pp. 393-319, 317-325), Dr. G. Agamennone reconsiders the problem. He shows that the apparent diminution of velocity would disappear if the time at Cadiz were a minute too late. And an error of this kind, he remarks, is possible, for the times given for the magnetic observatories correspond to the beginning of the movement, whereas the clocks at Cadiz would be stopped during a later phase. Assuming the velocity uniform,

he finds it to be  $3.15 \pm 0.1$  kilometres per second, a value which agrees very closely with some recent determinations.

The light of the Blue Grotto of Capri, as well as that of the so-called red and green grottoes (*grotto rosso* and *grotto verde*) has been spectrally tested by Dr. H. W. Vogel, and is described in the current number of *Wien. botan. Annalen*. The most striking fact about the Blue Grotto was the occurrence of an absorption band between the Fraunhofer lines C and D of the solar spectrum, which does not occur in ordinary water. In addition to this, the red and orange were extinguished as far as the D line. The same spectrum was exhibited by the water in front of the grotto. The "green grotto" is a rocky tunnel filled with bluish green sea-water. The rocky walls show green reflections in the interior, produced by the impact of the bluish light from the water upon the yellow stones. But the absorption band noted in the Blue Grotto is here entirely absent. From the top of the cliffs, patches of azure-blue water could be seen surrounded by green. They all showed the absorption band, and retained their position permanently, so that they are probably due to some local cause. The "red grotto" does not show a trace of red light.

ATTENTION was recently drawn in our columns to an interesting observation made by Dr. Ostroumoff, of Sebastopol, on the power possessed by the Copepod *Pontellina mediterranea*, of jumping in the air upon the surface film of water. It appears from several further communications that this peculiar habit is also possessed by several other Copepods, viz. *Pontella atlantica* (M. Edw.), according to Dahl (*Verh. deut. zool. Gesell.* 1894, p. 64), and *Pontella eufier* (Brady), according to an observation made by Captain Hendorff, who states that he several times saw this Copepod leap quite a foot high from the water in which it was contained. Herr Mrazek, in recording Captain Hendorff's observations (*Zool. An.*, No. 415, p. 5), also mentions the additional case of a Schizopod having the same habits. This phenomenon, however, can be easily observed in the case of British Schizopods, and appears to be the result of abnormal conditions rather than a natural habit. Herr Mrazek does not support Dr. Ostroumoff in his view of the connection between this habit and the process of exuviation; he regards the movement in question as either purposeless and sportive, or for the sake of attaining escape from enemies. The latter view certainly receives support from the somewhat analogous case of the *Viridula* fly.

We have received an elaborate paper read before the Congress of Scandinavian Naturalists at Copenhagen, by Dr. Ernst Almqvist, on the transmission of yellow fever. Much uncertainty of opinion exists as to the means by which this disease is propagated, some authorities asserting that it is a purely zoonotic origin, and cannot be imported into a place where it does not already exist, and others holding that it can be imported from one individual directly from one individual to another. Dr. Almqvist, who makes a special study of the subject, has arrived at the following principal facts about the dissemination of the infection, which are admitted by various authorities:—(1) The infection is transmitted together and explained by the same means, whether it be for this purpose the air, or the water, or the soil, or the insects, or yellow fever, and (2) regarding the mode of propagation, such as spores and rollers, and the way in which the infection is differently characterized and degrees of virulence, the mode of this theory, Dr. Almqvist claims many other facts of phenomena, and has produced an excellent work on the subject. Unfortunately, however, it is not only a hypothesis, but a star-nomicrobe, the mode of yellow fever has been discovered and accepted; but it is only a hypothesis, and it is intended to solve the question

THE new volume of *Memoir* (Zapiski) of the Caucasian Geographical Society (vol. xvi.) is again one of exceptional interest. It contains, first, a series of botanical papers on the flora of Northern Caucasia, by I. Akinfiiev, together with an account of a journey of the same author in Ossetia and Svanetia; three papers, by N. M. Alboff, on the vegetation of Western Transcaucasia, on new species found in Abkhasia, and on the Abkhasian ferns; and an abridged translation of several papers, by Dr. E. Dieck, on the flora of Western Transcaucasia; the series thus making a very valuable addition to our present knowledge of the flora of Caucasus. And next, the same volume contains a series of papers devoted to the still imperfectly known parts of the central section of the Main Caucasus ridge. M. N. Zhukoff contributes a paper on the glaciers of North-east Svanetia, with a new and very interesting map (13 miles to the inch) of a wide glacier region; A. V. Pastukhoff describes his ascensions of the Shah dagh and the Ararat, as well as his visits to some of the high-level villages, of which Kurush, situated at a height of 8175 feet, is the highest in Caucasia—the paper being accompanied by small maps and photographs of the Kichen-dagh, the Nesen-dagh, and the Kurush village; M. and Mme. Rossikoff contribute two papers on the glaciers and Alpine lakes of the Central Caucasus main chain, giving exact measurements of the speed of motion of several glaciers; and another Alpinist, N. Dinnik, gives a description of Mount Oshten and the surrounding parts of the province of Kuban, which is full of very interesting geographical and botanical data. And, finally, two papers, by MM. Shalikoff and Andronikoff, are geographical and statistical descriptions of two districts of the government of Tiflis—Ksan and Uraveli. An index of all the papers contained in the hitherto published volumes of both the *Memoir* (Zapiski) and the *Bulletin* (Izvestia) of the Caucasian Geographical Society, is also a most welcome feature of the present volume.

A SECOND edition of Dr. G. V. Poore's instructive "Essays on Rural Hygiene" has been published by Messrs. Longmans, Green, and Co. The new edition includes more than fifty additional pages.

THE Rose Polytechnic Institute, Terre Haute, Indiana, has published a bulletin on "Physical Units," by Prof. Thomas Gray. The bulletin comprises a concise and admirable collection of definitions of fundamental and derived units.

No. 2 of the *Botanisches Centralblatt* for 1895 contains an exhaustive bibliography of the colouring matters of plants, by Dr. Hermann Ritter Schrotter Kristelli, together with some new observations on the occurrence of carotin.

A WORK entitled "Molecules and the Molecular Theory of Matter," by A. D. Risteen, will be published in February by Messrs. Ginn and Co. The work is intended to be a popular exposition of the molecular theory of matter as it is held by the leading physicists of to-day. The subject is treated from a physical standpoint.

WHEN a book twenty years of age blossoms into a second edition, it is hardly necessary to say that the original must have undergone a thorough revision. This is the case with Prof. Alfred Newton's little "Zoology," published in 1874, among a series of manuals of elementary science, by the Society for Promoting Christian Knowledge. The new edition takes in much of the zoological work done during the past two decades, thus rendering it one of the cheapest, handiest, and best broad introductions to the study of zoology.

THE publication is announced of the first number of a *Phytopl. Brevi-americanis*, by Messrs. F. S. Collins and Isaac Holden and Dr. W. A. Setchell. The work will include all families of Alga, both freshwater and marine (except, for the

present, Characeæ, Desmidiæ, and Diatomaceæ), from the Arctic Ocean to the Isthmus of Panama, including the West Indies. Each number will include fifty species, and the price will be five dollars. Subscriptions and offers of contributions are to be addressed to Mr. Frank S. Collins, 97 Dexter Street, Mass., U.S.A.

FROM a note in the *Botanical Gazette* we learn that the fox-tail grass or squirrel-tail grass, *Hordeum jubatum*, is a serious pest to stock in the Western States of America. The barbed awns break up into pieces, penetrate the gums, especially near the teeth, producing swelling, and ultimately suppuration, of the gums, and ulceration of the jaw-bones and teeth, the latter being so loosened as to drop out. If the animal continues to eat hay containing this grass, the disease progresses till the bony tissue of the jaws is disarranged, the ulcers extend to all parts of the jaw-bone, and it becomes distorted and enlarged. The marrow-filled interior is changed into great cavities filled with the broken awns. This condition may continue till the cavities extend entirely through the jaw, and the tightly-packed awns protrude till they may be pulled out with forceps or fingers.

THE completeness of the series of Eocene and Cretaceous strata exposed along the great central river system of Alabama, is well known to American geologists. A report on the geology of the coastal plain of Alabama, just issued by the Geological Survey of that State, shows that, on account of the fine exposures along the river banks, and the great number and perfection of the fossils, the region presents the most complete and varied series of Eocene and Cretaceous strata known in the United States. All that relates to Cretaceous, Tertiary, and Post-Tertiary formations in the vicinity of the Alabama and Tombigbee rivers, is described in the first part of the report. The second part contains all the data of practical value concerning the various phosphatic marls, green-sands, &c., occurring in the region surveyed, and the third part includes a number of geological details referring to the different counties of the State. Prof. E. A. Smith, the State Geologist, and those who have assisted him, may be congratulated upon the publication of this important account of the stratigraphy of the Cretaceous and Tertiary formations of the Gulf region of Alabama.

AN inorganic mode of preparing hydrazine,  $N_2H_4$ , is described by Dr. Duden, of the Jena University Laboratory, in the latest issue of the *Berichte*. Hitherto the numerous methods of formation of this important hydride of nitrogen, described by its discoverer, Prof. Curtius, and his assistants, and by Thiele and von Pechmann, have all been based upon the decomposition of more or less unstable organic compounds of the diazo, nitrosamine, or nitramine types. Dr. Duden has succeeded in an inorganic synthesis by use of a singular compound, discovered by Davy and further investigated by Raschig and by Divers and Haga, which is produced by the action of sulphurous acid upon potassium nitrite. This compound, whose composition is represented by the formula  $K_2SO_3 \cdot N_2O_2$ , is now found to yield hydrazine upon careful reduction in alkaline solution. Divers and Haga showed that the ordinary products of reduction of the compound with sodium amalgam in concentrated alkaline solution are mainly potassium hyponitrite  $KNO$  and hydrogen potassium sulphite  $HKSO_3$ , smaller quantities of hydroxylamine and ammonia being likewise produced. Dr. Duden finds that if the reduction with sodium amalgam, or zinc dust and ammonia or soda, is carried out at a low temperature, the solution produced possesses very strong reducing properties, and after acidification deposits the salt of hydrazine corresponding to the acid employed. The freshly prepared compound of potassium sulphite

and nitric oxide is suspended in water cooled by ice, and sodium amalgam is gradually added with further extraneous cooling by means of a freezing mixture, until the liquid is found to strongly reduce Fehling's solution and yields, after acidification and warming to expel sulphur dioxide, a precipitate of benzalazine upon the addition of benzaldehyde. The benzalazine so obtained is found to exhibit all the properties of the compound as described by Prof. Curtius; it melts at  $93^\circ$  and yields numbers on analysis exactly agreeing with the formula  $(C_6H_5CHN)_2$ . With sulphuric acid it yields hydrazine sulphate  $(N_2H_4)_2 \cdot H_2SO_4$ , identical in melting point ( $256^\circ$ ) and all other properties with that derived from the organic methods of preparation. The formation of hydrazine from the compound of nitric oxide and potassium sulphite would appear to occur in two stages, an intermediate reduction compound being first produced of analogous constitution to Davy's salt in accordance with the following equation:

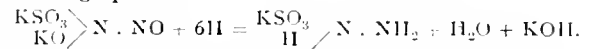

A further reaction then occurs between the intermediate compound and the alkali, with production of potassium sulphate and hydrazine

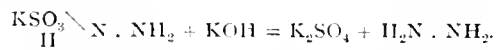

THE additions to the Zoological Society's Gardens during the past week include a Macaque Monkey (*Macacus cynomolgus*, ♀) from India, presented by Mr. H. Ralls; a Black-backed Jackal (*Canis mesomelas*) from South Africa, presented by Mr. Fred Bissmire; a Dusty Ichneumon (*Herpestes fulviventris*), a White-throated Monitor (*Varanus albigularis*) from South Africa, presented by Mr. J. E. Matcham; a Derbian Wallaby (*Halmaturus derbianus*) from Australia, presented by Mr. Joseph Palmer; a Jackal Buzzard (*Buteo jacob*) from South Africa, presented by Mr. E. Wingate; a Yellow-headed Conure (*Conurus jentaya*) from South-east Brazil, a Brown-throated Conure (*Conurus aruginosus*) from South America, presented by Mrs. Hankey; three Eroded Cinixys (*Cinixys erosa*), two Home's Cinixys (*Cinixys homeana*) from West Africa, presented by Mr. J. Banks Elliot; a Lesueur's Water Lizard (*Physignathus lesueurii*) from Australia, deposited; a Rosy-billed Duck (*Melospiza peposaca*), a Garden's Night Heron (*Nycticorax gardenii*) from South America, purchased.

OUR ASTRONOMICAL COLUMN.

THE PERSEID METEORS.—This well-known shower of meteors should be of the greatest interest to the mathematician, as well as to the observer. At Pulkova, in 1893, the shower was observed from July 22 to September 12, and a discussion of the 563 paths recorded forms the subject of an interesting paper by Dr. Bredichin (*Bull. Imp. Acad. Sc.*, St. Petersburg, September 1894). It has long been known that the Perseids are not as other regularly recurring meteor showers, and Dr. Bredichin explains their peculiarities by supposing that they are not produced by a swarm of meteorites, in the true sense of the word, but by particles circulating in different orbits. These orbits have widely differing inclinations, and the other elements also show striking departures from each other. One gets a good idea of the system which is suggested, by imagining a bundle of materialised orbits crossing the earth's orbit at the points which the earth occupies during August, and for some days before and after. The particles with long periods correspond to the meteors at the beginning of the showers, and to the primitive position of the comet from which the meteors are supposed to be derived, which, having a moderate period, has left these meteors behind. The position of the node of the comet is not symmetrical with reference to the nodes of the meteors, but appears to be nearer the beginning than the end of the showers. This con-

NITROGEN FIXATION IN ALGÆ.

tinuity of the phenomena for so long a time seems to confirm the idea of a variety of periods for the particles, and indicate also the repeated omission of the meteors from the body of the comet. If the forces of disruption were only those which have ordinarily been considered, the meteors would be dispersed in a long stream along the length of the orbit, as in the case of the November meteors; but since the orbits of the meteors are variously inclined to that of the comet, another force, acting transversely to the plane of the orbit, must be admitted as an important factor. The anomalous phenomena of the tails of some comets—a subject with which Dr. Bröcherin is already closely associated—and the energetic emissions which have been noted in several comets, including that which is connected with the Perseids, serve to demonstrate the possibility of such an action as that which he supposes to have taken place in the case of this swarm.

COMET 1894 I (DENNING) AND BRÖRSSEN'S COMET.—Dr. Hind contributes to the current number of the *Astronomische Nachrichten*, No. 3271, a very interesting note as to the identity of Denning's comet with that discovered by Brörsen. To investigate the question, he has found, with M. Schulhof's elements for Denning's comet and Dr. Lamp's elements for Brörsen's comet, that the distance of the orbits would be 0.0367 in Longitude 285° (1894.0), and that in April 1881 the comets approached one another within a distance of 0.138. On this account, he says, during the comet's recession from perihelion, might not Brörsen's comet have met with a catastrophe, causing disintegration and the return of a portion of it to perihelion, in a somewhat different orbit, in Denning's comet of last year?

Dr. E. Lamp has also considered this question of identity, and, in referring to Dr. Hind's note, writes that the similarity of the two orbits is very striking, and that, in the beginning of 1881, the two bodies must have been very close to one another near the point of intersection of the two orbits. With the same elements as used by Dr. Hind, he finds the point of intersection of the orbits in Longitude 284.47° and South Latitude 1.57°. The places of the two bodies are then as follows:—

	Denning.	Brörsen.
True anomaly ... ..	154.22	109.7
Ecc. anomaly ... ..	123.22	147.25
Radius vector ... ..	5.240	5.218

The point of nearest approach in the orbit of Denning's comet occurs in a position 5' behind, and in the Brörsen's orbit 4' before, the actual place, the distance between these points being 0.022 radii of the earth's orbit. Dr. Lamp suggests that, by increasing Schulhof's value of the mean daily motion by about 28", the comets would thus be brought together. The question, however, is in a very undecided state, but astronomers will await with interest the results of Dr. Lamp's investigation as to whether the comet furnish an instance of a mere approach or of a real physical contact.

STAR-BAYES' PECULIAR SPECTRA.—Prof. F. C. Pickering states in the *Astronomische Nachrichten*, No. 3269, that an examination of photographs of stellar spectra, taken at the Arequipa Station of the Harvard College Observatory, has led to the discovery of four new variable stars in Centaurus, Epsilon Pavæ, and Microscopium, and ten other objects with spectroscopic peculiarities. Of these, the spectra of five are classified as Type D, five appear to belong to Type V; one (R.A. 189.3834, Dec. 1.27.35) is a nebulæ; one has H $\beta$  bright; and the photographic spectrum of the remaining object contains no bright lines. The new low-velocity stars are drawn any sharp distinction of very fine and bright line stars, we quote the concluding paragraph of Prof. Pickering's communication: "The peculiar spectra of faint gaseous nebulae and stars of the hydrogen type are to be made each other, and can only be distinguished by the wavelength of the principal bright line. In page 106 of the *Astronomische Nachrichten* is of greater wavelength than H $\beta$ , which is of the hydrogen type, the line  $\lambda$  4861.0. Further wave-lengths and a representation of a chart and spectrum plate of the star were given in a similar position for 1890. R.A. 159.1096, Dec. 1.43.30, which has been announced as a star of the hydrogen type in the *Astronomische Nachrichten*, Vol. 115, p. 195, however, the star is in reality a gaseous nebula."

IN NATURE of March 20, 1894, Prof. Marshall Ward gave a clear and excellent summary of certain aspects of the question of nitrogen fixation in plants. Since the publication of that article, fresh and most important additions have been made to the subject.

Last May, P. Kossowitsch published an account of his experiments on Alge in respect to their nitrogen-fixing powers (*Bot. Zeitung*, May 16, 1894), and a short account of this contribution should form an appropriate supplement to Prof. Ward's paper.

In 1888, Prof. Frank, of Berlin, had stated his opinion that Alge possessed the power of free nitrogen fixation.

In 1892, Messrs. Schloesing and Laurent published an account of their classical researches dealing with many plants, among which Alge also found a place. Their experiments with these forms range in two series. In the first they found that if they kept soil, covered with Alge and containing bacteria of certain kinds, under observation for some time, an increase in nitrogen was perceptible. On the other hand, if they prevented the formation of Alge, although the same bacteria remained, there was no noticeable addition to the nitrogen of the system. In the second set of experiments, in which different Alge were employed, no nitrogen fixation could be perceived. It was evident from this that either particular kinds of Alge only have "fixing" powers, or that suitable bacteria were not simultaneously present in the second case, and that Alge can only fix with the additional aid of these micro-organisms.

In the following year, Koch and Kossowitsch devoted their attention to the subject, and went over much the same ground as Laurent and Schloesing, confirming their results, and adding new facts, the value of which, however, was somewhat enhanced by the algal cultures never consisting of any single species alone, but of several intermingled. Accordingly when, in 1894, Kossowitsch set himself the task of determining whether Alge in themselves possess the power of assimilating free atmospheric nitrogen or not, the first obstacle he had to overcome was the difficulty of finding a method by which he could obtain a single algal species in absolute purity. This was ultimately effected by growing the Alge on gelatinous silicic acid permeated with a nutritive solution, and subsequently on sterilised sand also containing food solution. The steps by which the isolation was effected were slow and beset with difficulties, which sprang up in the most unexpected manner, and the pages of Kossowitsch's memoir which deal with this subject possess a separate and great interest of their own; space, however, will not permit that the matter be detailed here. Having obtained the Alge in a state of purity, the next step was to transfer them to the apparatus in which their nitrogen-fixing powers were to be tested.

This consisted of a central air-tight vessel connected with a series of U-tubes, which were blown into bulbs at certain intervals. These bulbs contained strong sulphuric acid. The whole apparatus was sterilised, and the Alge under consideration sown upon a sterilised nutritive substratum in the central vessel. Air freed from all traces of nitrogen compounds was blown into the vessel through the U-tubes, the sulphuric acid in which killed any organisms which might be contained in this air.

The Alge which was first experimented on was *Cystococcus* (or an extremely similar form). Every precaution was taken in introducing this into the apparatus.

Using a nutritive solution perfectly free from all nitrates, it was seen that the Alge refused to show any signs of growth; it was clear, therefore, that at least to start development a trace of nitrate must be added to the soil. The addition of other nitrogen compounds was found to be useless, and accordingly a small and accurately measured quantity of a nitrate was mixed with the food solution in the central vessel. The whole apparatus thus fixed up was placed in the light, and left for some weeks. At first rapid increase in the Alge was noticeable, but after the lapse of about three weeks things evidently came to a standstill.

The addition of more nitrate free nutritive solution gave no result; but if only the merest trace of a nitrate were added, there was an immediate resumption of activity.

These facts in themselves are very good proof of the inability of *Cystococcus* to fix atmospheric nitrogen; but to make matters doubly sure, a careful chemical analysis was made. This showed

that there was no increase in nitrogen during all the weeks the Algae had been flourishing, and that accordingly no iota of the stream of free nitrogen which had been constantly passing through the apparatus had been "fixed." So far, then, the first Alga which had been put to the test of experiment showed itself incapable of utilising atmospheric nitrogen.

Kossowitch now turned to fresh experiments, choosing algal cultures of sometimes one, sometimes several species taken together; to all of these he added simultaneously soil-bacteria of mixed sorts. The apparatus employed was very nearly the same as that above described. In these experiments he desired to test the supposition of Berthelot and Winogradsky, who considered the presence of certain organic substances to be favourable to the fixation of nitrogen; he accordingly arranged his experiments in five pairs, both members of each couple having identical conditions, except that in the one a small quantity of sugar (dextrose) was added to the nutritive solution, whilst in the other no organic compound was present. One set was arranged with *Cystococcus* and soil-bacteria, and the results obtained showed that in the absence of organic materials a small but yet noticeable increase in the nitrogen of the system had taken place (from 2.6 mg. to 3.1 mg.) Where sugar had been previously added, however, there were three times as much nitrogen after the experiment as before. In a second pair of cultures the Alga *Stichococcus* and certain bacteria were used, but here in no case, either with or without sugar, was there any increase in nitrogen. This shows that *Stichococcus* has in itself no power of nitrogen fixation.

Another couple contained a mixture of several Algae, *Nostoc*, *Cylindrospermum*, &c., and certain soil-bacteria. In this instance a very large fixation of nitrogen took place, both where sugar was present and where not; in fact, in the former case the nitrogen was increased more than nine-fold.

All these observations shed much light upon the question of the relations existing between Algae, micro-organisms, and atmospheric nitrogen. They show:—

- (1) That at least two Algae—*Cystococcus* and *Stichococcus*—possess no "fixing" powers in themselves.
- (2) That many Algae, taken together with certain micro-organisms of the soil, do possess the power of assimilating atmospheric nitrogen.
- (3) That this power is much increased by the addition of such organic substances as sugar.

It should be noticed that among the ten cultures used in the second set of experiments, only two contained definitely isolated algal species, viz. the cases of the two cultures of *Cystococcus* and soil-bacteria.

It was just in this instance, moreover, that it had been shown that the Alga itself had no capacity for fixing atmospheric nitrogen. Accordingly, there could be little doubt that it was through the agency of the micro-organisms that the "fixation" had taken place in these latter cultures.

The experiments of Laurent and Schloesing had shown that if in a culture of Algae and bacteria endowed with "fixing" powers, the Algae were destroyed, the bacteria lost partly, if not entirely, this capacity, which the mixture had possessed. This pointed clearly to the fact that there was some close relationship existing between the Algae and micro-organisms.

There are many facts which seem to indicate the nature of this relationship.

Berthelot found that the nitrification of the soil only took place as long as organic compounds were present; if these were exhausted, the nitrifying process ceased. Gautier and Drouin also showed the importance which organic compounds have with respect to nitrification. Kossowitch's own experiments, in which the advantage of adding sugar to the culture was shown, also point in the same direction.

From such observations as these, Kossowitch concludes that the relationship which the Algae bear to the micro-organisms is one connected with the organic food supply of these latter; he thinks that the Algae, furnished with nitrogen by the bacteria, assimilate carbohydrate material, part of which goes to their own maintenance, but part also to that of the micro-organisms. It is, therefore, in his belief, an instance of symbiosis in which each supplies the wants of the other. There are many facts, partly the result of his own observations, partly the result of those of others, which uphold this view. If the mixed culture be placed in the light, there is a far more noticeable nitrogen increase than when in darkness. Again, if a rich supply of carbon dioxide gas be provided, this is marked by a decided rise

in nitrogen-fixing powers. Both these conditions are such as are known to influence carbohydrate assimilation in chlorophyll-containing organisms; but all experience is antagonistic to the view that light should be beneficial to the vital activity of the bacteria, and there are only one or two exceptional instances (*Nitronomas*, &c.) in which carbon dioxide can be directly assimilated by these micro-organisms.

Moreover, in the cases where the bacteria are brought into immediate contact with the Algae, as in those species of Algae which are enveloped in a gelatinous covering wherein the micro-organisms become embedded, nitrogen fixation appears to be greatly aided, and the addition of sugar to the culture has no such marked effect as in the instances where non-gelatinous Algae are employed. The explanation of this seems to be that the bacteria embedded in the gelatinous sheath are amply provided with carbohydrate food without the addition of sugar, which, therefore, comes more or less as a superfluity.

All this seems to justify Kossowitch's view of the part played by the Algae in the fixation of nitrogen; it appears to show that they have an indirect, but none the less important, influence upon the process.

This is roughly the extent of Kossowitch's article; it has been impossible to give here its details, the bare outlines of his researches could alone be mentioned, but it is hoped that sufficient has been said to show the importance of his work, perhaps even to indicate the interest which every page of his memoir possesses, dealing as it does with one of the most fascinating branches of vegetable physiology.

RUDOLF BEER.

#### THE COMMERCIAL SYNTHESIS OF ILLUMINATING HYDROCARBONS.

THE direct combination of carbon and hydrogen in the electric arc is a true case of synthesis, and if we could form acetylene in this way in sufficiently large quantities, it would be perfectly easy to build up from the acetylene the whole of the other hydrocarbons which can be used for illuminating purposes. For instance, if acetylene be passed through a tube heated to just visible redness, it is rapidly and readily converted into benzol; at a higher temperature naphthalene is produced, whilst by the action of nascent hydrogen on acetylene, ethylene and ethane can be built up. From the benzol we readily derive aniline, and the whole of that magnificent series of colouring matters which have gladdened the heart of the fair portion of the community during the past five-and-twenty years, whilst the ethylene produced from acetylene can be readily converted into ethyl alcohol, by consecutively treating it with sulphuric acid and water, and from the alcohol, again, an enormous number of other organic substances can be produced, so that acetylene can, without exaggeration, be looked upon as one of the great keystones of the organic edifice, and, given a cheap and easy method of preparing it, it is hardly possible to foresee the results which will be ultimately produced.

In 1836, it was found that when making potassium, by distillation from potassic carbonate and carbon, small quantities of a bye-product, consisting of a compound of potassium and carbon, was produced, and that this was decomposed by water with liberation of acetylene; whilst Wöhler, by fusing an alloy of zinc and calcium with carbon, made calcic carbide, and used it as a source from which to obtain acetylene by the action of water.

Nothing more was done until 1892, when Macquenne prepared barium carbide by heating at a high temperature a mixture of barium carbonate, powdered magnesium, and charcoal, the resulting mass evolving acetylene, when treated with water; whilst, still later, Travers made calcic carbide by heating together calcic chloride, carbon, and sodium. None of these processes, however, gave any commercial promise, as the costly nature of the potassium, sodium, magnesium, or calcium-zinc alloy which had to be used, made the acetylene produced from the carbide too expensive.

Whilst working with an electric furnace, and endeavouring by its aid to form an alloy of calcium from some of its compounds, Mr. T. L. Willson noticed that a mixture containing lime and powdered anthracite, under the influence of the tem-

1. Abstract of a paper by Prof. Vivian B. Lewis, read before the Society of Arts, Wednesday, January 17.

perature of the arc, fused down to a heavy semi-metallic mass, which having been examined, and found not to be the substance sought, was thrown into a bucket containing water, with the result that violent effervescence of the water marked the rapid evolution of a gas, the overwhelming odour of which enforced attention to its presence, and which, on the application of a light, burnt with a smoky, but luminous flame.

Investigation into the cause of this phenomenon soon showed that in a properly constructed electric furnace, finely ground lup chalk or lime, mixed with powdered carbon in any form, whether it were charcoal, anthracite, coke, coal, or graphite, can be fused with the formation of a compound known as calcic carbide, containing 40 parts by weight of the element calcium, the basis of lime, and 21 parts by weight of carbon, and that, on the addition to this of water, a double decomposition takes place, the oxygen of the water combining with the calcium of the calcic carbide to form calcic oxide or lime, whilst the hydrogen unites with the carbon of the calcic carbide to form acetylene, the cost of the gas so produced bringing it not only within the range of commercial possibilities for use *pro se*, but also the building up of a host of other compounds, whilst the production of the calcic carbide from chalk and from any form of carbon, renders us practically independent of coal and oil, and places in our hands the prime factor by which nature in all probability produces those great underground storehouses of liquid fuel upon which the world is so largely drawing to lay.

Calcic carbide is a dark grey substance, having a specific gravity of 2.262, and, when pure, a pound of it will yield on decomposition 5.3 cubic feet of acetylene. Unless, however, it is quite fresh, or means have been taken to carefully protect it from air, the outer surface gets slightly acted upon by atmospheric moisture, so that in practice the yield would not exceed five cubic feet. The density and hardness of the mass, however, protects it to a great extent from atmospheric action, so that in lumps it does not deteriorate as fast as would be expected, but in the powdered condition it is rapidly acted upon.

The acetylene made from it, when analysed by absorption with bromine, the analysis being also checked by determining the amount present by precipitation of silver acetylide, gives 98 per cent. of acetylene and 2 per cent. of air, and traces of sulphuretted hydrogen, the presence of this impurity being due to traces of sulphate of lime (gypsum)—in the chalk used for making it, and to pyrites in the coal employed.

Acetylene is a clear, colourless gas with an intensely penetrating odour which somewhat resembles garlic, its strong smell being a very great safeguard in its use, as the smallest leakage would be at once detected; indeed, so pungent is this odour, that it would be practically impossible to go into a room which contained any large quantity of the gas.

This is an important point to remember, as the researches of Liebreck and Liebreich show that the gas is poisonous, combining with the hæmoglobin of the blood to form a compound similar to that produced by carbon monoxide; whilst the great danger of the latter gas is that having no smell, its presence is not detected until symptoms of poisoning begin to show themselves, so that no fear need be apprehended of our getting into the room with acetylene.

Acetylene is soluble in water and most other liquids, and at ordinary temperature and pressure 60 F. and 30 inches of mercury—100 volumes of water will absorb 11 volumes of the gas; but as the temperature falls, the gas is dissolved, the water being saturated before the gas is gone. Water already saturated with carbon dioxide, will absorb quite so readily, whilst the gas is practically insoluble in saturated brine. 100 volumes of a saturated solution of brine will dissolve 5 volumes of the gas. The gas is far more soluble in alcohol, which at normal temperature and pressure absorbs six times its own volume of the acetylene, while the volume of paraffin under the same conditions will absorb only twice the gas. It is a heavy gas, having a specific gravity of 1.09.

When a light is applied to acetylene it burns with a luminous, intensely smoky flame, and when one volume of acetylene with one volume of air is burned in a cylinder, the solid residue runs down the cylinder, leaving behind a mass of soft, and heavy, black, as dense as black lead. When acetylene is mixed with 1.5 times its own volume of air, the mixture begins to be slightly explosive, the explosive force increasing until it attains a maximum with

about twelve times its volume of air, and gradually decreases in violence until, with a mixture of one volume of acetylene to twenty of air, it ceases to be explosive.

The gas can be condensed to a liquid by pressure, Andsell finding that it liquefied at a pressure of 21.5 atmospheres, at a temperature of 0° C., whilst Cailliet found that at 1° C. it required a pressure of 48 atmospheres, the first-named pressure being probably about the correct one. The liquid so produced is mobile, and highly refractive, and when sprayed into air, the conversion of the liquid into the gaseous condition absorbs so much heat that some of the escaping liquid is converted into a snow-like solid, which catches fire on applying a light to it, and burns until the solid is all converted into gas and is consumed.

In my researches upon the luminosity of flame, I have shown that all the hydrocarbons present in coal-gas and other luminous flames are converted by the baking action taking place in the inner non-luminous zone of the flame into acetylene before any luminosity is produced, and that it is the acetylene which by its rapid decomposition at 1200° C. provides the luminous flame with these carbon particles, which, being heated to incandescence by various causes, endow the flame with the power of emitting light. The acetylene, being in this way proved to be the cause of luminosity, one would expect that in this gas we have the most powerful of the gaseous hydrocarbon illuminants; and experiment at once shows that this is the case.

Owing to its intense richness, it can only be consumed in small flat-flame burners, but under these conditions emits a light greater than that given by any other known gas, its illuminating value calculated to a consumption of 5 cubic feet an hour being no less than 240 candles.

*Illuminating Power of Hydrocarbons for a Consumption of 5 cubic feet of Gas.*

	Candles.
Methane	5.2
Ethane	35.7
Propane	56.7
Ethylene	70.0
Butylene	123.0
Acetylene	240.0

It is stated that the carbide can be made at about £4 a ton; and if this be so, it should have a great future, as a ton will yield 11,000 cubic feet of the gas. The lime left as a by-product would be worth 10s. a ton, and the gas would cost at this rate 6s. 4½d. per 1000 cubic feet, and in illuminating value would be equal to London coal gas at 6d. a thousand. Its easy production would make it available for illuminating purposes in country houses, whilst its high illuminating value should make it useful for enriching poor coal gas.

*CHEMICAL CHANGES BETWEEN SEA-WATER AND OCEANIC DEPOSITS.*

THE numerous analyses of sea water by Forchhammer previous to 1805, and the later analyses by Dittmar, from samples collected during the *Challenger* Expedition, show that while the salinity—*i.e.* the amount of dissolved salts contained in 100 parts of sea-water—varies greatly in different regions of the ocean, still the composition of these dissolved salts—*i.e.* the ratio of the constituents of sea-salts—remains practically the same in all the superficial waters of the ocean. Consequently, it is only necessary to determine the chlorine in a definite weight of water to ascertain at once the respective quantities of the other salts present in the sample. Dittmar's examination of the *Challenger* waters has, however, shown that lime is slightly, although distinctly, more abundant in samples of sea-water collected in greater depths than in those samples collected nearer the surface of the ocean, and Dittmar's tables showing the difference between the chlorine calculated from the specific gravity and the chlorine found by analysis—point to differences in the composition of the sea-salts; but the observations are

Abstract of a Paper read before the Royal Society of Edinburgh on March 21, 1894, by Dr. John Murray and Robert Irvine, and published in *Trans. Roy. Soc. Edinb.*, part 2, No. 2.

Dittmar, *Challenger's Report on the Composition of Ocean Water*, "Phy. Chem. Chem. Exp." 1883, p. 4.

relatively so few, these differences so slight, so mixed up with observational errors, and so irregular in their geographical and bathymetrical distribution, that they cannot be said to indicate any general law other than a greater quantity of lime in deep water.

But there is abundant evidence that great changes in chemical composition take place in the substances deposited on the floor of the ocean, and, with the view of throwing some light on the manner in which these changes are brought about, it occurred to us to examine the composition of the sea-water associated or mixed up with marine deposits on the floor of the ocean, and especially with that variety of marine deposits known as Blue Mud.

The depth at which a fine blue mud may form in the sea, depends entirely on the depth of water and the extent of the basin; or, in other words, on the height and length of the waves.<sup>1</sup> In harbours it may be deposited not deeper than 1 or 2 fathoms, while along the western coasts of Scotland and Ireland, which are exposed to the waves of the wide and deep Atlantic, the true mud-line may be situated at a depth of about 150 or 200 fathoms.

In this paper we state the results of our investigation into the composition of the sea salts in samples of water enclosed in the blue muds from Granton Harbour and Quarry, near Edinburgh, at Queensferry, N.B., and other places. The water was obtained by filling a canvas bag with the mud and collecting the water which filtered through, the first portions being rejected.

The Specific Gravity of the filtrate was about normal for in-shore water, ranging from 1024 to 1026.

*Chemical Composition of the Sea-water Salts in Mud-water.*—On comparison with normal sea-water salts, the sulphates were greatly reduced, while the alkalinity (combined carbonic acid) was correspondingly increased, sometimes rising to ten times above the normal.

When a portion of the clear water filtered from the harbour muds was boiled, a precipitate was thrown down in a crystalline form, consisting of carbonates of lime and magnesia in the following proportions:—

CaCO <sub>3</sub> ... ..	73.30
MgCO <sub>3</sub> ... ..	26.70

100.00

Before boiling, the water had an alkalinity of 0.7760 grms. per litre, while after boiling it showed an alkalinity of only 0.2200 grms., thus proving that the alkalinity was mainly due to the formation and presence of these carbonates rendered soluble by free carbonic acid.

Saline and albumenoid ammonia ranged from 4 to 50 parts, and 1 to 5 parts per million, respectively. Lime was much less, and magnesia slightly less than the normal. The chlorine and the total bases were higher than normal water of equal density. Bicarbonate of manganese was present in the water up to 1 part in 10,000. Normal sea-water contains no manganese.

The following table gives a comparison of the composition of normal and mud-waters:—

	Average sea-water.	Mud-water.
Sodium chloride, NaCl ... ..	77.758	79.010
Magnesium „ MgCl <sub>2</sub> ... ..	10.878	11.222
Magnesium bromide, MgBr <sub>2</sub> ... ..	0.217	0.220
Magnesium sulphate, MgSO <sub>4</sub> ... ..	4.737	3.232
Potassium „ K <sub>2</sub> SO <sub>4</sub> ... ..	2.465	2.506
Ammonium „ (NH <sub>4</sub> ) <sub>2</sub> SO <sub>4</sub> ... ..	...	0.206
Magnesium carbonate, MgCO <sub>3</sub> ... ..	...	0.720
Calcium „ CaCO <sub>3</sub> ... ..	0.345	2.686
Calcium sulphate, CaSO <sub>4</sub> ... ..	3.600	...
Manganous carbonate, MnCO <sub>3</sub> ... ..	...	0.180

100.000 100.000

<sup>1</sup> See Murray and Renard, "Challenger Report on Deep-Sea Deposits," p. 170. (London, 1871.)

<sup>2</sup> See Ostwald, *op. cit.* pp. 137-138 and 200.

It will be seen that the total salts of the mud-water are low in proportion to the chlorine, consequently the D value—that is, the density minus 1000 divided by the chlorine—will be lower than normal water. In normal water the D value is 1.457, in mud water 1.430.

*The reactions that take place in Blue Mud* seem to be the following, and may be distinctly proved from the analyses of mud-water, as well as from a consideration of the whole subject. During the process of decomposition it appears that the greater part of the oxygen for the oxidation of the carbon and hydrogen of the organic substances in the blue muds is derived from the sulphur salts of the alkaline and earthy alkaline metals in sea-water, which, in the first instance, are reduced to the form of sulphides. These sulphides, owing to their instability, especially in the presence of free or loosely combined carbonic acid, are decomposed as formed. The sulphur thus reduced from the sulphates may in part, on passing as hydrosulphuric acid into the water immediately above the mud, become oxidised back again into sulphuric acid, which in turn, decomposing the carbonate of lime always present in the water (or in the deposit), would re-form sulphates.

This oxidation is effected but slowly, as the following laboratory experiments show:—

*Exp. I.*—A solution of hydrosulphuric acid (H<sub>2</sub>S) in pure water, which at first gave no precipitate with barium chloride, after standing a month, gave a distinct precipitate of barium sulphate, showing that the hydrosulphuric acid had been oxidised into sulphuric acid (SO<sub>4</sub>).

*Exp. II.*—A solution of hydrosulphuric acid in sea-water was exposed to the air till complete oxidation had taken place. On titration the sea-water had lost its alkalinity, the sulphuric acid being proportionately increased.

*Exp. III.*—Hydrosulphuric acid was passed into water holding carbonates of calcium and magnesium in suspension, and resulted in a yellowish solution of the sulphides of calcium and magnesium, carbonic acid being expelled. The sulphides so formed were in turn decomposed by excess of carbonic acid, with evolution of hydrosulphuric acid, bicarbonates being formed, the reaction apparently depending on which acid is in excess.<sup>1</sup>

A certain part of the sulphides, or it may be of hydrosulphuric acid, derived from the soluble sulphides by the action of the free carbonic acid present in the mud, reduces the ferric oxides of the deposit, forming sulphide of iron, which so long as it is not exposed to the action of oxygen, remains stable, being in this respect unlike sulphide of manganese.<sup>2</sup> The sulphide of iron gives the characteristic blue-black colour to the great majority of the blue muds, especially where there is abundance of organic matter. It is by this process that sulphur is continually being abstracted from sea-water and locked up in marine deposits, which may finally be converted into blue-coloured shales, schists, and marls. In these rocks the crystalline pyrites (FeS<sub>2</sub>) has evidently its origin in the processes of death and decay going on at the time of their deposition at the sea-bottom, the sulphur of the sulphide of iron being derived from the sulphates of the sea-water, and not from the sulphur of the organisms, as generally supposed. This decomposition seems to be due to the action of bacteria in causing putrefactive changes in dead organic matter. We have found that if sea-water containing putrescible organic matter be sterilised by boiling, and thereafter care be taken to prevent the ingress of bacteria to this cooled liquid, the changes above indicated do not take place. Apparently the organic matter must be broken down by bacteria into its component elements, which in the nascent condition are capable of reducing the sulphates to a lower form of combination. The bisulphide of iron in the coal measures has without doubt a similar origin.

<sup>1</sup> See also *op. cit.* (London, 1871), pp. 137, 138, 139, 140, 141, 142, 143, 144, 145, 146, 147, 148, 149, 150, 151, 152, 153, 154, 155, 156, 157, 158, 159, 160, 161, 162, 163, 164, 165, 166, 167, 168, 169, 170, 171, 172, 173, 174, 175, 176, 177, 178, 179, 180, 181, 182, 183, 184, 185, 186, 187, 188, 189, 190, 191, 192, 193, 194, 195, 196, 197, 198, 199, 200.

<sup>2</sup> The black or dark blue colour of many shales, especially of the Devonian and Silurian, is due to the presence of iron, either combined with sulphur as sulphide, or more rarely in the condition of carbonate or oxide. These shales, schists, &c., contain organic matter in a state of decomposition. In the older rocks this condition nearly approaches that of graphitic carbon in a dark schist from Argyllshire only 0.1 per cent. of *carbonaceous* organic matter was found. In the more recent formations the organic matter, in an abundant quantity, may give rise to the formation of petroleum. See 1849, by Dr. J. J. Lubbock, *Travels in the North of Scotland*, p. 12, Pl. 42, Heft 1.





partment, from 1856 to the end of February 1858, when Prof. Neumayer, now Director of the Nautical Observatory at Hamburg, commenced systematic observations at the new Magnetic and Meteorological Observatory, at Flagstaff Hill, Melbourne. Dr. Neumayer also established several observing stations at the lighthouses on the coast, and at a few places inland.

On the retirement of Dr. Neumayer in 1863, the Magnetic and Meteorological Department was transferred to the present Astronomical Observatory, then just erected, and placed under the direction of the astronomer, Mr. Ellery, in whose hands the institution soon became what it is to-day—not only a credit to the colony which founded it, but second to none in the southern hemisphere. He threw all his energy and skill as a physicist into his work, and early introduced photographic and other systems, by which we obtain continuous records of all variations of terrestrial magnetism, barometric pressure, and changes of temperature, electrical states of the atmosphere, and the direction and force or velocity of the wind, besides thermometers sunk at various depths (3 feet, 6 feet, and 8 feet) to determine the temperature of the ground; while, as regards astronomy, we have only to visit the observatory to see that it possesses some of the finest instruments in the world.

Besides the Melbourne Observatory, he has established meteorological stations of the second order at Portland, Cape Otway, Wilson's Promontory, Gabo Island, Ballarat (Mount Pleasant), Bendigo, Echuca, Sale (at the School of Mines), and twenty-three stations of the third order, besides 515 rainfall stations judiciously distributed throughout the colony.

In South Australia, thanks to the late Sir George Kingston, father of the present Premier, we have a continuous record of the rainfall in Adelaide from 1839, which that gentleman maintained until 1878.

Meteorological observations, more or less complete, were made at the Survey Office for a number of years, or until I took up the work in November 1856, when the observatory records commenced under my direction as Government Astronomer.

Since May 1860, all the observations have been made at the West Terrace observatory. For several years I had no assistant, and having a growing telegraph department to look after and control, the area of my work was necessarily restricted, and I laboured under many disadvantages; but I early established meteorological stations at Clare, Kapunda, Strathalbyn, Goolwa, Robe, and Mount Gambier, and placed rain gauges at the different telegraph offices. I also introduced the system of publishing daily reports of the weather and rainfall from all stations at the head telegraph office in Adelaide.

We have now meteorological stations, having standard or Board of Trade barometers, dry and wet bulb thermometers, maximum and minimum thermometers, and rain gauges, at Port Darwin, Daly Waters, Alice Springs, Charlotte Waters, Strangways Springs, Farina, Port Augusta, Yongala, Clare, Kapunda, the Agricultural College at Roseworthy, Mount Barker, Strathalbyn, Eucla, Fowler's Bay, Streaky Bay, Port Lincoln, Cape Borda, Robe, Mount Gambier, and Cape Northumberland, and 370 rain gauges; at the lighthouses at Cape Borda and Cape Northumberland, and at the telegraph offices at Port Darwin and Alice Springs, the observations are taken every three hours, night and day; at other stations at 9h. a.m., 3h. p.m., 9h. p.m.; whilst at Alice Springs there is a large evaporation tank similar to the one at the observatory, which it may be convenient here to describe.

It consists, first, of a brick tank, lined with cement; internal measurement, 4ft. 6in. square and 1 ft. 2in. deep. Inside this tank is another, made of slate, 3ft. square and 3ft. deep, leaving an intervening space between it and the larger tank of 7in. Both tanks are filled to the same level, or to within 3in. or 4in. of the top, fresh water being added as required. The evaporation is measured by a graduated vertical rod, which is carried by a float placed in a vertical cylinder of copper 4in. in diameter (perforated at the bottom) standing in the inner tank. The rod is graduated to  $\frac{1}{16}$  of an inch, and is read off by means of a fixed vernier to  $\frac{1}{100}$  of an inch. A rain gauge is placed by the side of the tank, and both the evaporation and the rainfall are read at 9 a.m. and 9 p.m.

In Tasmania, the Imperial Government established a magnetic and meteorological observatory at Hobart, as part of an international scheme, in charge of Captain Kay, and systematic meteorological observations were conducted from 1841 to 1854, hourly readings being taken until the end of 1848. The results were published, together with the magnetic observations, in

four large quarto volumes with a short but interesting and instructive article by the late Prof. Dove, then director of the meteorological stations in Prussia. Similar observatories were established at Greenwich, St. Helena, Cape of Good Hope, and Toronto, besides places in Europe, and by Russia in Asia.

From the beginning of 1855, the Imperial Observatory being closed, meteorological observations at Hobart were carried on by the late Mr. Francis Abbott until about the year 1880, when the Government took up the work, which was entrusted to the late Captain Shortt, R.N., who died in 1893. Captain Shortt proved a valuable coadjutor, and established eight other observing stations, besides a number of rain gauges in various parts of the island, of which there are now about fifty nine.

In Western Australia, a meteorological observatory was established by the Government in connection with the Surveyor-General's office, the work being entrusted to Mr. M. A. C. Fraser, in 1876, since which continuous records have been published. Prior to the date mentioned we have rain and temperature records at Perth from 1860 to 1869, taken by Mr. H. Knight. At present Mr. Fraser has fifteen meteorological stations, exclusive of Perth, and ninety one rain gauges. At Perth there is a self-recording barometer, selected by me when in England in 1886. The observations in this colony are very valuable, extending, as they do, from the south coast well into the tropics at Wyndham, Cambridge Gulf.

In Queensland, as has already been stated, meteorological stations were started at Brisbane and Rockhampton by Mr. Scott, the first Government Astronomer of New South Wales. I do not know the exact date, but Mr. Scott arrived in the colony in 1858, and retired in 1862. The instruments were transferred to Queensland on its separation from the parent colony, and for some years the duties of meteorologist devolved on Mr. Edmund MacDonnell, who established several observing stations and a number of rain gauges.

In 1887, Mr. Wragge was appointed, who—with the great ability and energy which characterise him, and which had brought him so much renown in starting, I believe at his own expense, the high level observatory at Ben Nevis, where he conducted the work under difficulties which would have deterred most men—soon effected a complete revolution. Beginning his work on January 1, 1887, he speedily equipped stations of the several orders all over the colony, along the coast round to the Gulf of Carpentaria, and inland to the very western boundary of the colony. He classified his stations under five orders, according to the completeness of their equipment.

Following the example of Mr. Ellery, Mr. Russell, and myself, Mr. Wragge commenced the system of publishing daily reports of weather and rainfall, and a synoptic map similar to the map we had for some time been issuing in Adelaide. He also co-operated with us in publishing forecasts of the probable weather during each ensuing twenty-four hours, with this addition, that he issued forecasts not only for Queensland, but also for the other Australian colonies; and, as these latter were made without regard to those published at an earlier hour by the several local authorities, it has occasionally happened that the two forecasts for the same colony differed from each other. I will not venture an opinion as to the desirableness of this independent action, beyond remarking that supposing the judgment and qualifications of the other meteorologists to be equally good, their local experience, and the possession of more detailed information in regard especially to prognostics, clouds, &c., gives them an advantage, and their forecasts should be of equal value, and be more frequently justified. I regret that Mr. Wragge's collected observations have not yet been published—from causes, it may be presumed, beyond his control—in such detail as he himself would wish, and which, in the interests of science, we all desire. This is to be regretted, as his stations are so distributed as to represent the climate of all parts of that large colony.

Besides the stations in Queensland, Mr. Wragge tells me he has supplied instruments for two stations of the first order in New Guinea, for one in New Caledonia, one in Fiji, and one in Norfolk Island, and two others of the second order in New Guinea.

In New Zealand, I learn from Sir James Hector, that from 1853 meteorological reports were included in the yearly volume of statistics issued by the Registrar-General, but the observations were of irregular character, and possessed little value until 1859, when the work was taken up in a more systematic manner. Observers were appointed at Wanganui, Auckland, Napier, New Plymouth, Wellington,



point images. This method is inapplicable when the dielectric angle is not a submultiple of two right angles, as has been shown by W. D. Niven, *Z. M. S.* vol. xii, p. 27. The only other case which has been hitherto solved is, the author thinks, that of the spherical bowl (Lord Kelvin, "Papers on Electrostatics and Magnetism," p. 178). In the paper by W. D. Niven, mentioned above, an attempt is made to deduce the capacity of such a conductor from the solution of a functional equation for a particular value of one of the variables, but the result obtained does not seem in the case of the spherical bowl to agree with Lord Kelvin's. The results obtained by the author also differ from those given by Niven. The object of the paper is to obtain the solution in the general case. To effect this, the functional image of a point placed between two planes intersecting at any angle is obtained in the form of a definite integral. In the next few paragraphs the reduction of this integral to known forms is effected in certain cases, and it is shown that the integration can be performed when the angle of intersection is any submultiple of four right angles; the case in which it is reducible to elliptic functions is also discussed. In § 5, the functional image of a line of uniform density parallel to the intersection of the planes is deduced. In § 7, the potential due to a freely-charged conductor bounded by two spherical surfaces cutting at any angle is obtained and some particular cases discussed. The capacity of such a conductor is obtained in § 8, in finite terms, and some particular cases are discussed in § 9; one of the most interesting of these is the capacity of a hemisphere, which is found to be nearly one and a quarter times that of the complete sphere, showing that the sharp edge acts somewhat like a condenser. Some cases are mentioned in the last paragraph which could be deduced from the results of the preceding ones.—The Dynamics of a Top, by Prof. A. G. Greenhill, F.R.S. To construct a model of the articulated deformable hyperboloid described by M. Darboux in Note xix. to Despeyroux' "Cours de Mécanique," t. ii., which shall realise the motion of the axis of a Top, the ratio of the axes of the focal ellipse must be taken equal to the modulus  $k$  of the associated elliptic functions. The parameters  $a$  and  $b$  of the two elliptic integrals of the third kind corresponding respectively to the lowest and highest vertical positions of the Top, which give the azimuth  $\psi$ , will be of the form

$$a = pK'i \text{ and } b = qK'i'; K, K',$$

where  $p$  and  $q$  are real proper fractions. Then two points P and Q must be taken on the focal ellipse whose eccentric angles, measured from the minor axis, are given by

$$\text{am}\{t(\rho + \gamma)K', k'\} \text{ and } \text{am}\{(t - \rho - \gamma)K', k'\};$$

and if the tangents HI and HJ are drawn at Q and P, intersecting in H, these tangents make angles

$$\text{am}\{(\rho + \gamma)K', k'\} \text{ and } \text{am}\{(\rho - \gamma)K', k'\}$$

with the minor axis. The parallel tangents OC and OG being drawn, intersecting in O, the design of the model is completed, in Henri's manner, by drawing any other two pairs of tangents to the focal ellipse; the tangents OI and IO being replaced by a pair of rods representing the generators through O, HI and HJ representing the parallel generators through H, the other pairs of tangents representing the connecting generators, all freely jointed at the points of crossing. If OG is held fixed in a vertical position, the point H opposite to O is constrained to move in a fixed horizontal plane; and now if H is moved along a herpolhode of parameter  $a + b$ , the generator OC will imitate the motion of the axis of a Top. Starting with the hyperboloid flattened in the plane of its focal ellipse, and H at a maximum distance from OG, the axis OC is in its lowest position; and as H moves along the herpolhode to its minimum distance from OG, the axis rises to its highest position, when the hyperboloid becomes flattened in the plane of its focal hyperbola. If the herpolhode has points of inflexion, the path of a point C in the axis OC will be looped; since the motion in azimuth of OC vanishes as H passes through a point of inflexion. If  $\rho = \gamma = 1$ , the point Q lies at the end of the minor axis of the focal ellipse; the path of C now has cusps. In the spherical pendulum the points H and O lie on the pedal of the focal ellipse with respect to the centre; this gives a geometrical interpretation of the equation

$$p'a = \pm p'q,$$

discussed in Halphen's "Fonctions elliptiques," i. p. 110. The vector OH represents the resultant angular momentum of

the Top; and the tangent to the path of H is thus perpendicular to the vertical plane GOH. When the momental ellipsoid at O of the Top is a sphere, then OH represents also the resultant angular velocity. But in the general case, when the momental ellipsoid at O is a spheroid, with axis OC, the resultant angular velocity is represented by the vector OH to a point H fixed in the generator HQ; also H and I describe equal curves with respect to OC in parallel planes perpendicular to OC, which are herpolhodes of parameter  $a - b$ . Since I can be joined to a fixed point in the opposite generator OG by a rod of fixed length, we have Darboux's theorem that the motion of the Top can be realised by rolling a herpolhode of parameter  $a - b$ , on a fixed sphere. The connection of the motion of a Top with herpolhodes has also been discussed by Dr. Routh, *Phil. M.* xxiii. p. 34. As an application, consider Halphen's algebraic herpolhode

$$x^2 + b^2(\eta^2 + \beta^2) = a^2$$

or

$$\{p^2 \sin^2 2\theta - b^2 r^2 + b^4 - a^4 = 0,$$

produced by rolling the hyperboloid of two sheets

$$\frac{x^2}{a^2} + \frac{y^2}{b^2} - \frac{z^2}{a^2} = 1$$

on a fixed plane at a distance  $b$  from the centre.

In the associated motion of the Top,  $\rho + \gamma = \frac{1}{2}$ , the focal ellipse of the articulated hyperboloid is given by

$$\frac{x^2}{b^2} + \frac{y^2}{b^2} = 1$$

the coordinates of H and O in its plane are given by

$$y^2 = \frac{a^2}{8} \left( \frac{a^2}{b^2} - 1 \right), \quad z^2 = \frac{a^2}{8} \left( \frac{a^2}{b^2} + 1 \right);$$

$$\text{at P } y^2 = \frac{b^2}{8} \left( \frac{a^2}{b^2} - 1 \right), \quad z^2 = \frac{b^2}{8} \left( \frac{a^2}{b^2} + 1 \right); \text{ at Q}$$

$$y^2 = \frac{b^2}{8} \left( \frac{a^2}{b^2} - 1 \right) \left( \frac{a^2}{b^2} + 2 \right), \quad z^2 = \frac{b^2}{8} \left( \frac{a^2}{b^2} + 1 \right) \left( \frac{a^2}{b^2} + 2 \right).$$

The motion of the axis of the Top is given by

$$\sin^2 \theta \cos 2\psi = 4\sqrt{2} \frac{a^2 b^2}{a^4 + 4b^4} \sqrt{\frac{1 - a^4 - 2b^4}{a^2(a^2 + 8b^2)}} - \cos \theta \sqrt{\frac{1 - a^4 - 2b^4}{a^2(a^2 + 8b^2)}}$$

$$\sin^2 \theta \sin 2\psi = \frac{a^2}{b^2} \sqrt{\frac{1 - a^4 - 2b^4}{a^2(a^2 + 8b^2)}} = \cos \theta \sqrt{\frac{1 - a^4 - 2b^4}{a^2(a^2 + 8b^2)}}$$

$$\sqrt{\frac{1 - a^4 + 4b^4}{a^2(a^2 + 8b^2)}} \cos \theta = \frac{a^2 - 4b^2}{a^2} \sqrt{\frac{1 - a^4 - 2b^4}{a^2(a^2 + 8b^2)}} = \cos \theta \sqrt{\frac{1 - a^4 - 2b^4}{a^2(a^2 + 8b^2)}}$$

Thus for instance, if  $a^2 = 2^2$ ,  $b = 1$ ; the point Q is at an end of the minor axis of the focal ellipse, and the curve described by C has cusps. If  $a^2 = 3^2$ ,  $b = 1$ ; Halphen's herpolhode has points of inflexion where  $r^2 = \frac{1}{2}b^2$ , and  $r^2$  varies between  $4b^2$  and  $8b^2$ ; the equation of the focal ellipse is

$$\frac{x^2}{b^2} + \frac{y^2}{4b^2} = 1,$$

and the coordinates of H and O are  $\pm \frac{1}{2}\sqrt{3}b$ ,  $\pm \frac{1}{2}\sqrt{6}b$ .—Some properties of generalised Brocard circles, by Mr. J. Griffiths.—On fundamental systems for algebraic functions, by Mr. H. F. Baker.

Physical Society, January 11. —Extra meeting, in the physical laboratories of University College (by invitation of Prof. Carey Foster).—Prof. Kicker, President, in the chair.—Prof. Rumsay read a paper, by himself and Miss Dorothy Marshall, on the measurement of latent heats of vaporisation of various organic liquids. The liquid to be examined is placed in a small flask with a narrow neck, and within this is a platinum wire which has its two ends fused through the bottom, so as to be capable of conveying an electric current. The flask is completely enclosed in a jacket, which is filled with the vapour of liquid of the same kind. Before the current is turned on, the vapour jacket is kept going for some time, so that the liquid in the flask is raised just to its boiling point, but no appreciable evaporation takes place. As soon as the current is turned on, boiling commences, and all the heat developed in the wire is expended in producing evaporation. By weighing the flask before and after, the mass of liquid vaporised is determined. So far the authors have only used the method for comparative

Intercomparison of the arrangements of the kind described are placed side by side, and the same current is sent through their two wires, which are joined in series and have approximately equal resistances. The ratio of amounts of heat expended on the two wires is varied by the ratio of the masses vaporised, is equal to the ratio of their latent heats. The determinations made by this method agree well with those of other observers; and the main object is to obtain values correct within about one per cent. a large number of liquids, rather than a highly accurate value for any one substance. In reply to Mr. Griffiths, the author stated that the platinum wire was found to rise about 25° above the temperature of the liquid, and Mr. Griffiths said that his experience had been similar. He did not see why a very high degree of accuracy should not be obtainable by the method. Prof. Rücker expressed his admiration for the work, and thought it justified by the fact that the results agreed more nearly with the theory than those of other observers. —Mr. Eumorfopoulos read a paper on the determination of thermal conductivity and emissivity. In the first series of experiments described, two bars of the same material and polish, and each of uniform circular section, are heated, each at one end, until the distribution of temperature has become steady. By means of two thermometers, one on each rod, a series of isothermal points are then found. According to the ordinary theory, if the two bars agree in temperature at a given pair of points, they will also agree in temperature at distances  $x_1$  and  $x_2$  measured respectively from these points, where  $x_1$  and  $x_2$  are connected by the relation  $x_1^2 \propto (2l_1^2/x_2^2)$ ,  $l_1$  and  $l_2$  being the lengths of the rods. This relation was not found to hold good in the rods examined. In all cases  $x_1/x_2$  was further removed from unity than the ordinary theory would require. One conclusion was that the formula usually adopted in such cases could not be used for the comparison of conductivities, unless the radii of the rods compared are equal, and their surfaces in the same condition. To settle the question, three brass rods were chosen, and their absolute conductivities compared by Ayrton's method. The emissivity was found to vary considerably with the radius, being greater the thinner the rod; moreover, the value of the emissivity deduced from the first assumption of the Porter's series was in each case found to be about 1.2 times as great as that deduced from the constant term.

Mr. A. W. Porter then read a paper on the influence of the dimensions of a body on the thermal emission from its surface. The ordinary assumption is that when a body is *in vacuo* or surrounded by air, the "emissivity" (*i.e.* the amount of heat radiating outwards from unit area per second per degree excess of temperature) is independent of the size of the body. Results obtained experimentally by Peltier for cylinders and spheres of various sizes show that the emissivity depends materially upon the size of the body. Peltier's formulae for cylinders and spheres surrounded by air show that for each of the forms the rate of emission from the surface, even if we of the radiation effect, may be expressed as a constant  $\frac{1}{2} \pi a$  a term inversely proportional to the radius. The author examines the results of supposing the constant to vary only in part the law of radiation, the remainder being assumed to follow the law of conduction. He thus arrives at the formula

$$E = a \log R - \log a l;$$

where  $E$  is the emissivity,  $l$  the radius of the rod,  $R$  the radius of a ball of the same weight as arounds the bar, and above which the excess of temperature are reckoned; while  $a$  and  $c$  are constants. The formula has been compared with experimental results of Ayrton and Ferguson, of Macfarlane, of Birtouley, and of Peltier, and has been directly checked by experiments on a brass rod when surrounded by water-jackets of different radii, as well as on a tube same bar unjacketed. The author finds that the present theory is much closer than is the case with the theory of constant emissivity, or with empirically determined form of Ayrton and Ferguson, and he concludes that generalising heat conductivity as a function of a function in determining emissivity as the size of the body is not correct. Prof. Carey Foster thought that an demonstration of the accuracy of the end-sure Mr. Porter had established was important. Prof. Ayrton agreed as to the importance of the nature of the enclosure. He argued that in such experiments, as those of Mr. Porter and Mr. Eumorfopoulos, the conductivity and emissivity, which were functions of the temperature, should not be assumed constant along the bar. Mr. Foster objected to the use of the

term emissivity as including loss of heat by contact with the air in addition to the loss by radiation. Mr. Griffiths said that in some of his experiments, where a wire conveying an electric current was immersed in a liquid in order to heat the latter, the rise of the temperature of the wire above that of the liquid was found to be nearly independent of the diameter of the wire. Mr. Eumorfopoulos said that in each case his comparison had been between portions of bars in which the range of temperature was the same. Moreover, the variation of emissivity and conductivity with temperature, as found by other observers, would be quite insufficient to account for his results. Mr. Porter said that the term emissivity had come to be accepted as referring to all heat lost at the surface of a body, whether by radiation or by conduction and convection. In that sense he had used the term. Prof. Rücker thought that emissivity, in this sense, was not a good term, but to change now would probably only make greater confusion. —Mr. G. U. Yule then gave a brief outline of his paper, on the passage of an oscillator wave-train through a plate of conducting dielectric. By a conducting dielectric the author means a substance whose conductivity and dielectric capacity are both of importance in the case under discussion; and the paper is mainly an investigation of the following problem: a train of plane electromagnetic waves falls at normal incidence on an infinite parallel-sided plate of conducting dielectric, whose thickness is finite, and at the first face of the plate, the amplitude of the vibration vector in the incident train is zero up to a certain instant, and then becomes equal to an harmonic function of time, multiplied by an exponential function with negative index; to find what proportion of the energy of the whole incident train is reflected back, what proportion is transmitted through the plate, and what proportion absorbed. At successive incidences of reflected and re-reflected wave-trains upon the two bounding faces of the plate, the amplitudes and phase-changes of reflected and transmitted portions have to be taken into account, and the resulting infinite series of terms have to be summed. The analysis is very long, but the results obtained are exact. Curves are given, showing (for special numerical values of the constants of the problem) the quasi-periodic variation of the amounts of energy transmitted and reflected, as the thickness of the plate is increased from zero up to a high value. Other curves are given showing the effect of varying the dielectric constant and the conductivity of the plate, and the difference between a "damped" and an "undamped" wave-train in regard to intensity of reflected and transmitted portions. The author compares his calculated results with measurements obtained in the case of oscillator waves travelling along a double-wire circuit about 100 metres in length; the wires at the middle of the circuit being run through a jar containing distilled water, alcohol, or a very dilute electrolyte. The necessary corrections, however, are difficult and uncertain, and the author has not found it possible to deal with them in a satisfactory way. —A letter from Dr. E. H. Barton was read, emphasising the necessity for taking into account the damping in the oscillator-train, and at the same time pointing out why, in his opinion, the corrections applied by Mr. Yule were inadequate and failed to yield intelligible results. Prof. Rücker congratulated Mr. Yule on his work, and on the importance of the results he had obtained. In returning the thanks of the Society to Prof. Carey Foster for the invitation to meet in University College, he expressed the pleasure he had felt in observing the extent and completeness of the laboratories. Hitherto London had been behind the provinces in this matter, and it was gratifying to find that students in London had now such opportunities for practical instruction in physics. The papers which had been read at that meeting were a proof that good use was being made of the laboratories for the purposes of research. The educational experiments they had seen in the laboratories were excellently devised, and he hoped that many of them would become a part of the regular course of instruction in the country. Prof. Fisher briefly replied.

Chemical Society, Dec. 20, 1894. —Dr. H. E. Armstrong, President, in the chair. —The following papers were read: —An improved form of barometer, by J. N. Collie. The author has devised a portable barometer presenting several new features. —The constituents of *Piper avatum*, by W. R. Dunsan and H. Garnett. *Piper avatum* is a West Indian medicinal plant; the authors have separated from it a toxic alkaloidal substance, which they term piperovarine,  $C_{16}H_{21}NO_2$ ; it seems likely to be of service in therapeutics. —Note on the active constituent of the Pellitory of medicine, by W. R. Dunsan and H. Gar-

nett. The Pellitory of medicine (*Anacyclus pyrethrum*) contains an active substance, which they name pellitorine; it closely resembles piperovatine, and is possibly identical with it.—The determination of some high temperature freezing-points by means of platinum-resistance pyrometers, by C. T. Heycock and F. H. Neville. The authors give the results of freezing-point determinations of a number of metals and salts.—The preparation of adipic acid and some of its derivatives, by W. H. Ince. Contrary to the statements of Apppe and Malaguti, adipic acid is not produced in the action of nitric acid on sebatic acid or beef suet. The author has prepared  $\alpha$ -monobromalipic acid in a state of purity, and has obtained  $\alpha$ -hydroxyadipic acid.—The action of hydrogen chloride on the oxides of calcium, barium, and magnesium, by V. H. Veley. Dry hydrogen chloride does not act on quick-lime or magnesia at ordinary temperatures; at higher temperatures action occurs. Baryta is acted on at all temperatures by the dry gas.—Latent heat of fusion, by H. Crompton.—Metallic tartrasenites, by G. G. Henderson and A. R. Ewing. Arsenious oxide dissolves in hot solutions of acid tartrates, giving tartrasenites; the sodium salt,  $C_4H_2O_6AsO_3Na$ ,  $2\frac{1}{2}H_2O$ , is stable and crystalline.—Note on the interaction of hydrogen sulphide and bismuth haloid compounds, by M. M. P. Muir and E. M. Eagles.

Zoological Society, January 15.—Dr. St. George Mivart, F.R.S., Vice President, in the chair.—Mr. P. Chalmers Mitchell exhibited and gave an account of a tibia and other bones of an extinct bird of the genus *Aepyornis* from Central Madagascar, which had been lent to him for exhibition by Mr. Joseph H. Fenn. With these bones was associated a skull of a species of *Hippopotamus*.—Prof. G. B. Howes exhibited and made remarks on the photograph of an embryo of *Ornithorhynchus*.—The Secretary exhibited, on behalf of Mr. K. Lydekker, a life-sized drawing of *Idiurus senkeri*, a new and remarkably small form of flying squirrel from West Africa, recently described at Berlin.—Lord Lilford sent, for exhibition, the skin of a duck, believed to be a hybrid between the Mallard (*Anas boschas*) and the Teal (*Querquedula arca*), that had been caught in a decoy in Northamptonshire.—The Rev. T. R. R. Stebbing exhibited a specimen of a species of *Peripatus* from Antigua.—Mr. Frederick Chapman gave an account of some Foraminifera obtained by the Royal Indian Marine Survey's s.s. *Investigator* from the Arabian Sea near the Laccadive Islands. The author described the forms found in the samples sent him. As many as 277 species and varieties were enumerated, some of which were new to science. Several of the species, which were here recorded for the first time from recent soundings, had been previously known from the Pliocene deposits of Kar Nicobar. One of the forms found in these recent deposits, viz., *Amphistegina radiata* (F. and M.), was described by the author as showing the presence of in-canal canals, a structure which had hitherto appeared to be restricted to Nummulites and allied forms. Examples of embryonic forms of the same species were also noted as being present in the peripheral chambers of the adult shell.—A communication was read from Mr. P. R. Uhler containing an enumeration of the Hemiptera-Homoptera of the Island of St. Vincent, West Indies. This paper had been based on specimens submitted to Mr. Uhler by the joint Committee of the Royal Society and British Association for the exploration of the Lesser Antilles.—A communication from Mr. F. D. A. Cockerell contained a description of a new species of the family *Coccolidae* belonging to *Lichtensia*, a genus new to the fauna of the Neartic region. The species was named *L. lycii*.—Mr. Sclater read some notes on the recent occurrence of the Barbary Sheep in Egypt. A flock of these sheep had visited the eastern bank of the Nile above Wady Halfa in the summer of 1890.—A second paper by Mr. Sclater contained some notes on the recent breeding of the Surinam Water Toad (*Pipa americana*) in the Society's reptile-house.

Entomological Society, January 16.—The sixty-second annual meeting; Mr. Henry John Elwes, President, in the chair.—An abstract of the treasurer's accounts, showing a good balance in the Society's favour, having been read by Mr. W. F. H. Blandford, one of the auditor, the secretary, Mr. H. Goss, read the report of the Council. It was then announced that the following gentlemen had been elected as officers and Council for 1895:—President, Prof. Raphael Meldola, F.R.S.; treasurer, Mr. Robert McLachlan, F.R.S.; secretaries, Mr. Herbert Goss and the Rev. Canon Fowler; librarian, Mr. George C. Cham-

ption; and as other members of the Council, Mr. George T. Bethune-Baker, Mr. Walter F. H. Blandford, Dr. Frederick A. Dixey, Mr. Henry J. Elwes, Mr. Charles J. Gahan, Prof. Edward B. Poulton, F.R.S., Dr. David Sharp, F.R.S., and the Right Hon. Lord Walsingham, F.R.S. It was also announced that Prof. Meldola, the new President, would appoint Lord Walsingham, Mr. Henry J. Elwes, and Prof. Edward B. Poulton, Vice-Presidents for the session 1895-96. The outgoing President then delivered an interesting address on the geographical distribution of Lepidoptera. He remarked that though a great deal had been written of late years on the geographical distribution of plants, mammals, birds, fishes, and reptiles, comparatively little had yet been done by entomologists to show how far the natural divisions of the earth's surface which have been established for other classes were applicable to insects. Perhaps the proportion of known as compared with unknown insects was still too small, and the classification of the known species still too uncertain, to allow anything like the same methods to be applied to insects that had been used for mammals by Dr. Wallace, F.R.S., for birds by Dr. Sclater, F.R.S., and Dr. Bowler Sharpe, and for plants by Sir J. Hooker, F.R.S., Mr. Thesleton Dyer, F.R.S., and Mr. W. B. Hemsley. The President enumerated the genera of the Rhopalocera, and pointed which of them were characteristic of the various regions and sub-regions into which the world had been divided by the zoologists and botanists above mentioned. He also exhibited specimens typical of these regions and sub-regions. The President then alluded to the prosperous condition of the Society, and to the increase in its numbers and income. Reference was also made to various Fellows of the Society and other entomologists who had died during the year, special mention being made of Herr H. T. Christoph, Mr. J. Jenner-Weir, Dr. F. Buchanan White, M. Lucien F. Lethierry, Pastor Wallengren, Dr. Jacob Swanberg, Major-General Carden, Dr. Hearder, and Mr. Wellman.—A vote of thanks to the President and other officers of the Society having been passed, Mr. Elwes, Mr. McLachlan, Mr. H. Goss, and Canon Fowler replied, and the proceedings terminated.

Royal Meteorological Society, January 16.—Mr. R. Inwards, President, in the chair.—The Council, in their report, reviewed the work done by the Society during the past year, and also stated that additional accommodation had been provided to meet the growing needs of the library. Forty-five new Fellows had been elected during the year. Mr. Inwards, in his presidential address, dealt with the subject of "weather fallacies," which he treated under the head of saints-day fallacies, sun and moon fallacies, and those concerning animals and plants. He also referred to the almanac makers, weather prophets and impostors, who have from time to time furnished the world with fit materials for its credence or its ridicule.—Mr. C. Harding read a paper on the gale of December 21-22, 1894, over the British Isles. This storm was one of exceptional severity, especially over the northern portions of England and Ireland and in the south of Scotland. It developed energy very quickly, and travelled with great rapidity. The self-recording anemometers show that the greatest violence of the wind occurred at Fleetwood, where the velocity was 107 miles in the hour between 8.30 and 9.30 a.m. on the 22nd; and for four consecutive hours the velocity exceeded 100 miles. This is the greatest force of wind ever recorded in the British Isles, and is 10 miles an hour in excess of the highest wind velocity in the great storm of November 16-20, 1893. At Holyhead the wind in squalls attained the hourly velocity of 150 miles between 10 a.m. and noon on the 22nd. The strongest force was mostly from the north-westward. Much destruction was wrought both on sea and land, and there was a heavy loss of life.

## PARIS.

Academy of Sciences, January 14.—On a method of verification, applicable to the calculation of series in astronomical problems, by M. Poincaré.—On autumn cultivations for green manures, by M. P. P. Dehérain. The author insists on the importance of autumn cultivations for subsequent digging in, for two main reasons: (1) nitrates are retained by the roots of growing plants, which would otherwise be lost in the drainage waters; (2) if buried at the proper time, the decomposition of the vegetable matter affords a considerable amount of useful fertilisation.—Experimental researches on the critical point of

liquids holding solid substances in solution, by M. Kaoul &c. From the results obtained, it appears that either solid bodies become gaseous and mix with other gases at temperatures below their points of fusion and under considerable partial pressures of their own vapours, or the solid bodies present are dissolved in droplets momentarily formed in many places in the mass of gas above the critical temperature of the solvent. In the latter case, a solid deposit should be formed on superheating the vapours. This point has to be investigated.—The treatment of vines, infested by phylloxera, with peat-moss impregnated with a mineral oil, by M. J. de Meij. Details are given of a process which appears to effectually clear the pest without injuring vegetation.—On a method of drawing a right line by the aid of jointed links, by M. Kaoul &c.—M. J. Janssen called the attention of the Academy to the contents and scope of the *Annales du Bureau des Longitudes*.—A letter from the *Annalen der Naturforschenden Vereinigung* was read inviting the Academy to send delegates to Innsbruck, to take part in a meeting for the consideration of the problem of investigating the variation of the intensity of gravity with the geological character of the crust of the earth.—On the application to differential equations of methods analogous to those of Galois, by M. Jules Drach.—On the determination of the equations of continuous finite groups, by M. E. Vissiot.—On the law of transmission of energy between the source and the conductor, in the case of a permanent current, by M. Vaschy.—On the production of cathode rays, by M. Joseph de Kowalski. (1) The production of the so-called cathode rays does not depend on the discharge from metallic electrodes across a rarefied gas. (2) They are produced chiefly where the primary illumination attains a considerable intensity; that is, where the density of the current lines is very considerable. (3) Their direction of propagation is that of the current lines at the place where the rays are produced, from the negative to the positive poles.—On the *entraine*ment of laminae waves by matter in motion, by M. G. L. Lecomte.—On some properties of silver sulphide, by M. A. Ditté. The double sulphides,  $4Ag_2S \cdot K_2S \cdot 2H_2O$  and  $5Ag_2S \cdot Na_2S \cdot 2H_2O$ , are described, and a method for their preparation is given.—On the preparation of amorphous silicon, by M. Vigoroux. The preparation is carried out by heating to about 540° a perfectly dry mixture of silica, magnesium, and magnesia. The silicon, by the usual treatment with acids, is obtained as a pulverulent, maroon-coloured substance.—On the polymorphic state: sulphides of zinc and manganese, by M. A. Vuibert.—On some sensitive reactions of amino-benzoic acids, by M. Oelsner de Comack.—On a class of nitriles, by M. Albert Colson.—On the constitution of hexamethylenetetramine, by MM. R. Cambier and A. Brochet.—On ethylene methylal, by M. Louis Henry.—New researches on pectase and on the pectic fermentation, by MM. G. Bertrand and A. Maheve. Pectase exists in solution in the cellular sap of acid fruits, just as in certain roots. There is no insoluble pectate. In acid fruit, the pectate is only apparent after neutralisation.—On the influence exercised by the nervous system and the internal pectate on histolysis. Facts illustrating the acceleration of normal glycolysis and sugar diabetes. A note by M. M. Lecomte.—The Pleistocene of the valley of Chambéry, by MM. E. Lhuillier and J. Vivien.—Remains of striped teryria from the granary of Bagottes-de-Bigotte (Hautes-Pyrenées), by M. Edouard Harb.—On the quantity phosphates from the rocks of U.S., by M. Charles Depéret.—An automatic method of giving electrical indications and automatic orientation, by M. Joseph Chard.

BRITISH

Physiological Society, December 21, 1894. Prof. du Bois-Reymond, President, in the chair.—Prof. Waldeyer gave a lengthy account of the most recent researches on the formative structure of the nervous system, laying special stress on the following points.—The entire nervous system consists of single fibres, which may most conveniently be called "neurites," each of which is composed of a nerve cell and its process. These processes are, on the one hand, "polyplasmic neurites," which rapidly become branched, until on the other end they "resorb" or "axons," which give off collateral branches and become medullated, and end in the branching, as do the collateral axons. Each neurite has only one "axon." The neurite conveys impulses from the cell, the neurites of axons convey impulses from the cell. All neurites, both dendritic and neuritic, end freely in fine

branchings. Every physiological path of conduction, whether from the periphery to the central nervous system, or *vice versa*, consists of two or more neurones, never of one. Conduction in the neurones is always longitudinal. Impulses are transmitted from one neuron to the other only by means of the free endings of the terminal branches. The lecture was illustrated by a series of schematic diagrams and some preparations.

BOOKS, PAMPHLETS, and SERIALS RECEIVED.

Books.—L'Industrie des Aracéens: W. Wagner (St. Petersburg).—Summer Studies of Birds and Books: W. Warne Fowler (Macmillan).—Über de Bevruchtung der Blömen: J. MacLeod (Gent, Vuylsteke).—Leos-Work for Amateurs: H. Orford (Whittaker).—Steel Works Analysis: Prof. J. O. Arnold (Whittaker).—Handbook for Hertfordshire, Bedfordshire, and Huntingdonshire (Murray).—Calcareous Cements: G. R. Redgrave (Griffin).—An Elementary Text-Book of Metallurgy: Prof. A. H. Sexton (Griffin).—Electrical Engineering: W. Slingo and A. Brooker, new edition (Longmans).—A Popular Treatise on the Physiology of Plants: Dr. P. Sorauer, translated by Prof. Weiss (Longmans).—Whence Comes Man, from "Nature" or from "God"? A. J. Bell, new edition (Isbister).—Why does Man Exist? A. J. Bell, new edition (Isbister).—A Collection of Appliances and Apparatus for the Prevention of Accidents in Factories, 2nd edition (Dulau).—Elektrophysiologie: Prof. W. Biedermann, Erste Abthg. (Jena, Fischer).—Allgemeine Physiologie: Dr. Max Verworn (Jena, Fischer).—Manuals of Elementary Science: Zoology: Prof. A. Newton, new edition (S.P.C.K.).—Manuals of Health: Air, Water, and Disinfectants: Dr. C. M. Atkman (S.P.C.K.).

PAMPHLETS.—Elementary Practical Chemistry: J. T. Hewitt and F. G. Pope (Whittaker).—Latent Heat of Steam and Absolute Zero: W. Donaldson (Waterlow).

SERIALS.—L'Anthropologie, tome v. No. 6 (Paris).—Quarterly Review, January (Murray).—Archives of Surgery, January (West).—Journal of Anatomy and Physiology, January (Griffin).—Botanische Jahrbücher, Neunzehnter Band, 4 Heft (Leipzig).—Royal Natural History, Part 15 (Warne).—Rendiconto dell'Accademia delle Scienze Fisiche e Matematiche, serie 2<sup>a</sup>, Vol. VIII, Fasc. 11, e 12 (Napoli).—Bulletin de la Société D'Anatomie de Paris, Nos. 5-7 (Paris).—Bulletins of the Royal Polytechnic Institute. No. 1: Physical Units: Prof. T. Gray (Terre Haute, Ind.).

CONTENTS.

PAGE

A Bad Method in Text-Books. By Prof. E. Ray Lankester, F.R.S. . . . . .	289
The Study of Rocks. By J. W. J. . . . .	290
Our Book Shelf:—	
Dubois: "Pithecanthropus Erectus, eine Menschen-ähnliche Uebergangsform aus Java."—R. L. . . . .	291
Gregory: "The Planet Earth. An Astronomical Introduction to Geography" . . . . .	291
Letters to the Editor:—	
The Hodgkins Prizes.—Prof. S. P. Langley . . . . .	292
The Artificial Spectrum Top.—Captain W. de W. Abney, C.B., F.R.S.; J. M. Finnegan and B. Moore . . . . .	292
The Kinetic Theory of Gases.—Prof. Arthur Schuster, F.R.S. . . . .	293
"Acquired Characters."—J. T. Cunningham; John Cleland . . . . .	293
Chinese Theories of the Origin of Amber.—Kumagusu Minakata . . . . .	294
<i>Rhyncholema terrestris</i> in Germany. H. Simroth . . . . .	294
The "Proceedings of the Chemical Society."—Prof. William Ramsay, F.R.S. . . . .	294
Philosophy and Natural Science.—David Wetterhan; The Reviewer . . . . .	295
Some Early Terrestrial Magnetic Discoveries pertaining to England. ( <i>Illustrated</i> ) By L. A. Bauer . . . . .	295
The Teaching University for London. By Dr. W. Palmer Wynne . . . . .	297
Notes . . . . .	298
Our Astronomical Column:—	
The Perseid Meteors . . . . .	301
Comet 1894 I, Denning, and Broisen's Comet . . . . .	302
Stars having Peculiar Spectra . . . . .	302
Nitrogen Fixation in Algæ. By Rudolf Beer . . . . .	302
The Commercial Synthesis of Illuminating Hydrocarbons. By Prof. Vivian B. Lewis . . . . .	303
Chemical Changes between Sea-Water and Oceanic Deposits. By Dr. John Murray and Robert Irvine . . . . .	304
Meteorological Work in Australia. By Sir C. Todd, K.C.M.G., F.R.S. . . . .	306
University and Educational Intelligence . . . . .	308
Societies and Academies . . . . .	308
Books, Pamphlets, and Serials Received . . . . .	312

THURSDAY, JANUARY 31, 1895.

## GEO-MORPHOLOGY.

*Lithogenesis der Gegenwart. Beobachtungen über die Bildung der Gesteine an der heutigen Erdoberfläche. Dritter Theil einer Einleitung in die Geologie als historische Wissenschaft.* By Johannes Walther. 8vo. pp. viii. + 535-1055. (Jena: G. Fischer, 1894.)

*Geotektonische Probleme.* By A. Rothpletz. 8vo. pp. 175. 107 figures, and 10 plates of sections. (Stuttgart: E. Schweizerbart, 1894.)

*Morphologie der Erdoberfläche.* By Dr. Albert Penck. Ratzel's "Bibliothek Geographischer Handbücher." 8vo. 2 vols. Vol. I. pp. xiv. + 171. 29 figures. Vol. II. pp. x. + 696. 38 figures. (Stuttgart: J. Engelmann, 1894.)

RECENT discussions in England as to the relations between geology and geography have only served to show that these sciences are so intimately associated that no satisfactory line of demarcation can be drawn between the two. These three works illustrate the extent to which this view has been accepted in the schools of Germany and Austria, and the valuable results to both sciences that follow from a due recognition of the fact. The three works agree in this, though they are very different in their aims and subject-matter. The first is a manual on rock-formation; the second, a monograph on one type of earth-movements; and the third, a systematic text-book of structural geography. One is a restatement of the principles of correlation, another a protest against speculation, and the other a compilation of the classifications of, and theories respecting, the different geographical forms. They have, however, so much in common in their methods, that they may be conveniently noticed together.

Prof. Walther's work goes even further. It shows not only the inseparability of geology and geography, but the need of a knowledge of biology for the correct application of the evidence of palæontology to stratigraphy. Since the days of William Smith, the evidence of fossils has been regarded as final in both historical and stratigraphical geology. It is therefore rather startling to find a geologist stating that the history of the earth could have been written from the structure of the rocks alone, without the assistance of the organic remains within them. It has been the rule, in the determination of the age of any particular bed, to accept only the evidence of the fossils as valid. So long as the method of correlation by the proportions of species and genera common to two horizons, was confined to comparatively simple areas, it gave fairly trustworthy results. But when extended beyond Britain and the North European plain, it was the cause of serious confusion. The classification of the very variable Cainozoic deposits of the Mediterranean basin were involved by it in chaos; it caused beds in Australia to be assigned to the highest instead of the lowest division of the Cainozoic, and led to limestones in the West Indies, probably formed in part within the historic period, being referred by high authorities to the Miocene. Even in such a simple

sequence as that of England, the method led to errors, as, e.g., in the exaggeration of the gaps in the geological record, such as that between the Chalk and the Lower London Tertiaries. Occasionally a warning against the neglect of lithology would be uttered, as by Godwin Austen and Sorby, or an effort made to use it. But the former were ignored; and the latter were not at first judicious, as in the case of the famous generalisation, that we are still living in the age of the Chalk, a suggestion about as useful as that we are still living in the Silurian, because sandbanks were formed then and are forming now.

For the recognition of the necessity for the limitation of palæontology, we have in the main to thank biology. Taxonomy—the study of distribution—has shown that age is only one of many conditions that govern the character of a fauna; the depth, the composition of the sea-floor, the distribution of the ocean currents, the proximity of different bathymetrical zones, all exercise an influence. Thus a fauna is often more allied to an extinct one, than to those which are living simultaneously in adjoining areas. Taxonomy has exercised its influence in two ways. In the first place, it has insisted on the proper recognition of the self-evident fact that deposits change in space as well as time: that a sandstone, e.g., may change into a clay laterally as well as vertically. Thus it is now recognised that the dividing line between the Gault and the Upper Greensand is a varying lithological one, and that the latter formation in one area was formed at the same time as Gault was being laid down in another. In the second place, it has led to the adoption of more detailed, zonal stratigraphy, and the demonstration thereby, that adjacent beds of different composition, and containing different faunas, have often been deposited simultaneously in stratigraphical continuity.

These views have gradually worked their way into general recognition by geologists, but Walther's is probably the first text-book in which they have been adequately expressed. The inconvenience in map-making, and still more in map-reading, which they involve, has led, perhaps, to an unconscious bias against them. Hence, even when theoretically admitted, their guidance has not been accepted practically. Walther's "Geologie als historische Wissenschaft" is, however, saturated with the results of biological teaching, the influence of which we may trace in nearly every page of the "Lithogenesis." Though well skilled in palæontology, he does not attach an exaggerated importance to the evidence of this science, but seems even to tend to the other extreme: if he does not underrate its value, he at least protests that it is less indispensable than has been thought. In his ardour for lithology, he goes so far as to say (p. 538) that "if we had an exact phenomenology of rocks, we could, without fossils, from the rocks alone, read the history of the earth." Walther's work is an effort toward such a "phenomenology," by an exposition of the lines along which it may be attained. He defines (p. 537) the objects of lithogeny "as the elucidation of the development of the fossil rocks by the investigation of rock-forming processes now in operation." He urges that rocks should be studied from the same point of view as animals and plants. He thinks that in comparative lithology, ontogeny should hold the

same place as it does in comparative morphology. This lithology he divides into three sections, equivalent to those adopted in biology. Thus, he says that the study of rock structure answers to comparative anatomy, the development of rocks now in process of formation to embryology, and petrography and stratigraphy to paleontology. Throughout the book he introduces biological terms and phylogenetic trees to emphasise his views. For example, he classifies rocks as homologous and analogous; as the former, he includes all those which are formed in the same "Facies-bezirke," and as the latter, those which are formed under different geographical climates. And climate, in the sense of this later-day lithology, is "the sum of all the meteorological and oceanographic conditions, including organic and inorganic processes," which affect the formation of a rock. The use, however, of these terms often appears of doubtful value; thus, when he states that the lavas of an oceanic island are only homologous with those of a continent, we doubt whether we are in any way better for the information.

The work is divided into three parts, entitled, respectively, "General Lithogeny," "the existing Facies-bezirke," and "the bases of Comparative Lithology." The first of these occupies fourteen chapters: it begins with an account of the destruction, deposition, and alteration of rocks. The destructive processes he divides into four classes: weathering, chemical, physical, and organic; ablation, both of ice and rock surfaces; transport; and corrosion. The last he restricts to the comparatively insignificant polishing action of loose material carried about by the wind, rivers, ice, or sea. According to Walther's scheme, denudation results from ablation, transport, and corrosion; he attributes it to four agencies, viz. the wind acting by "deflation," running water by "erosion," glacier ice by "exaration," and the sea by "abrasion." The second part of the book is the longest: each chapter is devoted to the description of a group of deposits, which he says are "homologous," as they are formed in the same "facies-bezirke" or geographical zone. Thus, on the continents there is the zone of the Polar Regions, with moraines, humus, ochre, &c.; the temperate zone, with its black earth, loess, &c.; the desert girdle, with its sand and salt deserts, and dried-up lake-basins; and the tropical zone, with its laterite and cotton soil, &c. Other groups of homologous rocks are the products of continental volcanoes, shore deposits and those of open seas, of oceanic abysses; coral reefs, and volcanic islands. Very obvious objections to this classification could be easily raised, and it certainly could not be recommended for the purposes of ordinary teaching; but as long as it is used only to illustrate the association of deposits, formed under any particular set of geographical conditions, it is extremely useful. The different subjects treated in the work are, moreover, brought well up to date. Thus, e.g., in the account of the supposed non-secreting organism *Gil- lonella*, the latest botanical researches of Molisch are summarised, and its character left more doubtful than ever. The chapter on coral-reefs is especially well done. The sketch of the life of a reef (pp. 915-927), which he calls the "richest of bionomi assemblages," is the best we know. The definition (p. 909) of a coral

reef as being essentially formed of branching corals, with calcareous sediment filling the interspaces, expresses a truth which is often overlooked. Even this is enlarged on another page, where it is stated that geologically a reef must be regarded as including not only the calcareous sediment on the surface, but that which is formed around it, to the depth of as much as 3000 metres. He illustrates the slopes around coral islands by the numerical method, due to Dietrich, which brings out clearly the differences between such atolls as those of the Bahamas and Keeling Island. The mean figures which he gives do not, however, teach much. It is interesting, therefore, considering that the coral island question is handled with full knowledge of all the latest information, and that the author's own investigations took place upon a region to which Darwin's theory was never intended to apply, to notice that he accepts that theory as substantially correct. It is surprising, considering the accuracy of the rest of the chapter, that a recent photograph of a *Pectinia quadrata* is again quoted (p. 899) as a *Manicina arcolata*.

The third section of the work is that which enunciates the general conclusions. It contains short chapters on the correlation of facies, the equivalence of rocks, the changes in the facies of deposits, and the lithological significance of organisms. This part of the book is, however, the least satisfactory; perhaps because most useful originality had been expected in it. Variations from the ordinary method of treatment and overstrained analogies had been passed in the hope that they would be turned to some account. This part of the book is, however, so general in its treatment, that the conclusions are rather indefinite. Nevertheless, the work is throughout so novel in treatment, so up to date in its information, that this cannot seriously impair its value.

Rothpletz's "Geotektonische Probleme" is a very different work from either of the others. Its title is a little misleading; one might expect from it an account of earth-movements in general, and a discussion of the theories of earth-structure by which these may be explained. One is, therefore, a little startled at finding that it commences with a protest against theories, and a warning against the danger of ideas creeping into general acceptance, under cover of a convenient term. He points out, for example, that Suess's term of "horst" for a mountain mass formed of one block of material, is so useful in descriptive geology, that it has been widely adopted. Rothpletz fears, therefore, that Suess's theory of the origin of "horsts," and its corollary that horizontal beds are never uplifted, may be unconsciously accepted. Similarly he foresees that, by the adoption of other convenient terms, the whole heresy of "Suessism" may gradually work its way into a position of influence it would never attain by its merits. The perils of geological progress threatened by this insidious "hypothesis building phantasy," as Rothpletz calls it, he thinks can only be averted by the critic, whose duty it is to bring all hypotheses to the test of facts. And the author sets himself to perform this task. His volume is devoted to the class of earth-movements known as "overthrusts." When cases of the inversion and repetition of strata were first noticed, they were regarded as due to the folding of the beds. During recent years, many of these have been



shown to be due to the thrusting of one set of beds on to another, either horizontally or at a low angle. Rothpletz shows that these overthrusts are even wider in their distribution than is now generally admitted. He describes the most important cases, summarises the literature and various theories regarding them, and states the explanation which seems to him to agree best with the facts. Most of the examples quoted, the author has personally examined.

The first case taken is that of the classical Linth in the Glarus. This, as interpreted by Escher and Heim, has exercised a great influence on geological thought. The valley has previously been regarded as due to a great double fold. Rothpletz, however, maintains that it is a "graben" or rift-valley, formed by the subsidence of the block of material which once filled it up. One difficulty that hitherto told against this explanation, was the fact that the marginal faults had never been discovered. Rothpletz, however, maintains that they are there; he describes them at one point, in a section which, he declares (p. 10), "must silence the most utterly sceptical." The denial of Heim's famous double fold necessitates a new interpretation of other features in the geology of the country. Thus the rocks in the Schild—the mountain to the west of the town of Glarus—have been explained by Heim as the crushed-out beds of the middle limb of the fold. Rothpletz, however, maintains and his evidence seems conclusive—that they are due to an overthrust. He adds a further difficulty to Heim's theory, by showing that if true it is inadequate as it stands. The country is more complex than a double fold can explain; a treble and a quadruple fold at least must be assumed, for the beds repeat themselves more than thrice. This Rothpletz explains by the assumption of three overthrusts which he names after Schild, Kapf, and Plattenalp.

The next case considered is that of the mountain mass of Sentis, to the north of the Glarus area. This was described by Escher von der Linth in 1857. It was then said to be remarkable in having a great series of faults crossing the axes of the folds, but none parallel to them. This was confirmed by the maps and memoirs of Escher's pupils, and Suess, therefore, in 1885, made the Sentis the type of a class of mountain structure named "Blatter." Some discrepancies between the descriptions and the maps led Rothpletz to re-examine the country. The result is that he finds numerous faults parallel to the ridges, as well as across them, and also a series of overthrusts which occurred later than the folding, and earlier than the transverse faults.

From the Sentis it is natural to turn to the Juras. This range has long been famous owing to the ingenious devices designed to enable the fold theory to account for the rock sequences that occur there. But the "vanishing trick" diagrams, by which the absence of certain beds has been explained, have always been viewed with suspicion; they seemed too much like the schemes by which Ptolemaic astronomy was reconciled with facts. Müller in 1860 demonstrated their insufficiency, but they still survive. Rothpletz discusses this fold theory in its three most plausible modifications, viz. the faulting of over-folds; the folding of an area after the rocks in the centre have been raised by a double fault; lateral contraction forcing one side of a valley of erosion

over on to the other. Rothpletz dismisses these, and accepts the theory of overthrusts along slightly inclined thrust-planes.

The fifth case is that of the highlands of the north-west of Scotland. This is so well known, that the author adds nothing new, except a doubt as to the relation of the minor and major thrusts. He notes with relief the abandonment of the view at first announced that the thrust-planes started as a result of the inversion of over-folds.

A simple example of overthrusting in a much later geological period is afforded by the granite of Lausitz in Saxony, which occurs above the Turonian limestones. This superposition was explained at first by the chalk having been deposited under an overhanging cliff, and then by the granite having been dropped as an erratic. Both these theories were ridiculously inadequate. The most popular explanation assigned an eruptive origin to the granite; the absence of contact-alterations and of apophyses from the granite is fatal to this. Overthrusting is the only theory left, and this Rothpletz accepts as satisfactory. The earth-movements in the coal-fields of Westphalia, Belgium, and northern France are next considered: these have long been known to be extremely complex. The explanation now accepted, is summarised with great lucidity, and illustrated by over thirty figures and three plates of sections. It attributes the present structure of the country to the intrusts of slices of complex composition between other deposits. The last case considered is that of the area of the coast of Provence and the French Alps. The author has not personally examined the ground, and so would have preferred not to discuss it. Haug, however, has suggested that the assumed "pli-failles" or fold-faults) are often only inverse faults, and that the latter are capable of explaining the phenomena without the hypothetical folds. Rothpletz, therefore, thinks it advisable to discontinue the use of the word "pli-faille," and suggests the substitution of "faulle de recouvrement," or some other term which does not beg the question.

In the concluding chapter, Rothpletz summarises the general characters of overthrusts. He remarks that their importance is being more widely recognised, and that they are accepted now in explanation of many phenomena for which the agency of folding was formerly invoked. He thinks that they probably always occur in mountain formation. He discusses their relations to the earth-movements with which they are associated, as far as our present knowledge enables these to be generalised. Thus, the thrust-planes occur approximately parallel to the folds, but the inclination of the planes is usually in the opposite direction to that of the mountains: this might have been expected, as it is in harmony with some of Daubree's experiments. Divergences between the strike of folds and overthrusts, however, occur, and are explicable by the later origin of the latter. The inclination of thrust-planes is almost always different from that of the beds or folds; the former, however, both above and below the thrust-plane, occur in their normal sequence. Friction breccias, mylonites, &c., occur along the thrust-plane, while "schleppung," or terminal curvature of the beds toward the plane, is generally developed. A single thrust-plane may occur; but, as a rule, there are many parallel

to one another, and this results in the type named by Suess the "Schuppen-structure." The chapter concludes by a consideration of the classification of earth-movements, and its difficulties; that advanced by Suess, he recognises as the most important, but he does not admit it as at all satisfactory.

This shyness of classifications is in striking contrast to the attitude of the last work, in which all the types of "earth-forms" are classified in a detail, and with a terminology, which seems at first needlessly elaborate. The work is a systematic account of the orography or structural geography of the earth, and is quite unlike any existing text-book. It has taken more than ten years to prepare. The delay has been partly due to the enormous amount of literature that has had to be considered, but also to the fact that during this period two works have appeared which have completely changed the whole aspect of geographical science. These are Richthofen's "Führer für Forschungs-reisende," and Suess' "Antlitz der Erde." The former introduced a more scientific classification of "earth-forms" or geographic types, while the latter has revolutionised our ideas as to how those earth-forms have been developed. One of the great advantages of Prof. Penck's work is that it is a re-description of the earth's surface in the terminology and in accordance with the views of these two leaders of geographical thought. It is a book which it is impossible to summarise. It is a compilation showing on every page the most detailed care and accuracy. No one acquainted with Prof. Penck's previous writings will be surprised at his extensive knowledge of the literature of both geography and physical geology. The numerous historical summaries that occur in it, show how thoroughly the author has ransacked literature, and how well the book has been brought up to date. Works published so late in 1894 as that containing Heim's description of the Pleistocene earth-movements in the Alps ("Die Entstehung der Alpenen Rand-seen"), and Gunther's memoir on the influence of atmospheric pressure on isostasy, are included. It is only natural that English literature is not so thoroughly done as the German, but important omissions are surprisingly few. The two most important are probably the absence of reference to Whymper's work on meroids, from the chapter on altitude determination, and to C. Reid's explanation of the formation of the chalk coombes, from the discussion of the origin of dry valleys.

The work is divided into three parts, dealing respectively with general morphology, the surface of the earth, and the sea. Its plan is based on the conception of the earth's surface as composed of a series of "earth-forms" which range between the extremes of mountains and valleys. The description and classification of these, and the study of their origin and development, form the subject-matter of geographical morphology. This science, therefore, depends on the literature of geodesy, geology, and geography. The book commences with an outline of general morphology, which depends in the main on the first of these. The chapters on mathematical geography, and on morphography and morphometry, are probably the most valuable of the five devoted to this part of the subject. In these he states the latest conclusions upon various debated problems. He points out

(p. 9) that the amount to which the form of the earth deviates from an ellipsoid of revolution is between  $\pm 200$  and  $\pm 250$  m. He discusses the relative value of the various geoids, and expresses a preference for Northern Europe, for Bessel's instead of Clarke's, which is used in England. The principles of earth-measurement are briefly considered; the standard levels used in different countries are tabulated, and their relations to each other shown. The value and method of construction of hydrographic, klinographic, hypsoklinographic, and bathygraphic curves are shown. The difficulties in the determination of altitudes caused by the uncertainties of refraction are pointed out. The inevitable inaccuracy of map lines is illustrated by a list of the lengths assigned to a portion of the Istrian coast in a series of standard maps; the figures range from 105 km. to 233.81 km. The calculation of the volumes of continents is considered, and finally elaborate tables given of geographical statistics. The ratio of land to water is taken as 2.54 (p. 97); the principal previous estimates are given from the time of Riccioli, who in 1661 estimated that the land was in excess in the proportion of 8 to 5. An interesting sketch of the literature on "geographical homologues" shows how early attention was drawn to the remarkable parallels and contrasts in the distribution of land and water. This part of the work concludes with the consideration of the question of the permanence of oceans and continents. Penck quotes Cayeux as if this author's investigations proved the terrigenous origin of all the chalk, and though he notices Blanford's arguments, he does not seem to appreciate their full significance. His sketch of the literature of the subject shows that, though with some striking exceptions, the difference on this question has been one between geologists on one side, and geographers on the other. In this connection it is interesting to note that Penck accepts (p. 107) the view that the ocean floors have a higher specific gravity than the continents, and places the difference, according to Helmer's work, at .001 of the specific gravity.

The second part of the book describes the surface of the earth, or the "Landoberfläche." The first section of this deals with the composition of the earth's crust, and the forces that act upon it. The figures given to illustrate Suess' terms are very clear and instructive; the table of geological systems is, however, out of date; the Ordovician is not accepted, and the Tertiary and Quaternary are each regarded as equal to such divisions as the Trias and Permian. The account of the agents of denudation is very detailed and thorough. The hydraulics of river action (pp. 259-385) is treated with especial care, and the references to the literature of the subject include a much wider range than is usual. The controversy as to Bael's law of the influence of the earth's rotation on the direction of rivers is clearly summarised, and the truth of the law upheld; great stress is laid upon the deepening of the Rhine on its left bank in the regulated portions of its course. The author attributes to glaciers considerable erosive power; he maintains that the characteristic feature in erosion by ice, is that the excavations vary in depth with the strength of the rocks, so that true rock basins are formed (p. 409). He still accepts the glacial origin of enques, and even approves of Ramsay's views of the origin of some of the Alpine

lakes. The description of the existing "earth-forms," or geographic types, occupies the first 460 pages of the second volume. These "earth-forms" are divided into eight types—plains, heaped-up mounds, such as moraines and dunes, valleys and the highlands through which they run, basins, mountains, areas of subsidence, and finally fissures and caves. The characters, classification, method of formation and terminology, including both local and scientific names, are stated in detail. A sketch of the literature of each type is also given. The chapters on "Wannen" or basins, and on mountains, are probably the best. The book closes with an account of the oceans, and the deposits on their floors.

The one serious drawback to this book is its complete neglect of the evidence of zoological distribution. Thus, for example, the questions of the origin of the Caspian Sea and the lakes of Nicaragua, are fully considered, but no reference is made to their faunas. No theory, however, could be accepted which failed to account for the anomalous characters of these. But it would be too much to expect Prof. Penck to show the same mastery of the literature of biology as he does of geography and geology. In this respect, Walther's book is superior to that of Penck. But it is idle to estimate their respective merits, for the three works are so different. One cannot compare Walther's statements of the principles of correlation with Rothpletz's detailed mapping, and either with Penck's digest of literature. Penck's, however, will probably prove the most generally useful of the three. An English translation would be of great service, by calling attention to a branch of geography that has been unaccountably neglected in this country. Thus, in the Geographical Society's "Hints to Travellers," instead of the details of Richthofen's "Fuhrer," the subject is not even mentioned. A translation would, moreover, necessitate greater precision in the definition of geographical terms, and the introduction of many new ones, for which there are now no equivalents in English, and which are essential to the scientific treatment of geography.

J. W. GREGORY.

#### ORGANIC CHEMISTRY.

*The Rise and Development of Organic Chemistry.* By Carl Schorlemmer, LL.D., F.R.S. Revised edition, edited by Arthur Smithells, B.Sc., Professor of Chemistry in the Yorkshire College, Leeds. London: Macmillan and Co., 1894.)

FOR some time this excellent historical survey of the development of organic chemistry has been out of print, and students of chemistry will heartily welcome the appearance of a second edition, which has been extended, in order to include a review of the more important results of the original investigation of the last ten to fifteen years.

Facing the title-page is an exceedingly good likeness of Schorlemmer, admirably reproduced from a photograph: then follows a short biographical notice, giving a brief sketch of the author's career, in which his brilliant researches are described. This is a very welcome addition to the book, because, as the editor points out, Schorlemmer, with characteristic modesty, mentions

these researches only on two occasions in the book (pp. 141 and 197), and then but very briefly.

Chapters i. to v. are very much the same as in the first edition, only a few slight alterations having been made. Chapter vi. deals with the perfection of the methods of organic analysis by Liebig, and these important researches, which affected in such a marked manner the subsequent development of organic chemistry, are perhaps scarcely discussed at sufficient length; a more detailed account of the history of organic analysis is to be found in Roscoe and Schorlemmer's "Treatise of Chemistry" vol. iii. p. 40). This chapter vi. also contains a short sketch of the work which led to the discovery by Raoult of his well-known method of determining the molecular weight known as the cryoscopic method.

Chapters vii. and viii. have not been much altered, but chapter ix., which deals with the constitution of benzene, tautomerism, and the asymmetric carbon atom, has, as was to be expected, been largely added to, and made to embrace most of the important results of recent work.

The constitution of benzene is dealt with in a very interesting manner. Baeyer's researches, on succino-succinic ester, which led to the rejection of Ladenburg's prism formula, are discussed, as well as those of Bamberger, on the reduction of naphthalene derivatives, the results of which may be said to have completely confirmed Baeyer's views.

After a short description of Laar's tautomeric hypothesis, the remainder of the chapter is taken up with Le Bel and van't Hoff's theory of the asymmetric carbon atom, and with Wislicenus' development of this theory. In a future edition, more emphasis might, perhaps, with advantage be laid on the general applicability of these theories, so that the student may not receive the impression that they have only been found valuable in the explanation of isolated cases, as, for example, the isomerism of the malic and tartaric acids, and of fumaric and maleic acids.

The first part of chapter x. is devoted, principally, to the history of organic synthesis, and contains an account of Frankland and Duppa's work on aceto-acetic ester, and of Conrad's researches on malonic ester, showing the value of these ethereal salts in synthetical work. The synthesis of malic, tartaric, and citric acid is also mentioned.

A very valuable historical sketch of the chemistry of the sugars, including a clear exposition of the more important results of E. Fischer's classical researches, followed by an account of Ladenburg's synthesis of coniine, and of the synthesis of uric acid, by Horbaczewski, concludes this excellent chapter.

The remainder of the book does not differ materially from the first edition, except that a very good index of authors' names and subjects has been added.

Students of organic chemistry must always be interested in the development of the science, and to them this work will be cordially welcome. It is a thoroughly readable book, written throughout in an attractive manner, and comprising in one small volume all the facts necessary for understanding the growth of organic chemistry.

Schorlemmer wrote, whenever possible, in German,

and never had any real facility in writing English. The editor is, therefore, to be congratulated on the very satisfactory manner in which he has performed the difficult task of preparing this book for the press. Great care has evidently been taken in reading the proof-sheets, as we have only noticed one or two unimportant misprints.

#### OUR BOOK SHELF.

*British Birds: Coloured Illustrations of all the Species of Passerine Birds resident in the British Isles, with some Notes in reference to their Plumage.* By Claude W. Wyatt. 210. Pp. iv, 25. London: William Wesley and Son, 1894.

THE author is a well-known ornithologist, who has made two expeditions, of which the results have been published—one to the Peninsula of Sinai, and the other to the Magdalena Valley in Colombia—and these proved that he was not only a good collector, but also a keen field-naturalist. He then travelled extensively, and visited many parts of the globe, observing the habits of birds, and making sketches of every kind of scenery. The latter became a great feature in the plates of the "Monograph of the Swallows (Hirundinidae)," which he brought out in conjunction with Dr. Bowdler Sharpe, who contributed the letterpress of the work, while Mr. Wyatt drew all the plates.

The present volume is the first of two which the author proposes to publish, the one before us dealing merely with the resident Passerines of the British Islands, while the second is to contain figures of all the migratory Passerines, the Picarian birds, the birds of prey, and the pigeons; but the game birds, waders, and swimming birds will be, presumably, treated of at a future period. Fifty species are illustrated by Mr. Wyatt in his first volume, and occupy twenty-five plates. As with his pictures of the swallows, the author makes a great feature of his accessories, and some of the landscapes are very pretty, and are evidently drawn from nature. The attitudes of the birds are life-like, and some of them are exceptionally good, the crows alone striking us as failing in massiveness of bill. The letterpress is of the simplest, and would have been all the better for more complete references to standard works, as many of those given are incorrectly quoted. It is, however, more as an artist than as a writer that Mr. Wyatt shines, and he is to be congratulated on having produced a very handsome volume, with beautifully coloured pictures of some of our most familiar favourites. As regards quality of paper, printing, colouring, and binding, there is nothing left to be desired.

*Standard Methods in Physics and Electricity Criticised, and a List of Further Methods Proposed.* By H. A. Sauer. (Published by the Author, 1894.)

FROM the title and table of contents of this work, one would expect to find a treatise on experimental physics. This expectation, however, is entirely dispelled when one commences to read the letterpress. After a very brief description of the construction of a voltmeter, which the author has devised (see *Nature*, July 12, 1894), more than a hundred pages are devoted to what presumably the author considers an exhaustive examination of the different uses to which this instrument may be put. The fact that his *Wattmeter* has considerable resistance, causes the author considerable trouble, but he consoles himself with the reflection that his *Wattmeter* or other *Wattmeter* generally has a resistance of from 100 to 1000 ohms. The difficulties encountered in measuring a quantity of

electricity by copper or silver deposition are dwelt upon, and a new objection is raised, namely, that since the deposits have to be weighed, variations in gravity will affect the results! At another part of the book the ordinary balance is considered devoid of sufficient accuracy, since the arms have generally different lengths, and Nicholson's hydrometer is recommended as a substitute when great accuracy is desired. In a chapter on sound, the author strongly recommends bicycle-wheels as a motive power. Apparently the cycle-wheels are to set themselves in motion, since the idea of driving any piece of machinery "by hand" is derided, and the great waste which takes place when water and other motors are used, is dwelt upon as a reason for their abandonment. One has met with the library steps which can be converted into half a dozen other articles of furniture; but these old friends sink into complete insignificance when compared with this gas voltameter and the numerous uses claimed for it, such as blowing soap-bubbles full of oxygen and hydrogen, which on being exploded can be used as fog-horns; supplying oxygen to aeronauts, or to explorers in coal-pits after an explosion; and preparing chlorine. It can also, we are told, be used as a barometer, pyknometer, ice calorimeter, dilatometer, thermostat, hygrometer, anemometer, level, or for exhausting incandescent lamp bulbs. The above are a few of the uses claimed, and are extracted from what the author describes as not an "exhaustive list!"

W. W.

*Electrical Engineering, for Electric Light Artisans and Students.* By W. Slingo and A. Brooker. Pp. 740. New and revised edition. London: Longmans, Green, and Co., 1895.

AN admirable work, covering the whole field of electric lighting. Though designed to include those branches of the subject prescribed in the syllabus issued by the City and Guilds Technical Institute, its scope is such as "to make it embrace the requirements, not only of those actually employed in the electric lighting industry, but also of those who, while having little or no electrical knowledge, have under their supervision various kinds of electrical machinery." The book is not merely a descriptive catalogue of electrical machinery, like some that we know, but a clearly-written, and amply-illustrated, volume which has proved of great service to engineers during the past five years, and, in its revised form, is sure to hold its own in the future.

*Lens-Work for Amateurs.* By Henry Orford. Pp. 231. (London: Whittaker and Co., 1895.)

A LENS is defined in this volume as "a portion of a refracting medium . . . bounded by two spherical surfaces which have a common axis." In the following paragraph, lenses with one of their surfaces plane, are described; wherefore we would ask Mr. Orford, why he did not include these in his definition: This, however, is but a detail. As a whole, the book is a trustworthy guide to the manufacture of lenses, suitable alike for the amateur and the young workman. It is profusely, though rather coarsely, illustrated by diagrams, and the instructions are simple and practical.

*Manual of Practical Morbid Anatomy.* By H. D. Rolleston, M.A., M.D., F.R.C.P., and A. A. Kanthack, M.D., F.R.C.P. Pp. 240. (Cambridge: University Press, 1894.)

A PRACTICAL handbook for the post-mortem room, showing how to carry out a systematic examination of a body, and indicating what morbid changes should be looked for.

LETTERS TO THE EDITOR.

*{The Editor does not hold himself responsible for opinions expressed by his correspondents. Neither can he undertake to return, or to correspond with the writers of, rejected manuscripts intended for this or any other part of NATURE. No notice is taken of anonymous communications.}*

A New Step in Statistical Science.

CONTRIBUTIONS of an abstract kind to statistical science are so little read by the bulk of statisticians, that the scope of the remarkable memoir by Prof. Karl Pearson may be unappreciated by them unless attention is pointedly directed to it.<sup>1</sup>

Statisticians are conversant with the use of curves to epitomise masses of data. The forms of the majority of these curves are skewed or humped, and have hitherto been non-descript, except as Prof. K. Pearson's previous memoir showed, some of them may be dissected into two or more normal curves, having different constants. It is only a few curves that are symmetrical and conform closely to the normal law of facility of error. These few have been much studied, the numerous and valuable properties of the normal curve being extremely helpful in dealing with them. When the conformity between the observations and the normal law ceases to be close, the latter must be applied warily. When the discrepancy is serious, it becomes unsafe to trust the theory at all. Not a few statisticians have chafed under these limitations, and felt that the normal law is too limited in its grasp to satisfy their needs. Now at length, it turns out, thanks to Prof. K. Pearson, that the normal law admits of being regarded as nothing more than a very special case of a highly generalised theory, by whose aid curves may be drawn that shall fit every one of the observed curves he has tried as yet. The shapes of these are curiously varied. Their list includes the dimensions of shrimps and prawns, of American recruits and of school-girls, of Bavarian skulls, of frequency of enteric fever, and of divorcees, of variation in house value, in butter-cups and in clover, in pauper percentages and in a mortality curve. Only those who have studied the delicate and oddly-shaped drawings of these observed curves on a large scale, upon which the equally delicate fitted curves have been superimposed, can adequately appreciate the wonderful closeness between the pairs of outlines. There can be no doubt that the descriptive efficiency of Prof. Karl Pearson's method is of the highest order.

The question of the utility of the method to ordinary statisticians has now to be considered. First, as to its descriptive powers. We are already able to describe the whole of any normal series by means of only two numbers; say, by the average of all the members of the series, and by the mean of the several departures of its individual members from that average. Henceforth, by the use of more constants, we shall be able to do the same to any series. A few figures will always serve as the equivalents of a vast amount of tabular matter.

The second and higher use is to afford a clue to the cause or causes of variety. It has long been a dream to me to select a peculiar and often recurring form of curve, and to study with all possible care the conditions under which it has been produced, so that whenever a new curve of that same form was met with, there should exist some guidance towards discovering the cause of its production. I have made not a few attempts from time to time, but was discouraged by the then impossibility of sufficiently defining the curves that were dealt with. That difficulty seems now removed. To explain myself further, let us suppose that a man finds the mark of a more or less incomplete circle on the ground, and wishes to discover how it was made. Various possibilities exist, which might have been recorded to help him: (1) The mark may have been made by a basin, &c., turned in a lathe, or, what come to the same thing in principle, by something revolving round a fixed centre. (2) It may have been stamped by a hoop, formed by bending an elastic rod until its ends met, the circular form depending on the equal distribution of stress. (3) It may have been the mark of a withy that had bound a faggot, which, after setting into shape, had broken away, the circular form arising from the compression of the sticks of the faggot within the smallest possible girth. (4) It may have been

the mark of a warped sheet of bark, hide, &c., the circular form of which depended on the unequal contraction of its outer and inner layers. (5) It could have been made by a projecting nail, near the angle formed by two straight rods securely joined at one end; the apparatus being caused to straddle and press upon two pegs in the ground, and moved in the only way possible under those conditions. Here the fragment of a circle would be due to the constancy of the angle subtended by the same chord. A catalogue of these and other possibilities, which are numerous and include circular forms of animal and vegetable growth, would certainly enlarge the speculations of the observer as to the cause of the circular mark. So it would be with the curves of which I spoke. Each form of curve would be a serious study in itself; still the results would gradually accumulate, and it is reasonable to look forward to a time when a set of such curves, each defined by Prof. K. Pearson's method, shall have been studied.

I venture upon one criticism as to the completeness of his generalisation. Variation of the normal kind is supposed to be due to the combined effect of (1) an infinite number of causes, that are (2) equally likely to err in excess or deficiency, and (3) that are independent of one another. These three restrictions are removed in the generalised curve, which bears a certain relation to the binomial point curve formed by the expansion of  $(p + q)^n$  when (1)  $n$  need not be infinite, (2)  $p$  need not be equal to  $q$ , while (3) the binomial form which implies independence of the contributory causes, is modified. Now though the condition (3) is removed, it does not, as yet seem to me that the supposition which replaces it, and which is based on such considerations as the effect of withdrawing  $r$  cards from a pack of  $n$  cards containing  $s$  suits, is analogous to what commonly occurs in *verum natura*. Namely, the intermingling of contributory causes of various degrees of efficiency, some of which are very few in number and have large effects. Thus the number of persons who walk day by day down St. James' Street, is occasionally vastly augmented by some national spectacle, and it is considerably and irregularly affected by changes in the weather. It does not wholly depend on a multitude of equipotent causes. So again, the time of ripening of the fruit on a tree generally, is much affected by the aspects of the particular branches on which it grows. I therefore conclude that the effects of an aggregate of large and small causes, ought to be distinctly included in a thoroughly generalised formula of variation.

FRANCIS GALTON.

The Kinetic Theory of Gases.

I THINK sufficient stress has not been laid on the distinction between the *purely mathematical* proof of the fundamental determinantal relation connecting the differentials of the co-ordinates and momenta of dynamical systems and the *purely statistical* applications of that relation which form the subject of the Kinetic Theory.

The well-known determinantal equation is perfectly general and applicable to any dynamical system whatever. It merely asserts that if the initial coordinates and momenta receive any small independent variations whatever, the resulting variations in the final coordinates and momenta after any fixed interval of time are so related to them that the differential product of the former variations is equal to that of the latter, conformably to the well-known laws of Jacobians, by which the variables are changed in a multiple differential or integral.

In general the variations in question are *purely hypothetical*, just as, in the principle of Least Action, the actual motion is compared with varied motions which have no real existence. If, for example, we consider the system to be the Earth, the variations could only be made real by making the Earth move differently to what it actually moves, and doing this in every possible way.

But when it is required to assign any physical meaning to the determinantal relation, these hypothetically varied motions must be represented by actual motions, and this can only be done by taking an indefinitely large number of independent systems, all similar to the one we started with, and setting them moving in all possible ways. The determinantal relation then tells us that if the coordinates and momenta of these systems are initially distributed according to what in my Report I have called

<sup>1</sup> "Mathematical Contributions to the Theory of Evolution" (Part II.), by Karl Pearson. Read at the Royal Society, January 21, 1875.

the Boltzmann-Maxwell distribution, they will be so distributed at any subsequent instant. But in the absence of collisions or encounters between the system, this distribution will *not* be in place. There exist other distributions equally well satisfying the condition of permanence.

The case of two or more molecules of gas in the process of encounter can be deduced, as shown in my Report, § 30, by taking each "system" to represent a pair of molecules, there being at every instant an indefinitely large number of such pairs having different coordinates and momenta. It now seems definitely settled that if the molecules are rigid bodies, the only possible permanent distribution unaffected by encounters is the Boltzmann-Maxwell distribution combined with motions of pure translation and pure rotation of the mass of gas as a whole (Report, § 46).

Many writers have limited their investigations to the case where all the encounters are binary, and I see that Prof. Fitzgerald has emphasised this point in his recent letter. I do not think this is the right place to draw the line. I can see no difficulty in taking account of encounters between three, four, or more molecules, provided that such encounters are sufficiently numerous to have a law of distribution. Where the line must be drawn is indicated in my Report, § 30 (iii.). The molecules which act on one another in any one encounter must form an infinitesimal fraction of the whole mass of gas, or the gas must at any instant be divisible into an indefinitely large number of independent molecules and groups of molecules, each molecule or group thus constituting for the time being a free system by itself. When the molecules act on each other at all distances, or it is impossible to divide them into small independent groups, the whole "air theory" breaks down.

It is this limitation which, to my mind, precludes our applying the Kinetic Theory in its present state, *not only* to molecules moving about in a continuous medium, such as the ether may be, but *also* to solids and, probably, liquids.

A good deal of confusion has, I fear, arisen with regard to what I have called Maxwell's Law of Partition of Kinetic Energy, *i.e.*, the statement that "if the kinetic energy of a system be expressed as a sum of squares, the mean values of these squares are equal," from the fact that the term "*mean value*" may be taken to represent "time average for a single system"; in which case this may be the point Prof. Fitzgerald had in view when he has held that the conclusions would not apply to the Earth or a "finite number of particles moving about for an indefinitely long time." It cannot be too strongly emphasised that this interpretation of mean values involves assumptions which have hardly been sufficiently justified in any general class of cases, and which have been repeatedly proved to be invalid in simple cases (Report, §§ 9, 12).<sup>1</sup> To give a simple, if not quite analogous illustration: suppose that on drawing counters out of a bag, we were to obtain on the average an equal number of red, white, and green counters. We should *not* be justified in inferring that if we kept a single counter sufficiently long it would change colour and become in turn red, white, and green.

As an illustration of a case where the Boltzmann-Maxwell Law is applicable, consider a sphere of density  $\sigma$  moving in a perfect liquid of density  $\rho$ . The kinetic energies of the sphere and liquid are in the ratio of  $\sigma : \rho$ , as we know from hydrodynamics considerations, and the same is true for any number of spheres, widely instances apart, are very large compared with their radii. This is not a case where *no* transference of energy takes place between the sphere and liquid, and it is not therefore open to Prof. Fitzgerald's objection to the case I previously cited. Whenever the motion of the solid is varied, energy is transferred to or from the liquid.

If a *single* sphere were acted on by the requirements of physicists, then the Boltzmann-Maxwell Law is not untruly applicable to the ether. If not, then it is certainly beyond the scope of our investigation. The Kinetic Theory is obviously a theory intended to account for several of physical phenomena only, viz. the thermal properties of gases. If any observed phenomena are not deducible from the results of the theory, it is to be regarded sufficient to show that it is not because the fundamental assumptions of the theory are not applied, *i.e.*, that the general conclusions are *not* *not* *not* with the Kinetic Theory.

G. H. BRYAN.

Perthshire, Cambridge, January 21, 1895.

### Boltzmann's Minimum Function.

I SAID in my first letter on this subject that the condition A, on which, or its equivalent, the proof is based, could not apply to the reversed motion. As that assertion has been questioned, may I confirm it thus?

The initial distribution of R, the relative velocity, *i.e.*, the number of pairs of spheres for which it has given direction, is arbitrary—condition A is fulfilled. Then, as proved, whatever the initial distribution, after collisions, the distribution of R is uniform, *i.e.*, all directions equally probable. Now reverse the velocities. If condition A is fulfilled in the reversed motion, then after the reversed collisions the distribution of R is uniform. It is equally certain that it must be the same as the initial distribution.

If, therefore, condition A is fulfilled in the reverse motion as well as in the direct, that can only be because the distribution of R was uniform to begin with. But that means that

H was minimum to begin with, and therefore  $\frac{dH}{dt} = 0$  throughout.

Boltzmann's theorem can be applied to both motions only on condition that it has no effect in either.

1 New-square, Lincoln's Inn.

S. H. BURGURY.

### Electroscopes in Lecture.

I SUPPOSE teachers still use gold-leaf electroscopes for their junior lectures; certainly I have found nothing else so dead-beat, or so readily understood; and by projecting with a lens a shadow of the leaves on a square-foot translucent screen, the movements are perfectly visible to a large audience by daylight. But the one objection to the instrument, when used for explaining the fundamental facts, say, of induction, is that it indicates similarly positive and negative potentials. Yesterday, however, my assistant, Mr. E. E. Robinson, ingeniously stowed the metal-cased instrument on a cake of paraffin wax, and electrified its outside negatively. By this process the zero of deflection is changed; the leaves stand apart for zero potential, diverge more for positive, and collapse for negative. A zero shadow-pointer and rough scale may be readily used; and I propose now to mount a projection electroscope in a suitable slightly charged Leyden jar, whose outer coat can then be treated as the usual earthed terminal of the instrument, whose case is connected to or formed by the inner coat of the jar. The insulated or variable terminal is conveniently arranged as an insulated sphere or other shaped body on the lecture table, not far from the small screen, attached by a long enough thin wire to the leaves—of which it is perhaps best to have only one movable.

OLIVER J. LODGE.

January 25.

### The Perseid Meteors.

YOUR interesting reference (NATURE, January 24, p. 301) to Dr. Brechelin's investigation of the Perseid shower, induces me to offer one or two remarks on the subject. In the paragraph alluded to, it is stated that the radiant was observed from July 22 to September 12, 1893; but this long duration cannot possibly refer to the same system as that which furnishes the abundant maximum on August 10. It is true there are radiants in Perseus in September, and the succeeding months of October, November, and December supply many others, but, after the end of the third week in August, nothing is seen of the real Perseids. I cannot say exactly on how many nights the display continues active, but it is certainly visible from July 10 to August 18, and the diurnal motion of the radiant is about  $1^\circ$  to the E.N.E.

There are really very few of the true Perseids seen after August 12, for the shower dies rapidly away after the maximum. On August 15, 1893, during a watch of three hours, I saw only one Perseid. On August 16, 1893, during a watch of 4½ hours, I saw only four Perseids. I mention these facts to prove the extreme tenacity of the stream at the middle of August. But there are differences from year to year. An observer watching the Perseids at a similar interval on the same dates in succeeding years will get a varied experience. Thus one year cannot be regarded as the criterion of all.

Some years ago I recorded a few white-streak leaving meteors between August 19 and 24, from a radiant at  $78^\circ$   $56'$  on the northern border of Auriga, and supposed they might be late

Perseids, but subsequent observations have convinced me that they had no relation with the great August shower. They probably formed the early members of a well-defined radiant of September Aurigids which I found at  $76^{\circ} + 56^{\circ}$  in 1879, and at  $77^{\circ} + 57^{\circ}$  in 1885.

It appears to me that observations of the Perseids, and of other meteor showers, are often undertaken and discussed while losing sight of a most important circumstance. I refer to the necessity of thorough training on the part of the observer, before he can possibly hope to attain a high degree of precision in recording meteor paths. Many months, if not years, of diligent practice are required to render the observer proficient, and even then there are many students who, being deficient in natural aptitude, will never succeed in the work. It seems to be the fashion at certain observatories to set a number of observers (some of whom have perhaps never registered a meteor path before) watching and recording meteors, and then to investigate their results as though they could be thoroughly depended upon. Such results are, however, practically useless when employed to test any complicated point in meteoric astronomy. It is similar to placing a man, who has never played in a cricket match before, as wicket-keeper to fast bowlers like Mould, Richardson, and Woods, and expect his performance to be creditable! In meteoric astronomy, as in many other spheres of action, skill is only to be acquired by long practice; indeed, it is difficult to single out any other branch of observation where the eye and the judgment have to be so quickly and accurately brought into play to afford the best results.

W. F. DENNING.

Bristol, January 27.

**The Artificial Spectrum Top.**

IN the interesting letters on the above subject, which have recently appeared in NATURE, there does not seem to have been any reference to the experiments of Helmholtz, as described in his "Handbuch der Physiologischen Optik," 1866, § 23. He describes the facts in minute detail, and illustrates them with numerous diagrams.

One important point not yet referred to, and described in detail by Helmholtz, is that if a disc, marked with black and white sections, be rotated with a certain rapidity, the field appears to be covered with a pattern composed of hexagonal spots; at the part of the field of vision corresponding to the yellow spot, a transverse oval figure is seen. In the centre of this figure is a dark spot surrounded by a black circle.

Each of the hexagonal spots is dark with a lighter spot in the centre, and surrounded by a red thread, which appears to be moving in minute drops. The field seems to be pervaded by a greenish hue, which flows towards the yellow spot.

These experiments, which I have verified on every point, have a very important bearing on the photo-chemistry of the retina and on colour vision.

Hendon, January 26.

F. W. EDRIJGE-GREEN.

IN reference to your Belfast correspondents' interesting experiments with the artificial spectrum, which were long ago included in my own experiments, a little reflection will show that when the speed of rotation is increased, we do *not* retain unaltered the resultant proportion of stimulus and anti-stimulus on the retina. With a slow rotation we have simultaneously on the retina a persistence image of the lines and a real image of the white card. When the speed is greater, we get simultaneously these two, and in addition a persistence image of the white card. Hence, according to my theory, the rise in scale with increased rapidity of revolution.

Colchester, January 26.

CHARLES E. BENHAM.

**Snake Cannibalism.**

THE reading of a paragraph and a letter printed in the *Mail* for October 24 and 29, reminds me of a case of one snake swallowing another, the consequences of which I witnessed. While engaged in running a survey line for a railway across a wood in this district, I noticed a snake close to me, doing its best to get out of my way, but almost unable to do so. One of my men struck at its neck with his "machei," and succeeded in cutting the snake's head clean off. Immediately, to our great surprise, another snake of the same species slowly emerged head first, and, after a few struggles to escape, remained

motionless on the ground; a gash in its cranium, which had been cut by the same stroke that killed the larger snake, being, no doubt, the cause of death, as the body was otherwise intact. A measuring tape showed that the larger snake was 6 feet in length, and the smaller 5 feet. In this case the snake was swallowed tail first, and therefore it seems highly probable that the larger snake simply devoured it, and I did not commence by trying to dispute a portion of food, such as the pigeon and frog cited in other instances.

H. TSUNAGAI.

Sancti Spiritus, Cuba, November 23, 1894.

**More about Moths.**

(Communicated by Prof. S. Garman, of the Museum of Comparative Zoology, Cambridge, U.S.A.)

IN NATURE for December 6, 1894 (p. 127), Mr. Henry Cecil publishes a criticism on a previous letter of mine, which I cannot accept without a few words of remonstrance. His explanation may be correct in part, but it certainly does not cover all the ground.

That resistance alone is not necessary for the expansion of the wings of moths, may be inferred from the fact that they will often expand after an interval of several days, when the moths have been prematurely released, the irregularity in outline arising, I think, from the evaporation of moisture from the wings, and in the consequent loss of elasticity. If the newly-hatched insects are confined in a warm moist box, this trouble seems to be obviated in a large degree, and the wings occasionally attain to nearly the normal dimensions.

In raising moths artificially, it cannot be assumed that the lack of proper pressure is entirely responsible for the frequent occurrence of cripples.

All the conditions of feeding, moisture, and heat, must first be carefully considered, since departures from the normal, on any one of these lines, might so lower the vitality of the insect, that perfect development would become impossible.

The writer also speaks of the wings of the moth in the cocoon as "folded and crumpled," a statement which is entirely at variance with my own observations. In all the cases which I have noticed, the wings are perfectly smooth and unfolded from the first, the increase in size resulting from a true expansion, the nature of which has, so far as I know, never been fully explained.

L. C. JONES.

Melrose, Massachusetts.

**THE PHYSICAL SOCIETY'S ABSTRACTS OF PHYSICAL PAPERS FROM FOREIGN SOURCES.**

THE days when learning meant dead languages, and science meant collecting beetles, have passed away; science has grown and spread until it is impossible for the most comprehensive intellect to grasp more than a few twigs on its numerous branches. Organised specialisation has become necessary to scientific progress. Each subject now has its special society, and each society has as much as it can do. Every sort of time-saving arrangement is necessary if the workers in any one branch of knowledge are to be kept informed as to what others are doing.

English chemists have long been supplied by the Chemical Society with excellent abstracts of the current literature of their subject, but up to the present the only available work of the same kind on Physics has been the *Beiblatter of Wiedemann's Annalen*. Admirable as these are, it is impossible that a German periodical can fully meet the wants of Anglo-Saxon physicists. It is therefore most desirable that abstracts of physical papers should be published in English. The Physical Society has now set itself to supply this want, and the first number of the new volume of "Abstracts" appeared early in the present month. The *Proceedings* of the Society will in future be issued monthly, and the abstracts of foreign papers on physics will be included under the same cover. They will, however, be paged separately, so that they can be bound separately at the end of the

year, when full notices, both to the subjects and the names of authors, will be added. At present the *Proceedings* contain approximately fifty pages of original matter, and fifty pages of abstracts from foreign and American sources.

It is an open secret that it is intended to enlarge the abstracts later, so as to include English work. They will then be an epitome of the work done in physics throughout the world. The preparation of a large number of abstracts on all sorts of subjects involves a great deal of work and some organisation, and it is thus better to be content with abstracts of half the extent of those of the Chemical Society or the *Berichtletter* at first, at any rate. The financial risk is also very heavy for a society which is not rich, however energetic it may be. The British Association has come forward with a helping hand, and is aiding the Physical Society with a very considerable money grant.

Mr. Swinburne has undertaken the office of editor. He is assisted by a strong body of abstractors, many of whom are recognised authorities on their own subjects, and authors of well-known books on physics. In the January number there are abstracts of 114 papers, of which 25 are on General Physics, 22 on Light, 12 on Heat, 1 on Sound, 34 on Electricity and Magnetism, and 19 on Chemical Physics. The price to non-members of the Society is two shillings and sixpence; but as the cost for a year at this rate exceeds the subscription to the Society, it is probable that the number of members will increase for this, if for no other reason. It is hoped that this will be so. Many branches of physics, unlike chemistry and electricity, have no great industry behind them. It is therefore necessary that all who care for the study of pure physics should rally to the support of the Physical Society in its new undertaking. The meetings of the Society are now held in Burlington House, in rooms hospitably put at its disposal by the Chemical Society. They are held at five o'clock on Fridays, so that persons who may come to town to attend them, can afterwards go on to the Royal Institution. If an author so desires, the publication of his paper will not be delayed for reading. Copies of the paper are circulated before the meeting, so that the discussion can begin early and with adequate knowledge. As soon as a paper has been read, an abstract and a short account of the discussion is published in *Nature*, in the *Lecturion*, and other journals. The paper itself is also communicated to the *Philosophical Magazine*, and is published with an abstract of the discussion in the Society's *Proceedings*.

### THE NATURAL HISTORY OF THE SOLWAY.

ALMOST all corners of the British Islands have been so thoroughly investigated by naturalists and collectors, that I may be excused for directing attention to one which seems to have been somewhat overlooked—the southern shore of Kirkcudbrightshire and Wigtownshire. I, at least, do not know of any work which has been done there of late years. The Solway itself, so far as I know, has received no attention at all—its shallow, character not offering much attraction to the student of marine zoology.

Yet the surrounding district is in other respects than its natural history, an extremely interesting one—very fertile and beautiful in its scenery, secluded and quiet, and out of the usual track of tourists, with many picturesque and ruinous relics of a bygone time, bounding a stream and lochs suited both to the naturalist and the artist, and associated in innumerable ways, at least, of the Walter Scott's finest work, "*The Monks of Melrose*," and "*The Red Rover*," to say nothing of the "*Widow's*" of a

more recent author, Mr. Crockett. It is, moreover, easily accessible, and I suppose it is probably due to the lack of hotels and other tourist accommodation that it is so little known except to residents in the immediate neighbourhood.

The bit of the district best known to me extends from the estuary of the Nith—separating Dumfriesshire from Kirkcudbrightshire—on the east, to the Water of Fleet, which empties itself into Wigtown Bay, on the west. This coast-line is of very diversified character, flat and sandy eastward, where it has behind it a large tract of marsh-land, the haunt of innumerable wild fowl, but rising eastward into precipitous cliffs of sandstone and limestone, which form in some places isolated pillars of considerable height, and in others are hollowed out into caverns, some of which are locally associated with the name of Scott's piratical hero, Dirk Hatteraick. Some of the streams—notably the Water of Urr—come down through a background of granitic hills, bringing with them a vast amount of fine detritus which is deposited on the sides of their estuaries and in the Solway itself, round about their mouths. In such cases the natural result is a very flat shore, composed of soft muddy sand, stretching out very far seaward, and at low water uncovered for stretches of many miles—a state of things not unlike that which is found in the more familiar Morecambe Bay at Grange-over-Sands. These muddy expanses, when left by the tide, are seen to be covered with the contorted mounds thrown up by innumerable lug-worms, and so closely packed are these that there is rarely a space of more than a few inches untenanted by its worm. They form, in fact, quite a conspicuous feature in photographs taken under these conditions, and I do not doubt that the worms themselves, passing through their bodies so much mud laden with decomposing organic matter, which they thus absorb and assimilate, contribute materially to the sanitary purification of what would otherwise become a reeking, pestiferous swamp. Beyond these lug-worms, I am unable to say anything about the larger mud-inhabiting fauna of the district. I thought it very likely that *Echinocardium cordatum* and, perhaps, *Synapta* might be found, as they are in some similar localities in the Firth of Clyde, but the little time which I spent in digging for them did not suffice to disclose any specimens; nor have I had any opportunity of dredging in the Solway Firth. The water is shallow, and the bottom uniformly sandy. I think it would be sure to yield interesting microzoa belonging to such groups as Copepoda and Ostracoda; perhaps also Cumacea and Mysida, but the absence of cast-up debris on the shore, either of the larger Crustacea or Mollusca, seems to indicate a dearth of those creatures outside. The littoral zone being chiefly of the flat sandy or muddy character already described, there is not, except in certain restricted areas, much opportunity for shore-hunting of the ordinary kind. But, away from the "sphere of influence" of the estuarine mud, there occur occasional patches of inter-tidal rock with promising-looking pools; these are, however, fearfully storm-swept, and incapable of affording sufficiently secure attachment for many adherent animals. A few common Hydrozoa, such as *Sestularia* and *Campularia*, a few patches of "*Hydratula*" and Ascidians were, I think, with *Alcyonidium gelatinosum*, about all that I noticed. Among swimming things were, however, many Amphipoda and Copepoda, and I took also several specimens of *Mysis Lamorna*. But my most interesting captures were made by washing the muddy deposit found on the bottoms of some rock-pools, and by netting amongst the weeds of pools situated above ordinary high water-mark, though still subject to occasional tidal influx. The Copepoda found in such pools will be described elsewhere, but it may be noted here that in some of the inland peaty pools and ditches



of the neighbourhood occurred an interesting Ostracod, *Cyclocypris globosa*; and in the White Loch, a species still more interesting and more capricious in its distribution, *Darwinula Stevensoni*.

As regards the botany of the district, I can say very little. My last two visits were made about midsummer, and at that time the sea banks were gorgeous with masses of thrift and red cranesbill (*Geranium sanguineum*), the marshy flats with golden fields of water-flag, the fells with thickets of *Rosa spinosissima* and numerous orchids, the most conspicuous of which was the sweet-scented species, *Gymnadenia conopsea*. These, of course, are all flowers which cannot be overlooked, and are an ever-present delight to the eye and mind: less alluring species, which need to be hunted for, were for the most part passed unnoticed, and such as I did gather were of no particular interest.

G. STEWARDSON BRADY.

#### PROFESSOR ARTHUR CAYLEY, F.R.S.

MATHEMATICAL science has suffered a grievous loss by the death of Prof. Cayley, which occurred on Saturday last, at Cambridge. There is hardly a branch of pure mathematics which is not indebted to him for original contributions of the highest value, while the important problems which have been elucidated by him are so numerous, and cover so wide a field, that he was certainly one of the greatest mathematicians which the world has ever known.

It was in September 1885, when Cayley was President of the British Association, that he was ranked among our "Scientific Worthies," Dr. G. Salmon being his biographer. We refrain, therefore, from giving a long notice of his life, and content ourselves with a brief sketch of his scientific work.

Cayley was born August 16, 1821, at Richmond, Surrey. At a very early age he showed great liking and aptitude for arithmetical calculations. He entered King's College School, London, at the age of fourteen, and three years later went to Cambridge, where he entered Trinity College. In 1842 he came out as Senior Wrangler and First Smith's Prizeman. Sir George Stokes had been Senior Wrangler in the previous year, and the late Prof. Adams obtained the distinction in 1843.

While still an undergraduate, Cayley commenced his career of mathematical publication by a paper in the *Cambridge Mathematical Journal* for 1841, but it was not until 1852 that he addressed a memoir to the Royal Society, of which he was elected a Fellow in the same year. Very soon after taking his degree at Cambridge, he entered the legal profession, and was called to the Bar in 1849. But during his career as a barrister, he was constant to his first love, mathematics, and it was while in legal practice that some of his most brilliant mathematical discoveries were made. In 1863, after fourteen years of chamber life in Lincoln's Inn, he returned to Cambridge to fill the newly-instituted Sadlerian Professorship of Mathematics, and no one could have been better fitted than he to discharge the duties of the holder of the chair, viz. "to explain and teach the principles of pure mathematics, and to apply himself to the advancement of the science."

With regard to Cayley as an original investigator, his special merit has been described by Mr. Glaisher, who termed him "the greatest living master of algebra." It is difficult to select the work for which he will be the best remembered, but Prof. Salmon defined it as "his creation of an entirely new branch of mathematics by his discovery of the theory of invariants, which has given quite a new aspect to several departments of mathematics . . . And the effect has been that the knowledge which mathematicians now possess of the structure of algebraic forms is as different from what it

was before Cayley's time as the knowledge of the human body possessed by one who has dissected it and knows its internal structure is different from that of one who has only seen it from the outside."

Among the honours which Cayley received, may be mentioned the Royal Medal of the Royal Society, awarded to him in 1859, and the Copley Medal in 1882. He was a correspondent in the section of Astronomy of the Paris Academy of Sciences, and was a Fellow or Foreign Member of many other societies and academies, both at home and abroad. He was given the honorary degrees of D.C.L. by the University of Oxford in 1864, and the LL.D. by Dublin University in the following year. Later, the University of Edinburgh conferred upon him a similar honour, and he received the degree of Sc.D. from his own University. The Universities of Leyden, Göttingen, and Bologna also conferred upon him the degree of Ph.D. In 1890, the President of the French Republic made him an officer of the Legion of Honour. This distinction was granted in consequence of a request addressed to the French Minister of Foreign Affairs by the President and other members of the Academy of Sciences.

Cayley's mathematical papers, commencing in the year 1841, have appeared in every periodical mathematical publication of importance in Europe and America. In the year 1887 he undertook the work of editing the series of ten quarto volumes, in which the Syndics of the Cambridge University Press are publishing his collected mathematical papers. The publication of these volumes commenced in 1889, and six of the volumes were reviewed in these columns a year ago (*NATURE*, January 18, 1894). The number of papers which appear in the six volumes is 416. Altogether seven volumes have as yet appeared. As Cayley is responsible for 724 titles in the Royal Society Catalogue down to 1883, and he has since produced a considerable amount of mathematical work, it seems improbable that ten volumes will be sufficient to contain the results of his prodigious activity and enormous literary industry.

What more need be said about this great master of mathematics? He sacrificed prospects of advancement in the law in order to follow the mathematical work to which he was devoted. He had the power to teach, and the ability to extend the boundaries of knowledge. He was "as distinguished for the amount and universality of his reading as for his power of original work." Truly, his memory will "outlive the life of dust and breath."

The funeral service will take place in the Chapel of Trinity College to-morrow (Friday). Lord Kelvin will be present to represent the Royal Society, and other men of science will probably attend to do honour to the memory of their brilliant fellow-worker.

#### NOTES.

WE are enabled to state that the communication to the Royal Society on "Argon, a new Constituent of Air," by Lord Rayleigh and Prof. Ramsay, to be given at the Royal Society to-day, will refer to the density of nitrogen from various sources; to methods for removing free nitrogen from air; to the separation of argon from air by diffusion; to the density of argon; to its spectrum (on which a short paper will be read by Mr. Crookes); and to its behaviour at low temperatures. It is interesting to note that Prof. Olszewski, of Cracow, has liquefied and solidified the gas, and will communicate a short paper on the subject. The solubility in water is also recorded. Various attempts to induce chemical combination are described, and general conclusions are drawn in a final section. The ratio of its specific heats shows it to be a monatomic gas, and proves that its atomic weight is approximately 40. The meeting will not be held in the apartments of the Royal Society, but in the theatre of the University of London.

THE metric system of weights and measures is to be introduced into Tunis on March 1.

DR. JOHN H. S. has resigned the Directorship of the Lick Observatory on account of ill-health.

DR. L. K. O., Professor of Physiology in the University of Marburg, has just died. He carried out a number of important researches in physiological and pathological chemistry.

SIR JAMES COCKLI, who held the post of Chief Justice of Greenland from 1862 to 1879, died on Monday, at the age of seventy-six. He was elected a Fellow of the Royal Society in June 1865.

PROF. LEWIS R. GILLES, of the College of Charleston, South Carolina, U.S.A., whose death occurred towards the end of last year, was born August 14, 1810. He was a Professor in the above-mentioned College for more than fifty years, from 1838 to 1892; at first as Professor of Mathematics, afterwards of Astronomy, Chemistry and Physics. Prof. Gilles published a number of articles on astronomy, natural history, &c., in various journals and in the publications of scientific societies.

It will be remembered by our electrical readers, that at the contest organised by the City of Paris in 1889 for the best electric meter, Prof. Elhu Thomson was awarded the prize of five thousand francs. Desiring that this sum should serve for the development of the theoretical knowledge of electricity, Prof. Thomson arranged to offer a prize for the best work on one of four important questions in electricity. The papers had to be sent in by the middle of September 1893, but the decision of the Committee organised to adjudicate upon them has only lately been made known. Four memoirs were received, one written in German, one in French, and two in English. It was decided that each of the two memoirs in English deserved the prize. One was by Dr. A. Webster, of the Clark University, Worcester, U.S.A., the subject being "An experimental determination of the period of electric oscillations." The subject of the other memoir was "An examination of the absolute accuracy of the formula for calculating the period of free oscillation of a discharge condenser under circumstances such that the resistance of the circuit has no appreciable disturbing effect." This memoir dealt practically with a determination of " $\pi$ " by a method of free oscillations, and the authors were Prof. O. Lange and Mr. P. T. Glazebrook. Ultimately it was decided to award a prize of five thousand francs for each of these papers, the money for the purpose having been collected. The collection of the additional money caused the delay in the publication of the decision of the Committee.

THE scarcity of hay often been expressed that corn or at least grass could be profitably cultivated on the high plateaux of Norway. Dr. Hurs Borch, the Director of the Norwegian Geological Survey, has lately, however, in a recent publication, that the soil which in question, was nearly all scraped away during the Ice Age, and that cultivation could not now be carried on with any hope of success.

THE Royal Photographic Society, which became incorporated in January 1 in this year, have determined that the Society shall hereafter consist of Executive Members and Fellows. In future, no members will be admitted to the fellowship until they have given the Council a satisfactory proof of the possession of them of suitable publications for the title L.R.P.S., which in this way will become a guarantee of ability on the part of its holder in either scientific or artistic photography.

During the past week, snow has fallen over all parts of the British Islands; in Scotland and the north of Ireland the amount has been large, and even in the Channel Islands a

depth of six inches was recorded. Very sharp frosts have also been experienced in all parts, and for some days the thermometer in places has not risen above the freezing point. The following low readings have been notified to the Meteorological Office: 5° at Llandoverly, on the 20th; 2° at Hillington (Norfolk), and 11° at Yarmouth, on the 27th; and 9° at Loughborough, on the 29th January. At Haparanda, in the Gulf of Bothnia, a temperature of - 24° was recorded on January 26 and 29, and over Europe generally the weather was very cold, frost and snow occurring as far south as Nice and Biarritz. A dense fog occurred in London on the afternoon of January 29.

THE twenty-fifth anniversary of the transfer of the telegraph to the State in the United Kingdom was celebrated on Monday, by a banquet at the Hotel Metropole, under the presidency of the Postmaster-General, Mr. Arnold Morley. The very remarkable developments of telegraphy during the last quarter of a century is shown by some statistical information furnished to the guests. The telegrams have risen from 6,830,000 to 71,465,000, the mileage of line from 14,776 to 32,881, the mileage of wire from 53,430 to 205,334, the instruments in use from 670 to 8500, the number of words per minute capable of being transmitted on the fastest form of instrument from 70 to 600, and the offices from 2932 to 9637.

ON Wednesday, February 6, the Hon. T. F. Bayard, United States Ambassador, will distribute the prizes to evening students of the People's Palace, Mile End Road, E.

THE following are the names of the candidates who passed the recent examination of the Institute of Chemistry:—A. E. Bell, C. S. Ellis, Dr. M. O. Forster, J. Lones, G. H. Russell, W. H. Soleau, W. L. Sutton, and W. G. Young.

ON Thursday afternoon, February 14, Mr. L. Fletcher, F.R.S., Keeper of Minerals at the British Museum, will begin a course of three lectures at the Royal Institution on Meteorites. The Friday evening discourse on February 8 will be delivered by Dr. G. Sims Woodhead, his subject being "The Anti-toxin Serum Treatment of Diphtheria."

IN accordance with the scheme recommended by the Royal Commission, telegraphic and telephonic communication has been established by the Post Office authorities in connection with the Liverpool life-boat service and look-out stations, and also at various points on the Welsh coast.

ACCORDING to the Paris correspondent of the *Lancet*, a survey of the statistics hitherto published in divers countries of the results of the application of Behring and Koix's method in the treatment of diphtheria up to the last day of December 1904, gives a total of 2700 cases with 433 deaths, or a mortality of 16 per cent.

A GENERAL meeting of the members of the Federated Institution of Mining Engineers will be held on Tuesday, February 12, at 10.30 a.m., in the Examination Hall of the Mason Science College, Birmingham. Arrangements have been made for visits to collieries, &c., on the following day.

THE third series of lectures arranged by the Sunday Lecture Society begins next Sunday afternoon, in St. George's Hall, Langham Place, at 4 p.m., when Mr. A. South Woodward will lecture on "The Restoration of Extinct Animals." Lectures will subsequently be given by Dr. R. D. Roberts, Prof. Henry I. Armstrong, F.R.S., Mr. C. T. Whitmell, Dr. C. W. Kimmis, Mr. Douglas Carnegie, and Mr. W. Mayhew Heller.

THE twenty-second annual dinner of the old students of the Royal School of Mines took place on Friday evening, at the Criterion Restaurant, under the presidency of Mr. W. H. Greenwood. A large number of guests were present, among

them being General F. T. Lloyd, Mr. Jeremiah Head, Prof. J. W. Judd, Prof. Roberts-Austen, Mr. H. A. Wiggin, Mr. E. Matthey, Prof. W. A. Tilden, Prof. A. W. Rücker, Prof. G. B. Howes, Mr. W. Gowland, Dr. W. P. Wynne, Prof. C. V. Boys, Prof. J. B. Farmer, and Prof. A. R. Huntington.

THE following arrangements have been made for lectures at the Royal Victoria Hall, Waterloo Bridge Road, S.E., during February: Sir Colin Scott Moncrieff on "Egypt and the Nile"; Mr. Smith Woodward on "A Visit to Russia"; Dr. J. Norman Collie on "The Alps around Mont Blanc"; Prof. Ramsay, F.R.S., on "Some New Discoveries about the Air." This lecture will have special reference to the investigations by Lord Rayleigh and Prof. Ramsay, which resulted in the discovery of a new constituent of the atmosphere.

THE twenty-first general meeting of the Association for the Improvement of Geometrical Teaching was held at University College on January 19, Dr. R. Wormell, the President, in the chair. The report of the Council, proposing the continuation of the *Mathematical Gazette*, and the Treasurer's report were read and adopted. Dr. Larmor, of St. John's College, Cambridge, was elected President in the place of Dr. Wormell, who retires; the other members of the Council, including the hon. secs., R. Holmes (The Avenue, St. Margaret's, Twickenham) and C. Pendlebury (53 Gunterstone Road, West Kensington), were re-elected. After the elections, Mr. E. M. Langley gave some geometrical notes, and Mr. G. E. Heppel read a paper on "Algebra in Schools." After an adjournment, Dr. Larmor took the chair, and papers were read by Rev. C. Taylor ("The A. I. G. T. Syllabus of Geometrical Conics") and Rev. J. J. Milne ("The Conics of Apollonius"), and Prof. Lodge gave some notes on Mensuration. Interesting discussions followed these. All communications with respect to the *Mathematical Gazette* should be addressed to the Editor, 16, Adelaide Square, Bedford.

COLONEL A. T. FRASER, writing to us from Bagdad, says that while travelling lately on the right bank of the Euphrates, he noticed a pair of caves near the usual black woollen cloth tent lived in by the Arabs, and found that, as evening drew in, a number of cows were driven down, and the caves shut with plugs of straw and thorns. "It was evident," he says, "that this must have been the primary use to which those early types of man of the flint and bronze ages, about whom we know so little, put the so-called cave dwellings, that of sepulture being an after-thought. One would imagine, reasoning hastily, that cows and Arabs should have more properly changed places. But the Arabs bring the experience of thousands of years to bear on this question, and prefer the free air to a confined atmosphere suitable only to ruminant beasts, and tents to caves. Having alluvial soil to deal with, the Arabs in this instance dug pits about four feet deep, and domed over the top with brushwood and straw to complete the caves, the whole showing but little above the surface. There was no need of permanence, as encampments shift with the seasons. Under other circumstances the old "cave" races would have dug the entire cavity out of the solid, but still put in their cattle, and remain outside themselves."

FOR some classes of observations involving the use of a spectroscope, the movement of either collimator or observing telescope is objectionable, and for such work it becomes necessary to rotate the prism in order to bring different parts of the spectrum into the field of view. If the condition of minimum deviation be of no importance, as in the case of Mr. Tutton's apparatus for obtaining monochromatic illumination, there is no objection to turning the prism in this way, but if the condition of minimum deviation for the central ray in the

field is to be retained, some special device is essential. This has already been accomplished in various more or less elaborate ways, but Mr. F. L. O. Walsworth has now indicated a means of satisfying this condition very simply (*Astronomy and Astrophysics*, December 1894). The general solution of the problem is effected by the introduction of a mirror into some part of the spectroscopic train between the slit and the focal plane of the observing lens, the mirror having an angular movement equal to one half the change in angular motion of the ray refracted at minimum deviation. The mirror may be disposed in several ways, but that finally adopted for use with the spectro-bolometer is to place it in continuation of the back face of the prism. With this arrangement the emergent ray is parallel to the incident one, so that a direct vision spectroscope is obtained by the use of a single prism. The prism and mirror are together mounted on the graduated circle of the spectrometer, and by making the axis of rotation of the system coincident with the intersection of the plane bisecting the refracting angle of the prism and the plane of the mirror, there is no lateral displacement of the ray at minimum deviation. The idea seems to be an excellent one, and capable of wide application.

THAT gales have a considerable effect upon the heights of tides is very well known. The gale of January 23, furnished an example of this at the East India Dock. According to a letter in the *Times*, high water was due at the Dock at 12:46 a.m. on January 24. At ten o'clock on the previous evening, however, the tide had risen three inches above Trinity datum, and then fell 5 feet 4 inches to midnight. It again rose five inches to 1 a.m., when it went away altogether. The phenomena suggest that, probably, the records of self-registering tide gauges, when discussed in connection with high winds and cyclones, will furnish useful results. Prof. Cleveland Abbe notes in the *Monthly Weather Review* that, during a hurricane at Charleston last September, the excess of the actual over the normal high water mark increased gradually until it reached more than five feet. In this connection some observations on the indication of distant storms by tides are of interest. Captain E. Jones, who for many years kept logs of deep-water voyages of Lieutenant Maury, states that, previous to a cyclonic storm which occurred early in September, he noticed that at low water the tide did not fall near as low as under ordinary conditions, and he came to the conclusion that a cyclone was approaching, as he had noticed before that under these conditions such storms are very certain to make their appearance. He testifies "that this abnormal condition is an infallible indication of a storm approaching or passing by. A storm directly in from seaward generally affects the flood tide even more than a low water tide, but in the present case the high water was about normal. A long experience gives me great confidence in the barometer as affording valuable prognostication of a storm, but this tidal wave along the coast preceding a cyclone must, as it seems to me, give absolute proof that some kind of storm is in progress; the astonishing thing is that the ocean level is affected by the cyclone at such a great distance, and especially ahead of it."

IN the *American Engineer* for January, Prof. H. A. Hazen gives some of the results of a very interesting balloon ascent made in the "Svea" at Stockholm, by S. A. André. The account is taken from the *Proceedings* of the Swedish Academy, vol. 20, part ii., No. 3. The balloon travelled for 136 miles east over the Baltic, the highest point reached being 9900 feet, and at the time of the ascent, Stockholm was nearly in the centre of a high barometric area; this fact, in connection with the position of the balloon over a wide expanse of water, adds great interest to the observations. The diminution of temperature with height, allowing for increasing heat during the day, was

about 1 in 270 feet, in the first 4000 feet, which is noteworthy, as the sea surface causes less diminution with height. Above 4700 feet, clouds were encountered, and these changed the rate of diminution, while at the highest point, the result was 1 in 100 feet. The most interesting feature is the great dryness of the air above 7500 feet; at 6000 feet the relative humidity was 100 per cent., and at 1800 feet higher it was only 4 per cent. Prof. Hazen states that this is the most extraordinary fall in humidity ever observed, and it shows how little we really know of atmospheric conditions, even at very low heights. The value of the results to be obtained by balloon ascents in determining the laws of storms is beyond doubt, and Prof. Hazen strongly advocates that such researches should be undertaken.

The origin of the Alpine Serpentine has always been a subject for wide differences of opinion. The Italian school of geologists until lately upheld the view that they were metamorphic sedimentary rocks, while English and German geologists maintain their intrusive nature. One of the latest contributions to this subject comes from Dr. Ernst Weinschenk who, in the *Abhandlungen* of the Bavarian Academy of Sciences (Munich, 1894) describes the occurrence and petrography of the serpentines of the Great Venediger, a mountain in the Eastern Alps of North Tyrol. He finds that they are undoubtedly intrusive rocks, formed by the consolidation of a peridotite magma that was squeezed in between the foliation-planes of the neighbouring mica-schists during the great Alpine earth-movements. They thus occur as a series of laccolites (*linsen*), which, we may observe, resemble in their origin those of Shropshire rather than the typical laccolites of the Henry Mountains, which were intruded into horizontal strata. After their first consolidation, the peridotites were crushed by the continuation of the earth-movements, and by the continued action of superheated vapours and solutions were gradually converted into their present condition. The evidence of these changes is seen in the minute structure of the rocks, which, as well as the nature of the metamorphism they have produced in the surrounding schists, is exhaustively described in the paper, and illustrated by a number of microphotographs.

A 1894th paper, by the same author, deals with the gneiss and granite of the same part of the Alps. These have also been studied by Prof. Leal, whose results are published in the *Procesos de la Academia de Ciencias* (Vienna, 1894). This author treats the rocks from a structural point of view, and his memoir is illustrated by a map and several sections; while Dr. Weinschenk describes the petrography in detail. Both authors assert the undoubtedly intrusive origin of these rocks, and incline to class them with the pre-carboniferous "Protogine" of the Western Alps. Dr. Weinschenk regards certain peculiarities in the granite as due to lateral pressure during the period of contraction, and proposes the term *Pleocrystallization* for the development of structures under such conditions.

The elasticity of solid gelatine solutions is the subject of an investigation by Erwin Frax, in *Wiedemann's Annalen*. Sticks of aqueous gelatine were obtained in the following manner. Brass tubes, about a foot long and half an inch thick, were cut in two at the centre and joined by wire rings. They were closed at one end with a cork, and were placed vertically. The gelatine solutions were then poured in, care being taken to prevent adhesion by rubbing with olive oil. The suspension of the sticks was a matter of some difficulty, but it was accomplished by brass clamps of the shape of a cylinder, cut along its length on both sides and rounded in file, which were gently pressed on the gelatine by a spring. It was found that in no case did the volume change by stretching, the diminution in girth being compensated by the increase of length. The

addition of common salt impaired the elasticity and strength of the sticks very considerably, making them unfit to support a pound weight, while part of the water could be replaced by glycerine, cane sugar, or gum arabic, without making any difference.

THE *Comptes-rendus* of the Paris Academy, of January 14, give an account of some modifications of an electrical anemometer formerly used by the Rev. Marc Dechevrens, at Zi-ka wei, for recording the horizontal and vertical movements of the atmosphere. The instrument, which is being constructed by M. Richard, is to be erected at the observatory of the Jesuit College in Jersey, and possesses some novel contrivances intended to ensure its satisfactory performance. The fan of the anemometer, which gives the horizontal component, is formed by portions of a cylinder; this arrangement was devised by M. Dechevrens, and is said to give excellent results. There is also an arrangement which assures sufficient duration to the electric contacts, to excite the electromagnets, while preventing prolonged contacts, which exhaust the batteries without doing any good. Two wires out of seven which exist in similar instruments are dispensed with; this is also an important simplification if the registrations are to be recorded at a distance.

THE current number of *Wiedemann's Annalen* contains a paper by Max Weber, on electromagnet pull. The author has measured the pull exerted on a long iron wire, one end of which projects within a helix, when a known current flows through this helix, producing a magnetic field of known intensity. The wire under examination is suspended horizontally by four silk fibres in the same way as in a ballistic pendulum. The displacement of the wire under the action of the coil is measured by means of a microscope, and from a knowledge of the weight of the wire and the length of the suspending fibres the pull can be calculated. The author has investigated the connection between the pull per unit cross-section of the wire ( $f_{\parallel}$ ), the strength of the field within the helix ( $H$ ), and the intensity of magnetisation ( $J$ ), and finds that  $f_{\parallel} = JH$ , when the length of the wire is parallel to the lines of force of the helix, and the diameter of the wire is very small compared with its length. The author has also examined the pull perpendicular to the lines of force, by using two coaxial magnetising coils separated by a small interval, the wire being placed with its length perpendicular to the axes of these coils, and its end passing through the space left between them. If the pull per unit area of cross-section of the wire under these conditions is called  $f_{\perp}$ , then  $f_{\perp}$  is always, in the case of iron, less than  $f_{\parallel}$ . For fields having an intensity of about 100, the ratio  $f_{\perp}/f_{\parallel}$  is about 100, but decreases rapidly with increasing field strengths, and appears to approach unity as a limit. Thus for  $H = 12,000$ ,  $f_{\perp}/f_{\parallel} = 1.11$ .

It is known that the direction of the pendulum line shows a considerable anomaly around Moscow. The line is deviated at Moscow by 10° to the north; at Tsaritsino, in the south-east, the deviation is only 0° 5' in the same direction; and at Podolsk, which is twenty-one miles from the capital, the deviation takes the opposite direction, to the south, and attains = 2° 7'. It has been supposed that beneath the neutral zone, at Tsaritsino, there must be great cavities in the rocks, or that the rocks, as a whole, have a density below the average. We now learn from a note by General Stebnitskiy, in the last issue of the *Zvezda* of the Russian Geographical Society (1894, No. 4), that the pendulum observations which have been made around Moscow by M. Iveronoff, give full support to the above supposition. The differences between the lengths of the second-beating pendulum, observed and calculated, being positive at Moscow and at Podolsk (+0.0108 and +0.0064 millimetres respectively), the same difference is negative above the neutral zone of Tsaritsino (-0.0228 millimetres), thus showing a deficiency in the accelera-

tion due to gravitation to the amount of  $\frac{1}{30,000}$  of the total force.

THE last number of the *Izvestia* of the Russian Geographical Society contains a very interesting account of Baron Toll's expedition to Arctic Siberia and the New Siberia Islands. Baron Toll was sent out by the Academy of Sciences to examine the body of a mammoth which was said to have been discovered on the banks of the Balakhna, a tributary of the Khatanga Bay, and altogether to continue the work which had been entrusted to Chersky, but was interrupted by his death. Lieut. Shileiko undertook the surveys, as well as the astronomical and magnetical observations. After a three months' journey the two explorers reached the village Kazachiye, at the mouth of the Yana, in  $71^{\circ}$  north latitude. A visit to the mammoth soon proved that there was nothing left but a few pieces of skin with its hair clothing, parts of the extremities, and a broken skull of a young mammoth. A number of remarkable explorations and surveys, astronomical and magnetical observations, and geological explorations were, however, carried out. The chief geological result is the settling of the real positions of the layers which contain relics of the mammoth. They are undoubtedly Post-Glacial, as they overlie the masses of underground ice which form the chief rock of the great Lyakhoff Island, and which, as Baron Toll's observations now prove, are remains of the great ice-sheet which formerly covered both the islands and the mainland, and whose moraines have now been discovered on the mainland. Moreover, these ice masses have the typical granulated structure of the glacier ice, which proves that they have originated from the snow-cover, and could not have originated from any sort of running water. As to the Post-Glacial layers which overlie the above, they contain, besides shells of *Cyclas* and *Valvata* and well-preserved insects, full trees of *Abus fruticosa*, willows, and birch, fifteen feet high, and bearing perfectly well-preserved leaves and cones. The northern limit of tree vegetation thus spread during the Mammoth period full three degrees of latitude higher than it spreads now, *i.e.* up to the  $74^{\text{th}}$  degree, and the mammoths and rhinoceroses of the time lived upon the patches of meadow clothed with the above bushes. It is worthy of note, that the masses of underground ice are not found in the lower parts of the Arctic coast which are known to have been covered by the Post-Pliocene sea, and that they only occur where the land rises a few hundred feet above the present level of the sea—that is, above the level of the Post-Pliocene ocean.

AFTER considerable delay, Murray's "Handbook for Hertfordshire, Bedfordshire, and Huntingdonshire" has been published. Brief notes on the geology, botany, and antiquities of these counties are given in an introduction.

THE Matriculation Directory (No. xvii.) of the University Correspondence College has just been received. It contains the examination papers (together with solutions) set at the recent matriculation examination, and also articles on the special subjects for next June, and for January 1896.

THE additions to the Zoological Society's Gardens during the past week include a Macaque Monkey (*Macacus cynomolgus*, ♀) from India, presented by Miss Teresa M. L. Monteath; two Little Auks (*Mergulus alle*) from Norfolk, presented respectively by Mr. Hamon Le Strange and Colonel Feilden; a Cardinal Grosbeak (*Cardinalis virginianus*) from North America, presented by Mr. F. Beresford Wright; two Leopard Tortoises (*Testudo pardalis*), a Cape Bucephalus (*Bucephalus capensis*) from South Africa, presented by Mr. J. E. Matcham; two Mantells Apteryx (*Apteryx mantelli*) from New Zealand, a Black Iguana (*Melopoceros cornutus*) from San Domingo, deposited; a Hog Deer (*Cervus porcinus*), born in the Gardens.

#### OUR ASTRONOMICAL COLUMN.

THE NATAL OBSERVATORY.—Mr. Nevill's report upon the work of the Natal Observatory, during the fiscal year ending last June, has been issued. The staff of the Observatory consists of an astronomical assistant, a meteorological assistant, and a computer, all of them ladies. In spite of such limited assistance, much important work has been accomplished. The observations of Mars during the opposition of 1892 have been completely reduced; and as soon as the corresponding observations made at the northern observatories have been reduced and published, it is proposed to compare the two series, and obtain from them a new determination of the distance of the sun. A contribution to the knowledge of the variation of latitude is included in the report. Since 1884 a number of observations have been made, by Talcott's method, to determine the latitude of the observatory. The observations invite consideration, on account of the fact that they were made and reduced before any special attention had been directed to the variation, arising from the suspected periodical inequality, in the direction of the polar axis of the earth. The mean latitude, deduced from the 1023 observations made during the six years 1884-1890, was  $29^{\circ} 51' 46''.68$ . The results obtained, from the separate observations of each year, show a steady gradual decrease since 1885. The observed latitude of the Observatory seems to have reached a maximum in that year, and to have steadily decreased since, at a nearly uniform rate of  $0''.27$  per annum. The rate of decrease up to 1890, however, appears to have quickly diminished, indicating a periodical irregularity in the apparent value of the latitude of the Observatory. Mr. Nevill remarks that a great deal of important work has accumulated at the Observatory, but the Government of Natal will not afford the necessary facilities for printing and publishing it.

THE NEW DUDLEY OBSERVATORY.—The disadvantages of the old situation of the Dudley Observatory had long been recognised, but it was not until 1892 that the generosity of Miss Bruce and other "friends and neighbours of the observatory," permitted the removal of the observatory to its present more favourable site. From an account given by the Director, Mr. Lewis Boss, in the *Astronomical Journal* No. 334, we learn that the observatory grounds consist of six acres, situated in an area of about forty acres, designed to form part of the park system of the City of Albany. The buildings appear to be all that can be desired, and many advantages will no doubt be derived from the provision of dwelling accommodation for the observers. The Transit Circle provided in 1857 has been re-erected with some slight additions, and it is satisfactory to learn that its large aperture of 0.203 m. and focal length of 3 metres, is no detriment to its excellence. A new equatorial, denominated the Pruyn, having an aperture of 31 centimetres, has been presented by the sons of a former President of the Board of Trustees. In this instrument, a photographic combination is obtained by replacing the flint glass of the visual telescope with a second one, and it is believed that this arrangement will be a complete success.

No elaborate programme of work is promised, but "the logic of events and inclination invites the observatory to undertake the comprehensive observation and discussion of stars known to have sensible proper motions." The Transit Circle will accordingly be devoted to this work, and the equatorial will take a subordinate place, "though it is expected that the zealous young assistants will continue to give a good account of themselves in work with this instrument, so far as circumstances permit."

THE MILKY WAY.—Returning to the subject of the distribution of stars in the celestial sphere, C. Easton (*Ast. Nach.* 3270) has derived some results of considerable interest by limiting his attention to two comparatively small regions of the Milky Way, one in Aquila, and another in Cygnus, the latter embracing a specially dark as well as a notably bright region. For each of these regions he finds that the general luminosity of the Milky Way corresponds very much more closely with Argelander's stars of magnitudes 9.1-9.5, than with the stars of greater brightness. A diagram in which all the stars of the Bonn maps have been reduced to the corresponding number of stars of mag. 9.5, shows very little similarity with the features of the Milky Way. Extending his inquiries to the photographs taken by Dr. Max Wolf, showing stars down to mag. 15, he shows that the very feeble stars followed the same law of distribution

as those of magnitudes 9.5. This correlation appears to indicate that the faintest stars and those of the 9th or 10th mag. probably form part of one system, and are at nearly the same distance from us. At the same time, some stars brighter than 9th mag. seem to be intimately associated with the Milky Way.

The hypothesis of an annular system, relatively isolated from the central part of the great galactic system, is regarded as not incompatible with the distribution of stars which he has found. For, at nearly the same distance from us, stars vary so much in size or intrinsic brightness as to give magnitudes ranging from 0.1 to 15, there seems no reason why some should not be of greater brightness than 9th mag.

There is nothing to prove, however that the various parts of the Milky Way are at an equal distance from us, nor even that it may be an enclosed ring. It does not appear improbable that subsequent researches may show the existence of one or several spirals emanating from a central accumulation, and recurring so as to form a nearly annular system, or one consisting of nearly concentric rings. However it may be, Mr. Easton's results seem to indicate that the portion of the Milky Way accessible to our means of observation, has but little thickness in relation to the diameter.

In a paper on the same subject (*Knowledge*, February), Mr. Chandler finds it difficult to resist the conclusion that the "dark areas" of the Milky Way are really regions of barrenness, and regards these features as indications of a process of condensation going on in the stellar as well as in the nebulous matter.

THE SYSTEM OF ALGOL.—Quite recently (*NATURE*, vol. xiv, p. 446) Mr. Chandler credited Algol with an obscure companion in addition to that which was recognised by Goodricke, and the existence of which has been fully confirmed by the investigations of Pickering and Vogel. Mr. Chandler's conclusions were based on a discussion of the systematic irregularities of the epochs of minima, and were apparently confirmed by a later discussion of the proper motion of Algol itself (*NATURE*, vol. xiv, p. 349). The evidence of irregular proper motion, however, is not regarded as conclusive by some authorities, and M. Tisserand, the Director of the Paris Observatory, is apparently one of the unconvinced. He has therefore attempted to find some other explanation of the phase variations. *Comptes Rendus*, January 21, 1895, and the result is to show that they can be simply and sufficiently explained by supposing a single dark companion moving in an elliptic, instead of a circular, orbit; and, in addition, that the bright star exhibits a retrograde proper motion. The result of this departure from the physical form would be a movement of the periastron point, and that would explain the apparent irregularities.

Assuming that the plane of the orbit is coincident with the equator of Algol, its eccentricity is found to be 0.132, and the orbital diameter is shorter than the equatorial by 1.5 per cent.

The irregularities of these conditions would be a very slight variation of motion in brightness in the long period of 140 years, and an entirely negligible difference in the time of passage to minimum and recency of normal brightness. The total duration of the eclipse, however, will vary very considerably. Taking the observations of 1850 and 1884 for the observations of Wurzburg, 1885, and 1891, respectively, M. Tisserand finds that the duration would be increased in this time by 1.63 hours. Since the true eccentricity of the orbit is 0.132, the true period of the eclipse, the length of the servers are 6.5h. and 9.6h. respectively. The former value is to be regarded as a confirmation of his hypothesis, the latter as pointing out the importance of spectroscopic observations in determining the distance from minimum, in connection with the explanation.

The irregularities of U Geminorum and U Cephei are probably to be explained in the same way.

### THE EXPLOSIVE NATURE OF THE SODIUM AND POTASSIUM DERIVATIVES OF NITROMETHANE.

SOME of the metallic derivatives of nitromethane, being characterised by an extremely explosive nature, sodium and potassium compounds of nitromethane have been referred to the current literature of the German chemist, Prof. Zelinsky of Moscow, who has been engaged in the study of the explosive character of the sodium compound,  $\text{CH}_2\text{N}_2\text{Na}$ , the nature of the preparation of this compound in dilute solutions of nitromethane,  $\text{CH}_3\text{NO}_2$ , with ether and heat, and the explosive character of sodium in alcohol, when the sodium compound is prepared. The precipitate requires to be washed with alcohol, and the dried portion of alcohol; the

dry compound thus obtained affords numbers on analysis agreeing with the anhydrous formula above given. In a former method of preparation described by Prof. Meyer, alcoholic soda was employed as precipitant, but the sodium nitromethane obtained invariably contained either water or alcohol; the use of sodium ethylate affords it anhydrous. Even the hydrated compound first isolated proved to be explosive; but upon placing a small quantity of it upon a watch-glass, and warming over a water-bath, in a short time it became suddenly converted into the anhydrous compound which immediately exploded with great violence. When a small quantity of the anhydrous compound prepared by use of sodium ethylate was placed in a test-tube, gently compressed, and then warmed, an explosion of so violent a nature occurred that the test-tube was completely pulverised.

Prof. Zelinsky has recently had occasion to prepare considerable quantities of sodium and potassium nitromethane, and has had the opportunity of testing and observing their explosive power upon a larger scale. He appears to have adopted essentially the same process for the preparation of sodium nitromethane as that described by Prof. Meyer, employing an alcoholic solution of sodium ethylate as precipitating reagent. Being desirous of obtaining the sodium compound perfectly anhydrous, an attempt was made to achieve this object by use of the water bath, but for the sake of precaution only about a gram of the substance was employed as a preliminary test of the efficacy of this method of dehydration. It was fortunate that such was the case, for within five minutes an explosion of so violent a nature occurred, that the watch-glass upon which the compound was supported was reduced to powder, and the water bath considerably injured. In order to demonstrate the explosive nature of this compound without danger upon the lecture table, Prof. Zelinsky recommends the following experiment.—A thick clock-glass, or better a stout metal plate, is sprinkled with small drops of water, and a very small piece of sodium nitromethane dropped upon it. After a few seconds, provided the amount of water has not been excessive, a deafening detonation occurs, with production of flame and projection of a thick cloud of smoke. The experiment may be varied by placing the substance upon the perfectly dry plate, and invoking its explosion by means of a smart blow with a hard object.

M. Neff has previously (*Ann. der Chemie*, 280, 273) described several of the metallic derivatives of the nitroparaffins, and has referred to the instability of the sodium compound, and the possibility of occasional explosions. Prof. Zelinsky now supplements this statement by remarking that an explosion always results from the contact of the dry sodium compound with a minute quantity of water. One of his assistants upon one occasion incautiously placed about five grams of sodium nitromethane in a glass vessel whose surface happened to be moist, with the result that a terrific explosion instantly occurred, which shattered every piece of apparatus upon the table, and the atmospheric wave produced occasioned the sudden extinction of the whole of the gas flames in the laboratory. The assistant fortunately escaped more than trifling injury, but a second such occurrence might have a very different result. This incident will doubtless serve to emphasise the great precaution which is necessary in handling these compounds.

The potassium compound,  $\text{CH}_2\text{KNO}_2$ , has been prepared in a similar manner, and found to be even more unstable than the sodium compound, exploding at the ordinary temperature shortly after its isolation. It separates upon the addition of the potassium ethylate in well-defined crystals. The crystalline form, however, soon disappears, and upon rapidly transferring to a filter, an explosion invariably occurs as soon as the compound becomes drained free of most of the mother liquor. The instability of the potassium compound at the ordinary temperature may also be readily demonstrated upon the lecture table. It is, of course, necessary to prepare it freshly on the spot, because of the impossibility of preserving it for any length of time. An ethereal solution of nitromethane is mixed with a solution of potassium ethylate in alcohol, the supernatant liquid rapidly decanted from the precipitate produced, the latter dried as quickly as possible between filter paper, and left quietly resting upon the paper. After a few minutes the substance explodes with a loud detonation.

These experiments will serve to indicate the extreme instability of the alkali-metal derivatives of nitromethane, and the violence of the explosions produced by their disruption.

A. E. TULLON.

RECENT WORK AT HARVARD COLLEGE OBSERVATORY.

THE forty-ninth annual report of the Director of the Harvard College Astronomical Observatory, by Prof. E. C. Pickering, has come to hand. Omitting matters of administration and some of the details, the following summary shows the most important events of the year covered by the report.

PHOTOMETRIC OBSERVATIONS.

The reduction of the photometric measures of the southern stars observed by Prof. S. I. Bailey in Peru, is now completed, and the catalogue containing the resulting magnitudes is in print. The observations of the first investigation undertaken with this instrument since its return from Peru are nearly completed. About six thousand stars have each been observed on at least three evenings. This catalogue includes all the stars of the Harvard Photometry, eighty lists of comparison stars for variables of long periods, and various stars the magnitudes of which are desired by other astronomers. A study has been made of the atmospheric absorption, especially for very low stars, and its coefficient has been derived on each evening, both for the southern and the northern stars. These values are now applied as corrections to the individual observations, instead of adopting a mean value of the absorption. A new working list has been prepared of the stars north of  $-40^\circ$  having magnitudes 7.5 or brighter, and which have not already been observed with the meridian photometer. This list contains about fourteen thousand stars, of which about two thousand have been observed during the last year.

Prof. Pickering refers to Mr. S. C. Chandler's criticisms on the photometric observations made with the meridian photometer. (*Astron. Nach.* vol. cxxxiv, p. 355, and vol. cxxxvi, p. 85.) It is maintained that the meridian photometer possesses the same advantages in measuring the light of a star that the meridian circle does in measuring its position. In both instruments absolute values are determined directly, and they are obtained very rapidly. Stars are identified in the same way in both, rapidly and accurately, and in both the systematic errors are small, even if the accidental errors are in some cases larger than those resulting from other methods. Stars can be observed with the meridian photometer under favourable circumstances nearly at the rate of one a minute, and the average deviation of the results thus obtained does not generally exceed one-tenth of a magnitude.

ASTRONOMICAL PHOTOGRAPHY.

The number of photographs taken with the 8-inch Draper telescope is 1657. The number taken in Peru with the 8 inch Bache telescope is 1768. All of the spectra photographed with these instruments have been examined by Mrs. Fleming. As a result seven variable stars, U Puppis, V Cancri, V Leonis, T Sagittarii, R Delphini, R Vulpecule, and R Phœnicis, have been shown to have the hydrogen lines bright in their photographic spectra. Unsuccessful attempts have been made to photograph the spectra of many other variables of long period when at maximum, and no image has been obtained. This has been found to be due in many cases to large errors in the ephemerides, and has been remedied by depending upon the observations of Mr. W. M. Reed, and making the time of photographing each star depend upon its observed, instead of its predicted, brightness. Eleven new variables have been discovered in the year, from the presence of bright hydrogen lines in their spectra, besides three the variability of which was discovered from changes in their photographic images. The number of stars of the fifth type has been increased by seven, making the total number of these objects 62. Five nebulae have been discovered from their spectra. The hydrogen line H $\beta$  has been discovered to be bright in the spectra of five stars, and twelve stars have been shown to belong to the fourth type. The spectra of A. G. C. 18049 and 22640 are peculiar. Several photographs have been obtained of the new star in the constellation Norma. At the Lick Observatory it was shown from visual observations that its spectrum, as in the case of the new star in Auriga, had become that of a gaseous nebula. This has been confirmed from photographs taken at Arequipa, which also show that this object is now gradually becoming fainter. The spectra of 4557 stars on thirty plates have been classified for the new Draper Catalogue. On one of these plates covering the region

of the variable star  $\eta$  Carinae, 1161 spectra have been measured.

The number of photographs taken with the 11-inch Draper telescope is 912. The lines in the spectrum of  $\zeta$  Ursæ Majoris are found to be double in 59 out of 340 images, and of  $\beta$  Aurigæ in 47 out of 65.

An investigation has been in progress for some time for the detection of stars having large parallaxes or proper motions. Photographs are taken in the usual position with the film towards the object glass, and also with the plate reversed, the photograph being taken through the glass. These are repeated at intervals of six months at the times when the effect of parallax on their right ascension would have its greatest value. Plates thus obtained may then be superposed so that the films shall be in contact, and the two images of each star made to appear like a close double with components north and south. Small changes in position may be detected by changes in the position angle, and the amount of the parallax or proper motion may be measured with great accuracy. Several hundred stars have thus been shown to have no parallax exceeding half a second.

OBSERVATION IN PERU.

The meteorological station on the summit of Misti, at a height of 19,200 feet, was successfully conducted for several months, one of the assistants, generally Mr. Waterbury, visiting it every ten days, and readjusting the self-recording instruments. Unfortunately, early in September, the shelter containing the instruments was found to have been broken into, and a number of the instruments carried off. Apparently the robbery was committed by two Indians, whose tracks were followed to a considerable distance. The property stolen would, of course, be of no use to the thieves, and its intrinsic value would be a small part of the actual loss. The work at this station was conducted with great labour; a mule path had been built to the summit, and the entire expenditure had been large. It will be a serious loss to science if it proves impossible to maintain the station.

The number of photographs obtained by Prof. Bailey with the 13-inch Boyden telescope is 561, including some remarkable charts. Among them may be mentioned photographs of the Nebula of Orion with an exposure of eight hours, of the cluster  $\omega$  Centauri with an exposure of six hours, and of  $\eta$  Carinae with exposures of six and fourteen hours respectively. In some of these, notwithstanding the long exposure, the image shows no deviation from the circular form. This is mainly due to substituting for a finder two eyepieces attached to the main telescope. One of them serves to follow a guiding star in the usual way; the other, directed to another star, shows if the plate needs to be rotated in its own plane. This appears to be an important improvement in making the best photographic charts of long exposure, especially of the polar regions. By the ordinary methods it is impossible to entirely correct such errors as those due to flexure and refraction, which do not depend upon the direction of the axis of the earth.

Attention is again drawn to the importance of making use of the admirable atmospheric conditions at Arequipa. A telescope of the largest size would not only have most favourable opportunities for work, but a field unexplored with such an instrument in the southern sky. Much could be done with a smaller instrument, as is shown by the work already accomplished with the 13-inch Boyden telescope. Out of a list of thirty telescopes having aperture exceeding 14 inches or more, but one is mounted south of latitude  $+35^\circ$ , and this one is not in use. A moderate expense only would be required to carry out this plan.

WORK WITH THE NEW TELESCOPE.

One of the most important events of the year was a careful trial of the Bruce photographic telescope. Nearly a thousand photographs have been obtained with it. The spectra of the faint stars prove very satisfactory, and stars too faint to be photographed with the other instruments can thus be studied. Bright hydrogen lines have been found in the spectra of  $\delta$  Orionis,  $\delta$  Iotidis,  $\omega$  Virginis and  $\delta$  Libræ, and the spectrum of  $\nu$  Ophiuchi has been shown to be of the fourth type. The length of these spectra is about a quarter of an inch, which is sufficient to show much detail in the spectra of fairly bright stars. To study still fainter spectra a prism of crown glass and of smaller angle has been ordered. The absorption of the photographic rays is less for this material, and it is expected that much fainter

spectra of the stars, and the dispersion will also be assisted by the use of a lens filled for the Biot telescope. I have experienced in making charts in which the stars are arranged in order of magnitude. Experiments are in progress in this direction, and I suggest that the method described above as a means of measuring the faintest stars will prove equally successful in the present case.

A series of experiments have been made to determine the intensities of the brighter stars on a uniform scale. It is suggested that this can be done with the transit instrument for stars brighter than the third magnitude, and that the scale may be extended to stars from the third to the sixth magnitude by a series of photographs which have been taken with a camera lens having an aperture of 2.5 inches. The images of the stars are of a certain size, and the intensity of the circular discs of light which can be accurately measured.

**ELECTRIC DISCHARGE THROUGH GASES.**

(ONE of the most important and interesting branches of physical science is that which deals with the connection between electrical and chemical effects.

The investigations on electrolysis made within these walls by Davy and Faraday proved that the important class of electrical phenomena associated with the passage of electricity through liquids, are connected in the closest way with chemical action. They proved that no electricity will pass through most liquids unless chemical action occurs, and that for each unit of electricity which passes through the liquid there is a definite amount of chemical decomposition.

This case, though it is one where the laws are most accurately known, is but one among many electrical phenomena which are inseparable from chemical action.

So many instances of this kind have been discovered, that we may perhaps venture to hope that we are not far from the time when it will be universally recognised that many of the most fundamental questions in chemistry and electricity are but different aspects of one and the same phenomenon.

Anything which throws light on the connection between electricity and matter, interesting as it is on its own account, acquires additional interest when regarded as elucidating the connection between chemical and electrical effects, and no phenomena seem more suitable for this purpose than those which are the subject of the discourse this evening—the discharge of electricity through gases. For in gases we have matter in the state in which its properties have been most carefully studied, and the investigation of the electrical effects is facilitated by the visibility of the discharge, affording us ocular, and not merely inferential, evidence of what is taking place.

The points to which I wish to refer particularly this evening are, firstly, the phenomena connected with the passage of electricity from the gas to the electrode, or from the electrode to the gas; and secondly, some of the properties of the discharge when it is entirely in the gas.

By using a long discharge tube, say, one fifty feet long, and covering the luminous discharge through a rotating mirror, we can trace the course of the luminosity due to a single discharge, as well as the manner in which the primary circuit of an induction coil, if we like so to call it, the luminosity follows the direction of the electric current through the tube. That is, the luminosity begins at the positive electrode, it then rushes down the tube with enormous velocity, but when it gets to the negative electrode, it remains behind; it does not disappear at once at the negative electrode, it goes down a hole, but lingers there, the electricity coming out as it enters it. In consequence of this delay in the positive discharge in getting out of the tube, there is an accumulation of positive electricity in the neighbourhood of the negative electrode until the potential fall at the electrode increases to about 150 volts.

The positive electricity which now opposes the discharge thus finds considerable difficulty in getting from the gas to the metal, though as I hope to show you later on, so long as it keeps in the gas it meets with what we may, in consideration of the view sometimes entertained in the case of a ridiculously small amount of resistance, its real difficulty is to get out of the

metal at some part of its course, and you see that the main portion of the discharge goes back into the main tube. In the second experiment the metal diaphragm is replaced by a very thin plate of mica; when the side passage is opened the discharge goes round, but when this is closed by a pellet of mercury the discharge prefers to go across the mica than through the mercury.

Fig 1

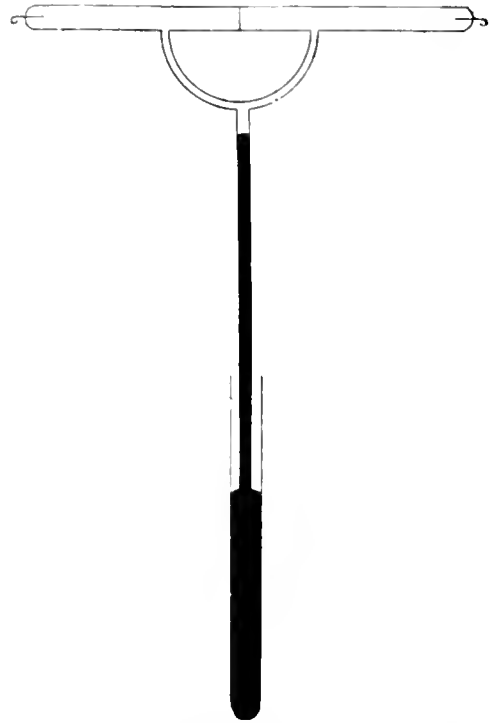

mercury I can stop up the passage by a pellet of mercury. We will first observe the discharge when the side passage is open; you see that the discharge, instead of passing across the thin piece of platinum leaf, takes the very much longer route round the side tube, so as to avoid crossing the metal. We will now raise the mercury cistern, and close the side tube by a pellet of mercury; the discharge now has no alternative but to cross the

Fig 2

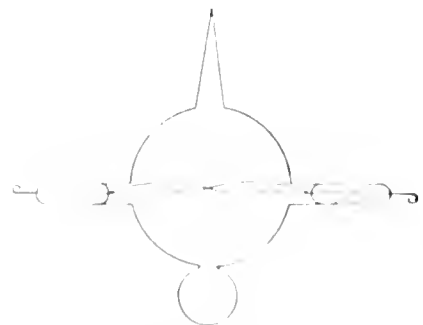

metal at some part of its course, and you see that the main portion of the discharge goes back into the main tube.

In the second experiment the metal diaphragm is replaced by a very thin plate of mica; when the side passage is opened the discharge goes round, but when this is closed by a pellet of mercury the discharge prefers to go across the mica than through the mercury.

Though this effect has long been known, it is so important that I have thought it well to describe it briefly. I. Thomson.



A second experiment which shows the same thing is the following. Two long electrodes are fused into a bulb, so that the tip of an electrode is a considerable distance from the place where it passes through the glass. We will now send an alternating discharge through the tube, and you will see, I think, that the discharge, instead of going straight across the short distance between the ends of the electrodes, goes from the tip of one electrode to the place where the other passes through the glass, thus staying as long as possible in the gas before passing into the metal. The appearance of the discharge shows that the positive electrode is at the end of the wire, the negative at the junction of the wire with the glass.

Another interesting example of the difficulty the discharge experiences in passing from gas to metal is the discovery made by Profs. Liveing and Dewar, that when the discharge passes through a gas containing a large quantity of metallic dust, the light from the discharge, when examined in the spectroscope, does not show any of the lines of the metal.

The difficulty which the positive electricity finds in passing from the gas to the electrode depends a great deal upon the nature of the gas, as well as upon that of the electrode; it is influenced by the position of the gas and the electrode relatively to one another in the electro-chemical series.

I have lately made a series of experiments on this point in the following way. An alternating discharge from a high tension transformer was made to pass between two electrodes fused into a bulb, which could be filled with the gases under examination. Another electrode connected to an electrometer, passed into the bulb, and was arranged so that it could be moved about from one part of it to the other. When the electrodes were metal and the bulb was filled with the electro-negative gas oxygen, the electrode received a positive charge in whatever part of the bulb it was situated; if now the bulb was filled with hydrogen at atmospheric pressure, then in the regions remote from the arc the electrode received a positive charge, but in the immediate neighbourhood of the arc itself it received a negative charge. When the pressure was reduced the region in which the charge was negative contracted, and finally at pressures about one-third of an atmosphere, seemed to disappear, and the electrode got a slight positive charge in whatever position it was placed. If now, instead of using metallic electrodes we use well-oxidised copper ones, and repeat the experiment in hydrogen, working at a pressure when there was only positive electricity, when the electrodes were bright and polished, we find that with the oxidised electrodes every particle of positive electricity is taken out of the tube, and a negative charge is left. This negative charge remains until the copper oxide is completely reduced; when this occurs the negative charge disappears, and is replaced by positive. Thus, under the same conditions as to the nature of the gas and the pressure, the bright copper electrodes leave a positive charge in the gas, while the oxidised ones leave a negative charge.

The most probable explanation of these results seems to me to be the view that the communication of electricity from gas to the electrode, or from the electrode to gas, is facilitated by the temporary formation of something of the nature of a chemical compound between the gas and the metal. In all such compounds the metal is the electro-positive element, and has the positive charge, the gas being the electro-negative and carrying the negative charge. Now consider the case when the negative charge is on the gas, and the positive charge on the metal; then the gas and metal have got the charges proper to them in any compound they may form, and are thus in a fit state to combine, or according to this view, allow the negative electricity to pass from the gas to the copper. But, now, suppose the gas was positively electrified, the gas and the metal have now opposite charges to those proper to them in a compound, and before the union of gas and metal in this state could result in anything but a most unstable compound, an additional process must be gone through—*i.e.* the charges on the gas and metal must be interchanged. Thus the conditions for the combination of the gas and metal are more complex when the gas is positively electrified than when it is negatively electrified, and thus, on the view that the communication of electricity between the gas and the metal involves a sort of chemical combination, we see that the negative electricity will escape more easily from the gas to the metal than the positive. Now consider the case when the gas was hydrogen, the electrodes oxidised copper; the hydrogen combines now not with the metal, but with the oxygen, forming water, in which hydrogen is the electro-positive element; thus,

in this case, it is the positively charged hydrogen which is in the state best fitted for pairing. The consequence is, the positive charge would be most readily removed from the gas and the negative left—exactly the opposite to that which occurred when the electrodes were bright. This reversal, as I stated before, is verified by experiment.

I have hitherto only spoken of the phenomena which accompany the passage of electricity from the electrode to the gas, or from the gas to the electrode.

I shall now pass on to consider the properties of the discharge when it is entirely confined to the gas.

We may produce a discharge which, during the whole of its course, shall be confined to the gas in the way represented in the diagram.

The two poles of a Wimshurst machine are connected to the insides of two jars A and B, while the outsides of these jars are connected together by a metal wire wound so as to form a coil. The electricity from the Wimshurst machine charges up the jars, the difference of potential between the poles increases until a spark passes. The passage of the spark puts the insides of the two jars in connection, and the jars are discharged. The discharge of the jar, as was proved from the theory of electromagnet action by Lord Kelvin more than forty years ago, and shortly afterwards confirmed by the experiments of Feddersen, is an oscillatory one, producing currents surging backwards and forwards through the wires with extraordinary rapidity. The

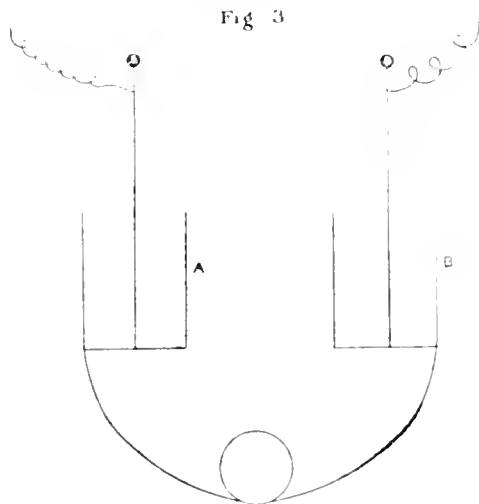

subject of these oscillatory currents is one which is tinged with melancholy. In the beginning of 1894 we lost Hertz, whose splendid work on these electrical oscillations is known to you all. The Managers of this Institution have marked their sense of the importance of this work by devoting a special lecture to this work alone, and they have entrusted that lecture to a most distinguished worker in the same field as Hertz. It would therefore be presumptuous on my part to refer in any detail to Hertz's work; but no physicist, and least of all one who is a member of Maxwell's University, could pass over in silence the death of Hertz.

When Hertz began his magnificent experiments on electric oscillations, there were many theories of electrical action. When he had finished them there was only one, Clerk Maxwell's.

Hertz's work was done with very much quicker vibrations than those produced by the apparatus now on the screen; this, however, gives rise to currents through the coil changing their direction some million times a second. If we place in the coil an exhausted bulb, the bulb in reality will be the secondary of an induction coil, and will be exposed to electromotive forces tending to produce circular currents parallel to the plane of the coil.

I will now place a bulb inside this coil, and you see that a circular ring discharge passes through it, and this discharge passes entirely in the gas.

The gas in the bulb now in the coil is the vapour of silicon tetrachloride; it happens to be the bulb which gives a brighter ring than any others I possess.

In his ring discharge passes through air at different pressures, the colour of the discharge changes very considerably. The first bulb I used in was at fairly high pressure, about 1/10 of a millimetre. I will now put in another at a lower pressure, and then another still lower pressure. Mr. Newall, who has been working on the spectra of these discharges, finds that at the highest of the first bulb the spectrum is due to nitrogen; at the second stage it is due to mercury vapour; the bulb was exhausted by a mercury pump, so that there is in the bulb a certain quantity of mercury vapour.

The apple-green colour in the more highly exhausted bulb is due to some compound of sulphur, which has got into the bulb from the sulphuric acid used to dry the gas. Mr. Newall finds that if the ordinary discharge from a coil between electrodes is taken in such a bulb, there is no trace of this sulphur spectrum. He has also found that when the bulb is at a pressure intermediate between what I may call the mercury and the sulphur stage, when the mercury and sulphur lines are both visible, these sets of lines come from different layers, the sulphur lines coming from a layer nearer the surface than the other.

If we take the discharge through a bulb containing oxygen, you will see that the ring discharge is succeeded by a bright glow; at first the glow is somewhat opaque, but gradually gets more transparent and changes colour. This gives a continuous spectrum crossed by a few bright lines. If we take the discharge through cyanogen, you see that the glow is even more persistent than the oxygen, though it is not so bright; all the gases which

nor would an absolute non-conductor; for a given period, and with apparatus of given dimensions, there is a certain conductivity which gives a maximum effect; this follows easily from the theory of induction of currents, but at this late period in the evening I will take a shorter course and prove it by an experiment.

I put a piece of brass in this loop, and you see it produces but a small effect upon the brightness of the discharge. Instead of brass I now insert a plumbago crucible, which, though a conductor, is not nearly so good a one as the brass, and you see the discharge in the indicating bulb is completely stopped.

I will now place in the second loop an exhausted bulb; you see it produces a decided diminution in the intensity of the discharge in the galvanometer bulb. I now replace the bulb by another of the same size containing dilute sulphuric acid; you see it does not produce nearly so large an effect as the exhausted bulb; this might be due, as we have seen, to the sulphuric acid being either too good or too bad a conductor. I can show that it is the latter by putting a bulb in filled with a stronger solution, which has a higher conductivity than the weak solution; if the smallness of the effect produced by the weak acid were due to its being a better conductor than the gas, then increasing the conductivity would still further diminish the effect of the acid; you see, on the contrary, that the strong acid produces a distinctly greater effect than the weak, hence the rarefied gas in the bulb is a better conductor even than the strong electrolyte. Let us consider for a moment the molecular conductivities of the two substances, the rarefied gas and the electrolyte. The

Fig 4



Fig 5.

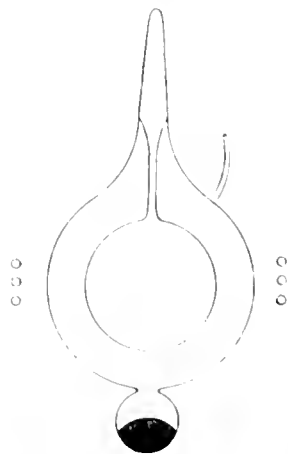

are with the exception of the class of substances which polymerize, that is, whose molecules can combine with each other, I imagine that what takes place in bulbs filled with these substances is that the discharge produces a polymeric modification, and that this gradually returns to its original state, and while doing so gives out a phosphorescent light. It is in accordance with this that in a high temperature where ozone cannot exist the discharge through an oxygen bulb does not show any glow.

It is at the beginning of this discourse that gases were exceedingly good conductors of electricity. I will now endeavour to show a portion of what I have just stated. The apparatus which I shall use for this purpose is a slight modification of one I have used for studying the ring discharge; the only difference is that in the wire connecting the two coatings of the bulb there are two loops instead of one. In one of these loops an exhausted bulb is placed, which is a kind of galvanometer, the brightness of the discharge an indication of the strength of the current flowing round the coil. I will place a second bulb in the other loop, which will be started in it, and will absorb the energy of the discharge, which will be absorbed; this will be the energy available for the second bulb, so that the change in the bulb will be a measure of the effect produced on the discharge will depend upon the conductivity of the substance placed in the second loop.

The effect is not directly proportional to the conductivity; in fact the perfect conductor would not produce any diminution,

pressure of the gas is about 1/10 of a millimetre, while in the electrolyte there are sufficient molecules of the acid to produce, if they were in the gaseous state, a pressure of more than 100 atmospheres; thus the conductivity of the gas estimated per molecule is about 10 million times that of the acid, this is greater than the molecular conductivity of even the best conducting metals.

If the pressure of the gas is diminished below a certain point, the conductivity begins to diminish. I have here an experiment which I hope will show this. The apparatus (Fig. 5) consists of two bulbs, one outside the other; the inner bulb contains air at a low pressure, while the space between the two bulbs is a very high vacuum containing practically nothing but a little mercury and its vapour. The amount of mercury vapour in this space is, at the temperature of the room, exceedingly small, but as the apparatus is heated the vapour pressure increases, and we are thus able to produce a fairly wide range of pressure in the space between the bulbs. The outer sphere is surrounded by the coil connecting the outer coatings of the two Leyden jars. When the space between the bulbs is a conductor, the alternating currents circulating in the coil will induce in this conductor currents whose inductive effect is opposite to that of the currents in the coil; and in this case this layer will screen off from the inner bulb the electromotive force due to the alternating currents in the coil. If, on the other hand, the space between the bulbs is a non-conductor, the inner bulb will be exposed to the full effect of these forces. We now try

the experiment: you observe that when the mercury is cold, and consequently the pressure in the space between the bulbs very low, a bright discharge passes through the inner bulb, while the space between the bulbs remains quite dark; when we heat the mercury so as to increase the pressure of its vapour, a bright discharge passes through the outer layer, while the inner bulb is quite dark; the outer layer is now a conductor, and by its action screens off from the inner bulb the induction of the coil.

The last experiment I have to show is one on the effect produced by a magnetic field on the discharge. When the discharge has to flow across the lines of magnetic force, the pressure of the magnetic field retards the discharge; when, however,

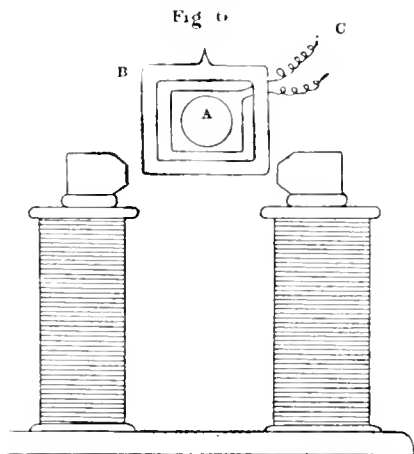

the discharge flows along the lines of magnetic force, the discharge is helped by the magnetic field. This is shown in the following experiment. A is a bulb; B a square tube, one side of which is placed between the poles of an electromagnet; the coil C, which connects the outside coatings of the jars, can be adjusted so that when the magnet is "off," the discharge passes through the bulb but not round the square tube; when, however, the magnet is "on," the discharge passes in the square tube but not in the bulb. In the square tube the discharge passes along the lines of magnetic force and is helped; in the bulb it passes across them and is retarded.

UNIVERSITY AND EDUCATIONAL INTELLIGENCE.

OXFORD.—In a Convocation held on Tuesday, January 29, the degree of Doctor of Medicine, by decree of the House, was conferred on J. S. Burdon Sanderson, F.R.S., Regius Professor of Medicine. Prof. Sanderson was at the same time empowered to discharge the duties of the Waynflete Professor of Physiology, and to dispose of the income of the department during the vacancy in the Waynflete Professorship.

The amendments to the proposed form of statute on degrees for research will be submitted to Congregation on Tuesday, February 12. There are no less than sixty-three amendments, most of which are consequential. The chief amendments propose that the degree of Bachelor of Arts shall be substituted for the proposed degrees of Bachelor of Letters and Bachelor of Science; that the delegacy for the supervision of candidates shall be chosen from among a limited number of University officials, and that there shall be no such delegacy, but that the supervision shall be entrusted to the Boards of Studies.

The Sibthorpe Professor of Rural Economy will deliver an inaugural lecture on Monday, February 4, at 5.30 p.m., on "The Present Relations of Agricultural Art and Natural Science."

Mr. A. B. Trevor Battye will give a lecture before the Ashmolean Society on Monday, February 4, at 8.30 p.m., on his experiences in Kolguev Island.

The Vice-Chancellor has received for the University a bequest from the late Miss Susan Kidd of a portrait of her father, Dr. John Kidd, of Christ Church, formerly Regius Professor of Medicine.

CAMBRIDGE.—The Special Board for Biology and Geology propose that in future the Walsingham Medal, given by the Lord

High Steward annually for biological research, shall be open to graduates of the University up to the standing of Master of Arts. Of the three Medals offered, two have been awarded—one for a zoological and the other for a botanical essay. It is also proposed that the Medal shall not be awarded twice to the same person.

The funeral of the late Prof. Cayley will take place on Friday, February 1, in Trinity College Chapel, and the Mill Road Cemetery. Members of the University desiring to be present, are requested to assemble in the College Hall at 1.45 p.m.

The Sedgwick Memorial Syndicate have been empowered to reconsider the plans, or prepare new ones, for the Geological Museum. The estimates for Mr. Jackson's plan exceeded the means at the disposal of the University.

Dr. L. E. Shore, St. John's College, has been appointed an additional member of the Medical Board. Dr. A. Ransome, F.R.S., Dr. J. L. Notter, Dr. T. Stevenson, F.R.S., and Dr. K. Thorne Thorne, C.B., F.R.S., have been appointed Examiners in State Medicine for the current year.

At the Matriculation on January 28, seventeen new students were entered. This brings the total for the present academical year up to 894.

THE Executive Committee of the City and Guilds of London Institute have awarded the first Salters' Company Research Fellowship for the encouragement of higher research in chemistry in its relation to manufactures, to Dr. Martin O. Foster. Dr. M. O. Foster is an old student of the City and Guilds Technical College, Finsbury, and Doctor of Philosophy of the University of Wurzburg. For several months he has been engaged in investigating some new derivatives of camphor in the Research Laboratory of the City and Guilds Central Technical College and by the aid of the Salters' Company's Research Fellowship, he proposes to pursue this line of work.

THE Organised Science Schools of the Department of Science and Art are schools in which the instruction is carried on methodically according to one or other of the courses laid down by the Department, or which has been specially submitted to and approved by it. It can easily be understood that such schools represent a very important stage in the system of scientific education which Mr. Acland is doing so much to improve. A number of new regulations, relating to these schools, have just been issued, to come into force after the examinations next May. The most important feature of the new scheme is the introduction of payment on inspection instead of payment on results, for by far the larger part of the instruction given in organised science schools. This modification, which applies to 120 science schools in the United Kingdom, has only become possible since the appointment of a staff of Science and Art inspectors. Another noteworthy feature is that reasonable latitude will be allowed to the teacher as to the nature of the course he may pursue provided the instruction is sound, satisfactory in amount, and combined with proper practical work. Even more satisfactory are the instructions that the practical chemistry for the first year's course should include the setting up of apparatus—weighing and other chemical manipulations, the preparation of gases, the estimation of volume, and so on. Analysis will, in future, occupy a secondary position in introductory courses. The mechanical test-tubing, which has hitherto formed the greater part of practical chemistry in Departmental schools, will thus give place to practical work of real educational value. We also observe that provision is made for a certain amount of literary instruction being given whilst the student is pursuing his science curriculum; that a choice of advanced courses is given; and that an alternative programme suitable for women is formulated, and instruction in subjects specially adapted to them is demanded; that practical instruction must be given in the subjects of science simultaneously with the theoretical instruction. Clearly, the new rules will greatly assist the development and better organisation of scientific education.

SCIENTIFIC SERIALS.

American Journal of Science, January.—Late glacial or Champlain subsidence and relevation of the St. Lawrence River basin, by Warren Upham. From the Champlain submergence the Atlantic coast of North America was raised somewhat higher than now; and its latest movement from New Jersey to Greenland has been a moderate depression. As in Scandinavia,

the restoration of a static equilibrium, is attended by minor oscillations, the conditions requisite for repose having been overpassed by the early relevation of outer portions of each of these great glacial areas. The close of the Ice Age was not a geological speaking, for equilibrium of the disturbed areas has not yet been restored.—An automatic mercury vacuum pump, by M. I. Pupin. This pump is a combination of a suction pump capable of raising mercury to practically any height, and an ordinary Sprengel pump, the two being connected by a siphon barometer. Mercury is pumped into the Sprengel reservoir by the suction pump. The reservoir of the latter is provided with two vertical tubes dipping into two mercury vessels. The end of one of these is higher than that of the other, so that when the mercury has fallen to the level of the end, no more mercury enters the tube, and the column already in it is slowly drawn up into the siphon barometer.—Graphical thermodynamics, by René Le Saussure. The author recommends the adoption of new coordinates instead of P and V. Instead of these, he employs the variables  $\phi$  and  $\beta$ , defined by the equations  $\phi = \tau - \tau_0$ ,  $\beta = \tau/\tau_0$ , where  $\tau$  is the period and  $\tau_0$  the amplitude of the vibratory motion constituting heat. Then the value of each variable depending upon the phenomenon can be obtained graphically.—Solutions of salts in organic liquids, by C. L. Langbarger. The law enunciated by Schroeder and De Chatelet, that the solubilities at equal intervals from the temperature of fusion for different solid bodies and in different solvents are the same, although approximately true for the cases investigated by them, is not applicable to the case of inorganic salts in normal organic solvents.

*Annalen der Physik und Chemie*, No. 13, 184. A new spectrum photometer, by Arthur König. Between the telescope and the collimator, which is provided with two parallel slits, are introduced, besides the refracting flint-glass prism, a twin prism and a Rochon polarising prism. One of the slits is provided with a total-reflection prism, in order to admit the standard light from the slit. The field of view shows two semicircles, one for each of the sources of light, and their relative intensities can be adjusted and measured by a Nicol prism near the eye. The observer notes the angle through which the Nicol prism must be rotated in order to give equal intensities to the two halves of the field. Spectra of various sources of light, by Else König. By means of König's spectrum photometer, various petroleum and gas lamps were spectroscopically studied.—On the process of light emission, by G. Jaumann. The author shows that the emissive vibrations of a luminous body exhibit a grouping which may be measured.—Capillary electrometers with mercury electrodes, by G. Meyer. The surface tension of mercury and some, but not all, amalgams is reduced by the addition of a solution of a salt of mercury, or of a salt of the metal contained in the amalgam. The reduction of surface tension which takes place during anodic polarisation is due to the formation of such mercuric or metallic salts.—Thermoelectricity of chemically pure metals, by K. Noll. This paper gives an account of a careful redetermination of the thermoelectricity of pure Cd, Sn, Ag, Au, Cu, Zn, Al, Pt, Mg, Fe, Ni, Hg, and German silver. Influence of magnetisation and temperature upon the electric conductivity of bismuth, by J. B. Henderson. The author shows that, before bismuth spirals can be employed to measure magnetic fields by their change of resistance, it will be necessary to find a ready means of testing their temperature, as the resistance is profoundly affected by changes in the latter.—High-temperature thermometers of Jena glass No. 5991, by Anton Mankke. These thermometers have to be filled partly with liquid carbonic acid, after which they may be employed for temperatures up to 550°, the carbonic acid keeping the mercury from boiling. The author describes how he found the expansion of the glass and the mercury for such high temperature, and calibrated one of the thermometers with reference to the air thermometer.

*Bulletin de la Société Naturelle de Moscou*, 1891, No. 1.—Contributions to the Moss flora of Russia, by Dr. Ernst Zicklerhath, being an enumeration of 202 species collected by the author in European Russia (paper in German).—The formation of the primary blastoderm and the origin of the chord and the mesoderm in the Vertebrata, by B. Lwoff (in German, with six plates). A work which already has been partially published in *Biologische Centralblatt* for 1892; it is based on the study of the embryology of the *Amblyopus*,

the *Parameyon*, the *Ascid*, the *Primitaria* and *Torpido*, several fishes and the *Lacerta*, and the author comes to the conclusion that the whole of the process is quite different from what is usually described as gastrulation. The paper is to be continued.—A general expression of the Thermodynamic Potential, by N. Oamoff.—Meteorological observations at the Petrovsk Agricultural Academy for the year 1893.

SOCIETIES AND ACADEMIES.

LONDON.

Royal Society, January 17.—“The Latent Heat of Evaporation of Water.” By E. H. Griffiths, M.A., Sidney Sussex College, Cambridge.

A calorimeter was suspended within a chamber the walls of which were kept at a constant temperature in the manner described in a previous paper.<sup>1</sup> The calorimeter was filled with a singularly limpid oil, which was stirred by paddles revolving about 320 times per minute, and immersed in the oil was a silver flask, which contained the water to be evaporated. The ends of a platinum-silver coil, within the calorimeter, were maintained at a known constant potential difference, and the rate of evaporation so controlled as to exactly balance the heat supplied by the electric current. The advantages of this method are that the results are not appreciably affected by (1) errors in thermometry; (2) changes in the specific heat of water; (3) errors in the determination of the water equivalent; (4) loss or gain by convection, &c. Differential platinum-thermometers were used, in order to ascertain the equality of the calorimeter temperature and that of the surrounding walls, thus differences of 0.0004 C. could be accurately measured, and smaller differences detected.

A series of experiments in which the saturated vapour was removed from the flask by a stream of dry gas, gave the following results.

Temp. (Nitrogen Scale)	L (in terms of a thermal unit at 15°)
24.96	581.9
39.99	572.4
49.82	560.5

The method of experiment was then altered; rapid evaporation was caused by removal of pressure, and the mass of water evaporated determined in a different manner.

A considerable number of experiments gave the following results.

Temp. (N. Scale)	Extreme values of L.	Mean L.
30.00	578.58 - 578.90	578.70
40.15	572.12 - 573.01	572.60

The conditions as to rate of evaporation, &c., were varied greatly during the experiments.

The results are expressed by the following formula

$$L = 596.73 - 0.6010\theta$$

This formula would give

$$L = 596.73 \text{ when } \theta = 0$$

and

$$L = 536.63 \text{ ,, } \theta = 100.$$

And these values are almost identical with those obtained by Dieterici at 0 (596.73) and Regnault at 100 (536.60). A study of the results leads the author to the conclusion that the “thermal unit at 15°” must be almost identical with the “mean thermal unit between 0° and 100°.” It has been shown by Rowland, by Bartoli and Stracciati, and by the author, that at low temperatures the specific heat of water decreases as the temperature rises, and it is probable that it arrives at a minimum between 30° and 40°, afterwards increasing with rise of temperature. There is, therefore, nothing impossible in the above supposition.

An investigation into the density of aqueous vapour (assuming the author's values of L and J) indicates that at low pressure the density of the saturated vapour is that of a perfect gas, and that at higher pressures (above 1.40 m.m.) it attains a density about 1.02 times as great as the “theoretical density.”

January 24.—“Mathematical Contributions to the Theory of Evolution. II. Skew Variation in Homogeneous Material.” By Prof. Karl Pearson, University College, London. (See p. 319).

<sup>1</sup> The Mechanical Equivalent, *Phil. Trans.* 1893 A, pp. 361-504. See *Phil. Mag.* January 1894.

**Royal Microscopical Society, January 10.**—Annual meeting.—A. D. Michael, President, in the chair.—After the report of the Council for the past year and the treasurer's statement of accounts had been read and adopted, the President announced that the following were elected as officers and Council for the ensuing year:—President, A. D. Michael; vice presidents, Prof. L. S. Beale, F.R.S., Dr. R. G. Hebb, E. M. Nelson, T. H. Powell; treasurer, W. T. Suffolk; secretaries, Prof. F. Jeffrey Bell, Dr. W. H. Dallinger, F.R.S.; ordinary members of Council, T. D. Aldous, C. Beck, A. W. Bennett, Dr. R. Braithwaite, Rev. E. Carr, Frank Crisp, E. Dadswell, G. C. Karop, C. F. Rousselet, Dr. H. C. Sorby, F.R.S., J. J. Vezey, and T. Charters White. The President then delivered the address, the subject being, "The History of the Royal Microscopical Society." The President said that if any of his hearers would leave that West-end abode of science, and journey eastward to Tower Hill, and thence by Sparrow Corner along Royal Mint Street, he would find himself in Cable Street, St. George's-in-the-East, not a very quiet or a very clean locality; turning down Shorter Street he would emerge opposite a space of green, where once stood the Danish Church, with its Royal closet reserved for the use of the King of Denmark when visiting this country; the space is surrounded by houses which have seen better days, and amongst them, between a pickle-factory and a brewery, stands a rather dilapidated erection which is 50 Wellclose Square; where, in 1830, lived Edwin J. Quekett, Professor of Botany at the London Hospital; and there, on September 3 of that year, seventeen gentlemen assembled "to take into consideration the propriety of forming a society for the promotion of microscopical investigation and for the introduction and improvement of the microscope as a scientific instrument." Among the seventeen were N. B. Ward, the inventor of the Wardian-case, which is not only an ornament to town houses, but was the means of introducing the tea-plant into Assam and the chinchonas into India, and who became treasurer of the society; Bowerbank Lister, who has been called the creator of the modern microscope; Dr. Farre, Dr. George Jackson, the Rev. J. B. Reade, and the enterprising and scientific nurseryman George Loddiges. Most of these subsequently became presidents of the Society. A public meeting was held on December 20, 1839, at the rooms of the Horticultural Society, then at 21 Regent-street, when the "Microscopical Society of London" was formally started. Prof. Richard Owen (not Sir Richard at that time) took the chair and became the first president, and shortly after the famous John Quekett became secretary, an office which he held almost to his death. At this moment Schleiden in Germany was commenting upon the paucity of British microscopical research, and attributing it to the want of efficient instruments, not knowing that a society was then forming which was to raise British microscopes to probably the first position in the world. The President then traced the history of the Society through the presidencies of Dr. Lindley the botanist, Prof. Thomas Bell the zoologist, Dr. Bowerbank, Dr. George Busk, Dr. Carpenter, Dr. Lankester, Prof. W. Kitchen Parker (all deceased), and of others equally famous who are still living; and showed how, under its influence and by its assistance, the vast improvements in the microscope, and the enormous extension of its use had gradually arisen; he also described its connection with the origin of the *Quarterly Journal of Microscopical Science*, the *Monthly Microscopical Journal*, and other publications, besides its own present widely circulated journal with its exhaustive summary of microscopical and biological work. He related how on John Quekett's death certain members of the Society subscribed to purchase for the Society's collection a curious microscope which Quekett possessed, and which had been made by the celebrated Benjamin Martin about 1770, probably for George III., and how they extended their subscription so as to provide a medal to be called "the Quekett medal" to be given from time to time to eminent microscopists; and how, difficulties having arisen, it happened that the only Quekett medal ever awarded was given to Sir John Lubbock. Finally, the President considered the future of the microscope and the prospects of further improvements. He said that many people were of opinion that the instrument is now perfect, and that consequently the most important *raison d'être* of the Society was over; he by no means agreed in that view, he believed that there was as much scope for progress in the future as there had been in the past; it was not by any means the first time

that this idea had been put forward. In 1829 Dr. Goring, then a great authority on the subject, wrote in one of his published works: "Microscopes are now placed completely on a level with telescopes, and like them must remain stationary in their construction." In 1830, less than a year after, appeared Lister's epoch-making paper, "On the improvement of achromatic compound microscopes," and we have been improving ever since.—Mr. H. V. Tebbs proposed a vote of thanks to the President for his address; this, having been seconded by Prof. Bell, was carried.

## EDINBURGH.

**Royal Society, December 17, 1894.**—The Hon. Lord McLaren, Vice-President, in the chair.—Mr. Patrick Murray read an obituary notice of the late Mr. Donald Beith.—In a paper on germination in ponds and rivers, Mr. H. B. Guppy described observations on the germination of semi-aquatic and aquatic plants, and discussed the effects of temperature and light.—A paper on the Hall effect and some related actions in bismuth, by Mr. J. C. Beattie, was read. Mr. Beattie finds, with high fields, a reversal of the Hall effect in certain specimens of bismuth.—Mr. George Romanes communicated a paper on attraction treated by graphic processes, with deductions.

January 7.—The Rev. Prof. Flint, Vice-President, in the chair.—Dr. W. Peddie read a paper on a case of yellow-blue blindness, and its bearings on the theories of dichromasy. The historical aspect of the Young-Helmholtz theory is as follows: (1) Young gave his theory of colour-blindness by lapse of one sensation, stating that this seemed to him to be simpler than any other assumption. But, as with his theory of colour-vision, he meant this theory to be given up if it were subsequently found to be inconsistent with experiment. (2) Helmholtz added his ideas regarding the nature of the mechanism, adopting *implicitly* Young's reservations, and stating *explicitly* that his ideas, if false, did not affect the basis of Young's theory. (3) In accordance with the above facts, when E. Rose brought forward the evidence of his observations, Helmholtz at once indicated the probable direction in which the statement of the theory had to be modified. (4) Subsequently, Helmholtz's pupils, König and Dieterici, working pre-umably under his direction, made a crucial test to find if it were absolutely essential to abandon the idea of lapse of a fundamental sensation, and found that it was necessary to do so. (5) König investigated, at different parts of the spectrum, the mean error of wave-length which could be made in adjusting light from different near parts of the spectrum to equality. (6) Helmholtz gave an expression, in terms of the unknown fundamentals, for the rate at which the total "sensation" varies with wave-length. He wrote down three linear equations, with unknown coefficients, expressing the three fundamental sensations in terms of those chosen (arbitrarily so far) by König and Dieterici. The latter were known in terms of the wave-length by means of the observations of these two investigators. Therefore, if Helmholtz could determine the unknown coefficients, he could express the other fundamentals in terms of the wave-length. Now an obvious assumption to make is this: the mean error of wave-length which can be made in adjusting two very narrow strips, one from each of two similar spectra, to apparent equality corresponds to a constant difference of total "sensation." Helmholtz made this assumption in order to determine the unknown coefficients by means of König's observations on the mean error. And he further justified this by showing that there was a close correspondence between the mean errors found by König and the mean errors calculated from his own theory on the assumption of a constant difference of sensation. Thus the new fundamentals, given by Helmholtz as "provisional," may be regarded as having been determined upon a purely experimental basis, with no assumption other than the radical assumption of three fundamental sensations. The whole thing is a beautiful example of the cautious, steady, scientific development of a theory. There has not been, by Helmholtz, any violent upholding of a weakened theory, followed by a sudden facing round after defeat. In violet, or yellow blue, blindness, the two colours of the spectrum are red and bluish-green, and the spectrum is shortened at the blue end with a sharp limit near the line G. Blindness of this type is rare. The case described in this paper presents the peculiarity that there is no shortening of the spectrum at either end. The range extends beyond the line *a* at the red end, and beyond the line *h* at the violet end. The

neutral point is near the line D, on the more refrangible side. The maximum intensity of the red colour is reached at a point near C on the less refrangible side, and the maximum intensity of the green colour is reached at a point rather nearer to F than the mid-distance from C to F. There is no second neutral point in the blue. It does not seem that the phenomena can be readily, if at all, accounted for on Hering's theory. On the other hand, it is easily accounted for on the Young-Helmholtz theory by fusion of the fundamental sensations.—Dr. N. H. Paton read a paper, by Dr. John Douglas, on metabolism in thyroid feeding.—Dr. Richard Berry read a paper on the anatomy of vermiform process and cæcum.—Prof. Tait communicated a paper on the ultimate state of a system of colliding particles, and the rate of approach to it.

PARIS.

Academy of Sciences, January 21.—M. Marey in the chair.—On the variable star  $\beta$  Algol in Perseus, by M. F. Tisserand. The author represents the variation in apparent magnitude as being due to (1) the existence of one obscure satellite with an elliptical orbit, and (2) a slight oblateness of the principal star, and shows that on these assumptions the variation period can be satisfactorily represented (see Our Astronomical Column).—On boron steel, by MM. H. Moissan and G. Charpy. As the result of a series of comparative tests, it is found that boron (0.58 per cent. in alloy used) imparts the property of a great increase in tensile strength by tempering without a corresponding increase of hardness. A sample of carbon steel giving similar increase of tensile strength on tempering, became so hard as to require working on the emery-bob, whereas the boron-steel could still be worked with a file.—Morphology of the lymphatic system. On the origin of the lymphatics in the skin of the frog, by M. L. Ranvier.—On the perforation of armour-plates, by M. E. Vallier.—On the production of the glycolytic ferment, by M. R. Lapine. The author is of opinion that the glycolytic ferment is produced from diastase. He relies on the increase of glycolytic power of pancreas when treated with dilute sulphuric acid, in conjunction with the loss of saccharifying power and gain of glycolytic power suffered by maltine when similarly treated with dilute acid.—*Revision of solar observations, made at the Royal Observatory of the Roman College, during the three last quarters of 1894.* A letter from M. P. Tacchini sent to the President. On the convergence of determinants of infinite order and of continued fractions, by M. H. von Koch. Influence of the rhythm of successions of interruptions on the sensitiveness to light, by M. Charles Henry. The investigation had for object the determination of the sensitiveness of the eye to interrupted light-rays of different types. The conclusion is drawn that it is possible to augment the luminous range of a signal by means of a succession of interrupted rays following a suitably complex non-rhythmic law.—Influence of temperature on the transformation of amorphous zinc sulphide, by M. Vallier. Failure of the Kjeldahl method for estimation of nitrogen when applied to chloroplatinates, by M. Delpine. In the case of trimethylamine and ammonium platinochlorides, the author finds by the permanganate modification of the Kjeldahl process a considerable deficiency in ammonia obtained. This deficiency is attributed to a reaction of free chlorine with the ammonia, as follows:



On  $\alpha$ -bromo-chloral and  $\gamma$ -chloral, by M. Harriot.—A new synthesis of anthracene, by M. Delacre. Anthracene is produced from benzyl trichloroacetate and benzene, by heating these substances in presence of aluminium chloride, and distilling the resultant ether, when it decomposes giving carbon dioxide and anthracene.—A contribution to the study of the ethereal salts of the tartaric acid, by MM. Ph. A. Guye and I. Fayollat. A study of the rotatory power of some of these esters in the light of the theory of the production of asymmetry.—On a parasite of *Lampyrus splendens*, by M. A. Couvel. The author names the newly-described parasite *Cydonia lampyridis*. On some bacteria from the *Thymus* (Colum), by M. B. Renault.

On the development of sieve-tubes in the Angiosperms, by M. Chauveau. The author concludes that (1) the rule of indirect development of sieve-tubes is far from general. Both direct and indirect methods of development may occur in the same bundle. (2) The presence of companion cells is not absolutely characteristic of the sieve-tubes of Angiosperms. On the Chili-Argentine earthquake of October 27, 1894, by M. A. F. Sanguin.—Note on *Urobolus*, by M. L. Daille.

BOOKS, PAMPHLETS, and SERIALS RECEIVED.

Books.—A First Step in Euclid: I. G. Bradshaw (Macmillan).—Memoir of Sir Andrew Crombie Ramsay: Sir A. Geikie (Macmillan).—A Handbook to the British Mammals: R. Lydekker (Allen).—The Great Problem of Substance and its Attributes (K. Paul).—A Travers le Caucase: J. Levier (Neuchâtel, Attinger).—Forschungs-berichte aus der Biologischen Station zu Plon: Dr. O. Zacharias, Theil 3 (Berlin, Friedländer).—How to Live in Tropical Africa: Dr. J. Murray (Phlip).—Field and Garden Crops of the N.W.P. and Oudh: J. F. Duthie, Part 3 (Roorkee).

PAMPHLETS.—Sur la Nature et l'Origine de l'Aurore Boréale: A. Paulsen (Copenhague).—Der Logische Algorithmus: J. Hontheim (Berlin, Dames).—International Beginnings of the Congo Free State: Dr. J. A. Reeves (Baltimore).

SERIALS.—Journal of the Sanitary Institute, January (Stanford).—National Geographic Magazine, December 29 (Washington).—Transactions of the American Institute of Electrical Engineers, November and December (New York).—Imperial University, College of Agriculture, Bulletin Vol. II No. 3 (Tokyo).—Records of the Botanical Survey of India, Vol. I, Nos. 3 and 4 (Calcutta).—Psychological Review, January (Macmillan).—Monist, January (Chicago).—Himmel und Erde, January (Berlin).—English Illustrated Magazine, February (Strand).—Sunday Magazine, February (Hibster).—Good Words, February (Hibster).—Astrophysical Journal, January (Wesley).—Longman's Magazine, February (Longmans).—Chamber's Journal, February (Chambers).—Observations Internationales Plaires, 1882-3. Expédition Danaise, Observations faites a Godthaab, tome I, livr. 2 (Copenhague).—Humanitarian, February (Hutchinson).—Natural Science, February (3ait).—American Naturalist, January (Wesley).—Journal of the College of Science, Imperial University, Japan, vol. VII, Parts 2 and 3 (Tokyo).—Transactions of the Linnean Society of London, Vol. IV, Part 2, On the Flora of Mount Kinabalu in North Borneo: Dr. O. Stapf (Linnean Society).—Ergebnisse der Beobachtungsstationen an den Deutschen Küsten über die Physikalischen Eigenschaften der Ostsee und Nordsee und die Fischeret, Heft 1-6 (Kiel, Lipsius).

CONTENTS.

PAGE

Geo-Morphology. By Dr. J. W. Gregory	313
Organic Chemistry	317
Our Book Shelf:—	
Wyatt. "British Birds being Coloured Illustrations of all the Species of Passerine Birds resident in the British Isles, with some Notes in reference to their Plumage"	318
Nabe: "Standard Methods in Physics and Electricity Criticised, and a Test for Electric Meters Proposed."—W. W.	318
Slingo and Brooker "Electrical Engineering, for Electric Light Artisans and Students"	318
Orford: "Lens-Work for Amateurs"	318
Rolleston and Knitlock: "Manual of Practical Morbid Anatomy"	318
Letters to the Editor:—	
A New Step in Statistical Science.—Francis Galton, F.R.S.	319
The Kinetic Theory of Gases.—G. H. Bryan	319
Boltzmann's Minimum Function.—S. H. Burbury, F.R.S.	320
Electroscopes in Lecture.—Prof. Oliver J. Lodge, F.R.S.	320
The Perseid Meteors.—W. F. Denning	320
The Artificial Spectrum Top.—Dr. F. W. Edridge-Green; Charles E. Benham	321
Snake Cannibalism.—H. Tsnagal	321
More About Moths.—L. C. Jones	321
The Physical Society's Abstracts of Physical Papers from Foreign Sources	321
The Natural History of the Solway. By G. Stewardson Brady	322
Professor Arthur Cayley, F.R.S.	323
Notes	323
Our Astronomical Column:—	
The Natal Observatory	327
The New Dudley Observatory	327
The Milky Way	327
The System of Algol	328
The Explosive Nature of the Sodium and Potassium Derivatives of Nitromethane. By A. E. Tutton	328
Recent Work at Harvard College Observatory	329
Electric Discharge through Gases. (Illustrated.) By Prof. J. J. Thomson, F.R.S.	330
University and Educational Intelligence	333
Scientific Serials	333
Societies and Academies	334
Books, Pamphlets, and Serials Received	336

THURSDAY, FEBRUARY 7, 1895.

## ARGON.

THE scene in the theatre of the University of London on Thursday last was in many respects unique. It will certainly be historical. It was unique in that the Royal Society had formally invited members of two other scientific bodies to attend the meeting, and had left the comparative seclusion of Burlington House to meet, in Burlington Gardens, an audience numbering at least eight hundred. It was the first of a series of discussion meetings to which, we suppose, similar invitations will be issued; but it will be long before the same eagerness to obtain a ticket is displayed—long before those who gain admission, will listen to so much worth hearing.

The previous history of the subject to be "discussed" is known to most of our readers. Lord Rayleigh has for some years been engaged on one of the most difficult of physical measurements, namely, the determination of the densities of some of the more permanent gases. In the case of nitrogen, he was confronted with the fact that if obtained from chemical compounds, it was about one half per cent. lighter than if extracted from the atmosphere. This result he published in the spring of last year, and the cause of the discrepancy was a subject of general conversation in scientific circles. Lord Rayleigh himself discussed it with some of his chemical friends. Prof. Ramsay was interested, and since last Thursday he has confided to an interviewer some details as to the part he played in solving the problem. It appears that he asked Lord Rayleigh's permission to investigate the matter, that using a chemical method he succeeded in separating a heavier constituent from atmospheric nitrogen, and that on writing to Lord Rayleigh, he learned that he, too, had achieved the same result by a process of "sparking."

The fact of the discovery was announced in a semi-public way at the meeting of the British Association at Oxford. Of course it attracted great attention, and curiosity was further stimulated by the silence of the discoverers during the five succeeding months. Towards the end of last year it was announced that they would give their results to the world in January. On Thursday last the promise was fulfilled, and all that is known of "Argon" was told to all.

Three papers were read, which showed that the period of silence had been devoted to strenuous work. It was proved beyond possibility of doubt or question that the atmosphere contains a hitherto unknown constituent. It has been separated from the air by *atm*olysis, by red-hot magnesium, and by "sparking." Its density has been determined to be about 1.7. It is very soluble in water, and it has been proved that the nitrogen extracted from rain-water is twice as rich in argon as that which exists in the air.

Mr. Crookes has found that the new substance has two spectra, marked by red and blue lines respectively. Both he and Prof. Schuster certify that the principal lines are identical in the case of two specimens obtained by different methods. The properties at very low tempera-

tures have been determined by Prof. K. Olszewski, of Cracow. The critical temperature is  $121^{\circ}\text{C}$ ., the critical pressure 50.6 atmospheres. The liquid boils under a pressure of 740.5 m.m. at  $-186.9$ , having at the boiling point a density of about 1.5. The melting point is about  $-189.6$ , and it has been frozen into a white solid resembling ice. Last, but not least, the ratio of the specific heats of the gas is approximately 1.66, and all attempts to induce it to enter into chemical combination with other substances have up to the present entirely failed.

After this torrent of well-established facts, it cannot reasonably be doubted that Lord Rayleigh and Prof. Ramsay have really discovered a substance, which, though existing in enormous quantity, has hitherto defied detection. Lord Rayleigh's work first showed that there was something to explain; the patience and masterly skill which he displayed throughout years devoted to weary weighings, must command universal admiration. As has been well said, the result is "the triumph of the last place of decimals," that is, of work done so well that the worker knew that he could not be wrong. Prof. Ramsay, too, is to be congratulated in that when this preliminary stage had been accomplished, his energy and skill enabled him to take such a share in the hunt after the unknown cause of the difficulty, that he rightly ranks as a co-discoverer of the new gas.

In scientific investigations, however, the answer to one question always suggests others, and interest in a discovery quickly precipitates into interest in its results. Seldom have a series of facts and figures raised more important issues. The ratio of the specific heats is 1.66, which points to the conclusion that the substance is monatomic. If it is monatomic, it must be an element or a mixture of elements. If it is a single element, its atomic weight must be about 40, and in that case no place is ready for it in Mendeléeff's table. The easiest way out of the difficulty is to suppose that argon is a mixture, and the authors point out that there is evidence for and against this view: "for, owing to Mr. Crookes observations of the dual character of its spectrum; against, because of Prof. Olszewski's statement that it has a definite melting point, a definite boiling point, and a definite critical temperature and pressure; and because on compressing the gas in presence of its liquid, pressure remains sensibly constant until all gas has condensed to liquid. The latter experiments are the well-known criteria of a pure substance, the former is not known with certainty to be characteristic of a mixture." The question is to be further investigated, but at present the authors conclude that the balance of evidence is in favour of simplicity.

On this hypothesis a very awkward question is no doubt raised. The periodic classification of the elements cannot, and ought not, to be abandoned at the first challenge, and till further evidence is forthcoming a heavy strain is thrown on the link of the chain of argument which connects the ratio of the specific heats with the monatomicity of the gas.

On the other hand, the conclusion that if the ratio of the specific heats is 1.66 the gas can be diatomic, is directly contrary to all analogy. Merely to say that mercury is monatomic, that Kundt found that the

ratio of the specific heats is one and two-thirds, and that therefore a similar relation must hold for argon, is to underestimate the case. Taking the very outside values, no diatomic gas has a ratio greater than about 1.42; and to place among these a substance for which the ratio is 1.07, would be entirely opposed to all the other indications of a theory which, though admittedly only approximate, nevertheless in all other cases accords fairly with the conceptions of the physicist. The behaviour of mercury vapour suggests that there are two classes of phenomena which occur within the molecule—a coarser group with which the ordinary mechanical theory of gases is concerned, and a more refined type detected by the spectroscope. It is the former, and not the latter, which are of the same order as the chemical facts which lead to conclusions as to the number of atoms in the molecule.

Thus, in the case of mercury vapour, the mechanical theory of gases ignores the vibrations, whether mechanical or electrical, which produce the spectrum, and gives the precise value of the ratio of the specific heats which corresponds to three degrees of freedom. Whether we frame a mental picture of a Bos with points, or are content with the more usual contradictory image of a smooth sphere, perfectly elastic, and yet incapable of internal vibrations, is for the present purpose comparatively unimportant. It is impossible to connect the conception of three degrees of freedom with anything that does not behave as one single thing, incapable of being set in rotation, and incapable of internal vibration. That such a thing may have structure is not denied. It is only affirmed that as far as the phenomena under investigation are concerned, structure is not recognisable. It is not denied that it may be subject to internal changes. It is only affirmed that these changes are of different order from the causes which affect the behaviour of the molecule in what may be called the pressure-producing machinery of a gas. Where the ordinary dynamical theory stops, there, and there, too, the chemical analysis stops also. The chemical facts which prove that mercury is monatomic have nothing to do with its spectrum. The arguments used would be valid if it had no spectrum at all. Analysis reveals no structure in the indivisible molecule of argon. In chemistry, and in the approximate theory of a "monatomic" means in this case, at all events, the same thing.

The case of the diatomic gases.

The result of the dynamical theory can be most easily repeated if we suppose the atoms to be smooth spheres, which may, for the present, be regarded as mere geometrical surfaces surrounding Boscovitch centres.

The theory holds that, unless the two atoms when united can be fully represented by a single point or a single smooth sphere, the ratio of the specific heats ought to be greater, but never less, than 1.4. This value would correspond to the case of two smooth spheres the surface of which we imagine to be in contact, or to two centres maintained at a certain fixed distance apart, but otherwise free. Smaller values would indicate greater internal freedom.

The gases may be divided into two classes, viz.  $\text{O}_2$ ,  $\text{N}_2$ ,  $\text{H}_2$ ,  $\text{CO}$ ,  $\text{NO}$  and  $\text{HCl}$ , and, secondly,  $\text{Cl}_2$ ,

$\text{Br}_2$  and  $\text{I}_2$ . The mean of the ratios of the specific heats for the first six is, according to Masson,<sup>1</sup> 1.399. The corresponding figure deduced from Regnault's experiments is 1.410. The highest value obtained from Regnault is 1.42 in the case of  $\text{HCl}$ , but Masson's value for the same gas is only 1.302, the mean being 1.406. In the cases of  $\text{Cl}_2$ ,  $\text{Br}_2$  and  $\text{I}_2$  the values are lower, lying between 1.293 and 1.323. The larger values thus in some cases slightly exceed, but are in all cases very close to, the limit fixed by the theory on the assumption that the dual character of the molecule can be recognised by it. The smaller values fall well within the limit.

The ratio of the specific heats has not been directly determined for many substances, but it can be calculated by well-known formula for all gases of which the specific heat at constant pressure is known, and though the values thus obtained are only approximate, they are sufficient to prove that the molecules of the more complex gases have always more than the minimum number of degrees of freedom which are consistent with the idea of their being built of smooth spheres constrained to remain in contact, and equal in number to the number of atoms within the molecule. Whereas, if argon is a diatomic substance, the molecule has fewer degrees of freedom than the theory indicates, and is thus the single exception to a universal rule. In that event it is not too much to say that the result will indicate a connection between its atoms of a kind absolutely different from that in any other known substance. In all other cases the approximate dynamical theory is in close agreement with the view that molecular structures made up of the union of two or more like or unlike things, have a more or less irregular form, and are capable of rotation. If argon is not monatomic, this rule will for the first time be broken. Quite apart from the absolute validity of the theoretical grounds on which it is based, and regarded only as suggested and not as completely justified by theory, it is nevertheless an empirical generalisation which up to the present has stood every test.

It is not sufficient to explain the difficulty by saying that the bonds between the constituents of the argon molecules must be very strong, for we have already assumed that the tie which unites the centres of the hydrogen or oxygen atoms is proof against the collisions which occur in the gas. *i.e.* is for the purposes of the approximate theory infinitely strong. It is further necessary that the molecule must be incapable of rotation, that the two points must coincide, or the two spheres be crushed out of shape, so that the surface is spherical. Such violent assumptions would be quite unjustifiable unless we are driven to them by facts which cannot be disputed. Until it is directly proved that argon is diatomic, we must agree with the discoverers that the weight of evidence is in favour of the molecule being indivisible. Whether in the future other and more convincing evidence will be adduced on the other side, the future alone can show. The courts of science are always open, and every litigant has an unrestricted right of moving for a writ of error.

<sup>1</sup> See K. Strooker, *Wet. Ann.*, 1884, p. 40.



## A TEXT-BOOK OF BOTANY.

*Lehrbuch der Botanik.* By Drs. E. Strasburger, F. Noll, H. Schenck, and A. F. W. Schimper. (Jena: Fischer, 1894.)

THIS book is intended for the use of students in the German *Hochschulen*; throughout it is written in a manner which is at once interesting and exact. According to the usual plan adopted in text-books of the kind, it is divided into two parts—the first dealing with general botany, and the second with special botany. In a general introduction a short *résumé* is given of the theories of descent and of natural selection, with a view to their bearing on the subject of the natural boundary between the animal and vegetable kingdoms.

The first division of the first part is devoted to the general morphology of plants. It is written by Prof. Strasburger. This whole subject he treats from a phylogenetic point of view, and so renders, what is in many botanies little more than a list of difficult names and their explanations, extremely interesting and suggestive reading. A good example of this will be found in his account (p. 26) of the leafy stipules of *Lathyrus aphaca*. In this connection it may be noticed that having once described the more important forms, he does not enlarge on the very various shapes and modifications assumed by leaves, stems, &c., as is often done in text-books, where the writers often appear to glory in the number of curious terms they collect descriptive of the forms of the members of plants—terms which, if it is necessary for the student to learn, might be more easily mastered if printed as a kind of botanical vocabulary or glossary, instead of rendering such an attractive subject as vegetable morphology a monotonous exercise of the memory. In the portion devoted to anatomy and histology we find the structure of the cell and its contents extremely lucidly described. The digression on p. 45, with regard to some of the properties of protoplasm and the effect of high temperatures and of reagents upon it, might have, perhaps, come more appropriately in the part of the book allotted to physiology. In the account of the systems of tissues in vascular plants, and their morphology, we are furnished with the results of recent work in this direction, of which so much is due to the author's own researches. With regard to the origin of these tissues, he disputes the theory according to which the meristematic apex of the stems and roots of planerogamic plants is differentiated into three distinct initial layers. He urges that the arrangement of the cells in these regions is rather due to mechanical causes, and that the terms Dermatogen, Plerome, and Periblem should be used simply to facilitate the description of certain cell-layers in the vegetative cone, without involving the idea of the presence of distinct Histogens, as they have been called. Throughout this whole portion on general morphology, we feel that the space has been too limited, and we wish that the author had not restricted himself to the 126 pages allotted, but had allowed himself to enter more fully on the numerous points of interest in this subject which he, perhaps beyond all others, is capable of discussing.

The same remark may also apply to Dr. Noll's part on physiology. It is throughout too much abbreviated.

Apart from this defect, which is involved in the nature of the book, it is very attractively written, and by its logical arrangement and clear descriptions does much to atone for the necessary crowding of facts. The chapter on the phenomena of movement in plants strikes us as suffering the least from the condensed nature of the writing, and seems to be a good account of both earlier and recent researches on the subject.

The special botany is the work of Dr. Schenck and Prof. Schimper. The classification adopted is that proposed by Braun, and elaborated by Eichler and others. Little need be said of this portion, except that much trouble appears to have been taken to make the descriptions, so far as possible, include the results of modern work. At the end of the book there is a list of medicinal and of poisonous plants, as well as a very complete index. It is to be regretted that the authors have not given some references to the literature of the subjects of which they treat, so that the student might be helped to pursue more fully his studies in the directions he desired. The book is throughout profusely illustrated by means of extremely good figures, many of which are tastefully coloured. The figures are, to a large extent, new, and those which are not specially designed for the book are well selected, in part, from Prof. Strasburger's other works and, in part, from sources which are not commonly familiar to English readers, so that in this way the value of the book is enhanced. With regard to the coloured figures, they have this novelty—that they are inserted in the text, and are not in the form of separate plates. H. H. D.

## A NEW POPULAR BOOK ON BRITISH BUTTERFLIES AND MOTHS.

*Butterflies and Moths British.* By W. Furneaux, F.R.G.S., author of "The Out-door World, or Young Collector's Handbook." With twelve coloured plates, and numerous illustrations in the text. (London: Longmans, Green, and Co., 1894.)

THE success of Mr. Furneaux's "Out-door World" was sufficiently marked to induce the publishers to make it the first of a series of popular illustrated works on British Natural History, to be called "The Out-door World Library." Of this series, the volume before us forms the second: and we observe that others are projected, on British Birds, Mammals and Reptiles, Pond-Life, &c.

This is pre-eminently a beginner's book, written in a popular style throughout, and it has also been nicely printed and illustrated, so as to make it as attractive-looking as possible. Hence the practical part of the subject is dealt with at length, while questions of a purely academic nature, such as synonymy, are wisely omitted almost entirely. English names are given the most prominent place; but the scientific names used in South's List are added in brackets.

The book is divided into four parts: Structure and Life-history of the Lepidoptera; Work at home and in the field; British Butterflies; and Common British Moths. The appendices include a list of British *Macro-Lepidoptera* according to South's "Synonymic List," as far as the end of the *Geometridæ* (the English names here being in brackets), and a Lepidopterist's Calendar.

The introductory chapters are very good, and the woodcuts are neat and instructive, especially that of the neuriation of a butterfly, on p. 9. We could have wished that Mr. F. Furneaux had had space to treat of such important subjects as neuriation and the scaling of the wings in detail. The early stages of *Lepidoptera* are also discussed and illustrated; and we notice that our author calls the head of a caterpillar the "first segment." We know that some hypercritical authors object to the head of an insect being called a segment, because it is morphologically considered to be made up of so many "somites." But to refuse to allow the head of an insect to be called the first segment (in the case of caterpillars, at least) appears to us as absurd as it would be to object to the skull being spoken of collectively, because it is morphologically regarded as composed of a number of modified vertebrae. On the other hand, we think that Mr. Furneaux has been injudicious in calling the five membranous pairs of legs of a caterpillar "claspers," a term properly applicable to the last pair only. We think the usual distinction made between the last pair and the others should be preserved in speaking of them, though the term by which the other legs are generally known (prolegs) is perhaps not quite correct.

The directions for collecting and preserving appear to have been written by an experienced practical collector, with his heart in his work. However, when insects are set in it, the groove is generally made deeper than is shown in the illustrations on p. 123. The advice to start at once with a cabinet, spaced out for all species, may be very good for those who can afford to buy a large cabinet off hand; but many of Mr. Furneaux's readers will certainly find it too costly, and we fear that any beginner who commences in such a manner will find his patience exhausted at his slow progress, and might give up the study of insects prematurely in disgust.

No terminal characters are given for species, genera, or even families; and, strangely enough, the Seraphims *Lophophora* are said to differ from the Pugs (*Lufpophora*) by their not covering their hind-wings when at rest; a difference being made of the curious appendages to the hind-wings of the males in *Lophophora*, which gives them the appearance of having six wings, and has suggested the name of "seraphim."

Generally speaking, however, the accounts of the various species discussed (all the butterflies and a good series of representative moths, at least among the *Macrolepidoptera*) are very good. Here and there, however, we meet with a doubtful statement, as that "the Black-veined White is hardly to be distinguished from the common Large White on the wing." Those accustomed to see both would hardly concur in them, nor would the former frequent open ground at a distance from trees.

The numerous woodcuts are of unequal merit, but a high standard of excellence is maintained throughout, and most of them are easily recognisable. The coloured plates, though recognisable too, are, we regret to say, not up to the standard of the woodcuts. Sometimes the colour is inaccurate, as in the case of the Purple Emperor, which has been represented a lilac rather than blue. It is, of course, a difficult matter to figure, but has been represented better in many popular books of late years. In the first two plates an attempt has

been made to throw up the colour of the insects (mostly whites and yellows) by shading. This has given rise to the appearance of an ugly smoky rim round the figures; and the experiment has been wisely abandoned in the remaining plates. We regret this the more, as the desired effect has been admirably attained by using a tinted background in Prof. Aurivillius' recent work on the butterflies and moths of Northern Europe; and we should like to see this improvement introduced into other books of a similar kind.

W. F. KIRBY.

#### OUR BOOK SHELF.

*Die Resultate der Aetzmethode in der krystallographischen Forschung, an einer Reihe von krystalisirten Körpern dargestellt.* Von Dr. H. Baumhauer. Mit 21 Textfiguren und einer Mappe mit 48 Mikrogrammen auf 12 Tafeln in Lichtdruck. Pp. 131. (Leipzig: Wilhelm Engelmann, 1894.)

It has long been known that the action of a reagent upon a smooth plane surface of a mineral substance may reveal details of structure previously invisible, and that such a mode of investigation has been extremely useful in the case of meteoric iron; indeed, the method is particularly valuable in that case by reason of the fact

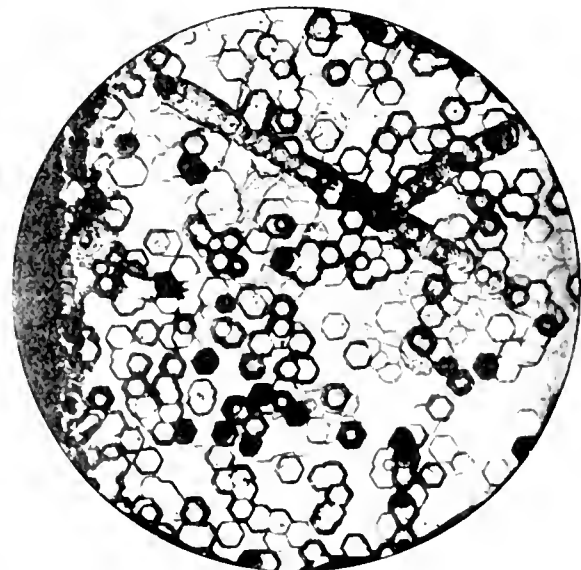

that the structure thus revealed is different from the structure of terrestrial iron.

The researches of Leydolt, Baumhauer, and others, have shown us that the figures produced by reagents on the faces of the crystals which are met with among minerals, or are artificially prepared by the chemist, though dependent on the kind and strength of the reagent, are yet characterised by a symmetry which conforms with that of the crystalline structure; further, the etched figures serve to indicate by their forms the particular kind of symmetry (holosymmetry, hemisymmetry, tetartohymmetry, twinning) belonging to the crystalline structure, in many cases where other characters, physical or morphological, are insufficient for the purpose; they are especially useful in the investigation of isomorphism.

The etched figures can be observed, for instance, in the case of a crystal of which the opacity renders investigation by means of transmitted polarised light impossible; and, even in the case of a transparent

crystal, they often serve to determine the particular type of symmetry to which the structure belongs when polarised light may merely indicate whether the crystal is optically isotropic, uniaxial, or biaxial. Dr. Baumbauer has done a great service by preparing for publication a series of magnified photographs of the figures produced by etching different faces of crystals of the following substances:—Fluor, Bleu le, Cryolite, Apatite, Nepheline, Ditolite, Zinnwaldit-, Leicite, Boracite, D lomite, Magnesite, Chalybite, Nickel sulphate, Strychnine sulphate.

The figure on the previous page shows the hexagonality of the depressions which, after etching, are seen on a basal plane of a crystal of Apatite.

These beautifully executed photographs are accompanied by detailed descriptions (85 pp.), and by a sketch of the history and development of the methods (46 pp.). Dr. Baumbauer has done such excellent work in this branch of science, that he is particularly qualified to select and describe examples which illustrate the potentiality of this mode of investigating crystalline structure. The photographs are mounted on twelve separate plates, so that they may be conveniently used in the classroom.

*Summer Studies of Birds and Books.* By W. Warde Fowler. Pp. 288. (London: Macmillan and Co., 1895.)

*Forest Birds; their Haunts and Habits.* By Harry F. Witherby. Pp. 98. (London: Kegan Paul, Trench, Trübner, and Co., 1894.)

IT would be difficult to find a worthier disciple of Gilbert White than Mr. Warde Fowler. Many of White's most exact and enduring observations were made on birds, and the "Natural History of Selborne" has furnished his imitators with descriptions of the characteristics of the Stone-curlew, the Ring-ousel, the Hoase-martin, the Sand-martin, the Goat-sucker, and many more of the birds of which he recorded the habits and movements. But Mr. Fowler's writings are not mere paraphrases of his prototype's. He is gifted with the "nice observation and discernment" required by every student of nature; and he can express himself in attractive language— attractive because it is unaffected, and because it is devoid of thin sentiment and gush. The result is that the papers reprinted in this volume are really valuable contributions to ornithology. To remark that there is not a dull page in the book may be a trite saying; nevertheless, so far as we are concerned, it is a true one in this case. What could be more readable than the chapters on the birds of the Engstlen Alp, and the birds of Wales; and where will you find a better example of careful and painstaking observation than is afforded by the account of the Marsh Warbler in Oxfordshire and Switzerland? The chapter on the songs of birds is most interesting; that descriptive of Aristotle's writings on birds, (in which fact and fiction are given equal prominence), should be read by all naturalists; and the biography of Gilbert White shows that the author is saturated with the spirit of the naturalist whose work has had such a wide influence upon natural history during the last hundred years.

Little more need be said about this charming book. So many volumes on popular natural history have lately appeared, that the subject has probably begun to pall upon the public taste. Mr. Warde Fowler's work, however, is so full of interest; it breathes out the air of the fields and streams so pleasantly, that it carries its own welcome to the heart of every lover of nature.

The second of the two books of which the titles are given above, is of quite a different character from the first. It is remarkably well illustrated, is daintily bound, and is nicely printed, and therefore it forms an attractive volume, so far as appearances go. But the text is

dull; for the author, while possessing the essential love of nature, lacks the words with which to express it eloquently. To him, "the Stock Dove is fourteen inches in length from the tip of the beak to the end of the tail, and its stretch of wing is twenty-six inches. Its general colour is bluish-grey. The head, wings, and back are of this colour, and the tail is the same, but tipped with leaden grey." There is much more of the same kind in the book; and we confess that after reading Mr. Warde Fowler's smooth phrases, Mr. Witherby's composition appears spiritless. The illustrations, however, are good enough to make up for deficiencies of the text, and for their sake alone, the book is worth buying.

LETTERS TO THE EDITOR.

[The Editor does not hold himself responsible for opinions expressed by his correspondents. Neither can he undertake to return, or to correspond with the writers of, rejected manuscripts intended for this or any other part of NATURE. No notice is taken of anonymous communications.]

On the Age of the Earth.

IN reference to Lord Kelvin's letter (NATURE, January 3, p. 227), he will, no doubt, presently communicate with you on the results of measurements which he is making on conductivity and temperature in rocks. I do not wish to forestall him by referring at present to his more recent correspondence with me. Three weeks ago I sent him the solution of the problem of a cooling sphere whose conductivity  $k$  and volumetric capacity  $c$  are any functions whatsoever of the temperature  $\tau$ , but which are always proportional to one another. As Mr. Heaviside had been writing to me, and had shown me that under certain circumstances the differential equation became linear, and as I had used his operators much as he himself uses the  $\sigma$ , I cannot say to what extent I can claim credit for the work. I now venture to send you the more general case.

If

$$\int c \cdot d\tau = u \dots \dots \dots (1)$$

so that  $u$  is the total amount of sensible heat in unit volume. The general equation is

$$\frac{d}{dx} \left( k \frac{d\tau}{dx} \right) + \frac{d}{dy} \left( k \frac{d\tau}{dy} \right) + \frac{d}{dz} \left( k \frac{d\tau}{dz} \right) = \frac{du}{at} \dots \dots (2)$$

Now let  $k = \kappa c$  where  $\kappa$  is a constant, then

$$k = \kappa \frac{du}{d\tau} \text{ as } c = \frac{du}{d\tau}$$

and the equation becomes

$$\frac{d^2u}{dx^2} + \frac{d^2u}{dy^2} + \frac{d^2u}{dz^2} = \frac{1}{\kappa at} \frac{du}{d\tau} \dots \dots \dots (3)$$

Any of the many problems that have been worked out on the distribution of  $u$  may be translated into temperature problems. Thus in a body before  $t = 0$  let  $u = u_1$  a constant everywhere, and after  $t = 0$  let the surface have everywhere a constant  $u = u_0$ . Let the solution be

$$u = (u_1 - u_0)F(x, y, z, t) \dots \dots (4)$$

In the body before  $t = 0$  let  $\tau = \tau_1$  a constant everywhere, and after  $t = 0$  let the surface have everywhere  $\tau = \tau_0$  a constant, then if  $\tau$  is the temperature anywhere

$$\int c \cdot d\tau = (u_1 - u_0) \int F(x, y, z, t) \dots \dots (5)$$

so that a table of the values of  $\int c \cdot d\tau$  enables the temperature at any place to be calculated.

If  $\frac{du}{dt}$  the rate of increase of  $u$  normally inward from the surface at any place, has been calculated, say that it is

$$\frac{du}{dt} = (u_1 - u_0)F(x, y, z, t) \dots \dots (6)$$

Comparison of Ocean Temperature obtained at Different Times in or near the same position, viz. 5° 48' N., 14° 20' W.

Depth in fathoms.	Challenger, 1873, Aug.	Challenger, 1876, April	Buccaneer, 1880, Jan.	Waterwitch, 1894, Sept.
Surface	70.2	83.75	85.5	80.0
10	—	83.2	82.5	78.0
20	—	70.0	70.6	—
25	72.0	—	60.0	75.2
30	—	62.0	65.0	69.2
40	—	60.0	60.8	62.8
50	62.5	50.2	58.8	60.2
60	—	58.5	—	—
70	—	57.8	—	—
75	58.8	—	—	58.8
80	—	57.4	—	—
90	—	56.5	—	—
100	50.2	55.0	50.4	57.0
110	—	55.2	—	—
120	—	54.6	—	—
125	54.4	—	—	—
130	—	54.0	—	—
140	—	53.3	—	—
150	52.2	52.7	—	52.5
160	—	52.4	—	—
170	—	51.4	—	—
180	—	50.8	—	—
190	—	50.1	—	—
200	48.3	49.5	49.0	—

Latitude and Longitude of Spot

Ship	Lat. 5° 48' N.	Long. 14° 20' W.
Challenger, 1873, Aug.	—	—
Challenger, 1876, April	5 28	14 38
Buccaneer, 1880, Jan.	5 48	14 20
Waterwitch, 1894, Sept.	5 48	14 22

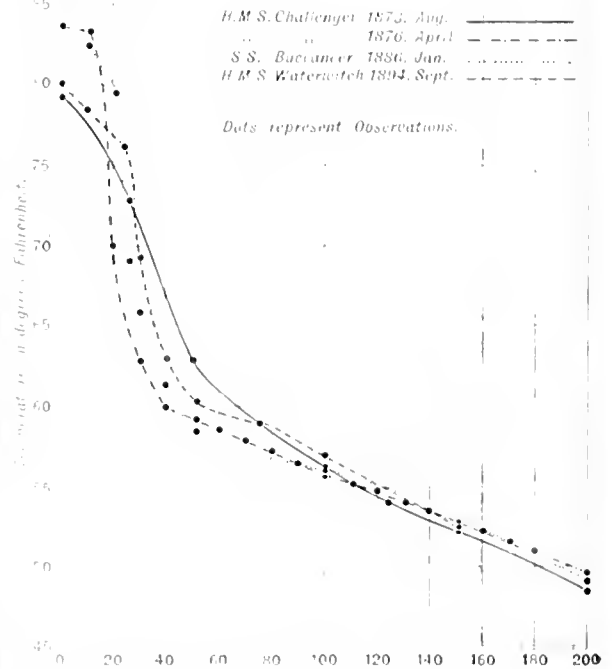

Diagram showing temperature at different depths obtained at various epochs in Lat. 5° 48' N. Long. 14° 20' W.

It will be observed that the temperatures at the surface vary by 0.3 F., at a depth of 20 fathoms by 0.6; at 40 fathoms,

as the temperature gradient inwards from the surface, and is the value of  $\frac{d\theta}{dz}$  at the surface.

If  $\theta_0$  and  $\theta_1$  are constant everywhere, say  $\theta_0$  and  $\theta_1$ , let us call the surface gradient  $\theta_0 - \theta_1$  then as usual  $\theta = \theta_0 - \frac{z}{L}(\theta_0 - \theta_1)$

$$\frac{d\theta}{dz} = \frac{\theta_0 - \theta_1}{L}$$

At the same place at the same time after cooling began

$$\theta = \theta_0 - \frac{z}{L}(\theta_0 - \theta_1)$$

and measuring  $\theta$  on the Centigrade scale,  $\theta_0$  and  $\theta_1$  are the actual capacities and conductivities at 0° C.

$$\theta_0 = \frac{100}{C_0} \quad \theta_1 = \frac{100}{C_1}$$

$$\theta = \frac{100}{C_0} - \frac{z}{L} \left( \frac{100}{C_0} - \frac{100}{C_1} \right)$$

Thus if  $C_1$  and  $C_0$  increase  $\gamma$  per cent. per 100 degrees Centigrade, and if  $\frac{d\theta}{dz} = \frac{100}{L} \left( \frac{1}{C_0} - \frac{1}{C_1} \right)$

$$\frac{d}{dz} \left( \frac{100}{L} \left( \frac{1}{C_0} - \frac{1}{C_1} \right) \right) = \frac{100}{L} \left( \frac{-\gamma}{C_0^2} + \frac{\gamma}{C_1^2} \right)$$

If the cooling of Lord Kelvin's infinite mass with a plane face the time which elapses until a particular surface gradient is reached is inversely proportional to the square of the gradient.

If the time taken on the assumption of constant  $C_0$  and  $C_1$  be called  $T_0$ , and if the time taken on the assumption that  $C_0$  and  $C_1$  increase  $\gamma$  per cent. for 100 degrees is  $T_1$ , then

$$\left( \frac{T_1}{T_0} \right)^2 = \frac{C_0^2}{C_1^2} \left( \frac{1}{C_0} - \frac{1}{C_1} \right)^2$$

$$\frac{T_1}{T_0} = \frac{C_0}{C_1} \left( \frac{1}{C_0} - \frac{1}{C_1} \right)$$

Thus the time taken on the assumption that  $C_0$  and  $C_1$  increase  $\gamma$  per cent. for 100 degrees is 121 times that on the assumption that they are constant.

So that Lord Kelvin's age of the Earth would be multiplied by 121.

It must be understood that my conclusions (NATURE, January 1, p. 22) are really independent of whether R. Weber's results are correct or not. Lord Kelvin has to prove the impossibility of their existence, the earth being better conductors (including convective conduction in case of liquid rock in crevices) than the surface rocks. If, however, Weber's results, as quoted by me, are trustworthy, the above solution is what I take Lord Kelvin to refer to in the last paragraph of his published letter. In considering all other elements as those of R. Weber, it must be remembered that rocks at twenty miles deep are not merely at a high temperature, but also under great pressure.

January 30. JOHN PERRY

Oceanic Temperatures at Different Depths.

The question of the temperature at the base of the temperature of different strata of water beneath the surface of the ocean, is one upon which a few observations have been made, that it will probably be interesting to students of oceanic phenomena to publish in NATURE the results obtained at one spot in the Atlantic, a period extending over as much as twenty-one years.

At a position of about 2 miles west-north-west from Cape Palma, in Africa, where the surface temperature is about 25.0 fathoms, and where on the surface the surface current is running to the eastward, the Challenger in 1873 and 1876 the *Buccaneer* in 1880, and the *Waterwitch* in 1894 have all obtained several temperature observations at a depth of 200 fathoms, the latter at 130 fathoms.

The results are given in the following diagram illustrated by a diagram.

by about 6°: at 50 fathoms, by 3°·7; while at 100 fathoms, three of the results are within 0°·3 of one another, the fourth being 1°·1 above the lowest. From 100 to 200 fathoms, the temperatures, diminishing in the same ratio, differ by about the same amount.

It is difficult to say exactly what value can be placed on each individual observation. Many small errors may creep in; errors of reading, errors from movement of the indices, errors from insufficient time being given for the instrument to take up the true temperature, &c.

These should not, however, reach a degree in any instance, and it is pretty plain that below 100 fathoms the temperature at this spot remains fairly equable. This confirms the general view held by those who have studied the results obtained from observations at different depths, in different parts of the ocean.

While from one point of view it is unfortunate that the observations have been taken in different months, on the other hand, the variation in the surface temperature at different seasons of the year is given full value in the comparison.

January 26. W. J. L. WHARTON.

"The Bird-Winged Butterflies of the East."

PERMIT me to add a few notes supplementary to the very interesting and able article, by my friend Mr. Kirby, entitled "The Bird-Winged Butterflies of the East," which appeared in your issue of January 10, p. 254.

(1) If the male of either of the two species of my genus *Æthoëptera* is examined in the proper light and position, a long pupæ form stigma, composed of raised scent-producing scales, will be very readily seen, of a more slender character, but in nearly the same relative position on the hind margin of the anterior wing, as in the males of the genus *Ornithoptera*, or, as Mr. Kirby prefers to call it, *Troides*. As I have pointed out in part viii. of my "Icones Ornithopterorum," this stigmatic sexual brand, being a densely black mark surrounded by the general velvet black of the wing, is very likely to be overlooked by a casual observer in some positions, while it is really very prominent in others; and I have called special attention to the lovely arrangements by which the latter result is attained; and a reference to the plates containing the figures of these species will suffice to show how very obtrusive the mark is, and how much more beautiful the insect becomes by the magical play of opalescent tints on the black which encloses the stigma, as the insect is moved into different positions against or opposite the light. To simply look at the insect as it stands in a cabinet drawer, is to miss all this glory and its *raison d'être*. As in all the species of *Ornithoptera*, the female possesses no such organ.

(2) *Æ. (?) Tithonus* (De Haan), as quoted by Mr. Kirby, is (as he evidently suspect) not a member of the genus *Æthoëptera* at all, but belongs to the first genus of the true *Ornithoptera*, viz. *Schoenbergia* (sub genus of Pagenstecher, and genus of Rippon); and I have no doubt that the female butterfly supposed to be its mate, is rightly assigned to it, as it is singularly like the female of *Sch. Paradisea* of Staudinger, and also co-generic with the large form described by M. Ch. Oberthur under the name *O. Goliath*. Neither in *Sch. Paradisea* or *Sch. Tithonus* is the male furnished with a pupæ-form sexual mark as in *Ornithoptera* and *Æthoëptera*, nor with an abdominal marginal pouch or fold concealing the *androconia*, as in the males of *Pompeoptera*, or as Mr. Kirby calls them, *Ornithoptera* and *Trogonoëptera*.

(3) I am compelled to regard the *Ornithoptera* as being naturally divided into three sub groups of unequal extent (so far as our present material indicates): (1) The African or *Acræoid* *Ornithoptera*, containing one genus (*Drurya*), and two species, *D. Antimachus* (Drury), and *D. Zalmoxis* of Hewitson; (2) The Oriental or true *Ornithoptera*, with the five genera *Schoenbergia*, *Ornithoptera*, *Æthoëptera*, *Trogonoëptera*, and *Pompeoptera*; (3) the South and Central American *Ornithoptera*, containing the numerous black and red, and black and green, and olive black *Papilio*s, which are usually allowed to follow the true *Ornithoptera* in our systematic catalogues. The males of many of these possess an abdominal marginal fold concealing the *androconia*, an organ not found, as far as I am aware, on the abdominal margin of any other section of the *Papilionidæ*—though the sexual stigma can be found on the anterior wings of several males, as in *P. Ulysses* for example, though differing in form and position.

(4) My reasons for not adopting Hubner's name *Troides* in place of *Ornithoptera* for the Priamus group will be found by referring to "Icones Ornithopterorum." At the same time, I

quite understand, and to some extent sympathise, with the severe and uncompromising application of the law of priority in nomenclature for which Mr. Kirby and several other naturalists contend.

(5) The wonderful iridescence of the yellow hind wings of *Pompeoptera Magellanus*, ♂, may be seen equally displayed on the under surface also.

Finally, I may safely say that the males of *Æthoëptera* and *Schoenbergia* are probably the most perfectly beautiful of the butterflies of the world.

ROBERT H. F. RIPPON.

Upper Norwood, S.E., January 19.

Thirst-endurance in some Vertebrates.

WHEN an example of great ability to endure thirst is desired, the camel is usually suggested. Hibernating animals also are put forward in instance of existence without water for long periods. The camel carries a supply with it, so that what is most wonderful in its case is the tank. Torpid animals need little or no moisture beyond that in their systems, and, besides, they benefit from dampness around them. Better examples abound on the arid plains near the Rocky Mountains and the Sierras, in the innumerable active, noisy little rodents, miles away from streams or pools, and out of possible reach of water by burrowing. Any one who observes these creatures in their haunts in midsummer, will be pretty sure to inquire, like one of my companions, "What do those little wretches get to drink, anyhow?" The only reply appears to be, "They drink water when they get it, and do without at other times." For weeks and months, when the vegetation is shrivelled and parched, and the sands are at their hottest, these squirrels and their neighbours, with thickening blood, wait for the rain, that the currents in their veins may be thinned and quickened. But one need not go so far for a much better instance than the camel. The common mouse endures thirst quite as well as its allies in the desert. This has been proved repeatedly by mice kept here as a reserve supply of food for a lot of reptiles. Reducing the allowance of water prevented the foul odour by which mice are generally attended; this led to keeping some of them entirely without water, to note the effect. Last winter, a few were kept in a warm room more than three months before being fed to the snakes. On the first of last October, several were put aside to have no drink; at the time of writing, three months and a half later, they are eating heartily of the driest of maize and grass seeds, on which alone they have been fed, and they act as if able to endure the experiment a month or two longer.

S. GARMAN.

Cambridge, Mass., U.S.A., January 17.

Electroscopes in Lecture.

THE electroscope which Prof. Lodge proposes to use to indicate positive and negative potentials by different movements of the leaves (see p. 320), has the disadvantage that (assuming the case to be charged negatively), if too large a negative charge be given to the gold leaves they will diverge, and the inference will be that the potential is zero or positive, neither of which is the truth. For the purpose Prof. Lodge has in view, a Bohnenberger's electroscope would indicate more clearly positive, negative, or zero potential. Instead of the two dry piles, the inner and outer coatings of a charged insulated Leyden jar connected to two knobs, one on each side of the single gold leaf, might be substituted.

J. REGINALD ASHWORTH.

The Owens College, Manchester.

Snake Cannibalism.

THIS notice in NATURE, January 31, p. 321, on the above-mentioned subject, calls to my mind the following passage in Réaumur's "Averroës," Paris, 1867, p. 310. He refers to the pre-Raphaelite pictures representing allegorically the "Seven Liberal Arts," and adds: "Dans une fresque récemment découverte à Pny . . . La Loge que tient en main un lézard ou un scorpion. Dans un tableau d'Angelico elle tient deux serpents qui se dévorent." I have not succeeded in finding any further statement about this picture in the books on Art within my reach, nevertheless this may prove an interesting addition to the growing literature on cannibal snakes.

C. R. OSTEN SACKEN.

Heidelberg, February 3.

## PIERRE DUCHARTRE.

AS announced in our issue of November 8, 1894, the *aven* of French botanists died on the 5th of that month, "having passed away without suffering, at the advanced age of eighty-three." Pierre Duchartre was pre-eminently a practical botanist, whose teachings were largely based upon actual knowledge, acquired by observation and experiment. Almost before the foundation of the present German school of botanists, of whom Sachs was one of the earliest exponents, Duchartre published (1857) the first edition of his well-known and highly esteemed "Eléments de Botanique." It was the result of thirty years' study and investigation; his first paper having appeared as early as 1836. It is true that Sachs's "Handbuch der Experimental Physiologie der Pflanzen" preceded it by one year; but for some years Duchartre's book held its own, not only in France but also in this country. As we learn from a sketch of his life by Mr. Gaston Bonnier,<sup>1</sup> Duchartre commenced his botanical studies under exceptionally difficult conditions, even for that period; but by great industry and perseverance he soon gained for himself a name and position which he maintained till the last. In 1843 he took up his abode in Paris, where he spent the last fifty years of his life, engaged in teaching, writing, and original research. In 1861 he replaced Payer at the Académie des Sciences, and succeeded him in the Botanical chair at the Sorbonne. For many years Duchartre was one of the principal supporters of the Société Nationale d'Horticulture, and he was seven times elected President of the Société Botanique de France, of which he was one of the founders. He was also President of the Société Nationale d'Agriculture, and the Académie des Sciences. Physiology and organology, including teratology, were his principal branches of study; but his very numerous contributions to botanical and horticultural literature cover a much wider field. Systematic botany, however, received comparatively little attention from him; a monograph of the Aristolochiaceæ being his chief work in this direction. His last work was a summary, from the German, of Engler's additions to Hehn's book on the native countries of cultivated plants. It appeared in the *Journal* of the French Horticultural Society a month before his death.

11.

## NOTES.

THE remains of the late Prof. Cayley were interred at Cambridge on Friday, and, notwithstanding the inclemency of the weather, snow having fallen heavily during the night, the proceedings were attended by a large number of persons. We are indebted to the *Times* for the following account of the funeral.—The body was brought from Garden House at two o'clock to Trinity College, and was met at the great gate by a procession numbering about 300 gentlemen, among them being many notable men of science. The pall bearers were the Vice-Master of Trinity (Mr. Abbs Wright), Dr. Glisher, the Right Hon. George Dunning, Prof. Jebb, M.P., Prof. Sir Robert Ball, Prof. J. J. Thomson, Lord Kelvin, and Prof. Sir G. G. Stokes. The choir headed the procession. Then came the officiating clergy—the Master of Trinity, the Bishop of Durham, and the Rev. R. S. John Parry, senior dean. Following the mourners came the Fellows of Trinity College—Mr. J. Prior, Dr. Jackson, Mr. H. M. Taylor, Mr. B. E. Hammond, Dr. Kirkpatrick, Dr. Stanton, the Rev. A. H. F. Boughby, Dr. Verrall, Mr. W. W. R. Ball, Mr. R. D. Hicks, Mr. R. J. Gibson, Mr. F. J. H. Jenkinson, Dr. Postgate, Mr. Fraser, Mr. J. G. Fraser, Mr.

J. D. Duff, Mr. A. N. Whitehead, Dr. Sidgwick, Mr. J. N. Langley, Mr. S. M. Leathes, Rev. C. Platts, Mr. C. Williams, Mr. A. A. Bevan, Mr. G. T. Walker, Mr. W. C. Whetham, Mr. G. A. Davies, Mr. Capstick, Mr. Innes, Mr. Nicholson, Mr. Cowell, Mr. Moore, and Mr. Wyse. Then came the Vice-Chancellor of the University and the representatives of the German and United States Embassies—viz. H.S.H. Prince Hermann von Schoenburg-Waldenburg for the German Ambassador, and Mr. D. D. Wells on behalf of the United States Ambassador. Baron d'Estournelles de Constant had intended to be present as representative of the French Ambassador, but was prevented at the last moment. The heads of Houses included the Masters of Peterhouse, Clare, Caius, St. Catharine's, Jesus, Christ's, St. John's, Emmanuel, Sidney Sussex, Downing, and Ayerst Hall, the President of Queens', and the Principal of Ridley Hall. The Royal Society was represented by Lord Rayleigh and Prof. Michael Foster; the Royal Astronomical Society by Mr. Knobel; the Mathematical Society by Major MacMahon, Mr. Kempe, Prof. Elliott, and Prof. Henrici; the Cambridge Philosophical Society by Mr. Larmor and Mr. Newall. The attendance likewise included Profs. J. R. Lumby, H. B. Swete, E. C. Clark, A. Macalister, T. McKenny Hughes, W. J. Lewis, H. E. Kyle, E. B. Cowell, J. E. B. Mayor, J. A. Ewing, W. W. Skeat, Sir G. M. Humphrey, and C. S. Roy; the Public Orator, the Registrar, Dr. Routh, and many others. An impressive service was held in the chapel of Trinity College. The concluding portion of the service took place at the Mill Road Cemetery, the Bishop of Durham committing the body to the grave.

WE are glad to see that the Duke of Argyll has recovered sufficiently from his illness to remove from the residence of Lord Kelvin to Inverary Castle.

THE very extensive and valuable botanical library of the late Prof. N. Pringsheim has been presented to the German Botanical Society, of which he was President, together with a sum of 25,000 marks for its maintenance.

THE Berlin correspondent of the *British Medical Journal* reports that a gift of 1,500,000 marks (£75,000) has come to the German Royal Academy of Sciences from a widow lady, Frau Wenzel. The sum is to remain as a foundation, and the interest used to assist scientific inquiries of importance.

THE death is announced of Dr. Lombard, the author of a standard work on Climatology from a medical point of view, and in 1882 the President of the International Congress of Hygiene at Geneva. An eminent German engineer—Hermann Gruson—has also just died, at Magdeburg.

REUTER'S correspondent at Christiania reports that earthquake shocks were felt at Christiansund, Molde, Aalesund, and Bergen between 12.15 and 12.43 on the morning of Tuesday, February 5, causing windows to rattle and disturbing furniture. The direction of the vibrations was from south-east to north-west.

A DEPUTATION from the recent Indian Medical Congress has (says the *Lancet*) waited upon Sir Anthony MacDonnell, controlling the Home Department, to urge upon the Government of India the extension of facilities for the study of preventive medicine and the prosecution of scientific research in that country. Sir Anthony MacDonnell, in his reply, assured the deputation of his interest in the objects in view, and announced that, in addition to the bacteriological laboratory at Agra, a similar institution for experimental research was to be established at Lahore.

THE United States Government has established an additional wind signal, to be known as the "Hurricane Signal," to be used in addition to the storm signals previously shown. The

<sup>1</sup> *L'Année biologique*, tome 14, p. 100. Paris, 1894.

signal consists of two red flags with black centres, shown one above the other, and will be used to announce the expected approach of tropical hurricanes, and also of those extremely severe and dangerous storms which occasionally move across the Lakes and the northern Atlantic shore. Whenever instructions are received to show this signal at any station, every effort has to be made to distribute the information, and all vessels have to be notified that it is dangerous to leave port.

THE Academy of Natural Sciences of Philadelphia, acting on the report of the Committee on the Hayden Memorial Geological Award, have voted the Hayden medal, and the accumulated interest on the fund, to Prof. G. A. Daubrée. The recipient in 1893 was Prof. Huxley. Prof. Daubrée was born in Metz, June 25, 1814, and is therefore now in his eighty-second year. He graduated from the *École Polytechnique* in 1834, and immediately received a commission to assist in the geological exploration of Algeria. He was called to the chair of Geology in Strasburg in 1839, and was Dean of its Scientific Faculty in 1852. He was appointed Engineer-in-Chief in 1855. In 1861, upon the death of the distinguished Cordier, he was selected to replace him in the Museum of Natural History, and as Professor of Mineralogy in the *École des Mines*, as well as in the *Académie des Sciences* in Paris. His writings have been numerous, original, and important, and his researches into the intricate causes of crystalline structure, and in the domain of experimental geology, are of exceptional value.

BY the death of Dr. F. Buchanan White, which took place on December 3, 1894, at Perth, in his fifty-third year, Scotland has lost one of her most active naturalists. His special branches were entomology and botany. Dr. White was one of the founders of the Perthshire Society of Natural Sciences, of the Scottish Cryptogamic Society, and of the East of Scotland Union of Naturalists' Societies; and was the originator and first editor of the *Scottish Naturalist*. He left, at the time of his death, a nearly completed "Flora of Perthshire." The *Entomologist's Monthly Magazine* notes that his friends are endeavouring to raise a fund to erect a memorial to him. It is proposed to place a mural brass tablet in St. Ninian's Cathedral, and also to procure an enlarged photograph, to be hung in the lecture room of the Perthshire Society of Natural Science. Any who wish to contribute to this memorial may send subscriptions to either Vincent L. Rorison, Dean of St. Andrews, The Deanery, Perth; or Henry Coates, President of the Perthshire Society of Natural Science, Pitcullen House, Perth.

DR. HERMANN WEBER, a Fellow of the Royal College of Physicians and Surgeons, gave, last December, the sum of £2500 in trust for the purpose of founding a prize to be called the "Weber-Parkes" prize, to be given at intervals for the best essay on tubercular consumption. It has now been resolved that the prize be awarded triennially to the writer of the best essay upon some subject connected with the etiology, prevention, pathology, or treatment, of tuberculosis, especially with reference to pulmonary consumption in man; that, in making the award, the College have regard to careful collection of facts and original research; that the value of the prize be 150 guineas, or such sum as the interest accrued on the capital, after payment of expenses, will permit; that a bronze medal be awarded to the holder of the prize, and a similar medal, to be distinguished as the "second medal," to the essayist who comes next in order of merit. The competition will be open to members of the medical profession in all countries, the essays to be type-written, and, if written in a foreign language, to be accompanied by a translation in English. It is a condition of the competition that each prize essay shall become the property of the College, though the College may grant its author permission to publish it.

ON Friday last, a deputation from the British Medical Association and the Ophthalmological Society waited upon Mr. Bryce, President of the Board of Trade, to urge the adoption of more precise tests for eyesight in the examination for the mercantile marine and railway servants. Dr. Macnamara, in introducing the deputation, said that railway and merchant marine authorities did not insist upon proper precautions being taken to exclude men with imperfect eyesight from being employed as signalmen, and in the movement of trains and vessels. Dr. Argyll Robertson held it was necessary that the tests should be adequate and uniform, that they should be skilfully employed, and that they should be applied at regular intervals. The tests should elicit three conditions: (1) the acuteness of vision possessed by the applicant; (2) the state of refraction of the candidate's eye; and (3) his acuteness of colour perception. Mr. Bryce, in the course of his reply, said he was glad to gather from what had been said by members of the deputation, that the tests embodied in the Board's circular of last September, to be applied to masters and mates, were recognised as being satisfactory, except in regard to the question of refraction. He was perfectly certain, however, that if the railway companies' examinations did not cover this defect, they would soon take steps to apply the test for it. But the Board of Trade had no statutory powers as regarded the companies in this matter, neither had they any power to apply the tests to all persons entering the merchant service.

IN June of last year, the Society for the Preservation of the Monuments of Ancient Egypt discussed the importance of having a thorough survey made of the Nile Valley from the First to the Second Cataract—that is to say, of the district which will be partially converted into a high reservoir when the dam at Assouan, even in its reduced proportions, is constructed. A draft scheme for such an archeological survey has been drawn up by the Committee appointed to decide upon the regions to be investigated and the work to be done. A list has been compiled to show the most important antiquities along the Nile Valley which require examination and copying. The Committee propose that the survey should commence with a preliminary reconnaissance, providing a general map and maps of sites, to be followed by plans of the buildings and special inquiries indicated in subsequent sections. It is probable that, under the special circumstances of the case, if the maps and plans referred to cannot be prepared for publication in Egypt, application to the Board of Agriculture might secure their multiplication and reduction by the Ordnance Survey. Such a course would secure perfect reproduction and a great economy. It is proposed that illustrations, other than plans, should be based on photographs, to be subsequently processed in printer's ink. This would secure permanency and great economy, and avoid all the expenses of hand illustration, which alone was available in the expeditions of 1789 and 1844. The Committee suggest that a non-commissioned officer of the Royal Engineers, who has passed through the Photographic School at Chatham, should be attached to one of the companies of Royal Engineers stationed in Egypt, and be employed in obtaining the photographs. It is understood that the preliminary reconnaissance is now about to commence, under the direction of the Public Works, Irrigation, and Archeological Departments of the Egyptian Government, very much in accordance with the detailed scheme, printed copies of which have been forwarded to Egypt.

A PAPER on boiler explosions, read at the Institution of Civil Engineers on January 29, by Mr. William H. Fowler, presents some points of interest. The theories, such as "deferred ebullition," "dissociation of water," "spheroidal condition," which have been propounded to account for

such explosions are well known. Mr. Fowler showed that it was the hot water, rather than the steam, in the boiler which formed the source of destructive energy. In regard to the causes of boiler explosions, there is nothing occult or mysterious. They can, as a rule, be traced by patient investigation to a combination of simple and well-known facts. Thus when a boiler-shell is normally in a state of high tension, if once a rupture takes place by the action of static stresses on a locally weak spot, the stored-up energy is capable not only of tearing the boiler to pieces, but of producing all the other destructive effects observed in connection with such disasters. Prominent among the principal causes of explosions is the corrosion of the boiler-shell. Some explosions have their origin in the stresses arising from expansion and contraction due to the action of the fire. As an illustration of the stresses set up by unequal expansion and contraction in a boiler, a case was mentioned in which an explosion occurred two hours after the fires were drawn. A frequent source of boiler explosions in the past is the practice of cutting large openings in boiler-shells, without providing compensating strengthening rings. Overheating from shortness of water is a common cause of boiler explosions, but the operation of this cause is different from the reason formerly assigned to it. Explosions are not the result of turning cold water on to red-hot plates. What takes place is that the overheated plates become gradually softened, with the result that they bulge downwards and are rent at the ordinary working pressure: explosions of this kind are of a relatively mild character. Many explosions arise from excessive pressure in consequence of the defective action of the safety valve. This may occur in a variety of ways, but the type of valve liable with a spring balance is the most prolific source. Finally, explosions sometimes arise from faulty material and construction. As a result of using iron of poor quality with lanced holes, incipient flaws are occasionally set up in the seams, and several cases have occurred in which these inherent defects were so situated as to forbid detection when the boiler was put together, and were only revealed by the explosion. These defects show the value in connection with new work of a careful hydraulic test.

The barometer has been very high over north-west Europe during the past week, and the type of weather over these quarters has been anti-cyclonic, with strong easterly winds or gales at several places on our coasts. In the neighbourhood of London the maximum day temperatures have not exceeded 53°, and at night deep frosts have occurred. In the suburbs a reading of 45 has been recorded, and a few miles distant the thermometer had several degrees lower, with a radiation temperature of 6° 5', while over the midland districts of England the thermometer in the shade has fallen 24° below the freezing point. *The Weather and its Record* published by the Meteorological Office states that during the week ending the 2nd inst. the absolute scale minima recorded were—2° at Wandsworth on January 28, 1° at Bromley on January 30, and 2° at Hillingdon on January 27. Over the whole country the temperature ranged from 8° to 14° below the mean for the week. Snow has fallen at many places in different parts of the kingdom.

THE beautiful Alpine phenomenon which the Swiss call "Alpengluhen," is not a simple red glow of the snowy peaks at sunset, but is sometimes intermittent, the glow returning once or twice after it has apparently died away. Dr. J. Amster, in a recent communication to the Swiss Natural Science Society, explains this repetition by taking into account the various variations undergone by the sun's rays in passing through the daily cooling atmosphere. Since the air is colder in the higher, and warmer in the lower strata, the solar rays undergo a kind

of total reflection which makes them pass upwards again, so that when the sun has reached a certain position they will no longer strike the summits. This is the end of the first glow. As the lower air cools, the rays become once more rectilinear, and the second glow sets in. When the sun sinks still lower, its rays are thrown down upon the glaciers by ordinary refraction. This refraction may be intensified by warm air from below reaching the upper regions of the air, which would give rise to the third glow. But the latter is only rarely observed.

It is gratifying to learn that the Italian Government has appointed a commission to study the violent earthquake which occurred in South Italy on November 16. In the meantime, Prof. Tacchini has established one result of great interest and, possibly, of much practical importance (*R. Acad. dei Lincei, Rend.* iii. 1894, pp. 365-377). The earthquake was registered at Rome by three pendulums in the Collegio Romano. The maximum displacement occurred at 5h. 55m. p.m., Greenwich mean time; but the first movement was registered by the great seismometrograph (length 16 m., mass 200 kg.) at 5h. 52m. 25s., by another (length 6m., mass 100 kg.) at 5h. 52m. 30s., and by a third still less delicate (length 1½ m., mass 10 kg.) at 5h. 53m. 20s. Now a clock was stopped at the observatory of Messina at 5h. 52m., there being no slight shock previously, and the maximum disturbance was registered at the same moment at the observatory of Catania. It may be inferred, therefore, that before the great shock took place, there was a microseismic motion insensible to man and to ordinary apparatus. But, if an instrument as delicate as that at Rome had been installed at Messina, the beginning of the motion would have been recorded 2½ minutes before the occurrence of the sensible shock.

We learn from the *Journal of Botany*, that a "Flora of Berkshire," by Mr. Druce, will shortly be published.

THE constant communication kept up by the central authorities at Kew with the directors of the various colonial botanic gardens, is bearing fruit in the numerous botanical publications which proceed from the Colonies. We have on our table the *Bulletin of Miscellaneous Information* from the Royal Botanic Garden, Trinidad, for January 1895; the *Agricultural Journal* of the Leeward Islands for October 1894; and *Notes on Antigua Grasses*, by Mr. C. A. Barber, Superintendent of Agriculture for the Leeward Islands; all containing notes and information of value for the dwellers in the Tropics.

FIVE *Bulletins* of the University of Wisconsin have come to us. One, the first of a Science Series, is on the speed of the liberation of iodine in mixed solutions of potassium chlorate, potassium iodide, and hydrochloric acid, the author thereof being Mr. H. Schlundt. His experiments show that the speed of the reaction increases to a marked degree with temperature. The presence in the mixture of an excess of one or more of the components also increases the speed, and an increase in the degree of concentration acts in the same manner. The presence of hydrobromic acid accelerates the reaction; and, to a less extent, hydrochloric, nitric, and sulphuric acids. Organic acids, however, and boric acid, do not increase the speed. The four remaining *Bulletins* referred to belong to the Engineering Series. In one, Mr. L. F. Loree traces the development of railroads from 1825 to the present time, chiefly dealing with the construction of the permanent way. Some practical hints in dynamo design are given by Mr. Gilbert Wilkes in the second of the series. The next, by Mr. C. T. Purdy, refers to the steel construction of buildings; and the fourth, by Mr. A. V. Abbott, deals with telephones and switchboards.

Two further communications concerning the new iodine bases are contributed by pupils of Prof. Victor Meyer in the current issue of the *Berichte*. In the first, Mr. John McCrear



describes the base and its salts derived from toluene, analogous to the compounds previously described by Prof. Meyer and Herr Hartmann derived from benzene. In the second memoir, Mr. Wilkinson describes a further series derived from para-chlor-iodo-benzene,  $C_6H_4Cl$ . The formation of both series occurs precisely as in the case of the benzene derivatives. The base derived from toluene was prepared from the para iodide of toluene as starting point. Its composition is  $(C_6H_4 \cdot CH_3)_2I \cdot OH$ , iodine apparently acting, as in the bases previously described, in a trivalent capacity, and forming the central element around which the two toluene radicles and the hydroxyl are grouped. The base itself has only been obtained in aqueous solution, but many of the salts crystallise well, and are consequently readily isolated. The iodide,  $(C_6H_4 \cdot CH_3)_2I \cdot I$ , is precipitated as a white powder, extremely sensitive to light, and melting at  $146^\circ$ . The corresponding chloride and bromide both crystallise from water in needles which melt at almost the same temperature in the neighbourhood of  $178^\circ$ . The bichromate is a particularly beautiful salt, crystallising from hot water in large orange-red plates. It is likewise explosive, detonating when heated. The nitrate,  $(C_6H_4 \cdot CH_3)_2I \cdot NO_3$ , is very soluble in water, and melts at  $139^\circ$ . The per-iodide is a remarkable compound,  $(C_6H_4 \cdot CH_3)_2I \cdot I_3$ , obtained by addition of two further atoms of iodine to the ordinary iodide above mentioned. It crystallises in dark red needles, endowed with a very brilliant lustre, and melting at  $156^\circ$ . In addition to these salts, double salts with the chlorides of gold, platinum and mercury are described, all of which crystallise well and exhibit definite melting points. The base of the series described by Mr. Wilkinson possesses the composition  $(C_6H_4Cl)_2I \cdot OH$ , being derived from para chlor-iodo-benzene by reactions analogous to those by means of which the base above described was obtained, and similar to those previously described by Prof. Meyer. The iodide, chloride, bromide, nitrate and chromate, as well as double salts with the chlorides of mercury and platinum, have been obtained in well-defined crystals. Hence it would appear that the reactions discovered by Prof. Meyer and Herr Hartmann, between iodosobenzene and silver oxide, and between sulphuric acid and iodosobenzene, which resulted in the preparation of the first iodonium bases, are of pretty general application in the benzene series. These remarkable compounds containing iodine as the grouping element must now, therefore, be regarded as thoroughly well established, and the older idea as to the nature of the iodine atom must give place to a fuller conception of the capabilities of that element.

THE additions to the Zoological Society's Gardens during the past week include a Chacma Baboon (*Cynocephalus porciarius*) from South Africa, presented by Captain Webster; a White-throated Capuchin (*Cebu hypoleucus*) from Central America, presented by Mr. H. W. Manning; a Senegal Parrot (*Pteroccephalus senegalus*) from West Africa, presented by Miss Alice Firman.

OUR ASTRONOMICAL COLUMN.

NEW STARS AND NEBULÆ.—The first number of the *Astro-physical Journal* has come to hand. It is practically a continuation of *Astronomy and Astro-Physics*, in a slightly different form, and is now published by the Chicago University Press. Among the contributions to the journal is a paper, by Prof. W. W. Campbell, on some interesting and significant changes which have occurred recently in the spectrum of Nova Aurigæ. The intensities of the two lines at  $\lambda 4360$  and  $\lambda 5750$  appear to have decreased very materially. When Prof. Campbell observed the Nova spectrum in 1892, these two lines were stronger in the Nova than in the nebulae in the spectra of which they were seen and photographed. Observing last November, however, he found that this condition of things was reversed, the lines

appearing relatively fainter in the Nova than in the nebulae. As is now very well known, the spectra of nebulae differ both as regards the number and intensity of the lines. The recent observations of the Nova seem to show that the spectrum is not only nebular, but it is approaching the average type of nebular spectrum. Prof. Campbell thus sums up the bearing of spectroscopic observations upon theories proposed to account for the genesis of new stars:—

"The Harvard College Observatory has shown that both Nova Aurigæ and Nova Normæ at discovery possessed substantially identical spectra of bright and dark lines, similarly and equally displaced. Both diminished in brightness and both assumed the nebular type of spectrum. The new star of 1876 in Cygnus probably had nearly an identical history: passing from a bright star with a spectrum of bright and dark lines, to a faint object with a spectrum consisting of one bright line (undoubtedly the nebular line  $\lambda 5010$ , or the two nebular lines  $\lambda 5010$  and  $\lambda 4960$  combined). We may say that only five 'new stars' have been discovered since the application of the spectro-scope to astronomical investigations, and that three of these have had substantially identical spectroscopic histories. This is a remarkable fact. We cannot say what the full significance of this fact is. One result, however, is very clear: the special theory propounded by various spectroscopists to account for the phenomena observed in Nova Aurigæ must unquestionably give way to the more general theories."

THE DESIGNATION OF COMETS.—A uniform system of cometary notation is certainly needed. The *Observatory* points out that though the small letters *a, b, c*, &c., are now generally used to denote the order of discovery, and Roman numerals I, II, III, &c., to indicate the order of perihelion passage, astronomers are not agreed whether to write Comet *a* 1894, Brooks's Comet, or Comet Brooks. It is therefore suggested, and the suggestion deserves to be acted upon, that in the future the order shall be letter, year, Roman numeral, discoverer. The full name of the comet would then run as follows:—Comet *a* 1892, I. (Swift); and if any part of the name be quoted, this order should be preserved. Those who have had to search for observation of comets in astronomical publications, will welcome the system of uniformity in indexing, proposed by our contemporary.

THE NEW CONSTITUENT OF THE ATMOSPHERE.<sup>1</sup>

I. Density of Nitrogen from Various Sources.

In a former paper<sup>2</sup> it has been shown that nitrogen extracted from chemical compounds is about  $\frac{1}{2}$  per cent. lighter than "atmospheric nitrogen."

The mean numbers for the weights of gas contained in the globe used were as follows:—

From nitric oxide	...	...	...	2'3001
From nitrous oxide	...	...	...	2'2990
From ammonium nitrite	...	...	...	2'2987

while for "atmospheric nitrogen" there was found—

By hot copper, 1892	...	...	...	2'3103
By hot iron, 1893	...	...	...	2'3100
By ferrous hydrate, 1894	...	...	...	2'3102

At the suggestion of Prof. Thorpe experiments were subsequently tried with nitrogen liberated from *urea* by the action of sodium hypobromite. The hypobromite was prepared from commercial materials in the proportions recommended for the analysis of urea. The reaction was well under control, and the gas could be liberated as slowly as desired.

In the first experiment the gas was submitted to no other treatment than slow passage through potash and phosphoric anhydride, but it soon became apparent that the nitrogen was contaminated. The "inert and odorless" gas attacked vigorously the mercury of the Topley pump, and was described as smelling like a dead rat. As to the weight, it proved to be in excess even of the weight of atmospheric nitrogen.

The corrosion of the mercury and the evil smell were in great

<sup>1</sup> Abstract of a paper by Lord Rayleigh, Sec. R.S., and Prof. William Ramsay, F.R.S., read before the Royal Society, at a special meeting, on January 31.

<sup>2</sup> Rayleigh, "On an Anomaly encountered in Determinations of the Density of Nitrogen Gas," *Rep. Soc. Phys.*, vol. lv, p. 246, 1894.

degree obtained by passing the gas over hot metals. For the fillings of June 6, 9, and 13 the gas passed through a short length of tube containing copper in the form of fine wire heated by a Bunsen burner, then through the furnace over red hot iron, and back over copper oxide. On June 19 the furnace tubes were omitted, the gas being treated with red hot copper only. The mean result, reduced so as to correspond with those above quoted, is 2.2985.

Without using heat, it has not been found possible to prevent the corrosion of the mercury. Even when no urea is employed, and air simply bubbled through, the hypobromite solution is allowed to pass with constant shaking over mercury contained in a U tube, the surface of the metal was soon fouled.

Although the results relating to urea nitrogen are interesting for comparison with that obtained from other nitrogen compounds, the original object was not attained on account of the necessity of treating the treatment with hot metals. We have found, however, that nitrogen from ammonium nitrite may be prepared without the employment of hot tubes whose weight agrees with that above quoted. It is true that the gas smells slightly of ammonia, easily removable by sulphuric acid, and apparently also of oxides of nitrogen. The mean result from three fillings is 2.2987.

It will be seen that, in spite of the slight nitrous smell, there is no appreciable difference in the densities of gas prepared from ammonium nitrite with and without the treatment by hot metals. The result is interesting as showing that the agreement of numbers obtained for chemical nitrogen does not depend upon the use of a red heat in the process of purification.

The five results obtained in more or less distinct ways for chemical nitrogen stand thus:—

From nitric oxide	2.3001
From nitrous oxide	2.2990
From ammonium nitrite purified at a red heat	2.2987
From urea	2.2985
From ammonium nitrite purified in the cold	2.2987
Mean	2.2990

These numbers, as well as those above quoted for "atmospheric nitrogen," are subject to a deduction of 0.0006 for the shrinkage of the globe when exhausted. If they are then multiplied in the ratio of 2.3108 : 1.2572, they will express the weights of the gas in grams per litre. Thus, as regards the mean numbers, we find as the weight per litre under standard conditions of chemical nitrogen 1.2505, that of atmospheric nitrogen being 1.2572.

It is of interest to compare the density of nitrogen obtained from chemical compounds with that of oxygen. We have  $N_2 = 0.002284 : 2.6276 = 0.87471$ ; so that if  $O_2 = 16$ ,  $N_2 = 13.6954$ . Thus, when the comparison is with chemical nitrogen, the ratio is very nearly that of 16 : 14; but if "atmospheric nitrogen" be substituted, the ratio of small integers is widely departed from.

To the above list may be added nitrogen prepared in yet another manner, whose weight has been determined subsequently to the isolation of the new dense constituent of the atmosphere. In this case nitrogen was actually extracted from air by means of magnesium. The nitrogen thus separated was then converted into ammonia by action of water upon the magnesium nitride, and afterwards liberated in the free state by means of calcium hypobromite. The purification was conducted in the usual way, and included passage over red hot copper and copper oxide. The following was the result:—

Globe empty, October 30, November 5	2.82313
Globe full, October 31	0.52395
Weight of gas	2.29918

It differs inappreciably from the mean of other results, viz. 2.2990, and is of special interest as relating to gas which at one stage of its history formed part of the atmosphere.

Another determination, with a certain amount of paratus, of the density of "chemical" nitrogen from the same source, magnesium nitride, which had been prepared by passing "atmospheric" nitrogen over ignited magnesium may here be recorded. The sample differed from that previously mentioned, inasmuch as it had not been subjected to treatment with red

hot copper. After treating the nitride with water, the resulting ammonia was distilled off, and collected in hydrochloric acid; the solution was evaporated by decantation, the dry ammonium chloride was dissolved in water, and its concentrated solution added to a freshly prepared solution of sodium hypobromite. The nitrogen was collected in a gas holder over water which had previously been boiled, so as, at all events, partially to expel air. The nitrogen passed into the vacuum globe through a solution of potassium hydroxide, and through two drying-tubes, one containing soda-lime, and the other phosphoric anhydride.

At 18.38° C. and 754.4 mm. pressure, 162.843 c.c. of this nitrogen weighed 0.18963 gram. Hence,

Weight of 1 litre at 0° C. and 760 mm. pressure = 1.2521 gram.

The mean result of the weight of 1 litre of "chemical" nitrogen has been found to equal 1.2505. It is therefore seen that "chemical" nitrogen, derived from "atmospheric" nitrogen, without any exposure to red hot copper, possesses the usual density.

Experiments were also made, which had for their object to prove that the ammonia produced from the magnesium nitride is identical with ordinary ammonia, and contains no other compound of a basic character. For this purpose the ammonia was converted into ammonium chloride, and the percentage of chlorine determined by titration with a solution of silver nitrate which had been standardised by titrating a specimen of pure sublimed ammonium chloride. The silver solution was of such a strength that 1 c.c. precipitated the chlorine from 0.001701 gram of ammonium chloride.

(1) Ammonium chloride from orange-coloured sample of magnesium nitride contained 66.35 per cent. of chlorine.

(2) Ammonium chloride from blackish magnesium nitride contained 66.35 per cent. of chlorine.

(3) Ammonium chloride from nitride containing a large amount of unattacked magnesium contained 66.30 per cent. of chlorine.

Taking for the atomic weights of hydrogen H = 1.0032, of nitrogen N = 14.04, and of chlorine Cl = 35.46, the theoretical amount of chlorine in ammonium chloride is 66.27 per cent.

From these results—that nitrogen prepared from magnesium nitride, obtained by passing "atmospheric" nitrogen over red-hot magnesium has the density of "chemical" nitrogen, and that ammonium chloride, prepared from magnesium nitride, contains practically the same percentage of chlorine as pure ammonium chloride—it may be concluded that red-hot magnesium withdraws from "atmospheric nitrogen" no substance other than nitrogen capable of forming a basic compound with hydrogen.

#### II. Reasons for suspecting a hitherto Undiscovered Constituent in Air.

When the discrepancy of weights was first encountered, attempts were naturally made to explain it by contamination with known impurities. Of these the most likely appeared to be hydrogen, present in the lighter gas in spite of the passage over red-hot cupric oxide. But inasmuch as the intentional introduction of hydrogen into the heavier gas, afterwards treated in the same way with cupric oxide, had no effect upon its weight, this explanation had to be abandoned, and finally it became clear that the difference could not be accounted for by the presence of any known impurity. At this stage it seemed not improbable that the lightness of the gas extracted from chemical compounds was to be explained by partial dissociation of nitrogen molecules  $N_2$  into detached atoms. In order to test this suggestion both kinds of gas were submitted to the action of the silent electric discharge, with the result that both retained their weights unaltered. This was discouraging, and a further experiment pointed still more markedly in the negative direction. The chemical behaviour of nitrogen is such as to suggest that dissociated atoms would possess a high degree of activity, and that even though they might be formed in the first instance their life would probably be short. On standing they might be expected to disappear, in partial analogy with the known behaviour of ozone. With this idea in view, a sample of chemically prepared nitrogen was stored for eight months. But at the end of this time the density showed no sign of increase, remaining exactly as at first.

*On the Densities of the Foreign Gases.* *Phil. Mag. Ser. 4, Vol. 3, p. 196, 1892.*

*Phil. Mag. Ser. 4, Vol. 3, p. 344, 1894.*

Regarding it as established that one or other of the gases must be a mixture, containing, as the case might be, an ingredient much heavier or much lighter than ordinary nitrogen, we had to consider the relative probabilities of the various possible interpretations. Except upon the already discredited hypothesis of dissociation, it was difficult to see how the gas of chemical origin could be a mixture. To suppose this would be to admit two kinds of nitric acid, hardly reconcilable with the work of Stas and others upon the atomic weight of that substance. The simplest explanation in many respects was to admit the existence of a second ingredient in air from which oxygen, moisture, and carbonic anhydride had already been removed. The proportional amount required was not great. If the density of the supposed gas were double that of nitrogen  $\frac{1}{2}$  per cent. only by volume would be needed; or if the density were but half as much again as that of nitrogen, then 1 per cent. would still suffice. But in accepting this explanation, even provisionally, we had to face the improbability that a gas surrounding us on all sides, and present in enormous quantities, could have remained so long unsuspected.

The method of most universal application by which to test whether a gas is pure or a mixture of components of different densities is that of diffusion. By this means Graham succeeded in effecting a partial separation of the nitrogen and oxygen of the air, in spite of the comparatively small difference of densities. If the atmosphere contain an unknown gas of anything like the density supposed, it should be possible to prove the fact by operations conducted upon air which had undergone atomolysis. This experiment, although in view from the first, was not executed until a later stage of the inquiry (§ 6), when results were obtained sufficient of themselves to prove that the atmosphere contains a previously unknown gas.

But although the method of diffusion was capable of deciding the main, or at any rate the first question, it held out no prospect of isolating the new constituent of the atmosphere, and we, therefore, turned our attention in the first instance to the consideration of methods more strictly chemical. And here the question forced itself upon us as to what really was the evidence in favour of the prevalent doctrine that the inert residue from air after withdrawal of oxygen, water, and carbonic anhydride, is all of one kind.

The identification of "phlogisticated air" with the constituent of nitric acid is due to Cavendish, whose method consisted in operating with electric sparks upon a short column of gas confined with potash over mercury at the upper end of an inverted U tube.<sup>1</sup>

Attempts to repeat Cavendish's experiments in Cavendish's manner have only increased the admiration with which we regard this wonderful investigation. Working on almost microscopic quantities of material, and by operations extending over days and weeks, he thus established one of the most important facts in chemistry. And what is still more to the purpose, he raises as distinctly as we could do, and to a certain extent resolves, the question above suggested. The passage is so important that it will be desirable to quote it at full length.

"As far as the experiments hitherto published extend, we scarcely know more of the phlogisticated part of our atmosphere, than that it is not diminished by lime-water, caustic alkalis, or nitrous air; that it is unfit to support fire, or maintain life in animals; and that its specific gravity is not much less than that of common air: so that though the nitrous acid, by being united to phlogiston, is converted into air possessed of these properties, and consequently, though it was reasonable to suppose, that part at least of the phlogisticated air of the atmosphere consists of this acid united to phlogiston, yet it was fairly to be doubted whether the whole is of this kind, or whether there are not in reality many different substances compounded together by us under the name of phlogisticated air. I therefore made an experiment to determine whether the whole of a given portion of the phlogisticated air of the atmosphere could be reduced to nitrous acid, or whether there was not a part of a different nature to the rest, which would refuse to undergo that change. The foregoing experiments, indeed in some measure decided this point, as much the greatest part of the air let up into the tube lost its elasticity; yet as some remained unabsorbed, it did not appear for certain whether that was of the same nature as the rest or not. For this purpose I diminished a similar mixture of dephlogisticated and common air, in the same manner as before, till it was reduced to a small

part of its original bulk. I then, in order to decompose as much as I could of the phlogisticated air which remained in the tube, added some dephlogisticated air to it, and continued the spark until no further diminution took place. Having by these means condensed as much as I could of the phlogisticated air, I let up some solution of liver of sulphur to absorb the dephlogisticated air; after which only a small bubble of air remained unabsorbed, which certainly was not more than  $\frac{1}{10}$  of the bulk of the phlogisticated air let up into the tube; so that if there is any part of the phlogisticated air of our atmosphere which differs from the rest, and cannot be reduced to nitrous acid, we may safely conclude that it is not more than  $\frac{1}{10}$  of the whole."

Although Cavendish was satisfied with his result, and does not decide whether the small residue was genuine, our experiments about to be related render it not improbable that his residue was really of a different kind from the main bulk of the "phlogisticated air," and contained the gas now called argon.

Cavendish gives data<sup>1</sup> from which it is possible to determine the rate of absorption of the mixed gases in his experiment. This was about 1 c.c. per hour, of which two-fifths would be nitrogen.

### III. Methods of Causing Free Nitrogen to Combine.

To eliminate nitrogen from air, in order to ascertain whether any other gas could be detected, involves the use of some absorbent. The elements which have been found to combine directly with nitrogen are: boron, silicon, titanium, lithium, strontium, barium, magnesium, aluminium, mercury, and, under the influence of an electric discharge, hydrogen in presence of acid, and oxygen in presence of alkali. Besides these, a mixture of barium carbonate and carbon at a high temperature is known to be effective. Of those tried, magnesium in the form of turnings was found to be the best. When nitrogen is passed over magnesium, heated in a tube of hard glass to bright redness, combustion with incandescence begins at the end of the tube through which the gas is introduced, and proceeds regularly until all the metal has been converted into nitride. Between 7 and 8 litres of nitrogen can be absorbed in a single tube; the nitride formed is a porous, dirty orange-coloured substance.

### IV. Early Experiments on Sparking Nitrogen with Oxygen in presence of Alkali.

In our earliest attempts to isolate the suspected gas by the method of Cavendish, we used a Ruhmkorff coil of medium size actuated by a battery of five Grove cells. The gases were contained in a test-tube standing over a large quantity of weak alkali, and the current was conveyed in wires insulated by U-shaped glass tubes passing through the liquid round the mouth of the test-tube. With the given battery and coil a somewhat short spark or arc of about 5 mm. was found to be more favourable than a longer one. When the mixed gases were in the right proportion the rate of absorption was about 30 c.c. per hour, or thirty times as fast as Cavendish could work with the electrical machine of his day.

To take an example, one experiment of this kind started with 50 c.c. of air. To this oxygen was gradually added, until oxygen being in excess, there was no perceptible contraction during an hour's sparking. The remaining gas was then transferred to the pneumatic trough to a small measuring vessel, sealed by mercury, in which the volume was found to be 10 c.c. On treatment with alkaline pyrogallate, the gas shrank to 0.32 c.c. That this small residue could not be nitrogen was argued from the fact that it had withstood the prolonged action of the spark, although mixed with oxygen in nearly the most favourable proportion.

The residue was then transferred to the test-tube with an addition of another 50 c.c. of air, and the whole worked up with oxygen as before. The residue was now 2.2 c.c., and, after removal of oxygen, 0.76 c.c.

Although it seemed almost impossible that these residues could be either nitrogen or hydrogen, some anxiety was not unnatural, seeing that the final sparking took place under somewhat abnormal conditions. The space was very restricted, and the temperature (and with it the proportion of aqueous vapour) was unduly high. But any doubts that were felt upon this score were removed by comparison experiments in which the whole quantity of air operated on was very small. Thus, when

<sup>1</sup> "Experiments on Air," *Phil. Trans.* vol. lxxv. p. 372, 1785.

<sup>1</sup> *Phil. Trans.* v. l. lxxviii. p. 273, 1782.

a mixture of 5 c.c. of air with 7 c.c. of oxygen was sparked for 11 hours, the residue was 0.47 c.c., and after removal of oxygen 0.06 c.c. Several repetitions having given similar results, it became clear that the final residue did not depend upon anything that might happen when sparks passed through a greatly reduced volume, but was in proportion to the amount of air present.

No satisfactory examination of the residue which refused to be oxidised could be made without the accumulation of a larger quantity. This, however, was difficult of attainment at the time in question. It was thought that the cause probably lay in the solubility of the gas in water, a suspicion since confirmed. At length, however, a sufficiency was collected to allow of sparking in a specially constructed tube, when a comparison with the air spectrum, taken under similar conditions, proved that, at any rate, the gas was not nitrogen. At first scarcely a trace of the principal nitrogen lines could be seen, but after standing over water for an hour or two these lines became apparent.

V. *Final Experiment of the Transfer of Nitrogen from Air by means of Red-hot Magnesium.*

A preliminary experiment carried out by Mr. Percy Williams on the absorption of atmospheric nitrogen, freed from oxygen by means of red-hot copper, in which the gas was not passed over, but simply allowed to remain in contact with the metal, gave a residue of density 14.88. This result, although not conclusive, was encouraging; and an attempt was made, on a larger scale, by passing atmospheric nitrogen backwards and forwards over red-hot magnesium from one large gas-holder to another to obtain a considerable quantity of the heavier gas. In the course of ten days, about 1500 c.c. were collected and transferred gradually to a mercury gas-holder, from which the gas was passed over soda lime, phosphoric anhydride, magnesium at a red heat, copper oxide, soda-lime, and phosphoric anhydride into a second mercury gas-holder. After some days the gas was reduced in volume to about 200 c.c., and its density was found to be 10.1. After further absorption, in which the volume was still further reduced, the density of the residue was increased to 19.60.

On passing sparks for several hours through a mixture of a small quantity of this gas with oxygen, its volume was still further reduced. Assuming that this reduction was due to the further elimination of nitrogen, the density of the remaining gas was calculated to be 20.0.

The spectrum of the gas of density 19.60, though showing nitrogen bands, showed many other lines which were not recognisable as belonging to any known element.

VI. *Proof of the Presence of Argon in Air by means of Atmospheric Nitrogen.*

It has already (p. 11.) been suggested that if "atmospheric nitrogen" contains two gases of different densities, it should be possible to obtain direct evidence of the fact by the method of analysis. The present section contains an account of carefully conducted experiments directed to this end.

The apparatus was prepared (after Graham) by combining a number of "charwarden" tobacco pipes. At first twelve pipes were used in three groups, each group including four pipes connected in series. The three groups were then connected in parallel, and placed in a large glass tube closed in such a way that a partial vacuum could be maintained in the space outside the pipes by a water pump. One end of the combination of pipes was open to the atmosphere; the other end was connected to a bottle aspirator, initially full of water, and so arranged as to draw about 2 per cent. of the air which entered the other end of the pipes. The gas collected was thus a very small proportion of that which leaked through the pores of the pipes, and should be relatively rich in the heavier constituents of the atmosphere. The flow of water from the aspirator could not be maintained very constant, but the rate of 2 per cent. was never much exceeded.

The air thus obtained was treated exactly as ordinary air had been treated in determinations of the density of atmospheric nitrogen. Oxygen was removed by red-hot copper, followed by cupric oxide, ammonia by sulphuric acid, moisture and carbonic acid by potash and phosphoric anhydride.

In a total weight of approximately 2.3 grams the excess of weight of the diffuse nitrogen over ordinary atmospheric nitrogen was in four experiments, 0.0219, 0.0214, 0.0227, 0.0215.

The mean excess of the four determinations is 0.02262 gram.

or, if we omit the first, which depended upon a vacuum weighing of two months old, 0.02187 gram.

The gas from prepared air was thus in every case denser than from unprepared air, and to an extent much beyond the possible errors of experiment. The excess was, however, less than had been expected, and it was thought that the arrangement of the pipes could be improved. The final delivery of gas from each of the groups in parallel being so small in comparison with the whole streams concerned, it seemed possible that each group was not contributing its proper share, and even that there might be a flow in the wrong direction at the delivery end of one or two of them. To meet this objection, the arrangement in parallel had to be abandoned, and for the remaining experiments eight pipes were connected in simple series. The porous surface in operation was thus reduced, but this was partly compensated for by an improved vacuum. Two experiments were made under the new conditions, in which the excess was 1.0037 : 11.0033.

The excess being larger than before is doubtless due to the greater efficiency of the atomysing apparatus. It should be mentioned that the above recorded experiments include all that have been tried, and the conclusion seems inevitable that "atmospheric nitrogen" is a mixture, and not a simple body.

It was hoped that the concentration of the heavier constituent would be sufficient to facilitate its preparation in a pure state by the use of prepared air in substitution for ordinary air in the oxygen apparatus. The advance of 31 milligrams on the 11 milligrams, by which atmospheric nitrogen is heavier than chemical nitrogen, is indeed not to be despised, and the use of prepared air would be convenient if the diffusion apparatus could be set up on a large scale and be made thoroughly self-acting.

VII. *Negative Experiments to prove that Argon is not derived from Nitrogen from Chemical Sources.*

Although the evidence of the existence of argon in the atmosphere, derived from the comparison of densities of atmospheric and chemical nitrogen and from the diffusion experiments (§ VI.), appeared overwhelming, we have thought it undesirable to shrink from any labour that would tend to complete the verification. With this object in view, an experiment was undertaken and carried to a conclusion on November 13, in which 3 litres of chemical nitrogen, prepared from ammonium nitrite, were treated with oxygen in precisely the manner in which atmospheric nitrogen had been found to yield a residue of argon. The gas remaining at the close of the large scale operations was worked up as usual with battery and coil until the spectrum showed only slight traces of the nitrogen lines. When cold, the residue measured 4 c.c. This was transferred, and after treatment with alkaline pyrogallate to remove oxygen, measured 3.3 c.c. If atmospheric nitrogen had been employed, the final residue should have been about 30 c.c. Of the 3.3 c.c. actually left, a part is accounted for by an accident, and the result of the experiment is to show that argon is not formed by sparking a mixture of oxygen and chemical nitrogen.

In a second experiment of the same kind 5660 c.c. of nitrogen from ammonium nitrite was treated with oxygen. The final residue was 3.5 c.c. and was found to consist mainly of argon.

The source of the residual argon is to be sought in the water used for the manipulation of the large quantities of gas (5 litres of nitrogen and 11 litres of oxygen) employed. When carbonic acid was collected in a similar manner and subsequently absorbed by potash, it was found to have acquired a contamination consistent with this explanation.

Negative experiments were also carried out, absorbing nitrogen by means of magnesium. In one instance 3 litres of nitrogen prepared from ammonium chloride and bleaching-powder was reduced in volume to 1.5 c.c., and on sparking with oxygen its volume was further reduced to about 3 c.c. The residue appeared to consist of argon. Another experiment, in which 15 litres of nitrogen from ammonium nitrite was absorbed, gave a final residue of 3.5 c.c. Atmospheric nitrogen, in the latter case, would have yielded 150 c.c., hence less than 1/40th of the normal quantity was obtained. It should be mentioned that leakage occurred at one stage, by which perhaps 200 c.c. of air entered the apparatus; and besides, the nitrogen was collected over water from which it doubtless acquired some argon. Quantitative negative experiments of this nature are exceedingly difficult, and require a long time to carry them to a successful conclusion.

VIII. Separation of Argon on a Large Scale.

To prepare argon on a large scale, air is freed from oxygen by means of red-hot copper. The residue is then passed from a gas-holder through a combustion tube, heated in a furnace, and containing copper, in order to remove all traces of oxygen; the issuing gas is then dried by passage over soda-lime and phosphorus pentoxide, after passage through a small U tube containing sulphuric acid, to indicate the rate of flow. It then enters a combustion-tube packed tightly with magnesium turnings, and heated to redness in a second furnace. From this tube it passes through a second index tube, and enters a small gas-holder capable of containing 3 or 4 litres. A single tube of magnesium will absorb from 7 to 8 litres of nitrogen. The temperature must be nearly that of the fusion of the glass, and the current of gas must be carefully regulated, else the heat developed by the union of the magnesium with nitrogen will fuse the tube.

Having collected the residue from 100 or 150 litres of atmospheric nitrogen, which may amount to 4 or 5 litres, it is transferred to a small gas-holder connected with an apparatus, whereby, by means of a species of a self-acting Sprengel's pump, the gas is caused to circulate through a tube half filled with copper and half with copper oxide; it then traverses a tube half filled with soda-lime and half with phosphorus pentoxide; it then passes a reservoir of about 300 c.c. capacity, from which, by raising a mercury reservoir, it can be expelled into a small gas-holder. Next it passes through a tube containing magnesium turnings heated to bright redness. The gas is thus freed from any possible contamination with oxygen, hydrogen, or hydrocarbons, and nitrogen is gradually absorbed. As the amount of gas in the tubes and reservoir diminishes in volume, it draws supplies from the gas-holder, and finally, the circulating system is full of argon in a pure state. The circulating system of tubes is connected with a mercury pump, so that, in changing the magnesium tube, no gas may be lost. Before ceasing to heat the magnesium tube the system is pumped empty, and the collected gas is restored to the gas-holder; finally, all the argon is transferred from the mercury reservoir to the second small gas-holder, which should preferably be filled with water saturated with argon, so as to prevent contamination from oxygen or nitrogen; or, if preferred, a mercury gas-holder may be employed. The complete removal of nitrogen from argon is very slow towards the end, but circulation for a couple of days usually effects it.

The principal objection to the oxygen method of isolating argon, as hitherto described, is the extreme slowness of the operation. In extending the scale we had the great advantage of the advice of Mr. Crookes, who not long since called attention to the flame rising from platinum terminals, which convey a high tension alternating electric discharge, and pointed out its dependence upon combustion of the nitrogen and oxygen of the air.<sup>1</sup> The plant consists of a De Meritens alternator, actuated by a gas engine, and the currents are transformed to a high potential by means of a Ruhmkorff or other suitable induction coil. The highest rate of absorption of the mixed gases yet attained is 3 litres per hour, about 3000 times that of Cavendish. It is necessary to keep the apparatus cool, and from this and other causes a good many difficulties have been encountered.

In one experiment of this kind, the total air led in after seven days' working, amounted to 7925 c.c., and of oxygen (prepared from chlorate of potash), 9137 c.c. On the eighth and ninth days oxygen alone was added, of which about 500 c.c. was consumed, while there remained about 700 c.c. in the flask. Hence the proportion in which the air and oxygen combined was as 79:96. The progress of the removal of the nitrogen was examined from time to time with the spectro-scope, and became ultimately very slow. At last the yellow line disappeared, the contraction having apparently stopped for two hours. It is worthy of notice that, with the removal of the nitrogen, the arc discharge changes greatly in appearance, becoming narrower and blue rather than greenish in colour.

The final treatment of the residual 700 c.c. of gas was on the model of the small scale operations already described. Oxygen or hydrogen could be supplied at pleasure from an electrolytic apparatus, but in no way could the volume be reduced below 65 c.c. This residue refused oxidation, and showed no trace of the yellow line of nitrogen, even under favourable conditions.

<sup>1</sup> *Chemical News*, vol. lxx. p. 301, 1872.

When the gas stood for some days over water, the nitrogen line reasserted itself in the spectrum, and many hours' sparking with a little oxygen was required again to get rid of it. Intentional additions of air to gas free from nitrogen showed that about 1½ per cent. was clearly, and about 3 per cent. was conspicuously, visible. About the same numbers apply to the visibility of nitrogen in oxygen when sparked under these conditions, that is, at atmospheric pressure, and with a jar connected to the secondary terminals.

IX. Density of Argon prepared by means of Oxygen.

A first estimate of the density of argon prepared by the oxygen method was founded upon the data already recorded respecting the volume present in air, on the assumption that the accurately known densities of atmospheric and of chemical nitrogen differ on account of the presence of argon in the former, and that during the treatment with oxygen nothing is oxidised except nitrogen. Thus, if

- D = density of chemical nitrogen.
- D' = " atmospheric nitrogen,
- d = " argon,
- a = proportional volume of argon in atmospheric nitrogen,

the law of mixtures give

$$aD + (1 - a)D' = D,$$

$$\text{or } d = D - (D' - D)a.$$

In this formula D' - D and a are both small, but they are known with fair accuracy. From the data already given

$$a = \frac{05}{0.79 \cdot 7925},$$

whence if (on an arbitrary scale of reckoning) D = 2.2990, D' = 2.3102, we find d = 3.378. Thus if N<sub>2</sub> be 14, or O<sub>2</sub> be 16, the density of argon is 20.6.

A direct determination by weighing is desirable, but hitherto it has not been feasible to collect by this means sufficient to fill the large globe employed for other gases. A mixture of about 400 c.c. of argon with pure oxygen, however, gave the weight 2.7315, 0.1045 in excess of the weight of oxygen, viz. 2.6270. Thus, if a be the ratio of the volume of argon to the whole volume, the number for argon will be

$$2.6270 \cdot 0.1045/a.$$

The value of a, being involved only in the excess of weight above that of oxygen, does not require to be known very accurately. Sufficiently concordant analyses by two methods gave a = 0.1845; whence for the weight of the gas we get 3.193, so that, if O<sub>2</sub> = 16, the density of the gas would be 19.45. An allowance for residual nitrogen, still visible in the gas before admixture of oxygen, raises this number to 19.7, which may be taken as the density of pure argon resulting from this determination.

X. Density of Argon prepared by means of Magnesium.

The density of the original sample of argon prepared has already been mentioned. It was 19.09; and, after sparking with oxygen, it was calculated to be 20.0. The most reliable results of a number of determinations give it as 19.90. The difficulty in accurately determining the density is to make sure that all nitrogen has been removed. The sample of density 19.90 showed no spectrum of nitrogen when examined in a vacuum tube. It is right, however, to remark that the highest density registered was 20.38. But there is some reason here to distrust the weighing of the vacuum globe.

XI. Spectrum of Argon.

The spectrum of argon, seen in a vacuum tube of about 3 mm. pressure, consists of a great number of lines, distributed over almost the whole visible field. Two lines are specially characteristic; they are less refrangible than the red lines of hydrogen or lithium, and serve well to identify the gas, when examined in this way. Mr. Crookes, who will give a full account of the spectrum in a separate communication, has kindly furnished us with the accurate wave-lengths of these lines, as well as of some others next to be described; they are respectively 699.56 and 705.64, 10<sup>-6</sup> mm.

Besides these red lines, a bright yellow line, more refrangible than the sodium line, occurs at 603.84. A group of five bright

green lines occurs next, besides a number of less intensity. Of the group of five, the second, which is perhaps the most brilliant, has the wave-length 561.60. There is next a blue or blue violet line of wave-length 470.2; and last, in the less easily visible part of the spectrum, there are five strong violet lines, of which the fourth, which is the most brilliant, has the wave-length of 421.0.

Unfortunately, the red lines, which are not to be mistaken for those of any other substance, are not easily seen when a discharge is passed through argon at atmospheric pressure. The spectrum seen under these conditions has been examined by Prof. Schuster. The most characteristic lines are perhaps those in the neighbourhood of F, and are very easily seen if there be not too much nitrogen, in spite of the presence of some oxygen and water vapour. The approximate wave-lengths are

487.91	Strong.
[486.67]	F.
484.71	Not quite so strong.
480.52	Strong.
470.50	Fairly strong characteristic triplet.
473.53	
472.50	

It is necessary to anticipate Mr. Crookes' communication, and to state that when the current is passed from the induction coil in one direction, that end of the capillary tube next the positive pole appears of a redder, and that next the negative pole of a bluer hue. There are, in effect, two spectra, which Mr. Crookes has succeeded in separating to a considerable extent. Mr. E. C. Baly, who has noticed a similar phenomenon,<sup>1</sup> attributes it to the presence of two gases. The conclusion would follow that what we have termed "argon" is in reality a mixture of two gases which have as yet not been separated. This conclusion, if true, is of great importance, and experiments are now in progress to test it by the use of other physical methods. The full bearing of this possibility will appear later.

The presence of a small quantity of nitrogen interferes greatly with the argon spectrum. But we have found that in a tube with platinum electrodes, after the discharge has been passed for four hours, the spectrum of nitrogen disappears, and the argon spectrum manifests itself in full purity. A specially constructed tube with magnesium electrodes, which we hoped would yield good results, removed all traces of nitrogen, it is true; but hydrogen was evolved from the magnesium, and showed its characteristic lines very strongly. However, these are easily identified. The gas evolved on heating magnesium *in vacuo*, as proved by a separate experiment, consists entirely of hydrogen.

Mr. Crookes has proved the identity of the chief lines of the spectrum of gas separated from air-nitrogen by aid of magnesium with that remaining after sparking the air nitrogen with oxygen in presence of caustic soda solution.

Prof. Schuster also has found the principal lines identical in the spectra of the two gases, as observed by the jar discharge at atmospheric pressure.

XII. Solubility of Argon in Water.

Determinations of the solubility in water of argon, prepared by sparking, gave 3.04 volumes per 100 of water at 12°. The solubility of gas prepared by means of magnesium was found to be 4.05 volumes per 100 at 13.0°. The gas is therefore about 2½ times as soluble as nitrogen, and possesses approximately the same solubility as oxygen.

The fact that argon is more soluble than nitrogen would lead us to expect it in increased proportion in the dissolved gases of rain water. Experiment has confirmed this anticipation. "Nitrogen" prepared from the dissolved gases of water supplied from a rain-water cistern was weighed upon two occasions. The weights, corresponding to those recorded in § 1, were 2.3221 and 2.3227, showing an excess of 2.4 milligrams above the weight of true nitrogen. Since the corresponding excess for "atmospheric nitrogen" is 11 milligram, we conclude that the water "nitrogen" is relatively more than twice as rich in argon.

On the other hand, gas evolved from the hot spring at Bath,

and collected for us by Dr. A. Richardson, gave a residue after removal of oxygen and carbonic acid, whose weight was only about midway between that of true and atmospheric nitrogen.

XIII. Behaviour at Low Temperatures.<sup>1</sup>

Preliminary experiments, carried out to liquefy argon at a pressure of about 100 atmospheres, and at a temperature of -90°, failed. No appearance of liquefaction could be observed.

Prof. Charles Olszewski, of Cracow, the well-known authority on the constants of liquefied gases at low temperatures, kindly offered to make experiments on the liquefaction of argon. His results are embodied in a separate communication, but it is allowable to state here that the gas has a lower critical temperature (-121°) and a lower boiling point (-187°) than oxygen, and that he has succeeded in solidifying argon to white crystals, melting at -189.6°. The density of the liquid is approximately 1.5, that of oxygen being 1.24, and of nitrogen 0.885. The sample of gas he experimented with was exceptionally pure, and had been prepared by help of magnesium. It showed no trace of nitrogen when examined in a vacuum tube.

XIV. Ratio of Specific Heats.

In order to decide regarding the elementary or compound nature of argon, experiments were made on the velocity of sound in it. It will be remembered that, from the velocity of sound in a gas, the ratio of specific heat at constant pressure to that at constant volume can be deduced by means of the equation

$$n\lambda \quad v = \sqrt{\frac{1}{d} \left\{ \frac{C_p}{C_v} (1 + at) \right\}}$$

when *n* is the frequency,  $\lambda$  the wave-length of sound, *v* its velocity, *c* the isothermal elasticity, *d* the density, (1 + *at*) the temperature correction, *C<sub>p</sub>* the specific heat at constant pressure, and *C<sub>v</sub>* that at constant volume. In comparing two gases at the same temperature, each of which obeys Boyle's law with sufficient approximation, and in using the same sound, many of these terms disappear, and the ratio of specific heats of one gas may be deduced from that of the other, if known, by means of the proportion

$$\lambda^2 d : \lambda^2 d' :: 1.41 : a,$$

where, for example,  $\lambda$  and *d* refer to air, of which the ratio is 1.41, according to observations by Rontgen, Wullner, Kayser, and Jamin and Richard.

Two completely different series of observations, one in a tube of about 2 mm. diameter, and one in one of 8 mm., made with entirely different samples of gas, gave, the first, 1.65 as the ratio, and, the second, 1.61.

Experiments made with the first tube, to test the accuracy of its working, gave for carbon dioxide the ratio 1.276, instead of 1.288, the mean of all previous determinations; and the half wave-length of sound in hydrogen was found to be 73.6, instead of 74.5, the mean of those previously found. The ratio of the specific heats of hydrogen found was 1.39, instead of 1.402.

There can be no doubt, therefore, that argon gives practically the ratio of specific heats, viz. 1.66, proper to a gas in which all the energy is translational. The only other gas which has been found to behave similarly is mercury gas, at a high temperature.

XV. Attempts to induce Chemical Combination.

Many attempts to induce argon to combine will be described in full in the complete paper. Suffice it to say here, that all such attempts have as yet proved abortive. Argon does not combine with oxygen in presence of alkali under the influence of the electric discharge, nor with hydrogen in presence of acid or alkali also when sparked; nor with chlorine, dry or moist, when sparked; nor with phosphorus at a bright-red heat, nor with sulphur at bright redness. Tellurium may be distilled in a current of the gas; so may sodium and potassium, their metallic lustre remaining unchanged. It is unabsorbed by passing it over fused red-hot caustic soda, or soda-lime heated to bright redness; it passes unaffected over fused and bright red-hot potassium nitrate; and red-hot sodium peroxide does not combine with it. Persulphides of sodium and calcium

<sup>1</sup> The arrangements for the experiments upon this branch of the subject were left entirely in Prof. Ramsay's hands.

<sup>2</sup> Kundt and Warburg, *Zogg. Ann.* vol. cxxxv. pp. 337 and 507.

are also without action at a red heat. Platinum black does not absorb it, nor does platinum sponge, and wet oxidising and chlorinating agents, such as nitro-hydrochloric acid, bromine water, bromine and alkali, and hydrochloric acid and potassium permanganate, are entirely without action. Experiments with fluorine are in contemplation, but the difficulty is great; and an attempt will be made to produce a carbon arc in the gas. Mixtures of sodium and silica and of sodium and boracic anhydride are also without action, hence it appears to resist attack by nascent silicon and by nascent boron.

XVI. *General Conclusions.*

It remains, finally, to discuss the probable nature of the gas, or mixture of gases, which we have succeeded in separating from atmospheric air, and which we provisionally name *argon*.

The presence of argon in the atmosphere is proved by many lines of evidence. The high density of "atmospheric nitrogen," the lower density of nitrogen from chemical sources, and the uniformity in the density of samples of chemical nitrogen prepared from different compounds, lead to the conclusion that the cause of the anomaly is the presence of a heavy gas in air. If that gas possess the density 20 compared with hydrogen, "atmospheric" nitrogen should contain of it approximately 1 per cent. This is, in fact, found to be the case. Moreover, as nitrogen is removed from air by means of red-hot magnesium, the density of the remaining gas rises proportionately to the concentration of the heavier constituent.

Second. This gas has been concentrated in the atmosphere by diffusion. It is true that it has not been freed from oxygen and nitrogen by diffusion, but the process of diffusion increases, relatively to nitrogen, the amount of argon in that portion which does not pass through the porous walls. This has been proved by its increase in density.

Third. As the solubility of argon in water is relatively high, it is to be expected that the density of the mixture of argon and nitrogen, pumped out of water along with oxygen, should, after the removal of the oxygen, be higher than that of "atmospheric" nitrogen. Experiment has shown that the density is considerably increased.

Fourth. It is in the highest degree improbable that two processes, so different from each other, should manufacture the same product. The explanation is simple if it be granted that these processes merely eliminate nitrogen from an "atmospheric" mixture. Moreover, as argon is an element, or a mixture of elements, its manufacture would mean its separation from one of the substances employed. The gas which can be removed from red-hot magnesium in a vacuum has been found to be wholly hydrogen. Nitrogen from chemical sources has been practically all absorbed by magnesium, and also when sparked in presence of oxygen; hence argon cannot have resulted from the decomposition of nitrogen. That it is not produced from oxygen is sufficiently borne out by its preparation by means of magnesium.

Other arguments could be adduced, but the above are sufficient to justify the conclusion that argon is present in the atmosphere.

The identity of the leading lines in the spectrum, the similar solubility and the similar density, appear to prove the identity of the argon prepared by both processes.

Argon is an element, or a mixture of elements, for Clausius has shown that if  $K$  be the energy of translatory motion of the molecules of a gas, and  $H$  their whole kinetic energy, then

$$\frac{K}{H} = \frac{3(C_p - C_v)}{2C_v}$$

$C_p$  and  $C_v$  denoting as usual the specific heat at constant pressure and at constant volume respectively. Hence if, as for mercury vapour and for argon (§ XIV.), the ratio of specific heats  $C_p : C_v$  be  $\frac{5}{3}$ , it follows that  $K = H$ , or that the whole kinetic energy of the gas is accounted for by the translatory motion of its molecules. In the case of mercury the absence of interatomic energy is regarded as proof of the monatomic character of the vapour, and the conclusion holds equally good for argon.

The only alternative is to suppose that if argon molecules are di- or polyatomic, the atoms acquire no relative motion, even of rotation, a conclusion exceedingly improbable in itself and one postulating the sphericity of such complex groups of atoms.

Now a monatomic gas can be only an element, or a mixture of

elements; and hence it follows that argon is not of a compound nature.

From Avogadro's law, the density of a gas is half its molecular weight; and as the density of argon is approximately 20, hence its molecular weight must be 40. But its molecule is identical with its atom; hence its atomic weight, or, if it be a mixture, the mean of the atomic weights of that mixture, taken for the proportion in which they are present, must be 40.

There is evidence both for and against the hypothesis that argon is a mixture: for, owing to Mr. Crookes' observations of the dual character of its spectrum; against, because of Prof. Olszewski's statement that it has a definite melting point, a definite boiling point, and a definite critical temperature and pressure; and because on compressing the gas in presence of its liquid, pressure remains sensibly constant until all gas has condensed to liquid. The latter experiments are the well-known criteria of a pure substance; the former is not known with certainty to be characteristic of a mixture. The conclusions which follow are, however, so startling, that in our future experimental work we shall endeavour to decide the question by other means.

For the present, however, the balance of evidence seems to point to simplicity. We have the effort to discuss the relations to other elements of an element of atomic weight 40. We inclined for long to the view that argon was possibly one or more than one of the elements which might be expected to follow fluorine in the periodic classification of the elements—elements which should have an atomic weight between 19, that of fluorine, and 23, that of sodium. But this view is completely put out of court by the discovery of the monatomic nature of its molecules.

The series of elements possessing atomic weights near 40 are:—

Chlorine ... ..	35.5
Potassium ... ..	39.1
Calcium ... ..	40.0
Scandium ... ..	44.0

There can be no doubt that potassium, calcium, and scandium follow legitimately their predecessors in the vertical columns, lithium, beryllium, and boron, and that they are in almost certain relation with rubidium, strontium, and (but not so certainly) yttrium. If argon be a single element, then there is reason to doubt whether the periodic classification of the elements is complete; whether, in fact, elements may not exist which cannot be fitted among those of which it is composed. On the other hand, if argon be a mixture of two elements, they might find place in the eighth group, one after chlorine and one after bromine. Assuming 37 (the approximate mean between the atomic weights of chlorine and potassium) to be the atomic weight of the lighter element, and 40 the mean atomic weight found, and supposing that the second element has an atomic weight between those of bromine, 80, and rubidium, 85.5, viz. 82, the mixture should consist of 93.3 per cent. of the lighter, and 6.7 per cent. of the heavier element. But it appears improbable that such a high percentage as 6.7 of a heavier element should have escaped detection during liquefaction.

If it be supposed that argon belongs to the eighth group, then its properties would fit fairly well with what might be anticipated. For the series, which contains

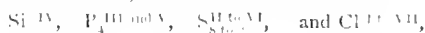

might be expected to end with an element of monatomic molecules, of no valency, *i.e.* incapable of forming a compound, or, if forming one, being an octid; and it would form a possible transition to potassium, with its monovalence, on the other hand. Such conceptions are, however, of a speculative nature; yet they may be perhaps excused, if they in any way lead to experiments which tend to throw more light on the anomalies of this curious element.

In conclusion, it need excite no astonishment that argon is so indifferent to reagents. For mercury, although a monatomic element, forms compounds which are by no means stable at a high temperature in the gaseous state; and attempts to produce compounds of argon may be likened to attempts to cause combination between mercury gas at 800° and other elements. As for the physical condition of argon, that of a gas, we possess no knowledge why carbon, with its low atomic weight, should be a solid, while nitrogen is a gas, except in so far as we ascribe molecular complexity to the former and comparative molecular simplicity to the latter. Argon, with its compara-

ively low weight and its molecular simplicity, might well be expected to rank among the gases. And its inertness, which has suggested its name, sufficiently explains why it has not previously been discovered as a constituent of compound bodies.

We would suggest for this element, assuming provisionally that it is not a mixture, the symbol Ar.

We have to record our thanks to Messrs. Gordon, Kellas, and Matthews, who have materially assisted us in the prosecution of this research.

#### ON THE SPECTRA OF ARGON.

Through the kindness of Lord Rayleigh and Prof. Ramsay I have been enabled to examine the spectrum of this gas in a very accurate spectro-scope, and also to take photographs of its spectra in a spectrograph fitted with a complete quartz train. The results are both interesting and important, and entirely corroborate the conclusions arrived at by the discoverers of argon.

Argon resembles nitrogen in that it gives two distinct spectra according to the strength of the induction current employed. But while the two spectra of nitrogen are different in character, the one showing dilated bands and the other sharp lines, the argon spectra both consist of sharp lines. It is, however, very difficult to get argon so free from nitrogen that it will not show the nitrogen bands superposed on its own special system of lines. I have used argon prepared by Lord Rayleigh, Prof. Ramsay, and myself, and, however free it was supposed to be from nitrogen, I could always detect the nitrogen bands in its spectrum. These, however, soon disappear when the induction spark is passed through the tube for some time, varying from a few minutes to a few hours.

The pressure of argon giving the greatest luminosity and most distinct spectrum is 3 mm. (The best pressure for nitrogen is 75 or 80 mm.) At this point the colour of the discharge is an orange-red, and the spectrum is rich in red rays, two being especially prominent at wave-lengths 690.56 and 705.64. On passing the current the traces of nitrogen bands soon disappear, and the argon spectrum is seen in a state of purity.

If the pressure is further reduced, and a Leyden jar intercalated in the circuit, the colour of the luminous discharge changes from red to a rich steel-blue, and the spectrum shows an almost entirely different set of lines. The two spectra, called for brevity red and blue, are shown on the large map, the upper spectrum being that of "blue" argon, and the lower one that of "red" argon. It is not easy to obtain the blue colour and spectrum entirely free from the red. It appears that a low electric motive force (3 cm. spark, or 27,600 volts) is required to bring out the red, and a high E.M.F. and a very hot spark for the blue. The red glow is produced by the positive spark, and the blue by the negative spark.

I have taken photographs of the two spectra of argon partly superposed. In this way their dissimilarity is readily seen. In the spectrum of the blue glow I have counted 119 lines, and in that of the red glow 80 lines, making 199 in all. Of these 26 appear to be common to both spectra.

The disappearance of the red glow and the appearance of the blue glow in argon as the exhaustion increases also resembles the disappearance of the red line of hydrogen when exhaustion is raised to a high point.

I have prepared tubes containing other gases as well as nitrogen at different pressures, and have examined their spectra both by eye observation and by photography. The sharp line spectrum of nitrogen is not nearly so striking in brilliancy, number or sharpness of lines as are those of argon, and the most careful scrutiny fails to show any connection between the spectra. I can detect no line in common between the spectra of argon and the band spectrum of nitrogen there are two or three close approximations of lines, but a projection on the screen of a magnified image of the two spectra partly superposed will show that at least two of these are not really coincidences.

I have found no other spectrum-giving gas, or vapour yield spectra at all like those of argon, and the apparent coincidences in one of the lines, which on one or two occasions are noticed, have been very few, and would probably disappear on using a

higher dispersion. Having once obtained a tube of argon giving the pure spectra, I can make no alteration in it, other than what I have explained takes place on varying the spark or increasing the exhaustion, when the two spectra change from one to the other. As far, therefore, as spectrum work can decide, the verdict must, I think, be that Lord Rayleigh and Prof. Ramsay have added one, if not two, members to the family of elementary bodies.

#### The Two Spectra of Argon.

[Lines having intensities below 8 have been omitted.]

Blue.		Red.	
Wave-length.	Intensity.	Wave-length	Intensity.
		705.64	10
		690.56	9
		640.7	9
603.84	8	603.8	8
		565.1	9
		561.0	9
		555.70	10
		549.05	8
		518.58	10
		510.5	9
514.0	10		
509.5	10		
500.7	9		
496.55	9		
493.8	10		
487.9	10		
		470.12	8
460.80	8		
450.05	8	450.95	9
442.05	10		
442.25	10		
439.95	10		
437.05	9		
436.60	9		
434.85	10		
433.35	9	433.35	9
		430.95	9
420.90	9		
		427.20	8
425.05	8	425.05	9
420.10	10	420.10	10
419.80	9	419.80	9
419.15	9	419.15	9
418.30	8	418.30	8
416.45	8		
415.05	10	415.05	10
410.50	8		
407.25	8		
404.40	8	404.40	9
401.30	8		
394.85	9	394.85	10
392.85	8		
		390.45	8
386.85	8		
385.15	10		
378.68	9		
376.60	8		
372.68	10		
358.70	10		
358.03	9		
357.50	9		
349.00	10		

The totals are:—

119 lines in the "blue" spectrum.  
80 lines in the "red" spectrum.

199 total lines.  
26 lines common to the two spectra.

A. R. C. Experiment by Mr. Watson, Glasgow, 1894.

FIGURE 1. The different spectra of argon and other gaseous spectra taken by the author and reproduced in the text.



THE LIQUEFACTION AND SOLIDIFICATION OF ARGON.<sup>1</sup>

Having been furnished, by Prof. Ramsay's kindness, with a sample of the new gas, argon, I have carried out experiments on its behaviour at a low temperature and at high pressures, in order to contribute, at least in part, to the knowledge of the properties of this interesting body.

Four series of experiments in all were carried out, two with the object of determining the critical temperature and pressure of argon, as well as measuring its vapour pressure at several other low temperatures, while two other series served to determine its boiling and freezing points under atmospheric pressure, as well as its density at its boiling point.

A detailed description of these experiments will be given in another place; I shall here give only a short description of the manner in which they were made.

For the first two experiments I made use of a Cailletet's apparatus. Its metallic manometer had been previously compared with the readings of a mercury manometer. As cooling agent I used liquid ethylene, boiling under diminished pressure. The glass tube of Cailletet's apparatus was so arranged that the portion immersed in the liquid ethylene had comparatively thin walls (not exceeding 1 mm.), so as to equalise the external and internal temperature as quickly as possible.

In both the other experiments the argon was contained in a burette, closed at both ends with glass stop-cocks. By connecting the lower end of the burette with a mercury reservoir, the argon was transferred into a narrow glass tube fused at its lower end to the upper end of the burette, and in which the argon was liquefied, and its volume in the liquid state measured. In these two series of experiments liquid oxygen, boiling under atmospheric or under diminished pressure, was employed as a cooling agent. I made use of a hydrogen thermometer in all these experiments to measure low temperatures.

*Determination of the Critical Constants of Argon.*

As soon as the temperature of liquid ethylene had been lowered to  $-128^{\circ}6$ , the argon easily condensed to a colourless liquid under a pressure of 38 atmospheres. On slowly raising the temperature of the ethylene, the meniscus of the liquid argon became less and less distinct, and finally vanished.

Seven determinations of the disappearance of the meniscus proved that the critical pressure was 50.6 atmospheres; but determinations of the critical temperature show slight differences.

quadruple walls, so as to isolate the liquid from external heat. After the liquid oxygen had been thus poured under atmospheric pressure, a great part of it evaporated, but there still remained about 70 c.c. boiling under atmospheric pressure. A calibrated tube, intended to receive the argon to be liquefied, and the hydrogen thermometer were immersed in the boiling oxygen. At this temperature ( $-182^{\circ}7$ ) on admitting argon, no appearance of liquefaction could be noticed, even when compressed by adding a quarter of an atmosphere pressure to that of the atmosphere. This shows that its boiling point lies below that of oxygen. But on diminishing the temperature of the liquid oxygen below  $-187^{\circ}$ , the liquefaction of argon became manifest. When liquefaction had taken place, I carefully equalised the pressure of the argon with that of the atmosphere, and regulated the temperature, so that the state of balance was maintained for a long time. This process gives the boiling point of argon under atmospheric pressure. Four experiments gave the numbers  $-185^{\circ}7$ ,  $-185^{\circ}8$ ,  $-187^{\circ}0$ , and  $-187^{\circ}3$ . The mean is  $-185^{\circ}9$ , which I consider to be the boiling point under atmospheric pressure (740.5 mm.).

The quantity of argon used for these experiments, reduced to normal temperature and pressure, was 99.5 c.c.; the quantity of liquid corresponding to that volume of gas was approximately 0.114 c.c. Hence the density of argon at its boiling point may be taken as approximately 1.5. Two other determinations of the density of liquid argon, for which I employed still smaller quantities of the gas, yielded rather smaller numbers. Owing to the small amount of argon used for these experiments, the numbers given cannot lay claim to great exactness; yet they prove that the density of liquid argon at its boiling point ( $-187^{\circ}$ ) is much higher than that of oxygen, which I have found, under similar conditions, to be 1.124.

By lowering the temperature of the oxygen to  $-191^{\circ}$  by slow exhaustion, the argon froze to a crystalline mass, resembling ice; on further lowering temperature it became white and opaque. When the temperature was raised it melted; four observations which I made to determine its melting point gave the numbers:  $-189^{\circ}0$ ,  $-190^{\circ}6$ ,  $-189^{\circ}6$ , and  $-189^{\circ}4$ . The mean of these numbers is  $-189^{\circ}6$ ; and this may be accepted as the melting point of argon.

In the following table I have given a comparison of physical constants, in which those of argon are compared with those of other so-called permanent gases. The data are from my previous work on the subject.

Name.	Critical temperature.	Critical pressure.	Boiling point.	Freezing point.	Freezing pressure.	Density of gas.	Density of liquid at boiling point.	Colour of liquid.
	Below	Atmos.			mm.			
Hydrogen (H <sub>2</sub> )	220.0	20.0	?	?	?	1.0	?	Colourless.
Nitrogen (N <sub>2</sub> )	-146.0	35.0	-194.4	-214.0	60	14.0	0.885	"
Carbonic oxide (CO)	-130.5	35.5	190.0	-207.0	100	14.0	?	"
Argon (A <sub>1</sub> )	-121.0	50.6	-187.0	-189.6	?	19.9	1.5	"
Oxygen (O <sub>2</sub> )	-118.8	50.8	-182.7	?	?	16.0	1.124	Bluish.
Nitric oxide (NO)	-93.5	71.2	153.6	-167.0	138	15.0	?	Colourless
Methane (CH <sub>4</sub> )	-81.8	54.9	164.0	-185.8	80	8.0	0.415	"

The mean of the seven estimations of the critical temperature is  $-121$ , and this may be taken as the critical temperature of argon.

The vapour pressures at ten temperatures from  $-128.6$  to  $139.1$  were also determined.

*Determination of the Boiling and Freezing Points.*

Two hundred cubic centimetres of liquid oxygen, prepared in my large apparatus,<sup>2</sup> was poured into a glass vessel with

<sup>1</sup> Abstract of a paper by Dr. K. Olszewski, Professor of Chemistry in the University of Cracow.

<sup>2</sup> *Bulletin International de l'Académie de Cracovie*, June 1890; also *Wiedemann's Beiblätter*, vol. 15, p. 29.

As can be seen from the foregoing table, argon belongs to the so-called "permanent" gases, and, as regards difficulty in liquefying it, it occupies the fourth place, viz. between carbon monoxide and oxygen. Its behaviour on liquefaction places it nearer to oxygen, but it differs entirely from oxygen in being solidifiable; as is well known, oxygen has not yet been made to assume a solid state.

The high density of argon rendered it probable that its liquefaction would take place at a higher temperature than that

<sup>3</sup> I have re-determined the boiling point of oxygen using large quantities of oxygen, and a hydrogen thermometer of much larger dimensions than previously. The registered temperature is 1.3 lower than that which I previously recorded.

at which oxygen exists. Its unexpectedly low critical temperature and boiling point seem to have some relation to its unexpectedly simple molecular constitution.

After the reading of the three foregoing papers, a discussion followed, in which we give the most important results.

Dr. H. F. Armstrong said that the discovery of the existence of a new constituent was undoubtedly a very strong one, and would not admit, meet with very little, or no criticism through the world. But, apart from the facts which were brought forward, there was a portion which was of a wildly speculative character; viz. the possibility of giving the probable nature of this new element. Arguing that the authors were not entirely satisfied with the evidence to be adduced in the application of the Clausius method for the determination of the atomicity of the gas. It was quite generally held that the conclusion which Prof. Ramsay put forward as the only alternative to the one which was apparently reached by the authors of the communication, is a reasonable one. It was quite likely that the two atoms existed separately in each other's embrace, that there was no possibility for them to rise in a nice of an illing outside, and that they were perfectly content to roll on together without taking any of the energy that is put into the molecule. The spectroscopic evidence was not sufficient to justify the conclusion that the new gas was a mixture. The great difficulty in accepting the conclusion that the gas was an element having a molecular weight of 40, and an atomic weight of 20, arose from the difficulty of placing an element of that kind. All these matters, however, would have to be discussed later on more fully, they were matters which could only be discussed very gradually, and more was known about the new substance.

Prof. A. W. Riebeck said that the one curious fact which came out of his study of the series of series of Prof. Ramsay was, that the whole of the work which may have existed on the matter for the last few weeks or months, it was clear that they had now a new constituent of the atmosphere. It seemed to him that the most interesting results arrived at from the physical point of view was the fact that there was no monatomic gas, and that the atomicity of the gas was 2. The experiments conducted by Prof. Ramsay and Prof. Ramsay made it certain that the gas had the particular ratio of specific heats mentioned. Well, then the question arose, What followed from this? In order that this ratio might be obtained it was necessary that the atoms with which they were dealing should be regarded as spheres of the same size, and that wherever the effect might be due to the same cause, the combination of Mendeleef, that was, the atomic weight of 40 was that at present upon no dynamical point of view, it would be reasonable to suppose, it would be reasonable to suppose that the atoms of the gas, on the other hand, the new substance stand on the same footing of these great spheres of the same size, which could not be upset without upsetting the whole of our fundamental ideas of chemistry.

Prof. Ramsay's statement that in the Bessemer process some iron filings of iron were put into a vessel called a converter. It was converted into a vessel of 1000 cubic feet of iron, and the fluid iron. There were 1000 cubic feet of iron in the converter. The fact that Bessemer's iron metal was converted into iron with ferromanganese, and pumped into the converter, of which one-twentieth was manganese, and which had been able to detect any iron in the converter from the water which was run off, was a very important one. It remained to be seen whether the iron was put into the iron, and if it stayed there, whether it was converted into the iron metal. Bessemer metal might be converted into iron, and it could be tried to come out of the converter, and it would be better passed into the converter.

Prof. A. W. Riebeck said that the one curious fact which came out of his study of the series of series of Prof. Ramsay was, that the whole of the work which may have existed on the matter for the last few weeks or months, it was clear that they had now a new constituent of the atmosphere. It seemed to him that the most interesting results arrived at from the physical point of view was the fact that there was no monatomic gas, and that the atomicity of the gas was 2. The experiments conducted by Prof. Ramsay and Prof. Ramsay made it certain that the gas had the particular ratio of specific heats mentioned. Well, then the question arose, What followed from this? In order that this ratio might be obtained it was necessary that the atoms with which they were dealing should be regarded as spheres of the same size, and that wherever the effect might be due to the same cause, the combination of Mendeleef, that was, the atomic weight of 40 was that at present upon no dynamical point of view, it would be reasonable to suppose, it would be reasonable to suppose that the atoms of the gas, on the other hand, the new substance stand on the same footing of these great spheres of the same size, which could not be upset without upsetting the whole of our fundamental ideas of chemistry.

Prof. Ramsay's statement that in the Bessemer process some iron filings of iron were put into a vessel called a converter. It was converted into a vessel of 1000 cubic feet of iron, and the fluid iron. There were 1000 cubic feet of iron in the converter. The fact that Bessemer's iron metal was converted into iron with ferromanganese, and pumped into the converter, of which one-twentieth was manganese, and which had been able to detect any iron in the converter from the water which was run off, was a very important one. It remained to be seen whether the iron was put into the iron, and if it stayed there, whether it was converted into the iron metal. Bessemer metal might be converted into iron, and it could be tried to come out of the converter, and it would be better passed into the converter.

Prof. Ramsay's statement that in the Bessemer process some iron filings of iron were put into a vessel called a converter. It was converted into a vessel of 1000 cubic feet of iron, and the fluid iron. There were 1000 cubic feet of iron in the converter. The fact that Bessemer's iron metal was converted into iron with ferromanganese, and pumped into the converter, of which one-twentieth was manganese, and which had been able to detect any iron in the converter from the water which was run off, was a very important one. It remained to be seen whether the iron was put into the iron, and if it stayed there, whether it was converted into the iron metal. Bessemer metal might be converted into iron, and it could be tried to come out of the converter, and it would be better passed into the converter.

Prof. Ramsay's statement that in the Bessemer process some iron filings of iron were put into a vessel called a converter. It was converted into a vessel of 1000 cubic feet of iron, and the fluid iron. There were 1000 cubic feet of iron in the converter. The fact that Bessemer's iron metal was converted into iron with ferromanganese, and pumped into the converter, of which one-twentieth was manganese, and which had been able to detect any iron in the converter from the water which was run off, was a very important one. It remained to be seen whether the iron was put into the iron, and if it stayed there, whether it was converted into the iron metal. Bessemer metal might be converted into iron, and it could be tried to come out of the converter, and it would be better passed into the converter.

gas there are no internal motions of any consequence. Now, if the atoms in a molecule are so bound together that hardly any internal motions exist, it would, so far as specific heat is concerned, behave like a monatomic element. That the atoms in argon may be very closely connected seems likely from its very great chemical inertness. Hence the conclusion that the ratio of its specific heats may be, not that it is monatomic, but that its atoms are so bound together in its molecule that the molecule behaves as a whole as if it was monatomic." It was difficult to conceive the possibility of such an eccentrically-shaped atom as that to move about without acquiring a considerable energy of rotation. He therefore thought that the only interpretation was that the gas was monatomic.

Lord Kelvin remarked as to the condition under which the ratio of the specific heats could be exactly 1.66, that he did not admit that a spherical atom could fulfil that condition. A spherical atom would not be absolutely smooth. In other words, it must be a Boscovich point. In fact, the only kind of atom that could be conceived as giving, in the dynamical theory of heat, rigorously the ratio 1.66 for the specific heat, was the ideal Boscovich mathematical point endowed with the property of inertia, and with the other property of acting upon neighbouring points with a force depending upon distance.

UNIVERSITY AND EDUCATIONAL INTELLIGENCE.

OXFORD.—A meeting was held on Monday last, in the rooms of the Regius Professor of Medicine, at the University Museum, and was attended by all the scientific professors and teachers of the University, with the exception of one or two, who, being unable to be present, expressed their concurrence by letter. It was unanimously resolved that a memorial connecting Sir Henry Acland's name in a permanent manner with the University Museum should be established. Symply was generally expressed with the scheme already before the public, but it was felt that a more distinctly personal memorial in the Museum was desirable. The future consideration of the proposal will be the subject of a second meeting to be held shortly.

Mr. A. Trevor Batty delivered a lecture before the Ashmolean Society, on Monday last, entitled "Ice-bound in Kolguev." The lecturer narrated his personal experiences, and gave an account of the manners and customs of the Symoyedi, illustrated by numerous lantern-slides and specimens, and he also described the ornithological features of the island.

The Sibthorpian Professor of Rural Economy, Mr. R. Warrington, F.R.S., gave his inaugural lecture to a large audience in the University Museum on Monday afternoon. The subject chosen was "The Present Relations of Agricultural Art and Natural Science." He deplored the want of really good agricultural and horticultural libraries.

CAMBRIDGE.—The election to the Sadleian Professorship of Pure Mathematics, vacant by the death of Prof. Cayley, will be held on Monday, February 25, at 2.30 p.m. The names and testimonials of candidates are to be sent to the Vice-Chancellor by Monday, February 18. The electors are the Vice-Chancellor, Mr. Austen Leigh, Dr. Phear, Dr. Ferrers, Dr. Taylor, Sir G. G. Stokes, Sir R. S. Ball, and Prof. G. H. Darwin.

The Observatory Syndicate propose the appointment of a Second Assistant Observer, at a stipend of £100 a year. The appointment will be for five years, and will be made by the Director, with the consent of the Vice-Chancellor.

SCIENTIFIC SERIALS.

*Annals of Meteorological Journal*, January.—Solar magnetism in meteorology, by Prof. F. H. Bigelow. This article contains some general remarks on the present state of the relations among-out of the relations that have been traced by the author's study of solar magnetism and its influences upon meteorological phenomena. Prof. Bigelow endeavours to show that the usually accepted mode of propagation of energy from the sun to the earth is not the only one that exists, and suggests that another possible mode is due to polarized solar magnetic lines, such as surrounds a magnet. The progress of the investigation was made in three distinct stages: (1) the detection of the time period of the sun's rotation; (2) the determination of

the intensity of the solar magnetic field from meridian to meridian of the sun; (3) the discovery of the inversion of the solar magnetism in certain periods. The author expresses the opinion that the convectional hypothesis of cyclones is untenable, and endeavours to shew, from an examination of the American meteorological curves for the years 1878-93 that the three systems—the one at the sun, that of the magnetic field in the northern hemisphere, and that of the American meteorological field—vary together in block from year to year.—Variations in the character of the seasons, by H. Gawthrop. The division of the year into four seasons is traditional, but when measured as phases of weather, it is not possible to fix these periods within definite limits. The author's investigation leads him to conclude that the primal cause for the variations in the character of the seasons must be traced back through all the effects of diurnal and seasonal insolation, and of the cyclonic storms in the lower atmosphere.

*Wiedemann's Annalen der Physik und Chemie*, No. 1, 1895.—Electromagnetic pulling force, by Max Weber. An iron wire whose length is very great in comparison with its thickness, experiences a pulling force proportional to the field intensity, its magnetisation, and its section area, when its end lies in a magnetic field, and its axis is parallel to the lines of force. If the lines of force are perpendicular to the axis of the wire, it also experiences a pulling force along its axis, which is, however, smaller in iron than the former force. The ratio of the pull along the lines of force to that across it is about 100 in moderate fields (such as  $H = 100$ ), but with increasing strength of field it quickly decreases, and appears to approach unity.—Different forms of multiple resonance, by V. Bjerknes. The conclusion usually drawn from Sarasin and de la Rive's experiments with electric waves propagated along wires, that there are as many stationary wave systems as nodal systems are exhibited by the resonator, is erroneous. These periods are due to the resonator, which resounds to a simple sine oscillation at different points. The only reliable method is to study the wave systems with "nonferrous" indicators, such as spark micrometers, electrometers, bolometers, and small thermo-couples. The difference between electric waves and light waves is that the latter are continually maintained, while the former are damped.—Total reflection of light in dense crystalline substances, by K. Camerer. The measurement of the index of refraction of substances of a crystalline structure by total reflection is attended with various difficulties. In some cases, there is no well-defined limit of total reflection, as in the case of paraffin or bees-wax planed or cast on mercury. When the same substances are cast or pressed on the surface of the prism, two limits, polarised at right angles to each other, are observed. The author explains this by supposing that in the latter case the substances crystallise in a uniaxial form, with their optical axes perpendicular to the surface, while in the former case they are biaxial.—Elastic behaviour of zinc at different temperatures, by Erich Zbarsky. It appears that the suddenness or otherwise of the cooling of cast zinc has no very decided influence upon its brittleness. It is not hardened by rapid cooling to anything like the extent that iron is.

*Bulletin de la Société des Naturalistes de Moscou*, 1894, No. 2.—On the Mastodons of Russia, and their relations to the Mastodons of other regions, by Mme. Marie Pavlova, being a summing up of her larger work, now ready for print. Its conclusions are: (1) It is the group *Mastodon Zygodon*, represented by *M. Borsoni*, *M. ohioensis*, and their varieties, which had a very great spreading in south-west Russia during the Miocene and the Pliocene periods. (2) None of these forms is specific to Russia, all having been widely spread in West Europe and North America. (3) The group of *M. Buxitoides* is only known till now through a very limited number of specimens of *M. arvensis*, while this group is widely represented in West Europe, Asia, and America. (4) The close resemblance between the Mastodons of Eurasia and America confirms once more the connection which existed between the two continents during the Tertiary period.—The Post-pliocene mammals of East Russia, by Prof. S. Sackenbergh (in French). They are: *Rhinoceros tchobitinus*, Fischer, and *Al. Merckii*, Jaeger; *Elasmotherium Fischeri*, De-marest, which has never been found in Perm, Ufa, Vyatka, Kazan, Nizhni Novgorod, and Simbirsk, but only further south, i.e. in Samara, Perza, and Saratoff; *Equus calalus*, very common—the fossil horses having already been made the subject of special studies by Mme.

Pavlova; *Cervus taranius*, *C. elaphus*, *C. aces* (*Alces palata*), and *C. megaceus* (*Megaceros sibiranicus*) Owen; *Antelope saiga*, Pallas; *Bos priacus*, and *Bos primigenius*, the latter very rare; *Oryx montanus*, Blainville (*O. fossilis*, Kuhn-eyer); *Sus*, sp.; *Elaphus primigenius*, very common—some molars offering great divergences from the usual type—and another yet undetermined species of *Elaphus*, of which one molar is kept in the museum of Kazan; though like as a whole to a mammoth tooth, it has well defined peculiarities of structure; *Castor fiber*; *Ursus arctos*; and an undetermined species of *Canis*. All these remains have rarely been found *in situ*, but chiefly in remodelled river deposits.—The second part and conclusions of the work of B. L. Wolf, on the embryology of mammals. The current theory of gastrulation is shown not to be supported by direct observation, and a new theory is proposed.—On the use of Bouguer's formula in the study of gravitation anomalies, by Prof. Th. Sloudsky (in French).—On some land shells collected by M. Koshlafowitsch on the Vorobievsky Hill, near Moscow, by Dr. Zickendath. They belong to species now quite common in Middle Europe (*Hyalina*, *Urtia*, *Cinnella*, *Pupa*, *Succinea*, &c.), and originate from the period when the Vorobievsky plateau was covered with thick marshy forests; they can by no means be considered as belonging to any ice period.—Entomological and botanical notes from Sarpta, by Alex. Becker (in German).

## SOCIETIES AND ACADEMIES.

LONDON.

Geological Society, January 9.—Dr. Henry Woodward, F.R.S., President, in the chair.—The formation of oolite, by E. B. Wethered. In previous communications the author has described pisolites formed by the growth of *Girvanella*, and some true oolitic granules having a like origin. He had previously expressed the opinion that all oolitic granules are of organic origin, and the facts described in the present paper give support to this view. He described the form of the granules, which frequently exhibit a series of concentric layers of calcium carbonate around a nucleus, and also dark striae and patches, the former placed more or less at right angles to the nucleus. The concentric layers often exhibit an irregularity which the author maintained to be incompatible with their chemical origin. Again, granules are found made of calcium carbonate occurring in two forms—a clear crystalline portion representing the organic structural part, and an amorphous portion consisting of ordinary carbonate of lime, which is either infilling or secreted material, possibly both. In discussing the origin of the crusts around the nuclei the author treated of the radial structure which is so marked a feature in the crust of oolitic granules. This structure has the appearance of light and dark striae when seen by reflected light: the light are tubules which have grown at right angles to the nucleus, while the dark are secondary formations. He referred to Rothpletz's description of the oolitic granules of the great Salt Lake, which are stated to have originated from the growth of lime-secreting algae, and thinks it possible that the fossil forms are of like origin, though not necessarily due to organisms allied to algae, and possibly even lower in the scale of life. In his opinion *Girvanella*—the first type of oolite-forming organism discovered—is simply a tubule. A long discussion followed the reading of the paper. The President thought that the author had placed evidence before the meeting sufficient to prove the organic origin of many of his oolitic granules. Mr. G. F. Harris believed that while most geologists would possibly agree as to the organic nature of the tubules in the pisolites referred to, they would not be unanimous in recognising the tubular structure in many of the oolitic granules shown. Many of the features presented by oolitic granules, and brought forward by the author as evidence of the organic origin of oolite, could be explained by the alteration effected in them since their original formation. Mr. F. T. Newton agreed with the author that the irregular tubules termed *Girvanella*, and seen sometimes within and sometimes on the outside of oolitic granules, were of organic origin, but he thought that the characteristic concentric and radiated structure of oolitic granules was entirely different, and not due to concentric tubules. Dr. G. J. Hinde did not think that the author was right in his interpretation of the concentric layers so common in ordinary oolitic grains as tubular forms of growth. In his (the speaker's) opinion these concentric lines might indicate

layers of glauconite, they were not in any sense tubules. Mr. A. C. Seyley expressed himself in agreement with the main contention in reference to the occurrence of organic tubular structures in the oolite grains described by the author; but the explanation offered by the author with regard to the radiating structure seen in certain grains he regarded as unsatisfactory, their general appearance being much more suggestive of secondary changes in the oolitic grains, which had no direct connection with the *Girardinella* tubes. Prof. Judd said that as far back as 1852 the eminent botanist Dr. Ferdinand Cohn had pointed out the important part played by algae in the formation of the Sprudelstein of Carlsbad and other calcareous rocks. At a later date Berner, the eminent French algologist, had insisted no less strongly on the work done in perforation and breaking-up of calcareous fragments by other plants. The speaker was inclined to regard some of the structures especially certain of the radial ones, as due to the action of destructive rather than to constructive organisms. Mr. H. B. Woodward referred to the modern formation of oolite-grains in waters charged with bicarbonate of lime, whether in proximity to calcareous springs or coral reefs. He thought that the slides exhibited by the author did not show connection between the *Girardinella* and the concentric and radiate bands of oolite-grains. Prof. Seeley believed that some of the photographs exhibited a structure which, although imperfectly preserved, might be compared with the sections of molluscs which the speaker brought before the British Association at Bath in 1888, as evidence that some grains of oolite are of organic origin. Mr. Kirtley said that, with regard to the nuclear portions of some of the sections projected upon the screen, he considered that the author was probably correct in ascribing an organic origin to the interlacing tubular structures; but, so far as the peripheral portion of the oolitic bodies was concerned, he believed that it presented no appreciable difference from that of ordinary calcareous concretions of a purely inorganic origin; similar radiating and concentric structures being also met with in the shales frequently present in eruptive rocks. Prof. A. H. Green also spoke; and the author replied.—On the Lias Ironstone around Banbury, by Edwin J. Walford. The ferruginous limestone of the Middle Lias of the Banbury district occurs practically within a ten-mile circle around Banbury. The zone (the Marlstone of the Geological Survey) is an "oolitic" typical limestone with much molluscan and crinoidal debris and some quartz grains. The author described the lithological characters of the rock, and their variations, as traced laterally and vertically, giving a full description of its local development, with a detailed account of the sections in the principal exposures.—Notes on the geology and mineral resources of Anaplo (Asia Minor), by W. F. Wilkinson. The route traversed from northwards to southwards through the city of Trebizond, through a country composed of sedimentary rocks (large limestones with some shales and conglomerates). In the mountains met morphic rocks were met with, and also granite rocks. The principal igneous rocks noticed are quartz and serpentines; in the latter chrome iron-ore occurs, and is worked.

Physical Society, January 25.—Mr. Medley concluded the evening's paper. Prof. Ayrton and himself, on tests of glow-lamps, which was commenced at a former meeting. With the power and apparatus employed in the tests, it was found that candle-power, current, and temperature per watt, all rose as the lives of the lamps increased. The author, being surprised at this result, took care to vary them, so that the effect observed was due rather to change in the resistance of their manganin potentiometer than to that of any kind of contact at the sockets of the lamps. Satisfyingly, when new lamps, they found that in all cases the light given out was greater after the lamps had been glowing for some time than when they were new. In the experiments with a glow-lamp glowing in candle power had a few minutes passed before the lamp had been burning for some time. Further, when the lives of the earlier lamps were away more than twenty or thirty hours, and of a few hundred hours, and so became comparative with those before the filament broke, the Edison-Swan lamps now examined showed a very marked saving, even when the filaments lasted over 100 hours. The rise in candle power was always accompanied by a rise in current, which, however, proportionally much smaller, so that the consumption of power per candle was actually less after the lamps had been burning 100 hours than it was at the beginning. Among the observations drawn by the

authors were the following: (a) When a group of Edison-Swan lamps, marked 100 S, are run at 100 volts, and each lamp as its filament breaks is replaced by a new one, it may be expected that the light given out will never subsequently be as small as when all the lamps were new; (b) an Edison-Swan lamp, marked 100 S, when run at 100 volts will give an average illumination of about 10 candles, and will absorb on an average power of about 4.3 watts per candle, so that such a lamp must be regarded as a 43-watt lamp, and not a 30-watt lamp, as is frequently stated; (c) the maximum rise of light recorded during the life of any lamp was 45 per cent.; (d) with lamps of the type examined, there is no point at which it becomes economical to discard a lamp before its filament actually breaks; (e) no marked economy can be gained by overrunning such lamps (i.e. by using pressures exceeding 100 volts). Prof. Ayrton mentioned that the improvement in glow-lamps after running for some time had been attributed to an improvement in the vacuum. Experiments made on new and used lamps by means of an induction coil showed that the more a lamp was used the better the vacuum became, but he (Prof. Ayrton), though at first inclined to adopt this explanation, had since found that though in all the lamps examined the progressive improvement of the vacuum was equally marked, the increase in candle-power varied between very wide limits, being very considerable in some lamps, and hardly perceptible in others. Prof. Rucker asked if it made any difference to the life of a lamp whether it were kept running continuously until the fibre broke, or were run for periods of a few hours, alternating with intervals of rest. The latter case would more nearly correspond with the conditions obtaining in practice. Prof. Ayrton replied that the lamps were kept running during the night, and were disconnected during the day.—A paper, by Prof. Anderson and Mr. J. A. McClelland, on the temperature of maximum density of water and its coefficient of expansion in the neighbourhood of this temperature, was read by the secretary, Mr. Elder. The dilatometer method was used, but the bulb of the instrument contained a quantity of mercury, determined by experiment, which for the range of temperature concerned was such as to secure the constancy of the remaining internal volume, occupied by water. The observed changes were thus the real, and not the apparent changes. The bulb was furnished with a graduated tube of small bore, bent twice at right angles, which served at the same time the purpose of a ground-glass stopper. (The joint was made water-tight by a little Canada balsam.) To determine the coefficient of expansion of the glass, the bulb and tube were filled with mercury at 0° C., and heated up to about 67° C., the necessary weighings being afterwards performed. The coefficient of expansion of mercury being known, the number of grams of mercury to be kept in the bulb during the experiments on water was calculated. The dilatometer was next filled with (thoroughly boiled) distilled water at about 5° C., the stopper-end of the graduated tube inserted, and the free end dipped under mercury, giving at 4° C. a column of mercury whose changes of level could be observed. A thermometer was placed with its bulb close to the middle part of that of the dilatometer; both being immersed in a water-bath which could be cooled by the addition of ice-cold water, or heated by radiation from surrounding objects. The thermometer used was graduated to tenths of a degree, and was compared with two similarly graduated ones by different makers. The two latter agreed very closely with one another, and one had a Kew certificate showing no error in the readings. Temperatures were written to the fourth decimal place, but accuracy to this extent was not claimed. Three sets of experiments were made, and for each a corresponding curve was drawn. In the first, the water was at atmospheric pressure; in the other two, at 1½ and 2 atmospheres respectively. Corresponding to these three pressures, the temperatures of maximum density found were 4° 18.44 C., 4° 18.23 C., and 4° 17.56 C. The value 4° 18.44 C., corresponding to atmospheric pressure, is greater than that generally received. Mr. Rhodes thought that sufficient precaution had not been taken to accurately calibrate the thermometers. He doubted whether temperatures read in the manner described could be relied upon to much less than 0.1. He did not see that any real advantage was gained by having mercury inside the dilatometer to compensate for the expansion of the glass. Mr. W. Watson thought that the mercury within the vessel would cause further uncertainty by tending to produce distortion of the glass. He pointed out

that in the case of water at maximum density, there would be practically no convection currents, so that equalisation of temperature would be very slow. As the bulb used was about 8 cm. in diameter, and all the experiments were made with the temperature rising, he thought that this would account for the high value obtained for the temperature of maximum density. Dr. Burton thought a distinct advantage was gained by compensating for the expansion of the glass. The values obtained in different experiments did not seem to be highly concordant. Prof. Kuecker thought that the criticisms which had been passed were, for the most part, just. For such measurements as these recorded, it was not sufficient to know the corrections of the thermometer readings at a few isolated points; the portion of the stem over which the readings were taken must be carefully and minutely calibrated. The Kew certificate not only ignored errors of less than  $0.5^\circ$  (as mentioned by the author), but it only gave corrections for a small number of temperatures, separated by considerable intervals.

**Linnean Society, January 17.**—Mr. C. B. Clarke, F.R.S., President, in the chair.—Mr. George Murray exhibited lantern slides representing a new part of *Pachytheca*, consisting of a cup-shaped receptacle in which *Pachytheca* was found by Mr. John Storr, of Cardiff. The walls of the cup are composed of radiating chambers like those of *Actinobolus*, and in the centre there are traces of an axile structure. Mr. Murray considered that this discovery only made the interpretation of the nature of *Pachytheca* more difficult than ever.—Mr. Arthur Lister exhibited and made remarks upon a Landrail (*Crex pratensis*) which had been found, a few days previously, near Axminster, in Devonshire, where it had been killed by coming in contact with telegraph wires. The occurrence in midwinter of a bird which is a summer visitor to this country, seemed to him to be worth notice.—Mr. J. E. Harting exhibited specimens of northern sea-birds which had been driven upon the east coast of England during recent gales; amongst others, the Little Auk (*Mergulus alba*), of which great numbers had come ashore dead, or in an exhausted condition; the Little Gull (*Larus minutus*), obtained at Whitstable on January 5; and an example of Brünnich's Guillemot, *Uria brunnicchii*, Sabine (*Trans. Linn. Soc.*, xii, p. 538), a species which, though abundant in Greenland, North-East Iceland, and Spitzbergen, is of such extremely rare occurrence on our coasts, that not more than two or three authenticated instances of its appearance here have been recorded. The specimen exhibited had been forwarded by Mr. W. J. Clarke, of Scarborough, near which sea-port it was shot on December 7, 1894.—A paper was then read by Mr. I. H. Barkill, on variations in the number of stamens and carpels. Of *Stellaria media* about 5700 flowers were examined, showing that towards the end of the life of the plant the number of stamens becomes reduced. *Ranunculus Ficaria* (nearly 800 flowers) showed that towards the end of the flowering period both stamens and carpels become reduced in number without their proportion being changed. Smaller numbers were examined of *Caltha palustris*, *Ranunculus arvensis*, *R. bulbosus*, *Thalictrum flaxum*, *Bocconia cordata*, *Prunus Padus*, *Prunus Lauro-cerasus*, *Crataegus Oxyantha*, *Rosa canina*, *Quercus Ilex*, and *Sagittaria montevidensis*, all of which showed, either in carpels or in stamens, a reduction in number towards the end of the flowering period. Of other influences besides age which affect the number of parts, temperature might be one, but nothing could be safely assumed.—Of a kindred nature was a paper by Mr. A. G. Tansley and Miss E. Dale, on variation in the floral symmetry of *Potentilla Tormentilla*, Necker. This paper, of which Mr. Tansley gave an abstract, was mainly a record of variations tending to alter the normal tetramerous actinomorphic symmetry of this flower. From his observations it appeared that independent variations of the epicalyx is considerable, but is probably mainly due to a tendency of its segments to revert to a primitively double condition. The residual independent variation is small, and roughly equal to that of the calyx and corolla. The number of stamens is more variable, and the carpels extremely so. Correlated variation of all the whorls is frequent, and produces deviating types of symmetry in about 3 per cent. of the flowers examined. The series of groups into which the various deviating types might be said to fall, illustrated the shifting of the centre of variation from the pentamerous type of allied flowers to the tetramerous type of *P. Tormentilla*.—A discussion followed, in which the President, Mr. H. N. Ridley, and others took part, and Mr. Tansley replied to the criticism offered.

**Chemical Society, January 17.**—Dr. Armstrong, President, in the chair.—The following papers were read: Octacetylmaltose, by A. R. Ling and J. L. Baker. Herzfeld's description of octacetylmaltose is in many respects erroneous.—Action of diastase on starch, by A. R. Ling and J. L. Baker. The isomaltose obtained by Lintner by the action of diastase on starch is not a pure substance. From the product of hydrolysis of starch paste by diastase, a triosazone was isolated; one of the products of the action is therefore probably a triose  $C_3H_5O_3$ .—New derivatives from  $\alpha$ -dibromocamphor, by M. O. Forster. Fuming nitric acid dissolves  $\alpha$ -dibromocamphor with formation of a neutral substance  $C_{10}H_{12}Br_2O_2$ ; this on alkaline reduction yields a monobromo-derivative  $C_{10}H_{11}BrO$ . The latter substance is converted into a nitro-derivative  $C_{10}H_{11}BrNO_2$  by nitric acid.—Acid sulphate of hydroxylamine, by L. Divers. Crystalline hydroxylamine hydrogen sulphate is prepared by acting on hydroxylamine hydrochloride with the calculated quantity of sulphuric acid.—The hypophosphites of mercury and bismuth, by S. Hada. Hypophosphites of the composition  $HgH_2PO_2$ ,  $Hg_2NO_2$ ,  $HgO$  and  $Bi(H_2PO_2)_3$ ,  $H_2O$  have been prepared.—Kamala, part ii, by A. G. Ferkin. The three acids previously obtained by the oxidation of rotterline are now shown to be ortho- and para-nitrocinnamic acids and paratitrobenzoic acid. From the composition of its metallic derivatives rotterline would seem to have the composition  $C_{20}H_{20}O_7 \cdot COOH$ ; it yields a crystalline substance, rotterlone  $C_{20}H_{20}O_7$ , when boiled with sodium carbonate.—The action of aqueous potassium cyanide on gold and silver in presence of oxygen, by J. S. MacLaurin. The solution of gold or silver by potassium cyanide solution is dependent on the presence of oxygen, and the rate of solution is proportional to the quantity of oxygen present, and to the coefficient of viscosity of the solution.—The crystalline forms of the two dimerhyppimelic acids, by W. J. Pope.—Oxidising action of ammonia solution on some metals, by W. R. Hodgkinson and N. E. Bellairs.—Action of magnesium on some phenylhydrazine compounds, by W. R. Hodgkinson and A. H. Cole. Complicated mixtures of products are obtained on boiling acetyl- or benzoyl-phenylhydrazine with magnesium filings.—Refraction equivalents of the elements and the periodic law, by R. M. Deeley.

## PARIS.

**Academy of Sciences, January 28.**—M. Marey in the chair.—Preparation and properties of boride of iron, by M. Henri Moissan. A boride of iron of the composition  $FeB$  is obtained by heating together iron and boron, best in the electric furnace. It forms brilliant grey crystals which remain unaltered in air or dry oxygen. Its density is 7.15 at  $18^\circ C$ . Its chemical behaviour with ordinary reagents is fully described.—On Fourier's problem, by M. E. Le Roy.—On the exact levelling of stations recently carried out in Russia, by General Venukoff. In a total of 1090 stations scattered throughout Russia, no altitude was determined greater than 338 metres. The most important result of the survey was the establishment of the identity of level of the Baltic, Black, and Azov Seas.—On the solution of solids in vapours, by M. P. Villard.—Action of an electric current on a number of metallic sulphides in the fused state, by M. Jules Garnier. Sulphur is gradually eliminated from the fused mass out of contact with air, the copper retaining a greater proportion of sulphur than iron and nickel in an ore containing the three sulphides.—On some properties of bismuth sulphide, by M. A. Ditté. The production and properties of crystalline bismuth sulphide, made in the wet way, are described. A remarkable double compound with potassium sulphide,  $Bi_2S_3 \cdot 4K_2S \cdot 4H_2O$  is obtained in very sharp and brilliant reddish-yellow, transparent rhombohedra from a solution of  $Bi_2S_3$  in potassium sulphide. The crystals cannot be kept in a moist atmosphere, as water readily blackens them.—Influence of the surrounding medium on the transformation of amorphous zinc sulphide, by M. A. Villard.—On carbonyl chlorobromide and dibromide, by M. A. Besson. The author obtains the substances  $COClBr$  and  $COBr_2$  by the interaction of  $COCl_2$  and  $BBr_3$ . They are both partially decomposed by distillation in air. They are very dilatible by heat, and possess very irritating vapours. In contact with mercury at  $100^\circ$  in sealed tubes they suffer total decomposition, but are only slowly acted on by cold water.—Methyl ether and ammonium derivatives of hexamethyl-1-amido-triphenylmethane, by M. A. Roesebleb.—On acetic esters from sugars, by M. C. Tarré. The author shows the various reactions given with different classes of sugars by acetic acid in presence of fused sodium acetate and of zinc chloride respectively. He describes three



THURSDAY, FEBRUARY 14, 1895.

ELECTRIC OSCILLATIONS.

*Les Oscillations Électriques.* Par H. Poincaré, Membre de l'Institut, Rédigées par M. Ch. Maurain. (Paris: Georges Carré, 1894.)

WE have already noticed at some length M. Poincaré's works on *Électricité et Optique*, and given an account of his views regarding Maxwell's theories, and his mode of presenting the subject in the light of Hertz's researches. The present work discusses more particularly the subject of Electric Oscillations, and includes comparatively little of the more abstract treatment of electrical theory to be found in the others. We have in it a very instructive and well-timed *résumé* of a good deal of the later work on the subject, with mathematical investigations of many points arising in connection with the various experimental researches referred to, which are of great value.

In a short preliminary statement of the theory underlying the Hertzian experiments, M. Poincaré adopts, to a certain extent, the mode of presentation used by Hertz himself. The two reciprocal sets of equations also made by Heaviside the starting-point of his researches, and called by him the circuital equations, are made by Hertz the basis of everything. Thus if  $L, M, N, X, Y, Z$  be the components of the magnetic and electric forces,  $\mu$  and  $\epsilon$  the "coefficients of magnetic and electric induction," and  $A$  the reciprocal of the velocity of light, the equations are

$$A\mu \left( \frac{\partial L}{\partial t} - \frac{\partial M}{\partial t} + \frac{\partial N}{\partial t} \right) = \left( \frac{\partial Z}{\partial y} - \frac{\partial Y}{\partial z} + \frac{\partial X}{\partial z} - \frac{\partial Z}{\partial x} + \frac{\partial Y}{\partial x} - \frac{\partial X}{\partial y} \right)$$

$$A \left( \epsilon \frac{\partial X}{\partial t} + 4\pi u, \text{ \&c.} \right) = \left( \frac{\partial M}{\partial z} - \frac{\partial N}{\partial y}, \text{ \&c.} \right)$$

where  $u, v, w$  are the components of conduction current at  $x, y, z$ . When  $u, v, w=0$ , one set of equations can thus be formed from the other set by interchange of  $L, M, N$  with  $X, Y, Z$ , and  $\mu$  with  $\epsilon$ . The electric energy is  $\epsilon(X^2+Y^2+Z^2) 8\pi$ , and the magnetic energy  $\mu(L^2+M^2+N^2) 8\pi$ , each taken per unit of volume of the medium.

The units of force are so chosen that  $\mu$  and  $\epsilon$  are both unity for vacuum, that is, for ether. Hence the introduction of  $A$  in the equations above. It is required to make the dimensions of both sides alike. We must confess that we much prefer the idea contained, though not clearly expressed, in Maxwell's treatise, of regarding  $\mu$  and  $K$  as quantities dependent on the physical properties of the medium, and such that the velocity of light in the medium is  $v = \sqrt{\mu K}$ . There can be no question of the enormous advantage of thus proceeding. It avoids the obvious absurdity of giving in a general system of measurement founded on the units of length, mass, and time, two different sets of dimensions to the same quantity according as it is measured electrostatically or electromagnetically. Further, if this were recognised, the serious difficulty which besets students, when they find that what is defined or explained as a mere ratio is unity, or the reciprocal of the square of the velocity of light, according to the system of units adopted, would entirely disappear. The discussion which took

place in 1882 regarding the dimensions of magnetic pole in electrostatic units, gave illustrations of the confusion and misconception to which neglect of the dimensional relation between  $\mu$  and  $K$  can give rise in the mind of even a master of physical science.

Let  $\mu_0, K_0$ , or better,  $\mu_0, \kappa_0$ , be the inductive capacities (magnetic and electric of ether,  $\mu, \kappa$ , those of any other substance, then  $\mu, \kappa, \mu_0, \kappa_0$ , will be the magnetic and electric permeabilities of the medium, and will be mere ratios. The magnetic permeability will then be as Lord Kelvin originally defined it, the ratio of two magnetic forces, of the magnetic force defined electromagnetically (in a crevasse across the direction of magnetisation) to the magnetic force according to the polar definition (in a narrow cylindrical hollow parallel to the magnetisation), and our ideas will no longer be liable to obfuscation in an important fundamental matter.

M. Poincaré derives the second set of equations stated above from the first set and the principle of conservation of energy, using for the total energy per unit of volume the sum of the expressions quoted above. The theoretical basis consists thus of (1) the experimental fact that the line-integral of electric force round a circuit is equal to the time-rate of variation of the total magnetic induction through the circuit, which gives the first set of equations; (2) the expressions for the magnetic and electric energies; and (3) the theorem that the work spent in heat per unit of volume per unit of time is  $Xu+Yv+Zw$ . The expressions for the energies are thus taken as fundamental. The result does not, however, depend on any supposition as to exact localisation of the energy; all that is involved is the expression of the energy as an integral extended through the whole field.

This is not the same as the process of Hertz, and it is not clear that it possesses any advantage over that method. In fact, Hertz's foundation is the two sets of reciprocal equations, which are first postulated, then shown to be consistent with observed phenomena. Thus the whole structure rests on the equations, and Hertz is but little, if at all, concerned with the dynamical explanation of electromagnetic phenomena. This, on the other hand, Maxwell is continually; and one of the most remarkable chapters of his book is that in which he applies the method of Lagrange to give a dynamical basis to the theory of induction and electromagnetic action. This was a natural outcome of the other process, which he followed, of establishing his equations as far as possible directly from the experimental facts, and connecting them by a strong web of dynamical theory. It does not seem likely, moreover, that the minds of many of those who are eagerly seeking for some more intimate knowledge of electromagnetic action will be content with anything but a dynamical explanation of electrical phenomena, and one which shall elucidate, in some measure at least, the relation of the ether to ordinary matter, and the reason for the existence of the ponderomotive forces exerted in the electromagnetic field.

In chapter iii. M. Poincaré proceeds to the theoretical study of Hertzian oscillations, and discusses in the first instance the solution of the differential equations for the case of conductors situated in a dielectric. The first part of this does not call for special remark.  $X$  is taken

in the ordinary way as the real part of  $B = i C_p e^{i t}$ , where  $i = \sqrt{-1}$ , and  $\phi = q - i \gamma$ . The value of  $\phi$  is here misprinted  $\gamma - i \gamma$ . The author then proceeds to find solutions for the case of an indefinitely extended dielectric, and throwing the equations into the form

$$L, M, N \frac{\partial \xi}{\partial x} - \frac{\partial \eta}{\partial z}, \&c.$$

that is introducing the vector-potential, he goes on to solve the resulting equations for  $X, Y, Z$ . Two solutions are obtained of the form

$$\xi = A \int \frac{u}{r} dx dy dz$$

where  $u$  may have either of the values  $u, u'$ , given by  $u = f(x, y, z, t), u' = f(x, y, z, t - Av)$ . Here  $u$  is the value of the component of the current at the point  $(x, y, z)$  at time  $t, u'$  the value of the same component at the same point at a time previous by the interval required for the light to travel from  $(x, y, z)$  to  $(x', y', z')$ ,  $r$  being the distance between these two points. The latter solution is, of course, adapted to the case of propagation in space with velocity  $1/A$ . It is exemplified by application to the complete solution of Lodge's spherical vibrator. Thus, in the assumed absence of radiation of energy and frictional damping out of the electrical vibration, may be regarded, for points external to the sphere, as simply a time-periodic electric doublet; for its electrification may be imagined produced by the relative displacement through a small distance of two uniform spherical volume distributions, each of which acts as if its whole charge were situated at its centre. But the existence of radiation very materially affects the result, for if  $r$  be the distance of any point from the centre of the vibrator,  $a$  the radius of the sphere,  $\psi$  a function which gives the electric forces by the equations

$$\frac{X}{Z} = \frac{\partial \psi}{\partial x} \frac{\partial_1 \partial}{\partial_1 \partial}, \frac{Y}{Z} = \frac{\partial^2 \psi}{\partial x_1 \partial_1 \partial z_1},$$

the direction of the axis of the vibrator being that of the  $z$ .

$$Z = \frac{1}{4\pi C} \left[ \frac{1}{r} \cos \sum_1 \left( r - \frac{t}{A} \right) + \frac{1}{r} \cos \sum_2 \left( r - \frac{t}{A} \right) + \frac{1}{r} \cos \sum_3 \left( r - \frac{t}{A} \right) + \frac{1}{r} \cos \sum_4 \left( r - \frac{t}{A} \right) \right]$$

The result is very interesting as showing exactly the frequency of the vibration in this case; that due to frictional damping is not a simple one. As  $1/A$  is the velocity of the radiation, it is clear that the radiation damping becomes important as  $1/A$  increases. It illustrates the difficulty of obtaining exact solutions; and has an important bearing on the interpretation of results obtained with resonators, which are not so exactly as compared with the vibrator.

Of course, the same method of treated cases can be found where the vibrator is not a sphere, a spherical vibrator of large radius, or a vibrator of small radius, can be computed by the same method. It is possible to obtain a more exact solution of the vibrations distant from the vibrator than that of the vibrator, by the use of no approximation, but this is not a simple matter; the exponential factor, and we are not able to give an approximate solution.

The result obtained by Hertz is similar to the period of the damping out of the vibration of the vibrator were

tested, of course, by his resonator; and we have, in chapter iv. of M. Poincaré's work, an excellent account of the mathematics of resonance, so far as here required, and of the propagation of electric waves along wires, illustrated by reference to the experiments of Sarasin and De la Rive, Blondlot, and others. Many of these have reference to the variation of the current with distance from the end of the wire, at which, of course, reflections took place. The theory, for example, of Mr. D. E. Jones' experiments, in which a thermo-electric couple was used to measure the heating effect at different distances from the end of a long wire, is worked out; and the results, when compared with those of the experiments, are found to agree.

Chapters follow on Propagation in Air, and Applications of Theory. In the latter, M. Poincaré refers, among other things, to the results of the very important experiments of Bjeiknes, on waves received by resonators of different metals; that is, their different rates of damping, and the depths to which the currents penetrate into the metal as measured by the thickness (to take an example) of copper, which must be deposited on an iron resonator in order that it may behave like one of solid copper.

These three chapters have a very important bearing on the question of multiple resonance, to which M. Poincaré has himself devoted special attention, and form, perhaps, the most valuable part of the work.

Lastly, the book deals with such applications of electrical oscillations as the determination of specific inductive capacities, the reflection and refraction of electric waves, and ends with a study of Hertz's "Memoir on the Fundamental Equations of Electrodynamics for Moving Bodies."

The mathematical discussions are, as we have indicated, throughout lucid and very frequently elegant. The facility with which an apparently intractable problem is taken hold of, and a few more or less elementary considerations made to yield an approximate solution or result, is very remarkable. We could have wished for a somewhat more physical treatment of the subject; but to those whose physical ideas have had some training with regard to these matters, M. Poincaré's treatise cannot but be of great service, as supplying what no doubt was its object, a review of the principal results obtained in this field of research compared with theory, as far as possible by the only sure test, that of calculation.

A. GRAY.

THE BOOK OF THE ROSE.

*The Book of the Rose.* By the Rev. A. Foster-Melliar, M.A., Rector of Sproughton, Suffolk. Pp. 335. 29 Illustrations. London: Macmillan and Co., 1894.

MR. MELLAR is well known among horticulturists as a successful grower and exhibitor of roses, and his book is what he wished it to be—the rose considered as a flower, with full details for its practical culture for amateurs, from the beginning to the end. Art is his text all through. He has very little to say about the botany of the rose, its geographical distribution, the origin of the numerous races of garden roses as distinguished from their wild progenitors, the fourteen chapters of his book



being devoted to such matters as soil, manure, planting, pruning, propagating, and exhibiting. For the cultivator the book covers all the ground, and Mr. Melliar's instructions are as clear, as thorough, and as trustworthy as any budding "Rosarian" could desire. There are already plenty of books about the rose, of which as much as this can be said, but there is still room for Mr. Melliar's. He writes mainly for the amateur grower of roses, and strongly recommends his hobby to the country parsons who are, he says, "all so poor, and likely to be poorer still." The delights of the rose-grower are only experienced when he himself does all the work entailed in the production of plants from cuttings, buds or seeds, to the exhibition flowers. The genuineness of Mr. Melliar's love for his hobby is seen in the following extract from his book:—

"But if it was you alone who had found, chosen, and grubbed out the [briar] stock from the hedge, or cut, prepared, planted, and transplanted the briar or manetti cutting—if no hand but yours had budded it, cared for it in all stages, and finally cut and shown the Rose—then, when perchance it is declared on all hands to be the finest specimen of the variety ever shown, it must be an additional pleasure to know that it is your Rose indeed, for that, as far as all human aid is concerned, you made it yourself."

If the book has a fault, it is to be found in this treating of the rose solely as a flower to be set on a tray at an exhibition and win a prize. Mr. Melliar has something of the narrowness of view of the old florist, for he sees little beauty in roses which are not likely to win prizes. He devotes thirty pages to instructions on exhibiting the flowers. This chapter is interesting as showing how much care and self-sacrifice are necessary to success in the exhibition tent, the paper covers to protect the buds from rain, wind, and sun, and the precautions necessary even when the flowers are ready to pack in their prepared mossy beds in boxes. In one very dry season, he says, his mossed boxes had been kept in the shade and duly watered, with the result that two huge slugs, each as big as his thumb, concealed themselves in the moss, and during the journey to the Crystal Palace regaled themselves on the roses!

Mr. Melliar speaks of several varieties of rose that show deterioration since they were first introduced, or "sent out," as the raisers express it. These fine varieties of rose are always propagated from grafts or cuttings, and deterioration is therefore unlikely. The same statement has been made with regard to apples, pears, and other fruits, which are multiplied in the same way as roses, but they have never been substantiated.

Until within the last thirty years or so, all the best garden roses were raised by continental growers, the belief being that they could not be produced in England. The same belief prevailed until recently with regard to chrysanthemums. It is therefore a pleasant surprise to see that of the 144 varieties of the Hybrid Perpetual section of roses, selected by Mr. Melliar as the choicest and best, no less than sixty of them were raised in England, and that the two best H.P. roses known, viz. "Her Majesty" and "Mrs. J. Laing," were raised by the late Mr. Bennett in Surrey. To these I would add a third, namely, "Grace Darling," also raised by Mr. Bennett, and

which, although not an exhibition rose, is yet one of the most beautiful of all in the garden. Its only rival is "Gloire de Dijon," raised in France forty years ago, and of which Dean Hole, prince of rosarians said, "Were I condemned to have but one rose for the rest of my life, I should ask, before leaving the dock, to be presented with a strong plant of 'Gloire de Dijon.'"

A book which deals chiefly with exhibition roses can scarcely be considered to justify its title, "The Book of the Rose," because to all but a very small section of gardeners the rose appeals with greatest force when seen as a naturally grown bush in the garden. The close pruning and other rigorous methods of the grower-exhibitor are suggestive of ear-cropping for dogs, and comb-cutting for cocks, disfiguring, for a special purpose, otherwise beautiful objects. Mr. Melliar has very little to say for the many beautiful single-flowered roses which are now coming rapidly into favour with gardeners, and whose flowers are often as lovely as the highest floral art could wish. Many of the perfect exhibition roses are just about as attractive in form and colour as a red-cabbage. The hybrids raised by Lord Penzance from the sweetbriar crossed with garden roses, are exceedingly beautiful, so too are the forms of the Japanese *Rosa rugosa*, *R. multiflora*, *R. bracteata*, *R. indica*, &c.

It is becoming a too common practice amongst professional gardeners to set about crossing beautiful species of plants, roses included, with a view to doubling or otherwise altering the form, or "improving" the colour of the flowers, to satisfy some absurd ideal, the consequence often being a considerable loss from the point of view of true art. We owe the garden roses of the present time to the breeders of florists' flowers, and are duly thankful. At the same time we would prefer to keep the best of the single-flowered roses just as they are. Mr. Melliar does not agree with those who look upon the rose as a decorative plant for the garden, but only as a means whereby he may obtain glorious roses. For me, the best tray of exhibition roses ever produced has infinitely less charm than a bed of yellow Banksian roses, or even a tangled mass of sweetbriar when covered with flowers. However, Mr. Melliar's book will teach any one how to grow good rose flowers, and there are thousands who would find pleasure in rose-growing by reading and following his directions.

W.

#### OUR BOOK SHELF.

*L'Industrie des Aranéina.* By Woldemar Wagner. (St. Pétersbourg: L'Académie Impériale des Sciences, 1894.)

THIS work may be divided into two sections: (1) the descriptions of the cocoons, nests, &c., of the commoner kinds of Russian spiders; and (2) the conclusions respecting the evolution of instincts and the classification of the species, to be drawn from the data thus established.

Wagner recognises four kinds of silken structures—namely, the snare, the retreat, the nest, and the cocoon. About the first of these but little is said. The remaining three, however, are discussed in considerable detail, and to the question as to whether these structures are of great taxonomic value, M. Wagner gives an unhesitating and most positive affirmative reply. It is unfortunately impossible within the limits of a short notice to criticise

most closely his arguments—but that they are worthy of the deepest attention, will be realised by all arachnologists who are conversant with M. Wagner's previous works.

It is the highest praise that can be bestowed upon this work, as to say that, even when stripped of its theories, it reaches the high standard of excellence attained by M. Wagner's previous papers, and that the real value of the theoretical part lies in the fact that

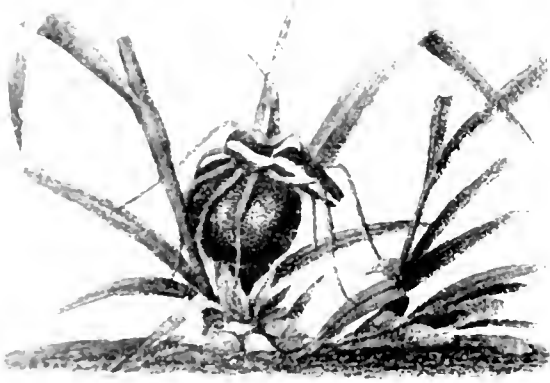

the key to all problems is sought in the hypothesis of evolution by means of Natural Selection.

The memoir is admirably illustrated with ten lithographed plates, of which eight are coloured, and, in addition, with two hundred and fifty-two diagrams in the text. The figure we here select for reproduction, to give an indication of the nature of the rest, represents the female of *Oxydemirbellis* carrying her cocoon.

R. L. F.

*Lectures on Practical Chemistry, Inorganic, and Organic.*

By J. T. Hewitt, M.A., D.Sc., Ph.D., F.C.S., and F. G. Pope. Pp. 42. London: Whittaker and Co.

WITHOUT the authors of this small book have confined themselves to such parts of elementary qualitative analysis as find a place in Stage I. of the Science and Art Department Syllabus, neither in general plan nor in details of treatment does the book possess any educational advantage over its many competitors. A mere recital of reactions cannot be considered as "Elementary Practical Chemistry." Surely it is possible to present even the array of facts utilised in analysis in such a manner as to comply with the fundamental requirements necessary to be fulfilled by all educational works designed for young students of science. The production of compilations of the present type will probably cease to exist when the new regulations for Organised Science shall come into force. We may then, perhaps, look for the production of really philosophical text-books arranged on sound educational lines, and yet calculated to minimise the very real difficulties encountered by the beginner. Putting aside these fundamental considerations, it is only just to say that the authors have brought together a strictly limited set of reactions with few positive inaccuracies.

*How to Live in Tropical Africa.* By I. Murray, M.D. Pp. 252. London: George Philip and Son, 1895.

SO FAR as literary merit is concerned, this is a poor book. The text is disjointed, it is too full of unnecessary propositions, and there is too much homology. But if only the subject matter is considered, the verdict is that the book is a trustworthy guide to tropical hygiene, and a useful manual on the cause, prevention, and cure of malarial fevers. The importance of such a handy volume to emigrants and visitors to Africa can hardly be over-estimated. And as the book is the outcome of medical experience, it possesses exceptional value.

[NO. 1320, VOL. 51.]

## LETTERS TO THE EDITOR.

[The Editor does not hold himself responsible for opinions expressed by his correspondents. Neither can he undertake to return, or to correspond with the writers of, rejected manuscripts intended for this or any other part of NATURE. No notice is taken of anonymous communication.]

### The Liquefaction of Gases.

PROF. OLSZEWSKI'S letter in NATURE of January 10 is a more serious matter than a *claim for priority*. The letter charges Prof. Dewar with allowing the impression to go abroad that he has carried out much original research into the methods of liquefying the more permanent gases, and the properties of the liquids produced; whereas, according to Prof. Olszewski, most of Prof. Dewar's experiments have been merely repetitions of work done by others.

In his brief communication to NATURE (January 10), Prof. Dewar has been too modest either to defend himself or to meet his opponent. Fortunately, he makes one definite statement:—"A reference to the *Proceedings* of the Royal Institution between the years 1878 and 1893 will be sufficient to remove the suggestion that the apparatus I use has been copied from the *Chimie Bulletin* of 1890."

I have followed Prof. Dewar's recommendation, and made references to the *Proceedings* of the Royal Institution. In his lecture at the Royal Institution on June 13, 1884 (*Proc. R. I.*, xi. 148), Prof. Dewar refers to Messrs. Olszewski and Wroblewski as having "recently made such a splendid success in the production and maintenance of low temperature." He describes and figures an apparatus which is a slightly modified form of that of the Polish professors, which in turn was derived from the apparatus of Cailletet; and he says: "Provided a supply of liquid ethylene can be had, there is no difficulty in repeating all the experiments of the Russian observers." No claim is made here to originality in the essentials of the apparatus, nor in the experiments performed. The apparatus referred to by Prof. Dewar in his lecture of June, 1884, was used by Prof. Olszewski in 1883, and was improved by him in 1884; in 1887 the apparatus was made capable of liquefying oxygen and other gases in considerable quantities at the ordinary atmospheric pressure (see Olszewski, *Phil. Mag.*, February 1895, 189-190). In 1890 the apparatus was so improved that from 50 to 100 c.c. of liquid oxygen could be produced by it (see Olszewski, *Phil. Mag.*, February 1895, 192-193). Prof. Olszewski states (NATURE, January 10) that a description of this improved apparatus was sent to Prof. Dewar. A year after this, on June 26, 1891, Prof. Dewar delivered a discourse on Faraday's work at the Royal Institution. The published abstract of this lecture (*Proc. R. I.*, xiv. 481) contains a photograph of the pumps and engines used in the laboratory of the Royal Institution, and a photograph of the arrangement of the apparatus on the lecture table; but it is impossible to make out the details of the apparatus from these photographs. So far as can be judged from the *Proceedings* of the Royal Institution, Prof. Dewar did not show large quantities of liquid oxygen, nitrogen, or air in his lectures until June 10, 1892, when he placed before his audience a pint of liquid oxygen. Two years before this Prof. Olszewski had obtained 100 c.c. of liquid oxygen, and he tells us in his letter to NATURE (January 10) that 200 c.c. of this liquid were prepared and exhibited by him in July 1891. A pint is undoubtedly more than 200 c.c., but unless one does something with the larger quantity which cannot be done equally well with the smaller, nothing is gained by conducting the manufacture on the large scale.

I can find no other mention of the apparatus used at the Royal Institution for liquefying large quantities of gases. There is indeed no accurate description in the *Proceedings* of that Institution of the apparatus used by Prof. Dewar. If Prof. Dewar has made marked improvements in any essential parts of Prof. Olszewski's apparatus, why has he not published an accurate description of these improvements in some recognised scientific journal?

A reference to the *Proceedings* of the Royal Institution is then sufficient, not to remove, but to strengthen, "the suggestion that the apparatus I [Prof. Dewar] use, has been copied from the *Chimie Bulletin* of 1890," or at least that it has been borrowed from descriptions of apparatus devised by Prof. Olszewski.

Every one must admire, and praise the skill which fashioned, the vacuum receivers for storing and experimenting with comparatively large quantities of liquid oxygen and air, which Prof. Dewar used in public for the first time on January 20, 1893, so far as can be gathered from the *Proceedings* of the Royal Institution (see *Proc. R. I.* xiv. 1.) The following sentences occur in the published abstract of Prof. Dewar's lecture on that date: "The prosecution of research at temperatures approaching the zero of absolute temperature is attended with difficulties and dangers of no ordinary kind. *Having no recorded experience to guide us in conducting such investigations*, the best instruments and methods of working have to be discovered." (The italics are mine.) (*Proc. R. I.* xiv. 1.) Now, in June 1890, that is two and a half years before Prof. Dewar made the statement I have quoted, Prof. Olszewski was able to say: "My new apparatus excludes the inconveniences of the former one, and renders it possible to preserve the liquid oxygen a longer time under the ordinary atmospheric pressure." And again: "Thus was solved the problem of liquefying considerable quantities of oxygen without the slightest danger." (See Olszewski, *Phil. Mag.* February 1895, 193-3.) Every reader of Prof. Olszewski's paper will agree that these statements are justified. Moreover, in October 1891, that is, fifteen months before Prof. Dewar declared there was "no recorded experience to guide us in conducting such investigations," Prof. Olszewski (in conjunction with M. Witkowski) described a method for not only storing, but also experimenting with, considerable quantities of liquid oxygen (*Cracow Bulletin*, October 1891). So far back as 1887 he published, in *Wiedemann's Annalen* (xxxi. 58), a full account of methods for determining the densities of liquid oxygen, nitrogen, and marsh gas. In 1887, also, he determined the boiling point of liquid ozone, and he began his measurements of the absorption spectra of liquid oxygen and air (*Wiedemann's Annalen*, xxxiii. 570); and in 1891 he published further measurements of the absorption spectrum, and the refractive index, of liquid oxygen (*ibid.* xlii. 663; see also *Phil. Mag.* February 1895, 197-9, and 206-8.)

It is just these properties, namely, the optical properties, of liquid oxygen which had been elaborately studied by Prof. Olszewski from 1887 to 1891 that are largely dwelt on by Prof. Dewar in his discourse of January 1893; and it is the illustration of these properties that is prefaced by the remark, there is "no recorded experience to guide us in conducting such investigations."

On January 20, 1893 (*Proc. R. I.* xiv. 10) Prof. Dewar said that liquid oxygen is "the most convenient substance to use for the production of temperatures about  $-200^{\circ}$  C. Liquid nitrogen, carbonic oxide, or air can conveniently be made at the ordinary atmospheric pressure, provided they are brought into a vessel cooled by liquid oxygen boiling under the pressure of about half an inch of mercury." It is interesting to compare with this Prof. Olszewski's words published in June 1890 (*Crac. Bull.*; I quote from the translation in *Phil. Mag.* February 1895, 192): "I proved long ago [*Compt. rend.* c. 350 (1885)] that liquid oxygen is the best cooling agent; for it easily gives the temperature of  $-211^{\circ}$  C. if the pressure is lowered 9 mm. of mercury, and it does not freeze even at the pressure of 4 mm." It may be said that the similarity between these statements is merely a coincidence. Perhaps it is. Nevertheless, Prof. Dewar's statement conveys the impression that he was the first experimenter to employ liquid oxygen for obtaining, and maintaining, very low temperatures. Another of Prof. Dewar's statements which imply more than they express, occurs in his lecture of June 10, 1892 (*Proc. R. I.*, xlii. 695): "He hoped that evening to go several steps further, and to show liquid air, and to render visible some of its more extraordinary properties." Remembering that air had been liquefied by Prof. Olszewski at least eight years before the lecture wherein this statement occurs was delivered, one must regret that Prof. Dewar did not choose words which should have made it impossible for the English public to suppose "that the liquefaction of oxygen and other so-called permanent gases was achieved for the first time by [him]." (See Prof. Olszewski's letter in *NATURE* of January 10).

Not only does Prof. Olszewski claim to have devised the methods, and constructed the apparatus, for liquefying considerable quantities of the more permanent gases, but he also asserts that most of the experiments on the properties of these liquefied gases which have been performed by Prof. Dewar are

only repetitions, on a larger scale, of work done by others. What, then, are these experiments?

Measurements of the refractive index of liquid oxygen, for the sodium light, and also of the absorption spectrum of liquid oxygen, were published by Profs. Liveing and Dewar in August 1892 (*Phil. Mag.* (5) xxxiv. 205; see also Dewar in *Proc. R. I.*, June 10, 1892; and Liveing and Dewar in *Phil. Mag.* for August 1894). The refractive index of liquid oxygen had been measured, and determinations of the absorption spectrum had been made, by Olszewski and Witkowski in October 1891, and these measurements were the complement of work begun, and published, by Prof. Olszewski in 1887 (*Wiedemann's Annalen*. xxxiii. 570. See Olszewski in *Phil. Mag.*, February 1895, 197-9). It is true that preliminary experiments on the absorption spectrum of liquid oxygen had been made by Profs. Liveing and Dewar in 1889. In their paper in *Proc. R. S.*, June 6, 1889, they say:—"We have observed repeatedly the absorption of liquid oxygen in thicknesses of 8 and 12 mm. Our observations confirm those of Olszewski."

On December 10, 1891, Prof. Dewar announced, in a note to the President of the Royal Society, that liquid oxygen is attracted by the poles of a magnet. This note was followed by another, on December 17, 1891, saying that liquid ozone was also attracted by the poles of a magnet. These detached, but interesting, experiments, which followed up work done by Faraday many years ago, must be placed to the credit of the Fullerton Professor at the Royal Institution.

A paper published in *Phil. Mag.* (5) xxxiv. 326 (1892) by Dewar and Fleming, on the electrical resistances of metals and other bodies at very low temperatures, contains the only piece of exact investigation to which Prof. Dewar's name is attached wherein liquid oxygen or air is used as an instrument of research, with the exception of the measurements of the optical properties of liquid oxygen, which have been shown to be mainly repetitions of the work of Olszewski and Witkowski. This research carries on and supplements earlier work done by Cailletet and Bouty, and by Wroblewski (*Comptes rendus*, ci. 161 (1885)).

A few observations have been made by Prof. Dewar on the phosphorescence of various substances at the temperature of boiling oxygen, and on the cessation of chemical action, and the continuance of photographic action, at the same temperature (see *Proc. R. I.* June 26, 1891 and June 10, 1892, also January 20, 1893; also *Proc. Royal Soc.* April 19, 1894, and *Proc. Chem. Sec.* June 28, 1894). The subject of chemical action at very low temperatures was investigated by Pictet in May and November 1892 (*Comptes rendus*, cxiv. 1245; cxv. 814) in a much more exhaustive way than has been done by Dewar, who has only touched the fringe of the matter (compare also Olszewski, *Phil. Mag.* February 1895, 208-9). The observations on the sensitiveness of the Eastman film at very low temperatures are interesting; but, so far as it has been published, the work is too slight to present material for detailed criticisms; and the same may justly be said of the lecture illustrations of phosphorescence at low temperatures. It may be remarked that Prof. Dewar's paper on photographic action at low temperatures has appeared only in the *Proceedings*, not in the *Transactions*, of the Chemical Society.

Prof. Olszewski's work on the properties of liquefied gases was begun, and accounts of his accurate experiments were published in recognised scientific journals, long before Prof. Dewar's experiments were heard of. The work of the Polish Professor is being continued in the same exact, modest, and scientific manner (see his paper on the optical dispersion of liquid oxygen in *Cracow Bulletin*, July 1894, noticed in *Phil. Mag.*, February 1895, 208; and his determinations of the boiling and freezing points, and other constants, of argon communicated to the Royal Society, January 31, 1895).

It seems to me that Prof. Olszewski has established a case which demands the instant and serious consideration of those who are truly interested in the advance of science, and are jealous of the good name of the scientific men of this country.

Cambridge, February 7. M. M. PATTISON MUIR.

THE object of the communications on the liquefaction of gases, which have recently appeared in *NATURE* and the *Philosophical Magazine*, is to depreciate the work of Cailletet and Pictet, to smother away the first-class work of the deceased

Wroblewski; to annihilate myself, and thereby to magnify the claims for originality of Prof. Olszewski. In spite of the mistakes inevitable to pioneers, the work of Cailletet and Pieter must always be credited with originating research in this department. To show my appreciation of such investigation, and to give it a wide publicity in the year 1878, a Friday evening address was devoted to the work of Cailletet and Pieter, during the course of which I showed for the first time in this country the working of the Cailletet apparatus. Similarly, in the year 1884, an address was given on the work of Wroblewski and Olszewski, in the course of which I illustrated for the first time in public the liquefaction of oxygen and air, showing the boiling point, &c., by means of a simple form of apparatus which did not involve the use of the Cailletet pump as employed by these experimenters. To deliver a lecture on the work of other people is generally considered a mark of honour, and as usefully diffusing a knowledge of the same. The critic has for some object omitted half the opening sentence of this address, which runs as follows:—

"The two Russian chemists, MM. Wroblewski and Olszewski, who have recently made such a splendid success in the production and maintenance of low temperature, have used in their researches an enlarged form of the well-known Cailletet apparatus; but for the purpose of lecture demonstration, which necessarily involves the projection on a screen of the actions taking place, the apparatus represented in the annexed woodcut is more readily and quickly handled, and enables comparatively large quantities of liquid oxygen to be produced."

The same tactics have been adopted of taking half a sentence from another part of the address, and leaving out the context. The sentence to which I refer ran thus:—

"Provided a supply of liquid ethylene can be had, there is no difficulty in repeating all the experiments of the Russian chemists; but as this gas is troublesome to make in quantity, and cannot be bought like carbonic acid or nitrous oxide, such experiments necessitate a considerable sacrifice of time. It was therefore with considerable satisfaction that I observed the production of liquid oxygen by the use of solid carbonic acid, or, preferably, liquid nitrous oxide."

Then follows a full description of how to use nitrous oxide with the apparatus in order to get liquid oxygen. Note the disingenuous comment of the critic: "No claim is made here to originality in the essentials of the apparatus, nor in the experiments performed." It has never been the custom to make public claims for originality, either in apparatus or experiment, in the course of an address given at the Royal Institution. He proceeds to allege, "the apparatus referred to by Prof. Dewar in his lecture of June, 1884, was used by Prof. Olszewski in 1883." On turning to the reference given, I find the following statement by Olszewski: "In 1883, and for several years following, I liquefied the gases in a strong glass tube." According to this distortion of fact, the apparatus of Andrews, Cailletet, Wroblewski, and Dewar are all the same, because gas was liquefied in a glass tube. I challenge the production of a reference to an apparatus antecedent to the date of this lecture in which liquid nitrous oxide had been used for the production of liquid oxygen. But all this is ancient history; the real charge begins with the year 1890. Assuming that I had been the inventor of Prof. Olszewski's apparatus of 1890, which is alleged to be the type used in the Faraday Commemoration Lecture of 1891, *on the separation of the forthcoming of the deluge four years in advance of the prediction of priority and personal merit*. What was said at the present juncture to precipitate this? In any one avoid coming to the conclusion that Prof. Olszewski's contact with "Argon" explains the sudden assault upon my labours in the same field of investigation.

If the critic had been a trustworthy person even to examine into the published lists, he could have found a reference in the *Proceedings of the Royal Institution*, between the years 1878 and 1893, that would have enlightened his ignorance, and thereby prevented his repeating Prof. Olszewski's suggestion that my large apparatus of 1891, which produced pints of liquid oxygen, was copied or derived from a description in *the Chemical Bulletin* for 1890.

Let us see what Prof. Olszewski said in the paper, entitled *Travaux de l'Académie de l'oxygène liquide*, June 1890:

"A flask of wrought iron, four litre in capacity (such as is used for liquid carbon dioxide) containing oxygen under a

pressure of 80 atm., is joined by a narrow copper tube to the upper end of a steel cylinder tested at a pressure of 200 atm. This cylinder having a capacity of 30-100 cub. centim., according to the quantity of oxygen which we wish to liquefy at a time, is immersed in liquid ethylene, of which the temperature may easily be lowered to 140 c. by means of an air-pump. The lower end of the cylinder is joined by a narrow copper tube to a little stopcock, through which the oxygen, liquefied in the cylinder, can be poured down into an open glass vessel, kept cool by the surrounding air."

In other words, replace the glass tube in my apparatus of 1884 by a small steel cylinder, and attach to its lower end a narrow copper tube with a stopcock, and the Olszewski apparatus of 1890 is produced, as a matter of fact, Pieter had used the same principle in the year 1878). Now, on June 11, 1886, I delivered a lecture on "Recent Researches on Meteorites," and the report in the *Proceedings of the Royal Institution* contains a sectional drawing of an apparatus solely constructed of copper, together with a valve for drawing off liquid oxygen, entirely different in type from the crude plan Olszewski adopted in 1890. I may mention that the plan of the apparatus was reproduced immediately after the delivery of the lecture, both in England and America. The section is confined to the refrigerator, all the accessories of liquefied and compressed gas bottles, compression and exhaust gauges, &c., having been omitted. From this plan of the refrigerator, any person so desiring could increase its capacity so as to work on a larger scale. The drawing shows the apparatus arranged for the special experiment of ejecting liquid oxygen into a vacuum chamber, but it is clear the apparatus discharged as easily into an open vessel. It is not any isolated experiment that is in dispute, but the new form of apparatus. The special object for which liquid oxygen was in use in this lecture, was to cool a piece of meteorite before insertion into an electric furnace. The following extract from the lecture will explain how the subject was introduced:—

"Meteorites, no doubt, have an exceedingly low temperature before they enter the earth's atmosphere, and the question had been raised as to what chemical reactions could take place under such conditions. It resulted from Prof. Dewar's investigations that at a temperature of about 130° C., liquid oxygen had no chemical action upon hydrogen, potassium, sodium, phosphorus, hydriodic acid or sulphuric acid. It would appear, therefore, that as the absolute zero is approached, even the strongest chemical affinities are inactive.

"The lecturer exhibited at work the apparatus by which he had recently succeeded in solidifying oxygen. The apparatus is illustrated in the accompanying diagram, where a copper tube is seen passing through a vessel kept constantly full of ether and solid carbonic acid; ethylene is sent through this tube, and is liquefied by the intense cold; it is then conveyed by the tube, through an india-rubber stopper, into the lower vessel; the outer one is filled with ether and solid carbonic acid. A continuous copper tube, about 45 feet long, conveying oxygen, passes through the outer vessel, and then through that containing the liquid ethylene; the latter evaporates through the space between the two vessels, and thus intense cold is produced, whereby oxygen is liquefied in the tube to the extent occasionally of 22 cubic centimetres at one time. The temperature at which this is effected is about -130° C., at a pressure of 75 atmospheres; but less pressure will suffice. When the oxygen is known to be liquid, by means of a gauge near the oxygen inlet, the valve A is opened, and the liquid oxygen rushes into a vacuum in the central glass tube below; some liquid ethylene at the bottom of the next tube outwards is also caused to evaporate into a vacuum at the same moment, and instantly some of the liquid oxygen in the central tube becomes solid, owing to the intense cold of the double evaporation. The outer glass vessel serves to keep moisture from settling on the sides of the ethylene tube. By means of the electric lantern and a lens, an image of this part of the apparatus was projected upon the screen, this being the first time that the experiment had been shown on a large scale in public.

"Performing this experiment, the temperature reached was a little below 200° C., that is, only 50° or 70° above the absolute zero of temperature, and in the experiment about 5 lbs. of liquid ethylene were employed."

"This I declare to be the first apparatus made wholly of metal, being an arrangement of copper coils, in which liquid oxygen

was made and decanted or transferred from the vessel in which it was liquefied to another by means of a valve, and thereby rendered capable of use as a cooling agent. In support of this assertion, I call as witness Prof. Charles Olszewski himself, who states in the *Philosophical Magazine*, February 1895, p. 189: "In 1883, and for several years following, I liquefied the gases in a strong glass tube." There is no suggestion made that a steel cylinder and valve was used by Olszewski till the year 1890. Whereas four years in advance I had used a much safer and better form of apparatus, practically identical in principle with that used in Cracow in the year 1890. Have I ever suggested that Prof. Olszewski was anticipated, or attempted to raise any question of priority? Perhaps the critic will have the audacity to say, in reply, this is no publication, the *Proceedings of the Royal Institution*, English and American science periodicals, not being amongst the class of recognised scientific journals. Well, if I am pleased to throw my bread upon the waters, adopting the view that every truthfully recorded experiment which appears in any journal associated with my name is publication, surely I should simply be conducting myself in the "too modest" way my critic commends.

As a specimen of the distortion of facts to prove another case of priority that is claimed, I find that MM. Charles Olszewski and Auguste Witkowski, Membres Correspondants, presenting their memoir "Propriétés optiques de l'oxygène liquide," on October 3, 1892, and, on referring to the paper, it is dated July 15, 1892, and the following footnote is added:

"Avant la publication de notre communication, MM. Liveing et Dewar ont fait connaître (*Phil. Mag.*, Aout 1892), les résultats de leurs recherches sur la refraction des gaz liquéfiés."

Yet the critic says our experiments were "mainly repetitions of the work of Olszewski and Witkowski." The garbled extracts selected to make it appear that I have been guilty of misrepresentation are all of the same kind. . . . Thus I am taken to task for using the expression in the lecture on liquid air, of 1893: "Having no recorded experience to guide us in conducting such investigations, the best instruments and methods of working have to be discovered." The next sentence runs as follows: "The necessity of devising some new kind of vessel for storing and manipulating exceedingly volatile fluids like liquid oxygen and liquid air, became apparent when the optical properties of the bodies came under examination. Apart altogether from the rapid ebullition interfering with the experimental work, the fact that it did take place involved a great additional cost in the conduct of experiments on the properties of matter under such exceptional conditions of temperature." What can be said in defence of such glaring misrepresentation of the meaning of my words? Mr. M. M. Patison Muir's demand for "instant and serious consideration" of his client's "case" has been quickly met. I trust the result will . . . fit in with his brief. JAMES DEWAR.

Royal Institution, February 12.

[A few personal remarks in Prof. Dewar's letter have been omitted, as they do not affect the points at issue.—Ed. NATURE.]

### Vertebrate Segmentation.

MR. H. G. WELLS, in a recent number of *NATURE*, honours my little book by making it an example of a contravention of what he regards as a principle of education. With that I have no quarrel. But I must object to the instance he has chosen. The sentences from which he quotes refer to the phenomena of segmentation common to coelomate tissues, and not to the derivation of vertebrates from any invertebrate group. So far from giving "the impression almost in so many words—'cut and dried,' and ready to be cast into the oven—that the vertebrate type is merely a concentrated derivative (concertina fashion) of the elæopod type," I devote the chapter (xv.) from which he has taken his quotations, to showing that the earthworm and the vertebrates merely belong to two out of the many isolated groups; and at the end of the chapter (though not in spaced type, as I did not consider the question of vertebrate descent congruous with the aims of an elementary textbook) I state that "the type common to the lowest members of the groups of which the earthworm on the one hand, and the vertebrates on the other, form the highest examples, is a simple unsegmented coelomate animal."

P. CHALMERS MITCHELL.

### The Black veined White Butterfly.

MR. KIRBY, on p. 340 of your last issue, says (in criticism of Mr. Furneaux) that this insect "would not frequent open ground at a distance from trees." I suppose there are not now many Englishmen who have taken it in this country: and it may be worth while to record that the common on which my brother and I used to find it tolerably abundant in the years 1857-1859, was quite an open place, with no adjacent wood, and very little hedge timber. This common is about a mile and a half to the west of Cardiff; I passed it in the train a few weeks ago, and noted that it is being encroached on by suburbs. We had many a hot chase there over gorse and briar, and always considered this butterfly the most difficult of all to catch. I have never seen it in England since 1850 or 1860.

Oxford, February 11.

W. WARDE FOWLER.

### Parrots in the Philippine Islands.

PRAY allow me space to acknowledge a bad mistake which I first made in the ninth edition of the "Encyclopædia Britannica" (xviii. p. 322), and have lately repeated in the "Dictionary of Birds" (p. 687), by asserting that parrots are "wanting in the Philippine Islands." Seeing that the article was written more than ten years ago, it is quite out of my power to account for the mis-statement: my only wonder is that it has not been before challenged, since there is, and has been for some centuries, abundance of evidence to show that there are plenty of parrots in that group of islands, which, indeed, is as well furnished with them (as remarked by my friend Mr. L. W. Wilesworth, who has kindly drawn my attention to my error) as is the island of Celebes, and I had already (p. 93) noticed the Philippine species of Cockatoo.

Cambridge, February 9.

ALFRED NEWTON.

### TWENTY-FIVE YEARS OF GEOLOGICAL PROGRESS IN BRITAIN.

LOOKING back across the fourth part of a century in the progress of any branch of science, we naturally turn first to the list of names of those to whose labours that progress has been due, and though many of these names may happily still be counted among the living, we note many a blank where the hand of death has thinned the ranks. Perhaps in this country no department of natural knowledge can boast a more illustrious bead-roll than that of Geology. The story of the earth had hardly begun to be scientifically studied until the first decades of the present century, and some of the early fathers of geology lived on until well within the life-time of the present generation. A curious transition has thus been going on during the last five-and-twenty years. On the one hand, there have been moving amongst us geological magnates who achieved their fame in the old days when it was still possible for a man to possess a tolerably full personal knowledge of almost every department of the science. On the other hand, around these few living memorial of the heroic age, grew up hosts of younger men, who, finding the main lines already traced for them, have become in large measure specialists, devoting themselves with enthusiasm, but with more restricted vision, to one formation, or one group of rocks, or one tribe of fossils. The days of broad outlines and rapid generalisation have gone. No new systems remain to be added to the geological record of these islands. No new assemblages of extinct types of life now reward the sedulous collector. We have entered upon the era of minute detail and patient elaboration. The field-glass has given way to the microscope. The advance of the science must now be based on laborious research, less brilliant no doubt in its immediate effect, but probably not less lasting in its influence and its results.

Among the great leaders who have passed away within the last twenty-five years are some who have largely helped to mould the whole fabric of geological science. In the petrography of geology, when will men cease to venerate the names of Lyell and Darwin? In laying down the broad lines of stratigraphy, Sedgwick and Marshall, Phillips, Griffith, Logan, Ramsay, and Jukes have left behind the imperishable monuments of their genius. In the paleontological domain, among many other illustrious men, Owen, Lonsdale, Salter, Davidson, Morris, Wright and Egerton have left us. In other departments of the science, our losses have been likewise heavy—the gentle Scrope, pioneer of volcanic geology; Robert Chambers, who, after Agassiz, led the way here in the study of ancient glaciers; David Forbes, who did so much to revive the study of rocks in Britain; as well as men like Page and Ansted, who by their popular writings helped to spread abroad an interest in geology.

Passing from the workers to the work accomplished, we may note a few of the more prominent features in the progress of geology in Britain during the last quarter of a century. Space will not permit the survey to be extended to the history of the science on the continent of Europe and in North America. And first as to the general recognition of the science as an important department of a liberal education. No previous generation has seen so many proofs of this recognition. Many new chairs of Geology have been founded in our universities and colleges. Text-books, class-books, hand-books, manuals and primers of the science have been issued in edition after edition, and new publications are constantly appearing. Field-clubs, and other local associations, have started abundantly into existence, and field-geology is one of their most attractive features. At no time of its comparatively short history has geology been more popular, in the best sense of the word, than it is at the present time.

If one were asked to specify the feature which above all others has marked the progress of geology in Britain during the last five-and-twenty years, one would reply with little hesitation—the enlarged attention given to the study of rocks, or what is termed the petrographical department of the science. For many years in this country that study was almost entirely neglected. The attractions of fossils and of stratigraphy drove minerals and rocks out of the field. As David Forbes used sarcastically to complain, geologists had forgotten that their father was a mineralogist. They allowed the petrography of the British Isles to lapse into a condition of dire confusion, without system, without accurate determinations, and without reference to what had been done in the subject abroad. The first important step in the way of reform was taken by one who is happily still among us, Mr. H. C. Sorby. Reviving the method of making thin slices for microscopical examination, devised by William Nicol, of Edinburgh, he applied it to the study of rocks, and showed how fruitful it might be made in investigating their history. Though his first paper appeared in 1839, it was long in awakening geologists in this country to the value of the new implement of research thus placed in their hands. It attracted notice sooner in Germany, and its applicability as demonstrated there, led ultimately to its adoption in the land of its birth. But only within the last twenty years has it been acknowledged to be absolutely indispensable in the investigation of the origin and history of rocks.

The introduction of the microscope as an adjunct in research has entirely revolutionised the study of petrography. And nowhere has the change been so marked as in Britain. The former chaos has been in large measure reduced to order. The rocks of this country, instead of being neglected, are a foremost object of study, and this branch of British geology has been brought abreast of the petrography of the continent.

It is perhaps inevitable that in such a complete transformation of methods, the new should be apt to be regarded as completely replacing the old way. The microscope has done so much, that its potency may not unnaturally be exaggerated, and a tendency so to magnify it may sometimes be observed. But, after all, the great field-relations of the rocks must in the first place claim our attention and guide our reasoning. The minute structures revealed by the microscope may be made admirably serviceable in controlling that reasoning, and in supplementing the field-evidence by a new body of data otherwise unattainable. Yet the microscope must remain the servant, not the master, in the applications of petrography to the larger questions of geological theory.

If now we turn to the stratigraphical domain of geology, perhaps the first remark that will occur to a reflective observer is that a much closer attention than ever before has been given in Britain to the investigation of the most ancient accessible parts of the earth's crust. The fundamental platform on which the oldest fossiliferous rocks repose, has been searched for with enthusiasm, and though this enthusiasm has led to mistakes, it has undoubtedly been successful in detecting that platform in several places where it was not before supposed to exist. The rocks of the platform have been laboriously investigated, and have been found to include both aqueous and igneous materials. Not only so, but a succession has been observed among them, vast sedimentary masses lying ununiformly on still more ancient gneisses. In these sedimentary accumulations no certain trace of organic forms has yet been detected. Nevertheless the search has not been abandoned. If it should eventually be successful, it would reveal evidence of a fauna or flora older than the oldest relic of life yet discovered in Britain.

In the region where the most ancient gneisses are typically developed, foliated representatives of almost all the well-known plutonic rocks have been recognised, and perhaps also, though dimly, traces of a group of primæval sediments, into which igneous masses have made their way. We have thus been able to take several distinct steps backward into the abyss of time. We know more clearly than before the general outlines of two or more great geological periods anterior to the earliest relics of animal life. And as a band of zealous investigators is busy in the exploration of these dim records, it is perhaps not too much to anticipate a rich harvest of discovery from their labours.

Among the applications of paleontology to the stratigraphical side of geology, unquestionably the most important in recent times has been the recognition of life-zones among the stratified formations, and the adoption of these as a clue to the interpretation of the sequence of strata, and even of tectonic structure. It is long since the ammonite zones of the Lias, first worked out in Germany, were traced in this country. Subsequently the paleontological platforms in the Chalk, so well developed in France, were found to hold good also in England. Still more recently the vertical distribution of graptolites has been shown by Prof. Lapworth to be so restricted that these organisms may be used to mark definite zones in the Silurian system. Nor is it in the animal kingdom only that such restriction has been asserted. The members of an extinct flora have been found to show a more or less marked sequence of genera and species, so that, alike in France and in England, the Carboniferous system has been subdivided into more or less distinct plant-zones.

The value of this paleontological aid in the investigation of stratigraphical succession can hardly be over-estimated. Among the undisturbed Secondary rocks of England, indeed, it is not indispensable, for the sequence of their formations and their subdivisions can be ac-

curately determined there from other evidence. Nevertheless stratigraphical arrangement gains much in precision, as well as in scientific interest, when changes in lithological characters are found to be accompanied by changes in organic forms; or, on the other hand, when the succession of animal or vegetable types is found to be repeated in distant localities irrespective of local variations in lithology. But where the rocks have been so folded and broken that from mere mineral characters their true order cannot be made out, the presence in them of determinable life-zones, elsewhere well established, may enable their complicated structure to be unravelled. How this task can be successfully accomplished, has been well shown by Messrs. Lapworth, Peach, and Horne, in regard to the excessively convoluted structure of the Silurian uplands of the South of Scotland.

There is, however, some risk of error in the application of this valuable aid in tectonic investigation. Obviously the existence of a life-zone, which will be of general utility, must be determined upon a basis of evidence sufficiently wide to eliminate mere local peculiarities. It should rest not on the presence of a single species, but on a group of species or genera, for the narrower its palæontological range the greater will be the risk of elevating accidental into general characters. We cannot suppose that a given species began and ended everywhere at the same time or on the same platform. In some areas the conditions would be favourable for its earlier appearance or longer continuance, so that we may expect the zones not to be very sharply defined, but to blend into each other, and in such a way that if we were to define them by single species we should find them to present exceedingly variable limits. In a restricted region, where the sequence of life-zones has been accurately ascertained, these platforms are of great value in working out questions of geological structure. But as we recede from that region the necessity of caution increases. The broad features of biological sequence will no doubt remain, and we shall be able to say where the upper or the lower members of a sedimentary series lie, but we may be led into mistakes by trying too rigidly to make the palæontological zones of one country agree with those of another.

In the department of geotectonics, one of the most interesting features has been the increased attention bestowed upon the nature and results of the great movements that have affected the crust of the earth. The early experiments of Hall, showing that the stratified rocks have undergone enormous lateral compression, have been repeated and extended, and many of the remarkable structures of mountain-ranges have been successfully imitated. More detailed investigation has been bestowed upon plicated and disrupted rocks, especially in Switzerland, Saxony and Scotland. The effects of mechanical deformation in producing foliated structures, even in what were originally massive rocks, have been copiously illustrated. The study of these questions has led to a better appreciation of the enormous plications, inversions, and dislocations which mountain-chains, modern as well as ancient, have undergone. In the Alps and in the Scottish Highlands, the subject has been pursued with great ardour, and these regions will henceforth be classical examples of some of the great features of geotectonic geology.

Another distinguishing characteristic of the last quarter of a century of geological progress has been the increased interest taken in the history of the earth's surface. It is strange that while, generation after generation, men laboured zealously to investigate the history of the planet as recorded in the rocks of the terrestrial crust, they neglected to take account of the superficial topography. They did not realise that every land-surface is a kind of palimpsest, on which the chronicles of a long series of ages may be more or less dis-

tinctly traced, and thus that every landscape has, as it were, two histories: first, that of the rocks which form its framework, and, secondly, that of the configuration into which these rocks have been carved. It was in Britain that this fascinating branch of geological inquiry first took definite form in the early days of Hutton and Playfair, and it is here that, after long neglect, it has within the last twenty or thirty years been renewed and pursued with most success. The varied geological structure of these islands, their changeable climate, their mountainous groups, and long lines of sea-beaten coast, make them exceptionally suitable for the prosecution of this inquiry. But this branch of geology is now receiving even more attention in the United States than among ourselves, and in many respects the geological structure of North America offers peculiar advantages for its cultivation.

It is impossible within the limits of this article to do more than present in brief outline a retrospect of a few of the departments of so wide a science as geology. Let me, in conclusion, make reference to but one more subject which has greatly exercised the minds of geologists during the last quarter of a century. It is more than thirty years since Lord Kelvin pointed out that there must be an ascertainable limit to the antiquity of the earth, and that from the data at that time available the limit could not be fixed at less than twenty, or more than 400, millions of years ago. He based this calculation on the thermal conductivity of the globe. Afterwards returning to the subject, he placed the limit within 100 millions of years; and still more recently, reviewing the question in the light of the arguments from tidal retardation and the age of the sun's heat, he has brought down the period of the earth's antiquity to about twenty millions of years.

Geologists have not been slow to admit that they were in error in assuming that they had an eternity of past time for the evolution of the earth's history. They have frankly acknowledged the validity of the physical arguments which go to place more or less definite limits to the antiquity of the earth. They were, on the whole, disposed to acquiesce in the allowance of 100 millions of years granted to them by Lord Kelvin, for the trans-action of the whole of the long cycles of geological history. But the physicists have been insatiable and inexorable. As remorseless as Lear's daughters, they have cut down their grant of years by successive slices, until some of them have brought the number to something less than ten millions.

In vain have the geologists protested that there must somewhere be a flaw in a line of argument which tends to results so entirely at variance with the strong evidence for a higher antiquity, furnished not only by the geological record, but by the existing races of plants and animals. They have insisted that this evidence is not mere theory or imagination, but is drawn from a multitude of facts which become hopelessly unintelligible unless sufficient time is admitted for the evolution of geological history. They have not been able to disprove the arguments of the physicists, but they have contended that the physicists have simply ignored the geological arguments as of no account in the discussion.

So here the matter has rested for some years, neither side giving way, and with no prospect of agreement. Within the last few weeks, however, as readers of NATURE will have observed, the question has been taken up anew from the physical side.<sup>1</sup> Prof. Perry, feeling that, after all, the united testimony of geologists and biologists was so decidedly against the latest reductions of time, that it was desirable to reconsider the physical arguments, has gone over them once more. He now finds that on the assumption that the earth is not homogeneous, as postulated by Lord Kelvin, but possesses a much

<sup>1</sup> NATURE, January 3 and February 7, 1895, pp. 147-151.

higher conductivity, and thermal capacity in its interior than in its crust, its age may be enormously greater than previous calculations have allowed.

The question being *an alicia*, we must wait until facts are settled. But there seems at present every prospect that the physicists will concede not merely the 100 millions of years with which the geologists would be content, but a very much greater extent of time.

ARCH. GEIKIE.

NOTES.

The second of the special meetings of the Royal Society is arranged for the 28th inst., when Prof. Weldon will bring forward as a subject for discussion, "Variation in Animals and Plants."

A sum of 12,000 francs (£150) was voted to the Mont Blanc Observatory by the French Chamber on Tuesday.

Prof. HENRY A. ROWLAND has recently been elected a Foreign Member of the Reale Accademia dei Lincei of Rome, in the section of Physics.

The death is announced of the Marquis de Saporta, the brilliant Formentor at Aix. He was a Correspondent of the Section of Botany of the Paris Academy of Sciences.

MR. REGINALD SICART POOLE, late Keeper of Coins at the British Museum, died on Friday last, in his sixty-third year. Few men have done so much as he to extend the study of Egyptology and antiquities, or have added more to these branches of knowledge. Before he was seventeen years of age he wrote a series of articles on Egyptian chronology, which afterwards appeared in book form under the title "Horæ Egyptiacæ." He began very early to lecture on Egyptology and numismatics, and in May 1864 made his first appearance as a Friday evening lecturer at the Royal Institution. In 1877 he became Keeper of Coins, and during his twenty-two years' tenure of that post he saw through the press thirty-five most valuable catalogues of the collections under his charge. He was the author of the "Cities of Egypt," and of the histories of "Egypt," "Hieroglyphics," and "Numismatics," published by Longmans in "Britannica." With Miss Amelia B. Edwards he was one of the founders of the Egypt Exploration Society, in which he remained the honorary secretary to his death.

A new scientific society, composed chiefly of the professors and assistants in the Paris Natural History Museum, has just been founded. This society owes its existence to Prof. Milne-Edwards, the present director of the museum. It is proposed to hold monthly meetings, and to issue a *Bulletin des Sciences Naturelles*, devoted to natural history matters.

The Londoner Literary and Philosophical Society is, for the first time, electing Mr. Henry Wood, F.R.S., for its president. A year ago the society was dissolved, its usefulness having been destroyed by the withdrawal of its intensional member, Sir John Lubbock, who had resigned his post in the Society, and had since then published a pamphlet, "The Londoner Literary and Philosophical Society," in connection with a new

history of the Museum of the Corporation of London, at Guildhall, has never been written, although the collection housed therein are of very considerable interest and value. Taking occasion of the visit of the Essex Field Club shortly next, Mr. C. Welch, the editor, will read a paper on the "Origin and Progress of the Guildhall Museum," to remedy this defect. The museum deserves to be better

known and better housed than it is at present. A museum fully illustrating the ancient history of London might easily arise from the present collections, and would be a worthy object for achievement for the richest Corporation in the world.

THE Société Technique de l'Industrie du Gaz en France offers several prizes in connection with the Congress to be held during the present year. The *Journal* of the Society of Arts says that the prizes open to all include one of 10,000 francs (£400) offered to the inventor of an incandescent gas-burner showing marked superiority, to be handed in to the Society before April 1 in the present year, unless the committee exercise their power of extending the period for another year. The sum of 8000 francs (£320) will be devoted to various prizes to be awarded to the authors of the best papers on some subject connected with the gas industry, such as the mechanical *manutention* (handling) of coals, cokes, and the various substances used in gasworks, a study of water-gas, and the substitution of hydro-carbons for cannel coal. The papers must be written in French, and not bear the name of the author; but they must contain at the commencement a motto, which must be reproduced on a sealed envelope containing a declaration, signed by the author, that his work is unpublished, and that he will not make any other publication on the same subject within a year. The manuscripts, with sealed envelope, must be sent to the Society, 65 Rue de Provence, Paris, at least forty days before the period fixed for the Congress.

DURING the past week the severe frost has continued over the whole of these islands, and heavy falls of snow have occurred in all three countries. The distribution of pressure has been generally anticyclonic, biting easterly winds, and gales on our coasts. The following are a few of the lowest shade minima published in the *Daily Weather Report* of the Meteorological Office, since we last went to press:—

	February 7	10	11	12	13
Nairn	0 ... 0	5 ... 4	3 ... 3	13 ... 13	5
Loughborough	2 ... 5	-4 ... 1	1 ... 4	2	
London	12 ... 10	11 ... 13	20 ... 14	15	
Cambridge	0 ... 0	7 ... 7	13 ... 15	15	

In the neighbourhood of the metropolis some very low readings were recorded on the 8th instant: Wallington 2.1, Croydon 5.5, Tulse Hill 6, Greenwich 6.9; and in other parts of the country the following minima have been observed: -12 at Braemar, -8 at Stamford on the 8th, -5 at Glenlee on the 9th, and a still lower reading, viz. -17, is said to have been observed at Braemar on the 11th instant. The reading of 6.9 at Greenwich is the lowest but one in the last 50 years, a temperature of 6.6 having been recorded on January 5, 1860. There had been no reading there lower than 10 in February during the same period, until the present frost, in which lower temperatures have occurred on two successive nights. In London such low temperatures rarely occur; a minimum of 5 was observed by Luke Howard on February 9, 1816. Another feature of the present frost has been the low daily maxima. On the 9th instant it did not exceed 20° at Tulse Hill. At Greenwich the maximum temperature on January 5, 1894, was 19°, which was then the lowest maximum observed there since 1841.

In a paper read before the British Medical Association in 1889, Dr. A. C. Miller pointed out that, under certain circumstances, advantage might be derived from high level residence in the treatment of tuberculous conditions. A note, which has a bearing on this view, is contributed by him to the *British Medical Journal*. The observers at the meteorological station on the summit of Ben Nevis are changed every three months or so. While on duty at the observatory, they are, as a matter



of course, exposed to the rigours and inclemencies of the climate on the top of the mountain, and are thus subject to conditions that, *prima facie*, might be expected to favour the occurrence of catarrhs and inflammations. But experience shows quite a different result. The observatory staff while in actual residence on the summit has been remarkably free from all kinds of ailments during the eleven years that have elapsed since the opening. The subsequent residence at low level, however, renders the members of the staff peculiarly liable to an affection which closely resembles, in most of its features, what is usually recognised as an influenzal catarrh. There seems little room for doubt that this condition is due to germ influences in the lower atmosphere. At the summit of the mountain organisms do not exist, or if they do exist, only in innocuous numbers. At the low level they relatively thrive, and, seizing upon the "virgin soil" of a renewed and susceptible mucous surface, they set up the phenomena described.

In the January and February numbers of the *Geological Magazine*, Mr. E. P. Culverwell criticises severely the astronomical theory of the Ice Age. He concludes that the change in the distribution of the solar heat received by the earth during a period of maximum eccentricity, would not cause a shifting of the isotherms as great as the displacements to which the course of existing isotherms is subject from purely geographical causes. If this is correct, the eccentricity theory of the Ice Age must be abandoned. As a possible alternative theory, Mr. Culverwell suggests a variation in atmospheric pressure through interchange of gases during the earth's passage through space.

SOME interesting additions to Paleobotany are being made by Japanese geologists. In a recent paper (*Journ. Coll. Sci., Imp. Univ., Japan*, vol. vii. part iii. 1894), Prof. Yokoyama gives the results of his study of the fossil plants from several localities on the outer or convex side of that remarkable island. Unlike the plant-bearing beds of the inner, concave side, which, so far as is known, are all Middle Jurassic, the strata from which the flora in question comes appear to be comparable in age to the Wealden of our own country. In the same number, Mr. Nishiwala records the occurrence in Japan of a Tertiary (probably Miocene) limestone with abundant remains of the peculiar calcareous alga or "nullipore," *Lithothamnion*.

PROF. A. ISSEL and Dr. G. Agamennone, who were deputed by the Italian Government to investigate the Zante earthquakes of 1893, have recently issued a valuable report of more than two hundred quarto pages (*Ann. dell' Uff. Cent. di Met. e Geod.* vol. xv. part i.: Rome, 1894). Dr. Agamennone contributes a catalogue of the earthquakes felt in Zante from the earliest times until 1893, and some general remarks on the same, as well as chapters on the relation between the shocks of 1893 and the contemporaneous geodynamic phenomena in Italy, and on the velocity of propagation of the principal shocks. Prof. Issel describes the geology of the island, relates in some detail the features of the recent earthquakes, and concludes the work with a chapter of theoretical considerations.

In a former note (p. 232), a brief description was given of a remarkable group of earthquake-pulsations recorded at several Italian observatories, and at Nicolaiew on October 27, 1894. It was supposed that these might have proceeded from the great earthquake which occurred on the same day in Chili and the Argentine Republic. The doubt which formerly existed about the time of the shock is now removed by the receipt of detailed accounts. The first pulsations were registered at Rome at 9h. 7m. 35s. p.m., Greenwich mean time, while the shock was recorded at the observatory of Santiago (Chili) at 8h. 50m. 26s.,

*i.e.* 17m. 9s. earlier. There can thus be little doubt as to the origin of the pulsations, which probably travelled with a velocity of nearly 11 k.m. per second.

A SIMPLIFIED process for silvering glass is described by MM. Auguste and Louis Lumière in the *Journal de Physique*. Take 100 parts by volume of a 10 per cent. solution of nitrate of silver, and add, drop by drop, a quantity of ammonia, just sufficient to dissolve the precipitate formed, avoiding any excess of ammonia. Make up the volume of the solution to ten times the amount by adding distilled water. The reducing solution used is the formaldehyde of commerce. The 40 per cent. solution is diluted to a 1 per cent. solution. The glass to be silvered is polished with chamois leather, and the bath is made up immediately before use, by mixing two parts by volume of the silver solution with one of formaldehyde. The solution must be poured right over the surface without stopping. After about five or ten minutes, at a temperature between 15° and 19° C., all the silver in the solution is deposited on the glass in a bright layer, which is then washed in running water. It is then varnished if the glass side is to be used, or polished if the free surface is required for reflection. This method does not require the scrupulous care necessary with other methods, but Brashear's process, for instance, gives mirrors which do not require polishing.

THE Government of Cape Colony has recently instituted inquiries in various quarters with a view to gain suggestions as to the best methods of developing the neglected sea-fisheries of the colony. The Minister of Agriculture has received a number of replies upon the subject, which have been published in the *Agricultural Journal* of Cape Colony. The first desideratum in a matter of this important nature is clearly that the Government should possess some trustworthy and responsible source of information upon matters connected with its sea-fisheries; and on this account Dr. Trimen, the Curator of the South African Museum, strongly recommends the Government to obtain the services of a competent naturalist, accustomed to the study of marine animals and, if possible, experienced in the work of English or American Fishery Departments, who would devote himself to a thorough study of South African Fisheries. The appointment of skilled naturalists as Fishery Advisers to Governments has been attended with excellent results in Holland and other countries, and we heartily endorse all that Dr. Trimen has to say in favour of the adoption of a similar course in the present instance.

MESSRS. LAWS AND ANDREWES have not finished their vindication of the innocuous nature of sewer air. We thought that from the microbic point of view this question had been disposed of; but the London County Council evidently think differently, and another report is to hand, telling us that the microbes present in sewage are not present in sewer air, and that there is no microbic relationship, either in quantity or quality, between the two. These investigators claim to have found a bacillus resembling the typhoid bacillus in a drain from the typhoid block of a fever hospital in which no disinfection had been carried out for two days previously. This is hardly "an important fact," and perhaps not an unexpected discovery; but it is interesting to note that when typhoid germs are placed in sterile sewage, they are said to succumb rapidly, whilst the closely allied *B. coli communis* multiplies extensively. Details are given as to how the sewage was sterilised; but whether culture material was introduced along with the respective organisms, is not mentioned. We fail to understand why the colon bacillus is described as "harmless"; it has been shown to possess very distinct pathogenic properties. Experiments were conducted to ascertain what effect certain sewage microbes would have on the vitality of the typhoid bacillus in

in the sewage, whether the demise of the latter would be hastened or retarded by their presence. In these investigations we were informed that the respective microbes were inoculated into the sewage *directly from the cultures*, so that we cannot accept the results obtained as representative. It has been repeatedly shown what an effect the presence of even minute traces of culture material has on the vitality of particular bacteria in water, &c., and what confusing and conflicting results have been obtained by different observers working with the same microbe through neglect of this simple precaution. It is to be hoped that if any further experiments in this direction are contemplated, Messrs. Laws and Andrews will bear this fact in mind.

The inaugural lecture "On the Present Relations of Agricultural Art and Science," delivered by Prof. R. Warington, F.R.S., in the University Museum, Oxford, on the 4th inst., has been published by Mr. Henry Frowde. By a few statements of fact, the Subthorpe Professor shows that the agricultural industry can only be placed upon a sound basis by the full adoption of scientific methods and the recognition of research. It is very well known that the provision for agricultural investigations in England is at present wholly inadequate. We have the important experiment station at Rothamsted, and the Royal Agricultural Society's station at Woburn. Experiments are also carried on at some of our agricultural colleges; but this represents practically all that is being done here for the elucidation of agricultural problems. Compare this with the provision made in other countries. "In the German Empire alone there are fifty-four agricultural experiment stations, besides numerous public laboratories for the analysis of manures, and seed testing. The experiment stations are supported by aid from the State. The whole number of experiment stations on the continent of Europe is about 190. There are besides these, about 120 public laboratories devoted to special kinds of agricultural work. In the United States, a great effort has recently been made to provide the whole country with experiment stations. Every State in the Union has now at least one station, supported, since the year 1887, with an annual income of about £3000 paid to it by the nation. The total number of experiment stations in the United States is at present fifty-five. . . . the practical working out of agricultural problems can only be accomplished by the establishment among us of a considerable number of experiment stations; only in this way can science be brought into touch with practice, and the teachings of science be reduced to that concrete form in which they can be put to profitable use by the farmer. Why should not our County Councils fund and maintain an agricultural experiment station in each county? Such a station would become a centre of light and teaching to a large district."

THE *Proceedings* of the sixteenth annual convention of the Association of Official Agricultural Chemists, just distributed by the U.S. Department of Agriculture, enforces the remarks referred to above. The volume is liberally full of facts relating to agricultural chemistry. It contains many original articles, abstracts of papers, analyses of fertilizers, foods, soils, and farm products, and numerous reports. Unfortunately, the results of such investigations in the United States are not fully applicable to British agriculture. What is wanted, as Prof. Warington pointed out, is a central agricultural laboratory in England, discharging one of its duties the preparation of chemical and agricultural statistics. When this has been established for a few years, agriculturists will not have to regret that they know more about the composition and properties of German and American produce than they do of similar products in our own country.

THE tenth of the Alembic Club Reprints, published by Mr. W. F. Clay, Edinburgh, contains Graham's most valuable contribution to pure chemistry, viz., the paper read before the Royal Society in 1833, entitled "Researches on the Arseniates, Phosphates, and Modifiers of Phosphoric Acid."

ALL that is readable about comets is to be found in Mr. Thynne Lynn's "Remarkable Comets" (Edward Stanford), the third edition of which has just been published. Though but a slender brochure of less than fifty pages, this little treatise comprises most of the interesting facts in the history of cometary discovery.

THE new illustrated catalogue of electrical and other apparatus, just published by Messrs Elliott Brothers, is capable of giving the student of elementary science a liberal education in scientific instruments. Almost every important piece of apparatus used in electricity is illustrated in the catalogue, as well as the tools of research and education in other branches of physical science.

THE Calendar of the Department of Science and Art, for 1895, has been issued. For the benefit of those unfamiliar with this publication, it may be worth mention that the Calendar comprises a history and general description of the whole Department, with a summary of the rules, and a list of the Science and Art Schools and Classes, containing the number of students in each school and in each subject.

IN the *Bulletin* of the College of Agriculture of the Imperial University of Japan (vol. ii. No. 3), Prof. Sasaki gives a full description of the scale insect of mulberry trees (*Diaspis patelliformis*, n. sp.) and of the principal features of its life-history. A great deal of damage seems to be done by this insect pest; and it would be well if tree-owners in Japan would make use of the simple remedial measures recommended by Prof. Sasaki. The *Bulletin* also includes a paper on the spermatogenesis of the silkworm by K. Toyama.

IN 1881, the first edition of "Elementary Lessons in Electricity and Magnetism" (Macmillan), by Prof. S. P. Thompson, F.R.S., was published. Since then the book has been reprinted, with alterations and additions, many times, and an entirely new edition has now been issued. We are reminded in the preface that during the fourteen years which have elapsed since the book first appeared, electrical science and the science of magnetism have been greatly advanced. Striking progress has been made in theory and in practice, and the expansion of knowledge has necessitated an expansion of the book. Whoso seeks a class-book on electricity and magnetism, containing an elementary exposition of recent work, will find their want supplied by Prof. Thompson's Lessons.

IN *Science Progress* for February, Dr. C. S. Sherrington, F.R.S., describes the varieties of leucocytes. Mr. A. C. Seward concludes his second contribution on the structure and formation of coal, with a paragraph which expresses his conviction that "the weight of evidence seems to tip the balance of opinion very materially towards the theory of drifting and subaqueous sedimentation, for the majority of the Palæozoic coal seams." An account of the researches on the methods of digestion in Coelenterates, is given by Prof. S. J. Hickson; Dr. W. F. Hume reviews works on geological folds and faulting; and Mr. Philip Lake adds to the literature of tectonic geology, a paper on Neozoic—that is, Mesozoic and Cainozoic—geology in Europe.

AT present the English Arboricultural Society hardly justifies its name, for it is more or less limited to the North of England. There is every prospect, however, of its extension southwards in the future, both on account of the attention now

being given to forestry, and because the Society is making efforts to increase its membership by going further afield. The *Transactions* of the Society, of which we have received a recent issue (vol. iii part iv.), should materially assist towards this end; for the instructive papers contained therein appeal to all foresters. In the Part received by us, there is an essay on "How Trees Grow," by Mr. J. Manghan; an essay on "Thinning Mixed Plantations," by Mr. W. Forbes; and a paper on "The Distribution of Trees in a Wood," by Prof. W. Somerville. These are all useful contributions, but even more important is the publication of the results of an inquiry, conducted by the Society, into the disease of the Larch, a subject about which much has been written and said. The information which Prof. Somerville has brought together, forms a valuable summary of the present position of knowledge in regard to the Larch disease, and shows the various conditions and cultural methods which hold out some prospect of securing comparative immunity from attack. With a larger membership, the Society would be able to carry out, and publish, the results of many similar investigations.

PROF. SCHIFF and Dr. Tarni describe, in a communication to the *Berichte*, an admirable substitute for the disagreeable sulphuretted hydrogen in qualitative analysis. The new reagent is the ammonium salt of thio-acetic acid,  $\text{CH}_3 \cdot \text{COSNH}_4$ . Ammonium thio-acetate is decomposed by hot dilute hydrochloric acid, liberating sulphuretted hydrogen without any precipitation of sulphur. No objectionable bye-products are formed in the reaction, only sal-ammoniac and acetic acid being produced. When a feebly ammoniacal solution of ammonium thio-acetate is added to a hydrochloric acid solution of the metals of the second group, and the liquid is heated to near boiling, the metals are at once precipitated as sulphides, while only the faintest odour of sulphuretted hydrogen is perceptible. After cooling and filtering, the filtrate is found to contain no trace of the metals, not even of arsenic if an arseniate had been originally present. The completeness and rapidity of the reaction, particularly in the case of arsenic, which is usually so troublesome to precipitate from arseniates, is one of its strongest recommendations, and is described by Prof. Schiff as being perfectly surprising. A couple of cubic centimetres of a 30 per cent. solution of ammonium thio-acetate is usually ample for a gram of the substance to be analysed. The reagent has been employed for some time by Prof. Schiff in the Pisa laboratory, and is much appreciated by his students, sulphuretted hydrogen being completely excluded from the laboratory, doubtless to the material advantage of all concerned, both as regards comfort and health. Thio-acetic acid is readily prepared by acting upon glacial acetic acid with phosphorus pentasulphide. It boils at  $95^\circ$ , and is but slightly soluble in water. When the acid is dissolved in a slight excess of dilute ammonia, a yellow solution is obtained, which is then diluted to three times the volume of the acid originally taken—that is, 10 cubic centimetres of the acid furnish 30 cubic centimetres of the reagent. Prof. Schiff serves the reagent out to his students in small bottles closed by a cork, through which a small pipette, holding 2 cubic centimetres, is inserted, by means of which the convenient quantity of the reagent can at once be added to the hydrochloric solution of their test substance. It is scarcely necessary to add that zinc, manganese, nickel, and cobalt are not precipitated in the presence of hydrochloric acid by the new reagent, any more than by sulphuretted hydrogen itself. The sulphides of these metals are at once precipitated, however, upon rendering the solution alkaline; but as ammonium sulphide acts quite as well for this purpose, Prof. Schiff confines the use of ammonium thio-acetate to the precipitation of the metals of the second group.

THE additions to the Zoological Society's Gardens during the past week include a Lion (*Felis leo*, L.) from India, presented by H.R.H. the Duke of Connaught; a Cape Bucephalus (*Bucephalus capensis*) from South Africa, presented by Mr. J. E. Matcham.

OUR ASTRONOMICAL COLUMN.

THE MASS OF THE ASTEROIDS.—A preliminary note on the probable mass of the asteroids was contributed by Mr. B. M. Roszel to the *Johns Hopkins University Circular* in May 1894, and summarised in these columns (*NATURE*, vol. 1. p. 87.) In that paper Mr. Roszel limited himself to determining the mass from a study of 216 minor planets; he has now extended the computations to 311 asteroids, the orbits of which are given in the *Berliner Astronomisches Jahrbuch* for 1894 (*University Circular*, January 1895). His chief object was to find a probable limiting value for the mass, rather than an accurate determination of the mass itself. Using the photometric determinations of the diameter of Vesta, by Pickering and Muller, and the direct measures of the diameters of Ceres, Pallas, and Vesta by Barnard, Mr. Roszel has reduced the volumes of all the asteroids to the volume of Vesta, except when Barnard's measures were the basis, in which case he computed the volumes of Ceres and Pallas separately, and added them to the combined volume of the remaining 309. Assuming the albedo constant and a constant density equal to the density of Mars, he obtained the following numbers:

Combined volume of 311 asteroids	5.185 vol. of Vesta.
"    "    omitting Ceres and	
Pallas.	2.684 " "
Volume of Vesta, in terms of volume of Mars:	
(1) From Pickering's estimate of the diameter of Vesta, assuming the albedo = albedo of Mars	0.00022
(2) From Muller's estimate, assuming (a) the albedo = albedo of Mars	0.00065
(3) From Muller's estimate, assuming (b) the albedo = albedo of Mercury	0.00129
(4) From Barnard's estimate of the diameter of Vesta	0.00018
Combined mass of 311 asteroids, in terms of mass of Mars:	
From Pickering's estimate, as above	0.00112
" Muller's estimate, as above (a)	0.00336
"    "    "    "    (b)	0.00666
" Barnard's measures	0.00273

The mean diameter of Mars was taken as 4230 miles. It appears from the above numbers that the combined mass of the asteroids is about 0.026 of the mass of the moon.

THE APPARENT DIAMETERS OF MERCURY.—During the transits of Mercury on May 9, 1891, and November 10, 1894, Prof. Barnard gave special attention to measurements of the planet's apparent diameter. (*Ist Jour.* No. 335.) In both cases the diameter in R.A. was found to be slightly greater than that in declination, and if this be not a mere accidental coincidence, as Prof. Barnard seems rather inclined to believe, it would indicate a small polar compression. The measures at the two transits respectively indicate a polar compression of 1/34 and 1/98, or a mean of 1/116. Though by no means insisting on the reality of the difference in the diameters, Prof. Barnard points out that "the results may be of great importance in the future, as bearing upon the rotation of the planet on its axis in a reasonably short period." Expressed in angular measure, reduced to unit distance, the two diameters as measured in 1894 were 6.241 for the "equatorial," and 6.178 for the "polar" diameter. It is incidentally mentioned that "though Mercury cannot be seen at transits with the naked eye alone, it only requires a power of 2½ diameters to make it easily visible."

THE VARIATION OF LATITUDE.—The results obtained by Mr. Chandler in his investigations of variation of latitude seem to be confirmed by M. Ivanof's recent discussion of the older series of observations made with the great vertical circle at Pulkowa. (*Ist Jour.* No. 335). "There is no doubt that two periods subsist; one equal to 428 days, the other to a year. Also, the semi-amplitudes of both terms are variable beyond any doubt."

## THE SUN'S PLACE IN NATURE.

I.

WHEN, in 1886, it became my duty to give a course of lectures here, I thought it advisable to deal with the sun and stars, not with reference specially to solar physics, but in order to give a general idea of two important lines of work which were running on nearly parallel tracks, and promised, in the end, with the greatest benefit to science. Only a very little was said in those lectures touching the relation of stars to nebulae, and the various views which have been held come out of mind with regard to the special nature of both these classes of celestial bodies. Such questions, however, have always had the greatest interest for mankind, for those at all events among us who care to know something about the universe in which our lot is cast. Now, friends, unfortunately or fortunately, depend upon the discussion or even the application of any branches of inquiry which are necessary in order to make progress along the lines of thought thus opened up; scant attention is paid to them, and rational bodies, for they lead to no profession; but in spite of that, some of the noblest triumphs of the human mind have been made in that region where man finds himself face to face with the mysteries of the distant heavens.

To consider completely the Sun's Place in Nature, which is the subject I have chosen for this present course of lectures, the relation of those two apparently different classes of celestial bodies to which I have referred, must be gone into. Thanks to the advance of modern science, I shall be able by-and-by to throw upon the screen pictures of clusters of stars, and of nebulae, in which you will see these bodies very much better than you could do if to-night you were in one of our best puppet-observatories in the world, for it so happens that the enormous progress which has recently been made in the application of photography to astronomical work enables us to get permanent records of parts of them which are so dim that they never have been and never will be directly revealed to the eye of man.

When we compare these two great groups of celestial bodies we find that, at all events in appearance, there is an enormous difference between them; that a nebula is certainly unlike a star, or even an ordinary star cluster. This is so obvious that even those who first observed those very few nebulae which are visible to the naked eye (such a one, for instance, as that which is now beautifully visible to us in the early night in the nebula of Orion, or the other in Andromeda, which we can see almost throughout the year), the greatest wonderment was caused by their strange appearance.

Let us go back 150 years. I have here a book, "*Les Hypothèses Cosmogoniques*," recently written by a distinguished French astronomer, M. Wolf, which contains a reference to what the French philosopher Maupertuis said about them in the year 1745. "The first phenomenon is that of those brilliant patches in the sky which are named nebulae, and have been considered as masses or groups of small stars; but our astronomers, with the aid of better telescopes, have only seen them as great oval areas, luminous and with a light brighter than the rest of the heavens. Huygens first discovered one in the constellation of Orion; Halley, in the *Philosophical Transactions*, pointed out six, the first in the Sword of Orion, the second in the constellation of Sagittarius, the third in the Centaur, the fourth before the right foot of Antinous, the fifth in Hercules, and the sixth in Andromeda. Five of these spots having been observed with a reflection of light, only one of them, the fourth, could be taken for a group of stars, the others seem to be great shining areas, and do not cluster among themselves, except that some are more round and others more oval in shape. It seems also that in the first of these stars which one discovers with the telescope are not capable of causing this brightness. Halley was much struck with these phenomena, which he believes capable of explaining a thing which has been difficult to understand in the Book of Genesis, viz. that night was created before the sun. He then regards them as holes through which one discovers an immense region of light, and finally, as openings in heaven itself. He concludes, to have been able to say that the stars which are seen in some of them are very near and radiant from the parts of light themselves."

I need not follow the quotation any further, but you see that 150 years ago some of our keenest intellects were struggling with the questions involved in mystery which had been started by the discovery of these nebulous bodies in space. That was in the year 1745. Soon after this, in the year 1755, Kant, who was a German, though he was by direct descent a Scotchman, brought out an hypothesis in which he attempted to show that there was the closest possible connection between stars and the clusters and nebulae of which Maupertuis spoke. He held distinctly that the stars were produced by some action brought about in nebulae; in other words, that the nebulae represented a first stage out of which stars, representing a later stage, were produced by certain processes of evolution.

From 1755 we pass to 1796, at which date we find a great Frenchman (Laplace) practically rediscovering and reasserting the same thing. It is believed that he knew nothing of Kant's prior work, and therefore we have the advantage of dealing with the results of the thoughts of two great minds. Laplace came to the same conclusion as Kant, so far as it went, but he went farther than Kant did, because he held that the nebulae really represent enormous masses of elastic gas at high temperature, and that therefore the stars, which he conceived, as Kant had conceived, to be produced by evolutionary processes from these nebulae, were really produced from incandescent masses of gas.

Now, seeing that our sun is a star, it is perfectly clear from this that both Kant and Laplace agreed that the sun, representing a star, had originally been produced from a nebula. That is my first point.

About the time of Laplace, i.e. about 1796, Sir William Herschel was making England famous by the discoveries rendered possible by that wonderful telescope which he had erected at Slough. There, for the first time, the possible similarities and the possible differences of these two great groups of celestial bodies were subjected to the most minute and laborious scrutiny. Well, he came absolutely to the same conclusion as his predecessors had done, and for Sir William Herschel there was no doubt whatever that from the most irregular nebula to the densest star there was a gradual process of change; that there was no radical difference, but that the star represented simply the result of certain evolutionary changes. This view thus strengthened held the field for some years; then a larger telescope was made by Lord Rosse, a 6-foot mirror was now available instead of the 4-foot one which had been erected by Herschel at Slough. Lord Rosse—you will find the whole story admirably told in Prof. Nichol's book, "*The Architecture of the Heavens*"—came to the conclusion that when he observed a so-called nebula on the finest possible nights, when the air was stillest, and the magnifying power which he could use was greater than usual, he could see what he called the possibility of a resolvability in it. That is to say, nebulae might after all really be star clusters, only immensely remote, so that the light of all the stars was, as it were, so welded together as to give that appearance of a candle seen through horn, which Maupertuis and his predecessors had observed.

Next we come to the year 1862, and we find a new instrument brought to bear, which at once drove into thin air all the statements which had been made on what had turned out to be a line of inquiry which was incapable of giving a final verdict. It so happened that in that year there was a very powerful combination formed by a distinguished chemist and philosopher, Dr. William Allen Miller, the Treasurer of the Royal Society, who had already done most admirable spectroscopic work, and a neighbour of his, Mr. Huggins, who had mounted a powerful telescope in 1856. The spectroscope, which was then practically a new instrument, was applied to the telescope.

I need not say much about the spectroscope, as I have already had an opportunity of describing it to some of you, but I may in a few words show exactly the function of this new instrument of enormous power, which has in a very few years perfectly changed the aspect of astronomical science. If we pass a ray of white light through a piece of glass called a prism, we find that after the light has so passed through, it is changed into a beautiful band, showing all the colours of the rainbow. This prism then is the fundamental part of the instrument which is called the spectroscope, and the most complicated spectroscope which we can imagine simply utilises the part which this piece of triangular glass plays in breaking a beam of light of any colour

into its constituent parts from the red to the violet; between these colours we get that string of orange yellow, green, and blue which you are familiar with in the rainbow. For sixpence any of you may make for yourselves an instrument which will serve many of the purposes of demonstrating some of the more beautiful fields of knowledge which have been opened up



FIG. 1.—A simple form of spectroscope.

to us by its use. From an optician you can get a tiny prism for sixpence; glue it at one end of a piece of wood about  $12 \times 1 \times \frac{1}{2}$  inch, so that you can see through it a coloured image of a needle stuck in at the other end of the piece of wood (Fig. 1). This you must do by looking sideways through it. Allow your needle to be illuminated by a candle or a gas

By such experiments as that, certain spectroscopic axioms have been formulated: three of them are very important.

First, when solid or liquid or densely gaseous bodies are incandescent, they give out continuous spectra.

Second, when a solid or liquid body reduced to a state of gas, or any gas itself, is giving light, the spectrum consists of bright lines, and these lines are different for different substances.

Third, when light from a solid or liquid body passes through gas at a lower temperature, the gas absorbs those particular rays of light of which its own spectrum consists.

We will next suppose, then, a spectroscope placed at the eye-end of a telescope (Fig. 2). The question put to the combined instruments is: 'What is starlight like?' It was found that the stars give a spectrum very much like the spectrum of the sun, in most cases at all events, and that this spectrum could be defined in the light of the third axiom, that certain of the light was absorbed, there were dark lines in the spectrum (Fig. 3); and thus we knew that light had been absorbed by an atmosphere surrounding something which was very much hotter than itself, and in that way the science of solar and stellar physics was founded.

Suppose another question put to this instrument: 'What is the light of the nebulae like?'

I have already told you that Laplace held that in these bodies we were dealing with gas at a high temperature. From the time of Tycho Brahe downwards, people had an idea that the nebulae were "fiery." What should we expect to get in our instrument? The second axiom tells us that, if we are dealing with matter in a state of gas, or anything vapourous at very high temperature, we shall get bright lines only. The question as to the nebulae was put in 1864, and, curiously enough, when the observation was made, Dr. Huggins remarked: "I suspected some derangement of the instrument had taken place, for no spectrum was seen, but only a line." "Only a line" was exactly what I suppose Laplace would have given all he possessed to see, if spectrum analysis had been invented in his day. That line settled the question. There was certainly a tremendous spectroscopic difference between stars and nebulae, and this difference has been emphasised by subsequent researches. (See Fig. 3.) It is evident, therefore, that Lord Rosse's suspicion that the nebulae might, after all, be found to be resolvable

into star clusters when greater optical power was used, was proved to be erroneous.

Now we come to the second point. I indicated in the previous course of lectures that there were differences among the stars, depending possibly upon chemical constitution, or temperature, or even upon their ages, and that the stars had been classified by several very diligent inquirers. Also, that in all the classifications that had been attempted, it was universally taken for granted, for some reason or other—possibly in view of the idea of Laplace—that all the stars in the heavens began in the condition of highest temperature, and that all that the stars did after that was to spend their millions and billions of years of life in getting colder; so that, if we could at the present moment find out which was the very hottest star in the heavens, we might be perfectly certain that every star in its beginning resembled exactly in spectrum, and therefore in physical constitution, that particular star which we suppose to be the hottest. It so happened that in that very course of lectures I pointed out, for the

first time, I think, in reference to the separation of stars into classes, that such an idea as that would never do; for if we form any conception of nebulae changing into stars, we begin by knowing that the stars are very much denser than the nebulae—taking the sun as an instance, the star practically close to us—and that as the stars are denser than the nebulae, they must be hotter than the nebulae, instead of being colder.

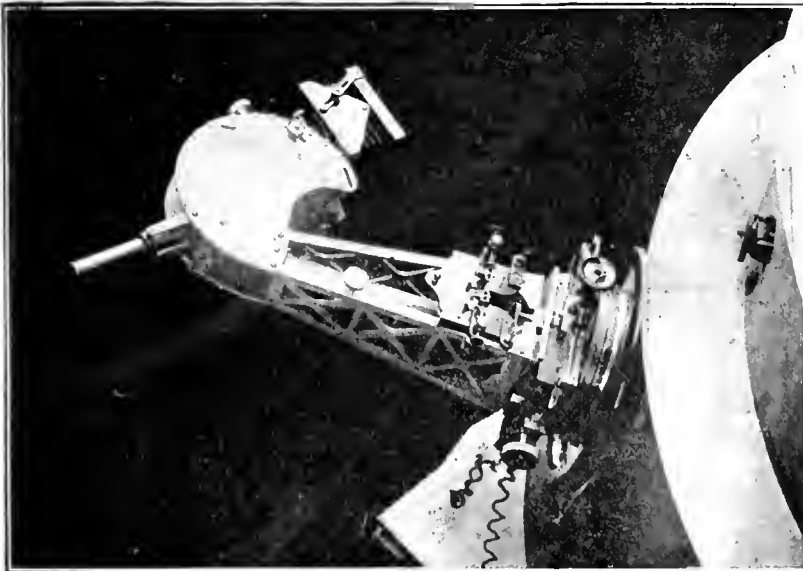

FIG. 2.—Star spectroscope, arranged for photographing, attached to eye-end of reflecting telescope.

flame, taking care that the direct light from the candle does not fall upon the face of the prism; you will then get a complete band of colour from red to blue. If you go into the sunlight—taking care again to protect the prism itself from the entrance of any foreign light—and allow the sunbeam to illuminate your needle, you get a spectrum of a different kind, full of black lines.

This depended absolutely upon the application of thermodynamics, and had been pointed out by Helmholtz in the year 1845. Sir William Thomson, now Lord Kelvin, also pointed out quite distinctly that the hypothesis of fiery nebulous matter—by that meaning nebulous matter hotter than the stars—was invented before the discovery of thermodynamics; otherwise, he said, the nebulae would certainly never have been conceived to have been fiery, something hotter than the average star.

I then went on to show that Lord Kelvin told us how he could imagine a condition of nebulae which might ultimately condense into stars without violating the laws of thermodynamics, which were completely traversed by Laplace's view; and he referred to a suggestion that had been made by Prof. Tait, who supposed that the luminosity of nebulae, and even the spectroscopic appearances which have been observed, might be explained by supposing that we were dealing with gaseous exhalations proceeding from the collisions of meteoric stones; and he also pointed out that possibly that would not only explain the luminosity of nebulae, but the luminosity of comets as well. By the kindness of the Director of this Museum, I have some specimens of these meteoric stones on the table. I would re-

might be explained by the fact that, in consequence of the collisions between these bodies occurring under different conditions and at different velocities, there would be very considerable differences in the temperatures produced in the two cases. Similar conditions might hold for stars in different degrees of condensation. It was also suggested that this new idea might explain the phenomena of variable and new stars, which have always been accounted to be the most extraordinary and mysterious in the whole domain of astronomy; and, finally, I said the subject was well worthy of study, because it seemed as if many phenomena on the nearest star to us, our own sun, might be really phenomena produced by the fall of meteoric bodies upon that surface which we see, and which we call the photosphere. It is now many years ago since Balfour Stewart and others threw out the idea that the phenomena connected with the formation of sun-spots were really produced by the fall of bodies upon that surface. Other philosophers have preferred the idea that we have to do with eruptions from the interior of the sun; nothing can be more divergent than the opinions which have been brought forward as explanations of these appearances.

But you at once see that, if we assume that this meteoritic action may take place in the solar atmosphere, it need not

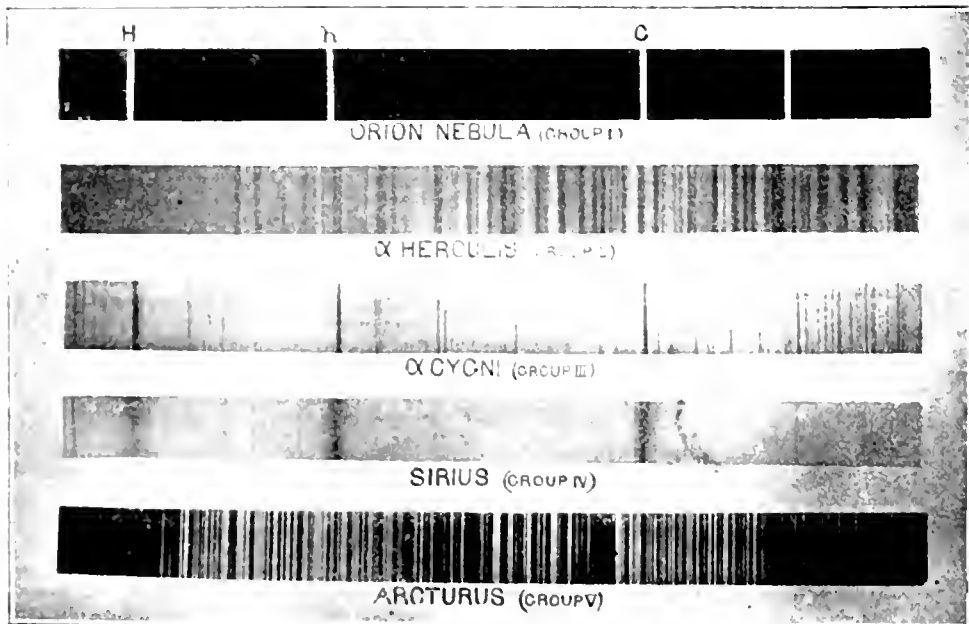

Fig. 1. The photographed spectrum of a nebula contrasted with the spectra of stars.

mind you that the few specimens which I have here have been selected from the magnificent collection upstairs; if you have a few minutes to spare after this lecture, you cannot do better than go and have a look at them, and you will see how very various both to the eye and in chemical and physical constitution they are. Let me also recommend you to get a little pamphlet (price 2s.) containing a description of the meteoric collection in the Natural History Museum, which is one of the finest in the world.

We thus arrived at the point that these wonderful nebulae may be explained, apart from any theory, that we have simply to look to a meteoritic origin to explain both the appearances and the spectrum.

After that point had been made I went on to make another, I had already referred to the various groups of stars, and I remarked that if one looked at the different groups of spectra, it seemed as if a classification of them, based on the ideas, did to the facts better, the existing ones depending on the unphilosophic one of Laplace. It is possible, I said, that the great differences which had been observed in the spectra of comets and nebulae, although the origin of the light of both was ascribed to the clashing together of stones in a certain part of space,

necessarily be a meteoritic action coming from without. Taking our own case, we live in a damp climate, and sometimes the air is dampest when there are no clouds. Clouds are condensations of the moisture in the air, and we know that it is not really a question of clouds only; we may have snow, rain, or hail, and all these represent different condensations of the damp—or, as we call it, the aqueous—vapour which is ever present in our air. Apply that to the sun. What is the air of the sun composed of? Well, certainly one important constituent of it is the incandescent vapour of iron; we are no longer dealing with a low temperature and the vapour of water, but with an atmosphere in the hotter parts of which iron is not solid or liquid, but in which the temperature is high enough to keep it in a state of gas, probably thousands of degrees higher than is arrived at in the Bessemer process.

We will assume, then, that that temperature and that condition of atmosphere prevails for 20,000 (it is probably nearer 50,000) miles above the photosphere of the sun. As we get further from the sun, the atmosphere is of course getting cooler, and at a certain distance above the photosphere the temperature will be so reduced that the iron vapour might play the part of our aqueous vapour; then it condenses and turns into iron snow

and iron hail and iron rain, and so on, falling upon the photosphere as the rain falls on the earth. There is thus a possibility in the sun of home-made meteoritic action.

So far as my last course of lectures was concerned, I there ended that part of the subject. But so many points had been raised in trying to give a connected view of these two very slowly converging lines of research to which I referred, that, after the lectures were over, I determined to discuss the various points which had been raised. I determined to take up Prof. Tait's suggestion, and see how all the spectroscopic observations which had been made up to the time of my lectures in 1886, bore out that suggestion which had been made in 1871, before there was very much spectroscopic evidence to go upon. The result was that my assistants and myself spent something like three years in gathering together, we believe, every available observation; at all events, if not every available observation, there were between thirty and forty thousand of them, and we found that a very considerable number. I not only determined to collect them, but also to discuss them, and make any experiments or observations which might be suggested by the discussion. The result of this was that, as a fruit of that course of lectures, several papers, some of them very long—it is not for me to say anything as to their value—were sent in to the Royal Society, and eventually brought together in a book.

Now, what I found was that when we discussed the meteoritic view in the light of all the observations we could get together, and in relation to stars as well as nebulae and comets, it seemed to explain many things, and threw a perfectly new light upon the visible universe; there were, moreover, several points raised of intense novelty and freshness, each of which could be discussed separately, cast aside if it were false, and held on to if it were true. I give a table of some of these new points of view.

*New points of view in the Meteoritic Hypothesis.*

- (1) There is the closest possible connection between nebulae and stars.
- (2) The first stage in the development of cosmical bodies is not a mass of hot gas, but a swarm of cold meteorites.
- (3) Many bodies in space which look like stars are really centres of nebulae; that is, of meteoritic swarms.
- (4) Stars with bright-line spectra must be associated with nebulae.
- (5) Some of the heavenly bodies are increasing their temperatures; others are decreasing their temperatures.
- (6) Double swarms, in any stages of condensation, may give rise to the phenomena of variability.
- (7) New stars are produced by the clash of meteor swarms. They are closely related to nebulae and bright-line stars.
- (8) Cosmical space is a meteoritic plenum.
- (9) A new classification of the heavenly bodies, based on the varying states of condensation of the meteoritic swarms.
- (10) The sun is one of those stars the temperature of which is rapidly decreasing.
- (11) Many of the changing phenomena of the sun are due to fall of meteoritic matter upon the photosphere.

We ultimately arrived at the conclusion that the sun is one of the stars, the temperature of which is gradually decreasing, and that many of the phenomena of the sun are due to the fall of meteoritic matter on the photosphere.

The doing of a large piece of work like that—and I say it is large because I am glad to have the opportunity here of expressing my gratitude to my assistants, who stood by me for three years—brings one out pretty well into the open, and renders one liable to a brisk fire of criticisms, some very valuable, some quite unworthy of the critics.

You will see that the work was undertaken with a view of determining the sun's place among the stars.

J. NORMAN LOCKYER.

*(To be continued.)*

**THE INSTITUTION OF MECHANICAL ENGINEERS.**

THE annual general meeting of the Institution of Mechanical Engineers was held on Thursday and Friday evenings, the 31st ult. and the 1st inst. Prof. A. E. W. Kennedy, F.R.S., occupied the chair. There were two papers set down for reading and discussion:

“The Determination of the Dryness of Steam.” By Prof. W. Cawthorne Unwin, F.R.S.

“Comparison between Governing by Throttling and by Variable Expansion.” By Captain H. Kiall Sankey.

Prof. Unwin, in his interesting paper, gave descriptions of the best known methods of determining the mean of moisture in steam up to now introduced. Most of the apparatus described was exhibited on the table of the theatre, whilst diagrams illustrative of them were hung on the wall. The author pointed out that the earliest attempts to determine the amount of moisture in steam, of which records have been found, were made during some boiler trials carried out by a committee of the Société Industrielle of Mulhouse in 1859. This committee tried three different methods—a method of separation, a condensing method suggested by Hirn, and a chemical method. In these early trials the condensing method only, in which the total heat of a sample of the steam was measured, appeared to give satisfactory results. But although the committee did not place full reliance on any of their methods, these have all been used by various experimenters down to the present time.

The origin of water entrained in steam, Prof. Unwin said, was to be attributed to three causes:

(1) Water projected into the boiler's steam space during ebullition. The extent to which wetness occurs depends on the activity of the ebullition, the area of the water surface, the volume of the steam space, the position of the steam valve, the density of the steam, and, probably more than anything else, on the quality of the water and its liability to produce foam. The author referred to the experiments of Mr. Thornycroft, who constructed a boiler with glass ends, through which the process of boiling could be seen. The result of observations on this boiler showed that waters which cause priming produce foam on boiling. Water which is very bad produces bubbles so durable as to remain a considerable time without breaking; and by them the steam space of a boiler may be entirely filled. So soon as this takes place, instead of simply steam leaving the boiler, the discharge consists of foam, which becomes broken up in its rapid passage through the steam-pipe. With pure water, steam retains no film of liquid long enough to be seen.

(2) Water may be produced in steam from the expansions to which it is subjected. Fluctuations of pressure arise from the intermittent demand for steam, and from the steam passing from places of higher to places of lower pressure. Prof. Unwin considered it difficult to believe that any great amount of wetness arises in this way in ordinary cases.

(3) The steam in the boiler, and the steam-pipes, loses heat by radiation. Probably in some cases considerable wetness is produced in this way. The wetness of the steam, so far as it is due to this cause, will increase as the demand for steam diminishes.

The author next went on to deal with the various methods of determining the wetness of steam, referring first to the weighing method, by which a known volume is weighed, when any excess of weight above that of a corresponding volume of dry saturated steam must be due to the water present. This method is obviously one of excessive difficulty.

The superheating method was next referred to in the paper, the experiments of Barrus and Carpenter being quoted. The Carpenter calorimeter consists of a vessel about 12 inches high by 5 inches diameter, consisting of an inner chamber and a jacket. The steam from the steam-pipe passes first to the inner chamber, where the moisture is separated, and then into the outer chamber. The separating chamber is therefore perfectly protected from radiation. As the water accumulates in the inner chamber, its level is shown by a gauge glass, and the amount in hundredths of a pound can be read off on a scale. A very small orifice at the bottom of the outer chamber regulates the amount of steam discharged. The escaping steam passes through a flexible tube to a simple form of condenser. The increase of weight in any given time in the condenser is noted, and the amount accumulated in the same time in the separator.

The condensing method was next described. This is founded on the condensation of a known weight of steam and the determination of its total heat by the rise of temperature in the condensing water. By comparing the total heat per pound of a sample of steam with that of a pound of dry saturated steam according to Regnault's tables, the amount of moisture in the steam can be determined. This method was first suggested by Hirn, and the apparatus which he designed is perhaps the most

1. “Circulation in the Thornycroft Water-Fall Boiler.” *Transactions of the Institution of Naval Architects*, 29, 1.

convenient form of apparatus for determinations by this method. It consists of an iron vessel about a foot in diameter, furnished with a glass cover; this forms the condenser. A small pipe and cock in the steam pipe deliver steam through a small orifice into the steam pipe into another pipe, through which it passes into the measuring water. An agitator and a sensitive thermocouple are provided in the condenser. For weighing the amount of steam condensed, the whole condenser is suspended from a hydrostat, which permits extremely accurate determination of any change of weight. The hydrostat is balanced by weights and the pointer is at a fixed mark before and after condensing the steam. The condensation method, the author said, is strictly accurate in principle, but difficult to carry out in a satisfactory manner. In order to overcome the difficulties a method of continuous condensation has been introduced. By this steam and cold water are both supplied at a constant rate, and the condenser acquires a steady temperature, which can be very accurately observed. A diagram of a continuous injection condenser was shown on the wall of the theatre. Steam passes from the steam-pipe to a small cylinder. The condensing water is drawn from a tank, and the mixed water and condensed steam are discharged into another tank. The two tanks are placed on platform weighing machines. Two thermometers give the temperature of the condensing water, the water used for condensing the steam, and of the mixture of condensed steam and condensing water. The difference of the total weight in the two tanks, after any interval of time, is the steam condensed in that time.

A separating method, which was introduced about the year 1860, by Mr. G. Barrus, was next referred to by the author. The steam to be tested is passed through an inner chamber jacketed by superheated steam. The sample of steam to be tested is thus dried and superheated at the expense of heat borrowed from the jacket. To avoid measuring the steam, an attempt was made to secure that equal weights of steam passed through the inner chamber and through the jacket. In that case the wetness of the steam can be calculated from observation of the temperatures only. The method, the author said, is accurate in principle, but appears to be difficult to carry out satisfactorily.

The wire-drawing calorimeter was next described. This and the separating method of the author considers most nearly fulfilled the necessary conditions requisite for measuring the quantity of moisture contained in steam. This calorimeter consists of two cylinders, steam passing from the first to the second through an aperture of a given diameter. The first steam pressure is in the first cylinder, and the pressure in the second differs little from atmospheric pressure. The manometers give the temperature of the steam (which are protected from radiation), and in this way the quantity of water present in the steam is estimated. The steam is allowed to flow through the apparatus for twenty minutes, when the temperatures become nearly steady. The weighing is completed, and temperatures only have to be observed. The observations can be continued as long as desired, and the steam may be used for the dryness fraction, from a considerable number of tests. If the steam is very wet, the temperatures in the inner chamber fall to about 212°, showing that water has been deposited. Atmospheric pressure is sufficient to dry the steam. The following table may be used if the wetness is not too great, as given in the following table, the pressure being 15 lb. per sq. inch, and the atmospheric pressure 14.7 lb. per sq. inch.

Final pressure in the second cylinder	Final temperature in the second cylinder	Final wetness in per cent.
26.7	152.2	0.50
67.2	175	2.44
133.7	191.4	4.21
247.7	213.9	9.13

The second cylinder is provided with a weighing scale using this method. The second chamber must be large enough for the orifices to the orifices are the transfer of heat and radiation must be so far prevented that the steam in the chamber is not sensibly cooled. A calorimeter by which the separating and wire-drawing methods were combined was also explained by the author. This is the globe calorimeter, which is a well-arranged apparatus.

Common superheating method was also described. A vessel of the well-known form is to be tested, and then heated by a jacket. As the jacketed, the mixed pressure in the interior of the vessel, the volume being constant. So long as the

steam is moist, the pressure will rise with the temperature according to the law for saturated steam. The moment all the moisture is evaporated, the rate of rise of pressure with temperature will become much slower.

The well-known salt test was next alluded to by the author. This, however, he pronounced to be inconvenient and untrustworthy, excepting perhaps in the case of a boiler subject to marked priming action.

The general conclusion drawn by the author was that the wire-drawing calorimeter without separator is the most convenient and accurate for steam with less than about 2 per cent. of moisture. For steam containing more moisture, the separating calorimeter without wire drawing apparatus is accurate enough and convenient. The use of the separator and wire-drawing calorimeter combined is more troublesome, especially if, as is desirable, a condenser is also used to determine the amount of steam passing through the separator. In cases where there is much priming, it would seem best to take the whole of the steam through an ordinary steam-separator, measuring the amount of water trapped, and then to test by a wire drawing or separating calorimeter the dryness of the steam after passing the separator. With priming much of the water probably flows along the bottom of the pipe, and it appears impossible that a sample can be obtained containing an average proportion of steam and water. It is recommended by Prof. Carpenter that the sample of steam to be tested should always be taken from a vertical, not from a horizontal steam-pipe. No doubt there is rather more tendency for water to flow along the bottom of a horizontal pipe than down the sides of a vertical pipe; but merely taking steam from a vertical pipe does not ensure freedom from error, especially if the amount of moisture in the steam is considerable. Variations in tests for wetness are doubtless often due to the difficulty of getting a true average sample of steam; and it would seem that errors are generally in the direction of under-estimating the amount of moisture.

A long and interesting discussion, which was adjourned from the Thursday until the Friday evening, was held on Prof. Unwin's paper. The chief point touched upon was the method to be adopted in getting a true sample of steam for analysis. This undoubtedly is the great difficulty that has to be overcome before a satisfactory method of determining the amount of moisture in steam can be arrived at. The majority of speakers were of opinion that water entrained in the steam would hang to the sides of the pipe, and a good many suggestions were made with a view to shifting the collecting nozzle over the whole area of the cross-section of the pipe, or else to give such an orifice to the nozzle as would cover a large part of the pipe area.

In his reply to the discussion, Prof. Unwin explained that this did not seem to him the true light in which the problem should be regarded. With steam rushing through a pipe at high speed, eddies would be set up which would be sufficient to thoroughly mix the steam and water so that there would be a fairly homogeneous mixture. The true difficulty arose from the checking of the velocity of the steam at the collecting orifice, an action which resulted in water accumulating so that an excess of moisture was shown in the sample drawn off. In order to overcome this, he had devised a collecting nozzle consisting of a bent-over tapered pipe, the orifice of which was at the small end, and was pointed towards the flow of steam. By adopting the necessary dimensions for the collecting nozzle, the steam collected would not be checked in velocity at the collecting orifice, and therefore moisture would not be deposited at that point.

Captain Savelly's paper was one of considerable length, and although dealing with one point only of engine design, was of great interest to engineers. It was illustrated by a large number of diagrams hung on the wall of the theatre. Without these it would be extremely difficult to give a fair idea of the course of reasoning followed by the author in discussing the merits of the two systems of governing engines. The paper, as the author said, was an elaboration of one section of a paper contributed to the Institution of Civil Engineers by the late Mr. Willans.

Speaking broadly, it may be said that the author's opinion was that the popular verdict in favour of variable expansion governing may for many purposes be accepted, yet its advantages were commonly much overrated, and in some cases it had no advantage at all.

It would be impossible within the limits of our report to trace out the respective merits of the use of the throttle valve and



automatic expansion gear, under the many conditions of working which the author supposes; and as the discussion on the paper was adjourned until the next meeting, we may leave the subject for the present.

The summer meeting of this Institution will be held in Glasgow this year, commencing Tuesday, July 30, and concluding on the following Friday.

THE ADVANCE OF TECHNICAL EDUCATION.

THE present state of technical education in England is, on the whole, satisfactory from the scientific point of view. The authorities having the funds arising from the Customs and Excise Act under their control, are beginning to see that instruction in the principles of science is by far the most important of the requirements. They are also coming to recognise that immediate results cannot be expected from their work—that they are laying a foundation rather than erecting a complex edifice. The Technical Instruction Committees who have not sufficiently realised this, will find that they will have to materially modify their at present too ambitious schemes, postponing much of the instruction in subjects of technology until a more thorough acquaintance with the fundamental principles of science underlying all such purely technical education has been provided, for it is only by such means that the stability of their educational superstructure can be ensured.

There are no grounds, therefore, for taking a pessimistic view of the future of technical instruction. One of the most gratifying signs of development is the large number of scholarships now awarded, and the increase in the number of competitors for them. The current number of the *Record* of Technical and Secondary Education sets forth in detail a statement as to the scholarships and exhibitions actually awarded, during the year 1893-4, by County and County Borough Councils. This most valuable Return shows the number of scholarships and exhibitions awarded; the value and length of tenure of the awards; where held; conditions to be fulfilled by the candidates; and the examining body, and the subjects of examination. Subjoined is a summary of the information.

Scholarships and Exhibitions tenable at	No. of Councils.	Scholarships and Exhibitions.		Total yearly value.
		Number awarded.	£	
(1) Technical, and Science and Art Schools ...	36	3456	10,620	
(2) Secondary Schools ...	37	1789	20,409	
(3) Universities or Institutions of University rank	28	362	6,783	
(4) Short courses of instruction ...	25	561	3,825	
		6168	41,637	

Sixty individual counties and county boroughs are represented in the above summary. Two others, Derby and Sheffield, allocate respectively £325 and £1000 annually to scholarships, and taking these into consideration, it appears that the total sum expended for the promotion of technical and secondary education by scholarships, during the year ending March 1894, was, in round numbers, £43,000. But this by no means represents the limits of expenditure under the scholarship head. It does not take the renewal of scholarships into account, and there are still seven local authorities whose scholarship schemes have not come into operation. Also, the scholarship schemes will undoubtedly be further developed as the work goes on; in fact, it is estimated that before very long as much as £50,000 will be spent annually on scholarships by the London Technical Education Board alone. Truly, these are halcyon days for the promising young student, however humble his state of life may be.

As to the values of the scholarships, they vary from a few shillings, as a fee for a short course of instruction, to £60 a year tenable for three years. The lower limit of age is usually thirteen, and the higher, twenty-five, though we see no reason why such a maximum age should be made absolute. In some cases, the income of the parents of competitors must not exceed £400 a year, but in others—London is the most notable instance—the parents of competitors for junior scholarships must not be in receipt of more than £150 a year.

Another important statement in the current *Record* shows the plans for promoting technical and secondary education in each of the counties and county boroughs of England. From this it appears that, of the 110 local authorities in England, 95 are giving the whole, and 13 part of their grants to educational purposes. Preston is the remaining authority, and it devotes the whole of the grant available—about £1600 per year—to the relief of the borough rate. But it should be stated at once, that Preston possesses a well-endowed "Harris Institute," where technical education has been carried on for years. The total amount available by local authorities is about £744,000, of which about £144,000 is diverted to the relief of the rates, leaving £600,000 for expenditure on education. We are sanguine enough to believe that, before long, most of the £144,000 at present devoted to general county purposes will be expended in advancing technical education. London alone is responsible for £114,000 of this misapplied balance, but as its educational scheme matures, it will doubtless absorb the whole amount available. It is to be hoped that the authorities applying the remaining £30,000 to rates, will soon see how detrimental their action is to their own interests.

In this connection it is necessary to condemn the application to rates of any unexpended balance of the grant available. In every county and county borough there are persons who utterly fail to realise that the interests of science are the interests of industry. To them, immediate advantages in the shape of a minute reduction of the rates, appeals far more than prospective developments of our national industries. Had such people the control of affairs, technical instruction would indeed be curtailed within narrow limits. Fortunately, they represent but a small minority in the County Councils; nevertheless, their influence is occasionally manifest. Ever since the Technical Education Acts came into force, attempts have been made here and there to use for general county purposes the funds available and necessary for education. But if the work is to be successfully carried out, it is essential that the Technical Instruction Committee should have entire control of the grants allocated to technical education. There is far too much uncertainty about the grants even now, and the County Councils which are inclined to exercise a veto as to the destination of the surplus funds of their Technical Education Committees, will soon find that self-respecting members of the Committees will retire from the work. Recently, however, one or two Councils have shown their incapacity to understand the magnitude of the problem before them, by voting the unexpended balance of their grants to the relief of rates. This action is tantamount to declaring that the funds at the disposal of the Committee are in excess of what is required; whereas, it is hardly too much to say that additional secondary schools are needed in almost every county and county borough in England, only to mention one way in which the money might be expended. For the balance to be diverted from education is bad enough, but no great foresight is needed to see that, once the action has been taken, there is no knowing where or when it will stop. Perhaps the county of Hampshire is the most notable instance in which a County Council has crippled the work of its Technical Instruction Committee. In November last, according to the *Southampton Times*, the Council resolved to appropriate, for general purposes, £6000 from the surplus funds which had been accumulated by the Technical Instruction Committee with the idea of eventually using it in educational developments. Without taking the views of the Committee into consideration, the Council appears to have calmly confiscated the balance resulting from economical administration, and by so doing not only discouraged careful expenditure, but in one fell swoop rendered the Committee powerless to deal in the future with matters which alone could be met by exceptional means. Surely it is not too much to expect a Council to have confidence in the ability of the Technical Instruction Committee, and to allow it to know its own needs. At any rate, a Committee whose opinion is disregarded must soon lose confidence in itself. It is a matter for congratulation that County Councils generally have not treated their Committees in the same way as the elect of the county of Hampshire.

One of the most refreshing reports we have seen for some time has recently been issued by the Derbyshire County Council. The report is satisfactory, not so much on account of work accomplished, but because it affords evidence that the Committee seems to have been brought to a good understanding as to what technical instruction should mean. One of the chief difficulties

which is the only one that can arise from the suspicion  
 of a "technical man" registrar, who schemes  
 to benefit him. No class endures this  
 in farms and their labourers. Almost every  
 of the apathy, or the opposition, of  
 the extension of knowledge in the scientific  
 of agriculture. When the Derbyshire Committee  
 of this branch of their work, they decided to establish  
 of the Department of Science and Art, because such classes are an unshakable ob-  
 of this section of the community. In the first place,  
 of an appearance of attempting a "turning" in the  
 of a man, and secondly, the teacher who is qualified to give  
 of the information contained in the Science and Art syllabus,  
 of actually engaged in the agricultural industry.  
 of both these difficulties have been cleverly met by the  
 of the Committee in this way:—"In place of the 'Agriculture' Classes  
 of the Science and Art Department, the Committee are anxious  
 of the students in rural evening schools shall go through a  
 of elementary science, which shall be of a very simple  
 of the highly scientific. It is intended that the student  
 of be taught by actual experiment, and shall thus come to  
 of appreciate the results of science as not fanciful, but are  
 of conclusions drawn from a study of actual facts. The phenomena  
 of of these are of less than a general character, but  
 of are largely confined to the domain of agriculture, so that  
 of without any special aid, the schoolmaster is attempting to  
 of teach "farming," the student learns a number of principles  
 of which can be directly applied in practice.

"The great merits of this scheme of teaching elementary  
 of science in evening schools in place of starting Science and  
 of Art Department 'Agriculture' Classes are that the students  
 of take up the study of science at a young age, studying other subjects which  
 of to make up the curriculum, the Elementary Science course  
 of extending over two or three years, so that a first set of pupils is  
 of only what the other ones have passed through; and further,  
 of there is no suspicion of teaching what can only be learned on  
 of a farm."

The scheme is very attractive, and good results may be  
 of expected from its application in Derbyshire. It enforces the  
 of that a knowledge of the elementary principles of science is  
 of not only a basis upon which to build courses of technology.  
 of The county of Derby is more dependent upon the mining  
 of industry than on any other; therefore its organisation of instruction  
 of in mining deserves a word of remark. It attempted to  
 of provide the instruction by means of courses of lectures delivered  
 of in a certain number of pit villages, but the results were hardly  
 of successful. The teaching was afterwards given by local men  
 of who had practical knowledge of mining, and some acquaintance  
 of with collateral branches of science, and this scheme was more  
 of satisfactory than the former. The point to be borne in mind  
 of in all such cases is that chemistry, steam, geology, some  
 of branches of physics, and mechanical drawing should form a  
 of part of the education of every mining student. With refer-  
 of ence to local teachers, a word may be necessary. There  
 of is a good reason why many districts to patronise  
 of technical schools, and should always be borne in mind that the  
 of of the main part of necessity by the man who will do best. In the  
 of of literature of practical science, it ought to be a guiding principle  
 of at the best to be given by advertisement and good  
 of care, and in every way be advanced.

The Government Technical Education Committees  
 of have expressed their views on Derbyshire. In connection  
 of with the subject of rural continuation schools, we read:

"The Committee are of the opinion that one of the great difficulties  
 of which the ordinary rural evening classes in receiving instruction  
 of in every kind of technical education is the lack of sufficient pre-  
 of liminary knowledge. Hence, in every school education has  
 of very largely failed, ways of remedying being continued to  
 of the point of giving easy courses of the scientific principles and  
 of of them. This is a course of expenditure on the part of the  
 of elementary education which is not wanted without some  
 of compensatory change by which the instruction given shall be  
 of of a more advanced nature, and sufficient enough to grasp  
 of the principle. This part of the work is done in a nutshell  
 of in the average boy leaves the elementary school, at about  
 of thirteen years of age, he is not allowed to be completed, with  
 of the result that he has to interfere with evening schools or classes  
 of of any educational value. Committee can not hope to attract  
 of of any of the working lad into evening continuation schools,

however diversified their prospectuses may be. Only here and  
 of there can pupils be found who have begun to see the depths  
 of of their ignorance, but these are the minds to nurture, and for  
 of their benefit systems of evening-classes should be constructed.

Before the era of the County Councils, the principal means for  
 of the spread of instruction in elementary science was undoubtedly  
 of the classes of the Science and Art Department. Testimony is  
 of borne to this in the report referred to. We read:

"It has been the custom in many educational quarters to  
 of criticise and condemn the methods of that Department, and to  
 of create an impression that but little good has been accomplished.  
 of The contrary of this is undoubtedly the case. In all manu-  
 of facturing centres it will be found that there are numbers of  
 of persons applying to every kind of industry scientific principles and  
 of knowledge gained at Science and Art Classes, and which could  
 of not have been gained anywhere else during the last thirty-five  
 of years." The Department is very well able to take care of itself,  
 of but this statement of fact may be profitably considered by those  
 of who disparage its usefulness.

If there is one thing our educational system lacks more  
 of than another, it is proper facilities for secondary education.  
 of Recognising that a good education in a secondary school is  
 of the only means by which the highest branches of technical  
 of instruction could be approached, the Derbyshire Committee  
 of offered for competition sixty scholarships tenable at secondary  
 of schools. After the awards had been made, it was found that  
 of only six out of the sixty successful candidates chose schools in  
 of the county, and that there was only one school in the adminis-  
 of trative county available for the girls who had won scholarships.  
 of An inspection of the Grammar Schools, and similar institutions  
 of in the county, with a view to determining their educational  
 of conditions and needs, revealed a general want of proper equip-  
 of ment; indeed, only one out of nine secondary schools had a  
 of chemical laboratory. Derbyshire is certainly not alone in this  
 of deplorable state of things, which it will take some years to im-  
 of prove. The fact that the defects in our educational system are  
 of being exposed, and that attempts are being made to meet them  
 of fairly, is a clear promise of progress. If the Technical In-  
 of struction Committees had done no more than reveal the in-  
 of efficiency and insufficiency of scientific instruction in the counties  
 of of England, they would have furthered the interests of science.  
 of But as they have also helped to organise and increase the  
 of facilities for such instruction, they have worked in no mean way  
 of for the extension of natural knowledge. Encouragement and  
 of friendly guidance is all that is required to render the work even  
 of more valuable in the future than it has been in the past.

R. A. GREGORY.

### SCIENCE IN THE MAGAZINES.

FIRST in importance among the contributions to the February  
 of magazines is a collection of opinions on forest preserva-  
 of tion, published in the *Century*. In response to a request from  
 of the editor of that magazine, a number of persons interested in  
 of arboriculture sent their views as to the general need of a  
 of thorough, scientific, and permanent system of forest manage-  
 of ment in the United States, and specifically as to the plan  
 of suggested by Prof. C. S. Sargent, which comprised the follow-  
 of ing features:

(1) Forestry instruction at West Point; the establishment of  
 of a chair of Forestry at the United States Military Academy, to  
 of be supplemented by practical study in the woods and by per-  
 of sonal inspection of foreign systems of forestry.

(2) An experimental forest reservation; the purchase on the  
 of Highlands near West Point, or elsewhere, of a small territory  
 of for the use of the proposed new branch of instruction.

(3) Control by educated officers; the assignment of the best  
 of educated of these officers to the supervision of the forest  
 of reservations.

(4) The enlistment of a forest guard; a body of local  
 of foresters, to be specially enlisted for the purpose of carrying  
 of out the principles of forestry thus taught.

The experts consulted agree in the opinion that the United  
 of States needs a thoroughly scientific and permanent system of  
 of forest management in the interests of the people of to-day, and  
 of of future generations. But the general feeling seems to be that  
 of the management of the forests should not be placed under any  
 of military organisation. As to the suggestion to increase the  
 of curriculum of the U.S. Military Academy so as to cover

instruction in forestry, it is rightly pointed out that a course in forestry which is merely an adjunct to a military education must fail to produce the highest efficiency as foresters in the officers who take it. "Adequate training in so large a subject," is remarked by one of the correspondents, "can be reached only by long and undivided attention." And further, as Prof. Cleveland Abbe says, "the arts of warfare are a special application of the arts of peace, and it is a perversion of the military school to make it a rival of the civilian schools of engineering, chemistry, forestry, &c." The general opinion appears to be that for the preservation and management of forest-reservations, a permanent body of foresters is required, but it should be composed of practical woodmen who have devoted some years to the study of forestry. If we may express an opinion upon the matter, to us this seems the only view which can have any support from scientific men. To make forestry a subsidiary branch of a military education, would be to establish scant provision for the science. If merely the protection of forest-reservation be aimed at, Prof. Sargent's plan probably offers the easiest way of obtaining it; but if the forests are to be developed, a forest-school, where foresters can be scientifically trained, becomes essential.

Another contribution to the *Century* is the sad story of the death of Emin Pasha, told by Mr. R. Dorsey Mohun, the United States agent in the Congo Free State. In April of last year, Mr. Mohun arrested and took the confessions of the two Arab slaves, named Ismailia and Mamba, who had killed Emin. The following is a brief statement of the melancholy facts:—In the Unyoro country, to the west of the Victoria River, Emin came upon an Arab camp, under the command of Said ben Abedi. He expressed his intention of making his way to Kibonge, about eighty miles south of Stanley Falls, and it was arranged that his force, numbering about 150 people, and Said's, should travel together. On October 5, 1892, Emin and Said arrived at the small village of Kinena, which lies 150 miles to the north-east of Kibonge. Said then went on to inform the Kibonge chief that the white man was coming, Ismailia and Mamba going with him. About twenty days later, Mamba returned with a letter to Emin, saying that safe conduct to Kibonge should be given; but the Kibonge chief sent another letter to the Kinena chief by Ismailia, containing instructions to kill Emin. The Pasha was induced to send his men into the plantations on a pretext, and while they were away he was murdered, and his head sent to Kibonge. This appears to have occurred on the morning of October 28, 1892. Emin's head was sent by Kibonge to Munie-Mohara at Nyangwe, the reason being, Mr. Mohun thinks, that Kibonge wished to show that he could kill a white man as well as Munie-Mohara, who had ordered the destruction of Hodister's expedition five months previously. "Not the slightest suspicion," says Mr. Mohun, "attaches to Said ben Abedi of having had any connection with Emin Pasha's death, which is regarded by the Arabs with whom I have talked as a stupid error on the part of Kibonge, who committed the crime simply to place himself on the same level as Munie-Mohara, who had killed Hodister. I do not believe, either, that Tippoo Tib had any hand in the crime, which must have been as great a surprise to him and to his son, Sefu, and his nephew, Rachid, who was the Governor of Stanley Falls, as it was to us." An article on "New Weapons of the United States Army," also in the *Century*, and the eighteen pictures and diagrams which illustrate it, will interest many of our readers.

Dr. Charles L. Dana writes on "Giants and Giantism," in *Scientific American*. Two years ago a man nearly seven feet in height, possessing very large feet, hands and head, came under his notice, and was found to be a victim of the peculiar disease known as acromegaly. The man died from the effects of his disease, and a portion of the brain—the pituitary body—was then found to be enlarged to many times its original size. This gave support to the idea that enlargement of the pituitary body is the cause of the gigantic growth of the extremities in acromegaly, and that giants generally are not simply freaks, but victims of a nervous disorder. The skeleton of the famous Irish giant was studied some time ago by Prof. Cunningham, and found to be characteristic of a case of acromegaly, and an examination of photographs of nearly all the living giants now on exhibition leads Dr. Dana to believe that about one half of them are acromegalics. According to Dr. Dana, "extraordinary size is a disease, a neurosis of nutrition, rather than a chance disturbance of development. . . . It is possible by certain kinds

of gland-feeding, to increase the stature of dwarfed persons very rapidly. There is, for example, a gland called the thyroid body lying in the neck, the juice of which, when fed to certain kinds of dwarfs (cochias) causes them to grow. Experiments in feeding animals and men with the pituitary body are now in progress."

"The Method of Organic Evolution" is expounded by Dr. A. R. Wallace in the *Fortnightly*, the article being really a critical and adverse review of Mr. Bateson's views on discontinuous variation, as set forth in "Materials for the Study of Variation." A second article on discontinuity in evolution, dealing with the theories advanced by Mr. Galton, will appear in a future number.

A posthumous essay, by Dr. G. J. Romanes, entitled "Longevity and Death," appears in the current number of *The Month*, to which it was sent by Prof. C. Lloyd Morgan. In it an unpublished essay, written in 1875, is quoted, in which occur the following passages:—

"Those species whose ancestral types have frequently been required to vary would have gained much during the history of their descent, by having their constituent individuals short-lived; for in this way a comparatively great number of opportunities would have been afforded for the requisite variation to arise: in other words, a comparatively great number of variations would have occurred in a given time. Hence it seems natural to infer that it is in the power of Natural Selection to affect the *curtailment* of individual life, wherever such curtailment would be of advantage to the species, that is to say, wherever *flexibility* of type is required. Of course, length of life is not the only factor which determines flexibility of type. There are at least three other such factors: (1) the period at which puberty sets in, (2) the number of times the individual breeds during its life-time, and (3) the number of young which it bears at each time of breeding. Nevertheless, it is true that the length of life is a highly important factor. Because, if the individual is short-lived, it becomes a necessary condition to the continuance of the species that parturition should be frequent. Or, more generally, there must be more or less of a direct proportion between the potential longevity of every species and the frequency of parturitions characteristic of that species—if not also of the number of offspring in each. Now, as Mr. Lankester has pointed out, there is, as a matter of fact, a highly remarkable correlation between potential longevity in the individual and frequency of parturition, as well as of numbers constituting the litter which are distinctive of the species. This correlation he attributes to generative expenditure acting directly to the curtailment of life; but in holding this view, I suspect that he is mistaking cause for effect. I do not think it is generative expenditure which causes curtailment of life, but that it is curtailment of life by Natural Selection which causes the high generative expenditure within the lessened period. It is as though all the conditions needed to secure flexibility of type were adaptively associated in these species which have survived in a comparatively fluctuating environment. Moreover, it is worth observing that all the organisms to which Mr. Lankester ascribes a practically unlimited potentiality of life, are organisms which, as far as we can judge, must always have been exposed to uniform conditions of life."

In addition to this, *The Month* contains an article by Dr. E. Montgomery, who attempts "first to gain a scientifically justified and logically consistent physical basis, upon which a naturalistic conception of vitality can be reared; and then, to show to what special physical conditions vital activities and vital organizations owe their existence." We also notice a metaphysical paper on "The Natural Storage of Energy," by Mr. Lester F. Ward.

Pascal is the subject of a paper, by the late Mr. Walter Pater, in the *Contemporary*, but his scientific researches are not dealt with. Towards the end of the notice, there is a note on the influence of imagination on his work. It is: "Hidden under the apparent exactness of his favourite studies, imagination, even in them, played a large part. Physics, mathematics, were with him largely matters of intuition, anticipation, precocious discovery, short-cuts, superb guessing. It was the inventive element in his work and his way of putting things that surprised those best able to judge. He might have discovered the mathematical sciences for himself, it is alleged, had his father, as he once had a mind to do, withheld him from instruction in them." A bright and sensible paper on "Nervous Diseases and Modern

life" is contributed to the same review by Prof. Clifford Allbutt. There is also a paper of interest to physical geographers, the title being "The Evolution of Canies."

The current quarterly *Review* has among its articles a sketch of the history of the Ordnance Survey, wherein we read "the scope of the undertaking exceeds any programme heretofore compelled by any Government, the mode and style of its execution are second to none, either from a scientific, artistic, or human point of view, and the cost of the work, stroke for stroke, is probably lower than that paid by any other nation for a similar purpose." Prof. Huxley's collected essays, and other works, are reviewed under the title "Prof. Huxley's read," and in the article "England in Egypt," the irrigation of Egypt, and the construction of the Phara dam, are noticed.

The *Illustrator and Illustrated London News* is rich in good illustrations. Among the articles we notice an account of the ploration of a Hunnish cemetery at Czka, near Buda-Pesth, where a number of skeletons have been found, and a complete skeleton of a woman, six feet three inches in length. Weapons, trumps, earthenware vessels, and various ornaments have also been found. "The Barring of the Chivie," a ceremony still carried out on the 1st night of the old year at Burghhead, in the north of Scotland, is described by Mr. H. W. Young. The custom appears to have come down from the most remote ages. The natives of Burghhead assert that it is a Druidical worship, while Mr. Young believes it to be simply a revival of the worship of Baal, a remnant of that great fire worship which prevailed over the whole world as known to the ancients.

The notes in an illustration of the ancient Egyptian tomb in the valley of Elphaytina, discovered and explored by H. R. Hall, the Crown Princess of Sweden and Norway, and an illustrated description of the re-erection of those interesting pre-historic monuments, the Dartmoor menhirs. Recent investigations have yielded some evidence which connects these stone-rows with the Neolithic period.

A passing notice must suffice for the remaining articles on scientific subjects in the magazines received by us. *Good Words* contains Sir Robert Ball's concluding paper on "Sir Isaac Newton," and a brief paper "On the Anti-toxin Cure for Cholera," by Dr. W. J. Fleming. A visit to the tomb at Aswan, where the jewels of an Egyptian princess of the Twelfth Dynasty were found last year, is described by Mrs. E. M. Stacey in the *Nationalist*. "The Humanitarian has an article on "The Prevalence of Nervous Diseases," by Dr. S. J. Parsons. "Some Curiosities of Modern Photography" are brought together by Mr. W. G. FitzGerald in the *Strait Times*.

The illustration he gives of an image photographed through the eye of a beetle is, however, quite eclipsed by a photograph taken by Dr. Satta through the lenses of the eye of a water bug, and reproduced in *Knowledge* for January 1904. Mr. Grant Allen concludes a rhapsody on the *English Illustrated Chamber's Journal* contains a list of some of the readable articles on scientific topics.

UNIVERSITY AND EDUCATIONAL INTELLIGENCE.

The University Congregation held on Tuesday, February 13, 1895, an amendment to the proposed Statute on Research Degrees, came under consideration. There were sixty-three amendments, and sixty-seven amendments came under consideration, as the length of some of them were of some length. The first amendment, proposed by the Provost of Oriel, and seconded by Prof. Osborn, and Mr. Strachan Davidson, proposed that the Degree of Bachelor of Arts should be substituted for the proposed Degree of Bachelor of Letters and Bachelor of Science. After a prolonged debate the amendment was negatived by 137 votes against 33.

An amendment by Prof. Osborn, defining "Science" as including Mathematics, Natural Science, Mental and Moral Science, was carried by 137 votes against 34. An amendment, proposed by Mr. C. Conway, of Trinity College, and seconded by Mr. Burne, provided that the appointment of the candidates for Research Degrees should be vested in the Boards of Faculties, instead of in a special Delegation, as proposed by the Statute under consideration. This amendment was carried by 110 votes against 49. Another amendment, by Prof. Holland, which proposed that candidates for Research Degrees, not being already Graduates of the University, should have obtained a degree in some other University, was rejected by 107 votes

against 39. The other amendments were either consequential on those already mentioned, or were of a formal character. The further consideration of the amendments was fixed for Thursday, February 21.

CAMBRIDGE.—The Sedgwick Prize in Geology has been awarded to Mr. Henry Woods, of St. John's College, Demonstrator in Palaeontology. The subject proposed for the prize of 1895 is "The Glacial Deposits of East Anglia." The essays are to be sent to the Registry by October 1, 1897. Candidates must be Graduates of the University who have resided sixty days during the preceding twelve months.

Mr. M. Laurie, of King's College, has been appointed by the Special Board for Biology and Geology, to occupy the University's table in the Naples Zoological Station, for three months from March 1.

A course of lectures in Anthropology, with practical work, is announced by Prof. Macalister for the Lent and Easter Terms. The lecturer is Prof. A. C. Haddon, of the Royal College of Science, Dublin. The subject of the first lecture, on February 14, at 3.30, is "The Methods of Anthropology."

The degree of Sc.D. *honoris causa* is to be conferred on Sir William MacGregor, Administrator of British New Guinea, in recognition of his able contributions to anthropology and ethnography.

The following appointments of electors to Professorships in Natural Science and Medicine are announced. Chemistry, Dr. T. E. Thorpe; Plumian of Astronomy, Dr. A. R. Forsyth, and Mr. W. H. M. Christie, Astronomer Royal; Anatomy, Dr. Allbutt; Bantyn, Mr. A. Sedgwick; Geology, Prof. Newton; Jacksonian of Natural Philosophy, Lord Rayleigh; Downing of Medicine, Dr. A. Macalister; Mineralogy, Prof. J. J. Thomson; Zoology, Dr. D. Macalister; Cavendish of Physics, Lord Rayleigh; Mechanism, Prof. Osborne Reynolds; Physiology, Mr. J. N. Langley; Surgery, Dr. A. Macalister; Pathology, Dr. Osbald.

A grant of £50 from the Worts Travelling Scholars Fund has been made to Mr. P. Lake, of St. John's College, for the purpose of investigating the distribution of Filibites in Russia and Sweden.

A PARLIAMENTARY PAPER dealing with the moneys received by the Councils of Counties and County Boroughs in England and Wales under the Local Taxation (Customs and Excise) Act, 1895, and available for technical education, has just been published. The following summary shows how the moneys have been expended:—

	Counties, Other than London and County Boroughs.	County of London.	Total.
Aggregate amount received up to March 31, 1894	2,439,319	687,034	3,126,353
Aggregate amount expended on—			
(a) Technical and Intermediate Education ...	1,481,712	27,249	1,508,958
(b) Purposes other than Technical and Intermediate Education ...	299,508	600,034	899,542
Aggregate amount appropriated to Technical and Intermediate Education, but remaining unexpended at the date of the Returns ...	635,033	59,754	694,687
Residue not appropriated for Technical and Intermediate Education, but remaining unexpended at the date of the Returns ...	131,166		131,166
	2,439,319	687,034	3,126,353

1 £6700 of this amount had been appropriated to County buildings and museum.

Seventy-one out of the 126 Councils had expended on, or appropriated to, Technical or Intermediate Education the whole of the moneys they had received from the residue of the Beer and Spirit Duties.

## SOCIETIES AND ACADEMIES.

LONDON.

**Physical Society, February 8.**—Annual General Meeting.—The chair was taken by the retiring President, Prof. Rucker. —The Treasurer, Dr. Atkinson, presented his report for the year 1894. The balance-sheet showed a somewhat larger expenditure than in previous years, the increase being partly due to the new system of publishing abstracts, partly to the rent of rooms and the expenses of tea. The balance in the bank had increased by about £33 during the year; but the Treasurer said that, strictly speaking, the Society had trenched on its capital to the extent of about £30, and that this would probably be the last report for some time to come which would show a balance in favour of the Society. The assets of the Society exceeded its liabilities by £2642 or 5*l*. Prof. Carey Foster asked whether it would not be possible, in estimating the assets of the Society, to make some allowance for the stock in hand. Dr. Atkinson replied that that had not hitherto been done, and the difficulty would be to assign a money value to the stock. The stock of the works of Joule, and of other memoirs, was of course decreasing, while the sale of the *Proceedings* was becoming somewhat greater. As regarded the securities of the Society, their actual value would be about £200 or £300 more than appeared on the balance-sheet. Prof. Rucker said that the Society had deliberately entered upon a policy of expansion, and that they must be prepared to find the expenditure increasing. On the other hand, it was hoped that by making the Society more attractive, a greater number of persons would be induced to join. In view of the great advantages now enjoyed by members, there had been some suggestion of raising the subscription; but, in any case, he thought that they might look forward to the future with confidence. The report was then moved and adopted.—The next business was the election of Officers and Council for the year 1895-6, and Messrs. Rhodes and Yule, being asked to act as scrutators, collected the balloting lists.—Prof. Carey Foster proposed a vote of thanks to the Lords of the Committee of the Council on Education, for having allowed the Society to meet at the Royal College of Science. At the commencement of the life of the Society, its founder and first President, Guthrie, had obtained permission for the meetings to take place at South Kensington, and the Society had continued to meet there until their recent migration to the rooms of the Chemical Society. The vote of thanks was duly seconded and was carried unanimously. Major-General Festing then proposed, and Mr. Croft seconded, a vote of thanks to the auditors, Messrs. Inwards and Trotter. This also was carried. Mr. Trotter then proposed a vote of thanks to the retiring Council; they had shown an energy which was rare in such societies, and had inaugurated an active and original policy, which must prove of the greatest benefit to the Physical Society and to physical science generally. Carried unanimously.—Mr. Elder gave notice of a proposed alteration of the rules, the object being to allow the Council under certain conditions to admit persons into the Society without requiring from them the usual number of recommendations from members. It was pointed out that sometimes eligible persons, especially those resident abroad, were unable to enter the Society because they were unknown to any of the existing members. The motion to sanction the proposed alteration was put from the chair and carried, but this decision will need to be confirmed at a subsequent meeting, of which due notice will be given.—Mr. Rhodes then read the following list of the Officers and Council elected for the year 1895-6: President, Capt. Abney. Vice-Presidents who have filled the office of President: Dr. Gladstone, Profs. Carey Foster and Adams, Lord Kelvin, Profs. Clifford, Reinold, Ayrton, Fitzgerald, Rucker. Vice-Presidents: Mr. W. Baily, Major-General Festing, Prof. Perry, Dr. Stoney. Secretaries: Messrs. Blakesley and Elder. Treasurer: Dr. Atkinson. Demonstrator: Prof. Blys. Other members of Council: Mr. Shelford Bidwell, Mr. W. Crookes, Messrs. Fletcher, Glazebrook, G. Griffiths, Profs. Hearici, Minchin, Mr. Swinburne, Profs. S. P. Thompson and S. Young.—Prof.

Rucker then vacated the chair in favour of Captain Abney, and the meeting being resolved into an ordinary meeting, Mr. W. B. Croft gave "an exhibition of simple apparatus." An optical bench was shown which consisted of a woollen lath of rectangular section, furnished with a millimetre scale, and clamped on to the table, together with three flat woollen blocks, whose contacts with the table and the lath left them only free to slide in a direction parallel to the scale. Another apparatus was designed for observing anomalous dispersion. A cork supported two rectangular pieces of microscope cover-glass, which were inclined at a small angle to one another; and a drop or two of a strong alcoholic solution of fuchsine being introduced between them was maintained in position by capillary action. Photographs were shown of Chladni's sand-figures, some of the forms being of an unusual character. Mr. Croft also exhibited a polariscope in which the polariser was a thin piece of glass stuck on to cork by means of black sealing-wax, and the analyser a plate of tourmaline; as well as a miniature model of Grove's gas battery. Photographs of some curious optical phenomena were projected on the screen, including 12-rayed stars seen on looking at a bright source of light through certain specimens of mica, and pairs of intersecting or non-intersecting circles of light, obtained under similar circumstances with (doubly refracting) fibrous calcite. These last, it was suggested, were similar in origin to the curves obtained by reflection at, or transmission through, a diffraction-grating held obliquely. Clock-springs broken by frost were also exhibited, each spring having given way in a very great number of places simultaneously. Dr. Johnstone Stoney said that many years ago he had published in the *Transactions* of the Royal Irish Academy an investigation of the circles seen in fibrous calcite, and had shown geometrically that they had nothing to do with the regularity of the fibrous structure, but were due to reflection and refraction within the crystalline plate. The distribution of the planes of polarisation round the circumferences of the circles was also accounted for by his investigations. Mr. Price said he had found that when a clock-spring during the process of hardening was kept in shape by wires, subsequent fracture was most apt to occur at those places where the wires had been in contact with the spring.—Mr. Rhodes asked if Mr. Croft had ever tried Newton's experiment of admitting sunlight between two sharp edges inclined at a small angle to one another. He had not been able to obtain the hyperbolic bands described by Newton. Mr. Croft said he had not tried the experiment exactly in that form. Captain Abney said that this experiment had succeeded very well in his hands.—Mr. S. Skinner read a paper on the tin chromic chloride cell. He said that his attention had been attracted to the cell by an account published by Mr. Case, of New York. The cell had been stated to give no E.M.F. at ordinary room-temperatures, while it gave a considerable E.M.F. at 100° C. The author had found that when the cell was directly connected up to a galvanometer, there was no current at ordinary temperatures, and some current at 100° C.; but when he had measured the E.M.F. by Poggendorff's method, he had found 74 volt at 15° C. and 40 volt at 97° C. The cell as originally described consists of a tin plate and a platinum plate immersed side by side in a solution of chromic chloride; when the temperature of the cell is near to 100° C., and the poles are connected, the following reaction occurs:—

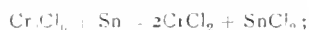

and when the poles are disconnected and the cell cooled, the reverse change takes place. The author prefers to use as electro-positive metal an amalgam of tin and mercury instead of a tin plate, so that when the tin precipitated during cooling falls to the bottom of the solution, it is redissolved in the mercury, and the cell has regained its original state. When silver nitrate solution is added to chromic chloride, only two thirds of the chlorine comes down as silver chloride, and this has led the author to suppose that the proper formula for chromic chloride is  $\text{CrCl}_2\text{Cl}$ . Hence he works out the electrolytic action by means of a Grotthus chain. Prof. Rucker asked whether a change of polarisation would explain the behaviour of a cell at different temperatures. Prof. Carey Foster asked whether the reversed chemical action on cooling from a high temperature were accompanied by a reversed E.M.F. Mr. Skinner said no. The tin was precipitated throughout the solution, and not at the surface of the tin plate, so that no E.M.F. of the kind was to be expected. Mr. Appleyard thought that Prof. Minchin had used tin chloride cells with two tin plates for electrodes, the

s only working when one plate was illuminated. Mr. ... otherwise it is known whether having the cells supplied energy ... or simply removed an obstacle in the form of polarisation. Mr. Skaner thought that heating acted by removing an ... Capitan Abney: And so ...

PARIS.

Academy of Sciences, February 1. M. Niry in the ... The proceedings were commenced by the announcement of the death of Prof. Arthur Cayley, correspondent of the ... M. Henne then gave a short ... of the scientific work of the great mathematician. On ... a new constituent of the atmosphere, discovered by Lord ... and Prof. Ramsay. An abstract by M. Berthelot of ... that has already appeared in these columns. He concludes ... the observation that, although argon has no action on the ... higher animals, it can not be concluded that bacteria may not be ... affected by it, for it is known that they absorb nitrogen. The ... suggestion is made that nitrogen obtained from the total ... destruction of animal or vegetable matter should be examined ... argon. On abelian functions, by M. H. Poincaré. —Proellers with tangential penetration, by M. Guyou. A description ... of a model of a new type of propeller. —The present state ... investigations on the vegetation of French colonies and pro ... trates, by M. Ed. Bureau. On a passage of the shadow of ... Jupiter's fourth satellite, by M. J. J. Landerer. The calculated ... time of half a passage is 27m. 9s.; observation gives the time as ... 30s. —Solar observations made at Lyons Observatory ... during the fourth quarter of 1894, by M. J. Guillaume. There ... appears to have been a general decrease of spots and faculae ... since the first quarter of 1893. —On continuous straight ... beams rigidly connected with their supports, by M. Eugene ... —On the nature of the "displacement current," of Max ... well, by M. Vaschy. A mathematical paper in which the author ... shows that certain properties admitted by Maxwell as hypotheses ... are mathematically exact, and may be deduced from his theory.

On the anomalous rotatory dispersion of crystallised absorbent ... media, by M. G. Moreau. —On Fresnel's biprism, by M. ... Georges Meslin. —Influence of low temperatures on the attractive ... power of artificial permanent magnets, by M. Raoul ... —The tabulated mean results of four sets of experiments, ... agreeing well together, show a continuously increasing attractive ... power as the temperature becomes lower. The range of ... temperature in these experiments was from 30 to 105°. —Mordant ... derivatives of hexamethyltrinitrophenylmethane, by M. A. Rosenstiehl. Methyl iodide forms with ... the complex triamines A<sub>3</sub>CR where A represents ... (CH<sub>3</sub>, N<sub>2</sub>C<sub>2</sub>H<sub>5</sub>), and R indicates an electropositive radical ... such as H, OH, or OCH<sub>3</sub>; two series of colourless combina ... compounds of this class exchange the radical R for an acid ... radical, and form colouring matters. (1) The second series, ... formed by the addition of three molecules of methyl iodide, ... contains three pentavalent nitrogen atoms. Colouring matters ... are not formed in this case, as the radical R cannot be ex ... changed for an acid radical. —On laccase and the oxidising ... power of this diastase, by M. G. Bertrand. —Reactions of ... chelidonic with the phenols in sulphuric solution, by M. ... —With a drop of gnaicol dissolved in 0.5 c.c. of ... concentrated sulphuric acid, chelidonic moistened and exposed ... to the air gives a fine carmine colouration. A list of colour ... reactions with other phenols is given. —On the development of ... the body in the shrimp *Palaemon serratus*, Latr. and the cray ... fish *Callinectes floridus*, Green H., by M. Louis Roule. —On the ... production of fucoid and mucus among the Melponas, by ... M. J. Perez. —On the influence of climatological conditions on ... the growth of trees, by M. Emile Mer. The author shows ... that the dryness of 1893 caused a diminution in the growth of ... wood in forest trees. A similar effect was produced by the ... excoriant of 1888. —On the reaction in polychroic anoles, ... by M. A. Michel Lévy. When the anoles are well developed, ... and free contours, deeply coloured, the reflection of the pig ... mented part is clearly superior to that of the unmodified sub ... stance. —The difference between the indices of refraction ... may amount to a decimal of the second order. It follows that ... the constitution of the mineral probably modified, as its ... dispersion of optical elastic was different. —On the existence of ... numerous remains of sponges in the *granite* of the Pre ... Cambrian of Brittany, by M. L. Cayrol. Conclusions: (1) ... There exist, at the base of the Precambrian of Brittany,

numerous and varied sponge spicules. 2 Almost all, if not ... all, the orders of sponges with siliceous skeletons are represented at this early epoch. —On the existence of a submarine ... delta in the Upper Cretaceous near Chautilon-en-Diois, by MM. ... G. Sayn and P. Lory.

BOOKS, PAMPHLETS, and SERIALS RECEIVED.

BOOKS.—The Foundations of Belief: A. J. Balfour (Longmans).—Cellulose: Cross and Bevan (Longmans).—Thoughts on Religion: Dr. G. J. Romanes (Longmans).—Elementary Lessons in Electricity and Magnetism: Prof. S. P. Thompson, new edition (Macmillan).—Remarkable Comets: W. J. Lynn, 3rd edition (Stanton).—Varied Occupations in Weaving: L. Walker (Macmillan).—Theoretical Chemistry from the Standpoint of Avogadro's Rule and Thermodynamics: Prof. W. N. Frost, translated by Prof. C. S. Palmer (Macmillan).—Atlas of Classical Antiquities: Th. Schreiber, edited for English Use by Prof. W. C. F. Anderson (Macmillan).—Annuaire de l'Observatoire Royale de Belgique, 1905: F. F. de Bruxelles, Hayez).—Memorial Club Reprints: No. 10, Researches on the Arseniates, Phosphates, and Modifications of Phosphoric Acid: T. Graham (Edinburgh, Clay).—Die Bearbeitung des Glases auf dem Blasenscheide: D. Djakonow and W. Lermantoff (Berlin, Friedländer).—A Treatise on Industrial Photography with Special Application to Electric Lighting: Dr. A. Palaz, translated by G. W. and M. R. Patterson (Low).—Bulletin of the U.S. Fish Commission, Vol. xii. (Washington).—Chemical Laboratory Labels, Part 2: W. H. Symms (Gallenkaempff).—Brasilische Pflanzenwelt: A. Müller (Jena, Fischer).—Elliott Brothers' Catalogue: No. 114 (Elliott).—A Fisherman's Lancies: F. B. Doyet (Stock).—Calendar of the Department of Science and Art, 1895 (Exyre and Spottiswoode).

PAMPHLETS.—On the Present Relations of Agricultural Art and Natural Science: Prof. R. Warrington (Frowde).—Bibliography of Aceto Acetic Ester and Its Derivatives: P. H. Seymour (Washington).—Geology of the Boston Basin: W. G. Crosby, Vol. 1, Part 2 (Boston).—North American Bows, Arrows, and Quivers: O. T. Mason (Washington).—Quelques Aperçus sur l'Économie des Forêts: C. Heary (Paris, Nony).

SERIALS.—Quarterly Journal of the Geological Society, Vol. li, Part 1, No. 201 (Longman).—Transactions of the English Arboricultural Society, Vol. 3, Part 1 (Carlisle).—Psychologische Arbeiten, Erster Band, 1 Heft (Göpping, Engelmann).—American Journal of Mathematics, Vol. xvii, No. 1 (Baltimore).—Bulletin of the American Mathematical Society, January (New York, Macmillan).—Bulletin de la Société Impériale des Naturalistes de Moscou, 1894, No. 1 (Moscow).—Proceedings of the Physical Society of London, Vol. xii, Part 3 (Taylor and Francis).—Proceedings of the Academy of Natural Sciences of Philadelphia, 1894, Part 2 (Philadelphia).—Bulletin of the Buffalo Society of Natural Sciences, Vol. 9, No. 4 (Buffalo).—Bulletin de l'Académie Impériale des Sciences de St. Pétersbourg, January (St. Pétersbourg).—U.S. Department of Agriculture (Division of Chemistry), Bulletins Nos. 41-43 (Washington).—Proceedings of the Boston Society of Natural History, Vol. xxxi, Parts 2 and 3 (Boston).—American Journal of Science, February (New Haven).—Medical Magazine, February (Strand).—Journal of the Academy of Natural Sciences of Philadelphia, 2nd series, Vol. 3, Part 2 (Philadelphia).—Strand Magazine, February (Newnes).—Strand Medical Magazine, February (Newnes).—Picture Magazine, February (Newnes).—Science Progress, February (Scientific Press, Ltd.).—Bulletin of the Geological Institution of the University of Upsala, Vol. 1, Nos. 1 and 2 (Upsala).

CONTENTS.

PAGE

Electric Oscillations. By Prof. A. Gray . . . . . 361
The Book of the Rose. By W. . . . . 362
Our Book Shelf:—
Wagner: "L'Industrie des Aracéna." (Illustrated). R. I. P. . . . . 363
Hewitt: "Elementary Practical Chemistry, Inorganic and Organic" . . . . . 364
Murray: "How to Live in Tropical Africa" . . . . . 364
Letters to the Editor:—
The Liquefaction of Gases.—M. M. Pattison Muir; Prof. James Dewar, F.R.S. . . . . 364
Vertebrate Segmentation.—P. Chalmers Mitchell . . . . . 367
The Black-veined White Butterfly. W. Warde Fowler . . . . . 367
Parrots in the Philippine Islands.—Prof. Alfred Newton, F.R.S. . . . . 367
Twenty-five Years of Geological Progress in Britain. By Sir Archibald Geikie, F.R.S. . . . . 367
Notes . . . . . 370
Our Astronomical Column:—
The Mass of the Asteroids . . . . . 373
The Apparent Diameters of Mercury . . . . . 373
The Variation of Latitude . . . . . 373
The Sun's Place in Nature. I. (Illustrated.) By J. Norman Lockyer, C.B., F.R.S. . . . . 374
The Institution of Mechanical Engineers. . . . . 377
The Advance of Technical Education. By R. A. Grezory . . . . . 379
Science in the Magazines . . . . . 380
University and Educational Intelligence . . . . . 382
Societies and Societies . . . . . 383
Books, Pamphlets, and Serials Received . . . . . 384

THURSDAY, FEBRUARY 21, 1895.

SIR ANDREW CROMBIE RAMSAY.

*Memoir of Sir Andrew Crombie Ramsay.* By Sir Archibald Geikie. (London: Macmillan and Co., 1895.)

THE memoir of Sir Andrew Crombie Ramsay, by Sir Archibald Geikie, is a valuable addition to literature and to science. We will refer our readers to the book itself to learn when Sir Andrew was born and when he died: what support the theories of heredity obtain from the scientific tendencies and noble courage of his parents and fore-elders: who were the teachers and friends, and what were the surroundings of his early years: what, in fact, made Ramsay such as we find him in later life—a prominent person in whatever circumstances he was thrown, whether in the small society of a provincial town or in scientific gatherings in London—a welcome guest at every table, a critic whom any author bolstering up wild theories with bad evidence would fear to have to reckon with. “Of an eminently social temperament, he made acquaintances easily wherever he went, and these chance acquaintanceships sometimes ripened into lifelong friendships. In one family circle we find him reading aloud Shakespeare, or Scottish ballads, or a good novel; in another, he takes part, heart and soul, in singing glees and madrigals: in a third, he joins in dancing and all kinds of merriment.” “English literature was to him a vast and exhaustless garden, full of alleys green and sunny arbours, where from boyhood he had been wont to spend many a delightful hour. When he found among his colleagues one whose talk was not always of stones, but who had ranged like himself far and wide in literary fields, he opened out his inner soul, and his conversation glowed with an animation and power, as well as a gleeful exuberance, which astonished and charmed his companion.” And “though he was not in any sense an antiquary, he knew a good deal about the history of architecture, and took a keen delight in visiting ruins and trying to form a mental picture of what they must have been before the gnawing tooth of time had dismantled them. Whatever, indeed, linked him with the past had a charm for him. He never willingly missed an opportunity of seeing a ruined castle or keep, a mouldering abbey, a grass-grown encampment, or a lonely cairn. If tradition or song invested any spot with a living interest, he would not consider his geological inspection complete if it had not included a visit to that site.” With his quick sympathy and conversational powers, with his wide knowledge of nature, as well as of history and her monuments, no wonder that he was welcome in any society of intelligence and culture. He would unbend in congenial and sympathetic company, like a strong man who had been out in the cold and had at last gained a warm fireside, but he always made room for others round the fire. His impulsive and generous nature was, however, tempered with native judgment and caution. He soon gauged the character of those with whom he was thrown, and quickly estimated the amount of receptivity and the temper of an audience.

NO. 1321, VOL. 51]

These qualities and acquirements with a strong and clear memory gave him much wealth of illustration in scientific discussion and in lectures. But his power lay more in the lucid exposition of his subject, the keen insight into the real points at issue, and the clearness with which he brought forward his array of facts and arguments. After one of his lectures at the Royal Institution, Faraday ran up to him, shook him by both hands, and asked “where did you learn to lecture?”

In the memoir will be found an account of his appointment to the chair of Geology at University College, from which he was always spoken of as Prof. Ramsay; also of his lectures there and elsewhere, and of his various other literary work.

In 1841 he was appointed Assistant Geologist on the Government Survey, under Sir Henry De la Beche, and throughout his forty years of service he was more and more identified with all its active work, either as himself taking part in the mapping, or as superintending others, though it was not until he had been appointed Director-General, in succession to Sir Roderick Murchison, that he officially represented the Survey to the public and the Government. An account of his life is therefore the history of the Survey, and no one is more competent than our author to tell the story.

The great difference between the work which has to be done by the Geological Survey and by amateurs is this. The amateur may examine a district in more or less detail, may pick out the points of interest, or the facts which illustrate some theory which he is developing, but, where he sees nothing, he may say nothing about it. The Geological Surveyor, on the other hand, must colour all his map, and sometimes has to put in by inference whole formations of which he has seen nothing whatever.

“He spends the day, map in hand, over the ground assigned to him for survey. Every exposure of rock is noted by him on his map or in his note-book, with all the needful details. Each stream is followed step by step up to its source; each hill-side and ravine is traversed from end to end; each quarry, sometimes each ditch, and even the very furrows and turned-up soil of a ploughed field are scrutinised in turn. . . . He is brought into every variety of scenery, and is compelled by his very duties to study these varieties and make use of them in his daily work.”

But even after all this careful search it often happens that he can find no direct evidence of the solid rocks below the soil and subsoils. He has to plot sections and see what, with the known thicknesses and dips, should be found there. He has to examine the surrounding country to see what occurs in the same relative position elsewhere, and whether any lines of disturbance which might complicate the results are running into the area respecting which, with little evidence, he must make up his mind and say something. The survey work is thus a grand training in the faculty of keeping one's wits about one, and of detecting sources of error. The habit of mind thus formed is often exhibited in the criticism of amateur work by trained survey men, and many can recall Ramsay's indignant protests against impossible or exaggerated sections when appealed to as evidence in support of any view.

He had a wonderful “eye for a country,” to use one of

his own favourite expressions. He rapidly took in the lie and relation to one another of the rock masses. To this any geologist who has worked with him in the field can testify, and this is what lends its value to his classical memoir on the geology of North Wales, and to the maps and sections of which it is explanatory. But when he had sketched out the outlines of the history of the ancient volcanoes of that area, and had noted the choked craters now exposed by the denudation of the overlying masses of lava and cinder and mud, and when he had described the isolated portions of the volcanic and marine deposits which, building up in mountains round the ancient roots of the volcano, still remained the record of great sheets that once spread continuously far and wide over the whole area: when he had done all this, he turned to another aspect of the question, and sought a clear answer to the inquiry how much rock, which we know surely once covered this area, has been removed by denudation? and we find in the same memoir sections illustrating the conclusions at which he had arrived.

For when "he had traced out the structure of a complicated geological region, and was able to show what should have been the form of the surface had it depended on geological structure," he was then "in a position to demonstrate how much material had been removed by denudation," namely, all that was above what he called the *Plan of Marine Denudation*, that is the old base level of ancient erosion, down to which all the agents of waste—rain, rivers, ice, and sea—had reduced the uplifted land: or perhaps, as we should now say, giving greater prominence to subaerial action, to the level at which the sea had arrested the work of the various agents that were reducing all dry lands to sea level.

Few men's work illustrates better than Ramsay's the place and value of a good "working hypothesis" in some kinds of higher scientific research. Imaginative and fertile in suggestion, no one was more sorry when further observations did not clearly support his first impressions, and he tried and tried and tried again to make it fit; yet he bowed always with deference to established evidence and logical consequence.

Besides his regular survey work, which was itself full of new observations and original treatment, and besides many papers giving the results of his researches on special points, he from time to time plunged into more speculative questions, and advanced some theory in explanation of the larger phenomena, especially those connected with surface configuration. For instance, reflecting on the great quantity of fine mud, "flour of rock," carried down by glaciers, and observing that ice was not, like water, restricted in its flow to continuous downward slopes, and holding that ice charged with stones would grind away more rock where the pressure was greater or the rock softer, he propounded the theory of the glacial erosion of rock basins.

This explanation is probably true in some cases, but he gave it a wider application than has been borne out by subsequent investigations.

Unfortunately he adduced as his first example the Lake of Geneva, a basin to which even those who agree with him upon the general probability of there being glacially eroded hollows such as his theory requires, would not now be prepared to apply it.

The public will read with profit and pleasure the biography of such a striking personality by a graceful and accomplished writer, who knew all about the man and his work, and had the skill to select with judgment and the good sense to keep the whole within the modest bounds of one volume of large print. Ramsay's many friends will love to have the record of his struggles and his triumphs, so many of which are told in his own words. Every survey man, not only of Great Britain, but throughout the world, will turn to this account of the commencement and growth of the geological survey of Great Britain, and cannot fail to profit by the insight it gives into the methods, life, difficulties, and results of that important branch of the public service.

So easily does the story run, that we cannot say whether the general reader, or the scientific student, will best appreciate this sketch of the progress of geological research through the most active and interesting half-century of its history.

#### OUR BOOK SHELF.

*Harvard College by an Oxonian.* By George Birkbeck Hill, D.C.L. (London: Macmillan and Co., 1894.)

DR. BIRKBECK HILL spent two months in 1893 in Cambridge, Massachusetts, and has compiled this little volume giving some account of the history of the celebrated college and university of Harvard. So far as Dr. Hill relies upon previous publications, his account is accurate, but his own observations and impressions are—as is very natural—often quite erroneous. Scant justice is done to the important and costly arrangements for the study of the various branches of the natural sciences which exist either at or in connection with the Massachusetts university. Dr. Hill is not fitted by his own education and experience to report on these matters, nor, indeed, can much value be attached to his somewhat antiquated standpoint as a critic or observer of university institutions. He contrasts Oxford and Harvard at every step, but he fails to give any picture or presentation of the real characteristics of the student's life at Harvard. He does not sufficiently emphasise the fact that the undergraduate at Harvard enjoys the immense benefit of true *university* education, at the hands of distinguished professors, with freedom and independence in regard to his choice and method of study, and as to such personal details of life as board and lodging; whereas the Oxford undergraduate is treated throughout his career as a goose to be nursed, monopolised and plucked by college ushers, who (owing to the system under which they are appointed) are, as a rule, as little capable of good teaching as they are of managing the domestic and disciplinary details of the college-boarding-houses. Dr. Hill notes that the rage for athletics is almost as serious an injury to study at Harvard as it is at Oxford. L.

*Tableau Métrique de Logarithmes.* By C. Dumesnil. Paris: Librairie Hachette and Co., 1894.)

THE use of logarithms for calculations is, as every one knows, a great saving of labour and time, and what otherwise would be complicated pieces of work are reduced to simple computations. The facility of working depends, after some time, on the good or bad arrangement of the tables, but instances often occur where much time is lost by having to turn pages backward and forward. For the case of logarithms to five places of decimals, M. Dumesnil has devised a means of eliminating altogether the use of tables, by adopting a series of scales neatly printed on stout sheets. From



these scales the divisions are so arranged that all the logarithms of the numbers from 1 to 10,000 can be easily read off, and *vice versa*. The scales, or tables as they are called, are published in two qualities. The cheaper are neatly and clearly printed, and on a smaller scale than the other; but, on the whole, we recommend the more expensive sheets, as the numbering is more easy to follow (coloured numbers being used), and the divisions are more legible on them.

To understand the method of working the tables is a matter of only a few minutes' attention, and when grasped, either the logarithm of a given number, or the number from a given logarithm, can be read off without the least hesitation. The book of instructions, which is separate from the tables, contains all that the user of the tables can require. The explanations are full and concise, and the worked-out examples will prove an excellent help in acquiring the methods of solution.

*In the Guiana Forest. Studies of Nature in Relation to the Struggle for Life.*

By James Rodway, F.L.S. With an Introduction by Grant Allen. Illustrated. (London: T. Fisher Unwin, 1894.)

WE have read Mr. Rodway's book with a good deal of pleasure. Such a subject as the struggle for existence amongst the animals and plants of the Tropics, could not fail to be full of interest when dealt with by an enthusiastic lover of nature. For it is in the Tropics that nature's principal workshops are situated, and no naturalist can afford, nowadays, to neglect that essential element in a liberal biological education—a visit to these regions. There the struggle for life is no longer, as in our own climates, a cold-blooded process which only a trained eye can follow, but a fiercely active competition for the means of subsistence which is everywhere apparent in every detail of the structure of the individual and of the economy of the species. The "heartless vegetable" amid such surroundings seems no longer a reality, but the cold figment of a northern imagination.

Mr. Rodway describes the vegetation of the forest, the swamp, the sand-reef, and the sea-shore, and each is sketched in vigorous outline. One cannot, however, avoid wishing that the author had been contented to give his impressions of the actual facts, without indulging in metaphysical moralising which is not scientific, and is not always common sense. Occasionally, too, he gives way to great prolixity, as, for instance, in an excursus on the interdependence of animals and plants, which is all very like something we have heard before, only that Mr. Rodway's story is longer. The author is on dangerous ground when he ventures to dip into the philosophy of natural selection, or to deal with problems of variation.

But notwithstanding these defects, the book is worth reading. It is well illustrated, and contains a large amount of really interesting observation which may stimulate the general reader, and which will recall many a half-forgotten scene to those who have themselves been travellers. The accompanying illustration, for which we are indebted to the publisher, shows a silk cotton-tree crowded with epiphytes.

*Lehrbuch der Experimentalphysik.* Von A. Wullner.

Band i. 5te Aufl. (Leipzig: Teubner, 1895.)

STUDENTS who wonder when we are to have an English treatise on experimental physics worthy of comparison with this well known German one (and the French text-books of Jamin and Violle), will find food for reflection in the fact that thirteen years have elapsed since the last edition of Wullner (the fourth) was published. Much the same thing holds good of other German scientific treatises, notwithstanding that publishing firms of repute in the Fatherland do not consider it beneath their dignity to quicken the sale of the remnant of an edition by having notices posted up in the

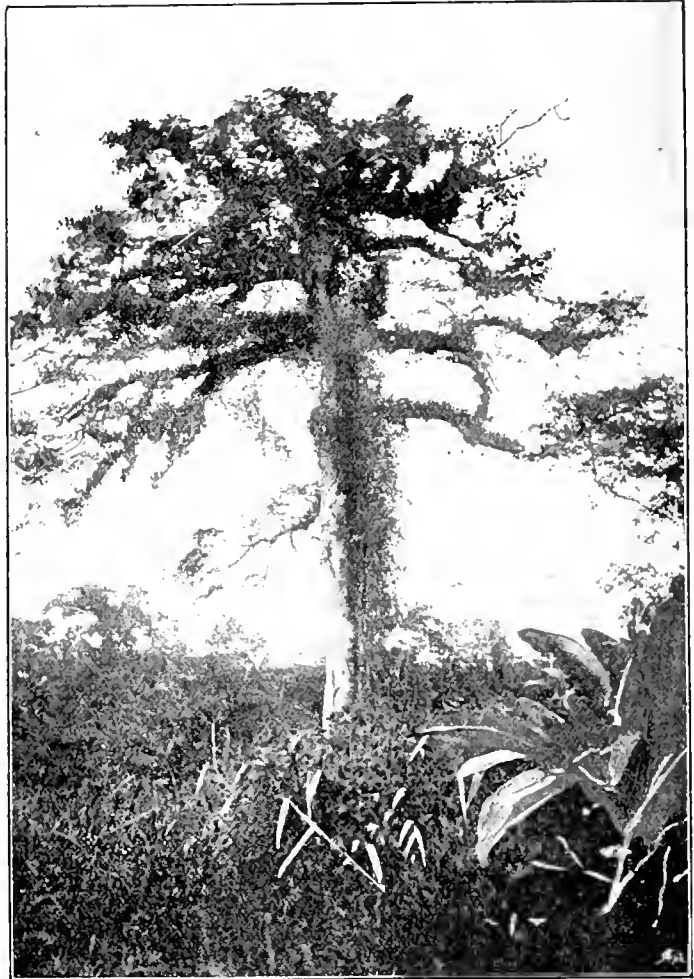

Universities intimating that *bona fide* students of the subject can secure copies at a reduced price by application through the University Professor.

In the present case the interval has been well employed. The first volume has grown to 1000 pages—or 150 more than in the fourth edition—and the most important researches published up to the end of 1892 have been incorporated. In the last edition the article on internal friction contained simply a discussion of torsional vibrations and logarithmic decrement, followed by a page in which mention was made of the researches of Schmidt and others, with a statement of the conclusion arrived at, viz. that in such elastic oscillations the

motion is opposed by an internal resistance or friction which is measured by the logarithmic decrement and is distinct from the elastic after-effect. In the new edition six pages are devoted to Holtzmann's theory of internal friction of solid bodies, according to which the damping of oscillations is regarded as due to the elastic after-effect, the result of which is that the force urging the wire towards its position of equilibrium is not proportional to the displacement. In the fourth edition there was little about "Hardness," beyond a list of the substances forming Moh's scale; indeed, the whole article on the different kinds of *Festigkeit* was rather unsatisfactory. Now the researches of Hertz and the experiments of Auerbach have made it possible to measure the hardness of a substance absolutely and without reference to the properties of any other substance.

Instead of being relegated to the volume on heat, as in some text-books, the kinetic theory of gases is here described at considerable length in the section treating of the properties of gases. This section has been overhauled, and Stefan's theory of gaseous diffusion is given in place of O. E. Meyer's. Prof. Wullner attaches so much importance to recent developments of the electromagnetic theory of light, that he has determined to alter the sequence of the subjects in his treatise, so that light and radiation may come at the end. In the edition now appearing, the second volume will therefore treat of heat, and the third of electricity.

*Peru. Beobachtungen und Studien über das Land und seine Bewohner während eines 25-jährigen Aufenthalts.*  
Von E. W. Middendorf. Berlin: Robert Oppenheim, 1893-94.

DR. MIDDENDORF commences his treatise on Peru by a long preface detailing the circumstances which led him to choose that country for his home. Starting as the surgeon of an Australian emigrant ship from Hamburg in 1854, he narrates the incidents of the voyage, an epidemic of cholera and other irrelevant accidents included, until on the return journey, sick of the sea, he left his vessel in Valparaiso, and after some further wandering took up his residence in Peru, and was led by degrees to pay closer and closer attention to the land and people of his choice.

The work is planned in three parts. The first volume deals nominally with Lima, the capital of the republic, but is really much wider in its scope, commencing with the history of Peru, and after describing the town with its streets and public buildings in somewhat tedious detail, proceeding to discuss the general institutions of the country from the standpoint of the capital. People, church, government, law, education, commerce, transport, and charities are all discussed; and at the end two chapters describe the municipal markets, slaughter-houses, water-works, bull-fighting arenas, theatres, and other places of amusement. The second volume describes the coast lands of Peru northward and southward of the capital, the towns and seaports, the provinces now ceded to Chile, the railway communications, and the antiquities. A third volume is promised dealing with the highlands, but presumably the scheme does not include an account of trans-Andine Peru.

We cannot look on Dr. Middendorf's work as an exhaustive or even a comprehensive work on Peru. It is indeed a boon for the general reader rather than the student. Abounding as it does in personal reminiscences, and written in an easy conversational style, it should do much to further the knowledge of the country it describes amongst Germans, taking people. But it is, we fear, too diffuse and bulky to serve this purpose with the same degree of satisfaction that a smaller work might have achieved, and it lacks firm and wide generalisations which could present a clear picture of the land and people as a whole.

## LETTERS TO THE EDITOR.

[The Editor does not hold himself responsible for opinions expressed by his correspondents. Neither can he undertake to return, or to correspond with the writers of, rejected manuscripts intended for this or any other part of NATURE. No notice is taken of anonymous communications.]

### The Liquefaction of Gases.

A CAREFUL study of his letter in NATURE of February 14 shows that Prof. Dewar makes four claims.

(1) He claims that in his lecture in 1884 he employed an apparatus "more readily and quickly handled" than that of Messrs. Wroblewski and Olszewski, in the illustrations he gave of the work of these investigators.

(2) He claims that in his lecture in 1884 he used liquid nitrous oxide for the production of liquid oxygen.

(3) He claims that in 1886 he liquefied oxygen by passing the gas through a long copper coil surrounded by liquid ethylene, and that his apparatus made it possible to transfer the liquid oxygen to a glass vessel wherein it could be used as a cooling agent.

(4) He claims that, in conjunction with Prof. Liveing, he determined the refractive index of liquid oxygen before the publication of Prof. Olszewski's first paper on the subject.

I shall consider these claims in order.

(1) The apparatus used by Messrs. Wroblewski and Olszewski in 1883 is fully described and figured in *Wiedemann's Annalen* for that year (xx, 243). The gas to be liquefied was strongly compressed in a glass tube, imbedded in an iron cylinder, and connected by a capillary tube with a glass vessel, which in turn was connected with a store of liquid ethylene, previously cooled by passing through a narrow copper tube two metres long immersed in a bath of solid carbon dioxide; the glass vessel was also connected with a double oscillating Bianchi air pump. The liquefied gas was collected in the glass vessel, and its properties were examined. A comparison of the apparatus of the Polish Professors with the brief description in the *Proceedings of the Royal Institution* of the apparatus used by Prof. Dewar in 1884 "for the purpose of lecture demonstration" will, I think, show that I stated the matter fairly in my former letter by saying that Prof. Dewar "describes and figures an apparatus which is a slightly modified form of that of the Polish Professors, which in turn was derived from the apparatus of Cailletet."

(2) If anything was gained by using liquid nitrous oxide for the liquefaction of oxygen, why has not Prof. Dewar continued to use this refrigerator?

Prof. Dewar claims to have devised a method for liquefying oxygen which was so much inferior to that brought into practice by Wroblewski and Olszewski that it was abandoned almost as soon as it was devised. I suppose his claim may be admitted here.

(3) Granting that the substitution of a long copper coil for a strong glass tube was an improvement, it must not be forgotten that the apparatus of Messrs. Wroblewski and Olszewski, described in 1883, enabled the liquefied gas to be collected in a vessel wherein its properties not only might be, but were, studied. That this apparatus was an efficient instrument is shown by the facts that before the year (1886) in which the copper coil method was described, Profs. Wroblewski and Olszewski had liquefied oxygen, nitrogen, and carbon monoxide; Prof. Olszewski had liquefied air, nitric oxide, and marsh gas; had determined the boiling points, at atmospheric pressure, and the critical temperatures and pressures, of these six gases; had solidified nitrogen, chlorine, hydrogen chloride, nitric oxide, carbon monoxide, and marsh gas; and had made careful determinations of the behaviour of hydrogen at 211 and 220°. But with his copper coil 45 feet long Prof. Dewar did nothing; for, so far as can be judged from his published papers, he did not initiate experiments on the properties of liquefied oxygen, nitrogen, or air, until 1891-92. I think we may conclude that the apparatus of the Polish Professors was better adapted for accurate work than "that made wholly of metal" to which Prof. Dewar refers. If Prof. Dewar's apparatus of 1886 was "safer and better" than "that used in Craew in 1890," as he says it was—why was not this safer and better apparatus turned to some scientific use before a description appeared of the apparatus of Prof. Olszewski, in which the gases were liquefied in a steel cylinder and then transferred to

a glass vessel? In his letter of February 14, Prof. Dewar tells us that by means of the copper coil apparatus of 1886 "liquid oxygen was made and decanted or transferred from the vessel in which it was liquefied to another by means of a valve, and thereby rendered capable of use as a cooling agent." Why, then, did he not use the liquid oxygen as a cooling agent? It is strange that seven years after this, when Prof. Dewar wished to "prosecute research at temperatures approaching the zero of absolute temperature," he says he had "no recorded experience to guide [him] in conducting such investigations." Had he forgotten his own apparatus with its copper coil 45 feet long?

Prof. Dewar's apparatus of 1886 must have been peculiar; in one sentence in his letter of February 14, its deviser speaks of it as "entirely different in type from the crude plan Olszewski adopted in 1890," and in another sentence he assures us it was "practically identical in principle with that used in Cracow in 1890."

The apparatus of 1886 succeeded, in Prof. Dewar's hands, in producing solid oxygen; why have we heard nothing of that solid oxygen? Determinations of some of the constants of that substance would be interesting and important.

I must beg attention to an instance of Prof. Dewar's boldness. In 1883 Messrs. Wroblewski and Olszewski liquefied oxygen, and other gases, in a strong glass tube; in 1884 Prof. Dewar repeated some of the experiments of the Polish Professors, using, as they had done, a strong glass tube, but adapting some parts of their apparatus so as to make it "for the purpose of lecture demonstration . . . more readily and quickly handled"; in 1890 Prof. Olszewski described an improved and enlarged instrument, based on that described by his colleague and himself in 1883, wherein the liquefaction was effected in a steel cylinder. Yet, in his letter to NATURE of February 14, Prof. Dewar says "replace the glass tube in my apparatus of 1884 by a small steel cylinder, and attach to its lower end a narrow copper tube with a stopcock, and the Olszewski apparatus of 1890 is produced." (The italics are mine.)

(4) As regards Prof. Dewar's joint claim to priority in the determination of the refractive index of liquid oxygen, I admit he is right and I was wrong. I was misled by the date at the beginning of the paper which contains the earliest measurements by Messrs. Olszewski and Witkowski of the refractive index of liquid oxygen. The paper is headed *Extrait du Bulletin de l'Académie des Sciences de Cracovie, Octobre 1891*. At the end of the paper is the date 15 *Juillet 1892*; this, and the footnote, quoted by Prof. Dewar, make it evident that 1891 at the beginning of the paper is a printer's error for 1892. I am sorry I made this mistake. Nevertheless, considering that Olszewski's quantitative experiments on the optical properties of liquid oxygen were begun in 1887 (*Wied. Ann.* xxxiii., 570), and were continued in January 1891 (*ibid.* xli., 633), I hold I was justified in referring to Prof. Dewar's experiments on the optical properties of liquid oxygen as "mainly repetitions of the work of Olszewski and Witkowski."

Towards the end of his letter Prof. Dewar refers to a quotation I made from one of his lectures ("Having no recorded experience to guide us . . ."); he follows my quotation (of which he gives only a part) by another to the effect that "the necessity of devising some new kind of vessel for storing and manipulating exceedingly volatile fluids, like liquid oxygen and liquid air, became apparent when the optical properties of the bodies came under examination." I had expressed admiration on "of the skill which produced" Prof. Dewar's new vacuum receivers. Prof. Dewar now tells us that when he prefaced his account of the making of these receivers by the sweeping assertion that he had no experience to guide him in conducting investigations at very low temperatures, he did not mean what he said; it was merely his way of saying that the vacuum receivers he was about to describe had not been made before. It was not I who made, it was Prof. Dewar himself who has made, a "glaring misrepresentation of the meaning" of his own words.

Prof. Dewar lays no stress, in his letter, on his own experiments on chemical action, phosphorescence, &c., at very low temperatures. It is these experiments, I suppose, that are referred to when he speaks of "throwing his bread upon the waters"; or does he abandon them as trifling, in that strange sentence—"Have I ever suggested that Prof. Olszewski was anticipated, or attempted to raise any question of priority?"

Prof. Dewar hides the essential questions in a mist of words. If he has made marked improvements in the methods of liquefying and manipulating the more permanent gases (besides his invention of vacuum receivers); if he has conducted original, accurate, and thorough investigations into the properties of the liquefied gases, where are the accounts of this work to be found? Every student of the subject knows he can lay his finger on the work of Olszewski, and also on that of his deceased colleague Wroblewski; and he knows that work to be thorough, accurate, and important. But where can there be found some distinct account of the scientific work in connection with the liquefaction of the more permanent gases that is attributed to the Fullerian Professor at the Royal Institution?

I asked, and I still ask, for an "instant and serious consideration" of the whole matter brought forward in these letters by "those who are truly interested in the advance of science, and are jealous of the good name of the scientific men of this country."

M. M. PATTISON MUIR.

Cambridge, February 17.

Argon.

THE beautiful research of Lord Rayleigh and Prof. Ramsay has proved up to the hilt that in argon they have discovered an unknown gas which is remarkable for some of its physical properties, and especially for its extraordinary chemical inertness.

Among the interesting questions which have been raised, but not fully solved, are: Is argon an elementary body? If so, how does it stand related to the other elements?

There are some who advocate its being an allotropic form of a previously known element, just as ozone is allotropic oxygen; but it has not yet been produced from, or resolved into, nitrogen or any other element; and, until that should happen, it has the full right to take rank as a new element.

At first sight the fact of its giving two different line spectra under different circumstances might favour the idea of its being resolved into two bodies; but the fact that these two very compound line spectra have twenty-six lines in common, which are not all of them among the strongest lines, appears to me an argument for the fundamental unity of the substance.

If argon be an element, what is its place in Mendeléeff's table? This is at present agitating the minds of chemists and physicists. The specific gravity of the gas would lead to an atomic weight of close upon 20; but it is argued from the velocity of sound through it that it is a monatomic gas, and therefore close upon 40. Now, if 20 be the atomic weight, it will fall in admirably with the periodic law; if 40, it will be perfectly inconsistent with it. The argument in favour of 20 is at least five-fold:—

(1) It will fill an existing vacancy in Mendeléeff's arrangement; that at the top of the eighth column. This is the first "even" series; and it should be remembered that the later "even" series in that last column are represented by the iron, palladium and platinum groups of metals; the "uneven" series being as yet unrepresented.

(2) It will follow the periodic law in regard to its melting point. That should be very low, like nitrogen, oxygen and fluorine; and so it is.

(3) It will follow the law in regard to its atomic volume. That is small; and so it should be by analogy.

(4) A great characteristic of argon is its not forming stable compounds with other bodies, at any rate at a temperature high above its boiling

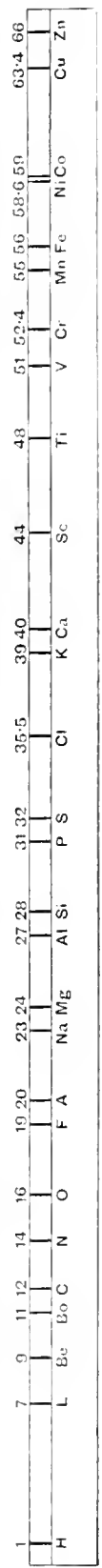

point. This property characterises the other occupants of the eighth column; to some extent in the iron group, and certainly in the palladium and platinum groups.

(5) The introduction of a new element with the atomic weight of 20 (not 21 or 22), will extend the range of certain recurring numbers which appear near the beginning of the series of atomic weights. In the existing arrangement of the atomic weights it will be observed that between oxygen 16 and fluorine 19 there are three units; between fluorine 19 and sodium 23 there are four; then the numbers run 1, 3, 1, 3, 1, 3. Adding argon at 20 the series becomes symmetrical all the way from oxygen to chlorine, as will be seen in the diagram on the previous page.

If, on the other hand, we were to adopt 40 as the atomic weight of argon, we should meet with the following serious difficulties:—

(1) There is no room for it. To place another figure just before or just after calcium would disarrange the whole subsequent series.

(2) It would break the periodic law in regard to its melting point.

(3) It would break the law in regard to its atomic volume.

(4) The inactive argon would be associated with metals of the earths, the compounds of which are remarkably stable.

(5) It would bring the atomic weight of three elements, potassium 39, calcium and argon each about 39.9, within one unit. This never occurs elsewhere in Mendeleef's table.

Against these considerations there is the forcible argument deduced from the ratio of the specific heats of argon. I will not attempt to weigh the respective merits of these lines of reasoning, especially in the absence of the details of the experiments on the velocity of sound, and until we have some knowledge of the compounds of argon. Trustworthy conclusions will not be possible till this further information is obtained. It is not a question of physics *versus* chemistry, for the true theory of its place among the elements must be able to coordinate all the facts upon which both the chemist and the physicist rely.

J. H. GLADSTONE.

London, February 8.

### The Aurora of November 23, 1894

PERMIT me to call attention to a significant fact disclosed by a scrutiny of the observations of the aurora of November 23, 1894, and having an important bearing in discussing the auroral dimensions, and which appears to have escaped notice (see NATURE, January 10). I refer to the *invisibility* of the objects at Dingwall, to the observers at Tynron, Dumfriesshire. Extracts from the synchronous accounts in NATURE, November 20, p. 107, and January 10, p. 249, will prove this statement.

*Tynron, 7.30.*—Luminous mist in the northern sky, strong enough to cast shadows on the shining surface of the wet ground. The mist moved from the horizon to the zenith, forming a detached luminous belt in patches, disappearing at 8.30, leaving only the light in the north.

*Dumfriesshire, 7.30.*—Sky covered in all directions by a canopy of streamers. At the same time the arch disappeared, and occasional streamer up to eight o'clock. It is not possible that the arch seen at Dingwall could be the same as the one at Tynron, because the form had vanished when the latter commenced to form, whilst there is a total absence of streamers, and phenomenally different mist not recognised at the other place. Until method of observation and analysis can be introduced that will eliminate the error of identification, the solution is likely to be indefinitely postponed.

W. H. WOOL.

Birmingham, February 11.

MAKING the necessary allowance for increased apparent luminosities of bright streaks, or of layers of light in the atmosphere, by the foreshortening effects of end on, and of edge presentation, the observations at Dingwall and in Dumfriesshire of the aurora of November 23, 1894, scarcely seem to recount very much which was not at the two places, at least partially, a fairly comparable and nearly contemporaneous description of the same phenomena. The bright form at the end of the glow was very strong at Dingwall from the east to west, a little southward from the zenith, until 7.30 p.m., when with the rapid drift of each display to the westward, it became less prominent there than the approaching canopy of streamers

which supervened, drifting up from the north-eastern sky in rear of it. But it assumed at the same time increasing prominence in Dumfriesshire (150 miles south of Dingwall), where between 7.30 p.m. and 8 p.m., it passed overhead in the shape of detached patches of light, a form which the belt was also seen to assume and to break up into, in a slow extinction stage at Slough, in that interval. The display of streamers rising from a large tract of light mist approaching Dingwall from the northward and increasing constantly in lustre at 7.30 p.m., did not extend far south of Dingwall before it faded out soon afterwards; and being (as it was seen at Slough) a dense local discharge of them, its corona of brightly-foreshortened beams overhead would naturally be a very impressive sight at Dingwall, although from a position 150 miles distant in Dumfriesshire, the broadside aspect of the short outbreak, seen from afar, instead of from underneath, would only have the appearance of a sheaf of coloured light projected up from the usual flat streamer-base, neither very wide nor extraordinarily lofty, but of the massive berg-like form, which was its description at Slough, not unfrequently noticeable in rather strong auroras; and it may even have been quite easily hidden from view entirely at Tynron, although a clear horizon in the north near Slough allowed its observation there, by trees or by other obstructions in the landscape.

If Mr. Wood can happily devise a practical means of perfectly recording the times and descriptions of *all* the rapidly changing features of an aurora, and the shifting variations of its misty light-glow, he could no doubt achieve results from observations which would be no less a benefit to astronomers and terrestrial magneticians, than an exact continuous registration of cloud phenomena would be of welcome interest to meteorologists and terrestrial electricians; but it needs no great familiarity with auroral exhibitions to be quite certainly assured that results of records even so elaborate as those might be, would never be found to confute, but only to confirm the generally accepted view of the really cosmical heights and dimensions of all truly auroral lights and coruscations; of all such lights, that is to say, as show in their spectra the yellowish auroral line, or some of the other well-recognised spectral indices of the aurora.

A. S. HERSCHEL.

### The American Association.

AT the Brooklyn meeting of the American Association for the Advancement of Science last summer, it was decided to meet this year at San Francisco, provided reasonable rates of fare could be secured from the trans-continental routes, as it was supposed could be done. Prof. Joseph Le Conte for three consecutive years had crossed the continent, laden with earnest and cordial invitations from the Universities and Scientific Societies of California, and the Common Council of San Francisco, to hold the meeting for 1895 in that city. The short-sighted policy of the railroads, however, refused to grant any concessions; and it has at last been decided to meet at Springfield, Mass., August 29—September 4. The meetings of affiliated societies will begin on Monday, August 26—rather later than the usual time of meeting.

Springfield is a small city, located in the heart of New England. It is the seat of the principal arsenal of the United States; and, while not a University city itself, it is within two or three hours' ride of nearly, or quite, a score of institutions of learning of the highest grade, including the two oldest and most powerful Universities in America, Yale and Harvard. This will be the second meeting at Springfield, the first having been held in 1859.

The Association is incorporated by the State of Massachusetts, and its office and museum are at Salem in that State; but no meeting has been held in New England since that at Boston in 1880, the most brilliant in all the history of the Association. The return to New England after this longest absence, gives unusual interest to the approaching meeting.

WM. H. HALE.

Brooklyn, New York, February 2.

### Earthquake in Norway.

AT about midnight on the 4th and 5th of this month, a fairly strong earthquake occurred in the southern part of Norway. The greatest disturbance was felt in the environs of the town of Alesund, upon the west coast (about 60° 30' lat. N.). From there

the shocks extended to the region of the Trondhjems fjord, the Swedish border, and the Christiania fjord, and Bergen, but the extreme south-west part of the country seems to have been undisturbed. The earthquake is also reported from Fünen, in Denmark. The movement proceeded in about seven minutes from the west coast to Christiania (at Christiania and 11h. 38m. Christiania time, 11h. 15m. Greenwich time). It is interesting to notice that the earthquake resembles one which occurred on March 9, 1866, and was felt across the North Sea at the lighthouse of Fluggarock, on the Shetland Islands. As I am engaged in collecting data about the earthquake of this month, I should be glad to know whether it was observed in the British Isles.

Christiania, February 11.

HANS REUSCH.

#### "The Black-veined White Butterfly."

My experience of this species in England enables me to support Mr. W. Warde Fowler's opinion (*NATURE*, February 14, p. 367) as to the preference of the species for open ground. I met with it in abundance in the New Forest in 1866, 1868, 1869, and 1870. It rarely occurred in or near dense woods, but preferred the open heaths and wastes of the Forest, where thistles were plentiful. In 1867 I found the species swarming, about mid-summer, in hay fields on hill-sides in Monmouthshire. There were a few small orchards, but not much wood, in the neighbourhood. For a detailed account of the former distribution of *Aporia crategi* in this country, I would refer Mr. Warde Fowler to my article on the subject in the *Entomologists' Monthly Magazine* for March 1887.

H. GOSS.

Surbiton Hill, March 16.

#### The Zodiacal Light.

At the present moment—7 p.m. February 16—the zodiacal light is more distinct than I ever remember to have seen it in England. The middle of the base is about 2° to the northward of the point where the sun set, and the axis is directed towards the Pleiades, and can be traced as far as the middle of Aries. The afternoon has been remarkably clear, and it is now a brilliant starlight evening.

J. P. MACLEAR.

Cranleigh, Surrey, February 16.

#### OYSTERS AND TYPHOID.

THE statements that have recently appeared, both in the general and in the medical press, concerning the communication of typhoid fever through the agency of oysters when eaten raw, make it desirable to review some of the data on which the suspicion in question is based. For many years past it has been a matter of assumption, when typhoid fever has followed, within some ten to fifteen days, on the consumption of raw oysters, and when no obvious cause for the disease could be detected, that the oysters stood to the fever in the relation of cause; and this attitude received no inconsiderable impetus when, a few years ago, a member of our Royal family sickened of typhoid fever under circumstances that were suggestive of oysters as the vehicle of the disease. Then again, it must be admitted that it has been a matter of no very uncommon experience amongst medical men to have to treat typhoid fever in patients who, at an antecedent date corresponding with the incubation period of typhoid fever, had indulged in an oyster supper after leaving some place of entertainment. And the suspicion has been confirmed, in some cases, when it has been ascertained that another member of the same party, having nothing but the oyster supper, in common with the sufferer referred to, has also had typhoid fever about the same date, or had suffered from vomiting and other symptoms the day after the consumption of the oysters. The assumption in cases of this latter class has been, that the specific poison of typhoid fever was, with other matter that had become objectionable to the system, got rid of by the attack of sickness. A case generally illustrative of this class of occurrence was recently recorded in the *British Medical*

*Journal*. Four friends had an oyster supper on November 5. Two of them lived not far apart, but the others had nothing in common as regards residence or anything else. On November 23 three of them sickened, and they were, later on, all found to have typhoid fever. One of the patients, during convalescence, disclosed both his profession and his views by re-naming his malady "bivalvular disease."

Amongst leading medical men who have adopted the view that oysters are a source of typhoid fever, we may name Sir William Broadbent, who early this year announced that from time to time he had seen cases of typhoid fever "apparently attributable to oysters," but that during the course of last autumn the evidence as to the communication of the infection through this agency has been of such a character as to produce "conviction" in his mind.

This naturally leads us to ask how the oyster becomes the vehicle of such a disease; and the evidence already forthcoming on this point is such that we could only wonder if typhoid fever were not occasionally conveyed to those who eat this favourite mollusc in an uncooked form. Investigation of some of the river estuaries and other places where oysters are cultivated and prepared for market, would almost lead us to believe that conditions favourable to typhoid fever were deliberately chosen for the purpose. Indeed, it is notorious that a number of our British oyster-beds are in such relation to sewer outfalls, that the oysters must of necessity be bathed in a solution of sea-water and sewage at every tide. According to a commissioner appointed to inquire into this matter by the *British Medical Journal*, a well-known Essex oyster fishery has "a sewer discharging between oyster-beds on either side"; and at a "health-resort" (!) on the same coast, it is a common practice to moor the oyster-boxes to a pier or groyne, within a few feet of which the evidences of sewage are too palpable to be specified. In both the places referred to, the typhoid fever poison, which it is known finds access to drains, had had ample chance of fouling the sewers in question.

It has been alleged, on the evidence of certain recent bacteriological investigations as regards the contents of London sewers, that the organism producing typhoid fever cannot live and multiply in sewers. But the organism has been found in sewers; it also lives in sea-water; and the fact remains that sewage bathes our oysters during cultivation to an extent that is essentially disagreeable, and that ought not to take place; and, also, that typhoid fever follows the use of oysters so cultivated. It may also be alleged, as is done by certain oyster-growers, that sewage is fatal to the oyster itself. In answer to this, we can only say that such evidence as we have obtained, as to some of our oyster-beds, is absolutely opposed to this statement; and not only so, but we know of more than one instance where the oysters are deliberately brought from the beds to fatten in still nearer proximity to outfall sewers for a week or more preliminary to their sale. In brief, if sewage and noxious micro-organisms can be retained in the beard and other portions of the oyster, or in the "juice," which is so much relished, everything seems contrived to secure such retention of filth at some of our oyster fisheries.

Doubtless the same applies to many foreign oyster-beds. Indeed, the recent experience embodied in a report by Prof. W. N. Cohn, as to an epidemic of typhoid fever amongst the students of a college at Middletown, Connecticut, not only supplies convincing evidence of this, but it affords the most connected and complete proof of "oyster-typhoid" as yet published. Quite an epidemic of typhoid fever occurred amongst the students of certain fraternities, and amongst a number of their friends who had joined them at their "initiation suppers," but who had subsequently returned to their distant

homes, where they sickened. The incidence of the epidemic was on those fraternities only who had included raw oysters in their menu; and even amongst these some marked escapes were in persons who, for one and another reason, had not consumed oysters. The suspected oysters came from Long Island Sound, where they had been put to "fatten" in a fresh-water estuary within 20 feet of a sewer known to have been receiving typhoid material. The last piece of evidence bearing upon this subject comes from an official source. It is announced that, on the strength of a report by the Medical Officer of the Local Government Board, as to the diffusion of cholera in England during 1893, which report is now passing through the press, an inquiry has been commenced into the circumstances under which oysters are cultivated and stored round our coasts. The reference is clearly to the serious outbreak of cholera at Grimsby and Cleethorpes, and to the diffusion of the epidemic from those places, whence a large distribution of oysters and other shellfish is constantly in progress.

Whatever be the outcome of the inquiry which has been instituted, it is certain that two questions will come to the fore: 1. the need for control over our oyster-beds, and 2. the desirability or not of allowing crude sewage to be discharged direct into the sea, or into tidal estuaries.

#### NOTES.

SIR HENRY ROSECOE has been made Chairman of the Select Committee of the House of Commons appointed to enquire whether any, and what, changes in the present system of weights and measures should be adopted.

We regret to announce that Mr. John Whitaker Hulke, F.R.S., resident of the Royal College of Surgeons of England, died on Tuesday, from broncho-pneumonia. An obituary notice in the *Zeeuw* furnishes us with the following particulars with regard to his career. Mr. Hulke was born in 1830, and was the elder son of a well-known and highly-esteemed surgeon at Deal, where his family had been settled for several generations. He was educated at King's College School, and subsequently spent two years in Germany, where he thoroughly acquired the language. After a varied experience as surgeon to the hospital at Smyrna, during the Crimean War, and in King's College Hospital, he migrated to Middlesex Hospital. In 1859 he received the Jacksonian prize of the Royal College of Surgeons for his Essay on Diseases of the Retina, and soon afterwards he brought out a treatise on the ophthalmoscope, then a novelty in eye-practice. This led to his being regarded mainly as an ophthalmic surgeon; but he continued to general surgery in the *Medico-Chirurgical Review*, and joined Mr. Holmes in editing the third edition of the "System of Surgery." He was elected a fellow of the Royal Society in 1867. In 1876 he was appointed an examiner in anatomy and physiology at the College of Surgeons; and in 1880 became a member of the Court of Examiners, an office which he held for ten years. In 1881 he was elected a member of the Council; and, after twice holding the office of vice-president, he became president in 1883, and has died in office. He had been president of the Pathological and Ophthalmological Societies, and at the time of his death was president of the Clinical Society and Librarian of the Royal Medical and Chirurgical Society. Mr. Hulke was, however, much more than an accomplished surgeon. He was a good comparative anatomist, botanist, and geologist; and was at one time president of the Geological Society of which he was elected the Treasurer on February 15. He was an artist in water colour, and was able both to model in clay and to carve in marble. His life is a real one to the medical profession, in which he was esteemed as a man of the highest probity and sagacity.

We notice the death, at the age of eighty-eight, of a gifted mathematician, the Rev. T. P. Kirkman. He was elected a Fellow of the Royal Society in 1857.

THE following deaths have occurred among scientific men abroad:—Dr. Gerhard Kruss, Extraordinary Professor of Chemistry in the University of Munich. M. Jules Regnaud, Professor of the Paris Faculty of Medicine, at the advanced age of ninety. The Rev. J. Owen Dorsey, a well-known ethnologist, at Washington, February 5. Prof. Dorsey had been connected with the Bureau of Ethnology, since 1877. He was the president of the Anthropological Section of the American Association for the Advancement of Science in 1893. We also have to record the death, at the early age of forty-five, on January 28, of Dr. F. Schmitz, Professor of Botany at Greifswald. For many years past, Dr. Schmitz had turned his attention chiefly to the study of the Algae, and especially of the red seaweeds or Floridæ, to our knowledge of the life-history of which he had made substantial additions. He published, in the year 1877, an account of the formation of auxospores in the diatoms, and, in 1879, a description of the green Algae of the Gulf of Athens.

PROF. L. GUIGNARD, President of the Botanical Society of France, has been elected to succeed the late Prof. Duchartre in the Section de Botanique of the Paris Academy of Sciences.

LORD RAYLEIGH will deliver a course of six experimental lectures on "Waves and Vibrations," at the Royal Institution, on Saturdays, March 2, 9, 16, 23, 30, and April 6. He will also deliver the Friday evening discourse on April 5, when his subject will be "Argon, the New Constituent of the Atmosphere."

A NEW thallium mineral has just been described, under the name of Lorandite, by Prof. Kierner, of Buda-Pesth. The new mineral occurs sparingly, in association with realgar, at Allehar in Macedonia. It is found as transparent crystals belonging to the Monosymmetric system, and having the form of plates or short prisms; its colour varies from cochineal-red to kermesite-red. The mineral proves on analysis to correspond to the formula  $\text{ThAS}_2$ , and contains 59.5 per cent. of thallium.

We have received from the Russian Chemical Society a pamphlet devoted to the description of the new chemical laboratory which has been erected at the St. Petersburg University. The laboratory has been built in accordance with the requirements of modern scientific investigation, and has cost £32,720. All branches of research have separate large halls, special rooms being allotted to physical chemistry and accurate physical measurements. Although the laboratory is behind many of the largest laboratories of West Europe, it has the advantages of perfect arrangements for each separate worker, and it decidedly has no rivals for the perfection of ventilation. The total amount of warmed air supplied to all the halls of the building attains 823,000 cubic feet per hour, so that the air will be totally changed from one to five times per hour in each separate hall.

THE Russian Geographical Society awarded, at its meeting of January 30, the Constantine medal to S. N. Nikitin for his numerous works on the geology of Russia; the Count Lutke medal to P. K. Zabskiy for geological work in Turkestan; the great gold medal to N. A. Karysheff for his work, "The Land rented by the Peasants"; and the Prjevalsky premium, of £60, to V. A. Obrucheff for his last journey in Turkestan and Central Asia. Small gold medals were awarded to the French geologist, M. Defforges, and the Austrian geologist, Baron Stenock, for their pendulum observations in Russia, and to M. Siensowski for his MS. on the Yakutes; and the great silver medal of Prjevalsky's name to Baron Toll and Lieutenant Shilebo, for their last journey to Arctic Siberia. Eleven silver medals were also awarded for minor works.

SEVERE frost has continued in nearly all parts of the British Islands, but in England and Ireland the cold was rather less intense last week. The frost has now continued for over four weeks, and although the period is shorter than in some other frosts during the present century, the intense cold experienced has been seldom equalled. There were no instances of temperatures below the zero, as in the preceding week, but readings of 20°, and even 30°, below the freezing point have been recorded. At Greenwich the mean temperature since the commencement of the frost is 28°, and the mean of the night readings is only 22°. Very little snow has fallen in any part of the British Islands, but the ground is still covered with snow from the fall during the earlier part of the frost. The type of weather has undergone a very considerable change, and the last few days have been much less cold, although frost occurs each night. The European anticyclone appears to have thoroughly given way, and in the course of two or three days the barometer has fallen to the extent of nearly an inch over Scandinavia. An anticyclone is, however, situated over the British Islands, and while this continues frost is still likely to be experienced.

AT the meeting of the Anthropological Institute on February 12, Mr. Brabrook drew attention to the work of the Ethnographic Survey Committee of the British Association, on which the Institute was represented by Mr. Francis Galton, Dr. Garson, and himself. He said the committee had been successful in obtaining a long list of places suitable for survey, and had prepared an octavo pamphlet, of twelve pages only, which gave comprehensive instructions to those who were willing to engage in it. What the committee now desired was to increase the number of observers, and he appealed to the members of the Institute for assistance in this respect. The committee were especially anxious to induce medical men to interest themselves in obtaining the necessary physical measurements in suitable places. For this purpose, they would be glad to furnish instruments, and render any other assistance that might be necessary and practicable. All their experience had shown them how valuable the results of their work would be likely to be, and how desirable it was that it should be proceeded with without delay.

THE magnanimous spirit which the Academy of Natural Sciences of Philadelphia has shown towards the circular sent out by the Royal Society, asking for co-operation and suggestions in making a subject-catalogue of scientific papers, is an indication of the unity of the interests of scientific societies. A report has been adopted by the Academy to the following effect:— (1) That a catalogue of scientific papers as proposed by the Royal Society is desirable, and that international co-operation should be engaged in its preparation. (2) That in order to secure uniformity in all parts of such a catalogue, a central bureau, as suggested by the Committee of the Royal Society, appears to be necessary, rather than that separate portions of the catalogue should be prepared by various institutions, such central bureau to be under the direction of the Royal Society, from which the proposition emanates; all publications of societies and monographs to be sent to such central bureau; the expenses to be met by returns from the sale of copies of the catalogue. (3) That such a catalogue should be classified, and should be issued at least once a year, each volume to be provided with an alphabetical index. (4) That the scope of such a classified catalogue should embrace the various yearly bibliographies of special sciences now issued. (5) That whenever translations or summaries are believed to be desirable, English should be made the basis of the catalogue.

THE fragility of human promises is proverbial. The following dialogue, which took place in the House of Commons on

Monday, furnishes another illustration of this quality:—Mr. Bartley asked the Chancellor of the Exchequer whether work was resumed last autumn at South Kensington Museum, as promised by him, so as to leave everything ready for the commencement of those buildings as soon as the money was voted by the House of Commons; and what sum was to be taken in the coming year's Estimates for the completion of those buildings in accordance with the pledge of the present President of the Local Government Board in March, 1894, on behalf of the Government. The Chancellor of the Exchequer said the demands upon the Estimates under other heads had proved so heavy that it had been found necessary to restrict the expenditure on bricks and mortar to the lowest possible point, and he feared that it would not be possible to undertake any large expenditure in connection with South Kensington Museum at present. Mr. Bartley: May I ask the right hon. gentleman whether it is not the fact that last year a certain estimate was allowed to pass on the distinct pledge from the Government that this year there would be a vote for this building? The Chancellor of the Exchequer: It was intended to do so, but, as we were reminded the other night, we ought to cut our coat according to our cloth, and the hon. member must allow me to know what our cloth is.

THE anniversary meeting of the Geological Society was held at Burlington House, on Friday, February 15, when the medals and funds were awarded as follows:—The Wollaston Medal, to Sir Archibald Geikie, F.R.S.; the Murchison Medal, to Prof. G. Lindström; the Lyell Medal, to Prof. J. F. Blake; the Bigsby Medal, to Mr. C. D. Walcott; the balance of the proceeds of the Wollaston Fund, to Mr. W. W. Watts; that of the Murchison Fund, to Mr. A. C. Seward; a moiety of the balance of the proceeds of the Lyell Fund, to Mr. P. F. Kendall; and the remaining moiety to Mr. B. Harrison. The President delivered his annual address, the subject bearing on the Palæozoic Crustacea. The following is a list of the officers and Council elected at the meeting for the ensuing year. (The names in italics represent new officers and members of Council.) President: Dr. H. Woodward, F.R.S. Vice-Presidents: Prof. A. H. Green, F.R.S., *W. H. Huttleston*, F.R.S., R. Lydekker, F.R.S., *Lieut-General C. A. McMahon*. Secretaries: J. E. Marr, F.R.S., J. J. H. Teall, F.R.S. Foreign Secretary: J. W. Hulke, F.R.S. Treasurer: *Dr. W. T. Blanford*, F.R.S. Members of Council: H. Bauerman, Dr. W. T. Blanford, F.R.S., *Prof. W. Boyd Dawkins*, F.R.S., Sir John Evans, K.C.B., F.R.S., Prof. A. H. Green, F.R.S., Dr. J. W. Gregory, *R. S. Harris*, Dr. G. J. Hinde, T. V. Holmes, W. H. Huttleston, F.R.S., J. W. Hulke, F.R.S., Prof. J. W. Judd, F.R.S., R. Lydekker, F.R.S., *Lieut-General C. A. McMahon*, J. E. Marr, F.R.S., *H. A. Miers*, *E. T. Newton*, F.R.S., F. Ratley, J. J. H. Teall, F.R.S., *W. Whitaker*, F.R.S., Rev. H. H. Winwood, Dr. H. Woodward, F.R.S., H. B. Woodward.

THE first scientific account of the Chilo-Argentine earthquake, which has reached Europe, is probably that written by M. A. F. Nogués (*Comptes rendus*, vol. cxx, 1895, pp. 167-170). The earthquake was remarkable for its intensity and long duration, the amplitude of the oscillations, and the absence of subterranean sounds. The epicentral zone is elliptical in form, its longer axis being directed nearly north and south, and passing by Rioja, San Juan, and Mendoza. The first two of these towns were severely damaged, and a large number of persons in them were killed and wounded. The boundary of the disturbed area is as yet undetermined, but it must have included a great part of the Argentine Republic and of the north of Chili. Within the epicentral area, the duration

of the shock was fifty-five seconds; at Santiago Observatory, where it was registered by a seismograph, the duration was 1 m. 4 s., and the amplitude of the oscillations 2.5 c.m.

The *Revue Scientifique* contains a full discussion of the cause of mountain sickness, by M. H. Kronecker, who was sent to investigate the conditions under which the proposed railway to the top of the Jungfrau could be worked without endangering man-life. M. Kronecker and six other persons from Berne were carried from Zermatt to a point near the summit of the mountain, 3750 m. above sea-level. It was proposed to reach the summit itself, but it was impossible to proceed without artificial carriers, the work being much too laborious at high altitudes. But at the altitude reached, all the symptoms of mountain sickness had shown themselves—acceleration of the pulse and of respiration, desire for rest, even after a very slight exertion, and headache. M. Kronecker arrived at some interesting conclusions regarding mountain sickness. It sets in at altitudes varying with different persons. Beyond 3000 metres it attacks all persons as soon as they indulge in the least muscular effort, and children and very old people are much less subject to it than others. It also varies with the character of the mountains, being usually less serious on isolated peaks. Persons in good health can stand massive transport to about 4000 m. without inconvenience, but they should not remain more than two or three hours at the top. A prolonged sojourn may be disastrous in its effects on health, as it proved to be in the case of Dr. Scherer. For the purposes of the railway, M. Kronecker recommends that all guards and other officials should be carefully selected and, if possible, acclimatise or frequently changed between the stations. Finally, the summit station should be arranged so that no further ascent whatever is necessary to get the full benefit of the view.

At a recent meeting of the Société Française de Physique, M. J. Kowalski read a paper on the conditions necessary for the formation of cathode rays. Starting from an experiment of Crookes, in which a vacuum tube having a constricted cathode and a parallel plate anode, the cathode rays are formed by the action of a glow discharge, but also of the construction of a cathode ray discharge apparatus, using tubes of different diameters. He found that, whatever the electric discharge is sufficient to produce the glow discharge or capillary tube joining the cathode to the anode tube, cathode rays are produced. The cathode rays are produced in a glow discharge by a glow discharge, but in obtaining cathode rays in a vacuum tube. This tube had somewhat the shape of a conical flask, and was placed along the discharge, the cathode being at the bottom. Under these conditions, the cathode rays are produced at either end of the tube, but the greater part of the vacuum tube. M. Kowalski also made some experiments to find that the production of cathode rays is connected with the disintegration of the cathode material. He found (1) that those rays are produced which are produced in a glow discharge is sufficiently strong to produce the glow discharge, as the same as that of the glow discharge, and the same as that of the glow discharge, and the same as that of the glow discharge.

The paper of M. Kowalski was read, M. Kowalski also made some experiments to find out whether the cathode rays were produced by the action of the glow discharge or by the action of the glow discharge, although he found that the cathode rays are produced in a glow discharge, and the same as that of the glow discharge, and the same as that of the glow discharge.

of force of the magnetic field. The experiment was made in air, as well as in carbon bisulphide in which sulphur had been dissolved. The author, although he does not think the above experiments are conclusive proof that cathode rays are radiation of a different nature from that which constitutes light, yet thinks they tend to show that there is some difference. Furthermore, if the cathode rays are analogous to light rays, it is difficult to explain the absence of double refraction when a magnetic field acts on the cathode rays.

THE triple number, pp. 10-12, of the *Bulletin* of the Botanical Department, Jamaica, is entirely occupied by a list of the more interesting trees and shrubs, 109 in number, grown in the Botanic Garden at Castleton, near Kingston.

IN the most recent part of the *Records of the Botanical Survey of India*, the Indian Government publishes a report of a Botanical tour in Kashmir, by Mr. J. P. Duthie, director of the Botanical Department of Northern India, accompanied by a map.

THE *Bulletin* of the Royal Gardens, Kew, No. 96, for December, 1894, contains an interesting article on "Cultural Industries in Dominica," an island which, since the abandonment of the coffee plantations, which were at one time its staple industry, is very far from yielding the economical products which might be expected from its climate and the fertility of its soil. A brief account is given of the four Botanic Stations in the Leeward Islands, those of Antigua, St. Kitts, Dominica, and Montserrat.

THE 1895 *Annuaire* of the Royal Observatory at Brussels, edited by M. F. Folie, has been received. The *Annuaire* is second only to that published by the French Bureau des Longitudes. It comprises ephemerides containing the principal astronomical data for the current year; geographical, meteorological, and other statistics; physical constants; and several articles, among them being three by M. Folie, on diurnal and annual aberration.

THE Smithsonian Report for 1893 has recently been issued. The report comprises a selection of miscellaneous memoirs embracing a considerable range of scientific investigation and discussion. This collection of reprints and translations, running into very nearly seven hundred pages, contains articles of interest to workers in all branches of science. Among the contributions to the Report is a monograph on "North American Bows, Arrows, and Quivers," by Dr. O. T. Mason. The paper, which is illustrated by fifty-seven plates, deals with the types of bows, arrows, and quivers of the North American aborigines, with incidental references to similar forms found elsewhere.

MESSRS. J. AND A. CHURCHILL have nearly ready the second volume of "Chemical Technology," edited by Mr. C. I. Groves, F.R.S., and Mr. William Thorp. This volume is devoted to lighting by candles and oils, and is illustrated by about 350 figures; the section on fats and oils being written by Mr. William V. Dent; stearine, by Mr. John McArthur; candle manufacture, by Messrs. L. Field and M. A. Field; the petroleum industry, by Mr. Boverton Redwood; lamps, by Mr. Boverton Redwood; and miners' safety lamps, by Messrs. Boverton Redwood and D. A. Louis. The third volume of the same work, containing gas lighting, by Mr. Charles Hunt, of Birmingham, and electric lighting, by Prof. Garnett, of the Technical Board of the London County Council, is in a very forward state.

MESSRS. MACMILLAN AND CO. will publish early in March the treatise on "Bessel Functions and their Applications to Physics," by Profs. Gray and Mathews, which has already been announced. The work, after an introductory chapter on the



problems which gave rise to the functions, deals with their properties, expansions involving them, semi-convergent expansions, Fourier-Bessel expansions, complex theory, definite integrals, and the relation of the functions to spherical harmonics. The physical applications embrace flow of heat and electricity, vibrations of membranes, hydrodynamics, electrical waves along wires, diffraction, and a number of miscellaneous problems. Numerical tables are appended, and also the Tables of Functions with imaginary argument, which have been prepared by Prof. A. Lodge for the British Association. A note containing useful formulæ for the calculation of the roots of Bessel Functions and others related to them, has been added from a manuscript placed at the disposal of the authors by Prof. J. McMahon.

WE have received Parts iv. and v. of *Indian Meteorological Memoirs* (vol. v.), containing the discussion of hourly observations made at Allahabad and Lucknow, forming a portion of the harmonic analysis of the observations recorded at twenty-five observatories in India, since the year 1873. The investigation is carried out in a most thorough manner, and there can be no doubt that when the work is complete, and the results correlated, much light will be thrown upon the laws which regulate atmospheric movements in those parts. In any case, the discussion will take rank amongst the most important of the kind hitherto undertaken by any country.

A COMPOUND of grape sugar with one of the acid radicle derivatives of hydrazine recently prepared by Herr Struve, a pupil of Prof. Curtius, is described by Dr. Wolff, of Berlin, in the current *Berichte* of the German Chemical Society, and, on account of its properties and mode of formation, appears likely to be of considerable service in the commercial extraction of pure dextrose from syrupy mixtures. It is first shown that the sugars of the aldose type react with the acylhydrazides to produce an aldose-acidylhydrazide by direct addition with elimination of a molecule of water. Thus, in the case of dextrose and benzhydrazide the following equation represents the change :



When dextrose and benzhydrazide are digested with 96 per cent. alcohol for five or six hours in a flask provided with an upright condenser, the new compound is produced in solution in the alcohol, and upon subsequent evaporation it separates in the form of acicular crystals, which can readily be purified by recrystallisation from alcohol. The crystals melt at 171–172 with partial decomposition. As lævulose does not react with benzhydrazide, pure dextrose can readily be isolated from the mixture of lævulose and dextrose in ordinary invert sugar by utilising the above reaction. The invert sugar is evaporated to a thick syrup, and the latter digested with alcohol and benzhydrazide for about six hours in a reflux still. The alcoholic solution is then evaporated over a steam-bath almost to dryness, the lævulose is extracted by washing with a minimum of alcohol, and excess of benzhydrazide removed by means of ether. Pure dextrose-benzhydrazide is then obtained in good crystals by two recrystallisations from alcohol. The recovery of dextrose from this compound with benzhydrazide is a very simple matter, for the compound is immediately broken up by boiling water into dextrose and benzhydrazide. It is found convenient in practice, however, to remove one of the products of the dissociation, the benzhydrazide, by precipitation as the insoluble benzal-benzhydrazide by means of benzaldehyde, which is found to be a most valuable reagent for the purpose. After filtration the liquid is evaporated to dryness, dissolved in cold water, whereby any traces of unprecipitated benzal-benzhydrazide are left behind, and again evaporated to dryness. The last traces

of impurities, chiefly benzaldehyde and benzoic acid, are finally removed by dissolving the dextrose in alcohol and precipitating with ether. The dextrose eventually obtained by evaporation of the clear solution is quite pure. Dr. Wolff lastly states that the above is a general process for separating aldoses from mixtures of sugars, and he is experimenting with a view to its adoption on the large scale.

THE additions to the Zoological Society's Gardens during the past week include a Snowy Owl (*Nyctea scandiavia*) from Norway, presented by Miss Wright; a Danlin (*Tringa alpina*), British, purchased.

#### OUR ASTRONOMICAL COLUMN.

MARS IN 1894.—SIGNOR G. SCHIAPARELLI remarks, in No. 3271 of the *Astronomische Nachrichten*, that the unfavourable state of the atmosphere during the opposition of Mars last year rendered magnification beyond 200 impossible except in rare instances. Speaking generally, he says that the "seas" were less pronounced than in 1877, and the "canals" were better visible in 1894, and seen in greater numbers. Some of the largest ones showed faint traces of doubling, but, with the magnifying powers used, nothing could be made out with certainty on this point. The southern pole cap became invisible in the 18-inch Milan refractor at the end of October. On October 8 it had already become very faint. The total disappearance cannot have been later than October 29, *i.e.* on the 59th day after the southern solstice of the planet. This is unusually early. In 1877–78 it was well seen as late as 98 days after the solstice. In the present case it is pretty certain that the whole of the southern pole cap was melted. A great change was also observed in the isthmus or peninsula of Hesperia, which separates the Mare Tyrrhenum from the Mare Cimmerium. It was apparently separated into two unequal portions by a newly formed channel. The Mare Sirenum, which in October, 1892, had been separated into two parts, was in October, 1894, seen to have resumed its ordinary aspect. But on November 21 the separation had reappeared. "This fact," says Schiaparelli, "and other analogous ones which I have observed in previous oppositions, lead to the conclusion that the abnormal changes in the markings of Mars do not take place by chance and without regularity, but that the same variation may reappear, with the same aspect, even after a long interval of time. The form and extent of such changes is determined by some element which is stable, or at least periodic."

NOVEL METHODS IN PHOTOMETRY.—The determination of the times of exposure of a photographic plate which are required to produce the same density of film when exposed to different light sources, forms the basis of the methods recently adopted by Dr. Janssen for investigating the brightnesses of the heavenly bodies (*Bull. Mens. Soc. Ast. de France*, February). In the case of stars, the plate is placed a little within the principal focus of a telescope; so that a disc, or "stellar circle," replaces the almost point-like image ordinarily obtained; a series of exposures is made on one star, and another series on the star to be compared with it; the two images of the same density are thus identified, and the photographic brightnesses of the two stars are inversely as the durations of the corresponding exposures. To compare the light of a star with the sun, an opaque screen, pierced with holes of the same size as the stellar circles, is placed in front of the photographic plate, and these holes admit sunlight to the plate at the moment a triangular aperture in another metal plate is passed over them on releasing a spring; in this way a series of circles of increasing intensity is impressed on the plate, and can be compared directly with the stellar circles.

In its application to nebulae, Dr. Janssen's method promises to be of great value. On the same plate which has been exposed to a nebula, a series of "stellar circles" is formed by directing the instrument to a star in the neighbourhood which shows no signs of variability. In the future, when one wishes to obtain a photograph of the nebula which will be strictly comparable to one taken previously, it will only be necessary by means of stellar circles to determine the exact exposure which should be given.

From an inquiry into the photographic luminosity of the tail

Comet: 1881, I. Janssen finds that the intensity decreased in a ratio between the fourth and sixth power of the distance from the nucleus.

**ATMOSPHERIC DISPERSION.** The fact that the image of a star as seen in a telescope is drawn out into a short vertical spectrum, with the red end uppermost, was noticed as long ago (1729) by Huggier, and the effect of the difference in colours of stars upon refraction appears to have been indicated in a general way by Lee in 1815. Even in small instruments this atmospheric spectrum is very noticeable in the case of bright stars at low altitudes, but, if necessary, it can be corrected by means of a thin prism placed in front of the eyepiece, or by employing an eyepiece of the form devised by the late Sir George Airy. In a recent paper (*Monthly Notices R.A.S.*, January), Dr. Rambaut points out the importance, in these days of extreme accuracy, of introducing a correction for atmospheric dispersion—according to the varying colours of stars—more especially in connection with observations of two stars in close proximity, as in measures of double stars, and observations for parallax. The claims of this hitherto rather neglected factor appear to be fully substantiated by a series of measures at different hour angles of  $\beta$  Cygni, in which double star the colours of the components are strongly contrasted: they “show clearly a systematic difference affecting the distance between them, of the sort, and in the direction, that theoretical considerations indicate.” Dr. Rambaut also shows that the systematic differences depending upon hour angle in the measures for the parallax of a Centaur by Drs. Gill and Allan, which they corrected by empirical formulæ, are due to a difference in the mean refrangibility of the light of the star and of the comparison stars. Further confirmation is derived from a re-examination of the Dunsink observations on the parallax of  $\beta$  Cygni, and the resulting value is corrected from  $465$  to  $67400$ .

An ingenious method of measuring atmospheric dispersion has been devised by M. Prosper Henry, and values determined for different colours (*NATURE*, vol. xliii, p. 400).

### THE SUN'S PLACE IN NATURE.

I.

I AM anxious to give in these lectures a statement, as clearly and as judicially as I can, of the discussions which have been going on since these results were published, to show what holes have been picked in the new views, and what new truths may be gathered from the new work which has now been brought to bear upon the old, so that as a result the place I have given to the sun among its fellow stars may be justified or withdrawn. These lectures will be different from the former ones, inasmuch as I then attempted to give you a piece of quiet history of several regions of fact and knowledge which had been well surveyed and mapped, and had become part and parcel of the common property of mankind. But now I shall have, in considering the discussion, rather to take you with me into the forefront of those who are fighting the battles of the confines of the unknown. I have to bring you news from the front, something like that which we are promised to-morrow or the next day from Port Arthur. I have to show how the battle is waging, who has lost, what positions have been occupied, and what things new and true and beautiful have been wrested from the unknown region; and I am the more anxious to do so, because, it enables me to bring before you the enormous advantage under which such work is now carried on; advantage in that now, when any question is put to any part of the heavens, we know that there are many good workers employed under the best possible conditions to get the particular information that we want; besides these advantages, in every branch of inquiry we have advances gigantic, marvellous, almost beyond belief.

I am sorry to say that in this world the centre of gravity of the activity has left our country and has gone our West. We have to look to our American colleagues for a good deal that we want to know in the matters, for the reason that now they not only have the biggest telescopes, and in the best observatories, but also they have been wiser than we—they have occupied high points on the earth's surface, and thus got rid of the atmospheric difficulties under which we suffer in England, and especially in London.

Let me bring before you one of the most perfect pieces of workmanship in the world constructed to investigate the phenomena of the heavens. It is a photograph of the Lick Observatory, situated at an elevation of 4000 feet on Mount Hamilton. Mr. Lick, the founder, was a very ambitious man. He was, I believe, an hotel-keeper at San Francisco, but however that may be, he has made his name immortal by helping on the progress of mankind. I wish we had some hotels like the San Francisco hotel in this country, and some Mr. Licks, because then some Englishman might immortalise himself in the same way. This, then, is the magnificent locality in which a great deal of the work that I shall have to refer to has been done. The principal instrument of this great Observatory is a refracting telescope having an object-glass three feet in diameter, and a tube fifty-four feet in length. This is practically the most important telescope in the world at the present moment, and to give you an idea of the wonderfully

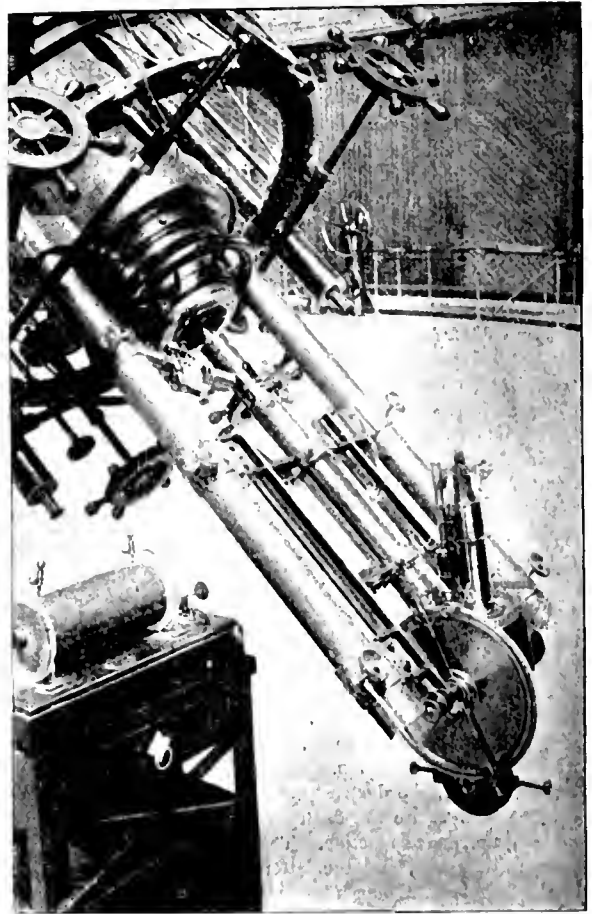

FIG. 4. Spectroscope attached to the eye end of the Lick Telescope.

broad way in which the authorities have gone to work, I need only state the following fact. Some of you who have been in an observatory may remember that it has sometimes been very difficult to get the observatory chair at the right height, or in the right position, for observing a star or any celestial body with any comfort. The Americans get over this by simply raising the floor. By means of hydraulics the enormous floor, some 80 feet in diameter, is moved up and down with the chair. The importance of spectroscopic work has not been lost sight of in the equipment of the Observatory, and a very powerful spectroscope can be used in conjunction with the great equatorial for observing or photographing the spectra of the various celestial bodies (Fig. 4).

One of the most important telescopes in England at present is Dr. Robert's reflector, with which several majestic represen-

For a further method of measuring atmospheric dispersion, see the work of Kingman and M. Prosper Henry, *Practical Geodesy*, vol. 2, pp. 100 and 101, and December, 1894, *NATURE*, vol. xliii, p. 400.

tations of the heavenly bodies have been produced; these I shall have to show you at one time or another in relation to different branches of our subject. In this instrument (Fig. 5) a reflecting telescope of 20 inches aperture is combined with a refractor of 7 inches aperture. The refractor is used as a guiding telescope, and ensures that the images of the stars and nebulae fall on the same part of the photographic plate which is being exposed in the reflecting telescope throughout the whole

on account of its brightness, spectroscopically gives us most easily indications of those bright lines which for ever set at rest the idea that we are dealing with solid or liquid bodies.

At the beginning of the present century it was found that in

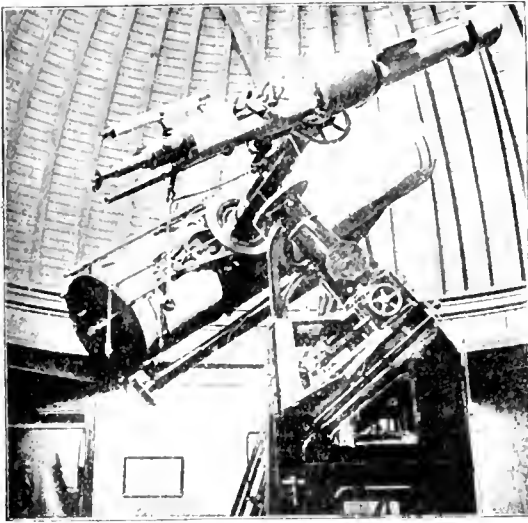

FIG. 5.—Dr. Roberts' twin telescope.

time of the exposure. Even with the best driving clocks, such a guiding telescope cannot be dispensed with when the exposures are prolonged for the number of hours necessary in some cases.

First for the nebulae. What is the difference, written down in this way, between a nebula and a star cluster? A comparison of Figs. 6 and 7 will at once show that in the case of a star cluster we have to deal with a collection of separate stars, while in the case of a nebula there is a filmy sort of



FIG. 7.—The spiral nebula in Canes Venatici, from a photograph by Dr. Roberts.

order to get the spectra of stars the best thing to do was to put a prism outside the telescope, and to let the light enter the telescope and be brought to a focus after it had passed through the prism; and it is a most unfortunate thing, that the



FIG. 6.—The Cluster 15 M Libræ, from a photograph by Dr. Roberts.

luminosity which is quite distinct from the neighbouring stars. Here and there the nebulousity is suddenly brightened, but, as I shall show hereafter, these condensations are not to be regarded as stars in the ordinary sense. Here is the nebula of Orion, which we owe to that wonderful telescope of Dr. Roberts. Several of you may have seen the nebula of Orion with a telescope, but you have never seen it exactly like this. You get here the idea which gave rise to the old notion of a candle shining through horn; this nebula is the one which,

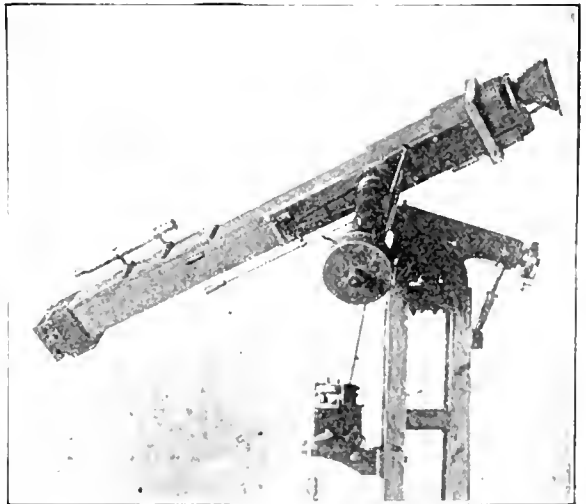

FIG. 8.—Showing method of photographing stellar spectra by the objective prism.

neglect of the application of this principle has hindered us probably in a delay of fifteen or twenty years in gathering knowledge on this subject. The whole credit of reviving this idea is due to Prof. Pickering, of the Harvard College, who since

its application has been able, with the aid of the large funds that he has at his disposal, and the magnificent help which he has accumulated round him, to obtain practically the spectra of all the stars down to the fifth or sixth magnitude in both hemispheres. In a few years' time we shall be able to work on the spectra of all the stars in both hemispheres, just as well as we can at present deal with their magnitudes and positions by the star charts.

An instrument of this kind (Figs. 8 and 9), having an aperture of only 6 inches, has been in use at Kensington for some time, and some of the results which have been obtained by its aid are shown in Figs. 3, 10, and 11. They are absolutely untouched photographs.

Without going into minute differences, we can, and, if we are wise, we shall deal first of all with the larger differences presented by the various classes of stars which people space. Here we have photographs of stars of different classes (Fig. 3). You will understand from these photographs how perfectly justified Rutherford and others have been in attempting to classify the



FIG. 9. Effective result.

stars by means of their spectra. In Sirius we get one class of stars, distinguished by the development of certain lines, which are due to the absorption of hydrogen. In a Cygni the hydrogen gas is represented quite distinctly, but the absorption there with regard to certain lines is much more developed than in such a star as Sirius. In Arcturus the absorption of the hydrogen is almost hidden in an enormous mass of lines. Here again we have another class, and it is not too early to remark that Arcturus in its spectrum exactly resembles our own sun. Thus we can say the sun is like Arcturus, not like a Hercules, a Cygni, and so on.

Fig. 10 is an exemplification of the kind of result which is now being obtained, and the kind of work which can now be carried on with regard to the minute structure of the spectra. One is the star Arcturus, and the other a star in the constellation of the Swan. You see at once that, if it is a question of attempting to determine whether stars are like each other, or whether they are unlike each other, and the points in which they differ, with the progress of modern science at the present moment—m

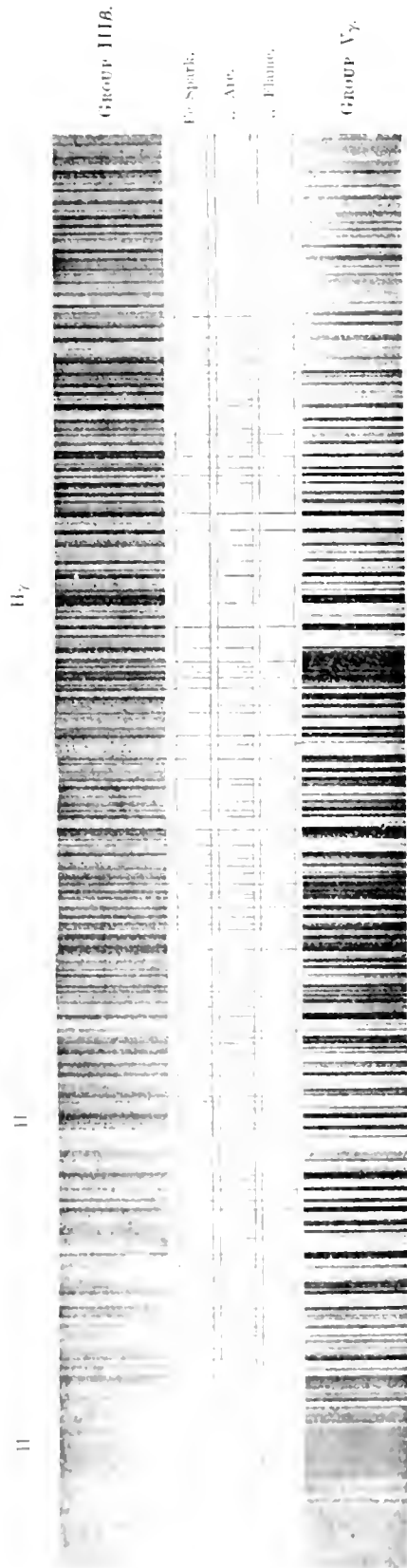

FIG. 10.—Spectrum of  $\gamma$  Cygni (1) compared with that of Arcturus (2). From photographs taken at Kensington.

as those resources are in some instances—we have really an opportunity of doing a considerable amount of work. The particular bit of work which is represented in this diagram is an inquiry showing how the iron lines observed in the spectra are represented in these different stars; we can see whether the condition of the iron vapour is the same in a star like Arcturus as it is in a star like  $\gamma$  Cygni. You will see that from this point of view there is a great difference in the atmospheres of these two stars.

The definition of the negatives obtained by means of the objective prism is of such excellence that they may be almost indefinitely enlarged, and this gives them a special value when we come to investigate the smaller differences between stars which have more or less resemblance to each other. Practically, we are able to dispense with elaborate micrometric measurements, and by placing the enlargements alongside each other, to see at a glance which lines agree in position and which are different.

NATHANAEL PRINGSHEIM.

BOTANISTS throughout the world will have heard, with deep regret, of the death of Prof. Pringsheim on October 6, of last year. His name is inseparably associated with the modern progress of the science, and there must be many, who, like the writer of this notice, can trace their first interest in scientific botany, in no small degree, to the fascination of Pringsheim's discoveries. Pringsheim was born in Silesia, in 1823. His career, though an active one, was unusually free from official cares. Except during four years, when he was Professor at Jena, he does not appear to have held any teaching post of importance. During the greater part of his scientific life, his work was carried on in a private laboratory, founded by himself at Berlin, and devoted entirely to the researches of original workers.

Pringsheim was founder and editor, from 1858 to the time of his death, of the famous *Jahrbuch für Wissenschaftliche*

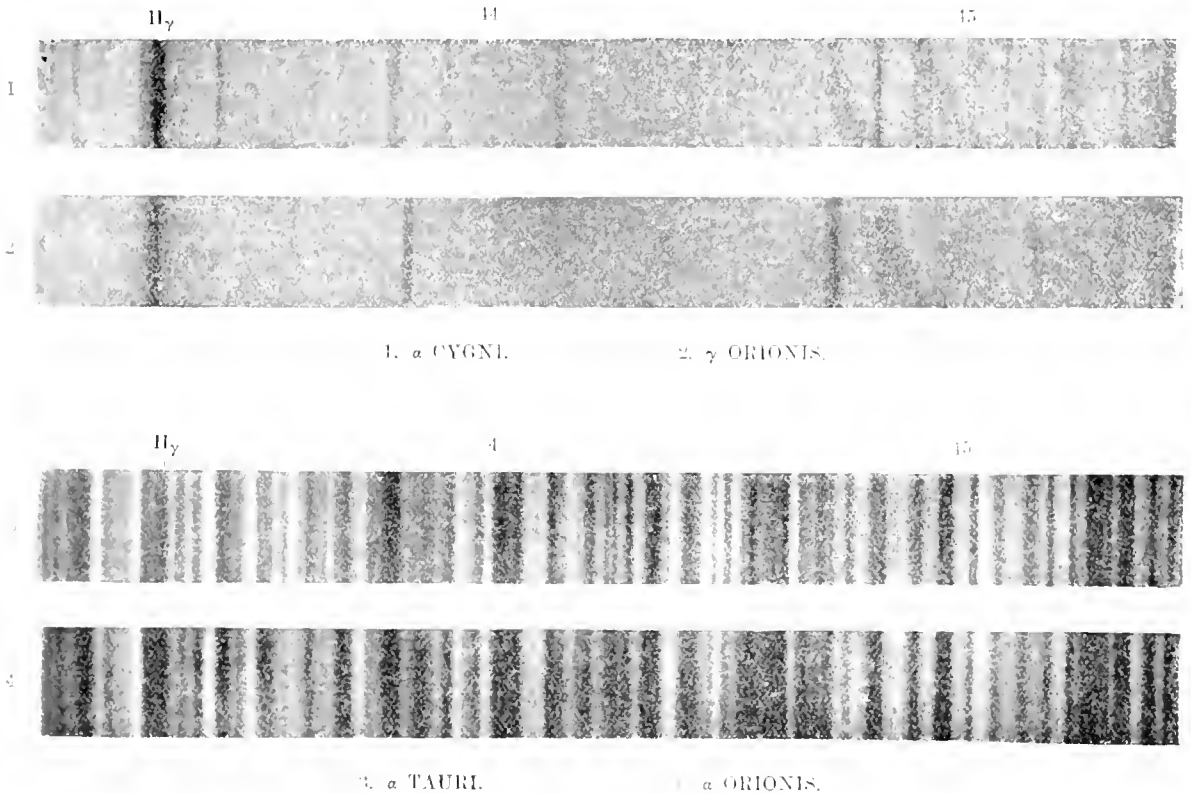

FIG. 11.—Portions of stellar spectra, greatly enlarged.]

The spectra represented in Fig. 11 have been enlarged twelve times from the original negatives, and on this scale the whole of the visible spectrum would be more than a yard in length. Here we observe, in the first place, the immense difference between two groups of stars, one in which the lines are very numerous, the other in which the number of lines is relatively small. We also have an opportunity of studying the more minute differences between stars like  $\alpha$  Tauri and those like  $\alpha$  Orionis, and between stars like  $\alpha$  Cygni and those like  $\gamma$  Orionis. In some cases, differences which might easily be overlooked altogether in an examination of the negatives alone, become apparent when the scale is enlarged in this way.

Thus, by means of the aids which have been placed at our disposal, by the recent improved condition of our stock in trade, and the wonderful diligence and skill of observers, chiefly in America, who have taken up the new work, we are now in a very much better position than we have ever been before to investigate this subject.

J. NORMAN LOCKYER.

(To be continued.)

*Botanik*, and was President of the German Botanical Society from its first origin. He was among the many distinguished foreign men of science who attended the meeting of the British Association at Manchester, in 1887.

The scientific activity of Pringsheim extended over a period of fully forty years (1848-1888), a time which covers what was perhaps the most brilliant epoch in the history of botany. His work began in the days when the science of histology was being built up on the basis of the cell-theory of Schleiden and Schwann; he himself contributed essentially to its construction. Pringsheim's greatest services to science, however, were in the department of the morphology and life-history of the lower plants, a line of research in which he was unsurpassed. Comparatively late in life his attention became directed to physiology, but in this direction his success was less conspicuous.

Pringsheim's earliest contribution to science was his Latin dissertation, "De forma et incremento stratorum crassiorum in plantarum cellula" (Linnæa, 1848), in which he discusses a question much agitated at that time, whether the

increase in thickness of the cell-wall takes place from without or from within. He decides chiefly from observations on the cells of the testa in seeds, in favour of apposition from the interior, a conclusion which no doubt holds good for the great majority of cases, though the researches of Strasburger have shown that this is not a universal rule.

Nearly afterwards, Pringsheim made his first investigation of a question which continued to occupy him, at intervals, for more than thirty years, namely, the development of the Saprolegniaceæ, a family which lies on the confines of the Algae and the fungi. At that time the delimitation of genera and species among these plants had fallen into great confusion. Pringsheim's memoir of 1851 bears the title, "On the development of *Saprolegnia*," but its subject was really a *Sap. elegans*. The zoospores of this family had long been known, and their resting-spores had already been observed by Schleiden and N. gelii. Pringsheim, however, was the first to prove that the two kinds of spore are produced by the same species; he watched the germination of the resting-spores, and saw that they gave rise to the ordinary form of the plant, with its zoospores. At that time he regarded it as an open question whether these plants are to be classified as Algae or Fungi; they are now assigned to the latter class, but placed near its lower limit, where there has not been much divergence from the original algal stock.

Six years later, Pringsheim discovered the sexual reproduction of the Saprolegniaceæ, an observation of the greatest importance, though his account was not free from mistakes, most of which he corrected himself in subsequent memoirs. It is a remarkable fact that in certain species of the family some individuals are entirely without male organs, and produce their spores parthenogenetically. In others the antheridia are present, but there is no penetration of the oogonium. The question whether actual fertilisation takes place in any Saprolegniaceæ was the subject of a keen controversy between Pringsheim and De Bary; the latter, for reasons which we have not space to enter into, held that the family, as a whole, is *apogametic*, i.e. that the sexual organs, even when present, have lost their function. Pringsheim, on the other hand, maintained that in the forms with fully developed antheridia true fertilisation takes place by means of "spermatozoiden." The question was under discussion up to the year 1883, and cannot even now be regarded as finally settled. Pringsheim's observations of the supposed aneuploid male cells are not very convincing, but neither is the negative evidence against the occurrence of fertilisation in the family decisive. The higher Fungi are characterised, as most botanists now agree, by a total loss of sexuality; in the Saprolegniaceæ we can, at any rate, trace the beginning of this retrogressive change.

It was, however, among the Algae themselves that Pringsheim's chief triumphs were won. His earliest purely Algalogical paper was on the germination of the resting spores of *Enteromorpha*, in which he first demonstrated the interesting fact that the embryonic plant presents a distinction of apex and base, which is quite lost in the later stages of its growth. The zoospores and motile spores of *Syringia* (described in the same paper, 1852) really belonged to a Chytridiaceous fungus. The same eminent author had already misled Pringsheim in some of his earlier observations on Saprolegniaceæ. In the following year, he made out the reproduction in a new genus, the *Volvocina*, allied to the "Water-net."

Pringsheim's most important investigations of the Algae were, however, with the year 1853, when he communicated to the Berlin Academy a memoir on the fertilisation and germination of the Algae, and the nature of sexuality. The chief point of the paper is the demonstration of the sexual reproduction of *Enteromorpha*, which he himself had discovered independently at the beginning of the century; it was reserved for Pringsheim to find the parent zooids, and to observe the fertilisation. The product of such an advanced mode of reproduction in an unicellular (or rather non-cellular) plant, was a startling discovery, and provoked some opposition among those who had not the good fortune of Pringsheim's conclusions. The paper further contains researches on the germination of *Enteromorpha*, and on the resting organs of *Enteromorpha*, which were only fully understood at a later time, and secondary observations on the remarkable life history of *Volvox* and *Infusoria*.

The latter discoveries were more fully announced in the

next year (1856), and two years later the whole history was told in a magnificent memoir, published in the first number of the *Jahrbuch für Wissenschaftliche Botanik*. This work is a model for all such investigations, and has left very little for subsequent observers to do, as regards these plants, which in some respects present unique peculiarities. The *Cedogoniaceæ* possess (in addition to the asexual zoospores) highly differentiated ova and spermatozooids. Many species are monoecious, and a few dioecious; most, however, present a remarkable form of dimorphism. Certain cells produce ova; others (usually in the same plant) give rise to small zoospores, which become free, attach themselves to the oogonia, or to adjacent cells, and there germinate into dwarf male plants. Each of these dwarfs consists of a single vegetative cell and an antheridium, in which two or more spermatozooids are produced, by which fertilisation is effected.

Another interesting point discovered by Pringsheim, is the germination of the sexually produced resting-spores, which do not grow directly into new plants, but give rise, each, to four zoospores; we thus have a case here, either of polyembryony, or of alternation of generation, according to our interpretation of the phenomena.

Two years later (in 1860), Pringsheim published an equally important memoir on another group of freshwater Algae—the *Coleochaetaceæ*. These curious little plants, which grow on the larger water-weeds, go through one cycle of development in each year. During the earlier part of the season, only asexual individuals, reproduced by zoospores, are formed. At the close of summer the last generation produces sexual organs also. After fertilisation (which is effected by spermatozooids) the oospore passes into its winter rest, and then germinates in the spring, giving rise, not to a normal plant, but to a parenchymatous, fruit-like body, in each cell of which a zoospore is formed. There is thus an evident analogy with the life history of the Mosses, which Pringsheim at once recognised. Of all Thallophytes, the *Coleochaetaceæ* show the nearest approach to that form of alternation of generations which is so general among the Bryophyta. Whether this is anything more than an analogy, is still an open question.

A controversial Algalogical paper of the same date (1860) is of interest, because the author opposes the view (held at one time by Thuret) that only a *dynamical* reaction takes place between spermatozoid and ovum. Pringsheim showed that the two sexual cells undergo an actual material fusion, a fact which lies at the root of all sound views as to the nature of the sexual process.

A year later, Pringsheim added to our knowledge of the remarkable course of development of the "Water-net" (*Hydrodictyon*), by tracing the history of those minute zoospores which become free from the parent-plant, and give rise to resting-spores. In this case, however, he overlooked the occurrence of conjugation, which, according to a subsequent observer, takes place between these small motile cells.

In 1862, Pringsheim turned his attention to marine Algae, and published some observations on the Red Seaweeds, in which he rightly described the structure of the sexual organs. Their function, however, was only demonstrated, five years later, by Thuret and Bornet.

To the year 1863 belongs an important memoir on the Characeæ, a group of plants, which, though so popular as textbook types, is still a mystery as regards its relationships. Pringsheim's observations were chiefly in the proembryo and allied structures. He established the existence of a striking correspondence between these organs and the protonema of the Mosses.

After an interval of six years, he returned, in 1869, to the investigation of the Algae, and made known perhaps the most important of all his Algalogical discoveries, that of the conjugation of zoospores, a process which he regarded as the primitive form of sexual reproduction in plants. This striking discovery was first made in *Parthenium*, one of the Volvocineæ, a family which is often claimed by the zoologists, but which, in its reproductive phenomena, betrays the closest affinity to undoubted plants. The motile cells, which conjugate in pairs, sometimes differ considerably in size, while in other cases they are almost exactly similar. The product of their union is a resting-spore, which on germination ultimately, though not directly, gives rise to a new colony. Pringsheim observed the details of the fusion of the sexual cells, and found that they first become united by their anterior ciliated ends, which consist

of clear protoplasm. He compared this part of the conjugating cell to the "receptive spot" of the ovum in the higher Algae, to the canal-cells of archegoniate plants, and to the synergidae of Angiosperms.

The conjugation of motile cells has since been observed in many other families of Algae, of the most diverse affinities, and in several of these families we can now trace the advance from this primitive fusion of like cells, to the union of a differentiated ovum and spermatozoid. Pringsheim's discovery has thus proved to have all the far-reaching significance which his scientific insight attributed to it, from the first. It has now become customary to speak of active conjugating cells as "planogametes," a word which is useful, as indicating their sexual function, but which must not be allowed to disguise their complete homology with the asexual zoospores.

In 1871, he discovered the male plants, and the presumable sexual cells of *Bryopsis*, a marine Alga, allied to *Laucheria*; the process of fertilisation however, has not yet been observed.

Pringsheim's latest contribution to Algology was his interesting work on the course of morphological differentiation in the Sphacelariaceae, a group of Brown Algae, in which the progress from filamentous to cormophytic structure can be traced through a very complete series. His views on evolution were akin to those of Nageli (*cf.* NATURE, vol. xlv. p. 582). He saw clearly the evidence of descent, but could not admit that natural selection is a sufficient explanation. It seemed to him that the highly differentiated *Sphacelaria* has no advantages, in the struggle for existence, over the simple *Ectocarpus*. He held that the first deviations from primitive simplicity of structure, are of a "purely morphological nature," and have no demonstrable relations to any physiological functions.

Views of this kind are widely spread among German naturalists. The greater, however, our knowledge of the conditions of life in plants becomes, the less room is left for these supposed "morphological characters," which are probably, at most, nothing more than adaptive characters which became fixed a long time ago.

We have endeavoured to give a connected account of Pringsheim's Algological work. During the same period, however, he had also made important contributions to science, in other directions; one or two of these must now be noticed.

A work bearing the date 1851, on the structure and formation of the vegetable cell, belongs to the period when the doctrine of the multiplication of cells by division had just gained the victory over the erroneous theory of free-cell-formation, so pertinaciously defended by Schleiden. Pringsheim's researches afforded valuable support to the new views. He observed cell-division in both vegetative and reproductive cells of many Algae, as well as in the pollen-mother-cells of Phanerogams. His view of the formation of the cell-wall comes wonderfully near to the conception of this process, which we have attained at the present day.

Pringsheim's work on the morphology and development of *Salvinia* (1863) is his most important contribution to our knowledge of the higher Cryptogams. He completely worked out the entire life-history of this interesting plant, and a more perfect monograph has never appeared. His observations will always form the basis of our knowledge of *Salvinia*, which is one of the most highly modified forms of Pteridophyta; they also throw great light on the embryology and development of the class as a whole.

Pringsheim, in 1876, crowned his long series of morphological investigations by a remarkable essay on the alternation of generations in the Thallophytes, and its relation to that in the Mosses. In the opinion of the writer of this article, this is, from a theoretical point of view, his most important work.

The essay was suggested by the experiments of its author on the sprouting of Moss-fruits. These experiments were undertaken by Pringsheim with the express object of determining whether the Moss-seta could be induced to subserve vegetative propagation in the same way as the Moss-stem, which it so closely resembles anatomically. He found that the seta of *Bryum* and *Hypnum*, when divided, and kept in moist air, developed a normal protonema, from which true Moss-plants arose. In other words, he succeeded in producing the sexual from the asexual generation, without the intervention of spores, thus establishing the first case of *apospory*, our knowledge of which has since been so much extended. In the meantime the converse phenomenon of *apogamy* had been demonstrated by

De Bary and Farlow, who showed that the asexual generation, in certain Ferns, may arise from the sexual protballus, without the intervention of the sexual organs. These facts really formed the groundwork of Pringsheim's theory of alternation.

His leading idea is that the successive generations among the Thallophytes are to be sought in the free sexual and asexual forms of the plant, and not in the plant itself on the one hand, and its fruit on the other. To take only one example: in the case of the Floridæ, Pringsheim regarded the tetrasporic and the sexual individuals as constituting the alternate generations; the sexually produced cystocarp he interpreted, not as a distinct generation, but as a case of polyembryony. Having expanded this view, he proceeds to face the difficulty, how it is to be reconciled with the life-history of the Mosses (in the widest sense), in which the alternation is between vegetative plant and fruit.

His reply is very ingenious: in the germination of the sexually produced spore of many Thallophytes the young plant suppresses more or less completely its vegetative stage, and proceeds at once to the formation of asexual spores; this is the case, for example, in *Ectogonium*, *Sphaeroplea*, *Hydrodictyon*, and more especially in the Phycomycetous Fungi, in which every transition can be traced between "sporangial" and "mycelial" germination of the sexually produced spore. Pringsheim goes on to say: "It may therefore hold good, as a general experience among Thallophytes, that the first neutral generation hurries by a short road to spore-formation, suppressing more or less the vegetative part of the plant." This change is most marked where germination takes place within the oogonium, as in *Coleochaete*. "Alternation of generations in the Mosses thus appears as a contracted form of that in Thallophytes; in the former the neutral generations are reduced to a single one, which remains in unbroken connection with the sexual plant. There is therefore no reason for comparing the sporogonium of a Moss with the fruits of the Thallophytes," and so on.

On this view it follows that all alternation of generations must be regarded as "homologous." Sporophyte and oöphyte, however differently modified, are homologous one with another, both having been derived from sexual and asexual individuals, which at one time presumably differed as little from each other as do the cystocarpic and tetrasporic plants in Red Seaweeds. It is therefore not surprising that in cases of apogamy and apospory, the one generation may still pass over directly into the other.

These views have been much criticised, and the case is still *sub judice*. In England the opposite theory—that the alternation in the higher Cryptogams is "antithetic," the sporophyte being an intercalated generation, not homologous with the oöphyte, is predominant, and appears to receive some support from certain minute histological differences between the two generations. Pringsheim's interpretation of the facts has, however, some advantages, perhaps the most conspicuous among which is that it would enable us to understand the existence of the immense and unbridged gulf which separates the sporophyte of the Muscinæ from that of the Vascular Cryptogams. The latter might well have been derived from ancestors, in which the "first neutral generation" had never suffered the extreme reduction which characterise it in the Moss series, but had always retained its vegetative organs. It would then no longer be necessary to endeavour to force the plant of a Fern or a Horsetail to fit into the Procrustean limits of a Moss-sporogonium.

We have endeavoured to give some idea of Pringsheim's varied activity in the field of morphology, which he cultivated with unsurpassed success. It remains to say a few words regarding his physiological investigations, though these are far from possessing the same importance.

So far as we have been able to find, Pringsheim's first entry upon the physiological domain dates from the year 1875, when he published papers on the spectrum of chlorophyll, and on the modifications of that pigment. His *debut* as a physiologist thus almost exactly coincides with the climax of his brilliant career as a morphologist. It was not till 1879, however, that he became prominent in physiological questions. In that year he produced his first paper on the action of light and the function of chlorophyll. He investigated the action of light of great intensity on vegetable tissues, and observed the consequent destruction of the chlorophyll, in green tissues, and the disorganisation of the protoplasmic structures, both of which he attributed to excessive oxidation. The great conclusion at which he arrived, is that "the function of chlorophyll, by means of

very powerful action, especially of the so-called chemical synthesis, the intensity of respiration, and to serve as a regular source of energy. He then proceeds farther, and states that the chlorophyll of only a few parts of plants evolve oxygen, and gives an explanation in the diminution of the normal rate of respiration, owing to the presence of the chlorophyll reaction, and thus regards assimilation as a function of the chlorophyll alone, with which the chlorophyll has been regarded hitherto in a purely negative way, by keeping off the light, and inducing the opposite process of oxidation.

In the next year, Pringsheim announced his discovery of a substance he called Hypochlorin. This he was able to concentrate in the chlorophyll corpuscles by the aid of certain reagents, especially dilute hydrochloric acid. He regarded hypochlorin as the first and most constant product of assimilation.

But Pringsheim's conclusions were sharply attacked, and extensive controversial literature soon grew up. As regards hypochlorin, it seems certain that Pringsheim was mistaken in the importance he attributed to this body. It has been clearly shown by Arthur Mayer and others, that hypochlorin is a product of assimilation, but is derived from the chlorophyll itself, by the action of the reagents employed.

The chief theory, that of the screening-action of chlorophyll, has not met with much favour from physiologists, and it is clear that this is, at any rate, not its only function. The investigations of Thimmar and Engelmann, have proved that certain of the rays emitted by the chlorophyll (principally those in the red and orange rays) most active in the decomposition of carbon dioxide, and chlorophyll, in fact, is not merely a screen, but a special apparatus which catches and retains those rays which are most active in the assimilative work of the plastid. On the other hand, recent investigations as to the action of light on the protoplasm have shown that many pigments (such as those of the red and yellow grains) are useful as screens, and have rendered it probable that this may be a function, though not the most important one, of chlorophyll also. The discovery, by W. Grignani, that green Bacteria can assimilate carbon from carbonic acid, even with artificial chlorophyll, and in the absence of light, is a strong confirmation of the view that the seat of assimilation is the protoplasm itself, and to this extent Pringsheim's conclusions are completely justified.

It would be hard to deny considerable credit to Pringsheim for his boldness and originality of his physiological theories, and for the progress which his suggestions effected. Yet it must be admitted that his views in the essential were one-sided, and are not supported by the same abundant evidence which distinguishes the views of other biologists. For example, in a number of cases, where he has made a bold assertion, he failed to add the necessary experimental confirmation, and thus a much of his suggestions are not supported, and thus not given weight, as he has not been able to confirm the theory of assimilation.

Pringsheim's views may be found in his paper, "Ueber die Assimilation der Pflanzen," *Botanische Jahrbücher*, vol. 1888, which has been translated into English in *Annals of Botany*, vol. 1890, and also in his *Ueber die Assimilation der Pflanzen*, Leipzig, 1891. His theory is supported by the observation that the illumination only of the chlorophyll may be doubted whether the assimilation is really taking place.

It is a pity that Pringsheim's views were not more fully supported by the work of other biologists. Pringsheim's views were not more fully supported by the work of other biologists. Pringsheim's views were not more fully supported by the work of other biologists. Pringsheim's views were not more fully supported by the work of other biologists.

Pringsheim's views were not more fully supported by the work of other biologists. Pringsheim's views were not more fully supported by the work of other biologists. Pringsheim's views were not more fully supported by the work of other biologists.

**THE ANTITOXIC SERUM TREATMENT OF DIPHTHERIA.**

THE subject with which we shall deal to-night, though at first sight of interest to the physician only, has been so fully discussed in the public prints, and has been so bitterly and unreasonably opposed on the one hand (perhaps also unreasonably applauded on the other), that those who take even a general interest in the public health, or who are wishful to obtain some insight into the practical and scientific aspects of a new system of treatment, may well be interested to know something of what is being so freely discussed in the columns of our daily newspapers. Beyond this, however, many take a more personal interest in a method of treatment which holds out promise of help in the cure or amelioration of the symptoms and conditions met with in diphtheria, a disease which, very justly, is looked upon as one of the most dangerous with which the physician has to deal. To begin with, I should like to make a frank confession. With that conservatism which is met with even in the most radical of natures, many, of whom I was one, felt disposed to treat antitoxic serum as belonging to the same group of substances as tuberculin, around which was constructed a theory of which the laboratory experimental basis, though apparently fair and firm, was as yet insufficient for the support of the structure of therapeutic treatment that was afterwards raised upon it. I followed the earlier experiments on this new method with great attention; I carefully analysed the principles on which the method was founded, and then with some misgivings watched the gradual development of the treatment as applied to a number of cases of diphtheria. I was inclined to receive the statistics with great reserve, as I felt that this new method, like all new methods of treatment, might be making cures in the minds of the observer, and not in the bodies of the patients. Now, however, I am convinced that whatever justification my incredulity may have had from the consideration of previous experiments, none could be claimed in connection with the experiments that were carried out in the investigation of this special subject, and I am thoroughly satisfied that, although the antitoxic serum treatment may not come up to the expectations of all the rash writers on the subject, for many people seem to think that it will be a specific against diphtheria in all its stages, at present, and this promise has in part been fulfilled, to diminish the diphtheria case mortality in a very remarkable manner.

*What is Diphtheria?*

It is primarily an inflammation of the mucous membrane (the moist skin of the tonsils, of the soft palate, of the upper part of the gullet, and of the upper part of the windpipe. During the course of this inflammation, which appears to be set up by the action of a special bacillus, there are usually thrown out some of the white elements of the blood and some of the white cells that float in the blood; these coagulate and form a soft, tough, whitish layer or film which affords an excellent food and resting place for this bacillus, which under such favourable conditions secretes or manufactures a most virulent poison. This poison is rapidly absorbed into the blood and is carried to various parts of the body; its effects are evident at first only on the nervous system, but afterwards on the muscles.

*The Bacillus of Diphtheria.*

First as to the bacillus. In 1875 Klebs described a short bacillus which he found on the surface of the greyish leather-like diphtheria membrane or film. Following up these observations, Loettler tried a definite etiological relationship between this bacillus and diphtheria. First he obtained pure cultures of the bacillus by growing it on solidified blood serum, or on a mixture of three parts of blood serum and one part of neutralised beef 1/1000th of a million of young extract of beef, 1 per cent. of peptone, 0.5 per cent. of common salt, and 1 per cent. of grape sugar. The organism may be readily detached from the surface of the false membrane by pressing readily but gently with the tip of cotton wadding twisted round the end of an iron wire or an ordinary penholder. When stained and examined under the microscope the diphtheria bacilli are found to be small rods, from 3 to 6  $\mu$  (1  $\mu$  = 1/100th of a centimetre) in length, fairly plump, straight, or slightly curved, sometimes wedge-shaped or pointed, but usually somewhat enlarged and rounded at the ends, where also in stained

A lecture delivered at the Royal Institution, on Friday, February 2, 1895, by Dr. G. F. S. Wainwright.



specimens the protoplasm is more deeply tinted than in the centre. This organism grows singly or in groups, or felted together to form a net-work; it may occur in irregular masses of considerable size. When these bacilli have been growing for some time on an artificial nutrient medium, they appear to be segmented, the stained material accumulating in small round nodules placed at intervals within a kind of membrane which is only very delicately tinted. During the past five weeks I have examined about 600 specimens taken from the throats of diphtheria patients, and I may say that in nearly every case where the disease has been diagnosed by the physician in charge, as being one of diphtheria, these typical bacilli have been found, whilst in those cases in which there was any doubt as to the nature of the disease, similar bacilli were found in some, but not in others.

This is of importance, because we shall find that this bacillus gives us the substance with which animals are rendered immune to the attacks of the bacillus itself, these immune animals in turn supplying the antitoxic serum. To prove that this bacillus is really the cause of the disease, Loeffler, in an elaborate series of experiments, inoculated the pure cultures of the bacillus grown on artificially prepared media, into animals; he was thus able to set up characteristic lesions, especially if he took the preliminary precaution to abrade slightly the mucous membrane, thus as it were ploughing the ground before scattering the seed. On such abraded surfaces the bacilli grew very luxuriantly, and false membranes were produced; in these lesions the bacilli could afterwards be found and again separated in pure cultures, whilst the characteristic toxic symptoms of diphtheria were in each case experimented upon, repeated with the utmost fidelity. Loeffler also pointed out a most important fact in connection with the presence of the organism in the body. He found that it was strictly confined to the local wounds or lesions in the throat and posterior part of the nose, and he was also able to prove that in this position these organisms commenced to manufacture most virulent poisons, which, unlike the bacilli, can become diffused throughout the body. Klein and Sydney Martin in this country have both made very valuable contributions to our knowledge, the former concerning the bacteriology of the disease, the latter in regard to the chemical action on the tissues of the toxic or poisonous products of the bacillus.

#### *The Toxines of Diphtheria.*

Martin found that after the poison formed in the throat has made its way into the internal organs of the body it undergoes certain changes; it is broken down into somewhat less poisonous compounds, but these, accumulating at certain points, act especially on the nerves and muscles. It appears then that we have to deal with two sets of poisons: a very virulent poison formed by the bacilli directly from the fibrin and albuminoids of the fluids of the blood, exuded on the surface of the mucous membrane; and secondly, a less poisonous series which appear to accumulate especially in the spleen. So long as these poisons remain in the body we have the general fever, rise of temperature, and altered conditions of circulation (as evidenced by the pulse), so characteristic of the disease. At a later stage, sometimes after all the primary symptoms of diphtheria have passed away, there are often met with what are called post-diphtheritic paralyses, which are due apparently to alterations in the nerves going to muscles, especially those going to the delicate muscles of the soft palate and around the opening into the windpipe, though other groups of nerves and muscles may be similarly affected. These post-diphtheritic paralyses may be due then to the action either of the virulent poison (ferment) formed in the membrane, or of the somewhat less poisonous but more stable toxines that are formed in the later stages of the disease. Through the kindness of Dr. Martin I am enabled to show you figures of nerves and muscles, the degeneration of which is due to the action of these poisonous substances. It is here unnecessary to enter into any detail as to the minute changes that take place in the nerve and muscle fibres, but on comparison of the affected nerve fibres with a healthy nerve fibre, it is evident that we have here grave structural alterations which must interfere most materially with the power of the nerve to conduct nerve impressions from the spinal cord to the muscle. The outer part or sheath of the nerve is in some places entirely wanting, whilst in other cases the axis cylinder or core of the nerve is either greatly attenuated or entirely absent. The poison in these cases has set up changes by which the communicating paths between the muscles and the spinal cord and brain have become thoroughly disorganised. The muscles, too, instead of being formed of cleanly

striated fibres, have this striation greatly obscured, first by a kind of cloudy or ground-glass look, and later by the appearance of a number of strongly refractile granules. These, when stained with osmic acid, become black, from which we argue that they are composed of fat, and it is said that the muscle has undergone a fatty degeneration, the muscular protoplasm being partially converted into fat; ultimately the striation may be almost lost. In a case of diphtheria, then, the following stages may be traced: a sore throat (often simple enough to begin with), by which the mucous membrane is prepared for the reception of the diphtheria bacillus. The diphtheria bacillus becomes implanted on this surface, gives rise to an acute inflammatory condition, and, subsisting on the inflammatory exudation, sets up a local manufactory of a most virulent poison. This poison, absorbed into the circulation, at once acts on the nervous system, although a certain proportion seems to be broken down into more stable, but less virulent, poison, which remains in the body, and may continue to act for a considerable time on the nerves and muscles.

#### *Immunity against Diphtheria.*

Whilst these poisons are attacking the more highly organised, and therefore less stable tissues, they are stirring up or stimulating the other tissues of the body to resist their invasion and action. If this were not the case, any one attacked by diphtheria must eventually succumb to the disease; but we know a considerable proportion of the cases of diphtheria recover even when no treatment at all is resorted to. Whatever may be the exact explanation of this recovery, we know that it depends upon the power of certain cells in the body to accommodate themselves to the presence of the toxines, and to go on doing their work of scavenging and of removing foreign substances from the body even under what originally were adverse conditions; during this process the cells become so profoundly and permanently altered that the patient is for some time protected against further attacks of the same disease. It was originally maintained that this alteration was entirely confined to the cells, but it is now generally accepted that these cells form or secrete substances which, thrown into the blood, either act directly upon the toxines so as to interfere with their activity, or so react upon the cells that they are able to continue their work in the presence of the toxine. At all events, a certain immunity against the disease is acquired. Upon these various theories is based the *rationalis* of the antitoxic serum treatment of diphtheria. Ferran claims to have been the first to obtain such a condition of immunity against diphtheria in animals; shortly afterwards, Fraenkel in Germany obtained similar results. Seeing that this immunity depends upon an alteration in the composition of the serum, should it not be possible, argued Prof. Behring, to take the serum of an immunised animal and transfer it to a patient suffering from diphtheria, so as to help the tissues and cells of the patient to cope with the toxic products of the diphtheria bacillus during the earlier stages of the disease, inducing, as it were, a kind of artificial immunity to help the patient over the acute period of the attack when the poisons, though most virulent, are most unstable, and when the tissues have not yet become acclimatised to the presence of the toxic products of the bacillus; when, in fact, they are paralysed and are able to do little to protect themselves. Behring so followed up this idea, that he was able to initiate a system of treatment which promises to revolutionise our therapeutic method in the treatment of certain specific infective diseases.

#### *The Production of Antitoxic Serum.*

Working on the fact that an animal might be rendered more and more insusceptible to the action of the toxic products of bacteria, Behring found that he might proceed in either of two ways. He might make an artificial wound with a needle, and introduce weakened bacilli into the animal, the weakened bacilli then growing but feebly and producing a modified toxine. After the effects of the first dose had passed off, he was enabled to increase the dose and to use more active bacilli, injecting them first into the tissues and eventually directly into the circulation, with the result that enormous doses of virulent diphtheria bacilli might ultimately be introduced without giving rise to more local swelling or general febrile disturbance than was first noticed when the small dose of modified bacilli was introduced. Such a method as this, however, was attended with considerable drawbacks, as it was almost impossible to gauge, at

accelerative effect on the strength of the bacilli. Not so, however, with the activity of the micro-organisms, the activity of which is not so accurately measurable, and the results are not so reliable. The bacilli might multiply in the connective tissue on the tissues, but the poisons when produced would not alter in quantity or activity. As may be easily seen, the fluid constituents of the blood can give rise to substances that are introduced into it from without, through the vital activity of the cells of the body, the products of which must be thrown into this fluid before they can be excreted, or through artificial injection. The toxic substances then found in the blood of an immunised animal, must in the case of natural immunity following an attack of diphtheria be the result of the activity of the tissue cells, especially of the connective tissue and white blood cell groups which have been "stimulated" by the toxins introduced from without, from the false membrane in the throat. Where it is desired to produce an artificial immunity, and an "artificial" antitoxic serum, the cells are stimulated by the introduction into the body of artificially prepared toxins. The cells acted upon by the toxins elaborate the protective fluid, which is thrown into and accumulates in the blood. This substance may act in one of several, or even in several ways: (1) It may directly antagonise the diphtheria toxin, and may thus prevent the paralytic action of the poison on the scavenging cells or phagocytes, as they are called, these left free to perform their proper functions, can deal with the foreign elements that have got into the blood, and also with the bacilli at the seat of the local attack, for, as has been pointed out by several foreign observers, and by Kuffer in this country, immediately beneath the layer of bacilli in the false membrane there is usually a very considerable accumulation of leucocytes, especially in those cases in which recovery ultimately takes place. (2) The antitoxic substances may act on the bacilli, inhibiting their growth and interfering with their power of producing toxins. This of course can only be a local action should it play any part in the process. (3) These substances may act directly on the cells of the blood lymph and tissues, stimulating and strengthening them that they are able to perform those functions above mentioned. It is at present difficult to state which of these processes is the one, or the most important, in protecting or curing the patient, and it may be that all play a part. It may be that the tissue cells, when acted upon by the specific diphtheria poison, become so modified that they are enabled to produce or secrete a substance which directly antagonises the action of that poison. This substance, thrown into the blood, remains there for some time, rapidly accumulates as larger and larger doses of the poison are thrown in, neutralising the poison, so that no further damage to the tissues is thus held in check, and remaining for some time after the toxin has disappeared, the antitoxic substance, reacting upon the cells, may render them less susceptible to the action of the toxin.

The first immunising experiments were naturally performed upon the lower animals, such as rabbits. Then Behring used sheep, but since various other animals had been tried, their use was abandoned by him, and Noctuid as perhaps the best of all animals for which to obtain an antitoxic serum. In the first place, these animals are entirely susceptible to the action of the diphtheria toxin, and can tolerate doses of living bacilli that would be fatal to man without producing anything more than a slight increase of weight and a rise of temperature. It has also been found that horse serum, when injected, produces the same results in the healthy human subject, that that of the lower animals does, perfectly well with human diphtheria, and with comparatively little danger of the establishment of the disease in the kidney in the form of nephritis. This is a most important point, and one that no other substance has ever been able to offer. The selection of the horse as an animal from which to obtain an immunised serum. Beyond that, however, the horse is shown to be in the vessels, separate very perfectly into water and from clot, which if he should be caught in a snare, the blood is a kind of serum, and the water is a clear, colourless serum which separates from the clot, and is a layer often several inches deep, however. This serum is the antitoxic substance. To say, therefore, that the blood can be separated from its large amount of clot, and if he be kept in a room that he cannot see, and if he be bled may be a very frequent way of obtaining an antitoxic serum, is in fact, as one observer has pointed out, bleeding

as well as did our forefathers, who thought as little of being bled as we think of going to Aix or Buxton.

Let us now turn for a moment to the method of treating the horses that we wish to render immune, in order that they may supply the antitoxic serum that is to be used for the treatment of cases of diphtheria. Roux's method, which is that that has been most carefully described, and which is the one used in this country first by Dr. Ruffer at the British Institute of Preventive Medicine, and then by Prof. McFadyean at the Royal Veterinary College, consists in introducing diphtheria toxin of a given strength in gradually increasing doses, until the blood of the animal so infected is found to contain a sufficient quantity of the antitoxine.

#### *Preparation of Diphtheria Toxine.*

The toxine with which the animal is to be injected is prepared as follows:—A broth is prepared by soaking a pound of finely-minced beef in water. This is allowed to stand for twenty-four hours in the cold. To the fluid expressed from the meat fibre at the end of that time is added  $\frac{1}{2}$  per cent. of common salt and 2 per cent. of peptone (meat artificially digested by pepsine). This broth is then rendered faintly alkaline by the addition of soda salts or caustic soda. This is done because it is found that the diphtheria bacillus cannot grow at all vigorously, or form its poisons rapidly in an acid solution, and such poison as is formed is neutralised, or is unable to act in the presence of even a faint trace of acid. It is found that even in Roux's solution, which is always faintly alkaline to begin with, an acid reaction soon appears, but, after about ten days, this is replaced by an alkaline reaction, and as soon as this takes place, the growth of the bacilli takes on new activity, the quantity of toxine is increased, and it becomes much more virulent. Roux found that he obtained his most virulent toxins after a month's growth. If the growth is allowed to go on longer than this, a process of oxidation appears to take place, and I have found that the toxine from a culture carried on for two months had already lost much of its toxic activity. It should be noted that a virulent bacillus should always be taken in the first instance, otherwise the results may be very disappointing.

This nutrient material is placed in a layer of not more than half an inch thick in a flat-bottomed flask, which is plugged with cotton wadding, and then closed with an india-rubber cork or cap. Through this composite plug three tubes are passed into the flask; the two lateral tubes are bent at right angles, both inside and outside the flask; whilst the centre tube is fitted with a small thistle-head, which may be plugged with cotton wadding, and then closed with an india-rubber cap. The outlets of the lateral tubes are also plugged with cotton wadding, and the whole apparatus is kept for an hour or two in steam maintained at a temperature of 100° C. Flasks so treated may be preserved for years without any change, beyond some slight evaporation, taking place in the broth. A small quantity of a pure broth culture of the virulent diphtheria bacillus is now drawn into a long thin pipette, the india-rubber cap and the cotton wadding plug are removed from the thistle head, and the contents of the pipette are introduced; the pipette is withdrawn, the cotton wadding is replaced, the india-rubber cap is fitted in position, and the flask is placed in an incubator which is maintained at the temperature of the body (98° F., or 38° 2 C.). As soon as the growth is well started (usually at the end of about twenty-four hours), a current of moist air is made to pass continuously over the surface of this cultivating fluid, the air being first warmed and saturated with moisture, in order as far as possible to prevent evaporation. A fine flocculent deposit soon makes its appearance on the bottom of the vessel, the supernatant fluid remaining clear. This deposit increases in thickness, much more luxuriant growth going on after the first ten days. Toxine is formed by the diphtheria bacilli so long as they can grow freely; that is, so long as they can obtain sufficient nutrient material from the fluid and from the air that is continually passing over the surface. At the end of a month, if all these precautions are taken, the toxine should be of such a strength that  $\frac{1}{10}$ th of a c.c. (about two or three drops) injected into a guinea-pig weighing 500 grammes (over 17 ounces) will kill it within forty-eight hours. The strength of the toxine or poison may be a little greater or a little less than this, but it is a comparatively easy matter to measure the strength, and therefore to graduate the dose to be used in immunising the horse. This only holds good, however, if the active diphtheria bacilli

are removed or destroyed; these, if left in the fluid, would be a complicating and inconstant factor in the equation. In order to kill these bacilli the Germans recommend the addition of  $\frac{1}{2}$  per cent. of carbolic acid to the culture; the dead bacilli falling to the bottom, leave a perfectly clear supernatant fluid. The French, on the other hand, recommend the separation of the bacilli from the fluid by means of a Pasteur-Chamberland filter. By this means a clear virulent poison which does not contain any diphtheria bacilli is obtained. With this fluid a horse with a good constitution, and which has been proved to be free from tubercle and glanders, is injected under the skin of the side of the neck in front of the shoulder. Small doses are first injected, either pure or with the addition of  $\frac{1}{3}$  of the volume of weak solution of iodine of potassium. If the fluid is of full strength, only about 2 c.c. can be given at the first injection. This is followed within twenty-four hours by a local swelling at the seat of injection, about the size of the palm of the hand, and the temperature may rise  $1^{\circ}$  or  $2^{\circ}$  F. ( $\frac{1}{2}$  to  $1^{\circ}$  C.), otherwise the general health of the horse does not seem to suffer. He eats well, and unless regularly exercised may become very lively; of this we have had ample evidence during the recent frost and snow, when it has been unsafe to give much exercise to horses that are not very sound in limb, and as a result they have been very fresh indeed. As soon as the swelling has disappeared and the temperature has receded to the original level, a somewhat larger dose is given; the same process is repeated time after time (the dose being gradually increased to bring about the same amount of swelling and rise of temperature) for about three months, or until such time as the requisite amount of immunity is acquired, *i.e.* until the antitoxic action of the blood is sufficiently marked. That there is a gradually increasing immunity is evidenced by the fact that enormously large doses of the toxine in the later stages of the treatment produce even less local and constitutional disturbance than was observed after the first few injections of comparatively small quantities.

The blood is now drawn off from the jugular vein of the immunised horse by means of a metal cannula or tube to which is attached an indiarubber tube; these are first thoroughly boiled, in order that no living micro-organisms of any kind may remain on or in them, and the skin of the horse is carefully cleansed with antiseptic lotions. The indiarubber tube leads the blood into a flask or vessel which has also been carefully sterilised, and provided with a well-fitting cotton-wadding plug or glass-stopper. The vessel when filled is placed in an ice-safes until the solid part, the clot, is completely separated from the fluid—the serum. From each gallon of blood about one quart of serum is expressed, though this varies considerably in different cases, and according to the time that the separation is allowed to continue (24 to 48 hours). This serum, a limpid straw-coloured fluid, is carefully decanted under strict antiseptic precautions, and, mixed with carbolic acid or camphor, is stored in small phials, each of which contains about a sufficient quantity for the treatment of a single patient. In the Pasteur Institute, and in the British Institute of Preventive Medicine, the antitoxic serum is apparently brought up to such a strength that  $\frac{1}{16}$  of a c.c. injected into a medium-sized guinea-pig (500 grammes, or over 17 ounces) will protect it against an injection twenty-four hours later of  $\frac{1}{2}$  c.c. of a culture of living diphtheria bacilli strong enough, if given by itself, to kill the guinea-pig in twenty-four hours. It is usually recommended that 20 c.c. of this serum should be given at the first dose, and that if necessary a second 10 c.c. should be given half an hour later. The method of testing the strength of the serum adopted by the Germans is that devised by Ehrlich, who takes ten times the lethal dose of diphtheria toxine, and in a test-tube adds a definite and known quantity of the blood to be tested. This mixture is then injected into a guinea-pig, and if the antitoxic power of the blood has been gauged aright, the animal does not suffer in the slightest degree from what under ordinary circumstances would kill ten guinea-pigs. The addition of less or weaker serum, or of more toxine would leave the mixture still toxic.

In order to obtain a definite standard with which to compare the antitoxic power of any serum, and to determine the dose of such serum, Behring and Ehrlich have described what they term a normal antitoxic serum—that is, a serum of such a strength that  $\frac{1}{16}$ th of a c.c. added to ten times the lethal dose of diphtheria toxine is exactly sufficient to render it innocuous. 1 c.c. of such normal serum contains one "immunisation unit," and

should be sufficient, when added to a hundred times the lethal dose and injected, to render it innocuous. In horses wholly immunised the serum may be fifty or even a hundred times as active as the normal serum above mentioned and the dose to be given varies according to the number of immunisation units in any sample. It is not here necessary to go into the question of dose, but it may be stated that 500 of these immunisation units are usually necessary to produce the desired effects in cases of diphtheria, though in some cases still larger quantities have to be used. Behring now supplies four strengths of the serum, the weakest (marked with a yellow label) is sent out for injection of cases where the disease has not already been contracted. The next (marked with a green label) is of a strength of 600 antitoxine units, and is given to those cases in which the treatment is commenced at the very outset of the disease—that is, when the first symptoms of diphtheria manifest themselves. The next stronger antitoxic serum (white label) equals 1000 antitoxine units, and is used for cases somewhat more advanced in which the prognosis is at all grave; whilst in still graver cases, and where the symptoms have been developed for some considerable time, it is often necessary to give a serum of 1500 units; this is marked with a red label, and is of course highly concentrated in order that the size of the dose may not be unduly increased. In place of No. 1, healthy children and adults who are exposed to diphtheritic infection may receive a quarter of the dose of the green label flask, which Behring considers will protect against diphtheria with very great certainty. Although these general directions are laid down, it is strongly insisted upon by Behring, Kossel, Roux, and in fact by all those who have had experience of antitoxic serum, that the dose must vary according to the severity of the disease, so that much must be left to the discretion of the medical practitioner in charge of the patient. The great error into which those who first use this agent fall, is the administration of far too small a dose, especially in the case of children, for whom the dose is nearly as large as it is for adults. For this reason some of the statistics published in this country and abroad are far too unfavourable to the method. The great drawback with this method is that the dose necessary to be injected is so large; but in the loose tissue of the side of the chest, the back, or the buttock, immediately under the skin, the fluid soon disappears. It is hoped that before long, however, the active principle may be separated, and so obtained in smaller bulk.

So far we have dealt principally with the antitoxic serum as prepared by Behring and Roux and by Roux's method, which is certainly attended with comparatively few difficulties; these, however, have the disadvantage that they take from three to six months to give the desired results. In order to do away with this disadvantage, Klein has carried out a series of experiments in which he has been able to obtain serum of considerable activity in as short a period as twenty-three days. Instead of introducing the poison only, he adopts the plan used by Behring and Roux in their earlier experiments, of injecting living bacilli which have lost a certain degree of their activity, using for this purpose old cultures. He afterwards introduces toxine along with more virulent bacilli, and thus obtains in the animal such a degree of immunity that it is enabled to withstand or to react very slightly to more than a fatal dose of diphtheria bacilli. By the third week the animal will bear the injection of large quantities of virulent bacilli, and by the end of twenty-three or twenty-six days the serum has acquired such antitoxic properties that 1 c.c. of it will protect 40 to 80 guinea-pigs against a lethal dose of living diphtheria bacilli. It is difficult to compare these results with Roux's and Behring's, but Klein's serum has been used with marked success in certain cases of diphtheria. It appears to have a special power of causing the membrane to clear away, and so to remove the manufactory of the poison, as on this membrane the diphtheria bacilli accumulate. This method is mentioned as one that may be used especially where it is desired to obtain antitoxic serum quickly.

Smyrnov has suggested quite a different method of preparing antitoxine. Under Nerecki's advice he passed electric currents through the serum of animals, and was thus able to endow it with a certain immunising power. But he was still more successful in obtaining powerful antitoxine by electrolysis of diphtheria bouillon cultures; curiously enough, the more virulent the culture the more powerful was the antitoxic substance he obtained. When this antitoxic substance was injected into a rabbit, which twenty-four hours before had received about  $\frac{1}{16}$  c.c. of a two or three days old diphtheria bouillon culture, there

was a rapid rise of temperature followed by marked improvement in the condition of the animal. This observer believes that anaesthetic can be obtained by this method that will be much more suitable for the treatment of the human subject than those obtained by the ordinary methods. His experiments, however, are far too few to carry any great weight, though they open up a most interesting field for future investigation.

*To be continued.*

UNIVERSITY AND EDUCATIONAL INTELLIGENCE.

CAVERIDGE.—The extension of the buildings of the Cavendish Laboratory is about to be undertaken, at an expense of over £4000. About half the cost will be met from the accumulated fees of students working in the laboratory.

MR. E. HAMILTON ACTON, Fellow and Lecturer in Chemistry of St. John's College, died suddenly, from heart disease, on Friday night. Mr. Acton was only in his thirty-third year; but he had earned a considerable reputation as a chemist, and his researches in vegetable chemistry, in particular, were of importance. He was an able and successful teacher. His funeral on Tuesday was attended by some hundreds of the junior members of the University, and by representatives of all the scientific departments.

M. J. ROBERT FERRINS, of Jesus College, Oxford, leaves England next week for Honolulu to resume his investigations in behalf of the Joint Committee appointed by the Royal Society and the British Association for the zoological exploration of the Sandwich Islands. The large collections he made there during his former stay (March 1892 to September 1894) have been admitted to various specialists, with results that show him to be an indefatigable observer in all branches of terrestrial zoology; and, since his return to England last autumn, he has been busily engaged in discovering what has yet to be done to complete our knowledge of the indigenous Fauna which is so rapidly disappearing.

THE County Councils of Northumberland and Durham are actively advancing technical education by affording assistance to Dr. W. Somerville, Professor of Agriculture in the Durham College of Science, to carry out extensive manurial trials. The experiments were begun in 1892, on nine farms in Northumberland; in 1893, when Durham joined in the work, the number of farms rose to twenty-six; while during 1894, the trials were made at no less than forty-three different centres in the two counties. The investigations must have a not inconsiderable influence upon the prosperity of the agriculture of the district to which they refer.

THE Technical Instruction Committee of the Essex County Council, with a view to promoting the spread of scientific knowledge and to encourage on the coast in the fishing industries, have arranged to erect a biological station at Brightlingsea last year, and, under the superintendence of Mr. J. E. Cunningham, a number of experiments were made for the purposes of demonstration. Some experiments on the experimental method of growing oysters were also commenced, although, owing to the unfavourable character of the season, they could not be carried very far. We are glad to hear, however, that the Committee, in conjunction with the Brightlingsea Oyster Fishermen, propose to carry on the work of the station, and that the Fishmongers' Company have also taken their share of the cost of the movement by giving a grant of £50 per annum for three years.

THE Manchester Town Council have accepted a tender for the construction of a road and bridge at a cost of £140,000.

SCIENTIFIC SERIALS.

*American Journal of Mathematics*, vol. xxii, No. 1, (January, 1895), Sur les courbes hyperboliques, par P. APPELL, is a beautiful paper on the geometry of curves, 1893, and of a similar kind by M. J. FERRINS, *American Journal of Science*, Mass., 1894, As a part of an investigation of the motion of a body attracted from a center of force, by L. C. CHANG by M. H. GREEN, gives the result of a study of the origin of the symmetry of the cell by F. ROBERTSON, and of the first and second order of the theory of hyperbolic functions, by O. G. LITTLE, in his work on statement of the well known

theorems of the theory of elliptic functions, and then extends these and some allied theorems to hyperbolic functions.—Sur la définition de la limite d'une fonction. Exercice de logique mathématique, by Prof. PEANO. The definition is one previously used by the writer, and also by two or three previous writers. It is practically given by Abel (*Works* ii, p. 199), in the form, "Pour qu'une série  $\Sigma a_n$  soit convergente, il faut que la plus petite des limites de  $n a_n$  soit zero." The same general idea of a limit is given in Cauchy's "Cours d'Analyse algébrique" (1821, p. 13), "quelquefois . . . une expression converge à-la-fois vers plusieurs limites différentes les unes des autres." Prof. Peano works on this definition, and demonstrates at some length its principal properties. To this end he employs la logique mathématique, "Cette science s'est rapidement développée de nos jours, et on l'a appliquée dans plusieurs travaux."—Dr. E. MCINTOCK contributes an article on theorems in the calculus of enlargement (3 paper read before the American Mathematical Society, August 14, 1894). It is an interesting sequel to his essay on the calculus of enlargement (vol. ii, pp. 101-161).—In his note on Foucault's pendulum, Mr. CHESIN considers the motion of a physical pendulum on the surface of the earth, taking into account the rotation of the earth about its axis. The initial velocity relatively to the earth of the pendulum is supposed equal to zero as in Foucault's experiment. Hence he retains the name of "Foucault's pendulum," although oscillations of any finite amplitude are considered. The portrait which is given with this number is that of M. E. PICARD.

*Wiedemann's Annalen der Physik und Chemie*, No. 2.—Fluorescence of solutions, by O. KNÖBLAUCH. There is a constant ratio between the intensity of the fluorescence and the existing light, even when the intensity of the latter is altered in the ratio of 1 to 6400. The author proves experimentally and theoretically that the effect upon the various fluorescent bodies of varying the solvent is very different.—The potential gradient in the positive portion of the glow discharge, by A. HERZ. The potential gradient in the positive unstratified glow discharge of a vacuum tube decreases as the current increases, and also as the diameter of the tube is increased; but it increases with the pressure, though not as rapidly.—Unipolar induction, by ERNST LECTER. The author discusses the different aspects of the question whether, when a cylindrical magnet rotates about its axis, the lines of force due to it are stationary, or rotate with the magnet. The former was Faraday's original view, the latter has been maintained by Tolver Preston and others.—After showing that all the experiments hitherto quoted as decisive one way or the other may be equally well interpreted on either assumption, he describes some test experiments which show that the lines of force stand still while the magnet rotates.—Electric dispersion, by P. DRUDE. A method is described for investigating the relation between the dielectric constant of a substance and the period of the electric waves traversing it, or what may be described as the electric dispersion of the substance. If the dielectric constant decreases as the period increase, there will be normal, if it increases, anomalous dispersion. Faral alcohol dispersion was found to be normal, and of the same order of magnitude as its optical dispersion. Water showed abnormal dispersion with the large wave-lengths used, whereas carbon tetrachloride showed no perceptible dispersion.—Effect of cathode rays upon some salts, by E. GOLDSTEIN. Lithium chloride, when exposed to cathode rays, assumes a bluish or dark violet colour, which it retains for some time in a sealed tube. Chlorides and other chlorides of potassium and sodium show similar effects. The colours are very superficial, and disappear on heating, or by the action of moisture.

SOCIETIES AND ACADEMIES.

LONDON

Geological Society, January 23.—Dr. Henry Woodward, F.R.S., President, in the chair.—Carrook Fell: a study in the variation of igneous rock-masses. Part II. The Carrook Fell Gneophyre. Part III. The Graungill Gneiss, by Alfred Harker. The augite-gneophyre of Carrook Fell was first described in its normal development, special attention being drawn to the various types of micrographic intergrowths which it exhibits. The variation of the rock was next examined,

and, in particular, a curious basic modification which occurs near its junction with the gabbro described in a former paper. The granophyre here passes into a coarse type rich in augite, iron ores, and apatite, its silica-percentage falling to 25.6 as 58. The author attributed this to the acid magma having incorporated in itself portions of the highly basic margin of the gabbro. The latter rock seems to have been fused or dissolved by the magma, with the exception of certain of its more refractory minerals which survive in the modified marginal part of the granophyre. The latter part of the paper dealt with a remarkable quartz-mica rock found on the north side of the Skiddaw granite. It differs in some respects from the Cornish greisens, and resembles in its mode of occurrence certain pegmatites in the Scottish Highlands. The author considered the rock to have been extruded from the granite in connection with the post-Silurian crust-movements of the district, while its composition has probably been further modified by subsequent chemical changes.—The geology of the country around Fishguard (Pembrokeshire), by E. R. Cowper Reed.—The tract of country forming the subject of this communication occupies the northern part of Pembrokeshire, from Newport to Strumble Head.—On the mean radial variation of the globe, by J. Logan Lobley. The author submitted considerations (chiefly derived from the characters of the earlier sediments) which led him to suppose that crust-folds have not been produced by continuous contraction of the earth, and that the planetary heat and mean radius of the earth have been practically invariable during the period which has elapsed since Cambrian times.

Zoological Society, February 5.—Sir W. H. Flower, K.C.B., F.R.S., President, in the chair.—A communication was read from Dr. E. A. Goeldi, in which he described the breeding habits of some tree-frogs observed by him in the Province Rio Janeiro. *Hyla faber*, Wied, constructs nests of mud on the shallow borders of ponds, wherein the young are protected from enemies whilst in the larval state. *Hyla geelbii*, Boulenger, dispenses with the metamorphoses, which are hurried through within the eggs, these being carried by the female on her back. *Hyla nebulosa*, Spix, deposits its eggs in a slimy mass attached to withered banana-leaves, the young remaining in this sort of nest until in the perfect, air-breathing condition.—Mr. Edgar A. Smith gave an account of a collection of land shells made principally by Mr. A. Everett at Sarawak, British North Borneo, Palawan, and other neighbouring islands.—Mr. Oldfield Thomas read a paper upon the long-lost mammal *Putorius africanus*, Desm., and its occurrence in Malta.—Mr. F. E. Bedford, F.R.S., read a paper on the visceral anatomy of the tree-kangaroo (*D. ulvolorus bennettii*), and pointed out the structure of the brain and other organs.

CAMBRIDGE.

Philosophical Society, January 28.—Prof. J. J. Thomson, President, in the chair.—The following resolutions were proposed by Prof. Sir. G. G. Stokes, seconded by Mr. Glazebrook, and passed unanimously: (1) "That the Cambridge Philosophical Society desires to express its sense of the great loss sustained by the University and the Society by the death of Prof. Cayley; whose eminence conferred honour on the Society which reckoned him amongst its Presidents, and whose simple and earnest character was an example to all and endeared him to those who knew him." (2) "That the Society do now adjourn without transacting the business of the meeting, as a mark of respect to Prof. Cayley."

PARIS.

Academy of Sciences, February 11.—M. Marey in the chair.—M. Faye gave a short account of the contents of volumes iv. and v. of the *Annales de l'Observatoire de Nice*.—On the presence and distribution of alumina in plants, by MM. Berthelot and G. André. Alumina is found in quantities comparable with the amounts of other bases present, mostly in the roots of plants having deep and abundant roots.—Preparation and properties of titanium, by M. Henri Moissan. Titanium has been prepared in the electric furnace. It requires the most intense heat capable of production, and even then contains at least 2 per cent. of carbon. It forms friable masses, having a bright white fracture. It is harder than quartz and steel. Its specific gravity is 4.87. The chemical properties are given in detail. Its silicide and boride are as hard as the diamond. The

carbide, TiC, and nitride, Ti<sub>3</sub>N<sub>2</sub>, are also fully described.—On some derivatives of phenolphthalein, by MM. A. Haller and A. Guyot.—M. Guignard was elected Member of the Botany Section.—Report on a work by M. E. Hardy relative to the application of sound vibrations to the analysis of two gases of different densities. By means of an instrument termed a Form-nophore) consisting essentially of two pipes tuned to give the same note, and blown with air and with air containing a lighter gas, the quantity of lighter gas present may be ascertained by the production of beats between the sounds emitted by the two tubes.—On a property of meromorphic functions, by M. Léon Borel.—On certain systems of equations to the derived partials, by M. J. Beudon.—On the electrostatic capacity of resistance bobbins, and its influence in the measurement of coefficients of induction by the Wheatstone bridge, by M. J. Cauro. Bobbins with double coils should only be used for small resistances; if the resistance increases, a capacity-error greater than that due to self-induction may be caused. To minimise capacity-errors the Chaperon winding should be used. These capacity effects may be neglected in measurements made with ordinary Wheatstone bridges; but they come into play with bobbins having small coefficients of self-induction with great resistances.—On the measurement of luminous flux, by M. A. Blondel.—On the passage of light across a thin plate in the case of total reflection, by M. Ch. Fabry. The formulæ of thin plates are shown to apply without modification to the case of a transparent spot at and surrounding the point of contact of a convex and plane-glass surfaces when the included thin plate is viewed at the angle of total reflection.—On the lowering of the freezing-point of dilute solutions of sodium chloride, by M. A. Ponsot. The author obtains results by his own method differing from those of previous observers. He finds that in the limit the lowering of the freezing-point is proportional to the number of grams of salt existing in 100 grams of solution.—On sulphide of gold, by M. A. Ditté. The behaviour of gold sulphide in presence of alkaline sulphides, with and without excess of dissolved sulphur, is described. The compounds: Au<sub>2</sub>S<sub>2</sub>.2Na<sub>2</sub>S.20H<sub>2</sub>O and Au<sub>2</sub>S<sub>2</sub>.Na<sub>2</sub>S.10H<sub>2</sub>O and Au<sub>2</sub>S<sub>2</sub>.4K<sub>2</sub>S<sub>2</sub>.12H<sub>2</sub>O are noted.—On a method of causing the crystallisation of precipitates; manganese and zinc sulphides and cupric hydrate, by M. A. Villiers.—On cinchonidine, a case of dimorphism of a compound having a specific molecular rotatory power, by MM. E. Jungfleisch and E. Léger. Cinchonidine is dimorphous, its two forms readily passing from one to the other. The monoclinic form is stable at the ordinary temperature, the rhombic form at about 35°.—On the plurality of chlorophylls; the second chlorophyll isolated from lucerne, by M. A. Etard.—A comparison between the coloured and colourless derivatives of hexamethyl triamidotriphenylmethane, by M. A. Rosenfeld.—On a new type of ethereal salt, methylene lactate, by M. Louis Henry. The preparation and properties are described of the substance

represented by the formula  $\text{C}_2\text{H}_5 \cdot \text{CH} \cdot \text{CO} \begin{matrix} | \\ \text{O} \cdot \text{CH}_2 \cdot \text{O} \end{matrix}$ —On the rela-

tion between the general form and the composition of the body in protozoa, by M. Félix Le Dantec.—A study of the agricultural value of the phosphate of aluminium from Grand-Combe, by M. A. Andouard.—On the contact phenomena of the lherzolite of the Pyrenees, by M. A. Lacroix.—New relations between the barometric movements in the northern hemisphere and the movements of the sun and moon in declination, by M. P. Garrigou-Lagrangé. (1) In the northern hemisphere the atmosphere oscillates about the 30° parallel, corresponding to the movement of the moon in declination, so that the pressures are lower with boreal than with austral moon below 30°, and inversely above. (2) The gradients take corresponding modifications. The barometric slopes from 30° south and north, are alternately increased and lowered, more strongly with boreal moon below 30°, more feebly above, and inversely with austral moon. (3) These differences in pressures and gradients augment towards the pole, at least up to the 70th parallel. (4) These movements are superposed on more general movements.

AMSTERDAM.

Royal Academy of Sciences, December 29, 1894.—Prof. Van de Sande Bakhuyzen in the chair.—A treatise on a simple method of roughly distinguishing between Scandinavian and southern diluvial sand, and between alluvial and diluvial sand, by separating the heavy minerals from the sand through im-

mers on of the ... of a specific gravity of 2.88, invented and described by Dr. J. L. C. Schroeder van der Kolk, from the subject of a report drawn up by Mr. Van Dieën and Dr. Lehiens.—Mr. Schols and Mr. Martin reported on an essay by Mr. J. J. A. Muller, in which the ... of the dislocation undergone by some parts of the ... system of Sumatra, in consequence of the earthquake of May 17, 1892. These calculations, which are based on data supplied by the measurements executed in the said island on behalf of the secondary triangulation, prove with great certainty a horizontal shifting of the following three points to the extent, and in the direction indicated:—

Sorik Merapi ... ..	1.23 M.	344 57'
Tor S. Hite ... ..	0.64 M.	149 2'
Goenveng Malintang ...	1.24 M.	304 28'

The directions being counted from the north point, going round through the east.—Dr. Van de Vries discussed some methods of deducing from given configurations more complicated configurations. In particular a series of configurations, first described by Andreef, was deduced from the tetrahedron by means of a system of polar coordinates.—Dr. Bikhuis Roozeboom, in considering the experiments of Prof. Spring, on the conversion of black into red H<sub>2</sub>S, showed that this author was mistaken in the nature of the phenomenon, which belongs to the category of the conversion of unstable modifications into stable ones. The pressure required for a conversion of this description does not admit of being expressed by a simple law.—Dr. P. van Romburgh has examined, in the laboratory of the "culture" garden at Tjékoumeuh, a number of coca leaves grown in Java, in order to ascertain their volatile constituents. Those of *Erythroxylon C. a Lam.* var., *Spruceanum* (Buck), when distilled with water, produced methyl-salicylate (about 20 c.c. was obtained from 140 lbsrs. of fresh leaves). In the water was also found a little acetone and in thyleic alcohol, and perhaps also traces of salicylic aldehyde. The quantity of methyl salicylate decreases in proportion as the leaves grow older; in fresh unexpanded top leaves Dr. van Romburgh found 0.13 per cent., in young leaves from 0.06 to 0.07 per cent., in old leaves even less than 0.02 per cent. The leaves of *Erythroxylon Bolivianum* (Buck) were also proved to contain methyl salicylate, but only 0.04 per cent., as well as those of *E. carmatum* (Buck), but not those of *E. Buemianum* (Girtt) and *E. Bonetianum* (Buck), while in the case of *E. peruvianum*, *Comor* the results were doubtful.—Prof. Kamerlingh Onnes read a paper on the Kryogenic Laboratory at Leyden, and on the production of extremely low temperatures. The object of the author in starting his investigations, upwards of ten years ago, viz. the combination of Wroblewski's and Oszewski's labours with those of Pieter, has been quite satisfactorily attained with the least possible means. Liquid oxygen is stored in a glass vessel adapted for experimenting at laboratory purposes; the oxygen vapours are continuously condensed, liquefied, and again poured into the said vessel, so that the evaporation from the surface takes place at a level that is very constant. With the aid of a small quantity of circulating oxygen, a bath of liquefied gas of quarter to a half atmosphere is maintained under normal or reduced pressure, *at a titium*. By this method no use is made of Dewar's vacuum vessels. The heat is protected from convective transference of heat by the water vapour, which cools a spectral chamber with plate glass windows. These windows remain quite free from hoar-frost, and do not interfere with the formation of images. The circulation of liquid oxygen is obtained in a spiral tube immersed in a water-bath boiling in a copper flask connected with a condenser, vacuum pump and compressor. The circulating ethylene is obtained in a condenser cooled down to -80° by a circulating stream of acid anhydride, or in some cases by carbonic acid. The apparatus is made of glass, and the flask especially is so designed that a minimum of condensed gases is required. Only 10 grammes of ethylene are used in the author's ethylene apparatus to obtain the above-mentioned permanent liquid oxygen, in contradiction to the great quantities mentioned in the accounts of Dewar's experiments. The purifying of the means of fractionating at low temperatures was so far as possible a modified form of Callieff's mercury plunger compressor, especially for this purpose, was described. The author is occupied with a few observations on certain investigations on the apparatus in course of execution, and intended to be preparatory to the manipulation of liquid hydrogen in the Kryogenic Laboratory of the future.

GÖTTINGEN.

Royal Academy of Sciences.—In the *Nachrichten*, part 4 (1894), the following papers of mathematical and physical interest appear:—Fv. Schilling, the fundamental polygon of Schwarz's  $s$ -function for the case of complex exponents; O. Bolza, a  $ps$  function for the general hyperelliptic case; R. Dedekind, on ideals (in the theory of numbers); E. Riecke, the equilibrium between a deformed homogeneous solid and liquid in contact with it; E. Riecke, Clausius' condition equation; A. Hurwitz, on the theory of ideals; R. Haussner, the numerical coefficients of Weierstrass's  $\sigma$ -series; G. Pick, invariant processes for higher binary forms; A. Schönflies, the hexagonoid of Eberhard; P. Bachmetjew, results as to electrical earth-currents in Bulgaria; E. Ritter, extension of the Riemann-Roch theorem to sets of forms; A. Sommerfeld, mathematical theory of the inflexion of light and electricity; W. Voigt, on piezoelectricity in crystals without a centre of symmetry.

BOOKS, PAMPHLETS, and SERIALS RECEIVED.

Books.—Cod Liver Oil and Chemistry: Dr. F. A. Müller (Peter Müller).—Mechanics: an Elementary Text-Book, Theoretical and Practical. Dynamics: R. F. Glazebrook (Cambridge University Press).—Colour Vision: Captain W. de W. Abney (Long).—The Student's English Dictionary: Dr. J. Ogilvie, new edition (Blackie).—The Story of the Stars: G. E. Chambers (Newnes).—Universal Electrical Directory, 1895 (Alabaster).—On the Geographical Distribution of Tropical Diseases in Africa: Dr. R. W. Felkin (Edinburgh, Clay).—Philosophy of Mind: Prof. G. T. Ladd (Longmans).

Pamphlets.—Le Service Chronométrique de l'Observatoire de Genève. No. 1. Prof. R. Gautier (Genève, Aubert Schuchardt).—Oxigen Polihédrico de las Especies: A. Soria y Lara (Madrid, Establecimiento Tipográfico).

Serials.—Engineering Magazine, February (Lucker).—Journal of the Franklin Institute, February (Philadelphia).—Himmel und Erde, February (Berlin, Paetel).—Internationales Archiv für Ethnographie, Band viii. Heft 1 (K. Paul).—Journal of the Anthropological Institute, February (K. Paul).—Journal of the Asiatic Society of Bengal, Vol. lxxiii. Part 2. No. 2 (Calcutta).—Astrophysical Journal, February (Wesley).—Journal of the Chemical Society, February (Gurney).

CONTENTS.

PAGE

Sir Andrew Crombie Ramsay . . . . .	385
Our Book Shelf:—	
Hill: "Harvard College by an Oxonian."—L. . . . .	386
Damesnil: "Tableau Métrique de Logarithmes" . . . . .	386
Rodway: "In the Guinea Forest. Studies of Nature in Relation to the Struggle for Life." (Illustrated) . . . . .	387
Willner: "Lehrbuch der Experimentalphysik."— <i>2<sup>e</sup></i> . . . . .	387
Muldenlof: "Peru. Beobachtungen und Studien über das Land und seine Bewohner während eines 25-jährigen Aufenthalts" . . . . .	388
Letters to the Editor:—	
The Liquefaction of Gases.—M. M. Pattison Muir . . . . .	388
Aurora. (Illustrated.)—Dr. J. H. Gladstone, F.R.S. . . . .	389
The Aurora of November 23, 1894.—W. H. Wood; Prof. A. S. Herschel, F.R.S. . . . .	390
The American Association. Dr. Wm. H. Hale . . . . .	390
Earthquake in Norway.—Dr. Hans Reusch . . . . .	390
"The Black-veined White Butterfly."—H. Goss . . . . .	391
The Zonal Light.—Rear-Admiral J. P. Maclear . . . . .	391
Oysters and Typhoid . . . . .	391
Notes . . . . .	392
Our Astronomical Column:—	
Mars in 1894 . . . . .	395
Novel Methods in Photometry . . . . .	395
Atmospheric Dispersion . . . . .	396
The Sun's Place in Nature. I. (Illustrated.) By J. Norman Lockyer, C.B., F.R.S. . . . .	396
Nathanael Pringsheim. By D. H. Scott . . . . .	399
The Antitoxic Serum Treatment of Diphtheria. By Dr. G. Sims Woodhead . . . . .	402
University and Educational Intelligence . . . . .	406
Scientific Serials . . . . .	406
Societies and Academies . . . . .	406
Books, Pamphlets, and Serials Received . . . . .	408

THURSDAY, FEBRUARY 28, 1895.

WHAT DOES THE CHEMIST MEAN  
BY "VALENCY"?

*Handbuch der Stereochemie.* Von Dr. C. A. Bischoff, unter Mitwirkung von Dr. P. Walden. II. Band (Schluss). (Frankfurt: H. Bechhold, 1894.)

THE author of the review of the first part of this book (*NATURE*, vol. xlix. p. 409) has given an account of it with which the present writer entirely agrees. Dr. Bischoff's book embodies a tolerably complete epitome of all that is known of a subject which at the present time has probably a larger number of cultivators than any other department of chemistry, and as a register of facts and references to original sources of information it is indispensable to the worker engaged upon stereochemical problems. On the other hand, the book is not only eminently unreadable, but the arrangement is sometimes far from clear.

Of this second and concluding volume about one third is occupied with an enumeration, continued from vol. i., of the various known cases of isomerism, inorganic as well as organic, which may be possibly referred to the geometrical hypothesis. The second third deals with chemical changes, such as ring formation and intramolecular changes regarded from the stereochemical point of view. The last part consists of additions to preceding pages, so as to bring the matter up to the most recent date possible. Examination of a volume such as this compels the reflection that spite of the great array of established fact, confusion still prevails among stereochemical writers, chiefly for want of some common agreement as to fundamental ideas.

"Atomicity," as it used to be called, meant originally the power exhibited by the several elements to combine in the proportions of one atom to 1, 2, 3, 4 or  $n$  atoms of some other element. Hence arose the idea of different atomic values in the process of exchanging one element for another. Later, from these notions about "quantivalence" it was assumed (without sufficient evidence) that when an atom, say, of carbon combines with four other atoms, the force of attraction or union for each of these four atoms is the same. Attempts were then made to estimate by thermal methods the mechanical value of each unit of "atomicity" or "quantivalence."

During all this time much discussion has occurred as to what becomes of units of "valency," to use the more modern term, which are not exercised as in unsaturated compounds generally, and Frankland's idea that even the "bonds" belonging to one and the same atom may saturate each other in pairs has been commonly used.

Since the observations of Van t'Hoff and Le Bel on the relations of chemical constitution to optical activity, and the revival of the hypothesis of spacial arrangements, and especially in the generally adopted theory of tetragonal carbon, the idea of *direction* which is implied in all space arrangements has been universally adopted. As to whether the direction in which valency can act is fixed or variable, opinion seems a little divided, and yet it is obvious that double linkage between two atoms, or the formation of any closed chain of tetragonal carbon

atoms whether conceived according to Van t'Hoff or Wunderlich, or otherwise, would be impossible on the assumption that the valency of carbon atoms can act only in certain directions which are quite fixed. Concerning this question the conclusion seems inevitable that we must suppose something analogous to a magnetic field between combining atoms.

But what, after all, is valency?

The fact is that while one atom of chlorine combines habitually with one atom of hydrogen, an atom of oxygen combines with two atoms of hydrogen, an atom of nitrogen with three, and so forth, and it is hardly assumption to say that so long as the hypothesis of atoms is used to express chemical combination, *some* geometrical arrangement of combined atoms in space is an inevitable part of the hypothesis. This was long ago pointed out by Wollaston. The valency of an element is then the numerical expression of its habit of combination. It is well known to be variable, and to depend to a great extent upon physical conditions. It may be that one atom can only act upon another in certain directions, but this does not render *necessary* the assumption that each atom is always doing something in these several directions, whether other atoms are present or not. This, however, is what is assumed by those who use the term "bond" in any of the recognised senses, or who attempt to determine the dynamical value of units of valency. There is some evidence in favour of the hypothesis that combination can only occur when atoms get within a certain maximum distance from each other, and the possibility that isomerism may result from changes in the distance between the atoms united within a molecule, is deserving of greater consideration than it has hitherto received. If we think, for example, of the exchange of an atom of chlorine for an atom of hydrogen in, say, marsh gas, it is difficult to believe that the chlorine atom occupies exactly the same place relatively to the carbon as the hydrogen atom for which it is substituted. Reasons may possibly be found for this in the difference of the force of "affinity" between carbon and chlorine on the one hand, and between carbon and hydrogen on the other, or it may result from the "residual valency" of chlorine acting upon the neighbouring hydrogen atoms, or from the difference of "mass" of the chlorine and hydrogen. But throughout all the various hypotheses used generally by chemists, runs the idea of direction variable within narrow limits, already referred to. Now, however much the direction along which a force acts may be supposed to vary according to circumstances, it is inconceivable on any mechanical principle that one force can act in several directions at once unless there is reason to suppose that it is divided in some way into component forces. Hence the "centric" formula for benzene, which has lately come into vogue, represents a wholly new idea which is incompatible with previously received ideas about valency and with the hypothesis of the tetragonal carbon atom. According to this formula an atom of carbon is capable of acting in eight different directions that is, it acts directly, in the conventional sense, upon one atom of hydrogen and upon two atoms of carbon, at the same time that it "influences" these two atoms of carbon and three others. This idea is wholly unnecessary to the explanation of the stability of the benzene

molecule. It can be accounted for quite simply in other ways, but its chief show prevalent is the idea that valency means, not only the power to do something, but that that power is always being exercised, and that in every chemical formula every unit of valency must be accounted for. This example is sufficient to illustrate the state of affairs in about valency and chemical combination, which seems to grow more serious and more tangled every day.

The doctrine of Stereoisomerism as at present used may be compared to the fluid theory of electricity. It is a working theory which some day, perhaps, will be superseded, but no great advance is likely to be made until some more clear idea as to the meaning of valency can be brought into use. In the meantime experimental inquiry is undoubtedly proceed-

near Eaux Chaudes. The impression, at a later date, was deepened by the marvels of Adelsberg; and a visit to Han-sur-lesse (Belgium) in 1888, determined him to explore thoroughly the swallow-holes and caves of Les Causses—the limestone plateaux to the south and west of the Cevennes and Auvergne—with which he had already made acquaintance. Here the rivers often flow through deep gorges—almost cañons, such as is illustrated by Fig. 1. In 1888 and the following year the author investigated the underground topography of the Departments of Lozère and Gard, and then extended his researches from Vaucluse to La Charente, going as far as the Puy-de-Dôme, the Côte-d'Or, and Provence, and, yet further afield, to Belgium, the Karst, and the Peloponnesus. Altogether he explored 230 "holes in the



FIG. 1.—Cañon de la Baume.

ing rapidly, and will prepare the way for the next step in theory. To the reader such a book as Bischoff's "Stereochemie" will afford much assistance in the laboratory, and can be safely recommended to all who are working in this direction. W. A. T.

CIVILS AND SWALLOW-HOLES.

*Les Abîmes, les sources souterraines, les cavernes, les gouffres et les grottes.* By E. A. Martel. 4 phototypes and 16 plans, with 100 smaller illustrations. Paris: C. Delagrave, 1914.

At the outset the author remarks that the man is a lumpy who realises in ripe manhood a project of boyhood. As a youth he was fascinated by the stalactites of the cave of Gargas, and the underground stream

rock," which he thus classifies: Swallow-holes (*abîmes*) 110, into 90 of which no descent had been previously made; emissaries of rivers (*sources*), 40, up 30 of which no one had penetrated; caves, 80, of which 45 were but imperfectly known. Besides these he had sounded, without descending, 35 swallow-holes, and examined 55 large emissaries, which could not be entered. Plans were made of underground galleries, the total length of which amounts to 50 kilometres; rather more than half the work being done by himself, the rest by collaborators. The result of this indefatigable, and sometimes rather risky, work is the most complete original memoir on "cave hunting" that has ever been published, a quarto volume of nearly 600 pages, containing many plans, and still more numerous illustrations, the latter mostly from photographs, together with a full bibliography of the subject.



To give any account of even the caverns of the Causses, which occupy the larger part of the book, would occupy too much space; so we content ourselves with a brief sketch of one of the most remarkable—that of Padirac, in the Causse de Grammat; and, after all, caves generally exhibit a strong family likeness. On a rocky plain a gulf, nearly forty yards across, opens out suddenly, as shown in Fig. 2, for which and the one on p. 410, we are indebted to the courtesy of the publishers. The greatest depth is just over twice the breadth, but a huge pile of debris rises from the bottom up to nearly fifty-nine yards from the surface. This leads on either side to a gallery. One of these ascends gently upwards, for about a couple of hundred yards, to a spot where a stream bursts from the rock. The other gallery,

Alps, being most frequent in the more eastern region, where sometimes a bare rocky tract is almost riddled by swallow-holes (*dolinas*) great or small. From the Karst district they may be followed through the Alps of Dalmatia into the limestone region of Greece; they exist also in the carboniferous limestone of England, Belgium, and America. One might almost say *ubi calx, ibi spelunca*.

M. Martel notices, but appears to have paid less attention to, the curious caves called *glacières*, so pleasantly described by Canon Browne in his "Ice Caves of France and Switzerland." In these the walls are hung with sheets and festoons of ice, and thick masses of it cover the floors. In summer-time the temperature inside them keeps very near to the freezing-point. M.

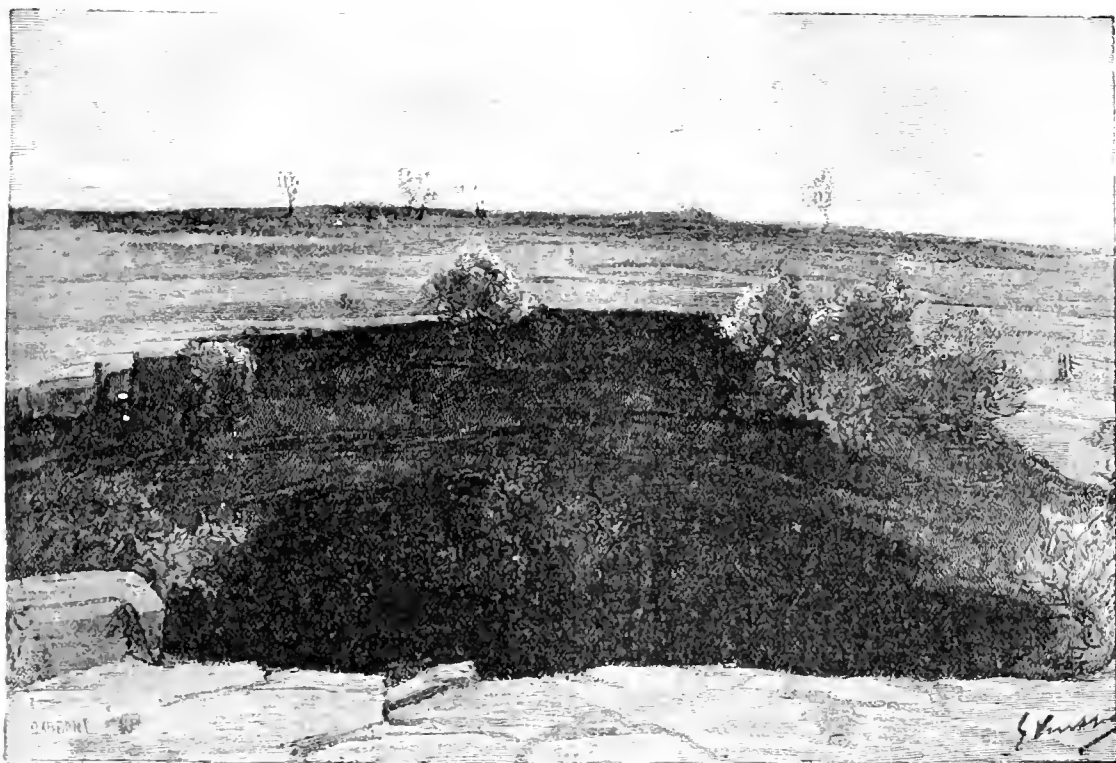

FIG. 2.—Shaft leading to the Cave of Padirac.

which is also traversed by this stream, extends for about a mile and three-quarters, following a rather serpentine course, which, in one part, bends at right angles to its former direction. At last it ends in a lake and a *cul de sac*. The cave is generally rather narrow, not many feet in width, but here and there broadens out into a large hall; the roof, also, rises and falls, its height not unfrequently being from forty to sixty feet—occasionally a good deal more. Padirac contains stalactites, stalagmites, and basin-shaped deposits of calcic carbonate; in short, is a thoroughly typical cave, with the not infrequent addition of a huge swallow-hole. Dozens of similar caverns may be found in this curious limestone region. They are abundant, under various names, in the Jura and in the limestone districts of the

Martel suggests that in winter they become filled with cold air, which remains there like the carbonic anhydride in a *grotto d'été*. But such as we have seen, appear to be better explained as natural ice-houses, where the summer warmth is insufficient to dispose of the snow and ice which had accumulated in the winter.

Is it possible that occasionally these swallow-holes and caves may be memorials of an age when the climate was colder than it is at present? Both are sometimes dry. In the case of the cave, this may be explained by the water having worked out a new, and as yet undiscovered, path; but some swallow-holes open out, like the mouths of wells, on gentle slopes or rocky plains, apparently disconnected from any system of drainage. They seem too large to be explained—like those countless pipes in

the rock of the *S. in. m. M. r.*—as only the work of rain. Is it possible that they were chiefly excavated in the Glacial epoch, when many elevated rocky plateaux would be buried under permanent, or nearly permanent, snow-beds, the drainage from which would give a supply of water, which was engulfed before it had the opportunity of excavating a glen? Some things seem not unfavourable to this suggestion. T. G. BONNEY.

#### OUR BOOK SHELF.

*Bulletin of the Botanical Department, Jamaica.* April 1887 to September 1894. Edited by the Director, W. Fawcett, B.Sc. Published by the Department of Public Gardens and Plantations.)

SINCE the increase of botanical stations in the British West Indies, there has been greater activity in the older establishments, and the Directors have followed the example of Kew, in issuing a monthly budget of information useful to planters and others, whether they plant for profit or pleasure. We have lately received a complete file of the organ of the Jamaica Garden, bearing the above title. This was started in 1887, and it has increased from a single page of foolscap size to a sheet of ordinary octavo; and the price is only twopence. The contents are of a varied and miscellaneous nature; but information on the cultivation and diseases of economic plants, and on the value and preparation of their products, largely predominates. It includes not only the results of local experience; the editor has also drawn upon the numerous sources open to him, thanks to the more intimate connection between similar establishments throughout the empire, due, to a large extent, to the efforts of the Director of Kew.

Among other things, there are lists of the economic plants, of plants yielding edible fruits, and of trees useful either for timber or shade, cultivated in the Jamaica botanic garden. Botanical and common names are given, as well as the native countries of the respective plants, together with the prices of seeds or plants at which they are offered to the inhabitants of the island. The prices, it may be mentioned, are ridiculously low; merely nominal, in fact. Free grants are also made; but in order to avoid waste of valuable plants, the conditions are somewhat stringent, though not more so than in intelligent and earnest cultivator would cheerfully submit to. Another interesting feature is Mr. Jeaman's descriptive enumeration of the Ferns of Jamaica. This was commenced in 1890, and is still unfinished. It is to be hoped that this will some day be issued separately, as the Fern-vegetation of Jamaica is perhaps the richest in the world, comprising between 40 and 500 species.

*Die Maschinen in Hilfsmittel der Chemischen Technik.* Von A. Pannicke, Civ. Ingenieur, vorm. Oberingenieur der Chemischen Fabrik Griesheim. (Frankfurt: H. Bechhold, 1894.)

WE are accustomed to hear little but praise of the German University system of education. There is, however, a reverse to the shield. While admitting the value of the training received by the University student in pure chemistry, the author of this work points out that only in a few of the higher technical schools is any systematic instruction given concerning the employment of machinery in manufacturing chemistry. The consequence is that many young chemists find, at the commencement of their practical career, that they have either to laboriously collect, from many scattered and not easily accessible sources, the information they require, or perforce remain mere copyists of the methods of others, for lack of the knowledge which might enable them to intelligently use the mechanical appliances best suited to attain their ends.

The work under review represents an endeavour to lessen the difficulties in this direction. In some 290 pages, a synopsis is presented of the principal mechanical arrangements with which the chemist may be concerned. A vast amount of information is set out in well-arranged sequence, and, though many of the descriptions are necessarily somewhat sketchy on account of the large number of appliances to be described, a study of the pages before us cannot fail to be of great use to the limited class for whom they were written. The book is well illustrated, having no fewer than 357 figures: these would have possessed a much greater value had dimensions been more generally given. From the point of view of the highly-trained chemist, it is perhaps to be regretted that valuable space is occupied by descriptions of certain machines of well-known types, such as common weighing machines. No doubt the volume is rendered more complete by the inclusion of such matter, yet it would seem of far greater importance that a chapter should have been added dealing with the many useful types of pressure and temperature regulators and their applications. It could hardly be expected that all parts of the book should be equally up to date; the account given of pyrometers is notably incomplete, no mention being made, for instance, of the now well-known instrument designed by Le Chatelier. English students may find in this compilation a useful index serving as a guide to direct their attention to the most important mechanical devices used in chemical operations; but we think that they will benefit more by undertaking the additional labour of unearthing details from the many admirable treatises and dictionaries already in existence in their own language. W. T.

*Air, Water, and Disinfectants.* (Manuals of Health Series.) By C. M. Atkman, M.A., D.Sc. Pp. 126. (London: S. P. C. K., 1895.)

THIS little book contrives to tell us a great many most interesting and instructive facts, without for one moment running the risk of boring us. It is written in an attractive style, and whilst popular, the author never forgets what is due to the subjects he is discussing.

Microbes, not perhaps, without reason, furnish material for a substantial portion of the text, and free use is made of "Our Secret Friends and Foes," which, however, Dr. Atkman amply acknowledges.

The little section on "Dust particles in the air" contains an interesting *resumé* of Dr. Atken's investigations, and as they have been, we believe, chiefly published in Edinburgh scientific journals, will doubtless suggest much that is novel to the general reader. Many such will be astonished to learn "that a cigarette smoker sends 400,000,000 particles of dust, more or less, into the air with every puff he makes," and that one cubic inch of the air of a room at night, when the gas is burning, may contain as many dust particles as there are inhabitants of Great Britain!

We cordially recommend this little book to all those who wish to obtain an accurate, though popular, idea of the nature of air, water, and disinfectants.

*An Elementary Text-book of Anatomy.* By Prof. H. E. Clark. (London: Blackie and Son, 1895.)

A TEXT-BOOK of anatomy, suitable as an introduction to junior students of medicine, and simple enough to be understood by all who wish to read about the structure of their bodies. The book is limited to the anatomy of the human subject, and is divided into seven sections, dealing respectively with the tissues, bones, joints, muscles, vessels (the heart, blood-vessels, and lymphatic vessels), nervous system, and internal organs. It contains numerous instructive illustrations, as well as a useful glossary, and is altogether a serviceable elementary manual of anatomy.

## LETTERS TO THE EDITOR.

[The Editor does not hold himself responsible for opinions expressed by his correspondents. Neither can he undertake to return, or to correspond with the writers of, rejected manuscripts intended for this or any other part of NATURE. No notice is taken of anonymous communications.]

## Liquefaction of Gases.

IN a long letter which you published in NATURE of February 14, Mr. Pattison Muir charged me with appropriating the work of Olszewski and passing it off as my own. I replied at some length, not on account of the intrinsic importance of the attack, but because there are always persons ready to assume that a charge of this kind, by whomsoever made, must be unanswerable unless it is answered. But as I can conceive nothing more uninteresting to your readers or myself, than a mere dialectical controversy with Mr. Muir, my reply to his letter published on the 21st will be brief.

"A careful study" of my previous letter has not enabled Mr. Muir to substantiate his original charge of wilful piracy. On the contrary, he entirely shuts his ground. He extracts four clauses from my reply and proceeds to deal with them, ignoring altogether the only question of the smallest importance, namely, the one claim made by himself to have convicted me of dishonest appropriation of another man's work.

The third claim found in my reply by Mr. Muir, which is the all-important one, is, to use his own language, that in "1886 I liquefied oxygen by passing the gas through a long copper coil surrounded by liquid ethylene, and that my apparatus made it possible to transfer the liquid oxygen to a glass vessel wherein it could be used as a cooling agent." Well, the only question here is whether I did or did not do what I claim to have done in a public lecture delivered and published in the year 1886, and this question Mr. Muir shirks.

Until Mr. Pattison Muir can declare that after trial an apparatus constructed according to the plan given in 1886 is essentially defective, and will not deliver liquid oxygen in a manner at all comparable to the Olszewski steel cylinder, described in the Cracow *Bulletin* of 1890, let him acknowledge at least that the case of Prof. Olszewski, which he championed in his last letter, will have to be abandoned.

Having failed to overthrow a single one of the claims which he himself after "careful study" holds me to have made, Mr. Muir falls back upon a general attack upon the scientific work "that is attributed to the Fullerian Professor at the Royal Institution." With what is attributed to me by others, I have no concern. The low temperature work that has been commenced and so far developed in the laboratory of the Royal Institution comprises the following subjects: Construction of apparatus for the production of liquid air and other gases in quantity, improving high vacuum, vacuum vessels for storage and manipulation of liquid gases, solid air, radiation at low temperatures, thermal transparency of liquid gases, refractive indices of oxygen, nitrogen, and air; spectroscopy of liquid oxygen and air, thermo-electric inversions, latent and specific heats, chemical action, magnetic properties, breaking stress of metals, solid matter and argon in liquid air, phosphorescence and photographic action, liquefaction of hydrogen, &c. The abstracts of the results of these investigations have been published, and if Mr. Pattison Muir would only take a little trouble he could find them. In due course, and when I think proper, fuller details will be published. Mr. Muir's case is, however, that my intellectual pap comes from Cracow, and that I have followed in the wake of the researches of his client. On referring to Prof. Olszewski's record of work since his alleged invention of the way to use liquid oxygen as a cooling agent in 1890, I find that with the exception of the refractive index of oxygen, which was anticipated by Prof. Leving and myself, and an attempt to confirm the late Prof. Wroblewski's critical constants of hydrogen, the work carried on at the Royal Institution and at Cracow have had nothing in common. It is not my business to inquire why Prof. Olszewski should take five years over this work, any more than it is legitimate for Mr. Muir to complain that I ought to have done more with my apparatus of 1886, than cool a piece of meteorite or expand liquid oxygen into a vacuum. No doubt by implication Mr. Muir intends to convey that any success at the Royal Institution was due to the use of a steel cylinder instead of the copper coil of 1886, and that suggestion I have to emphatic-

ally contradict, seeing that a steel cylinder never was used in any part of the apparatus employed for the liquefaction of gases. Under the circumstances it will be for Mr. Pattison Muir to explain what new information I could derive from Prof. Olszewski's alleged invention of 1890 which had not been already involved in the construction and use of my 1886 apparatus. All this, however, does not relieve Mr. Muir from his embarrassment. He charged me with having attributed to myself work done by other men, and to this charge I pin him. Having failed in his first attack, he has changed his ground, ignored the evidence of facts and facts which he cannot overthrow, and made a second attack in a form chosen by himself. This also has failed ignominiously. It is to be hoped that in future, when scientific investigators enter on priority discussions, the real combatants will be left to their polemics without the interference of third persons.

Royal Institution, February 26.

JAMES DEWAR.

## On Certain Questions of the Theory of Gases.

§ 1. I PROPOSE to answer two questions:—

(1) Is the Theory of Gases a true physical theory as valuable as any other physical theory?

(2) What can we demand from any physical theory?

The first question I answer in the affirmative, but the second belongs not so much to ordinary physics (let us call it orthophysics) as to what we call in Germany metaphysics. For a long time the celebrated theory of Boscovich was the ideal of physicists. According to his theory, bodies as well as the ether are aggregates of material points, acting together with forces, which are simple functions of their distances. If this theory were to hold good for all phenomena, we should be still a long way off what Faust's *faulus* hoped to attain, viz. to know everything. But the difficulty of enumerating all the material points of the universe, and of determining the law of mutual force for each pair, would be only a quantitative one; nature would be a difficult problem, but not a mystery for the human mind.

When Lord Salisbury says that nature is a mystery,<sup>1</sup> he means, it seems to me, that this simple conception of Boscovich is refuted almost in every branch of science, the Theory of Gases not excepted. The assumption that the gas-molecules are aggregates of material points, in the sense of Boscovich, does not agree with the facts. But what else are they? And what is the ether through which they move? Let us again hear Lord Salisbury. He says:

"What the atom of each element is, whether it is a movement, or a thing, or a vortex, or a point having inertia, all these questions are surrounded by profound darkness. I dare not use any less pedantic word than entity to designate the ether, for it would be a great exaggeration of our knowledge if I were to speak of it as a body, or even as a substance."

If this be so—and hardly any physicist will contradict this—then neither the Theory of Gases nor any other physical theory can be quite a congruent account of facts, and I cannot hope with Mr. Burbury, that Mr. Bryan will be able to deduce all the phenomena of spectroscopy from the electromagnetic theory of light. Certainly, therefore, Hertz is right when he says:<sup>2</sup> "The rigour of science requires, that we distinguish well the undraped figure of nature itself from the gay-coloured vesture with which we clothe it at our pleasure." But I think the predilection for nudity would be carried too far if we were to forego every hypothesis. Only we must not demand too much from hypotheses.

It is curious to see that in Germany, where till lately the theory of action at a distance was much more cultivated than in Newton's native land itself, where Maxwell's theory of electricity was not accepted, because it does not start from quite a precise hypothesis, at present every special theory is old-fashioned, while in England interest in the Theory of Gases is still active; *viz.*, among others, the excellent papers of Mr. Tait, of whose ingenious results I cannot speak too highly, though I have been forced to oppose them in certain points.

Every hypothesis must derive indubitable results from mechanically well-defined assumptions by mathematically correct methods. If the results agree with a large series of facts, we must be content, even if the true nature of facts is not

<sup>1</sup> Presidential Address to the British Association at Oxford.

<sup>2</sup> Hertz, "Untersuchungen über die Ausbreitung der elektrischen Kraft," p. 11. (Harth, Leipzig, 1892.)

revealed in every respect. No one hypothesis has hitherto attained this position, the Theory of Gases not excepted. But this theory agrees in so many respects with the facts, that we can hardly doubt that in gases certain entities, the number and size of which can only be determined, fly about pell-mell. Can we not so easily expect that they will behave exactly as aggregates of Newtonian centres of force, or as the rigid bodies of the *Mechanica*? And how awkward is the human mind in finding the nature of things, when forsaken by the analogy of what we see and touch directly?

Let us follow assumptions, while not professing to explain the phenomena which Lord Kelvin's allusion, nevertheless, shows to be possible, to explain the spectra of gases while ascribing 5 degrees of freedom to the molecules, and without departing from Bose-vich's standpoint.

Let the molecules of certain gases behave as rigid bodies, the molecules of the gas and of the enclosing vessel move through the ether without loss of energy as rigid bodies, or as Lord Kelvin's vortex rings move through a frictionless liquid in ordinary hydro-dynamics. If we were to take a vessel filled with one gram of gas kept during an infinitely long time always at 0° C. and containing always the same portion of ether, every atom of ether and every atom of our gas-molecules would reach the same average temperature. If then we were to raise the temperature to 1° C. and to wait till every ponderable and every ethereal atom was in thermal equilibrium, the total energy would be augmented by what we may call the ideal specific heat. But in actually heating one gram of gas, the ether always flows freely through the walls of the vessel. It comes from the universe, and is not at all in thermal equilibrium with the molecules of the gas. It is true that it always carries off energy, if the outside gas is colder than the gas; but this energy may be so small as to be quite negligible in comparison with the energy which the gas loses by heat-conduction, and which must be experimentally determined and subtracted in measuring the specific heat. Only certain transverse vibrations of the ether can transfer sensible energy from one ponderable body to another, either for a correction for radiant heat-must be applied to the variations of specific heats. These transverse vibrations are not produced (as in the older theories of light) by simple atomic vibrations, but their pitch depends on the shape of the hollow space which the molecule forms in the ether, just as Hertzian rays are not caused by vibrations of the ponderable matter of the body itself, the form of which only determines the pitch. Finally, an electric action accompanying a chemical process augments these transverse vibrations continuously. The general vibrations of the ether, on which these vibrations depend, vary in the same manner as the coordinates which determine the position of a molecule, because the entire ether has not yet attained into thermal equilibrium with the gas molecules. It has in no respect attained the state which it can assume if it were enclosed for an infinitely long time in the universe of the molecules of the gas.

Let us now ask: Do the molecules of a gas behave as rigid bodies? Are they composed of smaller atoms? Probably they are; otherwise the total internal vibrations is transformed into a motion which takes place so slowly, that when a gas is heated, the atoms require to the molecules may return for a long time to their original temperature. This random motion which takes place so slowly that it can be neglected in all calculations of temperature of the molecules, is not in reality the transference of energy along the walls of the vessel, if we also attribute to the ether the same motion. The Earth is not sensibly affected by the motion of the ether which flows freely through her.

If the ether is not transformed into heat, how is it that we can heat a body by radiation? Is the energy of the gas transformed into heat by the source of energy of the ether? Let us suppose that a pair of two gas molecules, one moving in the positive and the other in the negative direction, are separated, and that the energy of the ether is transformed into heat by the ether.

Let us now consider a certain ordinate  $H_1$  ( $H$  (min.)). Two cases are possible.  $H_1$  may be very near the top of a summit, so that  $H$  decreases if we go either in the positive or negative direction along the axis representing time. The second

It may be objected that the above is nothing more than a series of imperfectly proved hypotheses. But granting its improbability, it suffices that this explanation is not impossible. For then I have shown that the problem is not insoluble, and nature will have found a better solution than mine.

§ 2. Mr. Culverwell's objections against my Minimum Theorem bear the closest connection to what I pointed out in the second part of my paper, "Bemerkungen über einige Probleme der mechanischen Wärmelehre," *Sitz. ber. der k. Wien. Acad.* vol. lxxv, 1877. There I pointed out that my Minimum Theorem, as well as the so-called Second Law of Thermodynamics, are only theorems of probability. The Second Law can never be proved mathematically by means of the equations of dynamics alone.

Let us compare two motions of a dynamical system. At the beginning of the second motion, let the coordinates specifying the position of every part of the moving system, and the magnitudes of all the corresponding velocities, be the same as they were at the end of the first motion, but let the direction of every velocity be exactly reversed. Then in the second motion the system moves exactly in the opposite way to what it does in the first; hence, if for the first motion we have

$$\int \frac{dQ}{T} = 0,$$

then for the second we must have

$$\int \frac{dQ}{T} > 0.$$

That is, if under certain conditions

$$\int \frac{dQ}{T} = 0,$$

we can always find other initial conditions which give for the same system with the same equations of motion,

$$\int \frac{dQ}{T} < 0.$$

In the same manner, Mr. Culverwell wishes to refute my Minimum Theorem. Mr. Culverwell's reasoning is suspicious, because by the same reasoning we could prove that oxygen and nitrogen do not diffuse. Suppose that initially one half of a closed vessel contains pure oxygen, and in the other half pure nitrogen; when the diffusion has advanced for a certain time, reverse the directions of all velocities, then the gases separate again, and, according to Mr. Culverwell's argument, we could believe that the probability that oxygen and nitrogen separate, is as great as the probability that they mix.

Though interesting and striking at the first moment, Mr. Culverwell's arguments rest, as I think, only upon a mistake of my assumptions. It can never be proved from the equations of motion alone, that the minimum function  $H$  must always decrease. It can only be deduced from the laws of probability, that if the initial state is not specially arranged for a certain purpose, but haphazard governs freely, the probability that  $H$  decreases is always greater than that it increases. It is well known that the theory of probability is as exact as any other mathematical theory, if properly understood. If we make 1000 throws with dice, we cannot prove that we shall throw any particular number exactly 1000 times; but we can prove that the ratio of the number of throws in which that number turns up to the whole number of throws, approaches the more to 1/6 the oftener we throw.

Let us now take a given rigid vessel with perfectly smooth and perfectly elastic walls containing a given number of gas-molecules moving for an indefinitely long time. All regular motions (i.e., one where all the molecules move in one plane) shall be excluded. During the greater part of this time  $H$  will be very nearly equal to its minimum value  $H$  (min.). Let us construct the  $H$ -curve, i.e., let us take the time as axis of abscissae and draw the curve, whose ordinates are the corresponding values of  $H$ . The greater majority of the ordinates of this curve are very nearly equal to  $H$  (min.). But because greater values of  $H$  are not mathematically impossible, but only very improbable, the curve has certain, though very few, summits or maximum ordinates which rise to a greater height than  $H$  (min.).

We will now consider a certain ordinate  $H_1$  ( $H$  (min.)). Two cases are possible.  $H_1$  may be very near the top of a summit, so that  $H$  decreases if we go either in the positive or negative direction along the axis representing time. The second

case is, that  $H_1$  lies in a part of the curve ascending to or descending from a higher summit. Then the ordinates on the one side of  $H_1$  will be greater, and on the other less than  $H_1$ . But because higher summits are so extremely improbable, the first case will be the most probable, and if we choose an ordinate of given magnitude  $H_1$  guided by haphazard in the curve, it will be not certain, but very probable, that the ordinate decreases if we go in either direction.

We will now assume, with Mr. Culverwell, a gas in a given state. If in this state  $H$  is greater than  $H$  (min.) it will be not certain, but very probable, that  $H$  decreases and finally reaches not exactly but very nearly the value  $H$  (min.), and the same is true at all subsequent instants of time. If in an intermediate state we reverse all velocities, we get an exceptional case, where  $H$  increases for a certain time and then decreases again. But the existence of such cases does not disprove our theorem. On the contrary, the theory of probability itself shows that the probability of such cases is not mathematically zero, only extremely small.

Hence Mr. Burbury is wrong, if he concedes that  $H$  increases in as many cases as it decreases, and Mr. Culverwell is also wrong, if he says that all that any proof can show is, that taking all values of  $dH/dt$  got from taking all the configurations which approach towards a permanent state, and all the configurations which recede from it, and then striking some average,  $dH/dt$  would be negative. On the contrary, we have shown the possibility that  $H$  may have a tendency to decrease, whether we pass to the former or to the latter configurations. What I proved in my papers is as follows: It is extremely probable that  $H$  is very near to its minimum value; if it is greater, it may increase or decrease, but the probability that it decreases is always greater. Thus, if I obtain a certain value for  $dH/dt$ , this result does not hold for every time-element  $dt$ , but is only an average value. But the greater the number of molecules, the smaller is the time-interval  $dt$  for which the result holds good.

I will not here repeat the proofs given in my papers; I will only show that just the same takes place in the much simpler case of dice. We will make an indefinitely long series of throws with a die. Let  $A_1$  be the number of times of throwing the number 1, among the first  $6n$  throws,  $A_2$  the number of times of throwing 1, among all the throws between the second and the  $(6n+1)$ th inclusive, and so on. Let us construct a series of points  $n$  a plane, the successive abscissæ of which are

$$0, \frac{1}{n}, \frac{2}{n}, \frac{3}{n}, \dots$$

the ordinates of which are

$$y_1 = \left(\frac{A_1}{n} - 1\right)^2, y_2 = \left(\frac{A_2}{n} - 1\right)^2, \dots$$

let us call this series of points the "P-curve." If  $n$  is a large number, the greater proportion of the ordinates of this new curve will be very small. But the P-curve (like the aforementioned H-curve) has summits which are higher than the ordinary course of the curve. Let us now consider all the points of the P-curve, whose ordinates are exactly = 1. We will call these points "the points B." Since for each point  $y = (A/n - 1)^2$ , therefore for the points B we have  $A = 2n$ : these points mark, therefore, the case where, by chance, we have thrown the number 1 in  $2n$  out of  $6n$  throws. If  $n$  is at all large, that is extremely improbable, but never absolutely impossible. Let  $v$  be a number much smaller than  $n$ , and let us go forward from the abscissa of each point B through a distance =  $6v/n$  in the direction of  $x$  positive. We shall probably meet a point, the ordinate of which  $< 1$ . The probability that we meet an ordinate  $> 1$  is extremely small, but not zero. By reasoning in the same manner as Mr. Culverwell, we might believe that if we go backward (*i.e.* in the direction of  $x$  negative) from the abscissa of each point B through a distance =  $6v/n$ , it would be probable that we should meet ordinates  $> 1$ . But this inference is not correct. Whether we go in the positive or in the negative direction the ordinates will probably decrease.

We can even calculate the probable diminution of  $y$ . We have seen that for every point B we have  $A = 2n$  (*i.e.*  $2n$  throws out of  $6n$  turning up 1). If we move in the positive or negative direction along the axis of  $x$  through the distance  $1/n$ , we exclude one of the  $6n$  throws, and we include a new one. When we move forward through the distance  $6v/n$ , we have excluded  $6v$

of the original throws, and included  $6v$  others. Among the excluded throws we have probably  $2v$ , among the included ones  $v$  throws of the number 1. Therefore the probable diminution of  $A$  is  $v$ , the probable diminution of  $y$  is  $2v/n$  approximately. Because the variation of  $A$  was  $6v/n$ , we may write

$$\frac{dy}{dx} = \frac{1}{3}$$

But this is not an ordinary differential coefficient. It is only the average ratio of the increase of  $y$  to the corresponding increase of  $x$  for all points, whose ordinates are = 1. The P-curve belongs to the large class of curves which have nowhere a uniquely defined tangent. Even at the top of each summit the tangent is not parallel to the  $x$ -axis, but is undefined. In other words, the chord joining two points on the curve does not tend towards a definite limiting position when one of the two points approaches and ultimately coincides with the other.<sup>1</sup> The same applies to the H-curve in the Theory of Gases. If I find a certain negative value for  $dH/dt$ , that does not define the tangent of the curve in the ordinary sense, but it is only an average value.

§ 3. Mr. Culverwell says that my theorem cannot be true because if it were true every atom of the universe would have the same average *vis viva*, and all energy would be dissipated. I find, on the contrary, that this argument only tends to confirm my theorem, which requires only that in the course of time the universe must tend to a state where the average *vis viva* of every atom is the same and all energy is dissipated, and that is indeed the case. But if we ask why this state is not yet reached, we again come to a "Salisbury mystery."

I will conclude this paper with an idea of my old assistant, Dr. Schuetz.

We assume that the whole universe is, and rests for ever, in thermal equilibrium. The probability that one (only one) part of the universe is in a certain state, is the smaller the further this state is from thermal equilibrium; but this probability is greater, the greater is the universe itself. If we assume the universe great enough, we can make the probability of one relatively small part being in any given state (however far from the state of thermal equilibrium), as great as we please. We can also make the probability great that, though the whole universe is in thermal equilibrium, our world is in its present state. It may be said that the world is so far from thermal equilibrium that we cannot imagine the improbability of such a state. But can we imagine, on the other side, how small a part of the whole universe this world is? Assuming the universe great enough, the probability that such a small part of it as our world should be in its present state, is no longer small.

If this assumption were correct, our world would return more and more to thermal equilibrium; but because the whole universe is so great, it might be probable that at some future time some other world might deviate as far from thermal equilibrium as our world does at present. Then the afore-mentioned H-curve would form a representation of what takes place in the universe. The summits of the curve would represent the worlds where visible motion and life exist.

LUDWIG BOLZMANN.

Imperial University of Vienna.

### Oysters and Typhoid.

WITH reference to the article "Oysters and Typhoid," which appeared in your last issue, it may interest your readers to know that De Giaxa investigated some years ago the behaviour of the typhoid bacillus in sea-water, both in its natural and sterilised condition. He found that in ordinary sea-water the typhoid bacillus suffered very considerably in the competition with the numerous other water bacteria present, but it was still identified on the ninth day after it was first introduced. In sea-water in which all other bacteria had been destroyed, the typhoid bacillus was detected in very appreciable numbers on the twenty-fifth day. More recently, however, the existence of typhoid bacilli in sterilised sea-water has been examined by Cassedebat, and his results are not in accord with those obtained by Giaxa. Cassedebat found that whilst many pathogenic

<sup>1</sup> See Ulisse Dini, "Grundlagen für eine Theorie der Functionen einer reellen Veränderlichen" (Leubner, 1873, s. 117), or Weierstrass, *Journal für die Mathematik*, Band 79, p. 27.

bacteria, amongst which were those of anthrax and cholera, lived for several days, in the case of the former twenty-one to twenty-four days, and in that of the latter thirty-five days and even longer; typhoid bacilli were destroyed already in the course of forty-eight hours in sterilised sea-water. These results tend to confirm those obtained by Prof. Percy Frankland, who, in his last report to the Royal Society Water Research Committee, states that the addition of 1 and 3 per cent. of common salt to ordinary Thames water into which typhoid bacilli were introduced, acted very prejudicially on the latter, although it did not prevent the multiplication of many forms of water bacteria in a most astonishing manner. Similar results were obtained with salted but sterilised Thames water infected with typhoid bacilli, and not only did the latter disappear very rapidly, but the typhoid colonies which were obtained on plate-cultures from this salt water exhibited in some cases a very peculiar appearance, attributable to the degeneration of the typhoid bacilli under these conditions, for on passing such colonies through a farther process of plate-culture, they returned to their ordinary type.

Giannini experimented with fish, introducing pathogenic microbes *per os*. Unfortunately, he did not select the typhoid bacillus for these experiments, but took instead cultures of cholera and anthrax bacilli. He found that in both cases these micro-organisms were entirely destroyed in the course of a few hours. Experiments were also made with oysters and some varieties of mussel-fish. A small hole was bored in the shell, and vigorous broth cultures of anthrax and cholera bacilli were respectively introduced, after which the aperture was carefully closed with sealing-wax, and whilst some of the molluscs were replaced in sea water, others were kept in glass dishes without any water. The latter lived for two days under these conditions. Six hours after the injection had taken place, and again at the end of twenty-four and forty-eight hours, the sealing-wax was removed and a small quantity of the fluid within the shell was taken out and plate-cultures made. In the majority of the experiments these pathogenic microbes had completely disappeared in six hours, whilst in only two instances were they detected in small numbers at the end of twenty-four hours, and in no case were they identified after forty-eight hours. These results were irrespective of whether the mollusc was kept in or out of water. In these investigations, therefore, there would appear to be no evidence that these pathogenic microbes (cholera and anthrax) were capable of being transmitted by means of these shell-fish. So far as I am aware, no one has followed up these interesting experiments, and in view of the serious allegations which have lately been made against oyster as transmitters of typhoid fever, it is a subject which might well claim re-investigation.

February 13.

G. C. FRANKLAND.

The Occurrence of very Cold Days.

I have tried to estimate cold by minima of temperature. But we may also consider it as expressed in maxima. A day may fairly be called "very cold" in which the maximum is not over freezing point. I propose to offer some account of the occurrence of these days at Greenwich in the fifty winter seasons (November to March, 1844-5 to 1893-4). (For brevity, I will designate each winter by the year in which it begins.)

The number of these days are not very frequent. In some winters there are none. The highest number is 27. The list is as follows:

1844	11	1861	5	1878	18
45	—	62	—	79	10
46	11	63	4	80	12
47	4	64	5	81	—
48	2	65	—	82	2
49	7	66	—	83	—
50	—	67	6	84	4
51	—	68	4	85	3
52	—	69	—	86	5
53	4	70	—	87	5
54	15	71	4	88	2
55	1	72	4	89	1
56	4	73	—	90	27
57	2	74	—	91	5
58	1	75	4	92	0
59	6	76	—	93	5
60	0	77	—		

[Total] 251

The total, 251, gives an average of 5.02 for each season. Ten of the winters had none of those days, and fifteen had numbers over the average.

The distribution in months was as follows:—

November.	December.	January.	February.	March.
6	96	111	34	4
Average —	1.92	2.22	.68	—

Such days are rare in November; and still more rare in March. The six cases in the former month were in 1849, 1858, 1861, 1887, and two in 1890; the earliest in the month being that in 1887 (16). The four cases in March were all in one year, 1845. January has most of such days (about 17 per cent. more than December).

The largest number in any one month was sixteen in December 1893; the next, twelve in January 1867 and January 1881.

We might perhaps note that relative maxima of the seasonal numbers occurred in 1854 (15), in 1866 (12), in 1878 (18), and in 1890 (27); giving three intervals of twelve years.

Measured by mean temperature of the three winter months, these winters were all severe (considerably under average) except 1866, in which, though January (1867) was very cold, December and February were both mild (the latter uncommonly so); thus the winter was above the average of mean temperature.

Days with Maxima not over 32 at Greenwich.

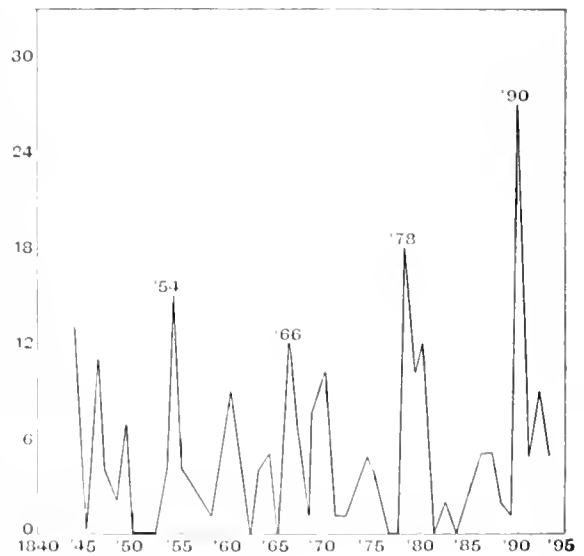

These very cold days most often come in groups (two or more in succession). The largest group was 10 in December '90; the next, 9 in January '81; then 6 in December '44, December '59, and January '93, &c.

Of the 251 days, 100 had maxima from 31° to 32°; 51 from 30 to 31°; 42 from 29 to 30°; 23 from 28 to 29°; 14 from 27 to 28°; and 21 under 27°, ranging down to 19°. The corresponding minima range from 20° down to 7°, with greatest density about 22 to 24° (45 cases).

How are the maxima related to their respective minima? There is, of course, no rigorous proportionality; and we may often find high maxima with very low minima (e.g. December 20, '60, max. 31° S, min. 10° 0'), as also low maxima with relatively high minima (e.g. January 15, '50, max. 26° 0', min. 25° 0'). On an average, however, high minima go with high maxima, and low with low. Take the following:

I selected the cases in which the maxima was under 27°; there are 21. Of the corresponding minima only four were over 20°. On the other hand, taking the last 21 (of 46) cases in which the maximum was over 31° 5', one finds only four minima under 20°. The average minimum in the former case was 16° 4'; in the latter 24° 4'. The average difference of maxima and minima was in both cases about 8°.

It may be useful to put down a number of the coldest of these days (reckoned by maxima). Here are 12 :

	Max.	Min.	Diff.
1. Jan. 5, '94 ...	19°0	12°8	6°2
2. Jan. 4, '67 ...	21°2	7°7	13°5
3. Dec. 21, '55 ...	23°2	17°0	6°2
4. Dec. 22, '90 ...	23°7	13°4	10°3
5. Dec. 22, '55 ...	24°2	16°9	7°3
6. Jan. 10, '91 ...	24°4	12°0	12°4
7. Dec. 31, '74 ...	24°5	18°5	6°0
8. Jan. 7, '94 ...	24°5	18°1	6°4
9. Jan. 16, '81 ...	24°6	17°7	6°0
10. Jan. 15, '81 ...	24°8	14°0	10°8
11. Mar. 13, '45 ...	24°8	13°1	11°7
12. Jan. 14, '67 ...	24°9	13°9	11°0

These minima, it will be seen, range from 7°7 to 18°5. I do not enter on the question as to the coldest days measured by minima; but from a table by Mr. Charles Harding, giving the minimum at Greenwich in each winter, 1841-89 (*Quart. Journ. of R. Met. S.* vol. xvi. p. 165), extended to '93, I take the following cases (adding the maxima since '44):

	Min.	Max.	Diff.
(Jan. 9, '41 ...	4°0	0	0
1. Jan. 5, '67 ...	6°6	32°5	25°9
2. Feb. 12, '45 ...	7°7	29°3	21°6
3. Dec. 25, '60 ...	8°0	30°0	22°0
4. Dec. 25, '70 ...	9°8	28°2	18°4
5. Feb. 19, '55 ...	11°1	33°4	22°3
6. Feb. 12, '47 ...	11°2	39°6	28°4

The lowest (4°0) was in '41, and so beyond our fifty years' limit. It will be observed that those six maxima are all higher than any in our first list, exhibiting a wide range in the temperature of the very cold days thus measured.

In the present remarkable season, there have been, up to February 27, 17 of our "very cold" days, viz. 6 in January, and 11 in February (an unprecedented case). The lowest maximum is 27°0, occurring on February 6, 7, and 9; the respective minima, 15°1, 9°6, and 10°2. A. B. M.

Hesper and Phosphor.

In his "History of the Inductive Sciences" (vol. i. p. 149. London, 1847), Whewell says:—"Pythagoras is said to have maintained that the evening and morning stars are the same body, which certainly must have been one of the earliest discoveries on this subject: and indeed, we can hardly conceive men noticing the stars for a year or two without coming to this conclusion" (*cf.* "The Planet Venus," by W. J. L., in *NATURE*, vol. xlix. p. 413). Now, what Whewell deemed so hardly conceivable appears to have actually occurred in old China. Wang Chung, the philosopher (*circa* 27-97 A.D.), in his work, renowned for its total repudiation of the then current errors, writes as follows:—"In the 'Book of Poems' it is said, 'Ki-ming (Phosphor) exists in the east, and *Chang kang* (Hesper) in the west.' In fact, however, they are but the phases of Jupiter and Venus, which, appearing now in the east, now in the west, received such distinct names from the ignorant bards" ("Lun-hang," Miura's edition, Kyoto, 1748, tom. xvii. pp. 12-13). Two facts are manifested in this passage. First, it shows that, celebrated for their astronomical acquirements in very archaic ages, as they are, the fact that the evening and morning stars are the same body, was not known to the Chinese of the eighth century B.C., when the poem entitled "Ta-tung" was composed, comprising the above-quoted line. Secondly, it shows that, even after the identity was established of the evening and morning stars, some Chinese, so well learned as Wang Chung, were ignorant of their own error: affirming that Jupiter as well as Venus appears now as Phosphor, now as Hesper, they have admitted the existence of two distinct Phosphori and two distinct Hesperii, and of a Phosphor essentially different from a Hesper. It is probable that some later scholars have tried to evade this intricacy by arbitrarily apportioning the two phases between the two planets; thus, Minamoto-no-Shita-zau, the Japanese poet and glossarist (909-983 A.D.), referring to a Chinese work "Kien-ming-yuen," which is perhaps lost now, identifies Jupiter (in Chinese: Sui-sing) with Phosphor (in

Japanese: Aka-boshi), and Venus (in Chinese: Tai-peh) with Hesper (in Japanese: Yûtsutsu) ("Wamyô Ruijushû," Nawa's edition, Kyôto, 1667, tom. i. p. 1).

February 22. KUMAGUSU MINAKATA.

The Recent Storm in the United States.

THE storm of February 4-9 in the United States was notable for its extent and severity, recalling the memorable blizzard of March 1888. The Government Weather Bureau gives the following comparison of the two:—

Snow ... ..	2 feet	5½ inches
Wind ... ..	50 miles	60 miles
Temperature at New York ... ..	4°8 above	3 below
Area ... ..	400 miles radius	1600 miles radius

It will be seen that the recent storm was more severe in everything except the amount of snow, and far more extensive. The entire southern portion of the country experienced severe cold, destroying fruits and vegetables to the value of 15,000,000 dols. in Florida alone. The zero line extended below the middle of Arkansas, and well down into Texas.

The storm reached New York on Thursday, February 7. On the previous afternoon, at about four o'clock, I observed at Brooklyn the unusual phenomenon of a double rainbow.

Brooklyn, February 11. WM. H. HALE.

SOME SUGGESTIONS ON THE ORIGIN AND EVOLUTION OF WEB-SPINNING IN SPIDERS.

IT cannot be reasonably doubted that one of the most interesting features connected with the natural history of spiders, is their habit of gaining a livelihood by spreading nets for the capture of prey. It may be that the large share of the attention of naturalists that this habit has attracted, is to be attributed to the fact that it appears to be confined in the animal world to spiders and men. This circumstance is of itself sufficiently remarkable to call for special comment; but its interest is not a little enhanced by the reflection, that since spiders made their appearance in the history of animal life vast ages before man came upon the scene, none of us can justly claim that any member of our own kind was the first in the field in the invention of the art of netting. Possibly, indeed, the oft-repeated and unavoidable observation of the efficacy of a spider's web for the purpose of catching otherwise unobtainable prey, may have roused in the brain of some intelligent hunter amongst our ancestors, the idea of the practical utility of a similar instrument for the capture of fish or other eatable forms of life. But if this be so, civilised man has long forgotten the debt of gratitude he owes to spiders. For, to the average individual amongst us, a spider is a thing to be looked upon and spoken of with fear and dislike amounting to loathing, and to be ruthlessly destroyed when a safe chance of destruction is afforded.

It is, perhaps, on account of this widespread repugnance that the science of arachnology has claimed within the last century far fewer students than many another less instructive branch of zoology. Moreover, such attention as it has received, is no doubt largely due, as suggested above, to the wonderful web-building powers that spiders possess. But those who have devoted their time to the study of webs, have, for the most part, contented themselves with observing and recording the structure and method of formation of the various types of nests and snares, and in claiming or disputing their value as a basis for a natural classification of the animals that make them. This has resulted, if in nothing else, at least in the accumulation of an array of facts sufficiently vast to

make it possible to attempt to weave them into a coherent and intelligible whole, by trying to trace the origin and evolution of the habit of net-spinning. It is strange that but a small number of students seem to have occupied themselves with this most attractive aspect of the subject. With the exception, indeed, of a few authors who have here and there thrown out stray suggestions upon particular points, no one appears to have seriously set himself to the elucidation of the whole problem. It is true that in the second volume of his work upon the American orb-weaving spiders, Dr. McCook devotes a chapter to the "genesis of snares"; but since he does not appear to be able to attach great importance to the evidence in favour of evolution, his treatise on the subject practically resolves itself into a demonstration of the fact that, by starting at any point you please, in what is called "aranead spinning-work," a series of gradations may be traced from one modification of architecture to another, from the simplest to the most complex, or from the most complex to the simplest. He thus succeeds in leaving his readers completely in doubt as to whether or not he intends one or all of his attempts at tracing the "genesis" of snares to represent what has actually occurred in the course of nature; and one closes the chapter without satisfactorily ascertaining if his writer has any definite views respecting a primitive form of spinning work. Yet, at the same time, it must be admitted, an impression remains that the suggestions that are put forward, based as they are upon an extensive knowledge of the subject, point in more than one instance to the true lines along which the web spinning habits have been evolved.

In attempting to arrive at an understanding of the origin of any structure or instinct in an animal, one nowadays naturally refers for an explanation to what is hypothetically its ancestor, or, failing this, its ancestor's nearest ally. If this method of research be adopted in connection with the spinning powers of spiders, it is found that silken threads are fabricated by two allied groups of animals, both of which are believed by some students to stand, in many respects, nearer than spiders do to the ancestor of the class to which spiders, scorpions, mites, &c., belong. In one of these—the Chelifers, or book-scorpions—the presence of silk glands has long been known. In the other—the *Phrynidæ*—their existence is now, for the first time, I believe, pointed out. The function of the silk in the Chelifer is cocoon-spinning; and that it is materially the same in the *Phrynidæ* is shown by the easily verified fact, that the egg-case of the mother is secured to the lower surface of her abdomen by fine silk-like threads. One of the chief interests of this discovery lies in the circumstance, that of existing animals the *Phrynidæ* appear to be most nearly allied to the immediate ancestor of the spiders. We are, therefore, justified in concluding that originally the silk in spider was utilised for the purpose of making a case for the eggs.

If, however, we consider the question from the standpoint of spiders alone, it seems to me that we should naturally arrive at the same result. For it is, *a priori*, probable that the primitive form of spinning industry was that particular kind which is now common to all groups. But when we pass in review the spinning work of the various tribes of spiders, we find that the habits of utilising the silk for constructing a snare, or drag-line, for ensnawing captured prey, or for purposes of locomotion, do not occur, by any of them, invariably throughout the class. In fact, we cannot say of any one of them that it is characteristic of spiders. Not so, however, is it with cocoon-spinning. Not, however, different from each other in structure spiders may be, and however dissimilar in habits and mode of life, we yet find that the instinct of the mother to spin a cocoon for the protection of her eggs is never wanting.

Granting, then, the possession of silk-glands inherited from an ancestor, we may conclude that the first step in the development of web-spinning was the formation of the cocoon. What was the second? We know that a spider's care for her eggs does not, as a rule, cease with the completion of the cocoon; some species carry it about with them; others mount guard in its vicinity. Possibly the former was the original method of disposing of it. But if so, since such a habit must more or less impair the mother's activity and must render her a conspicuous object of attack, we can understand why it has been abandoned for the latter method by the great majority of spiders, and is now almost confined to those species in which the nomadic mode of life reaches its highest development. If, on the other hand, as seems more likely, the primitive habit was that of watching by the cocoon, we can understand that during the temporary period of quiescence thus enforced, the mother would naturally seek concealment and protection for herself; and since she possessed the instinct and material for constructing a receptacle for her eggs, it is possible to see how a slight modification of intelligence might have led her to extend the same protection to herself by weaving a covering over and around the retreat in which she had sought refuge. Then if an aperture for ingress and egress, for purposes of feeding, were left at any spot in the wall of such a protective domicile, there would arise, in a rudimentary form, what is known as the tubular nest or web. And the next simple but important step would doubtless be the adoption of the silken tube as a permanent abode for the mother after the dispersal of the young to shift for themselves.

As a matter of fact, some spiders have advanced no further than this stage. The females of some *Drassidæ*, for instance, spin a temporary retreat for themselves and their young at the breeding season; while others utilise the retreat as a permanent dwelling-place. Lastly, the view that the formation of a tubular retreat was in reality the second stage in the evolution of web-spinning, seems supported by the circumstance that the tube, whether accompanied or not by accessory developments, is, with the exception of the cocoon, the most constant feature in the spinning industry of spiders.

Adopting then, for these reasons, the conclusion that a simple tube was the primitive form of nest, it seems that the evolution of web-spinning has been carried out along two main lines. Along one there is a gradual elaboration of the tube until it culminates, so far as structural complexity is concerned, in the trap-door nest with which everyone is familiar; along the other, the tubular nest either ultimately disappears, or, retaining its primitive simplicity, it is to a greater or less extent superseded by the formation of a new structure—namely, the net for ensnaring prey.

It will not here be necessary to enter upon a discussion concerning the various forms of tubular nests that are constructed; but a few words respecting the probable origin of the door-making habit may prove of interest.

In the first place, it is important to note that the remarkable instinct to close the aperture of a tubular nest with a movable lid is possessed by spiders belonging to two groups. These are the *Lycosidæ*, or wolf-spiders, of which the South European *Tarantula* is a historical example, and the gigantic *Arcturidæ*, which have won such a bad name for their alleged bird-catching propensities. But although there is no direct genetic affinity between the species composing these two families, it is nevertheless highly interesting to note that they present a close parallelism in nest architecture. In both there are species which form no nest, others which construct a simple silken tube, and others which close the aperture of the tube with a hinged-door. Yet it is certain that the last-named instinct has been independently acquired in the two cases. Moreover, it is probable, as



will presently be explained, that in both cases it has been brought to its present state of perfection under stress of the same adverse conditions of life. As is well known, Mr. Moggridge long ago suggested that the instinct to construct the door may have arisen from the habit of closing the aperture of the tube in the winter and opening it again in the spring. This idea, in substance, has been adopted and further developed by Dr. McCook, who states, upon the authority of Mrs. Treat, that a North American species of wolf-spider (*Lycosa tigrina*) has acquired the instinct of sealing up the aperture of her nest during the breeding season of the Mason-wasps; for at this period these insects scour the country for spiders, in order that they may lay up a store of food for their young. When the wasps have disappeared with the close of their hunting and breeding season, the spiders venture again to remove the covering of their nests; but Mrs. Treat has made the further important observation, that some examples leave the covering attached at one point. Thus a genuine, though roughly-formed, trap-door nest is produced. In view of this circumstance, there cannot be much doubt that the permanent and highly-finished trap-door nest of the Russian *Lycosa opifex* has been similarly brought about, as M. Wagner, the discoverer of the species, has suggested, under the stress of the dire persecution from wasps to which spiders in general are subjected.

Being thus able to trace with some degree of certainty the steps by which the trap-door nest has been evolved in one group of spiders, namely, the *Lycoside*, we are justified in concluding, at all events until evidence to the contrary is forthcoming, that it has been evolved in the same way in the case of the *Ariculariide*—the trap-door spiders *par excellence*.

The primary influence, then, that has been at work in guiding the evolution of the architecture of the tunnel-making species, has apparently been that great necessity for the preservation of life, the avoidance of enemies. But if we turn to the other line, along which the web-building instinct has been developed, we find that the primary guiding influence has been that second great vital necessity, the acquisition of food.

As has been already stated, the origin of the webs which function as snares seems to be referable to a simple silken tent or tube, similar to that from which all the more or less complicated forms of tubular nests appear to have been developed. Perhaps the most rudimentary form of snare arose, as Dr. McCook has suggested, from the chance spinning of a few stray threads about the mouth of the tubular retreat; or, perhaps, an irregular network of threads spun around the aperture to interfere with the entry of such enemies as wasps, was the first step in the evolution of net-spinning; or even lines anchoring the tube securely in its site might have first served the purpose of catching prey. But, however this may be, it is clear, as Dr. Romanes<sup>1</sup> has pointed out, that "there is much potential service to which the power [of net-spinning] may be put with reference to the voracious habits of the animal." Taking this into consideration with the variation in structure presented by different species of spiders, it is not surprising that there are many modifications of the net. Sometimes it is a thick, closely-woven horizontal sheet, which is continuous at one extremity with a tubular retreat, as in the case of one of our commonest house-spiders, *Tegenaria*; or, as in the equally common *Amaurobius*, the net is less regular in shape and less thickly woven, but is still continuous, with a silk-lined hole, in which the spider lurks; or again, the web, as in *Pholcus* or *Theridium*, may be composed of an irregular mesh-work of interlacing threads, without any such tubular retreat as that constructed by *Tegenaria* or *Amaurobius*; or, lastly, it may be composed of radiating and concentric

lines, like that of our garden spider, *Epeira*: and it seems to be generally admitted that this orbicular web of *Epeira* manifests the greatest perfection of instinct, and is therefore to be regarded as the highest form of this kind of spinning-work. Consequently, the question concerning the possible steps by which such a structure has been evolved cannot fail to be of interest.

In the first place, if all snares are traceable back to a common tubular origin, it may be taken for granted that those that are still associated with a tubular retreat are, *ceteris paribus*, of a more primitive type than those in which the tube has been abandoned. Furthermore, it may be confidently assumed that the habit of weaving the lines of the snare radially and concentrically in a definite and elaborate pattern, was preceded by the habit of arranging them irregularly and without order. Looked at from this point of view, the web of a *Tegenaria* or *Amaurobius* is a much less specialised structure than that of an *Epeira*. It may consequently be concluded that the complete orbicular snare of the latter animal, and of orb-weavers in general, has been derived from one which, like that of the tunnel-weavers, was composed of irregularly crossing threads, and was continuous at one extremity with a tubular domicile. Having arrived at this conclusion, we naturally appeal to nature for corroboration, and search for connecting links. Nor need we look far. For, taking first the tunnel-weavers, we find that a species of *Dictyna*, a spider nearly allied to our common *Amaurobius*, constructs a snare of which the threads are arranged radially and concentrically, but so roughly that the resemblance to the finished structure with which we are familiar in our garden-spiders is only remote. Nevertheless, one cannot avoid the conclusion that it represents an initial stage in the development of the perfect orb.

Turning, in the next place, to the orb-weavers, we naturally look out for snares constructed upon a more primitive plan than that which is typical of our English species of *Epeira*. But if there be any such in existence, we should reasonably expect, in accordance with our hypothesis, to find these simpler kinds associated with a tubular retreat. And our expectation would be justified by facts. For the large and handsome tropical genus *Nephilengys* spins a web which is structurally intermediate in character between that of *Epeira diademata* (our garden-spider) and that of the tunnel-weaver, *Dictyna*.<sup>1</sup> This web resembles that of *Tegenaria* and *Dictyna*, in consisting of a long silken tube, with an expanded funnel-shaped mouth opening directly upon an extended network of threads. But the latter, instead of being fashioned like that of the majority of tunnel-weavers, consists of a scanty mesh-work of lines arranged radially and concentrically with respect to the mouth of the funnel. In this particular it is similar to the net of our garden-spider, *Epeira*; but its area, instead of forming a complete circle, extends over only about one-third of this figure. The importance, however, of this distinction breaks down when the webs of other species of orb-weavers are taken into consideration. For it is found that those of the Malaysian *Epeira beccarii*, as figured by Mr. Workman, and of the North American *Epeira labyrinthica* of Hentz, are completely circular, and yet the radial threads at the centre of the web spring from the mouth of a long silk tube, in which the spider lurks.

To all intents and purposes, therefore, there are not many links missing in the chain which starts with the web of a tunnel-weaver, like our house-spider *Tegenaria*, and terminates with that of our garden-spider *Epeira*. Furthermore, from the web of *Tegenaria* gradations may be traced backwards to the simple tubular retreat

<sup>1</sup> I have to thank my friend Mr. H. A. Spencer for sketching of the web of a species of this spider, and also for a living example of the animal which he kindly brought to me from Durban, while acting as medical officer on board the s.s. *Merican*. I was fortunate enough to keep this spider alive for several months, and was thus enabled by personal observation to testify myself of the accuracy of Mr. Spencer's representation of the web.

of some of the tunnel-weavers belonging to the family *Draconidae*, which merely construct a web to serve as a nest during the reeling season.

But to strengthen the probability that such an evolution of webs has ever occurred, it is necessary to be able to show in what respects a snare composed of radiating and concentric lines may excel in efficacy the sheet-like web of a *Theridion* or the tangled mass of threads of a *Phidippus*.

Firstly, it seems clear that threads which radiate directly from the spot where the spider is stationed, first more rapidly and more certainly inform her of the position of a struggling insect than irregularly crossing threads, which must spread the vibration indiscriminately in all directions; and the advantage of there being as little delay as possible on the spider's part, between her perception of the vibration and her arrival at the spot, where it originates, will be readily understood by those who have observed powerful insects break loose from the web before being seized by the spider. Secondly, the object of the concentric lines is evidently to support the radii and to fill up the spaces between them. It may perhaps be urged, however, that these two ends would be apparently more satisfactorily attained if the inter-radial areas were filled in by a complete sheeting of web, or, at all events, by a larger number of threads than is used by an *Epeira* for this purpose. But it must be remembered, in the first place, that in proportion as the mesh of the web becomes closer, the whole structure is rendered more and more liable to be beaten down by the rain, or blown into shreds by the wind, unless its supports are correspondingly multiplied; and in the second place, that every thread of white silk that is added to the web, tends to make it more and more conspicuous, and so to convert it into a visible object, which will serve as a warning to wary flies, and as an attraction to marauding wasps. And these are the two ends which it is particularly the spider's interest to avoid, inasmuch as they are alike detrimental to its chances of life.

It is legitimate, therefore, to conclude that the principal, if not the sole factor that has guided the evolution of the orb-web has been the advantage gained by a delicacy of construction, involving comparative invisibility. But the making for invisibility has been kept in check, and has not been permitted to go to the length of interfering with the efficacy of the web as a net, for which a closeness of mesh and strength of thread sufficient to intercept and hold insects is a vital necessity for the spider.

Seeing, then, the advantage of the radiating threads as rapid and sure transmitters of vibration, and the necessity for a net as inelastic and delicate, and yet as strong as possible, we are led to inquire if the method of filling up the inter-radial spaces with concentric lines is not calculated to afford the greatest possible support to the radii. This inquiry must, I think, be answered in the affirmative. For it is the case here, the threads be drawn from points on one radius to points on another, so as to make the two interior angles on either side of them equal, these threads are the shortest that can be made; and the shorter the threads, the less their elasticity, and the greater the support they supply to the radii. This fact alone has been, one would think, of sufficient importance to bring about the concentric arrangement of the supporting lines. But more than all this, it is also to be borne in mind that the shortest threads utilize the smallest quantity of silk, and take the shortest time to spin. So that, in constructing a net of radiating and concentric threads, it appears to me that an *Epeira* economises both time and silk, and in addition renders her snare as strong and as serviceable, and yet as delicate and invisible, as possible.

E. I. POOCK.

#### NEW METRIC STANDARDS.

THE President of the Royal Society, with Sir John Evans, and the following members of the Council—Dr. A. A. Common, Mr. W. Crookes, Dr. A. R. Forsyth, Prof. H. Lamb, Prof. J. H. Poynting—visited the Standards Department of the Board of Trade on Thursday, the 21st inst., for the purpose of inspecting the new metric standards which have been recently deposited with the Department. The President and Council were received by Sir Courtenay Boyle, K.C.B., the Secretary of the Board of Trade, and Mr. H. J. Chaney, Superintendent.

Two new metric standards, of length and mass respectively (*des prototypes nationaux*), were delivered to the Board of Trade by the International Committee of Weights and Measures at Paris on September 28, 1889, and the third and final standard was received from the Committee in December last. All three standards are deposited at the Standards Office, 7, Old Palace Yard, Westminster, and are available for use in the verification of metric standards for the purposes of science.

The two standards received in 1889 include a "line" standard metric measure (*mètre-à-trait*) and a kilogramme weight. The standard received last year is an "end" standard metre (*mètre-à-bouts*). These three standards, together with other similar standards supplied to twenty-one different States, are, *inter alia*, the outcome of the results of the labours of the International Committee for more than twenty years; and Great Britain is the first country which has received all three of such standards.

The standards were verified at the Bureau International des Poids et Mesure (*Pavillon de Breteuil, Sèvres, près Paris*), which bureau was established under a Metric Convention, dated May 20, 1875, signed by twenty different High Contracting States, exclusive of Great Britain, who finally joined the Convention in September 1884. The Committee is a self-elected body, and is founded and maintained by common contribution from all countries who are parties to the Convention of 1875. The bureau of the Committee is required to be near Paris, and has been declared to be internationally neuter. The Committee was charged in 1875 with the construction, restoration, and verification of new metric standards (*des prototypes internationaux*) to replace the ancient standards of France (*mètre et kilogramme des archives*), and with the verification of copies of the new standards for all the contracting States. By such means the international accuracy of metric standards is now assured throughout the world.

The Committee, which includes thirteen members, undertakes also the verification of standards for scientific authorities or persons.

#### The Metre.

The two metric standards above referred to are made of iridio-platinum, or an alloy of 90 per cent. of platinum and 10 per cent. of iridium. The metres are in transverse sections, nearly of the form of the letter X, known as the Tresca form, and selected as being not merely as the most economical (iridio-platinum being a costly metal), but as being less affected by heat, practically non-oxidisable, and well adapted for receiving finely engraved lines. This alloy appears to be of all substances the least likely to be affected by time or circumstance, and has been preferred for standards purposes to rock-crystal, gold, &c. The lines on the *mètre-à-trait* are fine, and are barely visible to the naked eye.

The actual relation of our prototype metre No. 16 is as follows:

At 0° C.

No. 16 = 1 metre = 0.06  $\mu$   $\pm$  0.1  $\mu$  at 0° C.

Here  $\mu$  means one micron, or one-thousandth of a millimetre (or nearly 0.00004 inch), so that metre 16 may

be said to have been verified with an accuracy of one part in a million.

The certificate of the verification of the end standard, or *mètre-à-bout* (étalon No. 6), will not be issued by the Committee until their general conference in September next; but this standard has been verified also with great accuracy, with a probable error of  $\pm 0.3 \mu$ . In the verification of the end standard (*mètre-à-bout*) MM. Cornu and Benoit have introduced a method of reflection, by means of which it is unnecessary to bring the ends of the metre bar into contact with any touching surfaces, and thus the measuring ends of the bar may be carefully preserved and used. Only Austro-Hungary, Germany, Great Britain, and Russia have at present applied to the International Committee to be supplied with end standard metres.

Experiments with reference to light wave analysis, which have been carried out under the directions of the International Committee by Dr. Michelson during 1893, with the view to the discovery of a radiation of light of sufficient homogeneity to serve as an ultimate standard of length, appear to show that it is possible within certain limits to reproduce the length of the metre by reference to such physical constant.

#### The Kilogramme.

The unit of mass of the kilogramme is determined by a piece of iridio-platinum in the form of a cylinder, the height and diameter of which are equal (thirty-nine millimetres). The kilogramme, No. 18, supplied to Great Britain has no distinguishing marks, and is highly polished. On analysis it showed very faint traces of ruthenium, rhodium, and iron. Its volume was found to be at 0° C.

Prototype 18 = 46.414 millilitres,  
corresponding to a density of—

$$21.5454.$$

After its final adjustment it was found to be *in vacuo* at 0° C.

Prototype 18 = 1 kg.  $\pm 0.070 \pm 0.002$  milligramme.

So that it may be said that the kilogramme (kg.) has been verified with a probable accuracy of 0.002 parts in a million.

#### NOTES.

THE Committee of the Athenæum Club, acting under the Rule which provides for the annual election of persons "of distinguished eminence in science, literature, the arts, or for public services," have admitted to membership Prof. Bayley Balfour, F.R.S., and Sir W. H. White, K.C.B., F.R.S.

DR. F. J. LAUTH, the eminent Egyptologist, died at Munich on the 11th inst., at the age of seventy-three. He was Honorary Professor of Egyptology at the University of Munich, and Keeper of the Egyptian Collections. His writings on the antiquities of Egypt are numerous and important.

WE regret to announce the death of Prof. Heinrich Wild, of St. Petersburg. He was a Swiss by birth, and his work in magnetism and optics, as well as the magnetometer, polaristrometer, and other instruments devised by him, are well known to students of physics.

It is reported from Athens that the architect who has examined a number of the ancient monuments in Athens, states that the majority of them, and particularly the Parthenon and the Temple of Theseus, are in a dangerous state. The work of rendering them secure would cost a million drachmas. The Archaeological Society intends to make an appeal to all countries for a portion of the money required to restore these wonderful monuments to a sound condition.

GENERAL ANNEKOFF, constructor of the Russian Central Asian Railway, has been appointed one of the vice-presidents of the International Congress of Geography to be held in London in July next. Russia will further be represented on that occasion by nine or ten other well-known men, including Senator Semenoff (vice-president of the Imperial Russian Geographical Society), M. Grigorieff (secretary of the same society), and Baron Wiangel (director of the Imperial Lyceum).

A REUTER telegram from St. Petersburg reports that a scientific expedition, organised by the French Minister of Public Works, has just arrived at Samarcand. The head of the expedition is M. Jean Chatlanjon, who has previously made a journey in South America, and he is accompanied by two naturalists, MM. Henri Mangin and Louis Gay. From Samarcand the expedition will proceed to Tashkend, and after completing all the necessary preparations there, will start on a journey of exploration in Tibet and other countries.

WE are informed by the trustees of the Australian Museum, Sydney, that Dr. E. P. Ramsay, after twenty years' service as Curator of this Museum, has retired, owing to ill-health. Dr. Ramsay's official connection with the Museum as Curator ceased from December 31, 1894. The trustees have appointed as his successor Mr. R. Etheridge, jun., formerly of the British Museum, and lately Palæontologist to this Museum, and to the Department of Mines of New South Wales, and who has on several occasions temporarily acted as Curator. Mr. Etheridge has entered on the duties of Curator.

DR. A. R. WILLIS will commence a course of six lectures to working men at the Museum of Practical Geology, Jermyn Street, on Monday, March 4. The subject of the course is "Heat Engines."

THE weather over these islands has been comparatively mild during the past week, and the higher temperatures which set in at the end of the prolonged frost were maintained for some days; subsequently there was a slight return of cold, with high barometric pressure, accompanied by strong north-easterly winds, and snow showers in various places. Frost occurred on Sunday and following nights, the lowest shade temperatures being 22 in the central parts of Ireland, while in the south-eastern and midland portions of England the readings were several degrees below the freezing point.

AT a recent meeting of the Vienna Academy of Sciences, the President announced that the late Herr Joseph Treith, director of the First Austrian Savings Bank, had bequeathed the whole of his considerable fortune to the Academy for the purpose of the advancement of science. The grants are to be apportioned by a committee of five, three of whom are to be appointed by the Academy, and two by the Minister of Education, the Academy to decide all doubtful questions. The branches of science to be encouraged are those for which there is no other official provision made. Among the subjects suggested are the physical structure of the earth and of the heavenly bodies. The income is to be divided every year into several grants, but if some great enterprise is to be undertaken, it shall be permitted to let the funds accumulate for not more than three years. The extension of higher instruction among all classes fitted for it by education, the strengthening of moral character, the advancement of technical education, the simplification of medical practice, and the furtherance of the material prosperity of the human race by invention and discovery, are the guiding principles indicated by the donor for the administration of his generous gift.

AT the last meeting of the Société Française de Navigation Aérienne, M. de Fonvielle gave an account of a paper by M. Andree, the chief engineer of the Swedish Patent Office, read

on the 14th inst. before the Stockholm Academy of Sciences. In that paper the Swedish aeronaut described a scheme to go to the North Pole in a balloon, and, to carry out his plans, he asked for a sum equivalent to about £7220. Although M. L. Bienville opposed a similar scheme put forward about seven years ago by two of his countrymen, he expressed himself favourable to the new undertaking, and his opinion seemed to have been shared by the Society. M. Ardice has already executed a number of ascents in very difficult circumstances. He is well acquainted with all the peculiarities of Arctic climates, having been one of the meteorologists of the Swedish 1882-83 expedition for observing the transit of Venus from Cape Thorsden. He hopes to start from this station in the month of July, 1896, as it appears that there are no great variations of temperature at that time of year. The balloon is to contain 120,000 cubic feet of gas, and the inflation process is to be carried out at Cape Thorsden by means of compressed hydrogen.

THE Select Committee of the House of Commons appointed to inquire into the existing systems of weights and measures in this country had a meeting on Tuesday, under the presidency of Sir Henry Roscoe. Evidence was given by Mr. H. J. Chaney, Superintendent of the Standards Department of the Board of Trade, who described the system under which the verification of legal standards is carried on at the Board of Trade by experts appointed for the purpose, and also gave an account of the different systems of weights and measures now in use in the United Kingdom. He stated that the Imperial and the metric systems were the only ones with which the Department had to do in England, but there were other local customary weights and measures in use. There were many weights and measures in use which were not legally recognised. Among these he mentioned the carat, the boll (used in Scotland), the ell, the coomb (used for measuring corn), the Winchester bushel, the butchers' stone of 8 lb., the miners' dish (used for weighing ore in Derbyshire), and the gauge (used in measuring plates) as examples of weights and measures which were not recognised by law. A number of anomalies which formerly existed—e.g. a ton of tere being different from a ton of other materials, &c.—had disappeared to a great extent under the operation of the Weights and Measures Acts of 1878 and 1889. The Scotch and Irish mile were still locally recognised, but for all statutory purposes a mile was 1760 y. ds. Practically the only two countries of any importance in Europe in which the metric system was not adopted were Great Britain and Russia. In Germany, Austria, France, Italy, Spain, and Portugal the metric system was the only system in use.

THE advantages of work at biological stations have been recognised at various Universities. The Indiana University has lately shown its appreciation of the need for such research by securing on the establishment of an inland biological station on one of the lakes of Northern Indiana, probably Maxinkowick. To begin with, the main object of the station will be the study of variation. For this purpose it was thought that a small lake, well exposed, a limited, well circumscribed locality, within which the influences of environmental change would be reduced to a minimum. The study will be in the determination of the limits of variation in the non-hereditary vertebrate, the kind of variation, whether continuous or discontinuous, the partitive variation, and the direction of variation. In this way it is hoped to survey a base line of variation, which can be utilised in studying the variation of the same throughout their distribution. This study should be repeated for a series of years, or it should be repeated at different periods to determine the annual or periodic variation of the same. A comparison of this variation in the same locality in other similarly limited and well circumscribed areas,

and the correlation of the variation of a number of species in these areas, will demonstrate the influence of the changed environment, and will be a simple, inexpensive substitute for much expensive experimental work. In connection with this study of the developed forms the variation in the development itself will receive attention; for instance, the variation in segmentation, the frequency of such variation, and the relation of such variation in the development to the variation in the adult, and the mechanical causes affecting variation. Admirable courses of instruction have been drawn up by Prof. Carl H. Eigenmann, the Director of the Station, to lead to the special investigations, and there is every indication that useful work will be accomplished.

DR. A. PETER gives, in the *Nachrichten von der Königlichen Gesellschaft der Wissenschaften zu Göttingen*, the results of a second series of cultural experiments with dormant seeds, taken from various depths in the soil of woodlands or forest. The forest in question of the present day is the site of villages and cultivation that disappeared several centuries ago; and some of the samples were taken from dense forest, 100 to 150 years old, under the shade of which there has been no surface vegetation for years. The principal point to investigate was the probable existence of seeds of cornfield weeds still possessing the power of germinating and developing into reproductive plants. Dr. Peters succeeded in raising a large number of plants belonging to about fifty different species, including some that are essentially weeds of cultivation; and he believes he has good grounds for supposing that the buried seeds of many pasture plants and cornfield weeds retain the vitality much more than half a century; that is, under the conditions he describes.

THE hundreds of Gulls that have lately come up the Thames in search of food seem only matched by a remarkable invasion of the north and north-east coasts, by the Little Auk (*Mergulus alle*) during January. Writing in the *Zoologist*, Mr. J. E. Harting says that on the 21st of that month, great numbers were observed passing south, both at sea and along the coast, and many were cast ashore in a helpless condition, exhausted in their attempts to withstand the stormy weather which has recently prevailed. In the neighbourhood of Redcar, as many as two hundred and fifty of these little birds have been counted; at Scarborough they were also numerous, and on the Norfolk coast one hundred and twenty have been captured. Another result of the severe weather and snow during the third week in January, was that the Grouse in Yorkshire left the moors in packs, and migrated to the lower grounds in search of food and shelter. It is pointed out that an exodus of this kind is of extremely rare occurrence; the last one being during the severe winter of 1886.

IN the *Meteorologische Zeitschrift* for December last, Prof. G. Hellmann gives a very interesting account of the invention of the barometer which has now been in use 250 years. Torricelli, who died at the early age of thirty-nine years, was too busily engaged in mathematical studies to publish an account of his discovery, but on June 11, 1644, he wrote a description of it to his friend Ricci. This letter, and Ricci's objections to the experiment, were published in 1663 by C. Dati, a friend of Torricelli's, and as this work is now exceedingly scarce, Prof. Hellmann has reprinted the correspondence, in the original Italian, in the above-mentioned journal. Some of the paragraphs are noteworthy, especially those in which Torricelli states that it was not merely a question of producing a vacuum, but of making an instrument which would indicate the changes of the atmosphere. The first continuous barometrical observations appear to have been made in France. In England they were first taken by Robert Boyle, about the year 1659, to whom we owe the invention of the word "barometer."

SOME time ago we gave an account of the considerable extension of the ultra-violet photographic spectrum obtained by Dr. Victor Schumann, of Leipzig, by eliminating the air between the source and the sensitive plate, which was found to exert a strong absorption upon the rays of shortest wave-length. This work has been carried on since with great success. At a recent meeting of the Vienna Academy, Dr. Schumann announced that he had improved his plates and his "vacuum spectrograph" so as to obtain results in a few minutes which used to take as many hours. The hydrogen spectrum shows a further lengthening, and the spectra of cobalt, iron, aluminium, zinc, and cadmium have also been considerably extended beyond  $170 \mu$ . This limit, although far beyond the ordinary limits of the photographic spectrum, was due to a residue of air and electrode vapour. The absorptive effect of air upon the most refrangible rays was traced down to thicknesses below  $0.01 \text{ mm}$ . Hydrogen also shows a strong absorption for these extreme rays, especially if insufficiently dried.

HERR K. MACK, working in the Hohenheim Physical Institute, has succeeded in demonstrating the occurrence of double refraction of electric waves in wood. That electric waves, unlike light waves, are capable of penetrating wood, was already found by Hertz. "It is not without surprise," he says in his classical work on the "Propagation of Electric Force," "that one sees the sparks appear inside a closed room." But the fact that waves of electric force are transmitted in a different manner accordingly as they vibrate across or along the fibre of the wood, has only just been proved by Herr Mack, who gives a full description of his method in the current number of *Wiedemann's Annalen*. It is well known that two Nicoll prisms transmit no light when their principal planes are crossed, but that light may be made to appear by inserting a doubly-refracting substance between them. For the Nicoll prisms substitute Her zian concave mirrors with their focal lines crossed, and, instead of the tourmaline or other doubly-refracting substance, insert a plate of wood 10 inches thick, with its fibre at  $45^\circ$  to each of the focal lines, and you have Mack's apparatus. The sparks, which are extinguished on crossing the two focal lines, reappear on inserting the wood in the manner indicated. This striking experiment forms another important link in the chain connecting the domain of light with that of electricity.

In an admirable paper on the after-shocks of earthquakes (*Journal of the College of Science, Imperial University of Japan*, vol. vii. part ii.), Mr. F. Omori has attacked a somewhat neglected branch of seismology. In three recent Japanese earthquakes, those of Kumamoto in 1889, Mino-Owari in 1891, and Kagoshima in 1893, the after-shocks have been carefully recorded, and are here specially studied from the frequency point of view. Numerous tables are given, and also many curves showing the way in which the number of after-shocks varies with the time at different places. When their inequalities are smoothed away, these curves differ little from rectangular hyperbolas. At the same time, they show periodic fluctuations in the decrease of frequency of after-shocks. Besides the diurnal and annual fluctuations, six different periods have been ascertained, whose lengths range from a few hours to several months. In the case of the great Mino-Owari earthquake of 1891, the after-shocks were most numerous some distance to the south of the principal epicentral tract, which lay in the Neo valley. They also occurred more frequently along four axial lines, radiating from the vicinity of Koori, than in the neighbouring districts. Mr. Omori suggests that the principal earthquake was caused by the formation of some great fractures beneath the Neo valley, and that the axial lines indicate the positions of four weaker or deeper fractures, along which the crust is not yet in the way of steadily settling into equilibrium.

In a paper recently published (*Journal of Geology*, May-June 1894; *Johns Hopkins University Circular*, January 1895), Prof. W. K. Brooks discusses from the zoological point of view a problem familiar to the geologist—the sudden appearance in the Lower Cambrian of a rich fauna in which most of the great classes of animals are represented by unmistakable forms. His conclusion is that early Cambrian times and those immediately preceding them formed a period of rapid mollification induced by the first colonisation of the sea-bottom. His arguments may be briefly summarised thus:—Embryology indicates simple pelagic forms, as the ancestors of all the great animal stems. The existing pelagic fauna consists in part of small and primitive forms, and in part of the specialised descendants of shore or bottom forms. The fact that the latter are almost exclusively carnivorous indicates the enormous wealth of plant-life, mostly of minute forms, on which ultimately the existence of all the fauna depends, and shows the extremely favourable character of the conditions of pelagic life to simple organisms. The supply of these simple organisms is inexhaustible, and on them the bottom-fauna also depends for food. It is suggested that the evolution of all the main stems of animal life took place at the surface of the ocean, but that when their descendants had colonised the bottom the crowding that soon ensued there led to fierce competition, especially between nearly related forms, and to the specialisation of the types already established, but not the production of new types. The development of hard skeletons was an early result of these conditions. Geologists will certainly find many points to criticise in Prof. Brooks's suggestions, but they constitute an important addition to the discussion of faunal origins.

ONE of the many botanic stations the advancement of which has been promoted by the Director of the Royal Gardens at Kew, is that at Aburi on the Gold Coast. A few interesting facts referring to the establishment and present condition of this station are given in the *Kew Bulletin* for January, from which the following information has been gathered. The site is in the hills, at an elevation of about 1400 feet, overlooking the sea-board, near Accra and Pram Pram. In addition to its suitability for the growth of economic plants, Aburi is a valuable resort for European invalids. The locality has been greatly improved of late years, and it promises to become the centre of activity for many cultural industries started by the Botanic Station. During the winter of 1893-94 Mr. William Crowther, the curator (appointed in 1890), was deputed to visit the West Indies "to observe the system pursued there in the cultivation of economic plants, and to bring back such useful seeds and plants as might with advantage be introduced to the Gold Coast." Mr. Crowther very successfully carried out the object of his mission, and published a detailed report. Since then the work of the Aburi Station has made excellent progress. The inception, as well as the actual work, so far accomplished in botanical enterprise at the Gold Coast, is entirely due to the Governor, Sir W. B. Griffith. He has given warm and consistent support to the station, and personally encouraged in every way the efforts of the curator.

THE *Forschungsberichte* (Theil 3, 1895) of the biological station at Plön, recently published, contains a number of interesting papers on the flora and fauna and on the biological phenomena of the lakes adjoining the station. Among the contents may be mentioned the copious reports on the flora by Drs. Klebahn and Lemmermann, the faunistic contributions of Dr. Zacharias, and the memoirs of Drs. Zacharias and Strodsmann on the Plankton of the lakes. The investigation of the movements, periodicity, and changing quantity of floating organisms in inland waters can be pursued with such ease and completeness, as compared with marine phenomena,

that biologists may look forward to the early achievement of valuable results by Dr. Zacharias and his assistants. The present report goes far to justify this expectation.

THE history of the Royal Microscopical Society, as told by Mr. A. D. Michael in his presidential address last month, is contained in the February *Journal* of the Society.

A BOOK of gumméd labels, for the chemical laboratory, having the names of 750 special reagents, &c., printed upon them, has been compiled by Mr. W. H. Symons, and published by Messrs. A. Gallenkamp and Co.

WE are always glad to see the Reports of the Natural Science Societies of our Public Schools. The twenty-fifth annual report of the Wellington College Society has just come to hand, and the abstracts of the lectures delivered under the auspices of the Society, as well as the records of observations in various branches of science, show that excellent work is being done in creating and fostering interest in natural knowledge.

MR. H. WASHINGTON SMYTH'S "Notes of a Journey on the Upper Mekong, Siam," read before the Royal Geographical Society just a year ago, have been published in a handy and attractive form, for the Society, by Mr. John Murray. Siamese and Laos life are vividly described in the volume, and interesting information is given with regard to the geographical and general features of the country traversed.

THE Society for the Protection of Birds was called into existence to protest against the slaughter of birds for decorative purposes. It now numbers more than eleven thousand members, and the fourth annual report shows that it plays an important part in preventing the extermination of our rarer species of birds. Owing to the Society's efforts, that remnant of primitive ornamentation—the bird-wearing fashion—is on the decline. The Bill passed last July, to amend the Wild Birds' Protection Act of 1880, is given at length in an appendix to the report.

A HANDY work of reference, occupying an intermediate position between a mere school dictionary and a bulky lexicon, is Ogilvie's "Student's English Dictionary," a new edition of which, edited by Dr. C. Annandale, has been published by Messrs. Blackie and Son. The new issue has been so greatly enlarged and augmented, that it is practically a fresh work. A large number of scientific and technical terms, many of them newly introduced, as well as thousands of other words, have been added. The word-illustrations have been more than doubled, there being now nearly eight hundred of them. Experience has taught us that the "Students' Dictionary" rarely disappoints the inquirer; and its improved and enlarged form, it will be even more useful.

MR. E. MUMFORD AND Co. will shortly publish an important work on "Meteorology," by Mr. T. Russell. The volume is for its main object the explanation of the use of the barograph for the purpose of making forecasts. The various kinds of meteorological instruments are described, and a general review is given of all knowledge connected with the science of meteorology, and of interest in relation to weather changes. To the present extent, the volume refers to weather prediction in the tropics, and to the use of weather instruments in the prediction of the amount of snowfall and the depth of rivers. It will, however, be especially European meteorology, as well as also in the development of recent weather observation and prediction work, which will very soon be published by the publishers. It is a translation of the late Prof. A. de Quatrefages'

"Les Pygmées." This volume, which is the second in the Anthropological Series, has been translated by the editor of the series, Prof. F. Starr, of the University of Chicago.

THE atomic weight of tungsten has been subjected to a careful revision by Prof. E. F. Smith, of the Pennsylvania University, and the specific heat of the pure metal again determined. Two independent series of atomic weight determinations have been carried out, in which Prof. Smith has been assisted, respectively, by Miss M. E. Pennington and Mr. E. D. Desi, and accounts of the work are contributed to the current issue of the *Zeitschrift für Anorganische Chemie*. In the first series the method employed consisted in the reduction of pure tungstic acid to metal in a stream of pure hydrogen, and then determining the amount of oxygen absorbed by the metal upon conversion of the latter into tungstic anhydride by ignition in contact with the air. The mean value of the atomic weight derived from nine such determinations, taking oxygen as 16, is 184.92. The highest and lowest values obtained differed by only 0.02 from this mean value. The second series of determinations were based upon the estimation of the amount of water produced during the reduction of tungstic acid by hydrogen. Exceptional precautions were taken with the purification of the latter, in order to exclude error from this source. The mean of six experiments affords the value 184.70 for the atomic weight of tungsten, the greatest difference between the individual values being only 0.07. The slight difference of 0.2 between the results derived from the two methods of work is probably to be ascribed partly to the difference in the methods, and partly to the different personal factors involved. The mean of the two series, 184.8, may therefore be taken as representing a close approximation to the true atomic weight of tungsten. This value is considerably higher than the currently accepted one, 184.02, the number afforded by Clarke and Becker's recalculation of the experimental results of older determinations. The increase is in all probability due to the great pains which have been taken to remove the last traces of the lighter molybdenum from the tungstic acid employed, a task which is particularly difficult, and which most likely has never previously been so completely achieved.

THE specific heat of the pure tungsten obtained during the course of the atomic weight determinations has been ascertained by Prof. Smith in conjunction with Mr. Grod-speed. The method adopted was that described by Joly in 1886, involving the use of the "gravimetric calorimeter." The final mean value arrived at for the specific heat of tungsten is 0.0338, a result closely agreeing with former determinations of this constant. The atomic heat obtained by multiplying the new value for the atomic weight by this number expressing the specific heat is 6.25, a value in fairly close accordance with that usually accepted as representing the constant of Dulong and Petit for the truly metallic elements.

THE additions to the Zoological Society's Gardens during the past week include a Lion (*Felis leo*, ♂) from India, presented by Her Majesty the Queen; a Black-striped Wallaby (*Dipodomys dorsalis*, ♀) from New South Wales, presented by Miss H. W. Hoaxes; a Hairy-rumped Agouti (*Dasyprocta prymnolopha*) from Guiana, presented by Miss W. B. Jackson; a Roseate Cockatoo (*Cacatua roseicapilla*) from Australia, presented by Mr. A. Reynart; four Triangular-spotted Pigeons (*Columba jamaica*), two spotted Eagle Owls (*Bubo maculosa*) from South Africa, presented by Mr. J. E. Matcham; a Fieldfare (*Turdus philini*) British, presented by Mr. Gervase F. Mathew; two Lions (*Felis leo*, ♀) from India, deposited; an Llanid (*Oreos canina*, ♂), two Collared Fruit Bats (*Cynonycteris collaris*) born in the Gardens.

OUR ASTRONOMICAL COLUMN.

ORIGIN OF THE LUNAR FORMATIONS.—The experiments by which Scrope attempted to reproduce the characteristic features of the moon's surface have been repeated with slight modifications by M. Stanislas Meunier, and the results which he has obtained are certainly very suggestive, if, indeed, they do not furnish the key to the origin of the various formations which the moon presents to us. (*Comptes rendus*, January 28.) Plaster is mixed with water in which a little glue has been dissolved to prevent too rapid setting, and the mixture is heated in a frying-pan over a gas-burner until ebullition commences; the gas is suddenly turned off at an opportune moment, and the mass is left to cool undisturbed. Experimenting in this way, and by varying the consistency of the paste, M. Meunier has obtained many features besides the intermingling circular cavities produced by Scrope. The central peaks which are so frequently noticed in lunar craters are reproduced perfectly, being formed at exactly the same time as the circular borders, and even resembling their lunar prototypes in being generally somewhat lower than the edges of the craters. Further, the artificial craters tend to form in groups of two or three, or even more, and sometimes one ring will envelope several; some parts may be covered with cavities, with or without central peaks, and relatively large smooth areas at once recall the lunar "seas." If the experiment be carried on until nearly the whole of the water is evaporated, fissures also make their appearance.

By covering the paste with fine grey sand at the moment it begins to boil, the results are said to be still more striking, and better adapted for photography.

M. Meunier expresses the opinion that the moon has failed to pass through all the planetary stages, in consequence of the original relative scarcity of fluids, and he believes this conception to be confirmed to some extent by another modification of the experiment, in which the paste is covered with a rather thick layer of sand, representing the rocks forming the earth's epidermis; the "volcanic" manifestations then change character, and more nearly approach terrestrial types.

γ CASSIOPEIE.—This star has always possessed a special interest to spectroscopic observers since the discovery of bright lines in its spectrum by Secchi. Continued observations seemed to suggest a periodicity in the visibility of the bright lines, but this question can now be attacked more completely by the photographic method. Fifty-three photographs, extending over a period of six years, have been taken at South Kensington, and a first examination of the negatives has led to several important conclusions (*Roy. Soc. Proc.* vol. lvi. p. 173). The lines of hydrogen were constantly bright in the period covered by the photographs, and other bright lines were also seen in all good photographs. Further, the lines of hydrogen are double in all the photographs taken with sufficient dispersion, and the distance between the components is constant within the limits of error in measurement. Other conclusions are that the bright lines of hydrogen are superposed on broad dark bands, and that there are also other ill-defined dark lines in various parts of the spectrum; these dark lines correspond very closely with the lines seen in the spectra of ζ Orionis and Bellatrix. "This at once contradicts Prof. Scheiner's recent statement that he does not believe it possible that dark lines can exist in the spectrum." Dark lines have also been observed and photographed by Keeler.

It will be seen that the spectrum presents numerous peculiarities, and an explanation of the physical condition of the star or stars which produce the different appearances is by no means simple.

THE IDENTITY OF DENNING'S AND BRORSÉN'S COMETS.—It was pointed out in the *Astronomische Nachrichten*, No. 3271, that the orbits of the comet 1894 I (Denning), and Brorsén's comet, intersect in heliocentric longitude 285°, and that early in 1881 the two objects must have been close to one another near the point of intersection (see NATURE, January 24, p. 302). The elements used for the comparison were, in the case of Denning's comet, due to M. Schulhof. This computer gives new elements for the comet, in *Astr. Nachr.* No. 3276, and expresses an opinion upon the suggested connection. He thinks that the elements compared, with the exception of inclination, certainly present some points of resemblance. More important, perhaps, is the fact that the point of intersection of the two orbits is nearly their point of nearest approach to the orbit of Jupiter.

Applying M. Tisserand's criterion for the connection between two orbits, the value 0.47 was found for Brorsén's comet, and 0.50 for Denning's. It is therefore concluded that the two comets formed at one time a single body, and that after their separation their orbits were more and more modified by Jupiter.

THE ANTITOXIC SERUM TREATMENT OF DIPHTHERIA.

II.

The Treatment.

ASSUMING now that the antitoxic serum is available, how is it to be used? It has been strongly recommended that it should be used not only as a curative or direct therapeutic agent, but that it should also be used as a prophylactic—that is, as a protective agent against possible infection, especially during those periods when diphtheria is rife. It is almost too soon to consider this prophylactic property of antitoxic serum, as for some time to come the energy of those engaged in the preparation and use of this serum must be directed towards obtaining a sufficient supply for the treatment of cases of developed diphtheria.

Results of this Method of Treatment.

It may be well to consider what have been the results obtained up to the present, and for this purpose the statistical method will probably carry most conviction, especially if it is possible to give full and accurate detail; and now that these statistics have been criticised not only by those who have used this treatment, but also by those who oppose it because it runs counter to their feelings and ideas, they are every day more and more trustworthy, much fuller, and more valuable.

It is first necessary to determine the average case mortality in diphtheria for some considerable period before the antitoxic treatment was introduced; then to see what has been the lowest case mortality during an equal and similar period for which we have any statistics; and lastly, to compare these with the case mortality of the period during which the antitoxic serum has been used.

In Table I. are given the mean annual death rates from diphtheria per million living in England and Wales and in London, in four periods of three years each.

TABLE I.

	1871-3	1874-6	1877-9	1890-2
England and Wales	144	166	173	192
London	213	227	315	377

Dr. Sykes gives the following statistics:—During the year 1892 there were 1962 deaths from diphtheria in London, whilst in 1893 there were 3205, or nearly twice as many deaths.

Now let us see what has been the case mortality. Statistics after correction give the following results. During 1893 there were 13,694 cases of diphtheria notified in London. The mortality amongst these cases was 3195 (*Lancet* statistics corrected), or 23.3 per cent.

Table II. gives further information, and enables us to see what is the diphtheria case mortality in large well-found hospitals.

TABLE II.—Metropolitan Asylums Board: Admission, and Case Mortality, Diphtheria, 1888-93.

Year.	No. of admissions.	N. of deaths.	Percentage of case mortality.
1888	99	46	46.4
1889	722	275	38.0
1890	942	316	33.5
1891	1312	397	30.2
1892	2009	583	29.0
1893	2848	865	30.3

Note.—Diphtheria cases have only been admitted into the Hospitals since October 23, 1888.

In Table III. are given statistics dealing with the diphtheria case mortality where the serum treatment has been used. Wherever possible, the case mortality over a considerable period is given in the last column of the table, for purposes of comparison.

1 A lecture delivered at the Royal Institution, on Friday, February 8 by Dr. G. Sims Woodhead. (Continued from page 406.)

X 111

Name of doctor	Number of cases	Number of dead	Percentage of mortality
IA. HOLLAND.—			
Kessel, Berlin	233	54	23.0
1884			34.7
Baka, Buda-Pesth	117	13	11.1
Hallner, Berlin	99	37	38.5
Kate, ..	128	17	13.2
Arnsia, .. &c.	255	31	12.1
Knie, ..	121	40	33.1
Kanke, Munich	10	4	40.0
Weibgen, Berlin	95	18	28.0
Bogner, Greifswald	30	2	6.6
Kuntzen, Otscher leben	25	3	12
Hager, ..	25	1	4
Moller, Magdeburg	79	6	39.6
Sonnenberg, Berlin	107	22	20.6
Bagnisky, ..	303	13	4.2
Hahn, ..	205	49	24
Wiederhofer, Vienna	100	24	24
Trieste	252	45	17.8
Schuler, ..	32	none	0.0
Strahmann, ..	100	..	0.0
Rumpf, Hamburg	26	8	30.8
Blumenfeld, Austria	50	2	4.0
Heim, Vienna	27	6	22.2
Gradinger, ..	27	11	40.7
Montl, ..	25	1	4
Unterholzner, ..	31	8	25.8
Ganghofer, Prague	110	14	12.7
Other observers	39	4	10.2
FRANCE, ITALY, BELGIUM, SWITZERLAND			
Kony, Martin, and Charlou, Paris	448	109	24.5
Moizard, ..	231	34	14.7
Lebreton, ..	242	28	11.5
Euber, Lyons	47	16	34.0
Mya, Florence	17	2	11.7
Massei, Naples	4	none	0.0
Charon, Belgium	13	4	30.7
Ser, Constance	27	1	3.7
AMERICA			
White, New York	32	8	25.0
Muehler, Philadelphia	2	0	0.0
Welch, Baltimore	5	1	20
Catlin, ..	1	0	0.0
GREAT BRITAIN			
Cases reported to the Registrar General, London	123	22	17
Wytham, London	14	1974	38.8

taken four series of cases as reported, and have placed them side by side. The percentages of deaths at certain ages in the London Asylums Board hospitals before the serum treatment are given in Table IV., the percentages of deaths of four observers who have used the serum, in Tables V. and VI.

TABLE IV.—Showing the Mortality at Various Ages from Diphtheria admitted into the Metropolitan Asylums Board's Hospitals in the years 1888-93.

Ages	Cases admitted.	Died.	Mortality per cent.
Under 1	140	102	69.9
1 to 2	447	291	65.1
2 to 3	639	388	60.7
3 to 4	820	416	50.4
4 to 5	913	460	45.8
Totals under 5	2971	1597	53.8
5 to 10	2462	795	28.6
10 to 15	885	93	10.5

TABLE V. Showing Mortality from Diphtheria at various Ages.

	Kossel.			Wiederhofer.			Goodall.			Total.		
	Treated	Died.	Per cent.	Treated	Died.	Per cent.	Treated	Died.	Per cent.	Treated	Died.	Per cent.
Under 1 year	3	1	33.3	4	2	50.0	1	1	100.0	8	7	87.5
1-2 years	1	0	0.0	24	9	37.5	10	2	20.0	35	11	31.4
2-3 years	1	2	200.0	2	7	350.0	7	1	14.3	10	8	80.0
3-4 years	14	3	21.4	14	7	50.0	1	3	300.0	29	10	34.5
4-5 years	23	3	13.0	17	7	41.2	13	3	23.1	53	11	20.8
Fatal under 5	59	0	0.0	72	24	33.3	49	12	24.5	180	45	24.3
5-10 years	45	3	6.6	18	0	0.0	22	2	9.1	85	5	5.9
10-15 years	151	1	0.7	1	0	0.0	10	0	0.0	162	1	0.6
Grand totals	117	13	11.1	181	4	2.2	72	14	19.4	370	54	14.6

None of these were more than 13 years of age.

TABLE VI. Bagnisky (quoted by Virchow).

	Without serum treatment			With serum treatment.		
	Treated	Died.	Per cent.	Treated	Died.	Per cent.
0-2 years	33	23	69.7	34	8	23.5
2-4 ..	50	37	74.0	82	10	12.2
4-6 ..	50	27	54.0	81	7	8.6
6-8 ..	44	15	34.1	46	5	10.9
8-10 ..	24	7	29.2	30	3	10.0
10-12 ..	14	1	7.1	18	0	0.0
12-14 ..	9	0	0.0	12	1	8.3
Average for Hospital	230	110	47.8	303	40	13.2

It is very important, however, that the period of the disease at which the treatment is commenced should be taken into account, for, as already indicated, experience has taught that the later the stages of the disease at which this serum is injected, the stronger must be the dose given. It is necessary, therefore, to separate the cases in which the treatment is commenced at an early period from those in which it is commenced only when the poison has had time to disorganise the tissues, and to render them incapable of reacting to the antitoxic serum.

It is observed, however, that general statistics of this kind are of comparatively little value, unless the age of the patient treated is given. In order to determine the foundation upon which this is a very legitimate objection raised, I have

been comparing the results of the treatment of diphtheria in London with those of the same disease in other parts of a whole



The following table (VII.), given by Kossel, brings out the great importance of this element in keeping down the case mortality. In the first column is given the day of the illness on which antitoxic serum was first injected:—

TABLE VII.

Day of illness.	Treated.	Died.	Percentage.
I.	14	0	0'0
II.	30	1	3'3
III.	29	0	0'0
IV.	9	1	11'1
V.	11	2	18'1
VI.	6	3	50'0
VII.	5	2	40'0
VIII.	6	2	33'3
IX.	1	1	100'0
Unknown	6	1	16'6
	117	13	11'1

For statistical purposes, too, only those cases which have been bacteriologically examined and found to be due to the action of Loeffler's diphtheria bacillus should be accepted as being cases of true diphtheria. As most of the cases in which the diphtheria bacilli are absent run a much milder course, and are much more amenable to general treatment, and as many of these have been included under diphtheria in the old statistics, such elimination will necessarily make the record tell rather against the antitoxic serum treatment than in its favour.

From a somewhat extended experience (although condensed into a very short period of time) I am satisfied that this question of the Loeffler bacillus is most important, and that every case in which the serum is used should be bacteriologically examined.

It has been said, however, and said very truly, that statistics may be made to prove anything, and I have heard it said that the observation of a few cases of diphtheria under the antitoxic treatment is worth all the statistics that could be brought together for convincing a man of the value of the antitoxic serum treatment.

A distinguished physician, who has had charge of diphtheria wards for some time, informs me that the patients he sees now wear an entirely different aspect from those he saw before the serum treatment was adopted. Instead of being struck by the stupor, the pain, the difficulty of breathing, and the other distressing symptoms that so frequently manifest themselves during the course of this treacherous disease, he observes children with patches of membrane in the throat sitting up and playing with their toys. There is little of that distress of breathing, very little of the anxious look, and the wards altogether present a much more pleasant and genial appearance than he has ever before noticed. The other day I received a short note from another colleague, who has been going over the German hospitals to study this question, in view of taking out with him to the colonies a supply of antitoxic serum; he also states that this difference in the appearance of the diphtheria wards has impressed him far more than any statistics he has yet come across.

*The alleged ill-effects of the Use of the Serum.*

It has been said that most unfavourable symptoms have followed the exhibition of this serum. There can be no doubt of the fact; but after a careful study of the cases reported, I am thoroughly convinced that a very large proportion of them, at any rate, are merely *post hoc*, and not *propter hoc*. There can be no doubt that a kind of nettle-rash makes its appearance during the course of treatment, and that this may be accompanied by pains in the joints. Both these conditions, however, are usually quite transient, and seldom give rise to permanent ill effects. Albuminuria has also been ascribed to this treatment; but any one who has had to deal with children not only suffering from diphtheria, but from any form of disease, and even from none at all, will bear witness that albuminuria in children is of comparatively frequent occurrence. It is not striking, therefore, that those who have hitherto paid little attention to this subject should, when they come to make a careful examination of children affected with diphtheria, find a considerable number of cases in which transient albuminuria is a prominent symptom. More than this, however, it has been my duty to examine a large number of cases in which diphtheria has proved fatal, and in these cases there were certain lesions in the kidney, so distinct and so

frequently present, that in describing them I used to note simply "diphtheritic condition," and then describe in detail only those features in which the appearances differed from the type that I had in my mind. This will indicate to you that alterations in the internal organs, especially in the kidneys, such as would lead to marked interference with the performance of their proper functions, were present, and had been noted long before the antitoxic serum method of treatment came into use. I may give an example of what, under certain circumstances, might have been used as a powerful argument against the use of antitoxic serum. In the *Deutsche Medizinischer Wochenschrift* for December 20 of last year is reported a case of acute hæmorrhagic nephritis coming on after the use of Behring's curative serum. The patient recovered. But a similar case of acute hæmorrhagic nephritis in diphtheria, in which, however, the curative serum was not used, is reported in the same number of the same journal. The author of the second paper quotes some interesting statistics to show that albuminuria is of frequent occurrence in cases of diphtheria not treated with antitoxic serum. One observer found it in 131 out of 279 cases; another in 16 out of 53; another in 60 per cent. of all his cases; another in 227 out of 470. Suppression of urine has also been ascribed to the action of this agent; but here again, if a careful search be made of the records of diphtheria cases treated under the old method, it will be found that just as in scarlatina and acute specific infective diseases generally, but especially in those associated with rapidly supervening toxic symptoms, suppression of the urine is of common occurrence; and until we have statistics on these several points, which can be compared with those above mentioned, it will be impossible and unjust to ascribe conditions to the therapeutic agent which, so far as those best able to judge can see, are to be ascribed to the disease itself.

It has been held by some that the paralysis which is so common a sequel of diphtheria should disappear entirely under the use of what they are pleased to call a specific cure for the disease. It should be remembered that the antitoxic serum cannot make good any organic damage that has been caused by the action of the toxic products of the diphtheria bacillus. It may stop their action on the tissues, and it may stimulate the tissues to react against the poison, but to the tissues themselves must be left the process of repair; the *vis medicatrix nature* is alone responsible for the making good of damage already done. This damage may be done at a very early stage of the disease, and if the nerves or the muscles are attacked before the antitoxine is injected, then we must expect to find degenerations and evidence of these degenerations in the various forms of post-diphtheritic paralysis; but of this we may be sure, the sooner the poison is antagonised the less will be the risk of permanent damage to the tissues. It is for this reason, I believe, that the antitoxic serum treatment of diphtheria has been so much more successful than the antitoxic serum treatment of tetanus.

*Conclusion.*

The hope of success in diphtheria depends upon the early application of the remedy. One word of warning. It should not be accepted that this agent can reduce the cure of diphtheria to a mere process of injection. Everything must be done to improve the conditions under which the patients are treated, to maintain their strength, to give them fresh air, cleanly surroundings and good general hygienic conditions. It will be found withal that a certain number of deaths from rapid poisoning will take place, while a number of others will succumb in the later stages of the disease. This serum can no more act as a specific in every case than can quinine cure every case of malaria; but if properly used, we believe it will reduce the mortality in a very marked degree, and if at the same time those practical sanitary reforms and improvements for which our country is so justly renowned are carried out, we may expect that diphtheria as a scourge may gradually die out from our midst. As Dr. Seaton pointed out at Buda-Pesth, we have done more in this country to improve the conditions associated with most specific infective diseases than any other nation in the world. If, now, we can graft on to our system what is best in Behring's treatment, I am convinced that we shall soon have diphtheria statistics which will compare very favourably with any that have yet been presented. The antitoxic serum treatment is only one of our lines of defence against this disease; but so much progress has already been made along this line, that within a few years, or even months, we may fairly anticipate the announcement of still greater advances and successes.

DR. DUBOIS'S SO-CALLED MISSING LINK?

AT a meeting of the Royal Dublin Society, held on Wednesday, January 23, Dr. D. J. Cunningham, F.R.S., Professor of Anatomy in the University of Dublin, and Hon. Secretary of the Society, read a paper upon the characters presented by the fossil remains recently described by Dr. Dubois (see NATURE, January 24, p. 291.) The following is an abstract of this communication.

The fossil remains are three in number, viz.: the upper part of a cranium, a right-upper wisdom tooth, and a left femur. They are believed to belong to the Pleistocene period, and according to Dubois, present characters which justify him in placing the animal to which they belonged in a new family which stands midway between man and the apes. The specimens were found in Java, on the left bank of the Bengawan River, in the neighbourhood of Trinil. Each was exhumed at a different time, but all at the same level, viz. 1 m. below the dry-season level of the river, and from 12 to 15 m. below the level of the plain through which the stream has cut its way.

The characters assigned to the new family proposed by Dubois are the following: "Cranium absolutely and relatively to body-size, much more roomy than in simiidae, but less roomy than in hominidae; cranial capacity about two-thirds of the average capacity of the human cranium. The inclination of the occipital surface of the occiput distinctly stronger than in simiidae. Dentition after the type of the simiidae. Femur similar in its dimensions to that of man, and designed for the upright walk and a trade."

The leading peculiarities of the cranium of the so-called Pithecanthropus are: (1) the low depressed character of the cranial arch; (2) the extreme narrowness of the frontal region;

we are led from the fossil form up through the Neanderthal and Spy forms to the modern cranial arch.

The heavy, strongly marked superciliary ridges constitute another Neanderthal feature of the fossil form, but the transverse frontal diameter is very much less than that of the Neanderthal or Spy crania. In this respect the fossil cranium closely approaches the microcephalic skull referred to above, and also the skull of the gorilla.

When the measurements of the fossil cranium are compared with those of the Neanderthal and Spy skulls, other striking resemblances become manifest.

	Maximum antero-posterior diameter.	Maximum transverse diameter.	Cephalic index.	Cranial capacity
Fossil cranium ... ..	185	130	70	1000(?)
Neanderthal cranium ...	200	144	72	1200(?)
Spy cranium No. 1 ...	200	140	70	
Cranium of intelligent adult woman measured in the Anthropometric Laboratory of Trinity College ... ..	167	130	83.2	—

The fossil cranium is thus only 15 m.m. shorter and 10 m.m. narrower than the Spy cranium No. 1. In every anthropo-

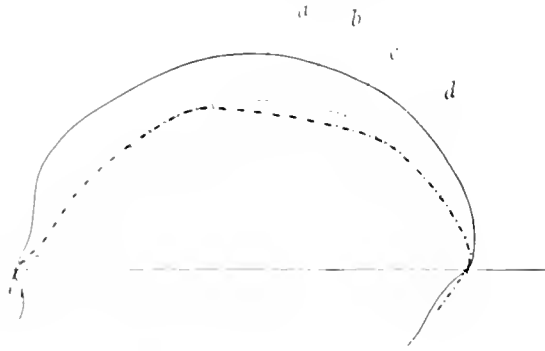

FIG. 1.—Outlines of the antero-posterior cranial arch of: a, ordinary Irish skull; b, skull of a microcephalic idiot; c, fossil cranium described by Dubois; d, skull of a gorilla. The line *m* is one which passes through the centre of the orbit, the centre of the orbit, and the centre of the glabella in the case of the skull of the gorilla.

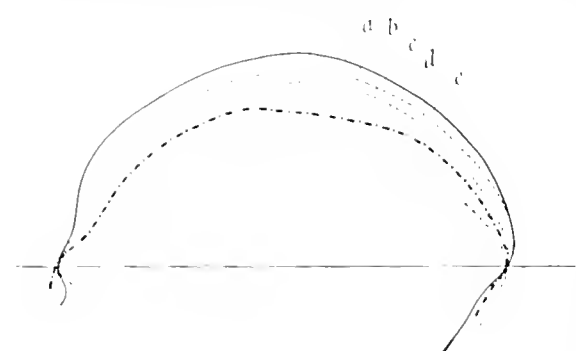

FIG. 2.—Outlines of the antero-posterior cranial arch of: a, ordinary Irish skull; b, Spy cranium No. 2; c, Neanderthal cranium; d, the fossil cranium described by Dubois; e, the skull of a gorilla. Base-line the same as in Fig. 1.

and (3) the striking development of the superciliary ridges. These are all to some extent simian features; and when outlines of the antero-posterior cranial arch of an ordinary Irish skull, of the skull of a microcephalic idiot (the brain of which presented many atavistic characters), of the fossil cranium, and of the skull of a young male gorilla, are reduced to the same size and superimposed one upon another, it is seen that the idiot cranium and the fossil cranium present almost identically the same curvature, but that the two outlines occupy a place about midway between the ordinary Irish cranium outline and that of the gorilla (Fig. 1).

Another combination of equally striking and equally interesting characters which distinguish the antero-posterior cranial arch of the fossil form, of the Neanderthal skull, of the Spy cranium No. 2, and of the ordinary Irish skull, are superimposed one upon another (Fig. 2). In this respect the Neanderthal cranium presents almost exactly the same characters as those of the fossil form, and is rather more like the latter than to the outline of the arch of the modern Irish skull. The Spy cranium No. 2 occupies a place between the modern Irish skull and the Neanderthal cranium, that by a series of easy and nearly equal gradations

metric laboratory intelligent individuals are occasionally measured who possess an antero-posterior cranial diameter very much less than that of the fossil cranium. In these cases, however, the head is usually brachycephalic, and presents a high and full cranial arch. In the above table the diameters of one of the smallest heads measured in the Dublin University Laboratory are given.<sup>1</sup>

Dubois calculates, from a comparison with ape crania, that the fossil specimen had originally a capacity of at least 1000. The average capacity of the European skull may be said to range from 1400 to 1500 (Weleker), and the Neanderthal cranium has been computed to have had a capacity of 1200. In this respect, therefore, the Neanderthal skull takes an intermediate place between that of the fossil form and of the European. Further, it should be borne in mind that a capacity of 1000 is usually regarded as indeed Dubois points out) as being the physiological minimum for the human cranium.

From these considerations the fossil cranium described by Dubois is unquestionably to be regarded as human. It is the

<sup>1</sup> A female cranium from the Island of Inishboffin on the west coast of Ireland presents an antero-posterior diameter of 173 m.m., and a transverse diameter of 122 m.m. In both of these diameters, therefore, it is smaller than the Java fossil cranium. It differs from the latter, however, in possessing a very lofty antero-posterior cranial arch.

<sup>1</sup> See also a paper by the same author on the "Pithecanthropus form" in the Proceedings of the Royal Dublin Society, (Batavia, 1894.)

lowest human cranium which has yet been described. It presents many Neanderthaloid characters, but stands very nearly as much below the Neanderthal skull as the latter does below the ordinary European skull. The similarity in form which it presents to the microcephalic cranium, with which it has been compared, is undoubtedly interesting, but on this account we are not to conclude that it belonged to a person of feebler intellect than others of the same race. The Neanderthal skull was supposed by certain observers at one time to have been that of an idiot, but this idea was disposed of when other crania, presumably belonging to the same geological period, and possessing similar characters, were discovered. That the fossil cranium should in many respects resemble certain microcephalic skulls, is not surprising: indeed, to some extent it was to have been expected, seeing that a considerable number of this class of idiots present undoubted atavistic characters in so far as brain and cranium are concerned.

Dubois, in his description of the fossil cranium, institutes a close comparison between it and the crania of the higher apes, and only incidentally touches upon its relationship with the human cranium. He asserts that no good could arise from a comparison between it and the Neanderthal and Spy remains, seeing that the latter are pathological. It is not within the scope of an abstract, such as this, to take up the gauntlet on a question of this kind. It will be sufficient to assert an entire accordance with the views so ably advocated by Prof. Huxley, viz. that the Neanderthal and Spy crania are typical of the earliest human race with which we are acquainted.

It is not necessary to delay over the femur. That it is human in every respect, no one could for a single moment doubt. Further, it is curious to note that its form and proportions are more those of a modern than of a prehistoric thigh-bone. It presents none of the characters which distinguish the Spy femora. Its length is 455 m. m., therefore the height of the individual to whom it belonged must have been 1654 m. m., or, in other words, about the same as that of an average Frenchman.<sup>1</sup> From the fact of the femur being found at a distance of from 12 to 15 m. from the place where the cranium was discovered, as well as from other considerations, it is very unlikely that the two specimens belonged to the same individual.

The tooth is undoubtedly a very remarkable specimen. Its great size and strong divergent fangs are characters which at first sight appear to separate it widely from an ordinary human upper wisdom tooth. But we know that in low races, such as the Australian and the Negro, and also in the ancient Neanderthaloid race, the wisdom tooth has not undergone the same retrograde changes which we observe in the European and other mesognathic or orthognathic people. If we take the mean of the antero-posterior and the transverse diameters of the crown of the fossil tooth, we get a result of 13·3. A right upper third molar extracted from the jaw of a negro, treated in the same way, yields a result of 11·5, whilst three Irish upper wisdom teeth, selected at random, give an average of 9. The negro tooth is thus seen, in point of size, to be as far removed from the European tooth as the fossil tooth is from it, and the same may be said for the condition of the fangs. The fossil tooth, so far as one can judge from the figure, is fashioned more after the human model than the simian. The variability of an upper wisdom tooth in man is very remarkable, not only in regard to size, but also in the disposition of its cusps and fangs.<sup>2</sup>

From what has been said, it will be seen that the skull and the tooth, even granting that they are from the same individual, present no such characters as would warrant the formation of a new family. The cranium at least is undoubtedly human. Most certainly they are not derived from a transition form between any of the existing anthropoid apes and man; such a form does not and cannot exist, seeing that the divergence of the ape and man has taken place long down in the genealogical tree, and each has followed, for good or bad, its own path. The so-called Pithecanthropus is in the direct human line, although it occupies a place on this considerably lower than any human form at present known.

### UNIVERSITY AND EDUCATIONAL INTELLIGENCE.

OXFORD.—The Biological Club held its jubilee meeting on Saturday last, when the professors of the biological faculties in the University were entertained to a commemorative dinner given in Merton College. The ravages of influenza unfortunately deprived the Club of the presence of several familiar members and of more than one expected guest; but the presence in Oxford of Prof. Bayley Balfour gave the Club an opportunity of extending its welcome to an old friend and an additional distinguished visitor. In the absence of Mr. G. C. Bourne, the presidential chair was taken by Mr. Henry Balfour, of Trinity. Profs. Bayley Balfour and Lankester replied for the guests.

In accordance with a recommendation from the Board of Faculty of Natural Science, the Council has approved of the subject of Astronomy being added to the list of subjects which may be offered in the Honour School of Natural Science. For a reason which is not very obvious at first sight, a candidate who offers Astronomy as a final subject must have obtained honours in the first or second public examination, but need not have passed any of the preliminary science examinations; and a candidate who has passed the science preliminaries is not eligible to compete in the Honour School of Astronomy unless he has obtained honours in the first or second public examination. The object of this rule, which places the School of Astronomy in a position different to that of any other science school, is to compel candidates to take Honours either in Mathematical Moderations or Finals before entering on Astronomy. But the object is not attained, for as the statute now runs, a man who has taken honours in Classical Moderations or in any Final Honour School may enter for the Astronomical School, whilst a man scientifically trained cannot. It may be hoped that the rule, which as it stands is absurd, may soon be rectified. The subject of Astronomy has long been an optional or additional subject in the Honour School of Natural Science, but like other additional subjects, has not attracted students. Astronomy having asserted its claims to recognition, Anthropology has followed its lead, and the Faculty of Natural Science has by a large majority sent up a recommendation to Council that the subject of Anthropology should be added to the Final School. The answer of Council has not yet been received.

In a Congregation held last week, the Curators of the University Chest were empowered to make sundry payments to the Curators of the Botanic Garden, to bring up the whole income of the Garden during each of the next four years to a sum sufficient to defray its expenses.

Mr. G. C. Bourne, Fellow of New College, has been elected a Delegate of the University Museum, in place of Mr. E. Chapman, Fellow of Magdalen College, resigned.

CAMBRIDGE.—The vacancy in the Sadlerian Professorship, caused by the death of Dr. Cayley, has been filled up by the election of Dr. A. R. Forsyth, F.R.S., University Lecturer in Pure Mathematics. Dr. Forsyth is well known as the author of standard text-books on Differential Equations and the Theory of Functions, and of many papers on the higher branches of pure mathematics. He is a Fellow of Trinity, and a member of the Council of the Senate.

Dr. Charles Waldstein, Reader in Classical Archaeology, has been elected to the Slade Professorship of Fine Art, vacant by the retirement of Prof. Middleton.

A shower of "fly-sheets" has fallen on the University on the question of requiring further evidence of power to write essays in the various degree examinations. The question will be decided by the vote of the Senate on Thursday afternoon.

SINCE 1892 there has been a decrease in the number of candidates for entrance into the Central Technical College at South Kensington. But though fewer candidates have presented themselves, the number admitted is about the same, indicating either that the examiners lowered the standard of students, or that candidates were better prepared for the examination. In the report of the work of the College during the session 1893-94, various causes are given to account for the diminution of candidates. One is the great increase of facilities for obtaining technical education in London and in the provinces since the College opened. To what extent this in-

<sup>1</sup> Popinard gives the average height of the French as 1650 m. m.  
<sup>2</sup> In the museum of the Dublin School of Dental Surgery there is an upper wisdom tooth extracted from the maxilla of an Irishman, the crown of which presents a transverse diameter of 13 m. m., and an antero-posterior diameter of 12 m. m. (mean result 12·3); which possesses seven cusps and four root fangs, two of the latter being partially fused. This tooth is very little smaller than the wisdom tooth of the fossil form, and is more remarkable in the way of cusps and fangs.

crease of schools for technical education may help or hinder the development of the Central Technical College remains to be seen. If to some extent it increases the competition for students, on the other hand it may, in the long run, more than compensate for this by increasing the public appreciation of the value of technical education. It is also suggested that probably the falling off in the number of candidates for admission is chiefly due to the continued commercial depression, and happily this is a disadvantageous condition which may be expected to pass away.

A copy of the programme of the College, received at the same time as the report, shows that the College is far and away in advance of similar institutions in London, and is in the highest degree competent to provide "for the higher technical education, in which advanced instruction shall be provided in those kinds of knowledge which bear upon the different branches of productive industry, whether manufactures or arts."

### SCIENTIFIC SERIALS

*American Journal of Science*, February.—On the relation of gravity to continental elevation, by T. C. Mendenhall. Determinations of the intensity of gravitation made by the Coast and Geodetic Survey, and by Commander Defforges, and extending across the North American continent, bring out the fact that the deviations from the values of gravitation as deduced from the theoretical shape of the earth's spheroid, are in a direct relation to the elevation of the observing station above sea-level. An explanation based upon differences in the density of the surface layers is difficult to find, but the fact is undoubted.—Glacial phenomena of Newfoundland, Labrador, and Southern Greenland, by G. F. Wright. The ice-sheet of Southern Greenland formerly sent glaciers down through all the fiords, filling them to a height of about 2000 feet, and pushing even to the very margin of the continent. Greenland, therefore, like the rest of the world, has had its ice age, which has already partially passed away. During the maximum of the ice extension, the mountains bordering the sea in Southern Greenland formed innumerable "nunataks." The ice was not thick enough to cover them in solid mass, and there is no probability that the ice extended far out into Davis Straits. In Labrador and Newfoundland, on the other hand, all the mountains were completely covered with glacial ice, which extended far out over the bordering continental plateau. The facts point to considerable preglacial elevations of land, followed in Labrador, at least, by a period of extensive depression below the present level, and subsequent gradual elevation. There is evidence of a recent date of the glacial period, while the indications of recent change of level point to tectonics rather than astronomical causes to account for the vicissitudes of the glacial period.—*The *Arct. *Antropus erectus**, Dubois, from Java, by O. C. Miller, see pp. 428-29.*

*Bulletin of the American Mathematical Society*, vol. 3, 4 (New York, January 1895).—A pathetic interest is attached to the second article, "Note on a memoir in Smith's collected papers," which must have been amongst the last pieces of work done by Prof. Cayley. The memoir is that on the Theta and Omega Functions (Smith paper, vol. 1, pp. 415-623). The notice is a very able one, and gives an abstract of the contents of the memoir.—The opening period a presidential address, delivered before the American Mathematical Society at its annual meeting, December 28, 1894, of which the title is, "The Past and Future of the Society." Dr. M. Chittock traces the growth of the Society from its origin in 1888 as a small mathematical club, meeting at Columbia College, where the first meeting was called by circular, organized by three gentlemen, up to its present membership of 251. A paragraph points out that the pioneer of all these mathematical societies was to have, subsequently sprung up was the London Mathematical Society. "There had been a previous example of a similar organization, and fears were felt and expressed that its management might naturally drift into the hands of a few having time and energy to give to its culture, and that there might thus be a real danger of its falling into the control of a clique. The type of time has developed the fact that the leading members of that Society have been men of broad views, unusually free from personal prejudice, and quick to recognize talent wherever displayed. We may almost

conclude from the history of that Society that proficiency in the science of mathematics is distinct evidence of a well-balanced mind." We repeat the wish we have previously expressed for the continued success of this flourishing young branch. In the Notes the new officers and Council are given, the new President being Dr. George W. Hill.—A long list of new publications closes the number.

In the numbers of the *Journal of Botany* for January and February, new plants are described by Mr. A. Fryer from Scotland (a new hybrid *Potamogeton*); by Mr. R. P. Murray, from Tenerife; by Mr. W. Fawcett, from Jamaica; and by Mr. H. N. Ridley, from the Malay Peninsula. Mr. A. Bennett discusses the claims of *Juncea tenuis* to rank as a British species.

### SOCIETIES AND ACADEMIES.

#### LONDON

**Chemical Society**, February 7.—Dr. H. E. Armstrong, President, in the chair.—The following papers were read: The action of heat on ethylic  $\beta$ -amidocrotonate: Part II, by J. N. Collie. During the destructive distillation of this salt,  $\alpha$ , $\gamma$ -dimethyl  $\alpha^1$  ethoxypyridine, a dimethylpyrrol and a pyridine derivative,  $C_6H_5N_2O$ , are produced together with ethylic luitidionemono-carboxylate.—The acidimetry of hydrogen fluoride, by T. Haga and Y. Osaka. Phenolphthalein is the best indicator to use in the titration of hydrofluoric acid. The authors' experiments with litmus suggest that the molecular composition of hydrogen fluoride is  $H_2F_2$  or  $H_4F_4$ .—Composition of ancient silver ornaments from Peru, by Miss C. Walker.

Molecular change in a silver amalgam, by Miss F. T. Littleton.—On heating silver amalgam, preferably of the composition  $AgHg_4$ , considerable swelling occurs; this can only be attributed to molecular change, inasmuch as gas is not evolved.—Sulphocamphylic acid II., by W. H. Perkin, jun. Further evidence has been obtained indicating that this acid has the composition  $C_9H_{12}(SO_3H).COOH$ ; the acid yields two isomeric acids  $C_9H_{12}.COOH$  on fusion with potash. Other new derivatives have been obtained.—Derivatives of ethylorthotoluidine, by W. MacCallum, jun.—Acetyl derivatives of benzacotine and acotinine, by W. R. Dunstan and F. H. Carr. A number of unsuccessful attempts have been made to convert benzacotine into acotinine by introducing an acetyl group: two isomeric triacetylbenzacotines and a tetraacetylbenzacotinine are obtained on acetylation. The authors have also prepared di- and triacetylacotinine and triacetylpyracotinine.—Aconitine aurichlorides, by W. R. Dunstan and H. A. D. Jowett. A new examination of the three modifications of acotinine aurichloride confirms the authors' previous assertions as to the existence and nature of these compounds. The alcoholate of acotinine aurichloride described by Freund and Beck is the  $\beta$ -aurichloride containing a little alcohol.

**Entomological Society**, February 6.—Prof. Raphael Meldola, F.R.S., President, in the chair.—The President announced that he had nominated the Right Hon. Lord Walsingham, F.R.S., Mr. Henry John Elwes, and Prof. Edward B. Poulton, F.R.S., Vice-Presidents of the Society for the Session 1895-96.—Mr. W. E. H. Blandford made some remarks regarding Mons. Brongniart's donation to the library, of his monograph entitled "Recherches pour servir à l'histoire des Insectes Fossiles des Temps Primaires." Mr. Blandford called attention to figures of pupae of species of *Spalgus* (Lycander), in the *Journal of the Bombay Natural History Society*. A discussion followed, in which Mr. Humpson and Mr. McLachlan took part.—Canon Fowler exhibited, on behalf of Mr. C. A. Myers, an unusually fine specimen of *Sphæria rotata*, growing from the prothorax of an underground larva of a *Hepialis*, supposed to be *H. vivaceus*, from New Zealand. Mr. McLachlan said that there was a doubt whether the caterpillar should be referred to this species. Mr. Blandford stated that the French Government had set aside a section of the Pasteur Institute at Paris for the study of entomophagous fungi.

Prof. L. C. Miall, F.R.S., and Mr. N. Walker, communicated a paper entitled "On the Life History of *Ericoma canescens* (Psychodæ)," with an Appendix by Baron Osten-Sacken. Herr Jacoby read a paper entitled "Contributions to our knowledge of African Phytophagous Coleoptera." Dr. D. Sharp, F.R.S., remarked that Enchsen began the "In-

sekten Deutschlands" some sixteen years ago, and as he was engaged on a classification of the Coleoptera of the world, he included a considerable number of these exotic species in his work.—Mr. G. F. Hampson read a paper entitled "Descriptions of New Heterocera from India."

**Mineralogical Society, February 5.**—Dr. Hugo Muller, F.R.S., in the chair.—Prof. Judd read a paper on some simple crystalline rocks (massive minerals) from India and Australia. From specimens supplied by Mr. T. H. Holland, of the Geological Survey of India, Mr. P. Bosworth Smith, late Government Mineralogist at Madras, and Mr. C. Barrington Brown, the author was able to make known some new types of rocks. Two remarkable forms of corundum-rock were noticed, one from Pipra, S. Rewah, first brought to the knowledge of mineralogists by Mr. F. R. Mallet, and the other from Hunsur Talug, in the Mysore State. A fibrolite rock, derived from the same district as the last, was also noticed. A new variety of tourmaline (schorl)-rock with a fibrous texture, having a wide distribution in India, was likewise described, and an analysis, together with a description of the optical properties of the mineral, was given. From the Bingera district in New South Wales, two dykes were described as traversing masses of serpentine, one being composed of a green garnet-rock (grossularite?) yielding gold, and the other of picotite, the chrome-spinel.—The Earl of Berkeley read a paper on an accurate method of determining the densities of solids, in the course of which it was shown that by taking suitable precautions with a pycnometer having a thermometer stopper and a capillary at the side, results accurate to 0.03 per cent. could be obtained. The actual values for different crops of rubidium alum were 1.8884, 1.8885, 1.8885 and 1.8889. The chief point of the communication was that the evaporation of the liquid used in the observations (CCl<sub>4</sub>) from the film formed between the stopper and the neck of the pycnometer, instead of being a source of error, is utilised to bring the level of the liquid into coincidence with the mark on the capillary.—Prof. Church made a communication on the determination of mineral densities. Three points were specially referred to: The employment of dilute alcohol instead of water was recommended as enabling full advantage to be taken of the sensitiveness of an assay balance; the results quoted for specimens under two grams in weight were probably correct to 0.03. A method of removing interstitial air by first replacing it with carbon dioxide, and then absorbing this gas by an alkaline solution or hyboiled water was described. An account was next given of a method of determining relative densities by means of mercury, the volume of mercury displaced by the mineral being weighed. Although no novelty was claimed for these methods, special precautions in their conduct were named, and illustrations adduced of their application to the determination of mineralogical problems.

## CAMBRIDGE.

**Philosophical Society, February 11.**—Prof. J. J. Thomson, President, in the chair.—On a method of determining the conductivities of badly conducting substances, by Prof. J. J. Thomson. A sphere of the substance the conductivity of which is to be determined is placed inside a coil A through which very rapidly alternating currents are passing. The currents induced on the sphere react on those in the coil. A small coil B placed in series with A contains a highly exhausted bulb in which a ring discharge is produced by the alternating currents. Any change in the intensity of the currents through A produces a change in the brightness of the discharge through the bulb inside B. The effect produced by the sphere inside A is measured by the change in the brightness of the discharge within B, and as the effect produced by the sphere depends on its conductivity, the observation of changes in the brightness of the discharge makes it possible to compare the conductivities of different substances. The paper contains applications of this method to the study of the conductivity of electrolytes under very rapidly alternating currents, of rarefied gases, of gases when entering into chemical combination, of flames, and of the effect of the formation of drops of water from aqueous vapour.—Note on the calibration of the wire of a Wheatstone bridge, by Mr. E. H. Griffiths.

## BERLIN.

**Physiological Society, January 4.**—Prof. du Bois Reymond, President, in the chair.—In the discussion on Prof. Waldeyer's discourse (of December 21, 1894), Dr. Benda and Dr. Rawitz

laid stress on the anatomical difficulties which stand in the way of the generalisations of Golgi's school, and Prof. Gad made his protest from the physiological point of view. Prof. Waldeyer recognised the propriety of the objections made against the newer views as to the minute anatomy of the nervous system, views due to those recent methods of research which have led to a very distinct advance in knowledge. Dr. Ziegenhagen communicated the results of his researches on the development of the blood-vessels in trout-embryos, based on observation of the living object, on injections by Weirheim's method, and on photographs.

January 18.—Prof. du Bois Reymond, President, in the chair.—Dr. Benda explained the preparations he exhibited of nerve-endings in muscles made by Prof. Sihler, of Cleveland.—Dr. Rawitz described a new method of staining cells with aniline dyes, which consists in first mordanting the tissues, hardened in Flemming's fluid, with tannin and tartar emetic, and then treating them with the dye. By this method of "adjective" staining, only the protoplasm of the cell is coloured, not the nucleus. The same speaker next described some results of his method as applied to resting-cells of salamander testis. The nucleus shows the brown-coloured chromatin filaments; the linin network and the distinct nuclear membrane are of a pale red colour. In the middle of the protoplasm, at some distance from the nucleus, is the dark-red attraction sphere with the centrosome in its midst. Close-set meshes of the network of red fibrils, which permeate the protoplasm, and are in other parts less close-set, join on to the periphery of the sphere, and are in direct communication with the nuclear membrane and the linin filaments. Occasionally the attraction spheres of two neighbouring cells are joined together by a dark-red filament.—Dr. Cohnstein described experiments on the action of intravenous injections of sodium chloride on the composition of lymph and blood, and showed that the observed variations of quantity and of the amount of water and salt in the lymph, as also the changes in the amount of salt in, and concentration of the blood, could be adequately explained by the purely physical processes of diffusion and filtration.

**Meteorological Society, January 8.**—Prof. Hellmann, President, in the chair.—Dr. L. A. Bauer discussed on the secular changes of terrestrial magnetism. From the observations available at an extended series of stations he had determined the declination and dip of a magnetised needle freely suspended at its centre of gravity, and had compared the curves of secular change thus obtained with the corresponding formulae. Taking older compass-charts additionally into consideration, he found that the curves of secular change must contain loops. If one imagines a magnetised needle, freely suspended at its centre of gravity, to be carried round the earth along a given parallel, one obtains the momentary curve of terrestrial magnetism for that parallel, and this curve corresponds to the curve of secular variation. This curve further shows a distinct loop, as, for example, for the parallel 40° N. In the discussion which followed, the President drew attention to the fact that the statements of the older travellers as to compass bearings can not well be used for determining the components of terrestrial magnetism, since each compass was specially arranged in order to show the astronomical north-pole, and hence it is necessary, first of all, to know what this special arrangement was before their indications can be used. Dr. Kassner described a "fohn" wind in the Riesengebirge, which was very marked on November 1 and 2 last, on the north fall of the mountain, and caused by the high temperature and excessive dryness. The dryness and great transparency of the air was observed as far as Breslau, a distance of 100 kilometres.

**Physical Society, January 11.**—Prof. du Bois Reymond, President, in the chair.—Dr. Altschul made communications from the Roul Pictet Institution, dealing first with the influence of intense cold (−70° to −200° C.) on a long series of chemical processes, and in the next place on physical processes, such as phosphorescence, &c. He then reported upon experiments on the behaviour of bodies at the critical temperature. The disappearance and reappearance of the meniscus was found to take place always at the same temperature as long as the warming of the substance was uniform. It was found that the critical temperature is a better criterion of the chemical purity of a liquid than are its melting point and boiling point, and a number of instances were cited where minute impurities altered the critical temperature by many degrees. Solutions of solids when heated above the critical temperature gave no precipitate,

the solid remaining dissolved in the gaseous vapours. Solutions of colouring matter behave similarly.

January 25. Prof. La Bois Reymond, President, in the chair.—Mr. A. Schott discussed the principles and advantages of two recently invented telescopes, of which one with a 44 inch lens and short focal length is to be set up in the Berlin Industrial Exhibition in May 1895, while the second, with a 50 inch objective-glass, is to be taken in hand later on. The glass for the first of the two is already cast by Dr. Schott, and is to be ground according to scientific principles by Steinheil. The speaker further discussed a series of important novelties in the mounting of the telescopes, by which the cost of the same would be materially reduced. The session, which was then opened by Prof. von Bezold, on behalf of Profs. Auwers and Vogel, and continued by Prof. Sommer, was adjourned to the next meeting.

Notes.—In the report of the meeting of the Physiological Society of December 7, 1894, NATURE, vol. li. p. 288, for "Dr. G. Joachim," read "Dr. G. Joachimstal."

PARIS.

Academy of Sciences, February 18.—M. Marey in the chair.—On Neumann's method and Dirichlet's problem, by M. H. Poincaré.—On the form of the intrados of arches, by M. H. Reiss.—On the kinds of chlorophyll; remarks on *Zygnema* of the north, by M. Laroche, by M. Arm. Gautier. The author claims priority for the proof that several chlorophylls exist, and that chlorophyll contains no iron, but contains organic phosphorus.—On the agricultural value of aluminium phosphates; remarks on the note of M. Andouard's note, by M. Arm. Gautier. In 1893 the author showed that amorphous aluminium phosphate was of value in agriculture owing to its solubility in the products of decomposition present in soils. This does not extend to crystallized phosphates of aluminium or of aluminium and calcium.—On the estimation of tannic compounds, by M. Aimé Girard.—Remarks on atomic weights, by M. Lecoq de Robaudin. The author mentions a method of classification of the elements which enables him to calculate their atomic weights as well as predict their properties; this system has not yet been published. According to it, argon belongs to a group of elements of which no other members are yet known. They should be actual atomic weights as follows: 26.045, 36.46 ± 0.08, 84.61 ± 0.20, 132.71 ± 0.15; (O = 16). They should be in order, the first two members relatively abundant, the others rare. Taken in order, they should be respectively more volatile than oxygen, sulphur, selenium, tellurium. The scope and method of a work on "The theory of algebraical functions and their integrals," by M. Appell and M. Fouard Gourzat, is explained in a short notice by the former.—On the astronomical inscription of Keshik, by M. Paul Lannery. The author draws conclusions from the study of the state of knowledge of planetary periods of the ancients.—On a surface of the sixth order, allied to the surfaces of the third type, by M. G. Humbert.—On the properties of amorphous silicon, by M. Vigoureux. These results are briefly given.—Speaking generally, amorphous silicon is very soluble in reduction with magnesium somewhat resembling the properties of silicon. Though somewhat soluble in water, at high temperatures, it is chemically very inert to the oxidation of the tannin of the cider apples, by M. Lecoq de Robaudin. This oxidation appears to be due to the presence of iron in the "black" type.—On the composition of the seeds of *Medicago sativa*, by M. X. Rucapès.—On the seeds of the *Medicago sativa*, by M. X. Rucapès and A. Hebert. An account of a tree found in the mountains of the Alps, and of a fruit produced from it. On the formation of cyanide, and osmic cyanide formation, by M. Lecoq de Robaudin. Analytical paper giving measurement of axial angles, and optical constants of  $K_2FeCl_4$ ,  $SiHCl_2$ ,  $SiHCl_3$ ,  $H_2O$ ,  $SiK_2PO_4$ ,  $SiH_2O$ . A note on the elementary composition of compounds throughout the extensive series of metal cyanides. On modifications of the blood brought about by the treatment with Bourgeois water from the spring of St. Pierre, by M. Ph. Lecoq de Robaudin. Conclusions from the elementary analyses (quoted): (1) Increase of chloroform and decrease of a notable amount of compounds and substances in the blood of patients due to the treatment. (2) Increase of leucocytes in the treatment produces a diminution of the numbers of white blood cells. (3) On the nucleus and nucleolus in the *Reptilium*, by M. Alphonse Leduc. On the germination of *Pepi-*

*crabro*, L.; conservation of heat in the nest, by M. Charles Janet.—Observations on the upper Tongrian or *Stampsien* strata in the Chalosse, by M. L. Rey.—Considerations on contact-metamorphism, derived from a study of the contact phenomena of lherzolite in the Pyrenees, by M. A. Lacroix.—Mineralogical composition and structure of the *silex* of the Paris gypsum, by M. L. Cayeux. Conclusions: (1) The siliceous nodules from gypsum, known as *silex*, have an essentially different micro-structure and mineralogical composition from *silex* properly so called. (2) They result from a substitution of silica for gypsum. (3) The silicification of gypsum causes the production of some one of the arrangements of which quartz is capable. (4) The ultimate term of the series of transformations of saccharoidal gypsum, under the action of silica, is the production of wholly quartzose plates, having the same structure as quartzites.—Earthquake recorded at Grenoble, a note by M. Kilian, of February 3, 6h. 2m. 40s. morning.

BOOKS, PAMPHLETS, and SERIALS RECEIVED.

Books.—Introduction to Physiological Psychology: Dr. Th. Ziehen, translated, 2nd edition (Sonnenschein).—An Elementary Text-Book of Anatomy: Prof. H. E. Clark (Blackie).—Report of Observations of Injurious Insects, &c., 1894: E. A. Ormerod (Simpkin).—Economic Classics—David Ricardo (Macmillan).—Economic Classics—Adam Smith (Macmillan).—A Course of Elementary Practical Bacteriology: Drs. Kanthack and Drysdale (Macmillan).—The Pathology of Mind: Dr. H. Maudsley (Macmillan).—Notes on a Journey on the Upper Mekong, Siam: H. W. Smyth (Murray).—Das System der Uebergangsl oder des Analytisch-Synthetische Princip der Natur: K. Beyrich (Berlin, Oppenheim).  
Pamphlets.—Revue de l'Aéronautique, 1895. 1<sup>er</sup> Livr.: Le Travail Interieur du Vent: S. P. Langley (Paris, Masson).—Tableau Oeconomique: F. Quésnay (Macmillan).—Philosophical Transactions of the Royal Society of London, Vol. 175 (1895) A, pp. 93-121: Propagation of Magnetisation of Iron as affected by the Electric Currents in the Iron: J. Hopkinson and F. Wilson (Dulan).  
Serials.—Brain, Part 10 (Macmillan).—Royal Natural History, Part II (Warne).—English Illustrated Magazine, March (125 Strand).—London Home Monthly, March (Cox).—Journal of the Royal Microscopical Society, February (Williams and Norgate).—Good Words, March (Isbister).—Sunday Magazine, March (Isbister).—Chambers's Journal, March (Chambers).—Longman's Magazine, March (Longmans).—Le Monde Moderne, February (Paris, Quantin).—Century Magazine, March (Cunwin).

CONTENTS.

PAGE

What does the Chemist mean by "Valency"? By W. A. T. 400  
Caves and Swallow Holes. (Illustrated.) By Canon T. G. Bonney, F.R.S. 410  
Our Book Shelf:—  
Fawcett: "Bulletin of the Botanical Department, Jamaica" 412  
Parnicke: "Die Maschinellen Hilfsmittel der Chemischen Technik."—W. T. 412  
Aikman: "Air, Water, and Disinfectants" 412  
Clark: "An Elementary Text-book of Anatomy" 412  
Letters to the Editor:—  
Liquefaction of Gases.—Prof. James Dewar, F.R.S. 413  
On Certain Questions of the Theory of Gases.—Prof. Ludwig Boltzmann 413  
Oysters and Typhoid.—Mrs Percy Frankland 415  
The Occurrence of very Cold Days. (With Diagram.)—A. B. M. 416  
Hesper and Phosphor.—Kumagusu Minakata 417  
The Recent Storm in the United States.—Dr. Wm. H. Hale 417  
Some Suggestions on the Origin and Evolution of Web-spinning in Spiders. By R. I. Pocock 417  
New Metric Standards 420  
Notes 421  
Our Astronomical Column:—  
Origin of the Lunar Formations 425  
5 Cassiopeia 425  
The Identity of Denning's and Brorsen's Comets 425  
The Antitoxic Serum Treatment of Diphtheria. II. By Dr. G. Sims Woodhead 425  
Dr Dubois' So called Missing Link. By Prof. D. J. Cunningham, F.R.S. (With Diagrams) 428  
University and Educational Intelligence 429  
Scientific Serials 430  
Societies and Academies 430  
Books, Pamphlets, and Serials Received 432

THURSDAY, MARCH 7, 1895.

*THE ANCESTRY OF THE VERTEBRATES.*

*Amphioxus and the Ancestry of the Vertebrates.* By Arthur Willey, B.Sc., Tutor in Biology, Columbia College; Balfour Student of the University of Cambridge. With a preface by Henry Fairfield Osborn. (Columbia University Biological Series, II.) (New York and London: Macmillan and Co., 1894.)

THE observations on *Amphioxus* made before the second half of the present century, amongst which those of Johannes Muller take a foremost place, showed that this remarkable animal bears certain resemblances to Vertebrates; and since then its interest in this respect has gradually become more apparent. The extent to which our knowledge of its structure and development has recently increased, is indicated by the fact that about two-thirds of the papers dealing with *Amphioxus* quoted by Mr. Willey have appeared during the last ten years. With the exception of the admirable account given by the late Prof. Milnes Marshall, last year, in his "Vertebrate Embryology," most of the works relating to this form are of a special nature, and to many not easily accessible. A consecutive history of the more recent observations was, therefore, greatly needed by those whose opportunities did not permit them to follow out the matter for themselves, and who will welcome a book written in an extremely lucid style by a naturalist who can speak with authority on the subject.

After giving an excellent description of the habits, anatomy, and development of *Amphioxus*, Mr. Willey devotes a special section to the Ascidians. Then follows a section on "the Protochordata in their relation to the problem of Vertebrate descent," which includes an account of the so-called "Hemichorda," together with a number of details relating to larval forms, Nemertines, and Vertebrates. On the basis of the facts stated, there is a considerable amount of theoretical matter dealing with the complex question included in the title of the book, in the discussion of which the author is not dogmatic, and makes the distinction between fact and theory clear to the reader. Of the very few inaccuracies we have noticed, mention need only be made of the statements with regard to the cilia on the ectoderm of craniate Vertebrates, on p. 176, and to the distribution of the ganglion-cells in the nerve-cord of Annulata, on p. 263, both of which require modification. The figures, which are 135 in number, are extremely good and clear, not a few of them being taken from the author's original papers; and a good bibliography is given at the end. Altogether we congratulate Prof. Osborn on the publication of the second of the series which is appearing under his editorship.

The problem of the ancestry of the Vertebrates has been approached from many different points of view, and some of the various theories advanced—such as the well-known "Annelid theory" of Semper and Dohrn—have been supported by so many facts and arguments as to gain for them many adherents. Others, again, were less fortunate, and cannot be said to have held the field at all. In all such phylogenetic speculations, as Mr. Willey

points out, mere parallelisms are often difficult to distinguish from true affinities; and even with the increase in our knowledge during the past few years, we are still so much in the dark that it is hardly possible to do more than accept provisionally any particular theory which appears to be supported by the greatest number of facts.

Although *Amphioxus* and the Ascidians have long been recognised as of extreme importance in helping to throw light on the question of Vertebrate ancestry, their many peculiarities are so difficult to explain that by many zoologists they have been attributed to degeneration—more especially in the case of the Ascidians—and on this supposition these animals can be of little use in helping us to any sound view as to the form and structure of the proximate ancestor of the Vertebrates.

The more recent researches on the structure and development of *Amphioxus* have, however, shown that, specialised as this animal undoubtedly is, it can no longer be so easily put on one side, and that it, at any rate, almost certainly represents an extremely archaic form. The general lines of its early development, for the knowledge of which we are mainly indebted to Kowalewsky and Hatschek, are now a matter of every-day knowledge, and are almost universally accepted as the best possible starting-point for the study of Embryology generally. In the present notice we can only refer to some of the more recent discoveries and theories as stated by Mr. Willey.

The curious tongue-bars in the gill-slits, which are only known to be represented elsewhere in *Balanoglossus*, are supposed by Mr. Willey to be the "functionally active organs, of which the thymus of the higher forms is a metamorphosed derivative." This view is supported by reference to Dohrn's account of the development of the thymus in Selachisms. In a note on p. 42, the meta-pleural folds of *Amphioxus* and the evolution of the lateral fin-folds and lateral line of Vertebrates are made the subject of a hypothesis which cannot be done justice to in a few lines. The discovery of the excretory tubules by Boveri and Weiss, is one of the most interesting points which have recently come to light with regard to *Amphioxus*; and Mr. Willey supports Boveri's view that, in spite of their special peculiarities, they represent the pronephric system of Vertebrates, and that the pronephric ducts of the latter are partially homologous with the atrial chamber of *Amphioxus*. This conclusion is especially important as furnishing another argument against the Annelid theory, to which, moreover, the nervous system of *Amphioxus* lends no support, although its peripheral portion "can only be compared definitely, at present, in its broader features, with that of the higher Vertebrates."

The remarkable asymmetry of the larva of *Amphioxus* has probably no ancestral significance, and Mr. Willey concludes that it "is of no specific advantage whatever to the larva, but is merely a stage, which has been preserved in the ontogeny, of a topographical readjustment of parts necessitated by the removal of the mouth from its primitive mid-dorsal position in consequence of the secondary forward extension of the notochord, which has thus caused a virtual semi-rotation of the pharyngeal region of the body. On the other hand, the forward extension of the notochord is a distinct advantage in

later life, since by giving resistancy to the snout, it enables the animal to burrow its way into the sand with such astonishing facility, while the fact that it grows to the front end of the body at a very early stage in the embryonic development, long before it comes to be put to this definite use, must be regarded as an instance of *proterogony* development, of which there are numerous and otherwise inexplicable examples in the field of comparative embryology." The author regards it as probable that the proximate common ancestor of Amphioxus and the higher Vertebrates was characterised by the possession of from nine to fourteen pairs of gill-slits, counting the "club-shaped gland" as representing the antimeres of the first primary slit.

After an account of the structure of the Ascidians, these animals are compared with Amphioxus, and are defined as "more or less *Amphioxus-like* creatures which have become adapted to a sessile habit of existence." Their embryology is then described, and it is pointed out that development proceeds along parallel lines in them and Amphioxus "up to a certain point, and then at the time of the outgrowth of the tail in the embryo of the former, and the hatching of the embryo of the latter, divergences set in." The precocious formation of the larval tail in Ascidians is shown to be one of the chief evidences of the abbreviation which has occurred in the development of this group.

Metamerism—"that fetish of the morphologists," as Brooks calls it—may, as this author points out in his monograph on *Salpa*, "have been acquired by the ancestors of the Vertebrates after the divergence of the Tunicates"; and consequently, even if the supposed metamerism of the tail in Appendicularia had not now been definitely shown by Seeliger and Lefevre to be artificial, it could hardly have been considered of ancestral significance. Mr. Willey recognises the secondary nature of the "so-called metamerism" of the tail in this animal, and is inclined to conclude that "the Appendicularia represent Ascidian larva which have become secondarily adapted to a pelagic life, and have acquired the faculty of attaining sexual maturity." We feel, however, that the arguments brought forward are hardly sufficient to balance those in favour of the view held by Brooks and many others, that Appendicularia is the more primitive type, though until the development of this form is known we cannot, as Mr. Willey points out, decide definitely between these two views.

As already indicated, Bateson's grouping of Balanoglossus, Cephalodiscus, and Rhabdopleura into the division *Hemichordata* of the group *Protochordata*, is accepted by the author, and these forms are described and compared, and an account of the development of Tornaria and of Echinoderm larva given. Although we fully appreciate the general force of the quotation from Weismann, given at the head of Section V., the perusal of the following pages will not, we fear, be convincing to everyone that it applies in this particular instance. Such arguments as those brought forward by Spengel in his great monograph on the Enteropneusta cannot easily be put on one side, and we must make allowance for the principle of parallelism in evolution quite as much in this case as in that of the Annelid theory. Nevertheless, whether the Hemichordata hypothesis proves to be true or

falls to the ground, it will have had its value in stimulating inquiry.

So many other points of theoretical interest naturally appear in considering the problem of Vertebrate ancestry, that one is tempted to discuss each as it arises. We must, however, content ourselves with a bare statement of certain only of these, and the conclusions at which Mr. Willey has arrived with regard to them.

It is concluded "that the ventral mouth of the craniate Vertebrates is the homologue of the dorsal mouth as we find it in the Protochordates, and that its direction of evolution has been, as was so ably maintained by Balfour, from the cyclostomatous to the gnathostomatous condition." The hypophysis is supposed to have arisen "in connection with a functional neuropore; when the neuropore ceased to be functional, there was no longer any bond of union between its inner portion, which opened into the cerebral cavity, and its outer portion, which opened into the buccal cavity; and these two portions became separated by differential growth of the cerebral and body-walls." Much stress—we are inclined to think too much—is laid on the pre-oral lobe, which is supposed to be "represented in the craniate Vertebrates by the *premandibular head-cavities*."

In conclusion, we cannot do better than quote the last paragraph of Mr. Willey's useful and suggestive book, which is dedicated to Prof. Lankester:—

"For the present we may conclude that the proximate ancestor of the Vertebrates was a free-swimming animal intermediate in organisation between an Ascidian tadpole and Amphioxus, possessing the dorsal mouth, hypophysis, and restricted notochord of the former; and the myotomes, colomic epithelium, and straight alimentary canal of the latter. The ultimate or primordial ancestor of the Vertebrates would, on the contrary, be a worm-like animal whose organisation was approximately on a level with that of the bilateral ancestors of the Echinoderms." W. N. P.

#### A CYCLOPEDIA OF NAMES.

*The Cyclopaedia of Names.* Edited by Benjamin E. Smith, A.M. Pp. 1085. (London: Fisher Unwin, 1894.)

THE production of a pronouncing and etymological dictionary of proper names, encyclopaedic in its scope and fulness, must have involved an immense amount of care and industry. The ponderous tome which represents the result of such labour comprises to quote from the Editor's introductory remarks—"not only names in biography and geography, but also names of races and tribes, mythological and legendary persons and places, characters and objects in fiction, stars and constellations, notable buildings and archaeological monuments, works of art, institutions (academies, universities, societies, legislative bodies, orders, clubs, &c.), historical events (wars, battles, treaties, conventions, &c.), sects, parties, noted streets and squares, books, plays, operas, celebrated gems, vessels (warships, yachts, &c.), and horses. Pseudonyms, also, which have literary importance, are included. The only condition of insertion has been that the name should be one about which information would be likely to be sought."



The condition expressed in the last sentence is one that may be regarded as essential, and only by adopting it as a guiding principle can any dictionary or cyclopædia worthy of the name be constructed. It follows from this that the various groups of subjects could not be presented with equal fulness: accordingly we find that persons and places are given a much greater amount of space than any other class. The personal names included in the volume embrace not only actual biography, but also mythology, legend, and fiction. We are chiefly concerned with the names of men of science, and, so far as can be judged from test references, few names of importance have been omitted. But even if a few omissions have been committed, it would be ungracious to condemn the work on that score; rather let us marvel at the number of names that have not been overlooked, and at the care which must have been expended in bringing so much accurate information together. Who but those that have had to investigate biographical details can understand the difficulties which crop up in the matter of dates, due to different styles of reckoning, and the differences between various authorities? It cannot be laid down that in every case the most trustworthy authority has been selected; nevertheless, there is ample evidence in the volume to show that judicious discrimination has been used.

The geographical names given include every town, place, or locality likely to be looked for by the average man; physical and political divisions of the earth; rivers, lakes, seas, &c.; and natural curiosities. In the spelling of place-names, the established usage in the language from which the name is taken has generally been accepted. In many cases, however, where the established English usage differs more or less from the native form, no general considerations can be applied. Instances of this are: Munich for the German München, Flushing for the Dutch Vlissingen, Hanover for the German Hannover. Having regard to the fact that there is a tendency to return to the native form of spelling place-names, where the difference between this form and the Anglicised orthography is slight (as in Hannover), the former has usually been taken. This seems to be a common-sense rule to follow, and it enforces the opinion of many geographers that the correct spelling of a place-name is the local one.

The general plan of the dictionary will be understood from the foregoing brief description. It only remains to be said that, as a collection of proper names, the work is the most complete one-volume cyclopædia that has ever come under our notice. No scientific society should be without the volume, and every reference library ought to have a copy on its shelves.

#### OUR BOOK SHELF.

*Varied Occupations in Weaving.* By Louisa Walker. Pp. 224. (London: Macmillan and Co., 1895.)

THERE is a scientific and an artistic side to the kindergarten system of education. Froebel's graduated sets of simple apparatus, known as "gifts," are most valuable in training a child to observe and think. The first of the gifts, consisting of six wool balls, coloured respectively violet, blue, green, yellow, orange, and red,

serve to teach elementary colours; the second, consisting of a wooden cube, a sphere, and a cylinder, is used to familiarise children with geometrical forms, and with the figures presented when the objects are rotated around different axes. A number of other gifts follow these, each calculated to develop the minds of the infants for whom they are intended. So much cannot be said, however, for all the "varied occupations" which are carried on in many elementary schools. The educational value of an occupation such as that described in the book before us, lies not in the development of the mind, but in the training of the hand and eye. If the elements of kindergarten knowledge have been previously acquired by the young students, there is no harm in teaching how to weave paper mats, and to do macramé work, though our opinion is that the child might be better employed in object-lessons, which naturally follow a scientifically arranged kindergarten course. For this playing at making things is often carried too far, and leads to technical instruction being given before instruction in the broad principles inculcated by means of Froebel's early gifts. Possibly we do not fully appreciate the value of hand and eye training for children. The greatest benefit to be derived from such training seems to be the cultivation of the imitative and inventive faculties. Addition and multiplication can be taught by the weaving occupations described by Mrs. Walker, but they can be taught just as well by means of Froebel's gifts. However, the book is the outcome of twenty years' experience in kindergarten methods of teaching, and therefore should be of great service to teachers of children, even though its value, when viewed from a scientific point of view, is but little.

*Horse Breeding for Farmers.* By Alfred E. Pease. (London: Macmillan and Co., 1894.)

THE aim and object of this little work is to impress upon the impecunious present-day farmer the pecuniary profit which is to be derived from horse-breeding; and if the balance-sheets which Mr. Pease produces are to be relied upon, it undoubtedly constitutes a profitable pursuit. Unfortunately, however, so much depends upon the judgment, care, and skill bestowed by the individual in the purchase of suitable mares, the selection of proper sires, as well as upon the business capacity of the breeder, when the time arrives for placing the produce upon the market, that a profit on paper may readily be converted into a loss in practice. More particularly is this so in the case of the lighter breeds, such as the hunter and high-class carriage horse, whose value is largely dependent upon the thoroughness with which they have been trained and schooled. Mainly for these reasons we believe that the average farmer will be best advised to confine his horse-breeding operations to the heavier or agricultural breeds. They possess the additional advantage of being more docile, less trouble to break in, more useful to the farmer whilst young, and, finally, are more readily disposed of. The other breeds are best left to the landowners and so-called gentleman-farmer. Holding these views, we regret Mr. Pease should devote twenty pages to tracing the origin and history of the English thoroughbred, the Arab, the Barb, and other Oriental breeds.

For the rest, the book is replete with valuable information on the subject it professes to deal with, and may be cordially and unreservedly recommended to those who are inclined to try their luck in horse-breeding. To our minds, the final chapter, which treats of the ailments which horseflesh is heir to, is the least satisfactory. This is hardly to be wondered at, when we bear in mind how wide a subject is veterinary science, and how small a space Mr. Pease has devoted to its consideration.

W. F. G.

*Preparation of Solids.* By William J. Hopkins. London: Longmans, Green, and Co., 1894.)

THE course here presented is the outgrowth of needs of the classes beginning the study of physics in the Drexel Institute, Philadelphia. It is arranged strictly for laboratory work, and although the ground covered is not very extensive, yet sufficient has been selected for a first course, and that expounded to a very full extent. Mechanics has been chiefly taken in hand, and the numerous problems have been so arranged that the student is able to investigate them experimentally for himself. A glance at the instructions and explanations shows one that the author wishes at every step to instil into the beginner the idea that habits of accurate and thorough observation must be developed, and, further, that students must be careful, complete, and orderly in recording and arranging his results. With this intention most of the experiments are accompanied with printed forms illustrating concise methods of recording the observations. The apparatus alluded to in the text is of a simple nature, and quite sufficient for those beginning the subject. As an introduction, a few pages are devoted to such fundamental points as units, errors and sources of error, coordinates, plotting of curves, &c. Altogether, the book will be found a serviceable and able help to all wishing to take part in the more simple laboratory work.

*The Story of the Stars.* By George F. Chambers, F.R.A.S. Pp. 192. (London: George Newnes, Limited, 1895.)

ONE or both of two qualifications are essential in a book designed for general readers: the text must be attractively written, or the illustrations must please the eye. This book has neither of these claims to public favour: the text is stodgy and the illustrations are the very worst that we have seen disfiguring a volume on astronomy. The former defect is due to the author's attempt to say something about the whole of sidereal astronomy in less than two hundred small pages; the wretched illustrations cannot be due to his inability to find others, so this fault must lie at the publisher's door. And yet we cannot understand why the publisher of the *Strand Magazine* and other pictorial papers could not give the same care to the illustration of a book on astronomy as he does to the description of the home of some celebrity. Only in regard to quantity of information are we able to say a favourable word for this book. Mr. Chambers is thoroughly competent to collect the facts belonging to the old astronomy, and to condense them. He may be able to compress a mass of knowledge into a small compass, but his latest production shows that he is not the touch *simplex munditijs* of a writer for the popular mind.

*Aerial Navigation. Proceedings of the International Conference held at Chicago, August 1893.* Pp. 429. (New York: American Engineering Office. London: Sampson Low, Marston, & Co., 1894.)

AN International Conference on aerial navigation formed one of the series of Congresses which were held in Chicago during the summer of 1893. The meetings proved to be successful, and the volume in which the proceedings are recorded shows that facts and positive knowledge, rather than speculations or descriptions of things "in the air," were the order of the day. Some thirty-five papers were presented, each containing an account of observations and results of experiments carried out by scientific men or experienced engineers. These papers and the discussions upon them are now published in a volume uniform with Mr. Chanute's treatise on "Flying Machines," previously noticed in NATURE, vol. I. p. 599, 1894. Both show that many of the problems of aeronautics and aviation are being treated scientifically. The present volume is of special interest to meteorologists, for it contains several papers on the exploration of the upper atmosphere.

LETTERS TO THE EDITOR.

[The Editor does not hold himself responsible for opinions expressed by his correspondents. Neither can he undertake to return, or to correspond with the writers of, rejected manuscripts intended for this or any other part of NATURE. No notice is taken of anonymous communications.]

The Liquefaction of Gases.

I DECLINE to follow Prof. Dewar into the fresh crop of irrelevant side issues raised by his letter in NATURE of February 28. The charge brought against Prof. Dewar, which I think I have amply substantiated, is that he has allowed the impression to go abroad that he has carried out much original research in the methods of liquefying the more permanent gases, and the properties of the liquids produced; whereas his experiments have been mainly repetitions of work done by others.

Prof. Dewar has not met this accusation. He has not proved that his methods for liquefying the more permanent gases are original methods, he has not even shown that for scientific purposes they are good methods; he has not proved that his experiments on the liquefied gases are either original or valuable; he has not attempted to rebut the actual facts, or to deal with the actual dates, brought forward by Prof. Olszewski and myself.

In his last letter Prof. Dewar gives a list of work "commenced and so far developed in the laboratory of the Royal Institution." The list might, however, have been made a little less grotesque by the omission of such things as "argon in liquid air," and the "liquefaction of hydrogen," and the substitution in place of these of a double &c.

When Prof. Dewar quits the region of romance, and tries to meet the definite statements I have made, and the evidence afforded by the dates I have quoted, I shall be ready to deal with his arguments to the best of my ability.

Cambridge, March 2.

M. M. PATTISON MUIR.

Eleven-year Sun-spot Weather Period and its Multiples.

MANY years ago, investigations in regard to the existence of a period of about eleven years in the weather corresponding with the eleven-year sun-spot period were actively carried out in various parts of the world. Much data was accumulated in support of such a period, a large part of which was published in the earlier volumes of NATURE. But the investigations, as a whole, showed that the period was less marked or more complex than at first anticipated, so that recently less interest has been manifested in the subject, and indeed many express their doubts as to the existence of such a period.

One of the complexities which has helped to obscure the eleven-year period is the existence of what may perhaps be called weather harmonics, on account of the resemblance to harmonics in sound—that is, the existence of other periods related to the length of the first as 2, 3, 4, &c. Thus the existence of the eleven-year period is obscured by the existence of other periods of 22, 33, 44, &c., years.

If the reader will turn to the letter "On Some Temperature Variations in France and Greenland," in NATURE of October 11, 1894, he will find plotted the smoothed number of frost days and mean July temperatures at Paris for a large part of the present century. These curves show three marked waves in the temperature with the crests about 1825, 1848, and 1869, that is, almost exactly 22 years apart. If the dates of the chief maxima and minima of the individual curves are arranged under dates 22 years apart, as shown below, it will be seen that the dates closely approximate, thus:—

Mean dates of					
maxima	...	1825	...	1847	... 1869
Frost days, Paris—					
minima	...	1824	...	1848	... 1868
July temp. Paris—					
maxima	...	1826	31	...	1848 ... 1870 ... 1885
Mean dates of					
minima	...	1815	...	1837	... 1859
Frost day, Paris—					
maxima	...	1814	...	1839	... 1856
July temp. Paris—					
minima	...	1815	...	1842	... 1862

If only the two highest maxima are considered, they occurred about 1826 and 1870, or 44 years apart; but if all the secondary

and chief maxima are considered, there are indications of an 11-year period, thus:—

Mean dates of minima—  
 1814 ... 1825 ... 1836 ... 1847 ... 1858 ... 1869 ... 1880 ... 1891  
 Frost days, Paris—maxima—  
 1814 ... 1830 ... 1839 ... — ... 1856 — ... 1878 ... 1889  
 July temp. Paris, minima—  
 1815 ... 1830 ... 1842 ... — ... 1862 ... — ... 1881 ... 1890

In the *Annals* of the Astronomical Observatory of Harvard College, vol. xxxi. part 1, p. 103, is given the average temperature for each five years, observed at a large number of stations in New England. The three stations having the longest records, namely, New Haven, Connecticut, Cambridge, Massachusetts, and New Bedford, Massachusetts, are given below:—

Year.	1781-85	1786-90	1791-95	1796-00	1801-05	1806-10	1811-15	1816-20	1821-25	1826-30	1831-35
Cambridge		50.4	48.0	49.4	47.4						
New Bedford ...							48.1	49.5	49.6	47.2	
New Haven	47.0	49.5	47.8	50.0	51.2	49.3	47.1	46.7	47.2	49.8	48.1

Year.	1836-40	1841-45	1846-50	1851-55	1856-60	1861-65	1866-70	1871-75	1876-80	1881-85	1886-90
Cambridge	45.6	47.7	47.4	47.1	48.1	47.1	46.4	48.5	49.5	49.0	
New Bedford ...	47.0	47.8	48.8	48.6	47.9	49.9	48.3	47.1	49.1	48.1	47.9
New Haven	47.5	49.4	47.1	48.6	48.0	50.6		51.7	48.4	48.6	

These records show that maxima occurred in New England about 1803, 1828, 1848, 1863, 1876, and 1889, and minima about 1818, 1838, 1858, and 1873. If these are arranged according to intervals of 22 years, as before, the following results are obtained:—

Mean dates of  
 maxima ... .. 1803 ... 1825 ... 1847 ... 1869 ... 1891  
 Observed max. temp.  
 New England ... 1803 ... 1828 ... 1848 ... 1863 ... 1889  
 Minima ... .. 1814 ... 1836 ... 1858 ... 1880  
 Observed ... .. 1818 ... 1838 ... 1858 ... 1873

It will be seen that the dates of maximum and minimum temperature correspond almost exactly with those observed in Paris, showing how general were the forces acting to produce them

That there exists all over the world a tendency to a period of

about 33 years, is so well worked out by Brückner, that it is only necessary to refer the reader to his treatise on "Klimaschwankungen seit 1700," to find exhaustive data on this subject.

This harmonic tendency of multiplication in weather periods has been extensively worked out by the writer in shorter periods, and the evidence of its existence appears conclusive, based in that case on a very large mass of data. It is desired to call attention to it here, that those making future inquiries concerning sun-spot periodicity and the weather may bear the possibility of this phenomenon in mind.  
 H. HELM CLAYTON.

Blue Hill Meteorological Observatory, Readville, Mass.

Abnormal Atlantic Waves.

In 1887 (*NATURE*, vol. xxxvii. p. 151) you kindly published a few remarks from me on the possible volcanic origin of the two waves which swept the decks of the steamers *Umbria* and *Faraday*, and which, from the data then available, seemed to have originated at a point in the Atlantic known as the "Faraday Reef," and marked with a cross (+) on the accompanying chart. I am now able to send you the details of a few similar cases which I have collected since then. The exact positions of the vessels, and the directions from which these solitary waves seemed to come, being also marked on the chart. In the case of H. M. S. *Orontes* the ship's course was not stated, and on account of darkness and other causes the directions from which some of the other waves came are not to be depended upon. None of these encounters would have been reported had they not caused much damage—masts and funnels going by the board, and bul'arks, deck-houses, and lifeboats being smashed; but many seafaring men can recall solitary and abnormally high waves having struck their vessels, although the sea was otherwise quiet. Amongst the strange results which these flows have produced, may be mentioned that the magnetism of the steamship *Energia* was thus suddenly altered sufficiently to introduce an error of 18° into the compass readings. The full details about this and a few other vessels have not been obtained.

North Atlantic.

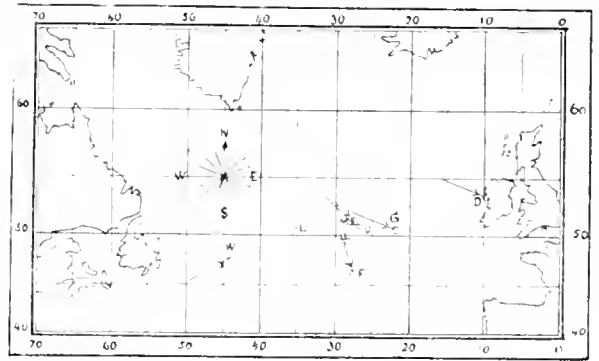

Initial	Ship's name.	Local time	Date	Latitude.		Longitude.	Speed.	Ship's course	Wave's course.
				North.	West.				
F	<i>Faraday</i> ... ..	6.45 a.m.	14 2 84	40	11	27 53	6	N. 72° E.	Port beam.
W	<i>Westernland</i> ...	2.45 a.m.	27 11 86	47	59	43 57	7	S. 60° W.	Bow.
G	<i>Germanic</i> ... ..	9.40 a.m.	5 5 87	50	36	22 8	4	N. 68° W.	Bow.
U	<i>Umbria</i> ... ..	4.40 a.m.	26 7 87	50	50	27 8	16	S. nearly W.	3 points on starboard bow.
	H. M. S. <i>Orontes</i> ...	5 p.m.	18 2 91	36	12	32 50	9	?	Bow.
L	<i>Festina Lente</i> ...	noon.	16 11 94	50	12	35 23	?	S. E. by S.	?
M	<i>Manhattan</i> ... ..	2 a.m.	17 11 94	51	26	27 31	?	S. 86° W.	N. W.
D	<i>Diamond</i> ... ..	10 p.m.	21 11 91	53	9	9 52	Lying to	W. N. W.	W. N. W.

The following are short summaries of each case :

*S. Faraday*.—The wave was visible like a line of high land on the horizon about five minutes before it struck the vessel.

*S. W. Diamond*.—A huge wave rose to a great height just in a lance of the ship. No other similar waves were met with. About noon the wind had changed from S.W. to W.N.W.

*S. S. Diamond*.—Wind W.N.W. with terrific squalls. Shipped tremendous sea over bow.

*S. S. Onyx*.—The disturbance came from N.W. and consisted of two waves. The first one was broken, the second one green. The wind had previously changed from S.W. to N.W.

*H.M.S. Orontes*.—While steaming in smooth water a huge wave broke over the vessel forward.

*S. Helena Lente*.—A steep sea fell on board from both sides.

*S. S. Manhattan*. The sea was high, but fairly true until a mountainous wave broke on board from N.W.

*S. S. Diamond*.—Lying to, awaiting daylight to enter port. The wave was heard some time before it was seen, and then seemed to be about 30 feet high. The vessel never rose to it, but was literally submerged for a time.

An examination of the chart will show that with the exception of the *Westerland* each wave may have originated at a common centre, and might therefore be due to subaqueous volcanic activity. However, as the solitary waves which strike the west coast of South America and the so-called Death Waves on the west coast of Ireland are said to be regarded as precursors of storms, it is possible that these solitary Atlantic waves may be due to a similar cause; but even then it is inexplicable how a number of comparatively small and regular waves can be converted into one abnormal one, or how the reported changes of wind and consequent confused sea could produce such a wave. It will be noticed that the dates for the *Helena Lente*, *Manhattan*, and *Diamond* are very close together, and therefore there is a possibility that they were struck by the same wave. C. E. STROMMEYER.

Glasgow, February 18.

### The Presence of a Stridulating Organ in a Spider.

WHILE spending a short time at Alice Springs, in Central Australia, during the course of last year, in connection with the Horn Scientific Expedition, I found that it was firmly believed by a considerable number of people, white men and natives alike, that a spider existed in Central Australia which made a booming noise at night. Thanks to the assistance of the blacks, the spider itself was easily captured, but I could detect no organ capable of producing a booming sound. The animal forms a tubular burrow, about three-quarters of, or an inch, in diameter, which passes down for some eighteen to twenty four inches in a slightly slanting direction until it terminates in a small chamber capable of holding the animal comfortably. In this chamber are found fragments of beetles upon which the animal has preyed, and a certain amount of web material; but there is no regular lining to the tube or chamber. The spider, which may reach a length of two and a half inches, and a span across the legs of five inches, proves to be *Phidippus*, belonging to the tribe *Trochilini*, to which also belongs the well known *Mysid*.

After listening carefully for the noise, and spending with a friend a night out in the open, in a spot where the booming could be heard, we came to the conclusion that the noise attributed to the spider was, in reality, made by a quail.

However, we kept one dozen specimens under observation in tin and wooden boxes, and after a few days in captivity, during which time they were very sluggish, one or two of them began to be more active, and on irritating one of the livelier ones (a large female) with a straw, I was pleased to see her rise on her hinder legs, and to hear her make a low whistling noise, moving alternately the palps up and down on the chelicera, as she did so. Whilst doing this she would make short angry darts at the straw.

On examination it was seen that the surface of the basal part of the palps was provided with a somewhat oval-shaped comb-like structure composed of hard chitinous teeth of various lengths, each ending in a club-shaped head. The comb is so placed that when the palps move up and down it rubs against a special part of the chelicera, which is provided with several rows of strong, sharply tapering spines, and the sound produced

can be heard, when the spider is in a box in a quiet room, at a distance of, at any rate, six or eight feet.

I was not at the time aware of the fact that, in the *Transactions* of the Entomological Society for 1877, Mr. Wood Mason had described a very similar stridulating organ in another ground-spider, *Mysid stridulan*, and it is interesting to note the close resemblance between, as well as the presence of, the organs in these two genera, both of which belong to the tribe *Territelariæ*. The figure given by Mr. Wood Mason admirably illustrates the position of the spider when it stridulates.

I hope to publish a full description of the organ in the volume dealing with the work of the Horn Expedition.

BALDWIN SPENCER.

Biological Laboratory, Melbourne University,  
January 24.

### The Spectrum Top.

PERHAPS some of your readers may be glad to learn that the curious phenomena of the spectrum top can be shown on a screen to a large audience. It is only necessary to paint the usual black lines and sector on a suitable disc of glass, and then to mount it in a revolving stage which can be rotated in a lantern by means of a multiplying wheel. The projected disc of light must not be too large; if the lime-light be used the disc may be about 2 feet in diameter, and about double that size with the electric arc. A great variety of effects can be obtained by interposing coloured glasses in the path of the beam; e.g. with a green glass, and in diffused gas-light, the dark sector and lines appear to be mauve-coloured when suddenly stopped after rapid rotation, or when very slowly rotated, but become of a dark blue when the gas is turned off. On rotating the disc in the usual way the lines appear to be blue, green, and violet.

With a blue glass in gas-light the dark sector and lines appear to be yellow when suddenly stopped, but a fine purple without diffused light. The colours given by the lines at a moderate rate of rotation are red, grey, green, and blue. With a monochromatic red glass, the lines appear to be blue, grey, red, and dark red.

Is it not somewhat extraordinary that a rich blue colour can be obtained when dealing only with monochromatic red light? With whatever coloured light the disc is fed, the characteristic red lines at the centre, and blue at the periphery, or *vice versa*, seem almost invariably to appear. Altogether the phenomenon is worthy of further study by physiologists and physicists; the lantern appears to throw, in a double sense, new light upon this interesting problem. The idea of employing transmitted instead of reflected light for producing the phenomena of the spectrum top is partly the suggestion of Mr. T. J. Walls, instrument maker, Edinburgh, who constructed the disc for me.

DAWSON TURNER.

Edinburgh, March 4.

### THE AGE OF THE EARTH.

PROF. PERRY and I had not to wait long after the publication of his article "On the Age of the Earth" (*NATURE*, January 3, 1895, pp. 224-227) to learn that there was no ground for the assumption of greater conductivity of rock at higher temperatures, on which his effort to find that the consolidation of the earth took place far earlier than 400 million years ago, is chiefly founded. In a letter of date January 13, most courteously written to me by Dr. Robert Weber in consequence of his having seen by my letter to Prof. Perry of December 13, that we were anxious to find how far his experimental results regarding differences of thermal conductivity and specific heat at different temperatures could be accepted as trustworthy, he tells me that he had made further experiments on an improved plan, and that on the whole his investigations do not seem to prove augmentation of conductivity with temperature; and he kindly gives me, with permission to communicate to *NATURE*, the following results, hitherto unpublished, of experiments which he made in the years 1885 and 1886

on the thermal conductivities ( $k$ ) and specific heats ( $c$ ) of five rocks.

	Density		
Basalt	3'0144	$c = 0'1703 + 0'000295t$ [between 0° and 60°] $c = 0'1046 + 0'000575t$ [between 60° and 110°] $k = 0'0031771 + 0'000001t$	
Marble	2'7036	$c = 0'20270 + 0'000460t$ $k = 0'0054011 - 0'000005t$	
Rock salt	2'161	$c = 0'2146 - 0'00017t$ $k = 0'01371 - 0'0044t$	
Anhydrite of Jura	2'892	$c = 0'1802 + 0'0003t$ $k = 0'01231 - 0'0024t$	
Quartz	2'638	$c = 0'1754 + 0'0004t$ $k = 0'015761 - 0'0019t$	

These results show practically no change of thermal conductivity with temperature for Basalt and Marble. For Rock Salt, Anhydrite of Jura, and Quartz, they show diminutions of thermal conductivity amounting per 100° C. to 44 per cent., 24 per cent., and 19 per cent. respectively. They contrast curiously with the 75 per cent. augmentation of thermal conductivity per 100° C. (NATURE, January 3, p. 226), used by Prof. Perry in his estimate of the age of the earth, and they form a practical comment on his statement (NATURE, January 3, p. 226): "From the analogies with electric conduction, one would say, without any experimenting, that as a metal diminishes in conductivity with increase of temperature, so a salt, a mixture of salts, a rock, may be expected to increase in conductivity with increase of temperature."

Since the beginning of January I have myself been endeavouring to find by experiment the proportionate differences of thermal conductivity of rocks at different temperatures; and before the end of January I had made some preliminary experiments on slate and sandstone, from which I was able to tell Prof. Perry that the thermal conductivity of each of these two rocks is probably less at higher temperatures than at lower. Since that time I have been arranging for experiments on granite, in which as rapid progress as I would have liked has been impossible for many reasons, including the necessity of standardising a Kew certificated thermometer of 1886, now for the first time being compared with an air thermometer in my laboratory. Unless its differences from the air thermometer are much larger than can be expected from what we know of the behaviour of mercury-in-glass thermometers generally, it is already almost proved that the thermal conductivity of granite is less between 150° C. and 250° than between 50° and 150°.

As to specific heats there can be little doubt but that they increase with temperature up to the melting point of rock, but the rate of augmentation assumed by Prof. Perry is about five times as much as that determined up to 1200 by the experiments of Rücker and Roberts-Austen (*Phil. Mag.*, 1891, second half-year, p. 353; for Basalt, and of Carl Barus (*Phil. Mag.*, 1893, first half-year, pp. 301-303) for Diabase; these being apparently the only experiments hitherto made on specific heats of rock at temperatures beyond the range of the mercury-in-glass thermometer.

Taking the primitive temperature as 4000° C. and the thermal conductivity and the specific heat at this temperature respectively 30 times and 14½ times their values at the surface, and throwing in a factor 3 for three-fold density at the greater depths though the average density of the whole earth is scarcely double that of the upper crust) Perry takes the product of three factors  $30 \times 14\frac{1}{2} \times 3$  and so finds in round numbers 1300 times my estimate as his corrected estimate of the age of the earth!! (NATURE, January 3, p. 227.)

But even if the ratios of thermal conductivities and of

specific heats at the higher and lower temperatures were as assumed, Prof. Perry's product of the two corresponding factors vastly over-estimates the age. Of this I thought I had given a sufficient warning when I wrote to him (December 13, "But your solution on the supposition of an upper stratum of constant thickness, having smaller conductivity and smaller thermal capacity than the strata below it, is very far from being applicable to the true case in which the qualities depend on the temperature." (NATURE, January 3, p. 227.) It is obvious that the supposed higher thermal conductivity and the higher specific heat, if beginning suddenly at a short distance below the surface, and continuing constant to the great depth, would greatly prolong the time of cooling to the same surface-gradient, beyond what it would be with these qualities increasing continuously with temperature. For the simple case of conductivity assumed to increase in the same proportion as specific heat, Prof. Perry has himself since given in a later communication (NATURE, February 7, pp. 341-342) the necessary correction of his previous mathematics: and in an example of his own choosing (50 per cent. augmentation of each quality per 100° elevation of temperature), he now finds 121 times my estimate for the age of the earth, instead of 441 times as by the formula which he used in his first article.

When the ratio of thermal conductivity to specific heat per unit bulk varies with the temperature, the problem of secular cooling presents mathematical difficulties which, so far as I know, have not been hitherto attacked; but I find it quite amenable to analytical treatment, and I hope before long to be able to offer a paper to the Royal Society of Edinburgh on the subject, as an appendix to my original paper "On the Secular Cooling of the Earth," published in its *Transactions* 1862. I have already worked out numerically two cases, in one of which both conductivity and specific heat increase with temperature, and in the other the specific heat increases with the temperature but the conductivity is constant. The first of these is at present only interesting as a mathematical exercise because, according to present knowledge, it is more probable that the thermal conductivity decreases than increases with increasing temperature. To the results of the second I shall refer later as substantially helping us towards a revised estimate of the time which has elapsed since the consolidation of the earth.

Twelve years ago, in a laboratory established by Mr. Clarence King in connection with the United States Geological Survey, a very important series of experimental researches on the physical properties of rocks at high temperatures was commenced by Dr. Carl Barus for the purpose of supplying trustworthy data for geological theory. Mr. Clarence King, in an article "On the Age of the Earth" published in the *American Journal of Science* (vol. xlv., Jan. 1893, used data thus supplied, to estimate the age of the earth more definitely than was possible for me in 1862 with the very meagre information then available as to specific heats, thermal conductivities, and temperatures of fusion. I had taken 7000° F. (3871° C.) as a high estimate of the temperature of melting rock. Even then I might have taken something between 1000° C. and 2000° C. as more probable, but I was most anxious not to under-estimate the age of the earth, and so I founded my primary calculation on the 7000° F. for the temperature of melting rock. Now we know from the work of Carl Barus (*Phil. Mag.*, 1893, first half-year, pp. 186, 187, 301-305) that Diabase, a typical Basalt of very primitive character, melts between 1100° C. and 1170° and is thoroughly liquid at 1200°. The correction from 3871° C. to 1200° or 1/3.22 of that value, for the temperature of solidification, would, with no other change of assumptions, reduce my estimate of 100 million to 1 (3.22)<sup>2</sup> of its amount or a little less than ten million

years; but the effect of pressure on the temperature of solidification must also be taken into account, and Mr. Clarence King, after a careful scrutiny of all the data given to him for this purpose by Dr. Barus, concludes that without farther experimental data "we have no warrant for extending the earth's age beyond 24 millions of years."

By the solution of the conductivity problem to which I have referred above, with specific heat increasing up to the melting point, as found by Rucker and Roberts-Austen and by Barus, but with the conductivity assumed constant, and by taking into account the augmentation of melting temperature with pressure in a somewhat more complete manner than that adopted by Mr. Clarence King, I am not led to differ much from his estimate of 24 million years. But, until we know something more than we know at present as to the probable diminution, or still conceivably possible augmentation, of thermal conductivity with increasing temperature, it would be quite uninteresting to publish any closer estimate.

In the latter part of Mr. Clarence King's paper on the "Age of the Earth" the estimates of the age of the sun's heat by Helmholtz, Newcomb, and myself, are carefully considered, and the following sentences with which the paper is brought to a conclusion will, I am sure, be interesting to readers of NATURE:—"From this point of view the conclusions of the earlier part of this paper become of interest. The earth's age, about twenty-four millions of years, accords with the fifteen or twenty millions found for the sun.

"In so far as future investigation shall prove a secular augmentation of the sun's emission from early to present time in conformity with Lane's law, his age may be lengthened, and further study of terrestrial conductivity will probably extend that of the earth.

"Yet the concordance of results between the ages of sun and earth, certainly strengthens the physical case and throws the burden of proof upon those who hold to the vaguely vast age, derived from sedimentary geology." KEELIN.

#### NOTES.

IN addition to Lord Aberdare, the Royal Society has to mourn the loss of two more of its Fellows. Sir Henry Rawlinson, the distinguished Orientalist, died on Tuesday, in his eighty-fifth year. He was elected into the Society so long ago as 1850. Sir William Savory, who died on Monday, at the age of sixty-nine, was admitted eight years later.

WE have also to announce the death of Dr. D. H. Tuke, well known for his works on psychological medicine.

IT is announced in the *British Medical Journal* that Dr. Arnold Kutter has tendered his resignation of the post of Director of the British Institution of Preventive Medicine.

WHEN the news of Prof. Cayley's death reached America, American mathematicians were not slow in expressing sympathy with their English brethren. We are informed that—"In that great American University, the Johns Hopkins, in which, not many years ago, Prof. Sylvester and Prof. Cayley, at the same time, gave instruction in advanced mathematics, the death of Prof. Cayley was the occasion of universal mourning, and all was appropriately draped with black."

IT appears from a correspondence between the Board of Trade and the Electric Lighting Committee of the St. Pancras Vestry, that Major Carlew, the electrical adviser of the department, has discovered, during his investigations into the recent explosions in the street boxes used for electrical supply in St. Pancras, that a remarkable

deposit on some of the insulators contained a considerable quantity of the metal sodium. The presence of this metal appears to be so grave a source of danger, and to afford so reasonable an explanation, in connection with the accumulation of escaped coal gas, of the several explosions which have recently occurred, that the Board of Trade intends to investigate the causes of the deposit of this substance with a view to its prevention, and in this investigation they have asked for the assistance of the Royal Society and of the Institution of Electrical Engineers.

PROF. CHARLES STEWART will deliver a course of six lectures on "The Internal Framework of Plants and Animals," at the Royal College of Surgeons, Lincoln's Inn Fields, on March 11, 13, 15, 18, 20, and 22, at five o'clock. Admission to the lectures can be obtained on presentation of visiting card.

A CORRESPONDENT, writing from Brooklyn on February 16, says:—"The severity of the weather and depth of snowfall throughout the southern United States for the past few days are unparalleled. On the 14th inst. the temperature at Abilene, Texas, was 15°, and in the State of Georgia it ranged about 9° lower than in New York city. Yesterday there was snow five inches deep in Atlanta, four inches at Darien, three inches at Thomasville, and two inches at Savannah, all in Georgia; two feet at Birmingham, Alabama; eight inches at New Orleans, Louisiana; six inches at Galveston, Texas, with snow falling as far south as Corpus Christi. In many places there had never before been snow enough to cover the ground to any measurable depth.

FROST prevailed during the greater part of the past week in nearly all parts of the United Kingdom, and in the northern and midland districts the thermometer in the screen has on several nights fallen as much as 10° below the freezing point. Snow has fallen over the greater part of the country, and in Scotland the amount has been heavy. The type of weather has been chiefly anti-cyclonic, and an area of low barometer readings was for several days situated to the eastward of our islands, so that strong and cold northerly winds were experienced over the entire country. A correspondent at Dundee states that the temperature in that district during the last two months was unusually low. The average maximum temperature of January and February was 36°·6, and the average minimum, 24°·9, so that the average mean temperature for that vicinity was about 30°·7. The normal values published by the Meteorological Council for Leith, a little more to the south, give 39°·5 as the average mean temperature for the two months.

PROF. M. MULLER contributed an article to the January number of *Globus* (Brunswick) on meteorology and the figure of the earth, which contains much useful information upon the subject of atmospheric circulation, and the results of the author's own investigations. He points out very clearly the effects of the earth's rotation and of the polar compression on the motion of the air, and strongly opposes the theory of equatorial and polar currents as propounded by Dove and his adherents. He explains the enormous forces that would be required to transpose a kilogram of air from the pole to the equator, and shows that the motion of a particle closely resembles that of a ball which is kept in circular motion on a revolving plate by a juggler, the rapid rotation of the plate, and of the earth, acting similarly on both ball and air, and keeping both moving in comparatively small and nearly closed curves.

DR. A. CASCANI notes the existence of two systems of undulations in the Constantinople earthquake of July 10, 1894, one propagated with a velocity of 4.9 km. per second, the other with a velocity of 2.3 km. per second (*Rend. dell' Acc. dei*

Linzi, December 16, 1894). The latter estimate is obtained from the times furnished by magnetic or astronomical observations, possessing instruments capable of recording long period oscillations only. The instruments of the Italian seismic observatories, on the other hand, registered the rapid movements travelling with the greater velocity, as well as the longer oscillations, whose velocity is again found to be 2.3 km. per second. Dr. Cancani remarks that these results agree with the theory explained by him in a former paper (*Ann. dell' Uff. Centr. di Met. e Geod.*, vol. xv. 1893).

NEWS has recently been received regarding the three attempts made last year to extend our knowledge of the higher mountains of Africa. The most important of these was Mr. Scott Elliot's expedition to Ruwenzori, some of the preliminary results of which he announced in a recent letter to NATURE. Mr. Scott Elliot seems to have found the higher slopes of the mountain extremely trying to the native porters. Botanical results of the highest interest may be expected from the work of such an experienced African botanist. As Mr. Scott Elliot did not succeed in reaching the highest zone in the mountain, his description of its geology may be incomplete. He has, however, announced one conclusion of the highest importance, viz. the discovery of traces of the existence of glaciers, seven miles below the existing snow-line. It will be remembered that in a recent paper published by the Geological Society, Dr. J. W. Gregory fully described similar glacial extension on Mount Kenya. The difficulty, however, has been felt that the same fact has not been recorded from Kilima Njaro, in spite of the numerous visits to that mountain. The glaciers there now seem to be at their greatest extension. It is probable that this is due to the fact that the peak with the existing glaciers is of very recent date. The absence of moraines from the older peak appeared perplexing. Mr. Scott Elliot's discovery, however, shows that the greater glaciation of Kenya was not due to a purely local cause, but to some change that affected the whole region.

WE have received a copy of the *British Central Africa Gazette* (vol. i. No. 15), describing Capt. Manning's recent ascent of Mount Mlanje, on October 22-25. The mountain is now well known from the botanical collections made there by Mr. Whyte, under the direction of Mr. H. H. Johnston. Previous attempts to ascend it had, however, failed through lack of time. Capt. Manning's party do not appear to have found the climbing very difficult. The summit is estimated at 9680 feet; but we are not told by what method this was determined. Apparently it was only by aneroid. The party were helped up by a new method of roping, which ought to recommend itself to the Chamounix and Zermatt guides. They used a long loop of calico, which they called a "machila": the climber leant back at one end of it, six or eight strong men pulled at the other. Probably in time, to "machila the Matterhorn" will be the regular thing in a Swiss trip.

THE third expedition to which we have to refer, has unfortunately not been successful in its attempt to solve the mystery of the reported snow-clad mountain which occurs between Kenya and Abyssinia. The existence of this has been frequently reported since it was first recorded by Abbadie as Mount Wosho. It was hoped that Dr. Donaldson Smith's expedition would have finally settled this question of the height and position of this mountain. The expedition has, however, been stopped by the Abyssinians, and sent back to the Somali frontier at Barri. His companion, Mr. Gillatt, has been compelled to return home, but Dr. Smith has determined to continue the expedition. As the rainy season and unhealthy country are before him, and as such people as the Somali are easily dispirited by a first failure, it is hardly likely that Dr.

Smith will reach Mount Wosho. He proposes to strike south for the Juba, and then westward across the Borana country to Basso Narok (Lake Rudolph). The expedition has already achieved some very interesting results, and if it succeed in its traverse of the Borana country, it will have amply atoned for its failure to reach its original goal of the Omo valley.

IN an address to the United States National Geographic Society, recently published in the *National Geographic Magazine*, Dr. C. Hart Merriam discusses the influence of temperature upon the geographical distribution of terrestrial animals and plants. It is well known that in the northern hemisphere animals and plants are distributed in circumpolar belts or zones, the boundaries of which follow lines of equal temperature; but difference of opinion prevails as to the period during which temperature exerts its restraining influence. Dr. Merriam opens new ground in the address to which we refer. Physiological botanists have long maintained that the various events in the life of plants, such as leafing, flowering, &c., take place when the plants have been exposed to definite quantities of heat, which are the sums total of the daily temperatures above a minimum ( $6^{\circ}$  C.) assumed to be necessary for functional activity, and are termed the *physiological constants* of the particular stages. Dr. Merriam infers from this that there must also be a physiological constant for the species itself; and this *species constant* must be the total quantity of heat required by a given species to complete its cycle of development and reproduction. It follows that not only the mean temperature, but also the total quantity of heat in particular zones must be considered in estimating the influence of temperature upon the distribution of plants and animals. Dr. Merriam has constructed a pair of isothermal charts of the United States, of which one shows the distribution of the total quantity of heat during the season of growth and reproduction (i.e. the sum of daily mean temperatures above  $6^{\circ}$  C.), and the other the mean temperatures during the six hottest weeks of the year. By comparing these with a biogeographical chart of the same region, Dr. Merriam concludes, from the striking coincidences which occur, that animals and plants are restricted in northward distribution by the total quantity of heat during the season of growth and reproduction, and in southward distribution by the mean temperature of a brief period during the hottest part of the year. The anomalous intermingling of boreal and austral types which occurs over an extensive area of the Pacific coast of the United States becomes explicable by the establishment of these principles, for here alone is a low summer temperature combined with a high sum-total of heat—the two conditions which permit extensive mixture in the same region of northern and southern types.

A CASE of dual brain action, presenting points of special interest, both in physiology and psychology, is described in *Brain* (Part lxxix.) by Mr. L. C. Bruce. The patient who formed the subject of observation varied considerably in his mental condition, and the most obvious phenomena observed during these changes were that in one condition he spoke the English language, and in the other the Welsh language. When in the former state, he was the subject of chronic mania. He was right-handed, and exhibited a fair amount of intelligence. He remembered clearly things he had noticed in previous English periods, but his memory was a blank to any that occurred during the Welsh stages. He wrote by preference with his right hand, his letters were fairly legible, and he wrote from left to right. If asked to do so, he would write with the left hand, but then produced mirror writing, traversing the paper from right to left. When in the Welsh stage, however, he was left-handed and the subject of dementia. His speech was almost unintelligible, but what could be understood was in the Welsh language. In this stage he had no idea of English,

and his mental and physical conditions altogether were the reverse of what they were in the English stage. From these observations, Mr. Bruce is led to believe that "the cerebral hemispheres are capable of individual mental action, and that the mentally active cerebrum has a preponderating influence over the control of the motor functions, the patient living two separate existences during the two stages through which he passes: the mental impressions received during each of the separate existences being recorded in one cerebral hemisphere only." If the cerebral hemispheres did not act independently, it is difficult to account for the patient's ignorance of events which happened to him in the Welsh stage when he passed into the English condition.

A NOTE on the electrostatic capacity of resistance coils wound in the ordinary way to avoid self-induction, is published in the *Comptes rendus* (February 11). The author (M. J. Cauro) has experimentally determined the electrostatic capacity of coils wound in several different ways, using for this purpose a Wheatstone's bridge arrangement with a commutator similar to that used by Ayrton and Perry in their secohmmeter. By comparing coils of practically the same shape and resistance the author finds that the errors due to capacity may, in the case of coils containing a large number of turns, be considerable when the ordinary double method of winding is adopted, but these errors are considerably reduced if the method of winding proposed by M. Chaperon is employed. The best results of all are obtained by winding the two wires in alternate layers, always starting from the same end of the bobbin, the wire being brought back parallel to the axis of the coil. For instance, with coils having a resistance of about 14,000 ohms and about 9500 turns, the three methods of winding give apparent self-induction (due to capacity) of  $-1.79$ ,  $-0.27$  and  $-0.16$  respectively. In order to make sure that the values obtained were really due to capacity, the author placed bundles of fine iron wire inside the different coils. The results obtained in this case were the same as those obtained without any iron core. By altering the connection of the two wires in the coil wound in the ordinary manner, so that the current traversed the two circuits in the same direction, the self-induction was found to be  $0.13$ . Thus by winding the wire double, the error due to electrostatic capacity was about twelve times as great as the error to eliminate which this method of winding was adopted.

Two volumes, recently added to the comprehensive *Aide Mémoire* series, published jointly by Gauthier-Villars and Masson, Paris, are:—"Appareils Accessoires des Chaudières à Vapeur," by MM. Dadebout and Croneau, and "Traité des Bicycles et Tricycles," by Dr. C. Bourlet.

THE names of the members of the electrical and kindred industries throughout the world are contained in "The Universal Electrical Directory," published by Messrs. H. Alabaster, Gatehouse, and Co. For simplicity and facility of reference the names are divided into four groups, namely, British, Continental, American, and Colonial, which are again subdivided into alphabetical and classified sections. There are nearly twenty-one thousand names in all, or two thousand five hundred more names than were given in the Directory for 1894.

Among the forthcoming books to be published by Messrs. J. and A. Churchill, the following are announced to appear at an early date:—"A Manual of Botany" based on that of the late Prof. Bentley, vol. 1., "Morphology and Anatomy," enriched with a large number of new illustrations, by Prof. J. Reynolds Green; "Elements of Health, an Introduction to the Study of Hygiene," by Dr. Louis C. Parry; and "Mental Physiology, especially in its relation to Mental Disorders," with illustrations, by Dr. T. B. Hyslop.

A VALUABLE work on the climatology of Africa, and on the distribution of disease in that continent, has just appeared. It is entitled "Tropical Diseases in Africa," by Dr. K. W. Felkin and is published by Mr. W. F. Clay, Edinburgh. The volume is based upon a lecture delivered at the African Ethnological Congress held at Chicago in 1893, and contains, as an appendix, a paper, read before the Budapest Congress last September, on a new method for graphically illustrating the geographical distribution of disease. The book forms an important addition to the literature upon tropical disease in Africa.

MEN of science are indebted to the beneficent provisions of the Smithsonian Institution for the generous distribution of scientific literature. A publication of special value to chemists is the "Bibliography of Aceto Acetic Ester and its Derivatives," by Mr. Paul H. Seymour, which, acting upon the recommendation of the American Association's Committee on Indexing Chemical Literature, the Institution has lately issued. The bibliography is arranged in chronological order from 1840, with author and subject indices appended. The outlines of memoirs are given, in order to show the scope of the originals. Mr. Seymour deserves the gratitude of chemists for this time-saving bibliography, upon which he has evidently bestowed much care.

ANOTHER paper prepared for the Committee on Indexing Chemical Literature, is "An Index to the Literature of Didymium," by Dr. A. C. Langmuir, just distributed as No. 972 of the Smithsonian Miscellaneous Collections. The index contains references to all the papers published on didymium, from the discovery of the element in 1842 to the year 1893. It furnishes a striking illustration of the wonderful results accomplished by the use of the spectroscope in modern chemistry. In addition to didymium, the following elements have now been indexed: Columbium, iridium, manganese, titanium, uranium, vanadium.

WE note the publication of the *Bulletin Météorologique* of the Imperial Observatory of Constantinople, for the year 1894. Although telegraphic observations have been published in the Paris weather report, we believe that very few regular observations from Constantinople have been received in this country for some twenty years. The bulletin contains some means derived from twenty-seven years' observations, which show that the maximum shade temperature was 99.5, in 1888, and the minimum, 17.2, in 1869. The average yearly rainfall is 23.3 inches, and the average frequency, eighty-six days. Snow falls on about fifteen days, and fog occurs, on an average, on fifty-nine days. An appendix contains a list of the earthquakes in the Ottoman empire during the year 1894.

A SKETCH of the attainments and life-work of Dr. T. B. Rake, who died at Trinidad last August, is given in the *Journal* of the Trinidad Field-Naturalists Club for December 1894. Dr. Rake was the superintendent of the Leper Asylum at Trinidad, and presided over the Leprosy Commission. The reports issued during his eight years' administration of the Asylum are of the highest value, for he was well acquainted with bacteriological methods of research, and he put on record numerous observations referring to the leprosy bacillus. He was not, however, only a high authority on leprosy, but an enthusiastic and keen observer of nature. At the time of his death he was the President of the Trinidad Field-Naturalists Club, the members of which will remember him for many years to come. An excellently reproduced portrait of Dr. Rake forms the frontispiece of the *Journal* containing the very appreciative obituary notice.

A MONUMENT to the humanitarian spirit of the members of the Mulhouse Association pour prévenir les Accidents de



Fabriques is afforded by a ponderous volume, the second edition of which has been received from the Association. The volume is entitled "Collection of Appliances and Apparatus for the Prevention of Accidents in Factories." It is illustrated by thirty-seven finely-drawn plates, and the text is printed in French, German, and English. The London agents are Messrs. Dulau and Co. What strikingly indicates the high motives which actuate the Association is that the volume is published at the price it cost to reproduce. The one object of publication is to spread the knowledge, and encourage the adoption, of the numerous appliances devised for the prevention of accidents from machinery. The factory inspector and manager, the mechanical engineer, and all others who are concerned in the construction and use of machinery, should see this very useful volume.

WE have received the first two numbers (1892-1893) of the yearly *Bulletin of the Geological Institution of the University of Upsala*. This is a publication that should be of great interest to all British geologists whose work lies among the Lower Palæozoic rocks, since on those strata Swedish researches have thrown so much light. Among the contents are two papers by C. Wiman, on the structure of Graptolites; stratigraphical papers, by the same author, and J. G. Andersson; petrographical and mineralogical papers, by Prof. Nordenskiöld and H. Sjögren; and others. Nine plates in all, illustrate the numbers. The papers are all in either English or German (French is the only other language permitted); this will be satisfactory to those British geologists who have found the Swedish language a serious barrier to the study of important geological papers in the past. We may add that the *Bulletin* will be sent, not only to all geological institutions, but also to all private workers who send their publications regularly in exchange.

AMONG the new editions received during the past week, is the second edition of the "Introduction to Physiological Psychology" (Swan Sonnenschein and Co.), translated from the revised and enlarged second German edition of Dr. Trichen's work, reviewed in these columns four years ago (vol. xlv. p. 145). The chief addition is a chapter upon the emotional tone of the ideas. Another new edition (the fourth), just received, is "A Treatise on Elementary Trigonometry" (Longmans, Green, and Co.), by Dr. John Casey, F.R.S., edited by Prof. P. A. E. Dowling. This little work has found favour among many teachers and students, and the new issue should be even more popular. Dr. W. H. Besant's "Conic Sections" (George Bell and Sons) has reached a ninth edition. The articles on reciprocal polars have been expanded into a separate chapter, and a chapter on conical projections has been inserted. Two other books, which may be included among new issues, belong to the handy series of Economic Classics published by Messrs. Macmillan and Co. One consists of select chapters and passages from Adam Smith's "Wealth of Nations"; the other contains the first six chapters of Ricardo's "Principles of Political Economy and Taxation."

MESSRS. SWAN SONNENSCHN AND CO. have in the press an important work on the Indian Calendar, written by Mr. Robert Sewell, in collaboration with Mr. Sankara Balkrishna Dikshit. The work contains complete tables for the verification of Hindu and Muhammadan dates for a period of 1600 years (A.D. 300 to 1900), and forms an attempt to carry out in practical form the exact fixation of the astronomical phenomena on which the Hindu Calendar depends, and without which no conversion of dates into European reckoning can be safely relied upon. It embraces the whole of India. The calculations have been based on the general tables published by Prof. Jacobi, of Bonn, checked and enlarged by Mr. S. Balkrishna Dikshit.

The precise position of sun and moon at sunrise on the meridian of Ujjain on the first day of each year of the Luni-solar Calendar during the period referred to is given, and for the Solar Calendar the moment of the sun's passing the first point of Aries in each year is entered in time reckoning. Full details for the addition and suppression of months in the intercalary Luni-solar years are provided; and where necessary the calculations have been made for true as well as mean intercalations. The solar phenomena have, moreover, been computed by both the Arya and Surya Siddhantas. It is hoped that the volume will form a standard work of reference for chronologists, as well as for all courts and offices in India.

THE additions to the Zoological Society's Gardens during the past week include a Giraffe (*Giraffa camelopardalis*, ♀) two Sable Antelopes (*Hippotragus niger*, 3 ♀) two Brindled Gnus (*Connochates taurina*, 3 ♀), a Levaillant's Cynictis (*Cynictis penicillata*) from South Africa, two great Eagle Owls (*Bubo maximus*), European, purchased; two Rock-hopper Penguins (*Eudyptes chrysocome*) from New Zealand, four Black Francolins (*Francolinus vulgaris*) from India, a Robben Island Snake (*Coronella phocorum*) from South Africa, deposited; a Black-headed Gull (*Larus ridibundus*), British, presented by Mrs. Rees Davis; a — Bazzard (*Buteo*, sp. inc.) from South Africa, presented by Mr. J. E. Matcham; a Robben Island Snake (*Coronella phocorum*) from South Africa, presented by Dr. Arthur D. Bensusan.

#### OUR ASTRONOMICAL COLUMN.

SPECTROSCOPIC MEASURES OF PLANETARY VELOCITIES.—A new feature in the application of the Doppler-Fizeau principle has been recently brought forward by M. Deslandres (*Comptes rendus*, Feb. 25). It is to the effect that when we observe the spectrum of a body shining by reflected light the displacement of the lines due to movements in the line of sight depends upon the movement of the body with respect to the original source of light, as well as on its movement with regard to the observer.

The truth of this principle is demonstrated by an investigation of the rotation of Jupiter which M. Deslandres has carried out with his usual skill. The equatorial linear velocity of the planet is 12·4 kilometres, and the difference of the velocities of the two extreme edges 24·8 kilometres; actual measurements of the spectrum photographs taken near opposition, however, show a relative movement of twice this amount. The best results appear to have been obtained by allowing the equator of the planet to lie along the slit of the spectroscope, in which case the effect of the displacements at different distances from the centre is obviously to produce an inclination of the lines of the planet spectrum to the lines of the comparison spectrum, and this inclination affords the means of determining the velocities. This method has the advantage that the effects of small movements of the image on the slit during the long exposure necessary with the great dispersion employed are of little consequence; movements in declination will have no effect on the inclination of the lines, and movements in right ascension will only tend to make them somewhat more diffuse.

M. Deslandres points out that the new principle may possibly have many important applications in connection with planetary velocities, among which he specially mentions the determination of the rotation period of Venus, and even possibly of the solar parallax, the latter being derived from the radial velocity of Venus. M. Poincaré shows that M. Deslandres' results are quite in accordance with theoretical considerations.

THE SATELLITES OF MARS.—Prof. Campbell, of the Lick Observatory, took advantage of the recent opposition of Mars to secure a long series of micrometric measurements of the satellites with the 3-foot telescope (*Astr. Journal*, No. 337). The reduction of the observations of Phobos shows that the eastern elongation distance was nearly a second greater than the western, whereas Hall's observations in 1877 showed that the distance at western elongation was then about 2'·2 greater

than the eastern. "If the orbit had remained unchanged from 1877, the western distance in 1894 should have been about 1° 8' greater than the eastern. The change of nearly 2° 8' is evidence of a marked transformation of the orbit during the years 1877-94. The line of apsides has probably revolved through a polar compression of the planet." The observations also appear to indicate a similar transformation of the orbit of Demios, but the evidence is not quite so conclusive. Both satellites are about 10 minutes behind Marth's ephemeris, and the adopted values of their periodic times require slight correction.

ECLIPSE OF THE MOON, MARCH 11.—The following particulars with regard to the total eclipse of the moon on the morning of Monday, March 11, may be of interest:—

	G. M. T.
	h. m.
First contact with penumbra ... ..	0 58.4
" " " shadow ... ..	1 53.9
Beginning of total phase ... ..	2 51.8
Middle " " " " ... ..	3 39.2
End " " " " ... ..	4 29.6
Last contact with shadow ... ..	5 24.5
" " " penumbra ... ..	6 20.0

The first contact with the shadow will occur at 127 from the north point of the moon's limb towards the east, and the last contact at 69 towards the west, in both cases for the direct image as seen with the naked eye. The magnitude of the eclipse (moon's diameter = unity) will be 1.619.

The moon will be seen in the shadow at places between longitudes 5h. E. and 12h. W. Among the principal stars occulted during the eclipse will be 83 Leonis, mag. 7.5, which will disappear at 2h. 17m. at an angle of 95° and reappear at 3h. 12m. at an angle of 338; and 7 Leonis, mag. 5.0, which will disappear at 2h. 56m. at 86°, and reappear at 3h. 43m. at an angle of 345; the angles being reckoned from north towards east.

THE NILE!

I AM to speak to you to-night of the Nile, and I think I may fairly say it is the most famous river in all the world famous through all the ages, for the civilisation that has existed on its banks; famous for its mystic fabulous rise, about which so many sages and philosophers have pondered; famous for its length, traversing one-fifth the distance from pole to pole; famous, and apparently destined to be famous, for the political combinations that ever centres around it. But I feel I must begin by an apology, for now that Egypt has come so completely within the tourist's range, probably many of my hearers have seen more of the Nile than I have.

If a foreigner were to lecture to his countrymen about the river Nile, and were to begin by informing them that he had never been above Greenwich, he might be looked upon as an ignorant and perhaps I am not much better, for I have never been higher up the river than Philæ, 610 miles above Cairo. For information regarding anything higher up, I must go, like you, to the works of Speke, Baker, Stanley, and our other great explorers. I shall not, then, detain you to-night with any elaborate account of this upper portion of the river, but will only remind you briefly of that great inland sea, the Victoria Nyanza, in extent only a little less than the American Lake Superior, traversed by the equator, and fed by many rivers, some of them taking their rise as far as 5 S. lat. These rivers form the true source of the Nile, the mystery only solved in the present generation.

The outlet of this great lake is on its north shore, where the river rushes over the Raft Falls, estimated by Speke to be only 100 or 500 feet wide, and with a drop of 12 feet. Thence the river's course is in a north-west direction for 270 miles, to where it thunders over the Murchison Falls, a cliff of 120 feet high. Soon after that it joins the northern end of Baker's Lake, the Albert Nyanza, but only to leave it again, and to pursue its course through a great marshy land for more than 600 miles, to where the Bahr el Jebel joins it from the west, a little further down the great and tributary comes in on the east. This is the region in

which the river is obstructed by islands of floating vegetation, which, if checked in their course, at last block up its whole width, and form solid obstructions known as *sabils*, substantial enough to be used as bridges, and obstacles, of course, to navigation, until they are cleared away. The waters of the Saubat are of very light colour, and tinge the whole river, which, above its junction, is green and unwholesome, from the long chain of marshes which it traverses. Hence it is called the White Nile, 600 miles further brings us to Kharoum, where the Blue Nile from the Abyssinian mountains joins it, and at 200 miles still further to the north it is joined by the Atbara river, also from Abyssinia, a torrent rather than a river.

Baker gives a graphic account of how he was encamped by the dry bed of the Atbara on June 22, 1861. The heat was intense, the country was parched with drought. During the night the cry went forth that the floods were coming, and in the morning he found himself on the banks of a river, he says, 500 yards wide and from 15 to 20 feet deep. All nature had sprung into life. A little north of the junction of the Atbara is Berber, whence you will remember is the short cut to Suakin in the Red Sea, which so many thought would have been the true route for our Army to take in relieving Gordon. From Khartoum to Assouan is a distance of 1100 miles of river, during which it makes two immense curves, for on a straight line the distance is not half so much, and it is in this part of its course that it passes over the six great cataracts or rapids which block all ordinary navigation. The first or furthest north cataract is just above Assouan, a distance of 750 miles from the Mediterranean, through the country known as Egypt. From the junction of the Atbara to its mouth in the Mediterranean, a distance of 1680 miles, the Nile receives no tributary. On the contrary, during every mile of its course its waters are diminished by evaporation, by absorption, and by irrigation. The river gets less and less as it flows through this rainless land, and its maximum volume is to be found during the floods at the junction of the Atbara, and at other seasons at Khartoum, 1875 miles from the Mediterranean.

The whole distance by river from the Victoria Nyanza to the sea is about 3500 miles. It may not be easy to derive any clear impression from this bare recital of mileage. Let me try to convey to you in some other ways the idea of the length of the Nile. Standing on the bridge at Cairo, I used to reflect that I was just about half-way between the source of the Nile and the White Sea. Or to put it another way: if we could suppose a river crossing our English Channel, and that the Thames should find its outlet in the Euphrates and the Persian Gulf, that river would be about as long as the Nile.

In this short sketch of the course of the Nile, I must not forget to mention one interesting feature. About 40 miles south of Cairo, the low Libyan chain of hills which bounds the Nile valley on the west is broken by a gap, through which the waters of the river can flow, and beyond this gap lies a saucer-shaped depression called the Fayum, of about 400 square miles in area, sloping down to a lake of considerable size, the surface of whose waters stands about 130 feet below that of the sea. This lake is known as the Birket el Kurin.

From the time of the earliest Egyptian records, this province of the Fayum was famed for its fertility, and to the Egyptian taste for its delightful climate. Many of the most precious monuments of antiquity have been found in the Fayum. The famous Labyrinth is supposed to have stood just at its entrance; and what has excited most interest for the engineer in all times, it is here that Herodotus places that wonderful lake Meris, which receiving for half the year the surplus supply of the Nile, rendered it back again in irrigation to Lower Egypt during the other half. Where this lake actually was, has excited discussion since any attention has been paid to ancient Egyptian history. It seems pretty clear that in earlier days the Birket el Kurin was of much greater proportions than it is now, but how it ever could have been large enough to allow of its waters flowing back into the Nile valley when the river was low, without at the same time drowning the whole Fayum, is not very clear.

Now, what are the functions of a great river, what are the offices which it renders to man? And first of all, at least in this latitude, we would mention the carrying off to the ocean of the surplus water that descends from the skies. Nobly does the Nile fulfil this duty; but with this enormous qualification that it transports the water from tracts where there is too much and carries it all free of cost, not to waste it in the sea, but to

Article re-delivered at the Royal Institution Library by Sir Colin Clark, F.R.S.

bestow it on tracts where it is of priceless value, more than taking the place of rain in watering the fields.

The next function of a river is to form a highway through the land, and for most of its course the Nile fulfils this duty well too. Gordon considered it possible for steamers to ascend the Nile during the floods from its mouth to the Fola rapids, a distance of about 3040 miles; but at other seasons, the six cataracts cannot be passed. Leaving out the 1100 miles which they occupy, there is an unbroken 750 miles in the lower, and nearly 1200 miles in the upper river. I cannot look on it as probable that it will ever pay to make navigable canals and locks round these cataracts, as it would entail so much hard rock-cutting.

Another function of a river is to promote industry by the employment of its water-power. We know how valuable is this power even in England, and how much more in countries like Switzerland, where it abounds, and on the great rivers of America. Excepting a few very rude wooden wheels in the Fayum, I do not know, through all the annals of the past, of a single water-wheel ever turned by the power of the Nile. But that power exists to an almost unlimited extent. And may we not prophesy that some day in the future, when that long stretch of Nubian cataracts has fallen into civilised hands, and when we know how to transmit electric energy with economy, that then our descendants will draw wealth to Egypt from its chain of barren cataracts?

As a drainage outlet to a continent, as a long highway, as a source of power, the Nile is great; but not so much so as many other rivers. Its unique position is due to the benefit it confers on Egypt in turning it from being a desert into being the richest of agricultural lands, supporting with ease a population of about six hundred to the square mile. Herodotus truly said Egypt is the gift of the Nile. It more than supplies the absence of rain, and this it does, first, by the extraordinary regularity with which it rises and falls; and secondly, by the fertilising matter which the waters carry in suspension, and bestow upon the land. Imagine what it would be to the English farmer if he knew exactly when it would rain and when it would be sunshine. When the Irrigation Department of Egypt is properly administered, the Egyptian farmer possesses this certainty, and he has this further advantage—that it is not merely water that is poured over his lands, but, during nearly half the year, water charged with the finest manure.

According to the early legend, the rise of the Nile is due to the tears shed by Isis over the tomb of Osiris, and the texts on the Pyramids allude to the night every year on which these tear-drops fall. The worship of Isis and Osiris has long passed away, but to this day every native of Egypt knows the *Lailat en Nuktah*, the night in which a miraculous drop falls into the river, and causes it to rise. It is the night of June 17. Herodotus makes no allusion to this legend of Osiris. In his time, he says, the Greeks gave three reasons for the river's rise. He believed in none of them, but considered, as the most ridiculous of all, that which ascribed the floods to the melting of snows, as if there could possibly be snows in such a hot region. It was many centuries after Herodotus' time when the snowy mountains of Central Africa were discovered.

The heavy rains commence in the basin of the White Nile during April, and first slowly drive down upon Egypt the green stagnant waters of that marshy region. These appear at Cairo about June 15. About a fortnight later the real flood begins, for the rains have set in in Abyssinia by May 15, and the Blue Nile brings down from the mountains its supply of the richest muddy water. It is something of the colour and nearly of the consistency of chocolate, and the rise is very rapid, as much sometimes as 3 feet per diem, for the Atbara torrent having saturated its great sandy bed, is now in full flood also. The maximum flood is reached at Assouan about September 1, and it would reach Cairo some four days later, were it not that during August and September the water is being diverted on to the land, and the whole Nile valley becomes a great lake. For this reason the maximum arrives at Cairo about the beginning of October. The rains cease in Abyssinia about the middle of September, and the floods of the Blue Nile and Atbara rapidly decrease; but in the meantime the great lakes and marshes are replenished in the upper regions, and slowly give off their supplies, on which the river subsists, until the following June. Yearly this phenomenon presents itself in Egypt, and with the most marvellous regularity. A late rise is not more than about three weeks later than an early rise. In average years the height of the flood at Assouan is about 25½ feet above the

minimum supply. If it rises 29 feet above this minimum, it means peril to the whole of Egypt, and the irrigation engineer has a hard time of it for two months. If the river only rises 20 feet above the minimum, it means that whole tracts of the valley will never be submerged. Such a poor flood has happened only once in modern times, in 1877, and the result was more serious than the devastation caused by the most violent excess.

The mean flood discharge at Cairo is about 280,000 cubic feet per second, the maximum about 400,000. The mean lowest Nile is about 14,000 cubic feet per second at Cairo, but some years there is not more than 10,000 cubic feet per second passing Cairo in June, and within three months after this may have increased forty-fold.

Until this century, the irrigation of Egypt only employed the flood waters of the river, and it was this that made it the granary of the world. No doubt, rude machines for raising Nile water were used at all seasons and from all times. But by these it was not possible to irrigate on a large scale, and in reality they were only employed for irrigating vegetables or gardens, or other small patches of land. It must not be thought that the water of the flooded river is ever allowed to flow where it lists over the lands. The general slope of the valley on each side is away from the river, a feature which the Nile shares with all Deltaic streams. Along each edge of the river, and following its course, is an earthen embankment, high enough not to be topped by the highest flood. In Upper Egypt, the valley of which seldom exceeds six miles in width, a series of embankments have been thrown up, abutting on their inner ends against those along the river's edge, and on their outer ends on the ascending sides of the valley. The whole country is thus divided into a series of oblongs, surrounded by embankments on three sides, and by the slope of the desert hills on the fourth. In Lower Egypt, where in ancient days there were several branches of the river, this system was somewhat modified, but was in principle the same. These oblong areas vary in extent from 60,000 to 3000 or 4000 acres, and the slope being away from the river, it is easy to cut short, deep canals in the banks, which fill as the flood rises, and carry the precious mud-charged water into these great flats, or, as they are termed, basins of irrigation. There the water remains for a month or more, some three or four feet deep, depositing its mud, and then at the end of the flood it may either be run off direct into the receding river, or, more usually, passed off through sluices from one basin to another, and ultimately back into the river. In November the waters have passed off, and wherever a man and a pair of bullocks can walk over the mud, and scratch its surface with a wooden plough, or even the branch of a tree, wheat or barley is sown, and so saturated is the soil that the grain sprouts and ripens in April or May without a drop of rain or any fresh irrigation. And a fine crop is reaped. One of our great brewers told me the other day, that when barley grown in this country was spread in the malting-house, about three per cent. of it must be counted on as not sprouting and being dead. If grain two or three years old was used, as much as twenty per cent. would be found dead. With Egyptian barley, he said, even after several years, you could count on every grain germinating. The crop once reaped, the fields remain dry, and crack in the fierce summer heat until next flood comes on.

The tourist who only comes to Egypt to shun "winter and foul weather," knows nothing of the majestic glories of the Nile flood. The ancient Nilometer at the south end of the island of Roda, just above Cairo, is one of the most interesting sights of the place. The water enters from the river by a culvert into a well about 18 feet square, with a graduated stone pillar in the centre. On each side of the well is a recess about 6 feet wide and 3 feet deep, surmounted by a pointed arch, over which is carved in relief a Kufic inscription, and a similar inscription is carried all round the well, consisting of verses of the Koran. A staircase goes down the well, from the steps of which the initiated may read the height of the water on the pillar; but they are few in number, and the hereditary Sheikh of the Nilometer, whose duty it is to keep the record, is a person of some importance. The Nilometer dates from A.D. 861, and I believe in the archives of Cairo may be found the daily record for 1000 years.

I need hardly tell you that when our English engineers took the river in hand, we established a number of gauges at Wadi Halfa, Assouan, Cairo, and many other points, on more scientific principles than the venerable Nilometer of the Roda Island.

After the river has begun to rise, its height is daily chanted

through the Cairo streets until it reaches 16 cubits on the gauge. At this point the *Khalig el Masri*, the old canal that flows through the heart of Cairo, is opened—up to this point it is dry, and full or empty it is little more than a sanitary abomination at present; but in former days it occupied an important place, and when the Nile water was high enough to flow down its bed, it was looked on that the flood had fairly set in, and that the sandy fruits of the earth might be duly expected.

The head of this canal is on the right bank of the river, just south of Cairo. The water enters a channel some 30 feet wide, with a high wall on its left, and a sloping bank on its right or southern flank. The water then flows under the pointed arch of an old stone bridge. The bed of the canal is cleared so that it would flow in at a gauge of about 14½ cubits, but an earthen bank is thrown across it about 4 feet higher.

There is no more interesting ceremony in Egypt than the annual cutting of the *Khalig*, as the opening ceremony is called. It takes place between August 5 and 15. Days before preparations are being made for the festival. Tents with innumerable lamps are placed along the wall on the one side. Frames for all manner of fireworks are erected on the sand-bank on the other side. All the notables are there in full uniform, or in canonical. The Khedive himself, or his representative, the Sheikh ul Islam, the highest dignitary of the Mohammedan faith, the Sheikh el Bekri, the Sheikh es Sadat, all the learned scribes of the great university of the Azhar, the Cabinet Ministers and Under-Secretaries, the Sirdar of the Army and his staff, the Judges, and the Financiers.

The Egyptian troops are turned out, salutes are fired, and about eight o'clock in the warm summer night the classes all assemble under the early-lighted tents, the masses crowd round the frames for the fireworks, the street is lined with harem carriages full of closely-veiled figures, though it is not much that they can see from their broughams. Out in the river, just opposite the canal's mouth, is moored an old hulk of a certain sea-going outline, which has been towed up from Boulak during the day, and is an emblem of the time when the great republic of Venice sent an envoy to witness the ceremony. This boat is full of lamps, and fireworks too. As the night deepens the excitement increases. The populace on the bridge and the opposite bank are shouting, yelling, and dancing wildly round the fireworks. On the other side are the gay uniforms and lighted tents, from whence we can look over the wall down on the dark water, where you see brown figures plunging in and waist-deep digging with their hoes at the embankment that blocks the canal's mouth.

Long before midnight the fireworks have gone out, and left the splendid stars to themselves; the grandees have all gone to bed, but the people keep up the revelry, and in the morning, by 7.30, every one has come back. Then but little of the bank is left uncut; a few more strokes of the big hoes will do it, and the brown skins and the brown water reflect the bright sunlight from above. Then the Sheikh ul Islam solemnly thanks the Almighty, Allah the All-powerful, the All-merciful. He implores His blessing on the flood, and at a signal the bank is cut, the waters rush in, and with them a crowd of swimmers. A bag of silver pastres is scattered among them, and the ceremony is at an end.

There is a pretty legend, worth telling, of the cutting of the *Khalig*. Amr, the Mohammedan General, took Cairo in A.D. 640. Long before then there had been a heathen ceremony, and a virgin was yearly sacrificed to the god of the river. When the season came round, Amr was called upon as usual to sacrifice the girl. He sternly refused. That year the Nile flood was a failure. You can fancy how the indignant heathen population must have raged at the invader, and said, "We warned you what would happen if you didn't propitiate the river-god." "Cannot we fancy, also, how Amr's wild Arab soldiers must have had their teeth sorely tried, and how they must have felt puzzled as to whether in this strange new country, with all those demon-bull temples and pyramids, crocodiles and sphinxes, it might not be as well to make friends of the local gods. Could Allah really help them here?" Again the Nile flood came round. This time surely Amr would sacrifice the girl, and save the land. No, he would not. The people rose in rebellion. Amr stood firm. But he wrote to the Khalid Omar for orders (Omar, whose name you will remember has come down in history as the destroyer of the Alexandrian Library). Omar approved of his conduct, but sent him a paper to throw into the Nile. On the paper was written, "From Abd Allah Omar, Prince of the

Faithful, to the Nile of Egypt. If thou flow of thine own accord, flow not; but if it be Allah, the one the mighty, who causeth thee to flow, then we implore him to make thee flow." Amr threw the paper into the water, and the Nile rose forthwith exactly as it was wanted. Since that day no girl has been sacrificed; but a pillar of earth is yearly left to be washed away in the middle of the canal, called the bride or the girl.

Such, as I have briefly described it, was the irrigation of Egypt until this century, when it fell under the rule of Muhammed Ali, a very sagacious and strong if a very unscrupulous ruler. He saw that the country could produce far more valuable crops than cereals. The European market could be supplied with these from the fields of Europe, but Europe could not produce cotton and sugar-cane. Egypt had the climate, had the soil, had the teeming population; but these crops required water at all seasons; nor would it do to flood the fields to any depth, for just at the flood season the cotton crop is ripening. There was plenty of water in the river; but how was it to be got on to the land? Perennial irrigation was a fresh departure. As I have said, the Nile rises about 25½ feet. A canal then running 12 feet deep in flood has its bed 13½ feet above the surface of the Low Nile. Either the Nile water had to be raised, or the beds of the canals had to be lowered, in order that one should flow into the other, and after that the water had to be raised from the canal on to the land. Muhammed Ali began by lowering the canal beds of Lower Egypt, an enormous work considering the great number of the canals; and as they had been laid out on no scientific principles, but merely to suit the fancies of Turkish pashas or village sheikhs, and as those who had to excavate them to this great depth had only the slightest knowledge of levelling, the inevitable result followed—the deep channel became full of mud during the flood, and all the excavation had to be done over again. Incredible as it may seem, this great work was done year after year. It was a great serf population; if they were not fighting Muhammed Ali's battles in Arabia and Syria, they might as well be digging out the canals. No one thought of paying or feeding the workmen. The bastinado was freely applied if they attempted to run away. If they died under the labour, there were plenty more to come. But of course the work was badly done. The water might enter the canal; but as the bed was not truly levelled, it did not follow that it would flow far. Then, as the river daily fell, the water in the canals fell too, and lessened in volume as the heat increased, and more was required. At last—in June, perhaps—the canal was dry, and the cotton crop that had been sown and watered, weeded and nurtured, since March, was lost altogether.

Then some one advised Muhammed Ali to throw a dam across the river, and so raise the water, and the result was the great Barrage.

About twelve miles north of Cairo the Nile bifurcates, and finds its way to the sea, by the Rosetta and Damietta branches. Across the heads of these two branches were built two stone bridges, one of 71, the other of 61 arches, each 5 metres or 16.4 feet span. These arches were intended to be fitted with gates; by lowering which, all the water would be dammed up, and diverted into three great trunk canals, taken out of the river just above these bridges. One to the right or east of the Damietta branch was to supply water to all the Provinces of the Eastern delta, one between the two bridges was to supply the splendidly fertile central delta, the third to the left or West of the Rosetta branch was to water all the Western delta down to Alexandria.

There was no intention of water storage at the Barrage, but it was merely with the object of controlling the supply. While there was water enough in the river, by closing the gates it could be kept to a uniform level, and sent down the three trunk canals, from which it was to branch, into many minor ones. As the river went down, gate after gate would be closed, and so a constant supply could be kept in the canals. The idea was thoroughly sound. The execution was feeble.

Mongel Bey, the French engineer in charge of the work, had no doubt many difficulties to contend with. The work went fitfully on for many years, thousands of men being forced to it one year, and carried off to a campaign the next. But at last it was sufficiently finished to allow of an opening ceremonial in 1861. Gates had been fitted into the Rosetta branch arches, never into the Damietta.

The Central canal had been dug in tolerably satisfactory style. The Western canal, too, had been dug, but passing through a strip

of desert it had become very much filled up with sand. The Eastern canal was dug some five miles, and then stopped. Of course the Barrage without these canals was useless. However, they began to experiment with it, closing the gates on the Rosetta side. It was intended to hold up  $4\frac{1}{2}$  metres, or 14 feet 9 inches of water. It never held up 5 feet, till in 1867, it cracked across from top to bottom, on the Western side. An immense cofferdam was built round the cracked portion, and the water was never held up again more than about  $3\frac{1}{2}$  feet, while the work was looked on as a deplorable failure. In 1883, all hope of making anything out of the Barrage was abandoned, and the Government were on the point of concluding a contract with a company to supply Lower Egypt with irrigation by means of an immense system of steam pumps, to cost £700,000 to begin with, and £250,000 a year afterwards.

That year there was a wretched serf army of 85,000 men working at canal clearances for 160 days, unfed, unpaid. The burden was nearly intolerable. The irrigation was all by fits and starts. There was no drainage; every hollow became sour and water-logged. With waterways everywhere, there was no navigation. In Upper Egypt things were better, as the system was a simpler one. But when we came to look into them too, we found great abuse, and on an average about 40,000 acres never succeeded in obtaining water, though in the midst of abundance.

The Fayum had long been a much-neglected province, though a most picturesque and attractive one. From carelessly allowing Nile water to flow into the lake during the floods, it had risen enough to swamp 10,000 acres of valuable land, and this mischief we found still increasing.

Throughout the whole country drainage had been absolutely neglected. And here I would point out that irrigation without drainage means the sure deterioration of the land sooner or later. Considerable pains had been taken in Egypt to get the water on to the land. No sort of effort had been made to get it off. In a properly irrigated tract, between every two canals of supply, there should flow a drainage channel; the former should follow as far as possible the highest lands, the latter should follow the lowest. The canal gets smaller, till at last it is exhausted, giving itself out in innumerable branches. The drain, like a river, gets larger as it proceeds, being constantly joined by branches. But if there be no drains, and if the canals are laid out to flow into one another, so as to divide the country into, as it were, a cluster of islands, you can understand how the drainage water has no means of flowing off into the sea, and settles in unwholesome swamps. These we found prevailing to an alarming extent in the rich provinces of the delta. Such was the wretched state of Egyptian agriculture—the one single source of the country's wealth—when Lord Dufferin laid down the lines of the English administration, which have been amplified and pursued ever since.

It was in May, 1883, that I took charge of the irrigation department in Egypt, having before then had some twenty years' experience of similar work in India; and I soon had the inestimable advantage of being joined by a band of the most indefatigable, energetic and able engineers, also from India, with whom it was my great privilege and happiness to be associated for the next nine years. I cannot talk too highly of these my colleagues—men who knew their work and did it, who kept constantly moving about in the provinces, badly lodged, badly fed, denied domestic comforts, constantly absent from their wives and families (they were all married men).

My friends, happy is the reformer who finds things so bad that he cannot make a movement without making an improvement. Happy the reformer who has as colleagues a staff of thoroughly loyal, duty-doing and capable men. Happy the reformer who is not pestered on all sides by the officious advice of the ignorant. Happy the reformer who has behind him a strong brave chief, as honest and truthful as he is strong. Such rare happiness fell to me in Egypt with my noble colleagues, and with Lord Cromer as our chief.

It is not my intention to enter into any details to-night of what our work was in Egypt. I have lately spoken about that elsewhere, and there would be no time to do so now. I must just describe it generally.

On first arrival, I was pressed, both by English and French men, to go into the question of the storage of the flood waters of the river on a large scale. I declined to do so, considering it would be time enough to think of increasing the quantity of water at our disposal when we had profitably used all that we already had, and while mighty volumes were daily flowing

out to the sea, it could not be said that we were doing that. The first great work to be studied was the Barrage. We were warned on all sides to have nothing to say to it, as it was thoroughly unsound; but we felt sure we must either make it sound or build an entirely new one, and we resolved on the former. The work had failed because it was faulty in design, the floorings and foundations not being sufficiently massive, and faulty in execution from the dishonest use of bad materials and from bad workmanship. The bed of the river consists of nothing more stable than sand and alluvial mud for at least 200 feet deep. It was out of the question to think of getting down to solid rock. It was not, as we thought, very safe to excavate very deeply close to the existing works, so we decided not to try it, but merely to strengthen and consolidate the foundations, built as they were on sand. I have said that the work consisted of two great bridges over the two branches of the river. We could not shut up either branch entirely; but we decided to strengthen and complete one-half of each bridge each season, which meant four seasons' work. While the river was still in considerable flood each November, we began to throw out great embankments of earth about 200 feet from the bridge; one up-stream, the other down-stream of it, beginning at the shore end, and ultimately enclosing one half of the river as in a pond. This used to take three months' hard work. Then we pumped the water out of this enclosure, and laid bare the very bed of the river. Then we laid a massive stone flooring,  $5\frac{1}{2}$  feet thick, extending 100 feet up-stream, and as much down-stream, of the bridge. This was very difficult and hard work. It was kept going day and night, without intermission, from March till the end of June. Then we cut great holes in our embankments, cleared out our machinery, and prepared for the arrival of the flood at the beginning of July. Each year one-half of one bridge was finished, and the whole was completed at the end of June 1890.

In connection with the Barrage were completed the three great canals to carry off all the river supply from above it. So that practically now the Low Nile is emptied every season at the Barrage and diverted into these canals, and no water at all escapes to the sea. The natives wade everywhere across the river north of this point. Since it was completed the Barrage has given no trouble. It holds up every year 4 metres, or 13 feet of water. The three trunk canals were all supplied with locks 160 feet by 28 feet, and adapted for navigation. The whole of these works cost about £800,000. The annual increase of the cotton crop, compared to what it was before 1884, is never less than two and a half millions sterling, which has not been a bad investment for Egypt.

Turning to Upper Egypt, my colleague, Colonel Ross, directed his attention very closely to the adjustment of canals overlapping one another, passing under and passing over one another; so that in future I trust that with the feeblest Nile flood it will be possible to pour water over every acre of the land.

The question of drainage was very thoroughly taken up. Twelve years ago it may be said that there were no drainage channels in Egypt. Two years ago there were about 1000 miles of such channels, some with beds as wide as 60 feet and flowing deep enough to carry cargo boats, others with beds only 3 or 4 feet wide. I am glad to say by these means large tracts in Lower Egypt which had been abandoned as totally ruined have now been restored to cultivation. The level of the lake in the Fayum was reduced by 13 feet between 1885 and 1893, and most of the inundated lands around it have been again dried.

I have already mentioned the cruel hardship of the corvée, the serf army of 85,000 men who were employed in the canal clearances from January to July, nearly half the year. I believe this institution was as old as the Pharaohs, and it was not easy to abolish it. But of course it went sorely against our British grain. Little by little we got money to enable us to pay our labour. By an annual outlay of £400,000 this spring corvée has entirely ceased since 1889, and now the Egyptian labourer carries out these clearances in as free a manner as his brother in Middlesex, and gets paid for his work.

Having thus, to the best of our powers, utilised the water in the river flowing past us, we turned our attention to the storage of the surplus waters. Without some such storage it is impossible to increase the cultivation during the Low Nile. All the water is used up. During High Nile there is always a great volume escaping useless to the sea.

There are two ways in which the water may be stored; either by throwing a dam right across the river and forming a great lake above it, or, if such a place can be found, by diverting the flood water into some suitable hollow, and drawing it off from there at the season of low supply, as done by Herodotus celebrated Lake Moiris. At one time there was a hope that such a storage basin might be found. An American gentleman, named Mr. Cope Whitehouse, in search of the real Moiris, found a very remarkable saucer-shaped depression just south of the Fayum. We knew it could not have been Moiris, because in its bed we found no traces of a deposit of Nilotic mud, but it might be possible all the same to utilise it. The place was very carefully surveyed, and the project was estimated; but it was found that the cost of conveying the water into this basin would be so great that it was out of the question.

Attention was then turned to the possible sites where a stone dam might be built right across the river. The southern boundary of Egypt just now is near Wady Halfa, the second cataract. It is no use going to look for sites south of this, for the country is in the hands of the Mahdi and his fierce dervish soldiers. North of this point, unquestionably the best site, perhaps the only possible site is where the Nile valley is traversed by a broad dyke of hard Syenite granite, in passing over which the river forms its first cataract just south of Assouan. It is here divided into several channels between rocky islands, and no channel is deep, so that it would be easy to divert the water from one after another, to lay bare the bed of the river, and lay the foundations of the dam in the open air. It wants no engineer to understand what an advantage this is.

And the great dam, such as was designed by Mr. Willcocks, would have been a work worthy of the land of the Pyramids and Karnak—a great wall of squared granite blocks—82 feet thick at base, of a maximum height of 115 feet, 1½ miles long, pierced by sluices large enough to allow of the whole Nile at highest flood rushing through. The lake formed would have been 120 miles long. Would this not have been a work of some majesty to commemorate for ever the English rule in Egypt—a work one would have been proud to have had a hand in? But it was not to be. The Egyptian saw no objection to it. The money could have been found. But there was an insuperable obstacle created when, on the Island of Philæ, about 250 B.C., Ptolemy II. built a temple to Isis, on the site of older buildings long disappeared. Round this temple other buildings clustered, built by Greeks and Romans. Those of you who have not seen them, are probably familiar from pictures with the group of venerable buildings standing amidst palm trees on the rocky island, and reflected in the waters below.

Had Ptolemy only built his temple on the island of Elephantine, a few miles north, it would have been unaffected by the great dam, but Philæ is just to the south, or up-stream side of where the great dam must necessarily have come, and in consequence the island, with its temples, would be drowned for about six months every year. You probably remember the outburst of rage and indignation which the announcement of this proposed desecration created in London last summer. It was not to be tolerated that England should commit such vanities. In vain it was answered that the place belonged to Egypt, not to England—that the Egyptian, who was to gain so much by the dam, cared absolutely nothing about Ptolemy and his temples—that he was prepared to pay a large price for a great work to benefit his country. What business was it of England to forbid him?

And it was not only the English who were indignant. For once, and only for once, I fear, since we occupied Egypt in 1882, was educated opinion in England and France at one. Both alike insisted that Philæ should not be drowned. Nor must I admit had all the engineers that were interested in the question the full courage of their opinions. While they longed to build the dam, and lamented the perverse fate that had put Philæ there, still they wished to spare Philæ—and their voice has prevailed. The majestic structure has been cut down 27 feet, and now will only be 88 feet high, and Philæ will stand safe and sound in a lake, but will never be drowned.

I personally accept the situation, for I never believed that it would be sacrificed. But yet as an engineer, I must sigh over the lost opportunity for England of making such a splendid reservoir. As I am a friend to Egypt, I sigh still more that the country will not have such a splendid supply of water as would enable Upper Egypt to have the full benefits now possessed by Lower Egypt, and Lower Egypt to expand and flourish.

The reduced scheme will, however, be a great boon to the country, and I trust will now be put in hand without delay.

In 1884, when the expedition up the Nile was first being considered, I was asked by the General Officer commanding in Egypt, whether I thought there was any possibility of the Mahdi diverting the river in the Soudan, and depriving Egypt of its water. The late Sir Samuel Baker was in Cairo at the time, and I consulted him as to whether he knew of any place in the Nile valley where during highest flood the water spills off to the right or left, towards the Red Sea or the Libyan Desert. He said he was sure there was no such place, and I then told the General it would be impossible for the Mahdi to divert the Nile. I was sure that with his savages he would never dam up the low supply until its surface attained the height of flood supply, and if even then during flood there was no spill channel, Egypt was safe enough.

But what the Mahdi could not do, a civilised people could do. A Government official has no business to talk politics, and the Royal Institution is no place for politics; but I may be allowed to point out an evident enough fact, that the civilised possessor of the Upper Nile valley holds Egypt in his grasp.

At this moment the Italians are on the eastern edge of that valley—a nation, I must say, who have been consistently most friendly to us in Egypt. Supposing that they occupied Khartoum, the first thing they would naturally and very properly do would be to spread the waters of the Low Nile over the Soudan; and no nation in Europe understands irrigation so well. And what then would become of Egypt's cotton crops? They could only be secured by a series of the most costly dams over the river, and the fate of Philæ would surely be sealed. But more than this: a civilised nation on the Upper Nile would surely build regular sluices across the outlet of the Victoria Nyanza, and control that great sea as Manchester controls Thirlmere. This would probably be an easy operation. Once done, the Nile supply would be in their hands; and if poor little Egypt had the bad luck to be at war with this people on the upper waters, they might flood them, or cut off their water supply at their pleasure.

Is it not evident, then, that the Nile from the Victoria Nyanza to the Mediterranean should be under one rule? That time is perhaps far off. I conclude what I have to say to-night, by giving you the assurance, and I challenge contradiction, that at no time in the long history of Egypt under Pharaoh or Ptolemy, Roman or Arab, or Turk, have the people of the country been so prosperous, or so justly ruled as during the last nine years.

## OBSERVATIONS OF SUN-SPOT SPECTRA

### I. The Widening of Iron Lines and of Unknown Lines in Relation to the Sun-spot Period.

It is now twenty eight years since I discovered that the lines seen in sun-spots were subject to widening,<sup>1</sup> and that different lines were widened at different times.

It was not, however, till 1879 that I was enabled to commence daily routine work of such a nature that all observations were comparable *inter se*. This desideratum was secured by limiting attention to the twelve lines most widened between F and D.

In 1886<sup>2</sup> I gave an account of some of the early results obtained by this research. I have recently commenced the complete discussion of the whole series of observations to the present year.

This discussion, involving 21,000 lines widened during the period in question, has necessitated three special researches: the first, dealing with the lines with which, contemporaneously, coincidences have been found in the laboratory; the second, dealing with those the origin of which is so far unknown; and the third, with the distribution of both sets of lines in spots in relation to the sun-spot period.

To make the work as definite as possible, I am, in the first instance, confining the inquiry concerning the known lines to lines of iron based upon the examination of the pure electrolytic iron referred to in a previous communication.

<sup>1</sup> A Paper read at the Royal Society, by J. Norman Lockyer, C.B., 1878.

<sup>2</sup> Roy. Soc. Proc. vol. xv. p. 26, 1886.

<sup>3</sup> Roy. Soc. Proc. vol. xl. p. 317.

<sup>4</sup> Roy. Soc. Proc. vol. lvi. p. 311.

The following statistics will show the relation of these iron lines to the Fraunhofer lines in the region F—D over which the spot work extends. In the table, "terrestrial lines" means lines which have been photographically recorded by myself or my assistants in the spectrum of some metal or another during the past twenty-four years; "unknown" means a line not so far traced by me in any metal with the exception of Cerium. This exception is necessitated by the fact that the spectrum of that metal contains practically as many lines as appear in the solar spectrum. The wave length map of Rowland's second series has been taken as a standard.

In the present communication I confine myself to submitting provisional curves based upon a preliminary inquiry into the number of times the lines of both categories have been observed to be widened in spots. Some slight corrections will, doubtless, be ultimately required when a few uncertainties connected with some of the earlier observations, made before Rowland's maps were available, have been cleared up. The highest points of the curves represent the maximum frequency of iron lines in one case and of unknown lines in the other.

The period embraced by the observations practically enables us to study what has taken place at two successive sun-spot minima and two maxima. It will be seen that the phenomena which followed the minimum of 1879 have been exactly reproduced after the minimum of 1890. At the minima the iron lines are prominent among the most widened lines; at the maxima we only find lines about which nothing is known. Since the discussion indicates that the iron lines involved, which ultimately disappear, are almost invariably those seen most prominent in the spark, the view put forward in my paper of 1886 that the change observed is due to the dissociation of iron in the spots as a sun-spot maximum is approached, is corroborated, and, so far, I have heard of no other simple and sufficient explanation.

It will be noted that the maxima and minima of solar temperature thus revealed to us, if my hypothesis be confirmed, lag behind the spot maxima and minima. This may explain the lag observed in those meteorological conditions, the secular changes in which have been held by Balfour Stewart, Broun, Meldrum, Blanford, Chambers, and others, to prove that the disturbances and changes in our own atmosphere are affected by those taking place in the atmosphere of the sun.

VARIATION IN ANIMALS AND PLANTS.<sup>1</sup>

THE importance of variation as a factor in organic evolution is not seriously disputed; but, if one may judge from the expressions contained in recent essays, naturalists are not agreed as to the manner in which variation among individuals is associated with specific modification.

The view originally put forward by Darwin and Wallace is that specific modification is at least generally a gradual process, result-

ing from "the accumulation of innumerable slight variations, each good for the original possessor" ("Origin of Species," chap. xv.). This view rests on the assumption that each of those small differences which are to be observed among a group of individuals belonging to the same species has generally some effect upon the chance of life. "Can we doubt (remembering that many more individuals are born than can possibly survive) that individuals having any advantage, however slight, over others, would have the best chance of surviving and of procreating their kind?" ("Origin of Species," chap. iv.).

Of late years, another view has received support from various writers. An examination of any series of animals of the same species preserved in a museum shows in most cases a large majority of specimens which are superficially alike; those individual differences, upon which stress is laid by Darwin and by Wallace, are often so slight as to escape attention unless minute comparison is made between individual and individual.

<sup>1</sup> A paper read at the Royal Society on February 22, by Prof. W. E. R. Weldon, F. R. S.

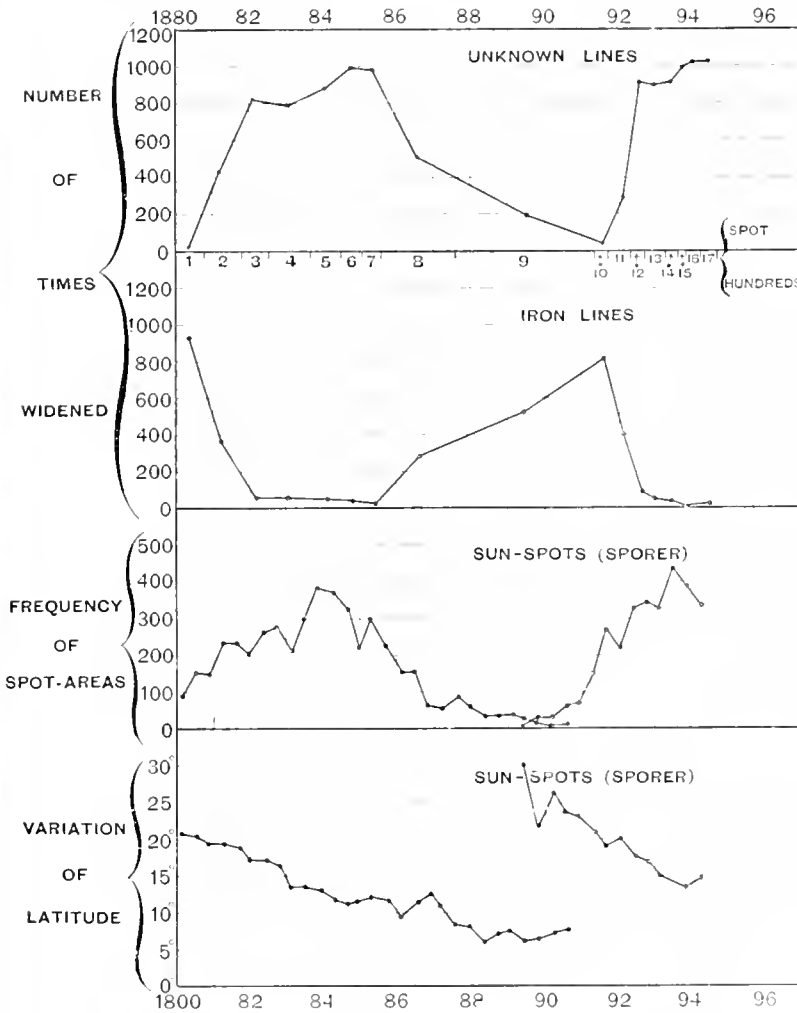

Region.	Fraunhofer lines.	Terrestrial lines.	Unknown lines.	Iron lines.
F				
4861—4900...	92	41	51	16
4900—5000...	175	96	79	45
5000—5100...	228	92	136	33
5100—5200...	176	92	84	39
5200—5300...	165	83	82	32
5300—5400...	211	76	135	29
5400—5500...	216	93	153	26
5500—5600...	186	57	129	31
5600—5700...	149	73	76	29
5700—5800...	198	48	150	22
5800—5895...	208	31	177	5
	2004	752	1252	397

But there will be found only a few in individuals which differ so remarkably from their fellows as to catch the eye at once. Such large deviations differ from the smaller ones, at least in most cases, by their extreme rarity; but they have been extensively collected, and most museums contain numerous examples of their occurrence. Some naturalists have been led, from the striking character of such variations, to assume for them a preponderant share in the modification of specific character. These persons assume, if I understand them rightly, that the advantages or disadvantages which accompany the more frequent slight abnormalities are in themselves of necessity slight; and that the effect of such slight abnormalities may be neglected, in comparison with the effect produced by the occasional appearance of considerable deviations from the normal type. They regard change in specific character as an event which occurs, not slowly and continuously, but occasionally and by steps of considerable magnitude as a consequence of the capricious appearance of "sports."

Without presuming to deny the possible effect of occasional "sports" in exceptional cases, it is the object of the present remarks to discuss the effects of small variations, as it may be deduced from the study of two organs in a single species.

The case chosen is the variation, during growth and in adult life, of two dimensions of female *Callina munda*, recently investigated by a Committee of the Royal Society; and what is here said may be considered an appendix to the report of that Committee.

The questions raised by the Darwinian hypothesis are purely statistical, and the statistical method is the only one at present obvious by which that hypothesis can be experimentally checked.

In order to estimate the effect of small variations upon the chance of survival, in a given species, it is necessary to measure (1st), the percentage of young animals exhibiting this variation; (2nd), the percentage of adults in which it is present. If the percentage of adults exhibiting the variation is less than the percentage of young, then a certain percentage of young animals has either lost the character during growth or has been destroyed. The law of growth having been ascertained, the rate of destruction may be measured; and in this way an estimate of the advantage or disadvantage of a variation may be obtained. In order to estimate the effect of deviations of one organ upon the rest of the body, it is necessary to measure the average character of the rest of the body in individuals with varying magnitude of the given organ; and by the application of Mr. Galton's method of measuring correlation, a simple estimate of this effect may be obtained. In the same way a measure of the effect of parental abnormality upon abnormality of offspring may be numerically measured by the use of Galton's correlation function, and such measurements have been made, in the case of human stature, by Mr. Galton himself.

It is to be observed that numerical data, of the kind here indicated, contain all the information necessary for a knowledge of the direction and rate of evolution. Knowing that a given deviation from the mean character is associated with a greater or less percentage death-rate in the animals possessing it, the importance of such a deviation can be estimated without the necessity of inquiring how that increase or decrease in the death-rate is brought about, so that all ideas of "functional adaptation" are unnecessary. In the same way, a theory of the mechanism of heredity is not necessary in order to measure the abnormality of offspring associated with a given parental abnormality. The importance of such numerical statements, by which the current of the force of adaptation, &c., may be tested, is strongly urged.

The report itself contains an attempt to furnish some of the numerical data, and I do for two dimensions of the more crab. The data cannot give an approximation to the law of frequency with which deviation from the average character occur at various ages. The conclusions drawn are that (1st) there is a period of growth during which the frequency of variations increases, affecting Darwin's statement that variations frequently appear late in life; (2nd) that in one case of preliminary increase it follows by a decrease in the frequency of deviations of given magnitude, in the other case it is not; and that (3rd) assuming a particular law of growth which remains, as is admitted, to be experimentally tested, the observed phenomena imply a selective destruction in the one case, and not in the other.

It is not concluded that the law of frequency at various ages,

adopted in the report, is exact. It is, however, hoped that the approximation is sufficiently exact to give numerical estimates of the quantities measured, which are at least of the same order as the quantities themselves, and for this reason it is hoped that the method adopted may prove useful in other cases.

#### SCIENCE IN THE MAGAZINES.

IN the February number of the *Fortnightly*, Dr. A. R. Wallace discussed in some detail Mr. Bateson's views on variation in relation to the method of organic evolution. He concludes his attack in the current number, and considers Mr. Francis Galton's views, stated in "Natural Inheritance" and in "Thumb and Finger Marks." It is held that the methods of organic evolution favoured by Mr. Bateson and Mr. Galton have failed to establish themselves as having any relation to the actual facts of nature. The reason for their failure is stated by Dr. Wallace as follows:—"they have devoted themselves too exclusively to one set of factors, while overlooking others which are both more general and more fundamental. These are—the enormously rapid multiplication of all organisms during more favourable periods, and the consequent weeding out of all but the fittest in what must be on the whole stationary populations. And, acting in combination with this annual destruction of the less fit, is the periodical elimination under recurrent unfavourable conditions, of such a large proportion of each species as to leave only a small fraction—the very elect of the elect—to continue the race. It is only by keeping the tremendous severity of this inevitable and never-ceasing process of selection always present to our minds, and applying it in detail to each suggested new factor in the process of evolution, that we shall be able to determine what part such factors can take in the production of new species. It is because they have not done this, that the two authors, whose works have been here examined, have so completely failed to make any real advance towards a more complete solution of the problem of the Origin of Species than has been reached by Darwin and his successors."

A story worth repeating here is told by Mr. John Murray, the publisher, in *Good Words*. One day Charles Darwin came to see the late Mr. Murray, and brought with him a MS. As he laid it out on the table, he said, "Mr. Murray, here is a book which has cost me many years of hard labour; the preparation of it has afforded me the greatest interest, but I can hardly hope that it will prove of any interest to the general public. Will you bring it out for me, as you have done my other books?" The book was Darwin's famous work on "Earthworms," which in the course of three months reached a fifth edition. Mr. Murray gives the incident as an illustration of the extreme modesty of a very distinguished man. The same magazine contains some stories of snake-cambalism, by Mr. H. Stewart. A very readable story, in which observations of the planet Mars, and projects of signalling to our ruddy brother, are described, is contributed by Mr. J. Munro to *Cassell's Family Magazine*. Mr. Munro makes the Martian signal to us by means of lights from various incandescent elements, the natures of which are detected spectroscopically. He has a lively imagination, and is fairly accurate in his astronomical references. In the *English Illustrated Magazine*, we notice another of Mr. Grant Allen's "Moorland Myths"—this time on butterflies; and also something about lions, by Mr. Phil Robinson. In the *Strand Magazine*, Mr. J. Holt Schoaling gives a number of ingenious diagrams for graphically representing statistics relating to the population of different countries. There is also the concluding part of an article by Mr. W. G. FitzGerald, on "Some Curiosities of Modern Photography," in which, among other illustrations, occur Prof. Boys' pictures of moving bullets, and a good reproduction of Dr. Roberts' photograph of the nebula in Andromeda. Another article of interest to photographers appears in *Le Monde Moderne* for February, under the title "Les Mouvements de l'Ouvrier." A number of excellent reproductions of some of M. Marey's photographs accompany this article. The same magazine contains a description of compressed air systems of tramway traction.

In addition to the magazines mentioned in the foregoing, the following have been received, but they do not contain any articles of scientific interest:—*Contemporary, Century, Scribner, Chambers', Longman's, Nation's, Sunday Magazine, and Humanitarian*.



## UNIVERSITY AND EDUCATIONAL INTELLIGENCE.

OXFORD.—An examination will be held at Merton College on Tuesday, July 2, 1895, and following days, beginning at 10 a.m., for the purpose of electing to three open Natural Science Scholarships, of which one will be at Merton College, one at New College, and one at Corpus Christi College.

The scholarships are of the value of £80 per annum, and are open to all candidates whose age on July 3, 1895, will not exceed nineteen years. The subjects of examination will be (1) Chemistry, Mechanics and Physics, or (2) Biology. An English essay, and a paper in Algebra and Elementary Geometry, will also be set to all candidates. Candidates will have an opportunity of showing a knowledge of higher mathematics. Candidates who offer Biology are requested to send to the Tutor in Natural Science, Merton College, at least one fortnight before the examination, a general statement as to the portions of the subject which they have studied, and the practical work which they have done. All such candidates will be required to show some acquaintance with Chemistry, Mechanics and Physics.

CAMBRIDGE.—The following is the speech delivered on February 28th by the Public Orator, Dr. Sandys, Fellow and Tutor of St. John's, in presenting for the honorary degree of Doctor in Science Sir William MacGregor, M.D. (Aberdeen), K.C.M.G., Administrator of British New Guinea:—

Orbis terrarum inter insulas, praeter Australiam latissime patet insula Australiae parti septentrionali ex adverso posita. Tota quidem insula insulis Britannicis duplo maior: insulae autem pars a Britannis occupata Angliam ipsam aemulatur. Nostrae vero coloniae ibi administrandae praepositus est vir insignis, olim in Academiae Aberdonensi in medicinae doctor, nuper scientiarum complurium non modo fautor et adiutor, sed etiam ipse auctor atque investigator indefessus. Praesidis nostri auxilio, Anthropologie, Geographiae, Geologiae, aliis denique scientiis nova lux affulsit, adeo ut coloniam illam remotissimam non tam imperii nostri propugnaculum quam scientiarum arcem et castellum longinquum appellaverim. De Caledoniae filiis, quibus ubique terrarum plurimum debet Britannia, nonnumquam dicitur, cum peregre absint, tum demum sese sentire esse domi. Huic Caledoniae filio paullisper reduci facinus hodie idcirco agimus, quod, a patriâ vocatus, non modo imperii nostri in utilitatem, sed etiam scientiae ad fructum, patriam relinquere est dignatus. Gens autem illa antiqua, ex qua ortus esse confitetur, olim sedibus paternis expulsa et ipso nomine prorsus privata, hodie, talium virosum auxilio, non sine nomine, non sine gloria est. Etenim gens illa Alpina, gentem fortissimam a poeta Romano quondam laudatam aemulata,

duris ut illex tonsa bipennibus,  
nigrae feraci frondis in Algido,  
per damna, per caedes, ab ipso  
ducit opes animumque ferro.

Duco ad vos equitem insignem, WILLELMUM MACGREGOR.

The Report of the Syndicate for the encouragement of advanced study and research has just been issued. It proposes that approved graduates of other universities, of not less than twenty-one years of age, should be admitted as Advanced Students, with certain special privileges. Such students are to pursue, under the supervision of committees of the special Boards of Studies, (a) courses of advanced study, or (b) courses of research. The former class may be admitted, after three terms, to a part of a Tripos examination, and if they attain therein a sufficiently high standard, their names will appear in a special list distinct from the Tripos list. After residing two years, they may be admitted to the B.A. degree, and thereafter proceed in the usual course to the M.A. and other higher degrees. Research students are, after three or more terms' residence, to present a dissertation adjudged by a Degree Committee to be "of distinction as an original contribution to learning, or as a record of original research." For this a special "Certificate of Research" is to be granted by the University. Holders of the certificate who have resided at least two years, are to be entitled to the B.A. degree, and to proceed to higher degrees in the ordinary course. Cambridge graduates may, on like terms, obtain the "Certificate of Research." The original proposal to establish new degrees (B.Litt. and B.Sc.) for the class of advanced students, has been dropped; but the possibility of proceeding to the higher degrees of the University is a new feature of importance. The Report is signed by all the twelve members of the Syndicate, including the Vice-Chancellor and

eight professors, representing both the literary and the scientific departments of University study. It will come before the Senate for public discussion during the present term. The main lines of the scheme resemble those of the plan provisionally adopted at Oxford, with the important difference that Oxford has taken up the idea, discarded at Cambridge, of founding special literary and scientific degrees for post-graduate students, and does not propose that they shall be eligible for the degree of Master of Arts.

A University Lectureship in Pure Mathematics will be vacant at the end of the present term, by the resignation of Dr. Forsyth, elected Sadlerian Professor. The lecturer will hold office for five years from Midsummer, 1895. Applications are to be sent to the Vice-Chancellor before Wednesday, April 24, 1895.

An examination for diplomas in Agricultural Science will be held in Cambridge in the week beginning July 1, 1895. The names of candidates are to be sent to the Registry by June 12.

ONE or two of the new provisions in the Revised Code for Elementary Day Schools, presented to the House of Commons last week, are worth noting here. Kindergarten methods of instruction have been recognised in infants' schools for some time, but they have usually ended in the infant school. "Object-lessons and suitable occupations" are now, however, to be counted as class subjects in the lower standards of elementary schools, so that the lessons which are so valuable in training the intelligence of the infant children will be extended. Properly carried out, these natural methods of instruction are of extreme importance in developing such powers of observation and reasoning as young children possess. Another commendable addition which Mr. Acland has introduced into the Code permits visits to be made, during school hours, to museums and art galleries: not more than twenty hours in the school year to be thus employed. Visits to the museums at South Kensington cannot but have a beneficial influence upon the minds of children, and if the guide is competent, they may be made of great value. Perhaps the new feature will lead to the establishment of science museums in towns where none at present exist. It may also assist in the reduction of the brick-and-mortar element (which makes many small museums little more than variety shows), and improve the arrangement and character of the collections.

## SCIENTIFIC SERIALS.

*American Meteorological Journal*, February.—The cause of the cyclones of the temperate latitudes, by W. H. Dines. Two theories have found considerable support: (1) the convectional theory, commonly known as Ferrel's, because he so fully explained it, and showed that cyclones were caused by the convectional ascent of a current of warm air in the central parts, the heat necessary to sustain the current being supplied, at least in part, by the latent heat set free by the condensation of aqueous vapour: (2) the theory proposed by Dr. Hann, who considers that the storms are merely eddies formed in the general easterly drift of the atmosphere in temperate latitudes, just as small whirls are formed in a river. Dr. Hann found that the temperature at high mountain stations in the Alps is higher during anticyclonic conditions than during the passage of storms. Mr. Dines thinks that the evidence is in favour of Ferrel's theory, as mathematical laws show that it is a possible one, and that the latent heat set free by the condensation of moisture will, if it take the form of kinetic energy, be sufficient to produce a most violent storm.—Recent foreign studies of thunderstorms: Russia, by R. De C. Ward. The Imperial Geographical Society of Russia instituted a special study of thunderstorms in 1871, which has been continued until the present time. This service, and others subsequently established, such as that in south-west Russia by Prof. Klossovsky, have led to some valuable results. The district of greatest thunderstorm activity is the Caucasus, then the southern central region. The predominant direction of movement is north-east, and the storms occur most frequently in June and July, the maximum frequency being in the afternoon.—The *Journal* also contains other articles of minor importance, including one on the moon and rainfall, by Prof. H. A. Hazen. The figures for Boston show a remarkable maximum at the day of new moon, and an equally remarkable minimum two days after full moon.

*Journal of the Russian Chemical and Physical Society*, vol. xxvi, parts 2 to 8. Among many valuable papers inserted in this issue, the following are especially worthy of notice: On the synthesis of formation of the amines, by N. Menshutkin.—On the nitration of saturated hydrocarbons with nitric acid, by M. Konovaleff.—On the solubility of various calcium sulphate, by A. Potilitsin.—On the nitration of aromatic hydrocarbons obtained by Friedel's catalyst, by M. Konovaleff.—On the structure of terpenes and similar compounds, by G. Wagner.—On the nitration of unsaturated hydrocarbons, by means of nitric acid, by M. Konovaleff.—On the halogen compounds of nitrogen, by Th. Solovneff.—In the physical part: On the electric resistance of lithium to alternating currents, by A. Salovsky.—On the variation of electrostatic energy, by M. Schiller.—On the variation in length of iron wire during magnetisation, by M. Goussier.—Experiments with alternating currents of high frequency, by N. Senguloff.

Part 2 of the *Journal* contains also, as a supplement, the first number of the *Memoirs (Izvestiya)* of the Central Board of Measures and Weights, which was instituted in 1893, and is placed under P. P. Mendeleeff, who is also the editor of this publication. In this first part we find besides a preface by the editor, several papers of more than local interest, namely:—The measurements made to compare the iron *ray* of the "Committee of the year 1893" with various units of length, accomplished in 1894, by MM. Glukhoff and Zawadzki. The comparison was also made with the bronze and iron yards of Aix.—On the weight of a litre of air, a very elaborate paper by P. P. Mendeleeff, in which some remarks concerning the measurements of Leduc and Lord Rayleigh, and the corrections which should be introduced into their measurements, are especially valuable. The average value arrived at by Prof. Mendeleeff is  $\rho = 0.131844 \pm 0.00010$ .

First list of the standard measures of weight and length at the Central Board, by Th. Zawadzki.—Data for the elaboration of an instruction for verifying the weights and measures in the public establishments.—Preliminary researches into new scales for grain, as a means of determining the quality of the latter, by Th. Selliaeff.

## SOCIETIES AND ACADEMIES.

### LONDON

Royal Society, February 7.—"On the Application of the Kinetic Theory to Dense Gases." By S. H. Burbury, F.R.S. February 14.—"An Instrument for Cutting, Grinding, and Polishing Section plates and Prisms of Mineral or other Crystals in any of the desired direction." By A. E. Tutton, Demonstrator of Chemistry at the Royal College of Science, South Kensington.

In a recent communication *Phil. Trans.* 1894 Series A, p. 1887, the author described an instrument for grinding accurately orientated section-plates and prisms of crystals of artificial preparations. The success of that instrument is so complete that another instrument has been devised and constructed, which enables equally accurately orientated plates or prisms to be prepared from the relatively harder crystals of natural minerals. The instrument is not intended to replace the one previously described, which is fully adapted for all the purposes of chemical crystallography, and the cost of which is only two-thirds that of the one now described. It is intended especially for the use of mineralogists, but, naturally, will serve all the purposes of the smaller instrument. It is constructed upon a scale one-fifth larger than the former one as regards such parts as are fundamentally similar, to confer greater strength. The mode of supporting the crystal is altered one within which the crystal is inserted, the construction of the circle and its axis and fine adjustment, and of the guiding axis and its counter-weights are designed for controlling the pressure between crystal and lap, as also of the traversing axis from which are pendule the crystal and its centering and adjusting movements, are similar in principle to the corresponding arrangements of the smaller instrument, although many details are altered for the sake of greater rigidity. The same likewise applies to the geometrical telecope and collimator and their

mode of support. The main innovations are those of a cutting apparatus, and a large grinding table capable of being readily furnished with any one of nine interchangeable grinding and polishing laps, suitable for use with crystals of every degree of hardness. Four metallic laps are provided, of iron, gun-metal, hard white metal, and pewter respectively, the first for rough grinding with coarse emery and brick oil or water, the second and third for fine grinding with flour emery, and the fourth for polishing with rottenstone and water. A polishing lap of hard felt, for use with putty powder and water, and a lap of box-wood, are supplied. Three glass laps, one coarsely ground, another finely ground, and the third of ordinary polished plate glass, are likewise provided for use with artificial crystals. The cutting apparatus is carried upon a horizontal arm pivoted about the back pillar of the instrument, in order to permit of its removal out of the way during grinding and polishing operations, and further supported when in use upon an adjunct of the right front pillar. It consists of a 4-inch disc of soft iron, supplied with diamond edge, and intended to be lubricated with brick oil, driven by an independent driving gear carried upon the arm. The supporting attachment to the front pillar is removable when not required, and includes a traversing apparatus for directing and controlling the cutting, and a safety back-spring to prevent the possibility of undue pressure being induced between the cutting disc and the crystal by injudiciously rapid rotation of the traversing screw. Instead of actuating the driving gear of the cutting or grinding apparatus by hand, a small electric, gas, or water motor may be employed.

"On the Ratio of the Specific Heats of some Compound Gases." By Dr. J. W. Capstick, Fellow of Trinity College, Cambridge.

The experiments described are a continuation of those of which an account is given in the *Phil. Trans.* vol. clxxxv, p. 1, Kundt's dust-figure method being used, and the ratio of the specific heats corrected for deviation of the gas from Boyle's law. The results are as follows:—

Name.	Formula.	$\gamma$
Methylene chloride.....	CH <sub>2</sub> Cl <sub>2</sub>	1.219
Chloroform .....	CHCl <sub>3</sub>	1.154
Carbon tetrachloride ...	CCl <sub>4</sub>	1.130
Ethylene chloride .....	C <sub>2</sub> H <sub>4</sub> Cl <sub>2</sub>	1.137
Ethylidene chloride.....	C <sub>2</sub> H <sub>4</sub> Cl <sub>2</sub>	1.134
Ethylene .....	C <sub>2</sub> H <sub>4</sub>	1.204
Vinyl bromide .....	C <sub>2</sub> H <sub>3</sub> Br	1.198
Allyl chloride .....	C <sub>3</sub> H <sub>5</sub> Cl	1.137
Allyl bromide .....	C <sub>3</sub> H <sub>5</sub> Br	1.145
Ethyl formate .....	HC <sub>2</sub> OOC <sub>2</sub> H <sub>5</sub>	1.124
Methyl acetate.....	CH <sub>3</sub> COOC <sub>2</sub> H <sub>5</sub>	1.137
Sulphuretted hydrogen	SH <sub>2</sub>	1.340
Carbon dioxide ...	CO <sub>2</sub>	1.308
Carbon disulphide .....	CS <sub>2</sub>	1.239
Silicon tetrachloride ...	CCl <sub>4</sub>	1.129

From these, and the results given in the former paper, it follows that

1. Replacement of one halogen by another in a compound has no effect on  $\gamma$ .
- (2) One H in a paraffin molecule may in some cases (e.g. ethane and propane) be replaced by Cl without altering  $\gamma$ , but a second replacement always causes a fall.
- (3) Carbon and silicon can be interchanged without effect on  $\gamma$ .
- (4) Isomeric compounds have the same  $\gamma$ .
- (5) Using  $\gamma$  to calculate  $\beta$ , the ratio of the rates of increase of intramolecular and translational energy of the molecule on a rise of temperature, we find  $\frac{\beta+1}{\gamma}$  is constant for the paraffins and their monohalogen derivatives, whence it follows that for these the ratio of the increase of mean total energy to the increase of kinetic energy of translation of the molecule is proportional to the number of atoms in the molecule.

\* On some Considerations showing that Maxwell's Theorem of the Equal Partition of Energy among the Degrees of

Freedom of Atoms is not inconsistent with the various Internal Movements exhibited by the Spectra of Gases." By Prof. G. F. Fitzgerald, F.R.S.

It has been generally held that a sufficient freedom of internal motion in an atom to explain the spectra of gases proved that the theorem as to equal partition of energy among all degrees of freedom could not hold, and various suggestions have been made as to why the *proof*, as given by Maxwell, Boltzmann, and others, fails in this case. Prof. Schuster has suggested that the numerous lines need not involve the same number of degrees of freedom, as it is possible that there may be connections between them such that one or two coordinates would define a motion which when analysed into its Fourier components, as is done by a grating or prism, would produce a very complex system of lines. However, even one degree of internal freedom would interfere very seriously with the observed value of the ratio of specific heats, and the object of this note is to explain how this difficulty may be surmounted without supposing that the theorem as to equal partition of energy is untrue, for it is not by any means disproved because a certain form of proof fails in certain cases.

It has been long held that the motion of the electrons on neighbouring atoms is very much controlled by the ether between them. The wave-length of light is generally many times as great as the molecular distances, so that the ether is a practically rigid connector between neighbouring electrons. Suppose now, as a particular example, that  $10^6$  atoms are in this sense, and so far as the motion of electrons is concerned, within one another's control. In this case the motion of these  $10^6$  electrons might be defined by means of, say, three coordinates. Hence, if the atoms were spheres, there would be  $3 \times 10^6$  degrees of freedom plus these three degrees defining the motions of all the electrons. Now, if the total energy be equally distributed among all these degrees of freedom, each atom will only have its share of the electromotions, and its energy of external motion will only be diminished by  $3 \times 10^{-6}$ th part owing to the existence of the internal motion of its electrons. I need hardly say that our methods of calorimetry are by no means sufficiently delicate to detect anything of this kind. There might be a thousand such internal degrees of freedom, and yet the ratio of specific heats would agree with observation.

There is some analogy between this suggestion and the case of a sphere moving in a liquid. The presence of the liquid, although apparently endowed with an infinite number of degrees of freedom, does not really increase the degrees of freedom at all, because its motion is entirely defined by the motion of the sphere. In a somewhat similar manner, I would suggest that at the presence of the million electrons does not sensibly increase the degrees of freedom of motion of the million atoms, as all their motions may be defined in terms of the motion of a few of them. That the ether would so control the motions of electrons seems almost certain from what we know of the rapidity with which electromagnetic actions are transmitted by it, showing how completely it behaves in respect of them as a system of rigid connections.

"Note on the Disease of Cabbages and allied Plants known as 'Finger and Toe,' &c." By George Massee, Royal Gardens, Kew.

The disease known in different parts of Britain as "finger and toe," "clubbing," or "anbury," attacks turnips, rape, cabbages of all varieties, radishes, and, in fact, most cultivated plants belonging to the order *Cruciferae*. Several common weeds are also attacked, namely, charlock (*Brassica sinapistrum*, Boiss.); garlic-mustard (*Sisymbrium alliaria*, Scop.); treacle-mustard (*Erysimum cheiranthoides*, Linn.), and shepherd's purse (*Capsella bursa pastoris*, D.C.). The last-named is reported from the United States by Halsted (New Jersey Agric. Coll. Expt. Station; *Bulletin* 98, 1893), and has not been observed to be diseased in Britain, although one of our commonest weeds. The disease is characterised by the formation of numerous nodules on the root, which becomes much distorted and soon decays, forming a slimy, fetid mass.

Bekeley (*Gard. Chron.*, p. 560, 1856) appears to have been the first to investigate the disease from a scientific standpoint, and although he did not succeed in determining the true cause, distinctly states that microscopic examination revealed the presence of a factor previously unknown in connection with plant diseases. Furthermore, Bekeley pointed out that wood ashes were a cure for the disease, and supposed this to be due to the presence of potash salts in the ash.

Owing to the serious amount of damage caused by "finger and toe" to the cabbage crop in Russia, the Government of that country offered a reward for the discovery of the cause of the disease. Woronin ("Pringsheim's Jahrb.," vol. xi. p. 548, tabs. xxix.-xxxiv., 1878) undertook the investigation, and after years of patient study published an elaborate account, proving clearly that the disease was caused by a minute organism related to the fungi, to which he gave the name *Plasmodiophora brassicae*.

In 1859, Voelcker (*Roy. Agric. Soc. Journ.*, vol. xx. p. 101, 1859) pointed out that the disease was influenced by the amount of lime present in the soil. Where little or no lime existed, as in light and sandy soils, the disease abounded, whereas in soil containing lime the disease was absent. This opinion is corroborated by the same author at a later date (*Op. cit.*, series iii. vol. v. p. 321, 1894).

A series of experiments have been carried out during four successive years at Kew, and they demonstrate the following points:—

(1) That in addition to cultivated plants, several common weeds belonging to the order *Cruciferae* are attacked by the *Plasmodiophora*. Hence the necessity for preventing the growth of such weeds in fields and hedge-banks.

(2) That the germs of disease are present in soil that has produced a diseased crop, and retain their vitality for at least two years.

(3) That the development of *Plasmodiophora* is favoured by the presence of acids, and checked by the presence of alkalies, agreeing in this respect with the fungi rather than with bacteria.

(4) For the purpose of sterilising infected soil, experiments prove that either a dressing of lime or a manure containing potash salts is effective, the last being most valuable, as it not only destroys the germs in the soil but also arrests the disease in seedling plants, and at the same time supplies one of the ingredients necessary for the healthy growth of turnips.

February 21.—"Iron and Steel at Welding Temperatures." By T. Wrightson.

The object of this paper was to demonstrate that the phenomenon of welding in iron is identical with that of regelation in ice.

The author recapitulated experiments made by him in 1879-80, described in the *Proceedings* of the Iron and Steel Institute for those years. These experiments were upon cast iron, and proved that this form of iron possessed the property of expanding while passing from the liquid to the plastic state during a small range of temperature, and then contracting to the solid state, and that the expansion amounted to about 6 per cent. in volume. This property of iron resembles the similar property of water in freezing, which, within a range of about 4° C., expands about 9 per cent. of its liquid volume, and then contracts as the cooling proceeds.

This property of water was investigated by Prof. James Thomson and by Lord Kelvin. The former showed that from theoretical considerations there was reason to expect that in the case of a body exhibiting the anomalous property of expanding when cooled and contracting when heated, it should be cooled instead of heated by pressure or impact. Lord Kelvin investigated the problem experimentally as affecting freezing water, and completely demonstrated the truth of his brother's reasoning.

The experiments made by the author in 1879 and 1880 suggested the view that this property of ice was connected with the property of welding in iron, but this was only hypothetical, as the experiments had been made on cast iron, which probably, on account of the presence of carbon, does not possess the property of welding. Further, it was not practicable to experiment with wrought iron in the same way as with cast iron on account of the difficulty of dealing with that substance in its liquid form. Prof. Roberts-Austen has, however, given metallurgical research a recording pyrometer, and this has enabled the author to resume the investigation at the Mint. The method adopted was the heating of bars in an electric welder, and as soon as the junction of the bars was at a welding temperature, end pressure was applied by mechanical power, and the weld effected.

Observations show that a molecular lowering of temperature took place inmediately the pressure was applied to the bar when in the welding condition.

The fall in temperature varied from 57° C. to 19° C., according to the circumstances of temperature and pressure.

The experiments appear to prove that wrought iron at a welding temperature possesses the same property of cooling under pressure which was proved by Lord Kelvin to exist in freezing water, and on which demonstration the generally received theory of regelation depends.

The author distinguishes the process of melting together of metals from that of welding. Either process forms a junction, but the latter takes place at a temperature considerably below the melting point.

The well-known and useful property of welding in iron appears, therefore, to depend, as in the case of regelation in ice, upon this critical condition, which exists over a limited range of temperature between the molten and the plastic state.

"Note on the Spectrum of Argon." By H. F. Newall.

In the course of a spectroscopic investigation in which the author has been for some time past engaged, a line spectrum, which so far as he was able to make out was unknown, had frequently presented itself upon his photographs. It appeared in May and June, 1894, under conditions which led him to call it, for the sake of convenience, "the low-pressure spectrum." It now appears that the lines are argon lines.

The argon of which the spectrum was observed was obtained from air, from which nitrogen was eliminated by passing electric discharge through it in presence of hydrogen or moisture and acid. Seventy-two lines in the author's "low-pressure spectrum" had their wave lengths given in the paper, and side by side were given the measurements of the wave-lengths determined by Mr. Crookes for the argon lines.

The agreement of the measurements shows conclusively that the same spectrum was observed. The agreement of grouping and intensity, also, leaves no doubt as to the identity of the two spectra.

The experiments were repeated, with slight variations, several times with results which, so far as the spectrum of argon is concerned, were constant. But it was noted that continued passage of the discharge appears to result in the attaining of a certain minimum pressure, after which there is slight and slow rise to a tolerably-fixed pressure.

It is interesting to find argon asserting itself, unsolicited, in quite new circumstances, and under conditions which practically constitute one more mode of separating argon from nitrogen—namely, the getting rid of nitrogen by passing electric discharge through it in the presence of hydrogen or moisture and acid.

February 28.—"The Effect of Environment on the Development of Lichnoderma Larvæ: an Experimental Inquiry into the Causes of Variation." By H. M. Vernon (from the Zoological Station, Naples).

The conditions of environment under which an organism develops are known to be of considerable influence in the production of variations. It was thought to be of interest to determine by exact measurement the effects which such slight changes in the environmental conditions as might occur naturally would produce in the growth of some organisms. The animal chosen was the larva or pluteus of the sea-moth *Stomatopoda larva*. These larvæ develop readily from artificial fertilisations, and they can, moreover, be obtained at all times of the year, irrespective of season. In all 10,000 larvæ were measured.

The effects of temperature on development were first studied. It was found that if the ova were placed in water at about 8° or 25° C. for an hour, or even for a minute, at the time of impregnation, the resulting larvæ after eight days development were, on an average, 40 per cent. smaller than those impregnated at from 17° to 22°, though all the subsequent conditions of development were identical. If kept at the abnormal temperature for only ten seconds during impregnation, the resulting larvæ were only 17 per cent. smaller.

The time of the year when the artificial fertilisations were prepared has a very marked influence on the size of the larvæ. Thus, those obtained in the month of August are about 20 per cent. smaller than those obtained in April, May, and October, while those obtained in June and July are intermediate in size.

The salinity of the water has had a great influence on the development.

The effects which the various colours of the spectrum have upon the development were also determined, though these are not conditions of environment which occur in nature. The development of the larva seems to be but little affected if it is

carried out in absolute darkness, the size only being diminished by 13 per cent. Larvæ grown in semi darkness are apparently 25 per cent. larger than the normal.

The body-length of the larvæ appears to be uninfluenced by the number of larvæ developing together in a given volume of water, if it be kept below 30,000 per litre. The arm-lengths are, on the other hand, considerably affected.

Certain products of metabolism exert a favourable influence on the developments of the larvæ, and not, as would be naturally expected, a harmful one.

As the number of measurements made was so large, it was thought to be of interest to subject them to statistical examination. It was found that with the body-length and oral arm-length measurements the deviations from the average occurred with a frequency indicated by the theoretical law of error. The measurements of the aboral arm-length did not agree so well, possibly owing to dimorphism.

Physical Society, February 22.—Captain Abney, F.R.S., President, in the chair.—An abstract of Mr. G. H. Bryan's paper, on the mechanical analogue of thermal equilibrium between bodies in contact, was read by Mr. Elster. After commenting on the difficulty in applying the kinetic theory of gases to the case of two substances in contact which do not mix, the author goes on to describe a system by which the phenomena of thermal equilibrium unaccompanied by diffusion can be explained. The two substances are represented by two sets of molecules designated by P and Q. Two parallel planes A and B, at a small distance apart, are imagined to divide space in three parts. Plane A (to the left of B) is supposed to be permeable to the P molecules, but to repel the Q molecules, whilst B is permeable to the Q set of molecules, and repels the P set. The spaces to the left of A and to the right of B are thus entirely occupied by the P and Q molecules respectively. Between the planes both P and Q molecules exist, and therefore have opportunities of colliding with one another and transferring energy from one gas to the other. Using generalised coordinates, it is shown by Boltzmann's method that when equilibrium is attained the mean kinetic energies of translation of the two kinds of molecules are equal, just as in the case of molecules which mix. Instead of assuming the planes A and B to repel the Q and P molecules respectively, the P molecules may be assumed to be positively electrified, and the Q ones negatively electrified, whilst the planes A and B are maintained at a constant difference of potential. The difference of potential thus assumed is analogous to "contact E.M.F.," whose existence is proved by experiment. The communication concludes with a development of Prof. Boltzmann's paper on the application of the determinantal relation to the kinetic theory of polyatomic gases, read before the British Association at Oxford. Dr. Stoney thought the arguments were based on actions depending on the distances of the molecules, and the supposition that they were rigid. In his opinion events occur in nature which are not represented by this simple theory, and great reservation should be shown in accepting dynamical problems which leave out of account actions occurring between matter and the ether. In nature nothing was large and nothing was small except relatively. Even molecules might possess infinite detail of structure. Their interaction with the ether must be considered in an complete theory.—Mr. G. U. Yule's paper on a new harmonic analyser, and one by Mr. H. N. Allen, on the electromagnetism field, were postponed.

Chemical Society, February 21.—Dr. Armstrong, President, in the chair.—The following papers were read:—The electromotive force of an iodine cell, by A. P. Laurie. The E.M.F. of a cell consisting of a zinc and platinum plate immersed in iodine dissolved in potassium iodide solution is constant, but is the smaller as the iodine solution is the more dilute; the effect of varying the constituents of the cell on the E.M.F. has been investigated.—Contributions to the chemistry of cellulose, by C. E. Cross, E. J. Bevan, and C. Beadle. The melting points of mixtures, by H. Crompton and Miss M. J. Whalley. When a solution deposits the pure solvent on cooling, the relation  $\log \frac{p}{100} = \frac{T - T_1}{T_1}$  holds;  $\rho$  is the number of molecules of solvent per molecule of solution,  $p$  is the molal latent heat of fusion of the solvent, and  $T$  and  $T_1$  the melting-points of the solvent and the solution respectively.—The volumetric determination of manganese, by J. Reddrop and I.

Ramage. Schneider's process for the determination of manganese may be rendered much more accurate by substituting sodium bismuthate for bismuth peroxide.—Bromocamphoric acid, an oxidation product of  $\pi$ -dibromocamphor, by F. S. Kipping. A bromocamphoric acid is obtained by oxidising  $\pi$ -dibromocamphor; its anhydride has been prepared together with a new hydroxy-acid and a nitrobromocamphor.—Note on the action of diastase on cold starch-paste, by H. T. Brown and G. H. Morris.—On the magnetic rotation of some unsaturated hydrocarbons, by W. H. Perkin. The magnetic rotations of a number of unsaturated open-chain hydrocarbons have been determined; a comparison of hexane, hexylene, diallyl, and dipropargyl shows that the differences between the latter pair are of a different order to those of the former pair.

**Linnean Society, February 7.**—Mr. C. B. Clarke, F.R.S., President, in the chair.—Mr. Thomas Christy exhibited a dried specimen of *Apllojappus Llaletis* and samples of the so-called Gum Kino, *Pterocarpus crinaeus*, of which some account was given by Mr. E. M. Holmes. Mr. George Murray exhibited a number of lantern slides of floating *Alga*, of which he gave brief descriptions referring to the localities in which they had been found and the literature relating to them.—By permission of the Director of the Royal Gardens, Kew, Mr. W. B. Hemslay exhibited dried specimens of a number of new plants from Eastern Asia. Conspicuous amongst these was a new genus of *Scitamineae* from the mountains of Northern Siam, characterised by having minute unisexual flowers destitute of stamens, a one-celled ovary with parietal placentation, and two filiform stylodia; a remarkably broad-leaved *Lysimachia* from the same region; new species of *Hypericum*, *Ventilago*, *Mesona*, and *Helicia* from Formosa; and a new genus of *Cyrtandrea*. From a collection made in Yunan, Western China, by Mr. W. Hancock, of Hong Kong, came a new *Jasminum*, allied to *J. nudiflorum*, with primrose yellow flowers an inch and a half in diameter; an elegant species of *Petrocosmea* (*Cyrtandrea*), and a showy *Branthia* (*Scrophulariaceae*) with long racemes of crimson flowers, which were much admired.—Mr. Thomas Hanbury exhibited a beautiful collection of fresh fruits of the *Aurantieae* grown in his own garden at La Mortola, Mentone, and gave an account of some of the more remarkable varieties, their mode of growth, and the conditions under which they had been grown.—A paper was then read by Mr. H. M. Bernard, on the comparative morphology of the *Galeodidae*. Having described a possible origin for the Crustacea from a chætopod annelid by an adaptation of the anterior segments to a method of feeding, whereby the parapodia would function as jaws, the author attempted the same for the Arachnida with a view to solve the question of their relationship with the Merostomata. The *Galeodidae* were chosen for special study because, unlike other arachnids, they have retained some segments of the cephalothorax as free movable segments, and hence might be expected to throw light on the subject. The author believed that he had solved the question of the primitive specialisation of the arachnid phylum from their annelidan ancestors, and expressed the opinion that as arthropods they are not related either to the Crustacea (including *Limulus*) nor to the Hexapoda; but that all these are distinct derivations of the Annelida. In an interesting discussion which followed, the paper was criticised at some length by Mr. A. D. Michael, Prof. Howes, and Mr. R. I. Pocock.

## PARIS.

**Academy of Sciences, February 25.**—M. Lowy in the chair.—On the penetration of a projectile in semi-fluids and solids, by M. H. Resal.—On a class of equations of which the general integral is uniform, by M. Emile Picard.—On the measurement of time in astronomy by a method independent of personal equation, by M. G. Lippmann. The author employs a photographic method. A platinum wire is rendered incandescent for a very short time at the commencement of each second by mechanical means. The light from the wire is, by the aid of arrangements described, thrown on to a photographic plate in such a way that the image formed corresponds precisely with the meridian of the place of observation. By suitable exposure a photograph is obtained of a portion of the heavens on the same plate. The time of transit of a given star can then be easily deduced from the hourly circles photographed as above. M. d'Abbadie remarked with reference to an alternative micrometric method proposed by M. Lippmann, that Bre-

guet had used a moving wire grating for measurement of the same quantities fifty years previously.—On the mutual relations of potential determinants, by M. de Jonquieres.—Ebullioscopic study of certain colouring matters from triphenylmethane, by MM. A. Haller and P. Th. Muller. The conclusion is drawn that, under the given experimental conditions, the hydrochlorides of the colouring substances of the triphenylmethane amido group are not dissociated, whereas the chlorides of ammonium bases and nitrosodimethylaniline hydrochloride are most clearly dissociated. Hence an argument may be drawn in favour of formulae of the type of  $C_{10}H_7(C_6H_4NH_2)_3$ , due to M. Rosenstiehl.—M. Sappey gave a short description of the "Atlas of Descriptive Anatomy," presented by M. Laskowski.—The Academy elected M. Weierstrass as foreign associate, the votes given being: M. Weierstrass 43, Prof. Frankland 1, Prof. Huxley 1.—A closed communication from M. E. Carvallo, accepted May 2, 1892, was opened. It gave the theory of the laws of crystalline absorption. For uniaxial crystals these are: (1) For the ordinary ray, the index of refraction and the coefficient of absorption are constant, whatever may be the angle between the luminous ray and the crystallographic axis. (2) The law of the index of the extraordinary ray is not altered sensibly by absorption. (3) The absorption of the extraordinary ray is represented by the formula

$$\frac{k}{n^3} = \frac{k}{n^3} \cos^2 \theta + \frac{k}{n^3} \sin^2 \theta,$$

where  $k$ ,  $n$ ,  $\theta$  represent the coefficient of absorption, the index of refraction, and the angle between the normal to the plane of the wave and the crystallographic axis. A memoir will shortly be brought out dealing with these results and their developments.—M. L. L. de Koninck claims priority for the properties of nickel and cobalt sulphides.—Spectrum researches on the rotation and movements of the planets, by M. H. Deslandres. (See "Our Astronomical Column.")—Observations on the subject of the preceding communication by M. Deslandres, by M. H. Poincaré. The theoretical views which have been confirmed by the foregoing results.—Determination of the position of the pole by photography, by M. C. Flammarion. By exposure of a fixed plate, circular traces of the circumpolar stars are obtained as shown in the figure given with the paper. Hence the position of the pole can be obtained with great accuracy.—On a surface of the sixth order which is connected with Kummer's surface, by M. G. Humbert.—On functional equations, by M. Léan.—On the exact invariants of an ordinary differential equation of the second order, by M. Tresse.—On some theorems of Arithology, by M. N. Bougaief.—Lowering of the freezing point and relative diminution of vapour pressure in dilute solutions, by M. A. Ponsot. The author deduces formulæ differing somewhat from those given by Wüller and Raoult, and agreeing with those of van 't Hoff and Duham, with the exception that a different meaning is given to one of the terms.—On the lowering of the freezing point of very dilute solutions, by M. A. Leduc. The author proposes the substitution of the measurement of a considerable pressure for a small temperature difference. A theoretical demonstration.—On a sensitive pressometer, for the measurement of fluid pressures, by M. Paul Charpentier.—The measurement of the intensity of light by the chemical action produced; experiments with mixtures of ferric chloride and oxalic acid, by M. Georges Lemoine.—On some combinations of lead iodide with other metallic or organic iodides, by M. A. Mosnier. A number of new double salts have been obtained and their composition determined.—On some combinations of nitric oxide with the chlorides of iron, by M. V. Thomas. The substances: (1)  $Fe_2Cl_6 \cdot NO$ , (2)  $2Fe_2Cl_6 \cdot NO$ , (3)  $FeCl_3 \cdot NO \cdot 2H_2O$ , and (4)  $FeCl_2 \cdot NO$ , have been obtained and their composition determined by analysis.—Action of formaldehyde on hydroxylamine hydrochloride and on methylamine hydrochloride, by MM. A. Brochet and R. Cambier.—Active amyl ethereal salts, by MM. Ph. A. Guye and L. Chavanne. A paper on the product of asymmetry.—New researches on the correlative variations of the intensity of thermogenesis and respiratory changes, by M. Laulanié.—"Autenarose carbonio-actonemique," or winter sleep of the marmot, by M. Raphaël Dubois.—On the *Rhinotrampa bisittatum*, Cuvier, by M. Léon Vaillant.—Evolution of the nervous system and of the vibratile organ in the larvæ of compound a-cidians, by M. Antoine Pizon.—On the rôle of Amœbocytes in the Annelids, by Emile G. Racovitza. Amœbocytes serve not only to deposit

ever, it is not in the epidermis, but when necessary, ...

DIARY OF SOCIETIES.

LONDON.

THURSDAY, MARCH 7.

ROYAL INSTITUTION, at 4.—The Rocks of Burma and Allied Minerals; ...

FRIDAY, MARCH 8.

ROYAL INSTITUTION, at 4.—Physical W. P. of Von Helmholtz; ...

SATURDAY, MARCH 9.

ROYAL INSTITUTION, at 4.—Waves and Vibrations; ...

SUNDAY, MARCH 10.

ROYAL BOTANIC SOCIETY, at 4.—Notes on the Remains of ...

MONDAY, MARCH 11.

ROYAL BOTANIC SOCIETY, at 4.—Three Years' Travelling and ...

TUESDAY, MARCH 12.

ROYAL INSTITUTION, at 4.—Internal Framework of Plants and Animals; ...

WEDNESDAY, MARCH 13.

ROYAL INSTITUTION, at 4.—The Diseases of Fishes and ...

THURSDAY, MARCH 14.

ROYAL INSTITUTION, at 4.—The Diseases of Fishes and ...

FRIDAY, MARCH 15. ROYAL INSTITUTION, at 4.—The Rarer Metals and their Alloys; ...

SATURDAY, MARCH 16. ROYAL INSTITUTION, at 4.—Waves and Vibrations; ...

BOOKS, PAMPHLETS, and SERIALS RECEIVED.

Books.—Elements of Pathological Histology; Dr. A. Weichselbaum, translated by Dr. W. R. Dawson (Longmans).—Le Léman: F. A. Forel, tome second (Lausanne, Rouge).—Everybody's Pocket Lawyer (Saxon).—A Treatise on Elementary Trigonometry, Dr. J. Casey, new edition (Dublin, Hodges).—Appareils Accessoires des Chaudières à Vapeur; Dubouché and Créneau (Paris, Gauthier-Villars).—Tanté des Bicycles et Bicyclettes, C. Bourlet (Paris, Gauthier-Villars).—Cone Sections, Dr. W. H. Besant, 5th edition (Bell).—Organic Chemistry—the Fatty Compounds; R. L. Whitley (Longmans).—Smithsonian Geographical Tables; R. S. Woodward (Washington).—Les Aurores Polaires, A. Angot (Paris, Alcan).—My Weather-wise Companion, B. T. (Blackwood).—The Fauna of British India, including Ceylon and Burma—Moths; G. F. Hampson, Vol. 1, Taylor and Francis).—Pamphlets.—Index to the Literature of Didymium, 1842-1893 (Washington).—Report of the Smithonian Institution, for the Year ending June 30, 1894 (Washington).—Report on the Operations of the Department of Land Records and Agriculture, Madras Presidency, for the Official Year 1893-94 (Madras).—Zwei Neue Paradiesvögel, A. B. Meyer (Berlin, Friedländer).—Serials.—Natural Science, March (Kau).—Casell's Magazine, March (Cass).—Contemporary Review, March (Hobster).—Humanitarian, March (Hutchinson).—Bulletin de la Academie Royale des Sciences, &c., de Belgique, 1895, Année 57, tome 22, No. 1 (Bruxelles).—Zeitschrift für Physikalische Chemie, xvi, Band, 4 Heft (Leipzig, Engelmann).—Scribner's Magazine, March (Low).—Zeitschrift für Naturwissenschaften, 66 Band, 1 and 6 Heft, 67 Band, 1 to 5 Heft (Leipzig, Pfeiffer).—National Review, March (Arnold).

CONTENTS.

Table with 2 columns: Title and Page. Includes 'The Ancestry of the Vertebrates', 'A Cyclopædia of Names', 'Our Book Shelf', 'Letters to the Editor', 'Our Astronomical Column', and 'Books, Pamphlets, and Serials Received'.

THURSDAY, MARCH 14, 1895.

*THE LIFE OF DEAN BUCKLAND.*

*The Life and Correspondence of William Buckland, D.D., F.R.S.* By his Daughter, Mrs. Gordon. (London: John Murray, 1894.)

IN the early decades of this century Geology had not established for itself an acknowledged place in the circle of the natural sciences. With as yet no settled philosophical basis, it offered a boundless field for indulgence in the wildest conjectures and the boldest speculation. Its votaries were, therefore, hardly regarded as serious students by the scientific men of the day. On the other hand, they incurred much popular odium. They had drawn such strange and almost incredible pictures of what they averred to have been the past history of the earth, so utterly at variance with all accepted beliefs, that they were looked upon with suspicion by some, sneered at by others, while by a large body of blatant opponents they were openly denounced as freethinkers, who, under the guise of natural science, aimed at the subversion of all religion. It needed some courage to be a geologist in those days, and still more to be a champion of the new inquiry.

Among the most prominent and effective of those who stood in the front of the battle and fought the hard fight was William Buckland. No man did more than he to raise geology from its depressed beginnings to the dignity of a definite branch of natural knowledge. And his name will ever be remembered with gratitude and affection as that of one of the clear-eyed, large-hearted fathers of English geology. This proud position he gained by a two-fold claim. The amount, the wide range and the intrinsic value of his original contributions to the science would have been enough to place him in the front rank of the leaders in that heroic age of geological discovery. But it was not merely, perhaps not even chiefly, by these qualifications, admirable as they were, that he attained to his unquestioned pre-eminence among his contemporaries. It was rather the unique personality of the man which gave him his remarkable influence, irresistibly engaging the sympathies and admiration of all who came in contact with him, bearing down gently but firmly all opposition, and gaining for him the affectionate esteem even of those from whom he differed.

His solid work remains and can be examined and weighed, and its influence on the progress of his favourite science can be accurately determined. But that personal sway passed away with him who wielded it, and is now only a memory. It has not yet been adequately pictured for the comprehension of those who never felt it, or who coming after have only heard feeble narratives of it, together, perhaps, with some of the many quaint stories still in circulation that illustrate it. At the time of his death numerous appreciative obituary notices of him appeared, some of them by personal friends who knew him well, and mourned the loss of so much that was bright, inspiring and lovable. Some pleasant recollections of him by his son Frank were published in the

last edition of Buckland's famous Bridgewater Treatise. But some more detailed biography might have been expected. He was a ready and copious correspondent, and it might have been supposed that abundant material must remain to furnish a picture of the man himself in his daily life, in his family, in his lecture-room, in his warm discussions with his friends, in his rambles with his students, in his intercourse with farmers and masons and labourers, and in his correspondence with many of the most interesting men of his time.

It was therefore with no little expectation that we received the volume of which the title is placed at the head of this notice. We have read it with interest and pleasure, and yet, it must be frankly confessed, with some measure of disappointment. Mrs. Gordon deserves the thanks of all lovers of science for the filial devotion and affectionate enthusiasm with which she has prepared this memoir of her father. We rise, indeed, from the perusal of the book with a somewhat fuller knowledge of Buckland's career, and with a little more insight into that personality which gave him his charm and his influence. But the information is neither of the kind nor of the amount which might have been looked for from the title of the volume.

Nearly half a century has passed since Buckland was stricken down by the malady which removed him from active life, and after some eight years of sad seclusion carried him to his grave. There can be few alive now who remember him in his prime, and from whom reminiscences of the man could be obtained. Mrs. Gordon appears to have done her best to procure such records from surviving friends, and she has received several of much interest. But it was from his own letters and jottings that most of real importance was to be looked for. The "correspondence," however, which appears on the title-page, forms but an insignificant part of the book. Long extracts are given from his lectures, his addresses and his sermons. Those who want to know more of the man himself would gladly exchange these citations for the brief notes and the longer epistles, in which he continually unbosomed himself and told so graphically what he was doing and thinking about from day to day. That Mrs. Gordon has made such comparatively slight use of such material must mean, we fear, that she has not been able to recover it. In that case we must sympathise with her disappointment. The task, perhaps, has been too long delayed.

In looking over the nature and amount of the work done by Buckland during his busy life, one is astonished at the great extent of subjects which claimed his attention, and in which he laboured and wrote. At one time he is absorbed in the study of changes of topography, whether it be the valleys of the south of England, or the solution of the chalk, or the destruction of the coast by landslips, or the sculpturing of the Highlands and of Wales by glaciers. At other times, or even when he had some of these topographical questions in hand, we find him hard at work upon problems in tectonic geology—British or foreign—the structure of the Alps, the geology of Nice, our south-western coal-fields, or the coast of Dorset. But undoubtedly it was the paleontolo-

logical side of geology that most fascinated him. And what a mass of observations he accumulated in that department of the science! Every grade of the animal kingdom had an interest for him. He was passionately devoted to living animals, and he made use of his knowledge of them and their ways in interpreting the remains of their remote ancestors imbedded in the geological formations. He would take endless trouble to satisfy himself as to the habits of some living animal, in the hope of thereby throwing light on the history of extinct forms. Witness, for example, his rapid journey to the Pentland Hills in Midlothian, for the purpose of examining the drained bed of a large reservoir, where he expected to find materials for elucidating the history of old lacustrine limestones.

In those days geology had not become a science of detail. There were new fields to be cultivated on every side, and Buckland was the first to enter some of these. His researches in caves opened up a fresh chapter in geological history. And his chivalrous support of Agassiz, in the face of much ridicule, when he announced the former existence of glaciers in Britain, must be recognised by all glacialists as one of the first steps which led to the recognition and cultivation of glacial geology in this country.

There was ever in Buckland's science a strong vein of practical common sense. He was imaginative beyond most of his compeers, and sometimes, perhaps, allowed his imagination too free a rein, but he never lost sight of the fact that geology has a very definite practical side, and may be turned to useful account in many of the affairs of daily life. He was an active farmer, in order that he might try various methods for the improvement of crops. To him we owe the introduction of coprolites, so valuable a source of artificial manures. He never lost an opportunity of preaching the true principles of drainage, and he insisted on the value of geological knowledge in all questions of water-supply. These are familiar enough applications of the science now, but it was largely through Buckland's influence that they were recognised.

Of the man himself as he lived and moved, Mrs. Gordon's volume gives a pleasing though hardly adequate picture. His boundless energy and enthusiasm were infectious, and led many a man and woman captive into the geological fold. His industry enabled him to carry on a busy scientific life, while at the same time he had on hand enough of other work to fill up fully the time of most men. His wide sympathies and large range of knowledge broadened his grasp of his own special science, and led him to see where he could find the most useful collateral information. His eloquence as a speaker and writer commanded the attention of his audiences, and did much to make his subject popular. His unwearied hospitality and his generous large-heartedness opened a way for him into the hearts of men, while his overflowing vivacity, his brilliant wit, and his racy talk made him the central figure in any company where he might happen to be. Truly there were giants in the land in those days, and no one of them deserves to be more warmly remembered for all that he did, and all that he was, than William Buckland.

[NO. 1324, VOL. 51]

#### OUR BOOK SHELF.

*The Birds of Eastern Pennsylvania and New Jersey.*  
Edited by Witmer Stone. Pp. 185. (Philadelphia :  
Delaware Valley Ornithological Club, 1894.)

THE Delaware Valley Ornithological Club has only been established about five years, but steps were taken shortly after its organisation to compile a list of the birds observed by the members in the vicinity of Philadelphia. In this volume the important results of the club's ornithological investigations are brought together in a compact form by the committee of three—Messrs. Morris, Rhoads, and Stone—appointed to prepare the work. A list of the birds to be found in the Delaware Valley and along the New Jersey sea-coast has naturally a limited sphere of usefulness, even though it may furnish a work of reference for ornithologists in general. But this volume contains not only an annotated list of the birds of the district to which it refers, and a bibliography of ornithological literature relating to Pennsylvania and New Jersey; it comprises, in addition, outlines of the knowledge of the geographical distribution and migration of birds, thus giving it increased value. These chapters

April 1891.

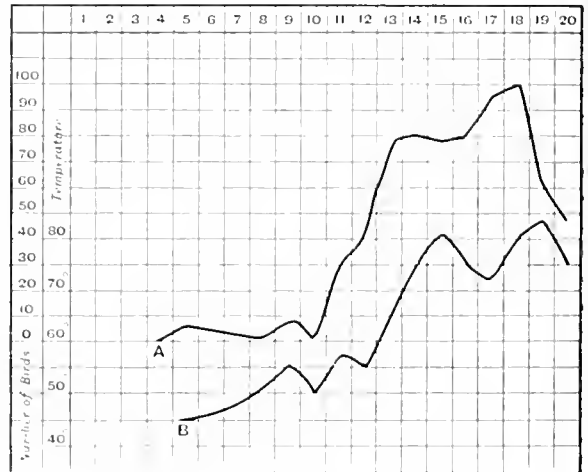

FIG. 1.—A, Migration Curve; T, Temperature Curve.

will lead beginners in the study of birds to understand the importance of simple observations.

The influence of meteorological conditions upon the migration of birds is an important point, and one which requires careful investigation. The records of the club's observers furnish some valuable facts for the study of migratory waves or rushes, and their relation to meteorology. It is pointed out that, during migrations, the flight of birds is not uniform, but is made up of a series of waves or rushes and rests or lulls. The relation of these rushes to temperature is well shown in the accompanying diagram, reproduced from the volume. The curve A represents graphically the fluctuation of the April migration of 1891, based upon observations of the Flicker, Chipping Sparrow, and Brown Thrasher; the curve B shows the temperature variation during the month of observation, based upon the daily maximum temperature. The connection between the two curves is very distinct, and it is especially interesting to observe that the "bird waves" occurred a day or two after a decided increase of temperature.

In conclusion, we think the Delaware Valley Ornithological Club is to be congratulated upon its activity, and Mr. Stone for this admirable addition to the literature on the birds of Eastern Pennsylvania.



*Conspectus Floræ Africæ, ou Enumération des Plantes d'Afrique* Par Th. Durand et Hans Schinz. Vol. v. Monocotyledonæ et Gymnospermæ. Svo. Pp. 977. (Bruxelles, 1895)

IT may, perhaps, be asked why the fifth volume of a work should appear before the fourth and all the preceding ones. Doubtless the authors were influenced thereto by the fact that neither Oliver's "Flora of Tropical Africa," nor Harvey's "Flora Capensis," has reached the groups enumerated in the bulky volume under notice. Certainly this course has the advantage of utility, and will be of great service in the elaboration of the continuation of the works named. As an index to the scattered literature of the subject, the present volume is indeed invaluable. It covers all that may be called African, including the Atlantic islands from Madeira to Tristan d'Acunha, and the islands of the Indian Ocean, from St. Paul and Amsterdam to Mauritius, Madagascar, and Socotra. It is true, the geography of the plants is not worked out all through so fully as Mr. C. B. Clarke has done the Cyperacæ. For instance, the characteristic grass of Tristan d'Acunha and St. Paul and Amsterdam islands, *Spartina arundinacea*, is only recorded from the former group. In other respects, Mr. Clarke's elaboration of the 800 Cyperacæ is by far the most complete and thorough part of the volume, though it is blemished by the introduction of a very large number of names of new species without descriptions.

But, leaving all criticism out, this volume will be welcomed alike by horticulturists and botanists; by the former, more especially, because it contains the petaloid monocots, so numerous in South Africa. Synonyms and references to figures in the various illustrated serials add to the usefulness of the enumeration. To give an idea of the extent of this compilation, it may be mentioned that the Liliacæ include nearly 1100 species, belonging to 67 genera. *Aloe* alone numbers nearly 100 species. The Iridæ are about 700 strong; *Gladiolus* being the largest genus, with 143 species. Orchids also exceed 1000 species, belonging to 74 genera; and 160 species of *Habenaria* are enumerated. Palms are less numerous than might have been expected, considering the comparatively large number in a small group of islands like the Seychelles. Only 63 species are given, which is about a quarter the number inhabiting British India. This is largely due to the genus *Calamus* being represented by only one species in Africa, whereas there are 72 in India. W. B. H.

*Leçons de Chimie.* Par H. Gautier et G. Charpy. (Paris: Gauthier-Villars, 1894.)

THE general plan of the second edition of this work does not differ essentially from that of its predecessor. The introductory portion on generalities—dealing with states of aggregation, laws of combination, equivalents and atomic weights, physical and chemical transformation, chemical equilibrium, the velocity of reaction, thermochemistry, &c.—has been recast, and now occupies one-fifth of the volume. In the descriptive portion, which is concerned with inorganic chemistry only, Moissan's work on fluorine, the diamond, and boron has been introduced. It is characteristic of a French text-book that even now it is deemed necessary to print alongside each important atomic equation the corresponding equation based on equivalents. In the same connection it will be somewhat disconcerting to English students to find that "Le poids atomique est égal au poids équivalent pour les éléments suivants: . . . Pour tous les autres éléments, la valeur du poids atomique est double de celle de l'équivalent." In other respects the book is well up to date, and contains much useful information expressed with the clearness and precision for which French text-books are deservedly famed.

J. W. R.

## LETTERS TO THE EDITOR.

[The Editor does not hold himself responsible for opinions expressed by his correspondents. Neither can he undertake to return, or to correspond with the writers of, rejected manuscripts intended for this or any other part of NATURE. No notice is taken of anonymous communications.]

### Variation and Specific Stability.

I AM afraid that in my anxiety to compress too long a statement, I did not make the points which I wished to bring forward in the recent discussion at the Royal Society sufficiently clear. I have therefore written out the following summary:—

(1) All organisms vary. That in doing so they obey Quetelet's law was suggested by Mr. Darwin himself more than twenty years ago. He observes (NATURE, September 25, 1873, p. 432):—"It is known from the researches of Quetelet . . . that men may be grouped symmetrically about the average with reference to their height. . . . We may presume that this is the usual law of variation in all the parts of every species under ordinary conditions of life."

(2) Prof. George Darwin supplemented this in a following number (October 16, p. 505) with a very lucid account of the principle. In this he says:—"We may assume with some confidence that under normal conditions, the variation of any organ in the same species may be symmetrically grouped about a centre of greatest density."

(3) A well-known illustration is that of a marksman shooting at a target. The distribution of his shots will follow the same law; they will be grouped round a centre of greatest density, which is easily ascertained, as it is the centre of gravity of the circumscribed figure. And on successive trials, if all conditions remain unaltered, the position of the centre will remain the same, though the positions of the shots will be different.

(4) No two individual representatives of a species in nature are exactly alike. All differ in some respect. We may picture the aggregate, however, as grouped with respect to any discriminating character like the shots on the target. Our conception of the species to which they belong is an abstraction which we endeavour to represent in our museums by a specimen which would be placed as near as possible to the centre of greatest density. Such an abstraction we may call the *mean specific form*.

(5) Returning to the case of the target, it is obvious that if some new condition be introduced, such as a wind blowing transversely, every shot will be affected, and the centre of density of the system will be shifted. What is the analogous result when we are dealing with the aggregate of individual organisms representing "a species"?

Natural selection will come into play, to begin with. It may be that some hitherto indifferent variation may be favoured by the new condition. Others will be relatively handicapped, and such a favoured variation will get the upper hand. It is obvious that the result will be to shift the centre of density: the mean specific form will have undergone a corresponding change.

(6) It is probable that so simple a result is not the usual one, and what actually takes place is much more complex.

Mr. Darwin concludes "that organic beings when subjected during several generations to any change whatever in their conditions, tend to vary." ("Variation of Animal and Plants," ii. p. 250.) I infer therefore, and all the facts which have come under my observation confirm it, that a change in the external conditions, otherwise the *environment*, will provoke some variation in the organism, which I may call the *stimulated variation*.

(7) It appears to me that from the Lamarckian point of view, the stimulated variation ought to be immediately adaptive. From the Darwinian this is not necessarily the case. It may be either advantageous or, at any rate, indifferent. ("Changed conditions generally induce mere fluctuating variability," Darwin, "Origin," 6th ed. p. 131.) Prof. George Darwin, in the note above cited, traces out the result in the two cases. In the former case, "with continual intercrossing," the new variation will get the upper hand, and the centre of density will be shifted: in the latter it will, by continuous "weeding out," be, after a temporary displacement, eventually restored.

(8) This leads to the consideration of the *stability* of the mean specific form. Some species seem to yield pretty rapidly, though with an appreciable *inertia*, to the influence of changed condi-

tions; others seen almost indefinitely to resist it. Probably, however, even the most intractable cases may eventually be broken down. This stability has been largely used as an adverse argument to organic evolution generally. Prof. Decaisne was much influenced by it, and stoutly maintained not merely the permanent stability of species but even of varieties. His experiments on the seminal reproduction of cultivated pears, which extended necessarily over a long series of years, was, as might be expected, adverse to varietal stability, and left him in a position from which he never extricated himself.

The existence of specific stability is, however, undoubted. Mr. Carnuthers devoted his address to Section D of the British Association in 1886 to a useful summary of the ascertained facts on the subject. He laid particular stress on the well-known data, which are illustrated in the Kew Museums, as to the flora of Egypt. This, 4000 years ago, was composed of species which differed apparently in no particular from their present living representatives.

An even more striking illustration is afforded by the history of standards of weight. From Prof. Ridgway's researches it appears that these were originally based on seeds ("Origin of Currency and Weight Standard"). He finds (p. 182) that "the Troy grain is nothing more than the barley-corn." Further, "in 1280 (St Edward I.) the penny was to weigh 24 grains, which . . . were as much as . . . 32 grains of wheat" (p. 186). The ratio still obtains. "In September, 1887, I placed in the opposite scales of a balance 32 grains of wheat (dry and taken from the midst of the ear, and 24 grains of barley taken from ricks of ears grown in the same field at Fen Ditton, near Cambridge, and I thrice repeated the experiment: each time they balanced so evenly that a half-grain weight turned the scale." Further, he found that "practically 4 wheat grains = 3 Troy grains" (p. 182). The same fact of stability can be illustrated from other seeds used as standards of weight. No working naturalist will then be disposed to very much quarrel with the conclusion arrived at by Mr. Carnuthers, that "species must be dealt with as fixed quantities."

Notwithstanding this, the counterfact remains that it is doubtful if there is any species the stability of which cannot be broken down by appropriate methods. I, however, prefer to say not that a species is "fixed," but that its mean specific form is appreciably stable under permanently uniform conditions. And this is probably what Mr. Carnuthers really meant.

The interesting question then arises, how is this stability brought about?

(10) The principle of stability seems to me scarcely to have received the attention it deserves. Mr. Darwin has, I think, never expressly stated it, though he was evidently well acquainted with it, and has supplied some explanation of its causes.

In dealing with the facts referred to above as to the Egyptian flora, he simply says: "In Egypt, during the last several thousand years, the conditions of life, as far as we know, have remained almost entirely uniform." ("Origin," 6th ed. p. 100.) The implication, though he does not actually say so, is that under such circumstances evolution is in abeyance. If it were not, it seems to me that we must admit Nageli's "inmate tendency towards progressive and more perfect development." Mr. Darwin states, however, the correlative principle with greater definiteness: "The influence of changed conditions accumulates, so that no effect is produced on a species until it has been exposed during several generations to continued cultivation or domestication." ("Animals and Plants under Domestication," ii. 261.) I have no doubt that this is true, and I entirely agree with De Vilmorin, cited by Mr. Darwin (loc. cit. p. 262) that "the first step is to get the plant to vary in any manner whatever, . . . let the fixed character of the species being once broken, the desired variation will occur or later appear."

More or less close interbreeding with it is well known, tend to stability. Mr. Darwin tells us: "After a dozen generations of self-fertilisation, it is probable that the new variety would remain constant, even if grown under somewhat different conditions." ("Cross and Self-fertilisation," p. 460.) The same fact is illustrated "by the survival during at least a half a century of the same varieties of the common pea and the sweet pea." (Darwin, loc. cit. p. 29.) Self-fertilisation has "the positive advantage that it assures the production of a large supply of seeds." (Darwin, loc. cit. p. 41.) The price ultimately paid is, however, probably a very heavy one—that of extinction. (Cf. Darwin, "Life," iii. 276.)

(11) The case of wheat is peculiarly interesting. It is not worth while pressing the evidence too far. But it may be remarked that wheat has by no means lost its power of variability. Mr. Carnuthers remarks:—"The improved varieties of our cereals now under general cultivation have been obtained almost entirely from the selection of individual plants." (*Journal R. Agric. Soc.* 4th ser., iv. p. 684.) Mr. Darwin ("Animals and Plants," i. 318) quotes the authorities for the statement that the wheat cultivated by the lake-dwellers in Switzerland had very small grains. Still we may admit that for a very long period the average wheat grain has not appreciably varied. This appears to me to prove nothing more than that wheat has got into a stable state, which I should attribute to the average uniformity of the conditions under which it has been cultivated. I shall not press the question of its self-fertilisation, which is generally accepted, but which Darwin (loc. cit. 316) thinks is generally invariable. Somewhere he has stated, though I cannot put my hand on the reference, that the size of the grain is disadvantageous.

If so, this would be unfavourable to its increase. De Candolle ("L'origine des plantes cultivées," p. 370) regards the original source of the wheat-plant as extinct, and suggests that the attractiveness of its grains for birds may have been the cause. At any rate it appears certain that but for cultivation it would now entirely disappear. The conclusion seems to be that mankind has brought it up to a certain standard which was sufficient for its purpose, and has not been compelled to carry it further by unconscious selection.

The case of maize, which has also been quoted, is much less to the point. It is now pretty certain that its origin is to be found in a form still existing in which the grains are only two-rowed. But maize, under existing cultivation, proves to be extremely variable.

(12) It appears to me that an important light is thrown upon what I may be allowed to term the *stability problem* by the remarkable investigation recently presented to the Royal Society by Prof. Weldon. It is one which I am persuaded would have given Mr. Darwin peculiar pleasure.

Prof. Weldon measures very carefully some organ in each individual of a given population. The measurements are plotted out along a base line; the number of individuals in which each measurement occurs are represented proportionately by lines drawn perpendicular to the base line. The summits when connected form a curve, which is termed a *frequency curve*. For a discussion of the general principle and of the interpretation of such curves reference must be made to the able investigation for which biologists are indebted to Prof. Karl Pearson (*Phil. Trans.* 1894, A, pp. 71-110).

Prof. Karl Pearson (p. 72) terms "a frequency curve which for practical purposes can be represented by the error curve," a normal curve. Such a normal curve, I apprehend, is only another way of representing the result of Laplace's law, which, as I stated above, there was reason to suppose was the ordinary law of variation. For he adds: "When a series of measurements gives rise to a normal curve, we may probably assume something like a stable condition; there is production and destruction impartially round the mean."

By applying the method to a crab from Plymouth Sound, Prof. Weldon has been able to throw light, it seems to me for the first time, on a most important factor in the stability problem.

"About 7000 females . . . were chosen (at random, except as regards their size), and two dimensions were measured in each. The results were then compared with those of the corresponding measurements, made upon a sample of 1000 adult females from the same locality."

The result was to show that "selective destruction" takes place in early life amongst individuals, which deviate from the "mean specific form." Prof. Weldon arrives at the conclusion "that the position of minimum destruction should be sensibly coincident with the mean of the whole system," is a condition which "may be expected to hold for a large number of species, which are sensibly in equilibrium with their present surroundings, so that their mean character is sensibly the best." The actual statistical demonstration of this fact, in my opinion, deserves to rank amongst the most remarkable achievements in connection with the theory of evolution.

(13) When the frequency-curve is almost normal, Prof. Karl Pearson infers "the pressure at a given time of some particular form of natural selection." The mathematician may in this case be able

to render assistance to the biologist of supreme importance. "The amount and direction of the abnormality will be indicated if this [abnormal] frequency-curve can be split up into normal curves." Analysis would in this way give us information which we could perhaps not even guess at.

I agree with Prof. Karl Pearson that "resolution into two" will be sufficient. The stress of natural selection at any moment must always be between the best and the next best.

In tolerably simple cases I have no doubt that the result of Prof. Karl Pearson's labours will be to throw great light on the matter. In more complicated ones we must look for some disappointment in view of "the great variety of solutions which may be suggested" (p. 106). And the tentative discovery of "component normal curves" seems likely to be fallacious (p. 90).

(14) I think it is important to insist that the importance of Prof. Weldon's present results has reference to the stability problem. He is fully aware of this fact when he says that "they cannot be expected to hold in cases of rapid change such as those induced artificially by selection under domestication, or naturally by rapid migration or other phenomena resulting in a rapid change of environment." These will lead to abnormal frequency curves.

(15) A few remaining points in Prof. Weldon's paper deserve some remarks.

I entirely agree with him in minimising the value of "sports" in evolution. As against Nageli and his followers, I see no ground for believing in any innate progressive tendency in organisms. When the organism is in stable relation with its environment it will continue so indefinitely. That is the conclusion I deduce from the flora of Egypt, and other facts which have been cited of the same kind. Prof. Weldon seems to me to have supplied this position with a most important proof by establishing the "selective destruction" of variations aberrant from the mean specific form. When the environment varies, stability is destroyed; but it will be ultimately re-established, though with a different centre, by the operation of natural selection. The result is that the organism has undergone some permanent degree of change. As I conceive the process, it is one of continuous adjustment of "slight" variations on one side and the other. But it is important to keep in view that variation in the environment stimulates the variation in the organism which supplies the ultimate material for a adjustment. That the amount of the adjustment at any moment is slight is not incompatible with its amounting to almost anything we like in the aggregate, if sufficient time be allowed. We might as well deny that a curve can be built up from its infinitesimal elements.

The value in this respect of sports may be easily overrated. It appears to me that generally, so to speak, they attempt too much and overshoot the mark. The improbability of a casual sport being exactly what is wanted to bring the organism into an advantageous relation to the environment at any particular juncture seems to me very great. That such a thing may occur is not denied, but it can hardly be more than a "fluke."

(16) This is confirmed by the fact that in the vegetable kingdom sports are rare, and they seem to have little power of holding their own in competition. I instanced the cases of the occurrence of copper-coloured and lacinate foliage in many trees, as well as the occurrence of varieties with weeping and fastigate habit. It is well known that to some extent these are perpetuated by seed. But the existence of such forms would undoubtedly be transient if it were not for their perpetuation as curiosities under cultivation.

(17) In museums it is usual to attempt the representation of the mean specific form. The association of strikingly aberrant specimens is interesting and often suggestive. But I do not see that they illustrate more than the possibilities of variation and the fact that it may be discontinuous.

(18) I placed upon the table plants of the feral type and of a recent cultivated form of *Cineraria cruenta* from the Canaries. The difference in habit and in the form and colour of the flowers was enormous. This has undoubtedly been brought about by human selection. As far as is known it has been accomplished by the gradual accumulation of small variations. The horticulturist has not troubled himself about the foliage, which, though more luxuriant, has remained practically unchanged. But it must not be assumed that it is unchangeable. In the case of the Chinese primrose, the feral form from north-west China, for which we are indebted to Dr. Henry, has palmatifid leaves rounded in outline; but the distal lobes are

occasionally lengthened out. The horticulturist, as a matter of fancy, working on this, has now split the type into two races, one of which has palmatifid and the other pinnatifid leaves. Many botanists would, undoubtedly, if they did not know their history, assign to such a different specific rank.

(19) I am not sure that I quite understand Prof. Weldon when he says that "the statistical method is the only one at present obvious by which [the Darwinian] hypothesis can be experimentally checked." In the first place, I should myself hardly call it experimental at all. In the next place, though I think it will throw important light on the stability problem, in the important cases where evolution is actually taking place, the mathematical analysis appears to me to be beset with very great difficulties. We must not, therefore, expect too much from it.

(20) On the other hand, museums, as at present organised, do not help very much the study of evolution. In the case of plants, I doubt if herbaria will ever be able to present material in a sufficiently compendious or complete form to be of much use. The study, however, of extensive series of a few species of insects ranging over the whole of a large geographical area, such as Mr. Elwes has brought together in the case of butterflies, must, it seems to me, afford most important material for future discussion.

W. T. THISELTON-DYER.  
Royal Gardens, Kew, March 10.

### Do Plants Assimilate Argon?

IT is a well-known fact that some plants are able to assimilate nitrogen from the atmosphere and form compounds. Now, as argon cannot be induced—at least up to now—by any known process of inorganic chemistry or physical science to enter into a combination with one or more of the known elements, it occurred to me whether that peculiar power which produced the cell is not able to form combinations with argon. The experiment to grow suitable plants in an atmosphere of pure argon, or argon mixed with pure oxygen, on a bed of pure sand, &c., would easily settle the question.

If this experiment has not yet been made, perhaps you will find space in your paper for the above few lines.

Essex-Kuhr, March 6. E. BLASS.

THE first thing is obviously to find whether there is any argon in a nitrogenous vegetable; and experiments are now nearly completed in my laboratory to see if nitrogen obtained from peas contains any argon. Similar experiments are being made with nitrogen from mice. In a few days I shall know the results. But this is, of course, on the assumption that the process which liberates nitrogen also liberates argon; and it is by no means certain. It should be remembered that argon and nitrogen have absolutely no similarity, and that their occurrence together in air is a pure accident, due to the inertness of both.

March 10. W. RAMSAY.

### The Measurement of Pressures in Guns.

IN a paper "On Methods that have been adopted for Measuring Pressures in the Bores of Guns" (Report of the British Association, 1894), Captain Sir A. Noble has remarked that it seems to him "that there is no method so satisfactory, despite its attendant labour, as that of *making the projectile write its own story*" (p. 540). That might be sufficient for *smooth bore* guns, where there was little or no friction in the bore, but it is quite unsatisfactory when applied to *rifled* guns, and especially B.L. guns.

The two methods of experimenting now in use employ the *pressure gauge* and the *chronograph*, both of which we will, for this occasion, suppose perfectly accurate. The pressure gauge measures directly the pressure of the powder gas  $P$ , the quantity wanted. The chronograph will measure  $P$ , the same pressure of the powder gas, *minus*  $F$ , the resistance offered to the motion of the shot by the rifling, the friction of the driving-band, &c., =  $P - F$ , where  $F$  is often very great. The difficulty is to see how these two different processes can confirm one another, as  $F$  is unknown and of great importance.

The only satisfactory method of determining the maximum pressure of powder gas at any point in the bore of a *rifled* gun is to measure it *directly*, by the pressure gauge, which requires many precautions to be taken, or by some other more simple method.

F. BASHFORTH.  
Horncastle, March 9.

The Velocity of the Argentine Earthquake Pulsations of October 27, 1894.

IN several recent notes in NATURE (pp. 232, 371, 393), attention has been drawn to the great Argentine earthquake of last October 27, and to the record of its pulsations in Europe. In one of these (p. 371) a rough estimate is given of the velocity, but a more detailed one seems desirable on account of the great distance traversed by the pulsations.

According to M. Noguès (*Compte rendu*, vol. cxx. pp. 167-170), the epicentral tract includes Rioja, San Juan and Mendoza. There is thus some uncertainty as to the exact position of the spot from which the pulsations started. In the following estimate I have supposed it to coincide with San Juan.

San Juan is about 312 km. from Santiago, and 11,600 km. from Rome, the difference being 11,288 km. The earthquake was registered by a seismograph at Santiago at 8h. 50m. 26s. p.m., Greenwich mean time. The slight preliminary pulsations were recorded by the great seismograph at Rome at 9h. 7m. 35s., the first maximum at 9h. 49m. 50s., and the principal maximum at 9h. 55m. 40s. Assuming that the first maximum (or beginning of the larger pulsations) corresponds to the movement which started the seismograph at Santiago, it follows that the distance of 11,288 km. was traversed by the pulsations with an average velocity of 3.17 km. per second.

It should be remarked that this estimate agrees very closely with those obtained for the same phase of the movement in the cases of the Greek earthquake of April 27, and the Constantinople earthquake of July 10, 1894 (namely, 3.21 and 3.20 km. per sec. respectively).

For the first slight movements recorded at Rome, Charkow and Nicolaiew, we must admit either that the pulsations producing them started some time before the great earthquake, or else that they travelled with a far higher velocity. If they left San Juan simultaneously with the larger pulsations (i.e. at 8h. 48m. 48s.), their average velocity must have been 10.38 km. per second. The horizontal pendulums at Charkow and Nicolaiew also recorded these early movements, beginning at 9h. 8m. 36s. and 9h. 12m. 6s. respectively; soon after which the curves more or less completely disappeared. San Juan is about 13,625 km. from Charkow and 13,240 km. from Nicolaiew, the average velocities to these places being therefore 11.47 and 9.47 km. per second. The latter obviously corresponds to a later phase of the movement.

Whether the slight preliminary pulsations start before, or at the moment of, the earthquake, is a question of the greatest practical importance from the point of view of earthquake-warnings. To answer it, one of the Italian seismometrographs or a horizontal or bifilar pendulum should be placed beside a seismograph in the immediate neighbourhood of the centre of disturbance.

C. DAVISON.

Birmingham, March 6.

The Society of Speleology.

THE attention of your readers has already been called to the formation of this Society in Paris (NATURE, January 3), the promotion of which is due to the action and enthusiasm of M. E. A. Martel, the author of the beautifully illustrated work "Les Abîmes," reviewed by Prof. Bonney in your pages of the 28th ult. This book describes and illustrates a number of extraordinary and often hazardous subterranean explorations in the underground caves and watercourses of the limestone districts of France, Belgium, Austria, and Greece. The Society is intended to carry on the work thus initiated by M. Martel and his devoted co-workers in a more effective manner, and over a wider area than has been possible by private enterprise. The formation of the Society, M. Martel writes me, is now an accomplished fact. About 130 gentlemen of all nationalities, some of whom bear well-known names in the ranks of science, have signified their adhesion. A provisional code of rules has been printed and adopted, and a meeting has already taken place, under the presidency of the president-elect, M. F. Deloche, Deputy for the Basses-Alpes.

The first article of the rules states the object of the Society as follows:—"The Society of Speleology is instituted in order to ensure the exploration—to facilitate the general study—to cooperate in the regulation or utilisation of subterranean avities of all sorts, known or unknown, whether natural or

artificial; to encourage and aid with funds investigations relating thereto; in a word to popularise and develop in a way, at once practical and theoretical, utilitarian and scientific, researches of all kinds in the interior of the earth." The subscription for ordinary members is fifteen francs per annum. It is intended to publish a quarterly bulletin; to a copy of which each member will be entitled.

In order to fully carry out the objects of the Society, the programme of which is a comprehensive one, more members are required, and I shall be glad to furnish any of your readers who may wish to join the society with the proposal form or *Bulletin d'Adhesion*, or they may be obtained from M. Martel, General Secretary, 8 Rue Ménars, Paris.

M. Martel, I may say, is desirous of extending his investigations to the British Isles, if sufficient inducement be offered in the exploration of some large cave, as yet unworked or imperfectly known, and where his apparatus of rope ladders, collapsible boats, &c., would be useful aids. Information on this head will be thankfully received by me.

MARK STIRRUP.

Bowdon, near Manchester, March 6.

Contraction of Trees caused by Cold.

THE splitting of forest trees by frost is often ascribed to the same cause which bursts a pipe charged with water when the temperature falls below 32° F., namely, the expansion of the water on turning into ice. Botanists know that this is not so, but the splitting is owing to a contraction of the wood by frost, similar, but in a less degree, to what happens when the wood is dried. With the thaw the trees expand to their original dimensions. Evidence of such contractions and expansions is furnished by the measurements herewith.

For some years past, I have regularly taken the girths of a number of forest trees during summer, in order to note the amount of growth. To do this accurately I have to use a steel tape, and of course to girth the trees at exactly the same place. My experience, thus acquired in measuring to a nicety, is a sufficient reason for confidence that the following figures are substantially correct.

No.	Girth of trees in October 1894, when done growing and before the frost.	Girths, February 5, 1895, 9 a.m. Temp. 5° F.	Girths, March 2, 1895, 3 p.m. Temp. 30° F.	Amount of contraction with frost.
	Inch.	Inch.	Inch.	Inch.
1	Sycamore...26 $\frac{3}{4}$	26 $\frac{1}{2}$	26 $\frac{3}{4}$	$\frac{1}{4}$
2	Sycamore...22 $\frac{1}{2}$	22 $\frac{1}{2}$	22 $\frac{1}{2}$	$\frac{1}{16}$
3	Sycamore...33	32 $\frac{1}{2}$	33	$\frac{1}{16}$
4	Elm ... 28 $\frac{1}{2}$	28 $\frac{1}{2}$	28 $\frac{1}{2}$	$\frac{1}{16}$
5	Elm ... 22	21 $\frac{1}{2}$	22	$\frac{1}{2}$
6	Elm ... 19 $\frac{1}{2}$	19 $\frac{1}{2}$	19 $\frac{1}{2}$	$\frac{1}{16}$
7	Ash ... 40 $\frac{1}{2}$	45 $\frac{1}{2}$	40 $\frac{1}{2}$	$\frac{1}{16}$
8	Oak ... 42 $\frac{1}{2}$	42 $\frac{1}{2}$	42 $\frac{1}{2}$	$\frac{1}{16}$
9	Oak ... 17 $\frac{1}{2}$	17 $\frac{1}{2}$	17 $\frac{1}{2}$	$\frac{1}{16}$
10	Oak ... 35 $\frac{1}{2}$	34 $\frac{1}{2}$	35 $\frac{1}{2}$	$\frac{1}{16}$
11	Beech ... 21 $\frac{1}{2}$	21 $\frac{1}{2}$	21 $\frac{1}{2}$	$\frac{3}{16}$
12	Beech ... 32 $\frac{1}{2}$	32 $\frac{1}{2}$	32 $\frac{1}{2}$	$\frac{1}{16}$
13	Beech ... 42 $\frac{1}{2}$	41 $\frac{1}{2}$	42 $\frac{1}{2}$	$\frac{1}{16}$

Bradford, March 4.

J. CLAYTON.

The Barrenness of Precambrian Rocks.

REFERRING to the paragraph in NATURE (February 28, p. 423), on the sudden appearance of a rich fauna in the Lower Cambrian rocks, I should like to make a suggestion for the consideration of geologists. May not the extreme poverty of organic remains in Precambrian (Archaean) strata be largely due to a scarcity of carbonate of lime in the water of the Precambrian seas? The Uriconian and Longmyndian rocks of Shropshire, which, at the very least, must include five miles of sediment, comprise hardly a scrap of limestone. The same remark will apply to the Precambrian strata of Charnwood, South Wales, the mainland of North Wales, and the great Torridonian group of Scotland. The Peibidian rocks of Anglesey contain bands of limestone, it is true, but it is highly probable that they are of chemical origin, and not derived from oceanic waters. There are, of course, plenty of limestones in the older Archaean rocks of North America, and a few of them in the Lower Archaean of

Britain; but the proof of their marine origin remains to be written. They contain no undisputed organic remains. The rocks in which they are intercalated are not proved to be altered sedimentaries. There were numerous animals living in the Salopian area in the Longmyndian epoch, for their trails are quite abundant in some of the slaty seams; but, if there were no carbonate of lime in the sea, there could, of course, be little material to provide shells for its inhabitants. Numerous creatures of many types might have been evolved, whose soft tissue would leave no traces in the rocks. In succeeding ages, as the forces of denudation cleared off the newer Archæan, and cut down into partially decomposed crystallines, abundance of calcic carbonate would be carried down into the sea.

C. CALLAWAY.

Wellington, Shropshire, March 1.

### The Artificial Spectrum Top.

In your issue of March 7, we notice a letter from Dr. Dawson Turner, in which he says he has had a "Benham's Spectrum Top" made on glass, by an optician, for the lantern, and recommending others to do the same.

Will you allow us to state that we have sold all rights in this copyright top to Messrs. Pears, reserving to ourselves only the sole right of making them as lantern slides, in which form we have been supplying them for some time.

The tops can be obtained from Messrs. Pears, and the lantern slides from us; any one else supplying either will, of course, be infringing the copyright.

NEWTON AND CO.

### RESEARCH IN EDUCATION.

NO branch of *research work* at the present day offers greater opportunities, whilst none is more urgently in need of *original workers*, than that which lies open to the teacher in school or college; and it is surprising how small an amount of sound work is accomplished in it—how little it is realised that there is a science of education to be developed by persistent study, application and research. An analytical habit of mind seems to be the very last qualification sought for in a teacher—such is the influence acquired by clerical instructors in the course of centuries by the universal extension of methods of teaching originated in the monkish cell and cloisters, and wielded with but slightly diminished force, even to-day, by their lineal descendants, whose voices still preponderate in educational affairs. Conservative and sheep-like—as we cannot fail to be if all our early life be spent in an atmosphere of dogmatism—the slowness with which we evolve and apply new ideas is phenomenal. It cannot be that sterility is the outcome of excessive labour in days gone by, and consequent exhaustion of the soil; still less, that it is owing to absence of demand; for it is only too clear that the entire change in the conditions of life witnessed within the century renders it necessary that our children should be so educated that they may successfully grapple with the new conditions, and it stands to reason that the preparation which sufficed in the case of their forefathers must be insufficient in theirs. This is now being universally recognised, but all too slowly and imperfectly. Thus the academic oration first on my list, delivered only in September last, at Freiburg, by the Professor of Anatomy, is a vigorous protest against the practice

<sup>1</sup> "Ueber die Vorbildung unserer akademischen Jugend an den humanistischen Gymnasien."—Programm wodurch zur Feier des Geburtstages seiner königlichen Hoheit unseres durchlauchtigsten Grossherzogs Friedrich im Namen des akademischen Senats die angehörigen der Albert-Ludwigs-Universität einladet der gegenwärtige Prorektor Dr. Robert Wiedersheim. (Freiburg, 1894.)

"The Teacher's Manual of Lessons on Elementary Science." By H. Major, B.A., B.Sc., Inspector of Board Schools, Leicester. (Blackie and Son.)

"Practical Lessons in Physical Measurement." By Alfred Earl, M.A., Senior Science Master at Tonbridge School. (Macmillan and Co.)

"A Laboratory Manual of Physics and Applied Electricity." Arranged and edited by Edward L. Nichols, Professor of Physics in Cornell University. Vol. I. Junior Course in General Physics, by Ernest Merritt and Frederick J. Rogers. Vol. II. Senior Courses and Outlines of Advanced Work, by G. I. Moler, F. Bedall, H. J. Hotchkiss, C. P. Matthews, and the Editor. (New York and London: Macmillan and Co.)

prevailing in the German "Humanistic" Gymnasia of devoting an enormous proportion of the school-time to classical studies, and the consequent neglect of drawing, natural science, geography and modern languages, as well as of gymnastic exercises, which is very strange, as he points out, when it is remembered that the meaning of *gymnasium* is a place for athletic pursuits. He especially complains of the way in which exercises in classical style are insisted on and monopolise attention, and strenuously advocates their banishment from the three lowest classes at least. He refers with feeling to the pressure which is brought to bear in school and at home on the child to whom such work does not appeal, and the unhappy state of house and family on "style-days," remarking that every one who, like himself, has had this experience in his own person and that of his children, will sympathise with this view. He tells us that his own bitter experience of thirty-five years ago still follows him in his dreams, and that he can never forget the encouraging words hurled at him by the master of the "Prima" of the Stuttgart Gymnasium when he had done a bad Latin exercise—"You never in your life will come to any good, as sure as my name is Schmid." Is not this too often the attitude of our schoolmasters, and is it not too often forgotten that the human mind, fortunately, will not in all cases respond to one uniform system of treatment? Surely the time must soon come when it will be the main duty of headmaster and headmistress to study their scholars, and assort them in accordance with their aptitudes; when no headmaster will set down a boy as of inferior intellect merely because he does not get on well on the classical side, and cannot therefore be made use of with effect as the winner of a scholarship at the university—a course which some of our most noted headmasters appear too often to countenance if report belie them not. Fortunately we are not here so much the victims of educational overpressure as is Germany under the terrible influence of its military system, although there is enough to complain of, especially in the case of girls' schools, owing to the improperly large number of subjects included in the time-table; moreover, examinations, such as the London University Matriculation, are exercising a most insidious effect; and now that County Councils all over the country are granting scholarships on the results of examinations, it behoves us to be much on our guard, and to take steps to secure that all such examinations are so conducted that reasonably well-taught and reasonably intelligent scholars can be submitted to them without any interference with the normal school course. Prof. Wiedersheim, referring to the very one-sided training given in the Gymnasia to the future jurist, theologian and philologist, calls attention to the importance to such students of some knowledge of natural science in the following passage, which undoubtedly deserves our attention, as we suffer in like manner: "Kein Gebildeter vermag sich heutzutage dem Einflusse, welchen die Naturwissenschaften auf das Geistesleben aller Culturnationen gewonnen haben, mehr zu entziehen. Die ganze moderne Weltanschauung, unser Leben und Denken, die Forschung auf allen Gebieten—ich erinnere nur an das auch in der vergleichenden Linguistik zur Geltung kommende genetische und causale Element—stehen unter der Signatur der inductiven Forschung. Mit diesem Umschwung hat auch das humanistische Gymnasium zu rechnen, sollen nicht Juristen, Philologen und Theologen in ihrem ganzen Bildungsgang einen Fehler aufweisen, der oft nicht mehr gut zu machen ist." But this is nowhere properly recognised. And yet Charles Kingsley long ago dreamt of a day when every candidate for ordination should be required to have passed creditably in at least one branch of physical science—if only to teach him the method of sound scientific thought. Dr. Percival

has urged in Convocation at Oxford that the elements of natural science should take their place in Respon- sions—side by side with the elements of mathematics, and equally obligatory. The late Master of Balliol, I believe, also recognised the importance of such a change; but the reformer who will carry it into effect is not yet in evidence, and perhaps his services will not be required, as the schools must soon do that which the universities ought long ere this to have had the fore- sight to enforce. We are, in fact, only beginning to escape from the bonds of tradition, and it cannot be denied that our release is being gradually effected—not through any action taken by our ancient universities, but rather in spite of them—mainly through the persistent efforts of a small but untiring and resolute body of outsiders whose position has yet to be made clear to the public, most of whom undoubtedly regard the teaching of experimental science much in the way that the introduction of pianos into Board Schools was regarded a few years ago by a majority of Londoners—as something very nice for those who can afford it, but as in no sense a necessary element in the education of the masses. We, on the contrary, contend that the human mind cannot, as a rule, be completely educated by exclusive attention to literary and mathematical studies, and that lessons in experi- mental science must form an integral portion of the entire school course, because such lessons alone afford the means of fully developing a side of the intelligence which perhaps more than any other is of importance in life—the faculty of observing and of reasoning correctly from observation: with Kingsley, we desire that the method of sound scientific thought should be taught universally in schools, to the exclusion of dogmatism and eyelessness; and we desire to inculcate habits of self- helpfulness and handiness. The motto from Montaigne adopted by Prof. Wiedersheim fully expresses the modern view of education: "Es ist nicht ein Geist und nicht ein Körper den wir erziehen sollen, sondern ein Mensch, und wir dürfen ihn nicht theilen." Hitherto more often than not, we have cut him up into pieces, and thrown the most important aside. It is only in Germany that a public address on such a theme can be delivered in celebration of the birthday of a Royal Highness—here we must fall back on the British Association; but this body has strangely wasted the unrivalled opportunities which its organisation affords of appealing to the public on such matters.

Fortunately, help seems to be at hand from a quarter from which it was least expected, as the schoolmasters are at last awakening to the necessity of reform, and have themselves taken action which, if persevered in, must be attended with most important consequences. At the recent meeting of the Incorporated Association of Head Masters, which now numbers nearly 300 members, on the motion of Mr. C. Stuart, of St. Dunstan's College, Oxford, London, S.E., it was resolved

(a) "That the Association is of opinion that Examining Bodies should encourage a more rational method of teaching science, by framing the syllabuses in such a manner that the practical work required may be strictly illustrative of the theoretical instruction given."

(b) "That it be referred to the General Committee to appoint a small Sub-Committee, so that a report may be presented to the next summer general meeting con- taining detailed suggestions, which it is proposed to make to Examining Bodies concerning examinations in science."

As I ventured to point out, when speaking on these resolutions, the consequences of their adoption will probably be far greater than those who have accepted them are likely to have contemplated. Thoughtful examiners have long been waiting for a sign: no one has been more dissatisfied with their examinations than they themselves have been, but it has been impossible for them

to examine much in advance of the teaching, as it would obviously have been most unfair to candidates to make them victims of a system for which they are in no way answerable; and at most it has been possible to gradually give a practical turn to questions in subjects which can only be taught properly by means of practical lessons. The gage thrown down by the headmasters will, there- fore, certainly be uplifted forthwith by all examining bodies whose work is not done in a purely perfunctory spirit, and the schools will find that of their own accord and most properly they have brought about a complete revolution in their own methods of teaching; for if they ask for proper examinations, they necessarily must be anxious to see corresponding proper methods of teaching adopted in their schools, and will provide for their introduction. Nothing could be more gratifying to those among us, who, during years past, have been pointing out the necessity of introducing radical changes and improvements.

A serious responsibility will now be cast on teachers, and it is clear that if workers are forthcoming with minds imbued with the proper spirit of inquiry, there will be ample opportunity of gaining distinction in the field of educational research. There is clearly much leeway to be made up, for although we are all agreed that every branch of natural science must be taught practically, we are, unfortunately, far from always practising what we preach, the system of mere lesson learning not only prevails far too widely and extensively, but is far too frequently regarded with approval as all-sufficient. The practical and theoretical work are seldom, if ever, made sufficiently interdependent—in fact, this is the blot on which the headmasters have laid their finger. Even in my own subject, chemistry, which is generally supposed to be in a stronger position than most others, as it has been taught practically from a considerably earlier date, much misconception prevails, and we are credited with having advanced far more than we deserve. Liebig, the founder of the laboratory method of teaching, appears to have taught *chemistry*—we are told that when Hofmann became a student under him, although a beginner, he was set to work at research; and we know that Liebig gave all his students problems to solve. But the march of progress and, especially, the press of numbers have long since led to the introduction of the anti-research method which some of us irreverently term test-tubing. Such and such *is* the case—do so and so, and *if* you do so and so, this and that *will* happen, are instructions so often dinned into beginners' ears, that they become part of their very being, and they in consequence are ever afterwards unable to give a straightforward account of what *they* have done, and insist, instead, on telling you, the teacher, what to do and what will, not what does, happen. Nothing is more rare in a chemistry examination paper than a straight- forward answer, not in terms of *if* and *will*, showing that the writer is describing from personal knowledge some- thing that *has been* done. The true object of experiment- ing is thus lost sight of as the habit grows of requiring to know in advance what will be the outcome of any particular experiment: the spirit of curiosity is rarely awakened. At the same time the worst possible literary style is encouraged, a real opportunity of developing a good one being most perversely sacrificed. Analytical tables were originally introduced with the laudable object of presenting knowledge to the student in a systematic form, but gradually we have allowed them to pass from the position of good servants to that of bad master—mainly because they offer so very convenient a method of keeping students occupied with a minimum of attention and labour on the part of the teacher and at a minimum cost, as a few test-tubes and weak solutions form almost the only stock in trade. Quantitative work is also done in an almost equally per-

functory way, as a rule, with the object of qualifying the student to do technical analyses, and the importance of measurements in establishing first principles is never taught practically, but is merely talked about: the result is that only the few who study the subject professionally, really grasp the meaning of the fundamental quantitative conceptions of our science. It is not surprising that under such a system, being helped over every stile, and having no training in research methods, our students are so very rarely properly educated. And altogether false ideas have arisen also as regards the value of true research work, this having been allowed in far too many cases to degenerate into mere preparation-making, or mere measurement work. There are many among us who have recognised these shortcomings in our method, but tradition exerts its all-powerful influence, and little short of a revolution is required to reintroduce a truly scientific procedure into our schools and examinations—to lead teachers to recognise that the only proper method is to make students researchers from the very outset. These remarks are but prompted by the desire to acknowledge that if I throw stones, I am fully aware that I dwell in a glass house; and especially to make it clear what is the point of view from which I regard the problem before the teacher of any branch of natural science.

The teaching of physics practically is of quite recent introduction. When I was a student at the Royal School of Mines, there were only lectures on physics; and when, about fourteen years ago, my colleague Prof. Ayrton and I visited all the chief continental schools, we found the practical courses in a very embryonic state. Now, although we have nowhere a laboratory which will compare in size or completeness of fittings with the palace erected at Zurich, practical physics is taught in all science schools and colleges, and the London University requires even candidates at the Intermediate Science and Preliminary Scientific (M.B.) examinations to pass a practical test. Many of the courses are very complete. I shall not easily forget the pleasure which I experienced on the occasion of a recent visit to Prof. Quincke's laboratory at Heidelberg from seeing there the marvellously simple, but yet exact, apparatus used in the practical course; the insight into the inner meanings of things afforded by his arrangements struck me as most perfect, and led me to wish that it were possible to teach my own subject so as to give the course an equally high educational value. There are also nowadays many admirable books from which the student may gather instructions how to make experiments in the various branches of physics—there can be no doubt, in fact, that the practical text-books in this subject are generally of a very high quality. But I venture to think that they need modification in some not unimportant particulars. Whilst in advance of the practical books at the disposal of the chemist, inasmuch as they stand in direct relation to the instruction in theory, being intended, as a rule, as Prof. Nichols happily states in the introduction to his first volume—to illustrate and therefore impress more thoroughly on the mind the principles and laws which have previously been taught by text-books or lectures, yet for this very reason the attitude in which they place the student is a wrong one. A "law" is dogmatically stated, and the student is told how to verify it experimentally, so that the young worker, instead of being led to *inquire*, is perpetually told in advance what are the facts, and is instructed to repeat the experiments merely in order to *prove* certain things. Consequently, in physics as in chemistry, students are far too little encouraged to find out things and to help themselves—instead of becoming imbued from the outset with the spirit of inquiry, they are led to expect and require assistance at every step. While galvanometer needles wag, they calmly put their hands into their pockets, and it becomes very difficult to induce

them ever to adopt any other mental attitude. Whilst therefore our teaching is enormously improved by bringing students into personal contact with the facts to an extent altogether undreamt of even in my student days, by the very wealth of appliances now at their disposal, they are fast becoming spoiled—perfect sybarites, and the self-helpfulness engendered by the rude and scanty apparatus of days gone by is strangely infrequent. The system apparently fails to engender or develop originality and powers of observation, however much it may tend to train even well-informed and exact workers; but I imagine that little more than a change in the form of the instruction is required, in order to make it impossible to say of any one, "that he knows *about* all sorts of things, but he can't *do* them," the only text, it seems to me, worth preaching from at present. The principle it embodies is the one of all others upon which the whole practice of education must be built up, whatever the subjects taught; but it is undoubtedly one which has not been kept persistently under notice, as it should have been by teachers generally.

The habit of mind complained of, so characteristic of all but a few gifted individuals among our students, is probably largely engendered by the training they have received during the early years at school; and it is incumbent on all teachers working in the field of educational research to do their utmost to develop methods which will counteract the evil effects of mere lesson learning and desk work, as these cannot be altogether dispensed with.

As illustrating—how not to teach elementary science, the "Manual" first on my list must be assigned to a high place: no doubt the intention is good, the information may be interesting and useful in its way, although often very bald if not inaccurate, but such a book has no right to figure as a "Manual of elementary science." It comprises instructions for object lessons, on every possible topic, to children in the six standards of elementary schools, in the form of very short chapters either of "special information for the teacher" or "introductory specimen lessons," and of "notes of lessons" in which, in parallel columns, the kind of question to be asked is set out under "method," and the information to be imparted under "matter." As in all books of this class, far too much is attempted. In the hands of a really capable teacher—who would not need such a book, however,—object lessons may be made of the highest value, but even in such hands the tendency always is mainly to impart information; the kind of lessons that would be given by the uninstructed teacher gaining inspiration from Mr. Major's manual, is easier imagined than described, and their educational effect could not fail to be harmful. We are better without such "science," and had better stick to the plain bread and butter fare of "prescientific" days, if we cannot teach in such a way as to inculcate the practice of scientific method; in fact, we do not want "science" teaching of any kind introduced into elementary or, indeed, any schools unless it take the form of work done by the children themselves: in no other way can the end we have in view—that of training them to do, not merely to know—be achieved, and any other kind of teaching must be a pretence and but an encouragement of priggishness.

As regards the course of the future, there is no doubt that much may be done in very early days to lead children to take note of everything about them, to describe what they see, and to collect and describe common materials of every kind. Some slight preparation for the study of botany may also be laid at this stage. But the science lessons proper begin when the children know enough arithmetic to measure and weigh. All who have studied the problem practically are probably agreed that simple measurement lessons must form the foundation, and there cannot be a doubt that it is both

desirable and possible to largely incorporate these with the arithmetic lessons—to teach parts of arithmetic and some geometry practically, in fact. Gordon's "Elementary Course of Physical Science" is probably the type of book which will be used with advantage at this stage, judging from the success the course has met with in Board Schools commencing with the fourth standard.

But the pioneer worker in this field is Prof. Worthington. His admirable little book, "An Elementary Course of Practical Physics," published in 1881, well known to all teachers of physics in schools, was expanded in 1886 into a larger work, "A First Course of Physical Laboratory Practice." These books have been of the very greatest service, and have probably rescued physics from being made a cram subject in schools; but they are scarcely simple or comprehensive enough for such young workers as I am contemplating. As they are intended to be used in connection with lectures, the motive for each experiment is rarely explained at sufficient length, and unfortunately they have the fault common to all such books, to which I have referred above, that the student rarely approaches the experiment in the attitude of the would-be discoverer.

Mr. Earl's book, although it deals only with measurements of length, mass, and time, is of greater length than Prof. Worthington's, but it does not need lectures to supplement it. It has a short but admirable preface, showing that the author has grasped the nature of the problem to be solved, but it is one thing to do this and another to succeed in solving it; and here I think he has been less successful. The style is far too didactic—the descriptions are far too elaborate—the aim is too high, and far too much is told, not enough left to be found out: to use a homely phrase, which I trust will not be misunderstood far too much fuss is made about the work. Such work should be done by young children; it must not be postponed until the evil effects of desk work have warped the scholar's mind, and natural curiosity begins to die out. But the book is far above such students. What, for instance, is the value of an introduction telling us what science is, and why we learn it? If taught to work, children will very soon insensibly learn to appreciate what they are doing, and nothing is gained by pointing out to them, for example, that "each individual stands a centre for himself of all things, knowing that around him are centres of endless variety, &c." Platitudes such as these are out of place in an elementary text-book, and they are beyond children of nine to twelve years of age, by whom simple measurement work will ere long be done in schools generally. In the next chapter, in like manner, we find at the outset a somewhat elaborate disquisition on the meaning of the words standard and quantity, and a description of how measurements of length are made, and then follow directions for a series of exercises: children cannot grasp such disquisitions, and are wearied by them, but most of them will use a foot or centimetre rule with great pleasure. This criticism may be applied to the book generally: the introductory instructions are too frequently high-flown, and too many refinements are introduced into them and into the exercises. The book, in fact, contains material enough both for a junior and a senior course, and would be more generally available if the matter were thus rearranged. But whilst objecting to it on the score of over-elaboration and absence of that simplicity of statement which is indispensable in a book to be used by young beginners, taken as a whole, and regarded from what I conceive to be the author's point of view, it is a contribution to educational literature of great value. The short preface alone is a manifesto of singular importance, coming as it does from a teacher in a public school of high standing. We find in it the remarkable and, I believe, novel expression—the "scien-

tific sides" of Public Schools, one, it may be hoped, that will soon take the place of "modern side," to which so great a stigma is attached through the ill-advised action of masters having sympathy only with classical training—action which has led to the modern side being often characterised as the refuge for the intellectually destitute; if the modern side once become the seat of training in scientific method, a fair share of the intellect of the school being allowed to it, there cannot be a doubt that it will soon reap payment "by results" sufficient to secure to it an honourable revenge. To return to the preface, we read that care has been taken to make the course logically progressive, the end in view being to train boys to observe accurately, to reason rightly, and to front nature with an open and inquiring mind. That it must be admitted more generally than is customary that the retention of facts should be subordinate in scientific education to a sound comprehension of them, a mind which has been trained to observe and compare accurately being more likely to acquit itself well in the world. That the right way of learning is chiefly to be cultivated, the matter being obviously less important than the method in learning science, and a logical and inquiring habit of mind being more valuable than the memory of facts and laws, as it is better equipment for future research and knowledge. It is urged that the course should afford some training in correctness of expression and accuracy of language, no insignificant part of scientific education, although this is seldom recognised. Lastly reference is made to the lack of continuity in work often prominent as a defect, especially in the modern sides of schools, and to the fact that much of the average "capacity of learning" is never utilised, owing to frequent change both of subject and matter. The book may serve in some degree, the author suggests, to bridge over with safety the distance between the laboratory and other classrooms, by acting as a Practical Arithmetic and, to some extent, as a Practical Grammar. Trite as some of these remarks may appear to be, those who are aware of the state of affairs in schools will know that, tested by the standards which generally prevail, they are the rankest heresy, but none the less heresy that must ere long revolutionise existing beliefs and practices. In fine, I am inclined to regard Mr. Earl's book as the account of an important research some results of which he has described in a previous publication, this being his second appearance as the author of an educational work. There is the clearest evidence that he has set himself to work out a problem of which he was able to realise, perhaps, only the general nature at the outset; and that, as so often happens in experimental inquiries as experience is gained, the nature of the underlying problem has been more clearly grasped as the work progressed, and important modifications of procedure have consequently been introduced. I look forward with expectancy to his next memoir, in which the results of his further studies will be presented to us, I trust, in far less elaborate guise, so as to render them available to the simplest understandings.

"The Laboratory Manual of Physics and Applied Electricity," arranged and edited by Prof. Nichols, of Cornell University, U.S.A., is intended as a college course, and is stated to be the outgrowth of a system of junior instruction which has been gradually developed during a quarter of a century, and I shall therefore venture to criticise it broadly from an outsider's point of view, as though it were a report on the results of an inquiry, with reference to its general character and the arrangement of the subject-matter. The first volume by Messrs. Merritt and Rogers is intended for beginners, and, we are told, affords explicit directions together with demonstrations



and occasional elementary statements of principles. It is assumed that the student possesses some knowledge of analytical geometry and of the calculus; also that he has completed a text-book and lecture course in the principles of physics. Here we may at once join issue with the authors. If, as is so frequently and indeed almost always the case at present, the student come to college knowing a good deal of mathematics and no physics, the first assumption is a legitimate one, but it is time that we began to insist that such educational abortions should not be reared, and that girls and boys be no longer allowed to grow up so ignorant that, although they have learnt a good deal of mathematics, they require to be told, when they come to college, how to use squared paper, how to make simple experiments illustrating the principle of the parallelogram of forces, how to roughly determine density by weighing in water and by means of a bottle—all of which, as well as a number of other practical arithmetic exercises for children, are included by Prof. Nichols in his first volume. The incongruity is made still greater by the appearance in the introduction, ten pages after the description of the graphical method of representing results, of a somewhat elaborate discussion of "probable error" and the application of the method of least squares. Surely, also, no student nowadays should be allowed to complete a text-book and lecture course before entering on practical work—are we not seeking rather to invert this order? Were it not that the editor tells us that it is not expected that the experiments will be taken consecutively, the book might be regarded as helping teachers in the choice of a properly graduated course of experiments; and with this confession before one, it is impossible also to take exception to the somewhat extraordinary classification of the experiments—an instance of which is afforded by placing an exercise on the measurement of the curvature of a lens by means of the spherometer first in the course, at p. 26, whilst the determination of relative density "roughly" by weighing in water is relegated to chapter ii. p. 80. Some indication of the editor's experience as to the order in which the experiments are advantageously arranged in a junior course would have been valuable, as even to meet the exigencies created by the simultaneous presence of a large body of students, it is scarcely desirable to take physical exercises in any order. Again, we are told that no attempt has been made to provide a complete and sufficient source of information for laboratory students—on the contrary, it has been thought wise to encourage continual reference to other works and to original sources, so that it is impossible to complain of the book on the score of the incompleteness of many of its descriptions.

The second volume is more interesting, logical and original, and less fragmentary. It is intended for students who have completed the "course" in vol. i. and who are prepared to take up special work; in it the needs of those who are in training to become electrical engineers have been specially considered—a sign of the times—and it is for them especially that the parts treating of applied electricity, heat, and photometry have been written. Parts i. and ii. occupy about half the book, and comprise 53 direct and 64 alternate current experiments, the intention clearly being to frame a systematic course suited to those who have gone through a simple qualifying course in general physics. The instructions are very tersely worded, and but serve to give general guidance—which is very desirable in the case of students in whom it is desired to develop habits of independence. Immediately after the electrical engineering course, there is a very short section on electric-light photometry. Following this comes the least satisfactory section in the book, that on heat—dealing with the experimental determination of specific heats, heat of combus-

tion, vapour pressure, vapour density, heat of vapourisation, mechanical equivalent of heat, cubic expansion, and measurement of temperature by means of thermo-electric couples. Much of this might with advantage be placed in the qualifying introductory course, and the engineering student would gain little from the exercises which do not properly find a place there. Moreover, this section is grievously behind the times in many respects—under vapour density, not only is the sole method described "the classic one used by Dumas," but the picture is that which has figured in every text-book since Dumas' description was published in 1826, showing a stove which it would be impossible to find. Experiment 9 is headed, "Use of the Favre and Silbermann water calorimeter," an instrument which it is difficult to imagine *in use* by students. But Mr. Matthews, who is responsible for this section, is clearly not a Rip van Winkle, as he also describes the Bunsen ice calorimeter and Berthelot's heat of vapourisation apparatus.

Part. iv. of the second volume comprises outlines of advanced work in general physics, based chiefly on researches done in the physical laboratories of Cornell University, written for the use of students who have completed the routine work, and desire to enter upon original investigation. This section will scarcely be of value to outsiders, as every competent head of a laboratory has problems enough awaiting solution, and a text-book of research is scarcely a much-felt want. Excellent advice is given at the outset of this section, and yet it is, in part, of such a kind as to bring out only too clearly how much we are behind in our conception of what is right and proper in education. At this stage—the commencement of original investigation—says Prof. Nichols, there is a critical point. Further success depends upon several matters which have been necessarily somewhat neglected during the earlier periods. In the first place, the student must acquire independence and self-reliance; he himself must face the experimental difficulties of the problem upon which he may be engaged, and must overcome them by devices of his own. Surely, we ought not to wait so long—the first essential in teaching scientific method should be to develop habits of independence; and if from the outset we lead students, as far as possible, always to take up the attitude of the discoverer, there should be no critical point in their career, but they should insensibly escape from leading-strings and walk alone.

Being prepared specially for students at Cornell University, the book will scarcely be used very widely, and, indeed, is not suited for general use, I imagine; yet it appears to me to be of considerable interest to teachers, as marking a distinct step forward in the evolution of the text-book of the future. There can be little doubt that those students, at all events, who have a technical career in prospect, will be taught on lines such as are indicated by the arrangement of the subject-matter adopted by Prof. Nichols—that after going through a qualifying introductory course, in which they gain a general understanding of the main principles and of method, they will devote their attention to the technical study of whatever branch they may select. But it is to be hoped that they will be so taught at school that the introductory college course will not only be much shorter than is at present necessary, but of a much higher character; and that, as I have said above, they will be inquirers from the outset.

To carry such a scheme as I contemplate in this article into execution, however, teachers of all subjects must be trained in the school of research: surely this is the keynote of future progress in education, indeed of our national progress.

HENRY E. ARMSTRONG.

## NOTES.

The Council of the Royal Society have fixed Wednesday, May 1, for the first Sitting of the Session. The Ladies' Conference will be held on some convenient day in June, probably the 12th.

It is understood that Sir Joseph Lister, Bart., the Foreign Secretary of the Royal Society, will be nominated for the presidency of the Liverpool meeting of the British Association, to be held in 1896.

FRANK W. C. UNWIN, F.R.S., will deliver the "John Forester" lecture this year, at the Institution of Civil Engineers, on "The Development of the Experimental Study of Heat Motors."

A SERIES of Cantor Lectures, on Commercial Fibres, will be commenced at the Society of Arts, John Street, Adelphi, on Monday next, by Dr. D. Morris, C.M.G. The subsequent lectures will be on March 25 and April 1.

THE 1895 conference of the Camera Club will be held on April 2 and 3, under the presidency of Captain W. de W. Abney.

THE death is announced of Sir Edward Banbury, the author of "History of Ancient Geography." Mr. Alfred Giles, whose name is well known among engineers, has also recently died.

At the meeting of the Royal Meteorological Society, to be held on Wednesday, the 20th instant, a lecture will be given by Mr. W. N. Shaw, F.R.S., on "The Motion of Clouds considered with reference to their Mode of Formation."

THE Council of the Society of Arts invite members to forward to the Secretary, on or before April 15, the names of such persons as they may think worthy of the Albert Medal for 1895. The medal, which is given annually in recognition of "distinguished merit for promoting Arts, Manufactures, or Commerce," will be awarded in May.

It is interesting to note, in connection with the subject of Mr. Stromeyer's letter published last week, that Reuter's correspondent at San Francisco reports that vessels arriving there announce the occurrence, on the 21st inst., of an earthquake in the bed of the Pacific Ocean. The disturbance was accompanied by a loud roar, coming, apparently, from the sea, which became covered with a mass of white foam, and subsequently rose in numerous geyser-like columns.

MR. HENRY CHADWICK, the author of numerous works and memoirs on philology and mythology, and a member of the Council of the Anthropological Institute, died at the beginning of this month, in his eightieth year. So long ago as 1836 he planned, as engineer, and also surveyed, the Glasgow and South-Western Railway, with the Morecambe Bay Embankment. He was engaged a few years later in acoustic telegraphy, and was employed to report on the telegraph system for India. His writings cover a wide range of subjects, but he was best known for his contributions to philology.

Our attention has been drawn to a scheme, which owes its initiation to Canon Tristram, and for which further sympathy and support is needed. With the object of creating a more general interest in the study of Natural History, and to stimulate observation and research, it has been proposed to establish a fund for a medal or other prize to be given annually by the Natural History Society of Northumberland, Durham, and Newcastle-upon-Tyne, for the encouragement of field work and original observations in any branch of the subject, whether Botany, Geology, or Zoology. The prize will be offered for the best original and intelligent study of any of the common

objects noticed in the fields or woods, on the moors, or by the sea-shore, &c.; competitors to be residents in the counties of Northumberland or Durham, or in Newcastle-upon-Tyne. It has been determined to associate the medal with the name of the late Mr. John Hancock. The capital fund required to provide the medal will not be less than £200, towards which amount over £100 has already been given and promised. Subscriptions towards the fund may be sent to Mr. A. H. Dickinson or Mr. M. C. Potter, Hon. Secretaries of the Natural History Society, Newcastle-upon-Tyne.

THE intention of the Ottoman Government to establish a geodynamic observatory at Constantinople has already been noticed in these columns (p. 180). The new institution forms a section of the Imperial Observatory, and is under the direction of Dr. G. Agamennone, who has just issued a valuable list of earthquakes felt throughout the empire in 1894. The chief interest of this catalogue centres in the accounts of the great earthquake of July 10, and the detailed record of its after-shocks. In the Observatory registers there are also preserved many seismic notices relating to previous years, which are to be edited and published at the earliest opportunity.

THE seismic history of several districts in Italy has been worked out with great care and thoroughness by Dr. Mario Baratta. In his last paper (*Rivista Geogr. Ital.*, Gennaio, 1895), he treats of the earthquakes of Calabria Ultra. In this province there are five well-marked seismic centres, or radiants. From their position, and from the direction in which the epicentre is displaced, it is clear that they are closely connected with the prominent faults which have helped to shape the present surface features of the district. Dr. Baratta concludes that the earthquakes of 1783 were produced by vibrations of these faults, and that the shock of last November 16 was a repetition of the terrible disturbance of February 5, 1783, the areas most strongly affected by them both being almost or quite identical.

THE Council of the Marine Biological Association has authorised the expenditure during the present year of a considerably larger sum for boat hire than has been spent in previous years. Naturalists who visit the laboratory during the coming season may thus expect increased facilities in their work, and ample supply of material for their researches. The Council, moreover, has authorised the director to offer free tables in the Plymouth Laboratory to naturalists who will be willing to render assistance in the arrangement of the collections in the museum, and in the collecting operations at sea. It is to be hoped that many will take advantage of the efforts which are being made to extend the usefulness of the magnificent laboratory at Plymouth.

THE Prince of Monaco has recently reported upon the first scientific cruises of his yacht the *Princesse Alice*. The area investigated included the western basin of the Mediterranean, the Straits of Gibraltar, and the Gulf of Gascony, along the western coasts of Morocco, Portugal, and Spain, down to a depth of 4898 metres. Fifty-eight soundings and forty-six temperatures and samples of sea-water were taken in these localities. The trawlings made by the *Princesse Alice* in the western basin of the Mediterranean merely confirm the known poverty of the fauna of the great depths of this part of the Mediterranean; the Atlantic operations of the ship in 1894 were unfortunately impeded by prolonged and violent northerly winds.

MR. J. V. BUCHANAN, who has investigated the samples of water taken by the *Princesse Alice*, finds that the density of the Atlantic water is the same along the whole south coast of Spain as far as Cape Gata, owing to the existence here of a strong surface current setting eastwards. From Cape Gata eastwards

only the denser water of the Mediterranean proper is met with. The difference between the ratios of salinity to alkalinity in the case of the Atlantic and Mediterranean waters is not very great, but is clearly marked. The mean coefficient of the Atlantic samples examined by Mr. Buchanan was 0.5000, and of the Mediterranean 0.4875; while the minimum coefficient of the Atlantic samples was greater than the maximum coefficient of the Mediterranean. A possible cause of the difference between the Mediterranean and Atlantic waters is sought in the abundance of calcareous rocks on the coasts of the former sea.

THE first number of the new *Chilian Journal of Hygiene* has recently been issued. It is published under the direction of the Institute of Hygiene recently established in Santiago, and is printed in Spanish. The present volume confines itself to the history and development of the organisation of public hygiene in general throughout Chili, and an account is also given of the provision for official hygienic administration in Germany, France, England, and Belgium. One of the functions exercised by the Santiago Hygienic Institute is the analysis of substances for purposes of trade and commerce, and the granting of official certificates as to their quality. Considering the enormously high death-rate of Santiago, which is stated to reach 57 per 1000, some reform in hygienic matters is urgently needed, and it is to be hoped that the establishment of this new Bureau of Public Health may beneficially stimulate public and private enterprise in this direction.

WE could not have a better example of the insufficient morphological descriptions which have become attached to some micro-organisms, than that afforded by Mr. A. Coppen Jones in his memoir on the tubercle bacillus, lately published. This investigator has studied this micro-organism for several years past at Davos, where he has had ample opportunity for the collection of tuberculous material, and, after most elaborate and painstaking researches, he considers that we are not yet in a position to assign its correct morphological place to the organism associated with consumption. Mr. Jones is of opinion that it probably stands in close relation to the moulds, and that it has far more right to be regarded as belonging to this category than to the schizomycetes in the strictest sense of the word. The conclusions are based upon very careful observations, and the memoir is abundantly furnished with beautiful illustrations. The tetanus bacillus has also been seen associated with mycelium threads, and Almquist is stated to have isolated two bacterial forms which produced a branched mycelium. The subject is a most interesting one, and well worthy the attention of morphologists.

AT the meeting of the French Meteorological Society on February 5, an important discussion took place on the subject of anemometry and the vertical currents of the atmosphere, which have sometimes been recorded by the so-called clinanemometer. M. Ritter thought that the ascending currents registered by those instruments were simply due to deviations of the atmospheric currents by obstacles, such as the tower on which the recording instrument was placed, which divides the current laterally, and also deflects it in an upward direction. M. Angot stated that such vertical currents do not rise to any great height, in proof of which he said that on making the ascent of the Pic du Midi, with an ascending wind caused by striking the incline of the mountain, a number of small papers thrown into the current only rose a few metres, and then fell down behind the observer. These observations tend to modify to a great extent the results of experiments on vertical atmospheric currents, which have from time to time been published, and make it advisable for further experiments to be carried out.

THE Report of the Meteorological Council for the year ended March 31, 1894, has been recently presented to Parliament.

In the department of ocean meteorology, the preparation of current charts for all oceans have been regularly proceeded with; the Council have procured from foreign meteorological offices nearly all the observations for the Pacific Ocean, with the view of rendering the generalised results as trustworthy as possible. The preparation and extraction of data for the south Atlantic and west coast of South America, have also been actively prosecuted. In the branch of weather telegraphy and forecasts, an important addition has been made by the receipt of daily reports from two stations in the Azores. Forecasts are prepared three times a day, either for publication in newspapers, or for the preparation of storm warnings, while during the hay-harvest season, forecasts were supplied to farmers and others, and were also widely distributed by the Board of Agriculture. The total percentage of success of these agricultural forecasts reached 91, being the highest yet recorded. Among the various publications the *Weekly Weather Report* supplies a very complete view of the chief meteorological changes over the greater part of Europe; considerable progress has also been made with the rainfall tables of the British Isles, the total number of stations for which the values for 1881-90 will be furnished is approximately 430, so that the general distribution of rainfall over our islands will be well represented. Among the miscellaneous researches carried on by the Council, we may mention the comparison of Dines's pressure tube anemometer, which shows the wind pressure at each instant; the vane is erected 93 feet above the ground, and the recording portion is in a room in the Meteorological Office. Upon the whole, the comparison speaks strongly in favour both of the reliability of this instrument, and of the mean record yielded by the Robinson cup anemometer, which has hitherto been generally in use, both in this country and abroad.

IT has often been observed that a bright scarlet uniform will in a good photographic dark-room with ruby-glass windows, appear perfectly white. On this subject Herr H. W. Vogel made some interesting communications to the Physical Society of Berlin at a recent meeting. Experimenting with oil lamps provided with pure red, green, and blue colour screens, he found that when white light was rigidly excluded, all sense of colour disappeared to the observers, and nothing but shades of black and white could be distinguished on objects in the room. He further found that a scale of colours illuminated by red light showed the red pigments as white or grey, which abruptly turned into yellow, and not red, on adding blue light. Hence a colour was perceived which was not contained in either of the sources. Red and yellow patches appeared of the same colour, so that they could hardly be distinguished. But the difference was at once brought out by adding green instead of blue light. How very much the kind of sensation experienced depends upon the intensity of illumination is easily seen in the case of the region of the spectrum near the G line of Fraunhofer. This region appears violet when its luminosity is feeble, blue when it is stronger, and may even appear bluish-white with strong sunlight, so that the assertion often made that with normal eyes a definite colour-sensation corresponds to a definite wave-length, cannot be upheld. Herr Vogel comes to the conclusion that our opinion as to the colour of a pigment is guided by our perception of the absence of certain constituents. Thus a red substance is only recognised as such when light of other colours is admitted, and we perceive its inability to reflect these.

AT the meeting of the Institution of Civil Engineers, on Tuesday, March 5, two papers, dealing with the transmission of power by electricity, were read. The first, on "Electrical Haulage at Earnock Colliery," by Mr. Robert Robertson, contained an account of the general features of the colliery and of

those of its seams into which electrical hauling-engines had been introduced to drive endless ropes, and to replace horse-traction between the main haulage-roads and the working-faces. The electrical generating plant comprised a dynamo for supplying power to the electrical hauling-engines, capable, at a speed of 620 revolutions per minute, of an output of 100 amperes at 490 volts. Two electrical hauling-engines, of which the main features were similar, were used. The two cables of stranded steel wire  $\frac{3}{4}$  inch in diameter, operated circuits of 2160 yards and 1020 yards in length respectively. The cables were driven continuously at a uniform speed, and the coal-hitches were attached to or detached from them by a Smallman clip. The efficiency of the plant as compared with the horse-traction, which it had replaced, was also considered. The electrical haulage-system in the Ell coal seam was capable of a daily output of 400 tons. The daily output by horse-traction had been 180 tons, and to increase this to 400 tons, thirty or forty horses would have been required, a number which could not have been employed in the available space without confusion. The daily output of the electrical haulage-system in the main coal-seam, which was not yet working at its full capacity, was between 150 and 200 tons. The yearly working expenses of the two systems were compared, upon the results of one and a half years' working, and were found to be £4130 and £1990 by horse-traction and by electrical haulage respectively, showing that an annual saving of £2140 had been effected by the latter. The total cost of the electrical installation had been £3500.

IN the second Paper—"Water-Power applied by Electricity to Gold-dredging," by Mr. Robert Hay—an account was given of plant which had been erected in New Zealand to utilise water-power for generating electricity to be transmitted to motors operating a dredge in different portions of a distant river. The plant described had been constructed for gold-dredging in the River Shotover, the course of which was for the most part in rocky gorges through rugged country, accessible only by tracks cut down the leading spurs and gullies. The water was obtained at a creek  $1\frac{1}{2}$  miles distant from the dredging ground, and was brought by a race cut in the side of the hill, or, in places where the ground was not suitable, in a timber-flume, to a pressure tank at a level of 524 feet above the pipes at the generator-house. From this tank to the wheel employed the water was carried in rolled-steel pipes. The prime-mover of the generating plant was a Pelton reaction water-wheel, upon the buckets of which the water, from a nozzle  $1\frac{1}{2}$  inches in diameter, impinged at a pressure of 228 lbs. per square inch. This wheel drove two series-wound dynamos working at a normal speed of 700 revolutions per minute, each developing a current of 40 amperes at an electromotive force of 650 volts, or together nearly 70 h.p. The conductors, of a length of two miles, were of No. 4 S.W.G. bare copper wire, and were supported upon insulators carried by cross-arms upon old 40-lb. rails. The current was conducted to two motors in the dredge, one for driving a centrifugal pump, and the other for operating the buckets, winches, and revolving cylinder. Two 10-ampere arc-lamps lighted the dredge at night, and were joined in multiple-series with the motors, with suitable arrangements for their control. The cost of the installation and the weekly working expenses were £7000 and £35 respectively.

At a recent meeting of the Academy of Science of Amsterdam, M. Kamerlingh Onnes presented a paper by M. L. H. Sierstema, on magnetic rotary dispersion in oxygen. Since making a preliminary communication on this subject, the author has improved his apparatus in several details, and is now able to examine the gas under a pressure of a hundred atmospheres. The oxygen employed was prepared by electro-

lysis, known method in which white light, having passed through the polariser, observing tube, and analyser, is then examined by means of a spectroscope. A dark band is thus obtained traversing the spectrum, and the analyser is turned till this dark band coincides with the part of the spectrum corresponding to light of any desired wave-length. With currents between 35 and 65 amperes, the author is able to get rotations of from  $3^\circ$  to  $4^\circ$ . In the case of oxygen the results are very well expressed by the formula  $\gamma = \frac{868 \cdot 028}{\lambda} \left( 1 + \frac{0 \cdot 07203}{\lambda_g} \right)$  where  $\lambda$  is the wave-length in thousandths of a millimetre; the mean error in  $\gamma$  being  $\pm 17 \cdot 5$ . This formula is deduced from the formula  $\gamma = \frac{c}{\lambda} \left( n - \rho \lambda \frac{\delta n}{\delta \lambda} \right)$  where  $n$  is the refractive index, given by Mascart. A series of measurements were also made on atmospheric air, and the values for nitrogen deduced by comparison of these numbers with those obtained for oxygen. The expression thus obtained for nitrogen is as follows:—

$$\gamma = \frac{560 \cdot 41}{\lambda} \left( 1 + \frac{0 \cdot 32424}{\lambda^2} \right).$$

AN interesting series of experiments have been carried on by Mr. T. Andrews, on the influence of stress on the corrosion of metals, which may have considerable practical applications. Bars of iron or steel were subjected to different stresses, and were then placed in some electrolyte—generally a solution of common salt—and the difference of potential between them measured. It was found that tensile stress caused the production of an average E.M.F. of 0.016 volt between the strained and unstrained bars, the latter being positive. The effect of torsional stress was to produce an average E.M.F. of 0.012 volt in the same direction. Similar results were obtained with flexional strains. From the data obtained, the author deduces a number of interesting conclusions which bear on the corrosion of iron structures, for which we must refer to the original paper in the *Proceedings of the Institution of Civil Engineers*, cxviii. 4.

THE ever-increasing precision in the study of the geological distribution of fossils renders it necessary, from time to time, to recognise that a well-marked lithological division, though of the greatest value in geological mapping, does not represent a definite time-level, but may gradually rise or fall in time as it is traced along its outcrop. This fact is well illustrated in England by the Cretaceous beds underlying the true Chalk, and some of the questions involved have been discussed in two recent papers in the *Geological Magazine*. The first of these, by Messrs. Jukes Browne and Meyer (November, 1894) deals with the Upper Greensand and Chloritic Marl. They point out that the latter term has been applied—and may justly be in its lithological sense—to various horizons up to the zone of *Belemnitella plena* (as at Beer Head), and they propose that if the name be retained it should be strictly limited to the zone of *Stauronema Carteri*, which may be regarded as the bottom bed of the true Chalk. They further point out that the well-known Warminster fossils are a mixture of two faunas—the majority coming from the summit of the true Upper Greensand, just below the *Stauronema* zone, though some are from that zone itself, the state of preservation being different in the two cases. Thus the confusion between Chloritic Marl and Warminster Greensand is due to a mixture of fossils from different levels—an accident that has often caused confusion in other formations—and a complete revision of the lists of fossils from these horizons must precede any further correlation. The second paper, by Dr. J. W. Gregory (March, 1895), deals with the Gault and Lower Greensand. After considering evidence of various kinds, he comes to the conclusion that the conformable passage from sandy beds into clay rises in time as it passes westward from Kent to Surrey, much as the upper limit of the

clay sinks further west towards Wiltshire. The lowest zone of the Gault in Surrey that has the typical clayey facies is equivalent to the fourth or higher zone of the Folkestone Gault, the lower zones being represented in the so-called "Folkestone Sands." Dr. Gregory indicates the levels at which, in Kent and Surrey respectively, the limits of the Albian, Upper and Lower Aptian, and Rhodanian formations of the Continent can be drawn; but insists on the necessity of continuing to recognise the old lithological divisions side by side with the new palaeontological ones. He also gives a critically revised and extended list of fossils from the phosphate beds of Great Chart, near Ashford, Kent.

THE 1894 "Report of Observations of Injurious Insects and common Farm Pests," by Eleanor A. Ormerod, will not yield to any of its predecessors in interest, value, or variety. The general character of these Reports is so well known that it is unnecessary to dwell upon it; but the present part gives prominence to several considerations which have not hitherto received very much attention. The first of these is the undoubted fact that almost any of the 12,000 species of insects inhabiting the British Islands, except those which feed exclusively on other insects, may, under certain circumstances, or when unusually abundant, become entitled to a place in the category of injurious insects. Thus, the present Report opens with figures and descriptions of three species of *Leptoptera*—the Eyed Hawk Moth, the Lappet Moth, and the large Tortoiseshell Butterfly—which are not generally so common in England as to be thought capable of causing serious injury; indeed, Miss Ormerod herself suggests that such pests might easily be got rid of by inviting an entomologist to clear them off. One of the most important insect visitations during the past year was that of the Antler Moth (*Charaxes graminis*) in South Scotland, where the larvæ fed on the tender grass which sprang up over the districts previously devastated by the vole plague. Several pages are devoted to hay mites, which appear, however, though sometimes excessively abundant, to cause little real damage. Other interesting creatures noticed are the eel-worms (in her account of which Miss Ormerod has unintentionally in part anticipated Prof. Percival's important paper on the subject in *Natural Science* for March, as fully explained in an accompanying note), horse-warble, winter gnats, wasps, &c. It does not appear to be quite certain whether the horse-warble is the same species as the ox-warble. Warble in the horse appears to be of much less common occurrence than in the ox, and usually to occur only in small numbers in the same animal. But this may be due to the horse being a more carefully-tended animal than the ox. Two other points of interest deserve notice. Several species of carnivorous ground-beetles are stated to be very destructive to strawberries. More information is certainly required as to how far so-called carnivorous insects will also eat vegetable matter, decaying or otherwise. It appears that sea-gulls are sometimes in the habit of frequenting turnip-fields infested with the Diamond Back Moth, and in one instance a farmer attributed the destruction of his crop to the gulls. So easy is it to make a serious error in discriminating between the farmer's friends and foes.

A NEW and particularly convenient method of preparing the unsaturated hydrocarbon allylene,  $C_3H_4$ , has been discovered by Prof. Keiser and Miss M. B. Breed, as the result of an investigation concerning the action of magnesium upon the vapours of the alcohols. Preliminary experiments showed that when magnesium is heated with organic compounds such as alcohols, acids, and ketones, a reaction of considerable energy occurs at more or less elevated temperatures, accompanied by incandescence of the metal. The reactions between magnesium

and the alcohols were then systematically studied. The magnesium, in the form of filings, was placed in a porcelain boat, and heated in a combustion tube through which the vapour of the alcohol was conducted. At a low red-heat the magnesium usually commenced to glow at one end of the boat, and the incandescence was then rapidly communicated to the whole quantity of metal, while large volumes of gas were evolved from the tube. When methyl alcohol is employed the action is extremely energetic, and the gases evolved consist mainly of about four-fifths hydrogen and one-fifth marsh gas. The residue in the boat is then allowed to cool in the vapour of the alcohol, when it is found to have the appearance of a black coherent mass. When this solid residue is placed in water a gas is slowly evolved, and if a few drops of ammonium chloride are added, the gas is liberated in a steady and moderately rapid current. The odour of the gas resembles that of acetylene, but when it is conducted through an ammoniacal solution of cuprous chloride the greenish yellow precipitate of cuprous allylide is produced, and with an ammoniacal silver nitrate solution the white crystalline precipitate of silver allylide is formed. These precipitates are highly explosive after separation and drying, a temperature of  $150^\circ$  being sufficient to bring about their explosion. When they are treated with dilute nitric or hydrochloric acids they dissolve with evolution of allylene. Ethyl alcohol behaves similarly towards heated magnesium, and the black residue left in the boat after the completion of the reaction is similarly decomposed by water with liberation of allylene, the rapidity of evolution of the latter being also largely augmented by the addition of a little ammonium chloride. The most convenient alcohol to employ, however, is propyl alcohol, for the black magnesium residue is in this case decomposed much more rapidly by water at the ordinary temperature, and the yield of gas is considerably larger. Prof. Keiser states that this method of preparing allylene for lecture purposes, by the reaction between magnesium and propyl alcohol, and subsequent decomposition of the product by water, is far preferable to the ordinary method of decomposing propylene bromide with alcoholic potash. Most of the other alcohols likewise afford magnesium residues which liberate allylene when brought in contact with water, but the gas is rarely so pure as that derived from the use of propyl alcohol.

THE additions to the Zoological Society's Gardens during the past week include a Macaque Monkey (*Macacus cynomolgus*, ♂) from India, presented by Mrs. Turner-Turner; an Azara's Fox (*Canis azarae*) from Brazil, presented by Messrs. Edgar and Harold Turner; four Amadavade Finches (*Estrela amantava*) from India, presented by Mrs. Faulkenor; a Chukar Partridge (*Caccabis chukar*) from India, deposited; a Sykes's Monkey (*Cercopithecus albigularis*, ♀) from East Africa, two Red-crested Pochards (*Fuligula rufina*, ♂ ♀) from India, purchased; a Great Kungaroo (*Macropus giganteus*, ♂), three Hunter's Spiny Mice (*Acomys hunteri*) born in the Gardens.

#### OUR ASTRO-NOMICAL COLUMN.

SPECTRUM OF THE ORION NEBULA.—A full account of the photographs of the spectrum of the Orion Nebula, which were taken with Mr. Lockyer's 30-inch reflector at Westgate-on-Sea in 1890, has just been published in the *Philosophical Transactions* (vol. 186 A, p. 73.) Four hydrogen lines more refrangible than K are shown on the photographs, and in all 54 lines have been recorded. The line near wave-length 3730, first discovered by Dr. Huggins, is a very strong line, and among other prominent lines, is the well-known chromospheric line at wave-length 4471. It is shown that many of the principal lines are coincident with bright lines photographed in the spectrum of P Cygni at South Kensington, and with bright lines in planetary nebulae and bright line-stars photographed by Campbell and Pickering, so that a close connection of these bodies is

established. Other tables show a close relationship between the brightness of the nebula and the dark lines in the so-called "dark stars," of which Rigel and Bellatrix are typical examples.

The following are the conclusions to which the investigation has led:—(1) The spectrum of the nebula of Orion is a compound one, consisting of hydrogen lines, low temperature, metal lines and flaring, and high temperature lines. The mean temperature, however, is relatively low. (2) The spectrum is different in different parts of the nebula. (3) The spectrum bears a striking resemblance to that of the planetary nebulae and bright-line stars. (4) The suggestion, therefore, that these are bodies which must be associated in any valid scheme of classification is strengthened. (5) Many of the lines which appear bright in the spectrum of the nebula, appear dark in the spectra of stars of Groups II. and III., and in the earlier stars of Group IV.: a gradual change from bright to dark lines has been found. (6) The view, therefore, that bright-line stars occupy an intermediate position between nebulae and stars of Group III., is greatly strengthened by these researches.

THE ECLIPSE OF THE MOON. The earlier phases of the total eclipse of the moon on Monday morning were observed under very favourable circumstances in the neighbourhood of London. The penumbra was not distinctly visible until about ten minutes before contact with the shadow, and the whole disc of the moon remained clearly visible, even at the middle of totality, until clouds stopped observations about 4 a.m. The parts deeply immersed in shadow were intensely red throughout, and with the telescope all the principal formations could be easily distinguished. During totality the sky was exceptionally clear, and numerous occultations were observed without difficulty. For half an hour after the commencement of totality the brilliant edge of the moon was pretty brightly illuminated, and presented a striking contrast with the redness of the advancing penumbra; at mid-eclipse, however, the whole of the disc was very red.

It is reported that nearly 140 observations of disappearances or reappearances of eighteen stars were secured at the Royal Observatory on Monday morning by the eleven observers who watched the progress of the eclipse.

THE NATIONAL ALMANAC, 1898. In the recently published volume of the British Ephemeris for 1898, we note several valuable additions. The places of eleven close circumpolar stars, four of which are in the northern hemisphere, are given for each day of the year, and the mean places of fifty-two additional stars for navigational purposes have been added. The improved expansions of the contents will also no doubt be generally appreciated. The publication of an abridged edition for the use of seamen is a step in the right direction.

### PHYSICAL WORK OF HERMANN VON HELMHOLTZ.

I.

[THE author we are to consider this evening was a career of "natural distinction." In a day when the range of "natural powers" is so vast that most workers are compelled to be content if they contribute something to one or two of the subdivisions of one of the main branches of science, von Helmholtz showed that it is not impossible to be at once a great mathematician, a great experimental physicist, and, in the ancient sense of the term, a great biologist.

It was but eight months yesterday since he delivered his address before the Royal Society, to-day, since he died, and the struggle has been for us to attempt to decide on the exact place which will be assigned to him by posterity; but making allowance for the fact that such age is a fit to place its own great among the greatest, and giving all allowance for the spell which his fame cast over many of us in the lecture rooms where we have first gained our knowledge of science, I am sure that I only express the views of all those who know his work when I say that we place him in the very front rank of those who have led the greatest scientific movement of our time.

It is, perhaps, I have now to justify. I must try to convey to you in some forty minutes an outline of the work of more than thirty or forty years, to give you a general idea of the wide range of the multitudinous activities which were crowded into them, of the varied and fruitful with which the most diverse problems were

attacked and solved, and, if it may be, some image of the man himself. The task is impossible, and I can but attempt some fragments of it.

The history of von Helmholtz is in one respect a simple tale. There are no life and death struggles with fate to record. His work was not done with the wolf at the door, or while he himself was wrestling with disease. He passed through no crises in which success or failure, immortality or oblivion, seemed to depend on the casting of a die. He suffered neither from poverty nor riches. He was a hale strong man on whom external circumstances neither imposed exceptional disabilities, nor conferred exceptional advantages, but who, by sheer force of the genius that was in him, passed on from success to success till he was recognised by all as the admirable Crichton of modern science, the most widely cultivated of all students of nature, the acknowledged leader of German science, and one of the first scientific men in the world.

It is the more fitting that this evening should have been set aside for the consideration of the work of Helmholtz, in that England may claim some share in his greatness. Before her marriage his mother bore an English name—Caroline Penn; she was, as her name implied, of English descent. His father was a Professor of Literature in the Gymnasium at Potsdam, so that his early days were passed amid that plain living and high thinking which are characteristic of intellectual circles in Germany. The boy did well at school, and when the time came for choosing a profession, his passion for mathematics and physics had already developed itself. The course of his love for these sciences did not run quite smooth. The path of his ambition was crossed by the hard necessity which in some cases checks, in others fosters, but in all chastens the aspirations of youth. He had to make his livelihood. Science must be to him what the Germans happily call a "bread-study." Medicine offered a fair prospect of prosperity. Physics, in those days, was but an intellectual pastime. And so the young man took his father's advice, and became an army doctor. In this, as in so many other cases, "the path of duty was the way to glory."

It is possible that if von Helmholtz had been what—with a sad consciousness of the limitations it implies—I may call a mere physicist, he would have played a greater part in the development of some of those subjects, the study of which he initiated or helped to initiate, but did not thereafter pursue. It is possible that had he been a biologist, and nothing more, he would have followed up the early investigation in which he disproved the old theory that putrefaction and fermentation are chemical processes only, clearly indicating, if he did not actually demonstrate, that the decay which follows death is due to an outburst of low forms of life.

He might thus under other circumstances have done work for which he showed his competence, but which is now chiefly associated with other names; but it is certain that without the unusual combination of wonderful mathematical power and a professional knowledge of anatomy he would never have accomplished the special tasks which it is his special glory to have achieved.

His first three papers, however, hardly displayed the fusion between his various powers which was afterwards so remarkable a characteristic of his work. The first two were on biological subjects. The third was the famous essay on the "Conservation of Force." I have told elsewhere the story of the dramatic circumstances under which it was given to the world, of the interest it excited among the members of the Physical Society at Berlin, the refusal of the editor of *Poggendorff's Annalen* to publish it, and the final triumph of the author and his views. (*Fortnightly Review*, November 1842.) Helmholtz was not, and did not claim to be an original author of the doctrine of the conservation of energy; but two young men, Sir William Thomson in England, and Helmholtz in Germany, independently, and within a month of each other, were the first persons who compelled the scientific world to regard it seriously.

The title is one interesting fact which connects this essay directly with the Royal Institution. Four years after it was published, it was placed by Du Bois Reymond in the hands of one who was lost to science in the same year as von Helmholtz himself—the late Prof. Tyndall. He was much impressed, and has spoken of the incident as bringing him face to face with the great doctrine of the "Conservation of Energy." ("Introduction to Popular Lectures by Helmholtz," translated by E. Atkinson, 1873.) He translated the essay into English, and

A Lecture delivered at the Royal Institution by Prof. A. W. Rucker, on Monday, 12th, March, 1895.

for many years made it his habit to place every physical paper published by Helmholtz within the reach of English readers.

And now, having brought you to the point at which Helmholtz may be said to have been fairly started on his life's work, let me first briefly describe his official career, before I consider his work in greater detail.

When his extraordinary abilities became evident, he was permitted to sever his connection with the army. At twenty-seven years of age he became Teacher of Anatomy in the Academy of Arts at Berlin. In the next year he was appointed Professor of Anatomy and Physiology at Königsberg, and he held similar posts in the Universities of Bonn (1855-58) and Heidelberg (1858-71). It was not till 1871 that his early love for physics was finally rewarded. When the chair of Physics was to be filled in the University of the newly-founded German Empire, in Berlin, it was felt that even in Germany—the land of specialists—no better occupant could be found than one who was then in his fiftieth year, and had been all his life a teacher of anatomy and physiology. The choice was universally approved and completely justified, and von Helmholtz held this post till his death.

In this connection I am, by the kindness of Sir Henry Roscoe, enabled to show to you a relic of remarkable interest. It is a photograph of the great teacher and investigator, taken at the very last lecture that he delivered—that, namely, on July 7, 1894.

For some years, that is, from the date of its foundation, von Helmholtz was the president of the *Physikalisch-Technische Reichs-Anstalt* in Charlottenburg. This institution, founded partly by the munificence of the late Dr. Werner Siemens, partly by funds supplied by the State, has no precise analogue in this country. It is devoted to the carrying out of systematic researches on questions of fundamental importance to which a long time must be devoted.

The most characteristic work of Helmholtz was, as I have already hinted, that in which his knowledge of physics and his knowledge of anatomy were both directed to a common end. He dealt in turns with the external physical phenomena, with the mechanism of the organs which the phenomena affect, with the relations between the mechanical effect on the organ and the sensations which it excites, and, lastly, with the connection between the sensations in those simple cases which can alone be investigated in the laboratory, and the complex laws of æsthetics and art.

The two books in which these problems were chiefly treated were the "Physiological Optics," and the "Sensations of Sound." It is impossible to do more than lay before you a sample which may afford some idea of the intricacy of the problems with which he dealt, and of the pitfalls amongst which he walked so warily. For this purpose I have chosen one branch of his work on "Sound."

I have deliberately selected that particular portion which has been most questioned, that on which the verdict of most of those who have sat in judgment on his views has been against him.

In discussing this question I must give a general description of the principal phenomena; but if I were to attempt an exhaustive catalogue of all the facts disputed and undisputed, and of all the theories which have been based upon or upset by them, not only would time fail me, but those who have not given special attention to the subject would, I fear, become hopelessly confused amid the chaos of opposing statements and views. Another reason which urges me to be brief, is that a few years ago Prof. Silvanus Thompson explained the whole subject to the members of the Royal Institution, having kindly consented to act as the mouthpiece of the celebrated instrument maker, König, who has played so large a part in these controversies.

Among the chief achievements of Helmholtz was an explanation of the physical difference between pairs of notes which we recognise as concords and discords respectively. When two neighbouring notes are sounded, alternate swellings and fallings off of the intensity are heard, which are called beats. These produce an unpleasant effect, which depends partly on their number, partly on the relative pitches of the beating notes. When two notes beat badly, they form an intolerable discord. When they become separated by a wider interval, the beats are so rapid that they cease to be unpleasant.

The sense of dissonance produced by many of these wider intervals, such as the seventh (4:7), requires further explanation. In general, the fundamental musical note is only the first

and loudest of a series of so-called partials, whose vibration frequencies are 2, 3, 4, &c., times that of the fundamental, and the consonance and dissonance of two notes is shown to depend on the presence or absence of beats between important members of these series. Thus in the case of the seventh the frequencies of the octave of the lower note and that of the upper note would be in the proportion 8:7, which are sufficiently near to make the beats very prominent and disturbing.

In cases where the notes are pure, that is, are not accompanied by upper partials, the explanation of dissonance is based upon another phenomenon.

When two notes are sounded simultaneously a third tone is often perceived, the frequency of which is equal to the difference of their frequencies. The number of vibrations of this tone is equal to the number of beats, and as there has been controversy as to whether the beats when they become rapid can produce a note, and if so, whether this note is or is not the same thing as the difference tone, it is necessary to distinguish between the two. This distinction is to be found in the mode of their production; but for the moment it is sufficient to remember that they may be distinguishable, and to reserve for them two names, viz. the beat-note, and the first difference tone respectively.

Helmholtz drew attention to the fact that together with the difference tone there is also produced a note, the frequency of which is equal to the sum of those of the two primaries, and this he called the first summation-tone.

Together with these he believed that there existed summation and difference tones of higher orders, the whole series being included under the name of combination tones. Our sense of dissonance between pure notes was explained as dependent on beats produced by the combination tones.

Up to the time of Helmholtz it was generally thought that these tones were produced in the ear itself, and had no objective existence in the external air. They are thus often called subjective, but as that adjective is usually reserved for impressions produced in the brain itself, it is better to say that they were regarded as *ear-made*. Helmholtz himself gave a theory, which showed that it is probable that a membrane like the drum-skin of the ear, which is forced out of shape by pressure, and that bones, like those in the ear, which can rattle, would, if acted upon by two notes, manufacture by their own proper movements all the varied combinational tones which his theory postulated. He therefore believed that combinational tones were largely ear-made.

You will observe that his theory of discord is quite unaffected by the question whether the combination tones are or are not sometimes objective. Provided only they are produced at all, it is immaterial whether they are produced in the ear itself. Von Helmholtz admitted that the phenomena we observe are in most cases ear-made tones; but he also asserted that they were sometimes objective, and could set bodies tuned to vibrate with them in resonant motion. This latter statement has been denied with singular unanimity, sometimes, I think, without due regard to the limitations which Helmholtz himself placed on the conditions under which the objective character of the notes can be realised.

All ordinary calculations as to the production and mingling of different waves of sound are based upon the supposition that the displacements of the particles of air, or other body through which the sound is travelling, are very small. If this is so, the force which tends to restore each disturbed particle to its ordinary position of equilibrium is accurately proportional to the amount of the displacement.

In von Helmholtz' view, objective combination tones were in general produced when the disturbance was so great that this condition was no longer fulfilled. Violence is of the essence of the explanation. Hence the siren, where both sets of holes open into the same small wind-chest—the harmonium, in which two reeds alternately close and open slits in the same enclosure, are the instruments best suited to produce them. Of these the siren is the more efficient. Von Helmholtz convinced himself that the combination tones produced by the harmonium are for the most part ear-made. He expressly stated that "when the places in which the two tones are struck are entirely separate and have no mechanical connection, as, for example, if they come from two singers, two separate wind instruments, or two violins" to which we may add two tuning-forks—"the reinforcement of the combinational

tones of resonance is small and dubious." ("Sensations of Tone," translated by Ellis, p. 157.)

Now this reinforcement by resonators has been altogether denied by most of those who have taken an interest in the matter, while, if an exception is allowed, it is in favour of the ears. As Helmholtz and others, the observed effects being ascribed to the ears, and not to the difference tone.

Some writers make no exception whatever in their denial of the objective reality of what may be broadly termed secondary tones. Thus Mr. Bosanquet, who made a most careful series of experiments some fourteen years ago, stated that "the ordinary first difference tone . . . is not capable of exciting a resonator. . . . In short, the difference tone of Helmholtz . . . as ordinarily heard, is not objective in its character." (*Phil. Mag. Ser. 4*, 1881, p. 233.)

Prof. Preyer, too, using very sensitive tuning-forks, found that the differential tone given by two forks did not affect a fork the frequency of which corresponded with its own, except in cases where the difference tone was itself a partial of one of the forks.

It must be remembered that the assertions of Helmholtz as to the experimental proof of the objective nature of the tones were made with reference to those instruments which he regarded as most likely to produce objective notes, viz. the siren and the harmonium, and that, therefore, experiments with forks hardly affect his position.

Let us now try with the siren whether it is possible to confirm or to disprove the validity of his views.

For this purpose the rather bulky apparatus which you see before you has been constructed. I should hardly have been able to realise the idea embodied in it, at all events in time to show it to you this evening, if I had not been favourably situated in two respects. In the first place, I have had the zealous co-operation of one of my assistants, Mr. Edwin Edser, who has not only made all the parts of the apparatus that required to be newly made, but has thrown himself into the investigation with the most energy, working at it late and early, and making many valuable suggestions and improvements. In our joint work we have been helped by some of my senior students, and notably by Messrs. Cullen and Forsyth. In the second place, I have had at my disposal the magnificent collection of acoustical apparatus in the National Museum at South Kensington, some of which I am allowed, by the kindness of the Department of Science and Art, to bring here this evening.

wave-length of light, the path of the ray which falls upon it is shortened by a whole wave-length, and the position of each band is shifted to that previously held by its neighbour. If the fork vibrates with an amplitude of this almost infinitesimal amount, the bands will disappear, or will alternately appear and disappear according to circumstances. The fork may therefore be used to detect by resonance the presence of vibrations, the frequency of which is 64 *per second*.

*A priori*, there were two difficulties of opposite kinds which made it doubtful whether the fork would be an efficient weapon for the purpose for which it was to be used.

In the first place it would feel tremors of any sort, and it was doubtful whether it would be possible to discriminate between mere shakes and the vibrations which were to be studied. This difficulty has been very largely overcome.

The table on which the apparatus stands rests on india-rubber. On the table are a pair of library steps; these support two pieces of wood, which are heavily weighted and rest on india-rubber balls. From these two beams hang steel wires, which carry india-rubber door-fasteners, and these in turn support two rods on which the paving-stone is placed. By this alternation of elastic and of heavy bodies we can make the bands absolutely steady, unless the disturbances are violent. The quick movements necessary for working the apparatus, the blowing of the bellows, and the like, produce no effect. On the other hand, the shutting of a door in a distant part of the building, the rumble of a cart in the street, will cause the bands to disappear. A great deal of the work on which we rely has been done at South Kensington between midnight and three o'clock in the morning. Trustworthy observations have indeed been made at other times, but it is only in the still small hours that the apparatus is at its best.

The second doubt was of a different kind. It was certain that the instrument would be more or less shaken; it was not quite certain whether the fork would respond to vibrations of the given period. It is easy to set a tuning-fork in vibration by resonance when it is mounted on a sounding box, but in that case the vibrations of the enclosed mass of air are communicated through the box to the fork. When the stalk of the fork is held rigidly, a tuning fork is notoriously difficult to excite by resonance. This objection is, of course, to some extent counter-balanced by the extraordinary sensitiveness of the means of detecting the vibrations, but it is necessary to supplement this by other devices. The instrument used is a siren (s). In front of it is placed a hollow wooden pyramid, the narrow end of

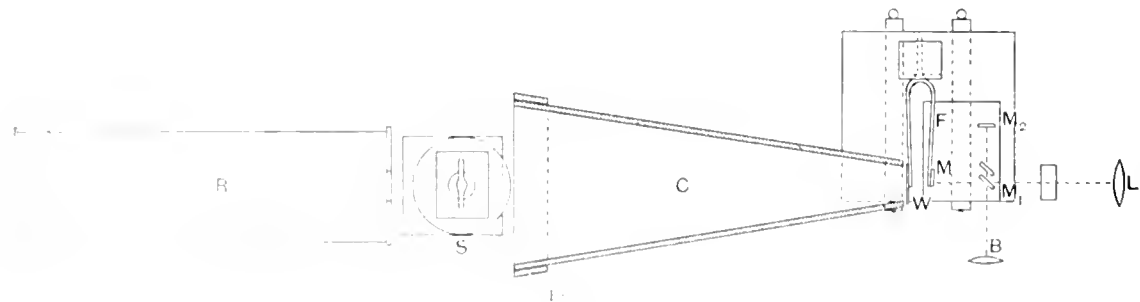

The essential parts of the apparatus, Fig. 1, is a tuning-fork,  $F$ , to one prong of which is attached a mirror,  $M_1$ , and to the other a piece of thin wood, strengthened by ribs, which is of the same weight as the mirror. The fork thus loaded has been compared with one of König's large standards by means of Lissajous' figures. Its frequency does not differ from 64 complete vibrations per second by more than one vibration in two minutes. The shank is supported by a mass of lead, which in turn is placed upon a paving-stone. Upon this stone also rest the other mirrors necessary for producing Michelson's interference bands. The mirror  $M_2$  is silvered so thinly that half the light which falls upon it is reflected, and half is transmitted.

Any proceeding light from the lantern,  $L$ , will be divided at  $M_1$  into two rays, which follow the paths  $M_1M_2M_1$  and  $M_1MM_1$  respectively. Interference bands are thus produced, which can be projected on a screen, so as to be rendered visible to a large audience.

Light from one prong of the tuning-fork may travel through the eighty-three inch of an inch, that is, through a distance equal to a half

which is near to, and is of the same area as the wooden plate attached to the tuning fork. This serves to collect the waves of sound, and to concentrate them on the fork. Behind the siren is a large resonator by König, timed to respond to 64 vibrations per second.

In some respects the apparatus requires careful handling. Of course if you blow down the collecting cone the fork may be disturbed, and sometimes a particular note of the siren appears to affect the fork for no very obvious reason. Probably the resonance of the air in the cone, or the vibrations of the wooden disk, may at times be the causes of such effects. We have, however, found that whatever they may be due to, they differ in appearance from those produced by vibrations synchronous with the period of time of the fork, and they can in general be got rid of by a very slight readjustment of the apparatus. The fact that our main conclusions do not depend on any such nicety, is proved by the fact that the instrument has been set up twice in the laboratory, and once in the lecture-room in the College. In



each case all the experiments have been successful, and on one occasion only were we troubled by a disturbance due to a note (of about 253 vibrations) when sounded alone. A slight readjustment of the cone, however, eliminated this effect entirely.

Such difficulties make it no easy matter to set up the apparatus in a hurry, and the most I can hope to do this evening is to demonstrate to you the methods of using it. I cannot undertake to make the actual measurements before you.

It is, however, desirable to illustrate the sensitiveness of the apparatus to vibrations of 64 per second, and its insensitiveness to other sounds.

Provided the current of air does not travel directly down the cone, organ-pipes may be blown just outside it without producing any effect. One of König's large tuning-forks may be bowed strongly without effect.

If, however, the exciting fork be tuned to 64 vibrations per second, and if it be struck as lightly as possible with the handle of a small gimlet, used as a hammer, the handle having been previously covered with india-rubber, the bands will immediately vanish, though the note produced is often quite inaudible, even to a person whose ear is placed close to the fork.

Let the weights on the fork be shifted so that it makes 63.5 vibrations per second, then the resonating fork beats, and the bands regularly appear and disappear every two seconds.

Having thus explained the construction and working of the apparatus, let me show you how we have tested whether it responds to a difference tone. When the proper rows of holes are opened, the siren will give simultaneously the  $c'$  of 256 and the  $c'$  of 320 vibrations. The interval is a major third, the difference tone is 64 vibrations. The pitch is determined by the beats between the upper note and a standard tuning-fork which gives  $c'$ . Sounding the upper note alone no effect is produced on the interference bands, as the beats first appear, then die out, and are finally heard again when the note given by the siren is too high.

It could be shown in like manner that the 256 note alone produces no effect, but if, when the standard fork of 320 vibrations and the upper note of the siren are judged to be in exact accord, the 256 note be also produced, the bands immediately disappear. Sometimes, of course, a small error is made in the estimate of the pitch, and the effect is not instantaneous, but in every case the bands disappear when the beats between the two notes are so slow that they cannot be distinguished.

It is therefore evident that Helmholtz was right when he asserted that the difference tone given by the siren is objective. It exists outside the ear, for it can move a tuning-fork.

(To be continued.)

### JAMES WATT AND OCEAN NAVIGATION.<sup>1</sup>

IF it be asked what James Watt did during his long, busy, and eventful life to improve ocean navigation, or to adapt the steam engine to the work of propelling ships, I am obliged to reply that I am not aware he personally did anything, or even that he concerned himself much about the matter. He took no active part that we know of in applying or adapting his steam engine to the propulsion of ships. The reason probably was that after his attention was first directed to the subject of the steam engine, or fire engine, in 1759, his whole energy was expended, first in improving the steam engine and making its manufacture commercially successful, and afterwards in executing the orders that came for pumping and other engines that were required for mines and manufactures. In the case of most of the greatest mechanical inventions—Watt's among the number—it has not been the ideas or the inventions by themselves that have brought success, prosperity, or even satisfaction to their owners. These results have had to be painfully and slowly evolved out of long and costly practical demonstrations and experience of the alleged merits of the invention. James Watt toiled, suffered and endured for more than twenty years after his discovery of separate condensation in 1765, before he could see that his steam engine would ever bring him anything

but disappointment, loss, and misery. It is highly characteristic, however, of Watt's fertile and original genius, and significant of what he might have done to develop the marine engine at the commencement of its history, had he taken the matter up, that upon the two principal occasions we know of when he applied his mind to the subject, he made very pregnant suggestions. Thus, when Watt sent drawings of his engines to Soho in 1770 for Mr. Boulton to construct one for experiment, and had been told that it was intended to make an engine to draw canal boats, Watt wrote, "Have you ever considered a spiral oar for that purpose, or are you for two wheels?" and to make his meaning clear he sketched a rough but graphic outline of a screw propeller. This is, perhaps, the earliest suggestion of a screw propeller, except that it was proposed by Daniel Bernoulli, the mathematician, in 1752. Again, in 1816, four years after the first Clyde steamboat, the *Comet*, was built at Port Glasgow, when Mr. Watt was upon his last visit to Greenock, he went to Rothesay and back in a steamboat. At that time the engineer did not reverse his engines, but merely stopped them some time before the vessel reached her mooring-place, and let her gradually slow down. James Watt, then an old man of eighty, tackled the engineer of the boat, and showed him how the engine could be reversed. He tried to explain this with the aid of a foot rule, but not being successful in doing it to the complete satisfaction of the engineer, he is said to have thrown off his overcoat and given a practical demonstration. Although Watt never took up the subject of steam navigation and never made a marine engine, still he was in reality its originator, because he discovered and provided the means by which it could be applied with advantage to the propulsion of ships. Each of his great improvements upon the old engine that worked by atmospheric pressure and condensed its steam in the cylinder—such as the separate condenser, the working by steam pressure as well as by pressure obtained by vacuum, the double action of the steam in the cylinder on both sides of the piston, working the steam expansively, the centrifugal governor for automatically regulating the speed of the engine, and many others—was a direct adaptation for marine purposes.

There is one point in the history of shipping at which we can draw a definite line between old and new, when changes were made so radical in their nature, and so rapid and universal in their operations, that all which came after is fundamentally different from what existed before. The period of transition falls in the early part of the present century, when the propulsion of ships by steam power was substituted for propulsion by the wind—the motive power that had been employed from time immemorial—and when the material out of which their hulls were built was changed from wood to iron. The lateness of this period and its near proximity to the present, is illustrated by the fact that it was not till after the accession of H.M. Queen Victoria that steamships and ships built of iron came to be regularly employed in ocean navigation. At the close of the first third of the nineteenth century, the over sea trade of the world was carried on with ships that were all built of wood and propelled by sails. Only about 200 of these were over 500 tons in burden, or much over 100 feet long. Nothing approaching to such a rapid and complete revolution as these two great changes brought about in the dimensions, forms, and all the characteristics and qualities of ships, in the conditions of life on board ship, and in travelling by sea, was ever experienced before in the known history of shipping. All the old ships of which we have any knowledge—and by old ships I mean all that existed prior to the introduction of steam—were built and fashioned entirely by manual power, with the aid of very simple tools; and they were either propelled through the water by manual labour, or by sails that could be worked in the simplest manner by the crew. One of the broadest distinctions between the ships of the past that were built of wood and propelled by sails and those of the present that are built of iron or steel and propelled by steam, is that everything had to be done in the former by the hand of man, without any aid from machine tools or other modern labour-saving and labour-helping appliances. And this was so both in preparing the materials used in building the hull and shaping them to their requisite form, putting them in position, fastening them together, and in working the ship at sea and handling the sails so as to make the pressure of the wind most effective for propulsion. In modern ships, almost everything is, on the other hand, done by steam-power in its various applications. It is by this means the plates which form the hull are first of all rolled

<sup>1</sup> Abstract of the Watt Lecture, delivered by Dr. Francis Elgar at Greenock, on January 13.

and was a great deal of weight to be required to drive many of the great steamships by steam-power also, but ships, after they are built, are propelled through the water, stored, pumped, and propelled, by light oil, loaded in this or that, and the engines and boilers are trained, hoisted and fixed, and all the necessary working operations are carried on. There is a great increase of difference in size between the ships of 2000 tons and the great trailing vessels of the last century. It is the application of steam-power to propulsion and to machinery that has enabled vessels to be produced the dimensions and proportions of which were formerly unapproachable. The employment of iron and steel as the material of construction would have been impossible without the aid of steam-power; and it is the extra strength of hull obtained by means which enables ships to be built of the large size that has now become common. Steam-power has thus not only furnished a mode of propulsion certain and regular in action, and enabled ships to make the voyages with little regard to wind or weather, but it has, in manufacturing the raw material out of which ships are built, permitted the dimensions to be very largely increased, and that not only without risk and inconvenience, but with very great increase of room, comfort, and safety. It is sometimes thought that the largest ships are essentially more unsafe than those of smaller size; but the fact is, more of size enables a vessel not only to be made easier in her movements at sea and less affected by the waves, which she is travelling, but it also enables the largest ships to be divided into so many separate water-tight compartments, as to be practically unsinkable by the action of the heaviest sea, or by the worst effects of a collision. It is not only that the large ships are constructed so as to possess the highest degree of safety, but many of the latest ones are, and it is perfectly practicable to obtain in cases where safety is the principal consideration. In small vessels the same degree of safety can be always obtained. Safety is a quality that can be much increased by growth in dimensions.

Although James Watt may not have helped actively in the application of steam-power to ships, it is really to him and his inventions we have to look as the source whence all the great modern improvements in ocean navigation have been derived. We find in James Watt the typical engineer. He was a great philosopher and a great mechanic. He possessed first the combination of qualities and the temperament requisite to enable a man to ascertain what may be learned of the forces of nature and their mode of operation, and to utilise and apply these in the most direct way for producing a required result. He found that happy union of what is commonly called the "theoretical" with the "practical" mind. For as there was no better practical philosopher than Watt in the country, so was there no more practical philosopher so ingenious related to the subjects of his work, or a more patient and thorough investigator of the principles or theories upon which it depended. He tested everything by experiment; and it is said that when asked an opinion of a new invention or proposal his reply invariably was, "Make a model." But having ascertained by experiment what he said of the facts connected with any subject, he was investigating and working out the details of the explained by some physical law with which they could be shown to accord. His mind was turned towards the great mechanical problems he took in hand, was not one engaged in a close and desperate struggle with the details of questioning, cross-examining, testing by experiment, and so on in all sides, and refusing to give in, but he had a full and covering the particular secret here pure theoretical knowledge. A very sure saying of his was, "Nature can be completely understood on her weak side."

We have seen what are the qualities necessary to make a great engineer. There are no human faculties, intelligence, scientific knowledge and a certain amount of observation and original investigation, energy, patience, and perseverance. There have been great engineers who have exhibited some of these qualities in a very high degree, but none who possessed all together in such a measure as to be such unanimous blending. We see in the case of Watt the combination of all otherwise, and few years, have a refined and a complete machine of the steam-engine was when Watt had put it all into the hands of the perfect men, that he was the possessor of the great mind. The proof of Watt's steam-power as a mechanic and philosopher contained are the foundation of the fact that he did this in a short time, was the great ideas that were

imposed by the quality of the materials and the workmen of the day, the greatest work that has been performed by any engineer of modern times.

We often hear the question asked by anxious parents or aspiring youths: How can my son, or how can I, as the case may be, become an engineer or a naval architect? This is sometimes asked as though the making of an engineer or a naval architect were perhaps a matter of three or four years' work in an office, combined with a certain amount of study of books, or attendance at lectures. There are few persons not belonging to one of the many branches of the engineering profession who know what this question really means. Engineering—and when I say engineering, I include in the term shipbuilding and all other branches of that grand profession, "whereby the great sources of power in nature are converted, adapted, and applied for the use and convenience of man"—engineering has of late become somewhat fashionable, and has attracted the notice of classes in the community who at one time would have despised it as a base, mechanic art, and turned their backs upon it. It has apparently acquired the reputation of being a well-paid profession and of being worth belonging to, in a money sense. To the general body of inquirers who thus look to engineering as offering better financial prospects than the army or navy, than the law, medicine, or the Church—including some who think there might be a chance in that direction after failing to qualify for one of the professions named—let me say that the prospects of success are very remote unless he who enters upon it is gifted with mechanical aptitude and skill, is willing to gain experience by a long course of hard work, and at the same time has the capacity, the taste, and the time for acquiring a sound knowledge of the mathematics and the physical sciences that relate to the particular branch of engineering he may think of taking up. Competition is now very keen in all departments of engineering, and what prizes there may be to strive for in them, can only fall to those who are exceptionally gifted with knowledge, experience, energy, and determination. An ordinary student or apprentice who can only learn what some one teaches him, and has not much faculty for independent observation, or for reflecting upon and discovering the causes of the many things he sees going on all around him, is never likely to be more than a subordinate in the ranks of the profession, a hewer of wood and a drawer of water, for others who have greater power of acquiring knowledge, of thinking for themselves, of observing and investigating closely and accurately the causes of defects and difficulties that arise out of their work, and of devising the necessary means of overcoming them.

If poets "are born and not made," I am sure it is equally the case with a great engineer like James Watt. His wonderful mechanical skill and ingenuity were natural to him, and were the means of determining the course his life would take. But even with all that, it is quite clear he could never have made his great discoveries and improvements had he not been a naturally gifted and diligent student, and acquired all the knowledge that was obtainable at the time of mathematics and natural philosophy. It is true that scientific study alone cannot make an engineer; but with the example of such a great mechanic as James Watt before us, it would be very presumptuous for any to say of himself that his own practical knowledge and judgment are sufficient to make him a fully qualified engineer without studying what others have said or done upon the subjects of his work, or the physical laws that underlie the whole fabric of his practice and ideas. I would be the last to encourage any young man to suppose that a short course of study, or even great progress in mathematics and the physical sciences, would justify him in thinking himself an engineer; but I am at the same time perfectly sure that no one, however great his mechanical skill and ability might be, could ever become an engineer in the true sense of the term without following Watt's example of studying, thinking, and diligently acquiring all the knowledge of nature and nature's laws he can obtain; and applying such knowledge to the better understanding of the principles which relate to his work, and upon which the degree of success he may achieve in it depends.

One other remark with regard to James Watt. I have spoken of the great benefits we have derived in this country from the application of his steam engine to ocean navigation by drawing the various parts of the world closer towards us, and converting the sea into a broad highway that unites us to the different continents

and islands upon it in a neighbourhood which is becoming nearer and more intimate every year. We often speak complacently of the advantage this is to our own country in particular—of what it has done in enormously increasing the wealth and prosperity of the rich, and ameliorating and brightening the lives of the poor—in promoting the growth of our manufacturing trades—in enabling food to be imported from abroad in large and regular supplies at much cheaper rates than we could produce it ourselves in these islands, and in the great increase of population that the growing prosperity of the country and the easier conditions of life have thus brought about. All this is true, and it represents an extent of change and of progress during a short space of time that we can only look and marvel at, as being due to so large an extent to the results of one man's inventions. But there are other feelings with which we do well to regard the matter besides those of wonder and admiration, and of self-satisfaction with the great prosperity and the numerous advantages the country has reaped. We have been favoured above most other peoples by all these great changes, and have been blessed in very bountiful measure. We must not forget, however, that among the privileges we thus enjoy, that of immunity from danger and harm is not included. There are few pleasures or privileges to be had without alloy; and we now find, as a set-off against the benefits obtained through the improvements in ocean navigation, that we have much greater responsibilities and difficulties in protecting ourselves against danger, and in preserving unimpaired for the future the heritage of power and prosperity that has been handed down to us. The same causes that make ocean navigation easy, swift, and certain for us, make it easier also for any possible enemies to attack us. The great increase of population, due to the recent growth of wealth and prosperity, requires for its existence constant supplies of raw material to be kept up from abroad, in order that our surplus hands may be profitably employed in manufactures, and it requires also large and continuous food supplies from outside in order that it may be fed. Hence the great problem of the time for this country—how to protect ourselves against the dangers and drawbacks of the new state of things, while enjoying for the time its advantages and reaping its rewards; and how to effectually shield the vulnerable points in our armour that have arisen out of changes and improvements which brought so much good in other ways. It is upon the sea that any real danger to England would arise; and upon the sea it would have to be met. Let us hope that the nation which has covered all the seas of the world with its ships will not now fail in energy and enterprise, or be slow in providing and maintaining adequate defence of what it has produced with such success, and out of which it has reaped such rich reward. If we were to fail thus in our duties, and so shirk our responsibilities, the improvements and benefits we owe so largely to the genius of James Watt might, after all, prove a curse instead of a blessing; and we should be unworthy of the country and the race which produced the great engineer who taught his contemporaries, more than one hundred years ago, how to manufacture power.

#### UNIVERSITY AND EDUCATIONAL INTELLIGENCE.

OXFORD.—Mr. Francis Gotch, F.R.S., Holt Professor of Physiology in University College, Liverpool, has been elected to the Waynflete Professorship of Physiology, vacated by the appointment of Dr. Burdon Sanderson to be Regius Professor of Medicine. Prof. Gotch is no stranger to Oxford, having been for some years assistant to his predecessor in the Waynflete Chair.

CAMBRIDGE.—Dr. W. S. Lazarus-Barlow, of Downing College, has been appointed Demonstrator of Pathology in the room of Dr. J. Lorrain Smith, who has been elected Lecturer in Pathology at Queen's College, Belfast.

The Examination in Sanitary Science for the University Diploma in Public Health will begin on April 2.

Hitherto one of the conditions which had to be fulfilled before the Science and Art Department made payments to the Committees of schools or classes, for the instruction of students, has been that the parents of a student should not have an income exceeding £400 a year from all sources. A Blue-paper now informs us that the Lords of the Committee of

Council of Education have decided to enlarge this limit to £500 per annum. In future, therefore, the student on account of whom a claim is made must belong to the category of "persons in the receipt of not more than £500 a year from all sources, that is, who are allowed an abatement of the income-tax; and their children if not gaining their own livelihood." This example could be followed with advantage by the Technical Education Committees of those County Councils that restrict their Scholarships to competitors whose parents are in receipt of less than £120 a year.

#### SCIENTIFIC SERIALS.

*Bulletin de l'Académie Royale de Belgique*, No. 1.—Is the declination indicated by a compass independent of its magnetic moment? by Ch. Lagrange. According to Gauss's theory it may be assumed that the magnetic axis of a magnet lies in the direction of the lines of force of the field, whatever its magnetic moment may be. But in practice it is found that the orientation of a magnet depends upon the strength of its magnetisation. Since these systematic differences are not due to magnetic force, they must be due to some other force, probably a force hitherto unknown. Hence the magnetic chart of the earth calculated by Gauss's theory cannot be considered rigidly correct. A new constant must be introduced, depending upon the declinometer. The author foreshadows an explanation of these facts, based upon the "circulation of the ether," and intimately associated with the physics of the globe.—Double decompositions of vapours, by Henryk Arctowsky. It is not necessary that two substances should be dissolved in water to bring about their mutual decomposition; or their "ionisation," in terms of the electrolytic theory, is not altogether dependent upon water. Freshly sublimated mercuric chloride and flowers of sulphur were placed in small vessels inside a Bohemian glass tube over an organic combustion furnace. A current of pure dry hydrogen was introduced, which on heating formed sulphuretted hydrogen with the sulphur. This gas and the vapour of  $\text{HgCl}_2$  gave a precipitate of mercuric sulphide on the walls of the tube. This reaction, which is contrary to Berthelot's principle of maximum work, does not take more time than the corresponding reaction in water. To prove that it was a true double decomposition,  $\text{CO}_2$  was substituted for the hydrogen, when it was found that the sulphur vapour alone was unable to attack the mercuric chloride.

*Bulletin de l'Académie de Science de St. Pétersbourg*, fifth series, vol. 1, No. 4, 1894.—Minutes of proceedings for October last.—On derived functions of superior orders, by N. Sonin (in Russian).—Crustacea Caspia: contributions to the knowledge of the Cateinological fauna of the Caspian Sea, by G. O. Sars (in English, with eight plates). The Gammarideæ are continued, and the following species, mostly new, are described and figured: *Gammarus Warpachowskyi*, *minutus*, *macrurus*, *compressus*, *milii*, *robustoides*, *crassus*, *abbreviatus*, and *obesus*, and *Niphargoides caspius*, Grimm.—On the transformation of Periodical Aggregates, mathematical paper by H. Guldén (in German).—On Free Energy, by B. Galitzine (in Russian).

#### SOCIETIES AND ACADEMIES.

##### LONDON

Royal Society, January 24.—"Notes of an Inquiry into the Nature and Physiological Action of Black-damp, as met with in Podmore Colliery, Staffordshire, and Lilleshall Colliery, Shropshire." By Dr. John Haldane.

Black-damp, sometimes also called choke-damp, or "stythe," is one of the gases frequently found in the workings of coal mines. It is distinguished from fire-damp by the fact that it is not explosive when mixed with air, but extinguishes flame; and from after-damp by the fact that it is not the product of an explosion, but collects in the workings under ordinary conditions. Like after-damp and fire-damp, it produces fatal effects when inhaled in sufficient concentration. A further distinction has been drawn between black-damp and white-damp, which latter is described as capable of supporting combustion, while at the same time acting as a poison when inhaled.

The author has made a number of observations on concentrated black-damp from two pits, the first being in a fiery

and the second in a non-biery district. The conclusions arrived at are as follows:

1. The specimens of black-damp consisted when diluted of nitrogen containing an admixture of a seventh to an eighth of its volume of carbonic acid.

2. Air containing just sufficient black-damp to extinguish a candle or lamp produced no immediately sensible action on a man. A mixture of about 16 per cent. of the black-damp and 84 per cent. of air extinguished candles and lamps, whereas a mixture of about 60 per cent. of the black-damp and 40 per cent. of air would be required to produce immediate danger to life.

3. The dangerous physiological action of black-damp is due to deficiency of oxygen, not to excess of carbonic acid. The effect first appreciable when increasing proportions of black-damp are breathed is, however, due to carbonic acid alone.

February 21.—"The Composition of the Extinctive Atmospheres produced by Flames." By Prof. Frank Howes.

In a former paper (*Rev. Soc. Phil.*, vol. lvi.), the author communicated the results obtained by mingling gases, which were extinctive of flame, with air, until a flame burning in the air was just extinguished. The gases used in the experiments were carbon dioxide and nitrogen. Each of these gases was separately introduced into the air, and the composition of the atmosphere thus produced, which just extinguished flame, was determined by chemical analysis.

The general results arrived at were:—

(1) That wick-fed flames require atmospheres of very similar composition to extinguish them; while gas-fed flames require atmospheres of widely differing composition.

(2) That nitrogen must be added in larger proportion than carbon dioxide, in order to extinguish the same flame.

(3) That the minimum proportion of extinctive gas which must be mingled with air in order to extinguish a flame is independent of the size of the flame.

A supplementary series of experiments has now been undertaken in order to determine the composition of the atmosphere extinctive of each flame, which is produced by the flame itself when burning in an enclosed volume of air at atmospheric pressure. The apparatus used and the method of experimenting are fully described.

As in the previous series of experiments (*loc. cit.*) the combustible substances used were chiefly those which are burnt for ordinary heating and lighting purposes—namely, alcohol (absolute), alcohol (methylated), paraffin (lamp oil), colza and paraffin, candle, hydrogen, carbon monoxide, methane, and coal-gas.

Determinations were made of the percentage composition of the residual atmospheres left by the flames, and these were compared with the composition of the artificial atmosphere in which flame is just extinguished, and with the composition of atmospheres which are resorbable according to the recent experiments of Dr. Halane (*Proc. Roy. Soc.*).

The conclusions drawn from the tabulated results of the experiments published in the paper are that:—

(1) The flames of the combustible gases and liquids, which were extinguished upon, produce, at the point of extinction in an enclosed atmosphere, a change in the proportion of oxygen in the air, generally corresponding to that produced by preparing extinctive atmospheres by artificial mixture.

(2) The flames of candles and lamps, when they are extinguished by burning in a confined space of air, produce an atmosphere of a more plentiful composition with that of air expelled from the lungs.

(3) The extinctive atmosphere produced by the combustion of the flames of candles and lamps, and the air expired from the lungs after burning in a confined space, are respirable with safety.

(4) The extinction of an ordinary candle or lamp flame is not necessarily indicative of the uninhabitability of an atmosphere for human life when it is breathed.

Geological Society, February 7.—Dr. Henry Woodward, F.R.S., President, in the chair. On the occurrence of a *Sauripodus* from Madagascar, by R. Lydekker, F.R.S. The bones described in the paper were collected by Mr. Flett in the east of the island of Nosy-Be, on the north-eastern coast of Madagascar. They include a very large limb-bone, and portions of the tibia and premaxillary. These bones were described in detail, and the animal which possessed them was referred to the genus *Bathio-*

*gnonidius*, Owen; a dorsal vertebra, described in the paper, being taken as the type of the new species. The identification of the Madagascar reptile with a type occurring in the Jurassic rocks of England harmonises with the reference of some of the strata of the island to the Jurassic period.—On the physical conditions of the Mediterranean basin which have resulted in a community of some species of freshwater fishes in the Nile and the Jordan waters, by Prof. E. Hull, F.R.S. The author summarised the evidence in favour of the existence of barriers in post-Miocene times, separating the Mediterranean area into a chain of basins. He brought forward arguments in support of his contention that the waters of the eastern (Levantine) basin became fresh during a period when the area of evaporation was smaller, and the supply of river-water greater, than at present. Into this freshwater lake the waters of the Nile would flow directly. He had elsewhere given reasons for believing that the Jordan Valley from Lake Huleh to Arabah was the bed of a lake over 200 miles long, and at least 1300 feet above the present level of the Dead Sea. He suggested that the waters of this lake escaped into the Levantine basin through the plain of Esdraelon. With such physical conditions existing, the fauna of the Levantine basin would have had a means of spreading throughout the whole system of waterways connected with it. In conclusion the author added some observations on the changes which occurred in the Mediterranean area subsequent to the post-Miocene epoch of earth movement.—On the loess and other superficial deposits of Shantung (Northern China), by S. B. J. Skerichly and T. W. Kingsmill. The following deposits were described in the order of their antiquity:—(1) Recent fluviatile deposits. (2) Marine sands with *Cardium*, *Ostrea*, and *Bulla*, extending to a height of 200 feet above sea-level, and indicating former submergence to that amount. (3) Old river gravels, often resting on loess, and possibly contemporaneous with the marine gravels. They furnish part of the evidence relied on by the authors for supposing the existence at that time of a climate moisture than the present one. (4) Loess. (5) Basement-gravels having the same relation to the loess that the Upper Green and bears to the Chalk. The loess east of the Pamirs is extensively developed over an area of over one million square miles. It is sometimes over 2000 feet thick, and occurs up to several thousand feet above sea-level. Evidence was brought forward by the authors with the intention of establishing the absolute want of connection between the Chinese loess and the present river-systems, its original stratified condition (as shown by variation of tint and horizontality of layers of concretion), and its subsequent rearrangement to a great extent. The absence of marine shells was discussed, and the suggestion thrown out that the shells had been destroyed by percolating water. The authors gave their reasons for supposing that the loess is a marine formation, and stated that the sea need not have reached to a higher level than 600 feet above the present sea-level, for the Pamir region where it occurs, 7000 feet above the sea, is an area of special uplift. They maintained that there are no proofs of the glaciation of Northern and Eastern Asia, so that Chinese loess could have no connection with an area of glaciation. They stated that the zoological, ethnological, historical, and traditinary evidence alike pointed to the former depression of Asia beneath the sea, and the subsequent desiccation of the land, consequent upon re-elevation.

Mathematical Society, February 14.—Mr. A. B. Kempe, F.R.S., Vice-President, in the chair.—The chairman announced the decease, since the January meeting, of Prof. Cayley, F.R.S., and Sir J. Cockle, F.R.S., and stated that the Society had been represented at the funeral of the former by the President, himself, and Profs. Elliott, F.R.S., and Hurwicz, F.R.S. Messrs. Walker, F.R.S., Glaisher, F.R.S., and Elliott, F.R.S., paid tributes to the memory of the deceased gentlemen, and a resolution was passed unanimously that the President (Major MacMahon, F.R.S.), who was absent owing to a domestic affliction be requested to convey, in such form as he should think most expressive of condolence from the Society to Mrs. Cayley and Lady Cockle.—Dr. Hobson, F.R.S., gave a brief sketch of a paper, by Mr. H. M. Macdonald, on the classification of a circular disc in any field of force symmetrical with respect to its plane.—Prof. Elliott read a paper on certain differential operators, and their use to form a complete system of seminvariants of any degree, or any weight.—Prof. W. Burnside, F.R.S., sent notes on the theory of groups of finite order, iii and iv. Herr Holder, in a paper in the *Math. Ann.* vol. xl., and Dr. Cole, in a paper in the *American Journal of Mathematics*, vol. xv., have

determined all the simple groups whose orders do not exceed 660. The only other known results in connection with the question as to whether there is a simple group corresponding to a given order are as follows. There is no simple group whose order is the power of a prime, or whose order contains two or three prime factors; and the only simple group whose order contains four prime factors is a group of order 60. The latter result was established in a paper published in vol. xxv. of the *Proceedings of the Mathematical Society*. The present paper aims at an extension of these results. If  $p_1, p_2, \dots, p_n$  are distinct primes in ascending order, it is shown that in a group of order

$$p_1 p_2 \dots p_{n-1} p_n^m$$

the number of operations whose orders are divisible by  $p_s$  and by no lower prime is

$$(p_s - 1) p_{s+1} \dots p_{n-1} p_n^m,$$

from which it follows at once that a group whose order is of this form can neither be simple nor contain a simple sub-group.<sup>1</sup> It is also shown that a group whose order is of the form

$$p_1^2 p_2 \dots p_{n-1} p_n^m$$

cannot be simple, and cannot contain a simple sub-group, with the exception of the case in which it contains a tetrahedral sub-group; in which case  $p_1 = 2, p_2 = 3$ . Thirdly, it is shown, with certain limitations, that if no prime entering in the order of a group, except the greatest, appears to a higher power than the second, the group cannot be simple. Fourthly, it is proved that no groups whose orders are of the forms.

$$p_1^m p_2 \text{ or } p_1^m p_2^2$$

can be simple. A deduction from these results of general form, aided by the consideration of certain more particular cases, is that the only simple groups whose order is the product of five primes are the known simple groups of orders 168, 660, and 1092. Finally, it is shown that if in a group of order

$$p_1^m p_2^m \dots p_{n-1} p_n^m$$

the sub-groups of order

$$p_1^m, p_2^m, \dots, p_{n-1} p_n^m$$

are all cyclical, the group cannot be simple, and cannot contain a simple sub-group.

**Entomological Society, February 20.**—Prof. Raphael Meldola, F.R.S., President, in the chair.—Mr. W. M. Christy exhibited specimens of *Lycena agestis*, caught in Sussex, last summer, which had a white edging round the black discoidal spot. He said the specimens might, perhaps, be identical with the northern form of the species known as the variety *salmacis*.—Mr. H. Goss exhibited a small collection of Lepidoptera from the South of France, made by Mr. Frank Bromlow.—Prof. Meldola invited discussion upon the address delivered by Mr. Elwes, as retiring president, on the "Geographical Distribution of Butterflies," at the last annual meeting. He remarked that he had not himself had time to consider the paper in an adequate manner, but he thought that the discussion might lead to a useful expression of opinion if the speakers would deal with the question as to how far the scheme of distribution advocated by Mr. Elwes was borne out by a comparison with other orders of insects. He was of opinion that in considering schemes of geographical distribution, the results arrived at were likely to be of greater value the wider the basis on which they rested, and he therefore suggested that the question might also be taken into consideration as to how far it was justifiable to draw conclusions from the consideration of one division or one order only. Dr. Sharp, F.R.S., remarked that geographical distribution consisted of two divisions; firstly, the facts; secondly, the generalisations and deductions that may be drawn from them. He thought that as regards insects generally our knowledge of the facts was not yet sufficient to warrant any generalisations. Still the impressions of those who have paid attention to particular groups of insects are even now of some importance, though at present based on incomplete knowledge. He thought the Rhopalocera would prove to be a somewhat

exceptional group in their distribution. Notwithstanding that Australia and New Zealand are so poor in them, this was by no means the case with their Coleoptera, Australia being very rich, and its fauna of Coleoptera being very distinct. He thought that if Lepidoptera generally were well collected in Australia and New Zealand, it would be found that this order was not so poor in species as was supposed. He instanced the case of the Sandwich Islands, where it was supposed that there were very few species of Lepidoptera, and yet some 500 species, or perhaps more, had been recently found there by Mr. R. C. L. Perkins, who had been sent to investigate the islands by a committee appointed by the Royal Society and British Association.—Mr. McLachlan, F.R.S., said he was of opinion that no definite demarcation of regions existed, but that all the regions over-lapped; in any case the retention of Palearctic and Nearctic as separate provinces was not warranted on Entomological data. He believed that at the close of the Glacial period some insects instead of going north were dispersed southwards, and that the present geographical distribution of some forms might thus be accounted for. The discussion was continued by Mr. Osbert Salvin, F.R.S., Mr. J. J. Walker, Herr Jacoby, Mr. Champion, Mr. Elwes, and Prof. Meldola.—The Rev. T. A. Marshall contributed a paper entitled "A Monograph of British Braconidæ, Part vi."—Mr. J. W. Tutt read a paper entitled "An attempt to correlate the various systems of Classification of the Lepidoptera recently proposed by various authors." In this paper he criticised the opinions recently expressed by Mr. G. F. Hampson, and Dr. T. A. Chapman, in certain papers published by them. A discussion ensued, in which Mr. Elwes, Prof. Meldola, and Mr. Tutt took part.

**Zoological Society, February 19.**—Sir W. H. Flower, K.C.B., F.R.S., President in the chair.—Mr. F. E. Beddard, F.R.S., read a paper in which he gave a description of the brain of the Glutton (*Gulo luscus*).—A second paper by Mr. Beddard contained a description of the brain of different species of Lemurs that have died in the Society's Gardens, pointing out the range of variation to be observed in the cerebral convolutions of this order.—A communication was read from Mr. C. Davies Sherborn and Dr. F. A. Jenkinson, in which was given the dates of the publication of the parts of Siebold's "Fauna Japonica" and Giebel's "Allgemeine Zoologie" (first edition).—A communication was read from Dr. J. de Bedriaga, "On the Pyrenean Newt, *Amblyopis aspera*, Dugès," dealing with the external, osteological, and larval characters of this imperfectly-known Batrachian, and giving an account of its habits.

**Linnean Society, February 21.**—Mr. C. B. Clarke, F.R.S., President, in the chair.—Mr. J. H. Vanstone exhibited specimens of some nearly allied Hydrozoa, namely, *Bougainvillea ramosa* and *B. musca*, and after demonstrating their structure, gave reasons for concluding that although the latter had been described as distinct by Prof. Allman, the characters relied upon were not of specific value but simply varietal.—Mr. George Frebner exhibited some lantern slides of *Glaucosiphonia capillaris* and other Algae, with accompanying descriptions, and gave an interesting account of his method of preparing slides in colours.—On behalf of Mr. J. Boerlage, the President demonstrated the chief points in a paper communicated by him on the identification of *Chionanthus Ghari*, an obscure species figured by Gertner at the end of the last century in his famous work "De fructibus et seminibus Plantarum," but hitherto undetermined. From the researches of Mr. Boerlage it now appeared that it was evidently referable to *Scopulandron costatum*, Kuntz. This was made clear by the excellent drawings which accompanied the paper, as well as by the specimens which were exhibited.—A paper was then read by Mr. E. M. Holms, on new marine Algae from Japan. The author pointed out that up to the present time the known species of Algae from that country did not exceed 300, or about half the number found in Great Britain; but that the districts around three centres only had been explored, namely Hakodadi, Tokio, and Nagasaki, notwithstanding the fact that seaweeds are largely used as food by the Japanese, and form an important article of commerce. The paper included descriptions of twenty-three new species (the structure of which was shown by means of the oxyhydrogen lantern) belonging to the genera *Cladophora*, *Coarum*, *Dictyota*, *Dictyopteris*, *Polyzonias*, *Chombrus*, *Gracilaria*, *Grateloupia*, *Gymnogongrus*, *Halymeria*, *Lethereatia*, and *Padina*.

<sup>1</sup> It has been pointed out to the author since the paper was communicated to the Society, that this first result is contained in a paper by Herr G. Frobenius, *Berliner Sitzungsberichte*, 1893.

CAMBRIDGE.

Philosophical Society, February 25.—Mr. R. T. Glazebrook, Treasurer, in the chair.—On binocular colour mixtures, by Dr. W. H. R. Rivers. Two methods of producing binocular colour mixture were shown—by Wheatstone's stereoscope and by a modification of Hering's method devised by Mr. E. T. Dixon. Colour mixture mixtures were described as occurring in the after-image following binocular combination of coloured patches.—On a new parasite probably allied to *Echinorhynchus*, by Mr. A. E. Sars. The specimens described came from the skin of a *Themisto* taken by Mr. Perkins in the Island of Katal, one of the Sandwich Islands.—Notes on *Pachythea* with exhibition of specimens, by Mr. A. C. Seward. The genus *Pachythea* from Silurian and Devonian rocks of Britain and Canada has been a subject of discussion among palaeontologists ever since its discovery in 1853. Several writers have placed it as fossil among Algae, and this position has been assigned to it on the grounds of a supposed resemblance of its histological structures to that of certain recent genera. An examination of a series of microscopic sections prepared by Mr. Sturmer, of Cardiff, has led the author to doubt the sufficiency of the evidence on which the comparison with any existing alga has been based, and to regard *Pachythea* as an organism of uncertain position which might well receive attention at the hands of biologists.

PARIS.

Academy of Sciences, March 4.—M. Marey in the chair.—The life and works of Admiral Paris, member of the Geography and Navigation section, by M. E. Gayon.—Axioms of two plane lines, by M. H. Resal.—Prophylactic remedy for marsh-fevers, by M. d'Abbadie. The use of a daily fumigation of the body with sulphur is urged as a preservative against intermittent fevers in malarial districts.—On the interior pressure and the virial of the interior forces in fluids, by M. E. H. Amagat. A mathematical paper in which the variations of certain theoretical constants, deduced from the results of the experimental determinations of the properties of gases under high pressures, are discussed.—Observation of Wolf's planet BP, made at Toulouse Observatory, by M. F. Rossard.—Recitation of some arithmetical theorems, by P. Pepin. The month of February, 1895, at Parc de Saint-Maur Observatory, by M. E. Kelou. A discussion of the meteorological conditions obtaining in the neighbourhood of Paris. It is shown that a continued low temperature is very rare in February. The mean temperature of the month is given at 4.45. The minimum temperature was reached on the 7th at Parc de Saint-Maur = 15.4, and at Chateaudun = 14.6, and on the 9th at Vendôme = 15.4. At the first-named station the earth was frozen beneath turf to a depth of 0.53 metres, and in the lower garden to a depth of 0.65 metres. Panoramic views obtained with the repeating twin-camera, by M. J. Carpentier.

By-products of oxides and sulphides. Zinc sulphide, by M. A. Villiers. Calorimetric researches on dilute solutions. Sulfamic acids, by M. L. Monnet. The heat of solution of primary amines in agreement with the concentration of the solution. On hexane hydroamine; ammonium salts; action of acids; production of primary amines, by M. D. Béline. The reaction of acid on the various amides of hexamethylene-amine.  $C_6H_{12}N_4R_6 + 6H_2O = 3NH_3 + 3NRH_2$ , is given as a new method of forming primary amines. The use of bis-nitro potassium iodide for the isolation of these primary amines is noted.—On the composition of French and foreign oats of the 1893 crop, by M. L. Bouché. New considerations on the comparative anatomy of the Limac, by M. J. P. Durand de Gerville. M. F. Inaud Ferrer followed up this paper with a discussion of the theory of the compound nature of the higher animal organisms.—On a disease of the spiny lobster, by M. J. L. Bouvier and George P. B. On the formation of the shell of molluscs, by M. Maynier de Villepoix.—On the distillation of perfumes, by M. Desprez. Experiments on the fermenting materials prepared by the vine, by M. A. Muntz. The following conclusions have been arrived at: (1) In all varieties the absorption of nitrogen and potash in each vine considered is more than that of phosphoric acid. (2) Nitrogen is absorbed in large quantity by the vine, and, contrary to widely received opinions, nitrogenous manures ought to be used; these are in other respects the most effective. (3) In the southern vineyards, nitrogen is absorbed in greater proportion than phosphoric acid in more northern

regions potash is most absorbed. (4) Notwithstanding the enormous difference in yield, the southern vine requires no greater amount of nutritive materials than the vines of more temperate climates. (5) The quantity of fertilising elements used by the vine per hectolitre of wine produced is three or four times more considerable in the more northern districts than in the south.—On the abnormal partitions of the fronds of ferns, by M. Adrien Guébard.

BOOKS, PAMPHLETS, and SERIALS RECEIVED

Books.—Abrégé de la Théorie des Fonctions Elliptiques: C. Henry (Paris, Nony).—Mechanics—Statics: R. T. Glazebrook (Cambridge University Press).—Steam-Power and Mill-Work: G. W. Sutcliffe (Whittaker).—Scientific and Technical Papers of Werner von Siemens, Vol. 2. Technical Papers, translated (Murray).—From a New England Hillside: W. Potts (Macmillan).—Prince Henry the Navigator: C. R. Beazley (Putnam).—Catalogue of the Birds of Prey, with the Number of Specimens in Norwich Museum: J. H. Gurney (Porter).—Anuario publicado pelo Observatorio do Rio de Janeiro, 1894 (Rio de Janeiro).—A Theoretical and Practical Treatise on the Manufacture of Sulphuric Acid and Alkali: Dr. G. Lunge, 2nd edition, Vol. 2 (Gurney and Jackson).—A Students' Text Book of Botany: Dr. S. H. Vines (Sonnenschein).—The Origins of Invention: Dr. O. T. Mason (Scott).—Die Gesellschaftsordnung und ihre Naturliche Grundlagen: O. Ammon (Jena, Fischer).—Die Grundgebilde der Ebenen Geometrie: Dr. V. Thierhard, 1 Band (Leipzig, Teubner).—Vorlesungen aus der Analytischen Geometrie der Kegelschnitte: F. Dingeldey (Leipzig, Teubner).—The Astrologer's Ready Reckoner: C. J. Baker (Halifax, Occult Book Company).—The Voyage of H.M.S. Challenger. A Summary of the Scientific Results (with Appendices), 2 Paris (Eyre and Spottiswoode).—Le Climat de la Belgique en 1894 (Bruxelles).

PAMPHLETS.—Sweet Casa-va: H. W. Wiley (Washington).—Neudrucke von Schriften und Karten über Meteorologie und Erdmagnetismus, No. 4 (Berlin, Asher).—Über die Grundlagen und Ziele der Raumlehre: Dr. V. Thierhard (Leipzig, Teubner).—A Summary of Progress in Mineralogy and Petrography in 1894 (Waterville, Me.).—Sociedad Científica Argentina. Flores—Insectos. A. Gallardo (Buenos Aires).—The Basic Massive Rocks of the Lake Superior Region: W. S. Bayley (Chicago).

SERIALS.—Geographical Magazine, March (Stanford).—L'Anthropologie, tome vi, No. 1 (Paris).—Bulletin of the American Mathematical Society, February (New York).—Journal of the Chemical Society, March (Gurney and Jackson).—Natural History of Plants, Part xi (Blackie).—Verhandlungen der K. K. geologischen Reichsanstalt, Jahrg. 1894, No. 1 bis 18 (Wien).—Insect Life, vol. 7, Nos. 1-5 (Washington).—American Journal of Science, March (New Haven).—Bulletins de la Société d'Anthropologie de Paris, No. 3, 1894 (Paris).—Psychological Review, March (Macmillan).

CONTENTS.

	PAGE
The Life of Dean Buckland . . . . .	457
Our Book Shelf:—	
"The Birds of Eastern Pennsylvania and New Jersey." (With Diagram) . . . . .	458
Durand and Schinz: "Conspicua Flora Africae, ou Énumération des Plantes d'Afrique."—W. B. H. Gautier and Chatpy: "Leçons de Chimie."—J. W. R. . . . .	459
Letters to the Editor:—	
Variation and Specific Stability.—W. T. Thiselton-Dyer, C.M.G., F.R.S. . . . .	459
Do Plants Assimilate Argon?—E. Blass; Prof. W. Ramsay, F.R.S. . . . .	461
The Measurement of Pressures in Guns.—Rev. F. Bashforth . . . . .	461
The Velocity of the Argentine Earthquake Pulsations of October 27, 1894.—C. Davison . . . . .	462
The Society of Speleology.—Mark Stirrup . . . . .	462
Contraction of Trees caused by Cold.—J. Clayton . . . . .	462
The Patience of Precambrian Rocks.—Dr. C. Callaway . . . . .	462
The Arctical Spectrum Top.—Newton and Co. . . . .	463
Research in Education. By Dr. H. E. Armstrong, F.R.S. . . . .	463
Notes . . . . .	468
Our Astronomical Column:—	
Spectrum of the Orion Nebula . . . . .	471
The Eclipse of the Moon . . . . .	472
The <i>Natural Almanac</i> , 1898 . . . . .	472
Physical Work of Hermann von Helmholtz, I. (With Diagram.) By Prof. A. W. Rucker, F.R.S. . . . .	472
James Watt and Ocean Navigation. By Dr. Francis Elgar . . . . .	475
University and Educational Intelligence . . . . .	477
Scientific Serials . . . . .	477
Societies and Academies . . . . .	477
Books, Pamphlets, and Serials Received . . . . .	480

THURSDAY, MARCH 21, 1895.

## MODERN BACTERIOLOGY.

*Lehrbuch der Bakteriologischen Untersuchung und Diagnostik.* By Dr. Ludwig Heim. Crown 8vo. Pp. 528. (Stuttgart: Verlag von Ferdinand Enke, 1894.)

THE writer of this volume takes care to leave us in no doubt as to its purpose. We are told in the preface, "Für den Praktiker ist dieses Buch geschrieben." Again, "Ein Lehrer und ein Führer soll dies Buch sein." Even the unfortunate student, who, in spite of attending a practical course on bacteriology, has failed to carry away an adequate knowledge of his subject, is to turn to this book for consolation, where "he may yet arrive by its assistance at his goal, providing he follow step by step and point by point the instructions which it contains."

But after a careful perusal of this bulky octavo volume, we find ourselves unable to agree with the author's estimate of his book. It contains a mass of facts, a bewildering maze of detail through which we think no student would have the patience to thread his way, much less the student who has failed in spite of passing through a course of practical instruction. Possibly Dr. Heim knows too much, or is too generous in giving his knowledge away. A little more reticence would have not only made his book less unwieldy in dimensions, but the whole treatment of the subject would have gained in simplicity.

The excessive love of minute detail is characteristic of most German text-books, but we do not think the following example of it will easily be surpassed: "Smokers must put their cigars or cigar-ends so down that the burning part rests on the table, the mouth-piece remaining free. Eating must not under any circumstances be carried on in the laboratory. The moistening of the fingers in the mouth is to be rigidly avoided. Gum labels must only be wetted with water." We can only say that if the student approaches his subject with as little feeling for it as the necessity of these instructions implies, he will, we predict, never do much, however often he may read through Dr. Heim's volume!

The work is divided into three parts—bacteriological manipulations, including microscopic investigations; the preparation of culture media, and experiments on animals. The latter section is given in greater detail than in most text-books, and is very clearly described. Secondly, the morphological and other characteristics of bacteria, containing an admirable though brief account of the subject of immunity and the latest developments of serum therapeutics. Thirdly, the diagnosis of bacteria in disease, as well as their demonstration in our surroundings. The information imparted is, in nearly all cases, gathered from the most recent publications in Germany; but on consulting the list of journals referred to in the text, the only foreign publication considered worthy of notice is the *Annales de l'Institut Pasteur*, English periodicals being completely ignored, as well as the excellent *Annali dell'Istituto d'Igiene Sperimentale*, published in Rome, and the official reports, published in St. Petersburg, of

the work carried out in the Imperial Institute of Experimental Medicine.

This accounts for the omission of all reference to Palermo's most interesting experiments on the attenuation of the pathogenic properties of the cholera bacillus through exposure to sunshine. In the section describing the methods which may be adopted for reducing and increasing the virulence of particular bacteria, mention is made of Arloing's isolated investigation on the attenuation of the disease-producing powers of the anthrax bacillus through three hours' insolation; but the fact is passed over, that Palermo succeeded in reducing cholera bacilli to the condition of vaccine through the action of sunshine, so that guinea-pigs, when inoculated first with *insolated* cholera bacilli, and then with ordinary virulent cholera bacilli, instead of dying, as usual, in about eighteen hours, remained alive.

The survey of the present state of our knowledge on the question of immunity is, perhaps, the most interesting and best-written portion of the book. Theoretical considerations of the subject are kept in abeyance, and prominence is only given to the practical outcome of the investigations which have been made. The results of Roux's application of serum in the treatment of diphtheria in the Paris hospitals appeared too recently to admit of incorporation here. In the section on the production of spores, the author throws doubt on Roux's method for obtaining anthrax bacilli permanently deprived of their power of producing spores, so-called *asporogene* anthrax. He states that he has not been able to succeed in procuring such a race of anthrax bacilli, although he has made numerous attempts with the utmost regard to Roux's recipe. The method devised by Phisalix is preferred, which consists in prolonged exposure of anthrax cultures to a temperature of from 30° to 42° C.; but this device only answers as long as the bacilli are kept in ordinary culture media, for even when introduced into broth containing a fraction of guinea-pig's blood, they are at once sufficiently revived to produce spores.

In describing the capacity for multiplication possessed by bacteria, an interesting experiment is cited, which we do not remember having seen elsewhere, showing that 149 cholera bacilli kept at 37° C. had within three hours increased to as many as 96,000, and that the minimum time occupied by these bacilli in the production of a new generation was twenty minutes. This involves, however, the assumption that in the process of multiplication from every individual cell two new ones are started, never more or less.

The concluding portion of the volume, which deals with bacteriological diagnosis, and occupies close upon 200 pages, is helpfully illustrated by photographic plates of many pathogenic micro-organisms. In this section, in speaking of the vexed question of the microbic origin of scarlet fever, Dr. Heim considers that the cause of this disease has not yet been discovered, and that the streptococci which have been found by various observers must be regarded as a secondary and not primary infection; in his own words, "man muss sich wohl hüten dabei die Grundkrankheit zu übersehen." According to Doehle, scarlet fever may be with more likelihood ascribed to protozoa; and this authority is of opinion

that similar organisms may very possibly be found to be the exciting cause of both measles and small-pox. In malaria protozoa are now accepted as the origin of the disease, and a similar suggestion has been made to account for yellow fever in the absence of all trustworthy microbic evidence. The examination of air, water, &c., for micro-organisms, is, of course, only dealt with in a very cursory manner. In the small section devoted to water-bacteriology, we are glad to find Dr. Heim calling attention to the errors which may so easily occur in the correct numerical estimation of bacteria in water.

Dr. Heim has spent an immense amount of patient labour on the compilation of this volume, and he approaches his subject invariably from the point of view of a man who has worked out things and problems for himself: it is thus that his book acquires an original flavour, which, whilst making it more palatable to the teacher, renders it less likely to find favour, or prove useful to the student. We venture to think that it will, in the concluding words of the preface, "sich den Herrn Kollegen nützlich erweisen"; and it must in any case be regarded as a responsible and noteworthy contribution to the bacteriological text-books, now fairly numerous, already in existence.

G. C. FRANKLAND.

#### CHEMICAL ANALYSIS.

*Lehrbuch der natürlichen Grundlagen der analytischen Chemie.* Von W. Ostwald. (Leipzig: Wilhelm Engelmann, 1894)

THE Professor of Chemistry in the University of Leipzig has taken so assiduously to the making of books that, as regards the fruitfulness of his pen, he may well take rank with even the more prolific of our writers of fiction. Despite this fact, it is not too much to say that none of his productions will appeal to a larger section of the chemical public than the little volume under notice. For although it is professedly a work on general analytical chemistry, it will mainly make its mark as a concise exposition of qualitative analysis, based upon the most recent developments of chemical theory.

The author first deals with the modes of recognising substances (*Zustände* and *Vorgangseigenschaften*) and the modes of separating substances prior to recognition. Amongst other things the theory of filtration and washing is considered, together with the complication introduced by "adsorption," that curious property in virtue of which the concentration of a solution near the surface of an immersed solid is greater than the average concentration. Separation, it is emphasised, must always be mechanical, and if it cannot be effected directly by the physical methods described, such as distillation or the action of solvents, chemical operations, such as form the subject matter of qualitative analysis, have first to be performed.

At this point we meet with views which are novel in an analytical text-book. The theory of analysis, it is urged, now stands upon a new platform. With van't Hoff and others, we must regard the properties of dilute solutions, acids, bases, and salts as mainly those of

their ions: and herein lies a simplification of the utmost importance, for it is possible to express in terms of the properties of, say, 50 anions and 50 cations the properties of the 2500 odd salts to which they may give rise. A digest of the new theory of the constitution of solutions is here given, and of the mode in which the law of mass action may be extended to analytical reactions by regarding the ions as individual substances.

A precipitate in its mother-liquor we are to regard as a system in equilibrium. Precipitation is never complete. On precipitating  $\text{BaSO}_4$ , for example, a small amount remains in solution, and portion of this is dissociated into the ions Ba and  $\text{SO}_4$ . The precipitate is in equilibrium with the soluble  $\text{BaSO}_4$ , while it in turn is in equilibrium with the ions. Now the active mass of a solid is constant, hence for equilibrium the product of the concentrations of the ions in the solution must have a definite value—the solubility product. If the product be raised above this definite value, more precipitate must form; if it be lowered, more precipitate must dissolve. We have here a reason for the common practice of adding an excess of precipitant in order to ensure complete precipitation. In the case quoted the solubility product of the  $\text{BaSO}_4$  will be partly kept up to the necessary value by means of the Ba ions of the excess of precipitant, and hence less  $\text{BaSO}_4$  will require to remain in solution. This is a particular instance of the general rule that the solubility of a substance is diminished by the presence of another having an ion in common with it.

We can thus formulate a theory of precipitation. It is in general the result of interaction between ions; consequently, if on mixing two solutions ions are present which can form a substance having a sufficiently small solubility product, that substance is precipitated, and causes which affect the solubility product are the causes affecting the precipitation. Here are one or two instances of this method of treating analytical reactions.

The solubility of  $\text{Mg}(\text{HO})_2$  in water is regulated by the solubility product of Mg and HO ions. If hydrochloric acid, which is almost completely dissociated, be added to the water, the H ions of the acid at once unite with the HO ions of the dissolved  $\text{Mg}(\text{HO})_2$  to form water, because water is practically undissociated. In this way the solubility product of the  $\text{Mg}(\text{HO})_2$  is diminished, and more solid  $\text{Mg}(\text{HO})_2$  must dissolve in order to maintain the product at the value necessary for equilibrium. If sufficient HCl be present, all the  $\text{Mg}(\text{HO})_2$  will pass into solution.

The following case of precipitation is more complex:—If  $\text{CO}_2$  be passed through a solution of  $\text{Pb}(\text{NO}_3)_2$ , little or no precipitate is obtained, whereas two thirds of the lead is thus removed from a solution of  $\text{Pb}_2\text{C}_2\text{H}_3\text{O}_2$ . In solution carbonic acid is but slightly dissociated into its ions  $2\text{H}$  and  $\text{CO}_3$ ; yet if  $\text{Pb}(\text{NO}_3)_2$  be present, the product of the concentrations of the Pb and  $\text{CO}_3$  ions is greater than the solubility product of  $\text{PbCO}_3$ ; hence a precipitate forms. At the same time, however,  $\text{HNO}_3$  is produced, and H and  $\text{NO}_3$  ions accumulate in the solutions, since  $\text{HNO}_3$  is strongly dissociated. Now H ions diminish the electrolytic dissociation of the  $\text{H}_2\text{CO}_3$  just as excess of  $\text{NH}_4\text{Cl}$  or HCl diminishes the ordinary dissociation of  $\text{NH}_4\text{Cl}$ . The solubility product of the  $\text{CO}_3$  and Pb ions is thus diminished, and but a small quantity



of  $\text{HNO}_3$  has to accumulate, that is, but little decomposition has to take place, before the solubility product is reduced to the critical value, and no more precipitate is produced.

If  $\text{Pb}(\text{C}_2\text{H}_3\text{O}_2)_2$  be used, since acetic acid is but feebly dissociated, much more precipitate can be produced before the H ions introduced into the solution by the acetic acid are numerous enough to reduce the solubility product to the critical value, and thus stop further precipitation.

Reactions may also be due to the formation of complex ions. Alumina in presence of water is in equilibrium with the ions Al and  $3\text{OH}$ . If KOH be added,  $\text{K}_3\text{AlO}_3$  is produced, of which the ions are  $3\text{K}$  and  $\text{AlO}_3$ . The latter is not available for equilibrium with alumina, hence the solubility-product is reduced, and more alumina must dissolve.

With a chapter on quantitative estimations, such is the subject-matter of the theoretical part of the book. The second, or practical part, is concerned with the important reactions of qualitative analysis, treated as much as possible from the above standpoints.

The book is not written for the beginner, but to supply adequate theoretical support to the routine work of general analytical chemistry. Enough has been said to show that it is in great part unique, and throughout it is refreshing and profitable reading; indeed, it affords the easiest means yet offered to the general reader of getting the gist of current views, not only of the theory of analytical processes, but of the constitution of solutions, and of chemical mechanics—the law of mass action and the velocity of chemical change.

The ideas put forward relating to the nature of analytical processes are, of course, open to differences of opinion. The time has no doubt passed when the conceptions of ions and electrolytic dissociation were regarded as but the vain imaginings of mathematicians who had dabbled in chemistry. Nevertheless the view is still widely spread, at any rate in this country, that although they serve as a means of correlating otherwise isolated properties, and of predicting phenomena in solution, they are altogether too artificial to be anything but the crudest picture of what actually exists. Be this as it may, the book before us serves a good purpose, inasmuch as it puts in a clear light the fact that the direction of analytical reactions is determined by the solubility of the possible products of the interaction, and that when the reaction has run its course we have a system in equilibrium again governed by solubility.

In the common method of presenting qualitative analysis to the student, theoretical considerations are either entirely ignored, or are supposed to be supplied by statements asserting that a precipitate AB is formed in a given solution because the affinity of A for B is greater than its affinity for the other radicles present. It is this system, coupled with the abuse of the ordinary chemical equation, whereby all reactions are regarded as perfect, that fills the ranks of budding chemists with disciples of Bergmann, the gospel according to Berthollet, Wenzel, and Guldberg and Waage, notwithstanding.

J. W. RODGER.

#### ANALYTICAL GEOMETRY.

*An Introductory Account of certain Modern Ideas and Methods in Plane Analytical Geometry.* By Charlotte Angus Scott, D.Sc., Professor of Mathematics in Bryn Mawr College, Pennsylvania. Pp. xii. + 288. (London: Macmillan and Co., 1894.)

DR. SCOTT'S treatise is a welcome addition to the many excellent text-books on analytical geometry which have been published during the last few years. But while most of the text-books in use at the present time adequately explain the initial difficulties of the subject, scarcely one can be regarded as a satisfactory book for those students who wish to go beyond the elements as treated with the use of Cartesian coordinates. For such students Salmon's "Conics" is still the standard work. But although every fresh edition of this is carefully revised to meet modern requirements, there are many beautiful geometrical methods and theories which are only briefly noticed, but which should be fully discussed in a standard work. The book under review does not, indeed, aim at replacing Salmon's, but it is admirably adapted to be used as a companion to it. It aims at giving a concise account of the principal modern developments due to Cayley, Clebsch, Reye, Klein, and a few other continental geometers. As an introduction to the study of the higher branches, it may be confidently recommended to students as a clear, full, and well-arranged exposition of the leading principles of the subject. At the same time the book is something more than a text-book for students. Those who wish to keep up their mathematics, and have no time to spare to read the various papers and memoirs that are published every year, will find much that will interest them—many beautiful geometrical ideas that are here published for the first time in an English text-book.

The author starts with the general idea of coordinates, and develops simultaneously the theory of point-coordinates and line-coordinates, with a full explanation of the special peculiarities of the two systems. The principle of duality is then explained, and the descriptive properties of curves discussed. After a short but adequate chapter on curve tracing, the theory of projection and homography is introduced, leading up to the theory of correspondence. The chapter devoted to this theory is very well written, and is in fact one of the principal features of the book. In it will be found a full discussion of quadric inversion, based on a memoir by Dr. Hirst. The remaining chapters are devoted to a discussion of the generalisation of metrical properties of curves obtained by replacing the circular points by a conic, and a brief explanation of the connection which subsists between geometry and the algebraical theory of invariants.

The treatise is confined to plane geometry, in which figures are considered as combinations of points and straight lines. In constructing a system of coordinate geometry for such figures, two theories naturally present themselves; the two in which the point and the straight line are, respectively, the *primary* elements, and the straight line and point the *secondary* elements. But although Dr. Scott states that any other geometrical entity might be taken as the primary element, she makes

not in any such theory. We wish that she had found it possible to introduce a brief notice of the analytical theory in which the circle is taken as the primary element; in view of the fact that most of the properties of an important class of curves—bicircular quantities—are best discussed by expressing the equations of these curves in terms of *trilinear* coordinates.

It is also a matter of regret that the use of trilinear coordinates is retained, although results are usually given in terms of areal coordinates as well. The use of both systems is confusing to students, and the use of the areal system has a double advantage; firstly, the fundamental metrical formulæ are more easily proved, and secondly, the areal system is intimately connected with the tetrahedral system in solid geometry. For the latter reason, if for no other, it is very desirable that the use of trilinear coordinates should disappear from our text-books on plane geometry. In this book the proofs of two fundamental results (§§ 20, 21) are long and tedious.

The only other point we have to find fault with is that harmonic relationship and involution are introduced as particular cases of cross ratio and homography. The author herself admits (p. 160) that this view disguises the real difference between the two conceptions, and explains that while cross ratio and homography relate to different spaces, harmonic relationship and involution relate to pairs of elements in the same space. The theories are developed independently, but we should have preferred that the theory of harmonic groups and the theory of involution should have been developed before the introduction of the idea of cross ratio and homography.

The examples chosen by the author to illustrate various theorems have been very carefully selected, and should be found quite sufficient for the use of students. Among them will be found many theorems of independent importance, which could scarcely be said to come within the scope of the book. We may add that an excellent index is provided. R. L.

#### OUR BOOK SHELF.

*Aurora Polaris.* By Alfred Angot. Pp. 318. Paris: Librairie Alcan, 1895.

FRENCH has made two important contributions to the knowledge of auroræ. Perhaps the first work devoted entirely to the study of auroral phenomena was the "Traité physique et historique de l'auroræ boréale," by Mairan, published by the Paris Academy of Sciences in 1732. A century later a volume was published containing the results of aurora observations made on the *Recherche* during the scientific expedition to Lapland. The plates which illustrated the observations then made have been and under tribute by M. Angot for the present volume. At the publication, however, of the "Auroræ boréales" which resulted from the 1838-39 expedition, we have it on the authority of M. Angot that no work dealing wholly with the subject has appeared in France. This volume, therefore, stands as practically the only one which our neighbours on the other side of the Channel can find a popular account of auroræ, written by one of their own countrymen.

M. Angot has treated the subject lightly, yet scientifically. He traces the history of aurora observations

from the time of Aristotle; describes the apparently adventitious forms assumed by the phenomena; explains the facts as to the extension, position, frequency, and periodicity of auroræ; develops the relations between auroral and terrestrial magnetism and electricity, and connects them with meteorological phenomena; and, finally, he presents the cosmical, optical, magnetic, and electrical theories put forward to account for the phenomena.

A list is appended, giving in chronological order all the auroræ seen in latitudes above 55° North from 1700 to 1890, with the names of the places at which observations were made. Eighteen rather coarse illustrations are distributed through the book. Altogether, the volume is a valuable summary of the growth of knowledge of auroræ.

*A Few Chapters in Astronomy.* By Claudius Kennedy, M.A. (London: Taylor and Francis, 1894.)

IN these 150 pages are discussed four or five of the numerous problems in astronomy, and these are handled in such a manner as to make them full of interest, both for the general reader and for the student. This book, unlike many others, is not written for the sole purpose of pouring condensed knowledge into the student's head, but for those who wish to sit down for half an hour or so and read for recreation, and so gain a fair understanding of some of the discussions contained in them, without going into too great detail. The points chiefly referred to, are, visual illusion affecting certain astronomical phenomena; the effect of the earth's rotation on certain moving bodies, as projectiles, paths of projectiles, Foucault's Pendulum and the Horizontal Pendulum; the causes of the tides; the moon's variation; and the parallactic inequality. In the last two chapters the text is accompanied by several figures.

As a supplement to the ordinary text-books on astronomy, this small volume will be found especially useful, as it deals with subjects not generally referred to in them, or at least only briefly mentioned.

*Mechanics for Colleges and Schools: Statics.* By R. T. Glazebrook, M.A., F.R.S. Pp. 180. (Cambridge University Press, 1895.)

THIS addition to the physical series of the Cambridge Natural Science Manuals will hardly add to the reputation of the assistant director of the Cavendish Laboratory. The only noteworthy feature is the prominence given to the experimental verification of static principles; but excepting this, little can be found to distinguish the book from others of a similar type. Many of the experiments described are intended to be performed by the students, and the theoretical consequences are, when possible, deduced from experiments. This is undoubtedly the right line to go upon, but we are afraid that few of our schools or colleges possess at present sufficient apparatus for the laboratory work described. The text is clear and concise, and sufficiently illustrated; and the examples are numerous.

*The Telegraphist's Guide.* By James Bell, A.I.E.E. Pp. 101. (London: Electricity Office, 1895.)

TELEGRAPHISTS in the Government service have now to submit themselves to a technical examination before they can obtain promotion. Herein we have a guide in which the subjects of the new examination are considered in the order laid down by the Postmaster-General. The aspiring telegraphist will find the book a means of acquiring the knowledge he needs; and students of telegraphy not directly connected with the service, may obtain from it useful information on the practical working of telegraphic systems.

LETTERS TO THE EDITOR.

[The Editor does not hold himself responsible for opinions expressed by his correspondents. Neither can he undertake to return, or to correspond with the writers of, rejected manuscripts intended for this or any other part of NATURE. No notice is taken of anonymous communications.]

Corrections of Maximum and Ex-Meridian Altitudes.

IN navigation the error introduced by taking the maximum altitude of a heavenly body for its meridian altitude is not sufficiently great to need correction when it is due to variation of declination alone, as it is then much within the probable errors of observation. When, however, a ship is steaming at a high speed, the error is considerably increased by the variation of latitude, especially when this is of opposite sign to the variation of declination.

The formula giving the correction in seconds of arc to be applied to the zenith distance of a body for reduction to the meridian is

$$x = Ch^2 \dots \dots \dots (1)$$

where, with the usual notation  $C = \frac{\cos l \cos \delta}{2 \sin(l \mp \delta)} \cdot \frac{\sin^2 15'}{\sin 1''}$ , and  $h$  is the hour angle in minutes of time. Thus, if  $z$  be the zenith distance, we have the equation

$$z - Ch^2 = l \mp \delta,$$

the upper or lower sign being taken according as  $l$  and  $\delta$  are of the same or of opposite sign. Since we may consider  $z, h, l,$  and  $\delta$  as functions of the mean time  $t$  and  $C$  constant, we have on differentiation, if  $z$  be a minimum,

$$-2Ch \frac{dh}{dt} = \frac{dl}{dt} \mp \frac{d\delta}{dt}$$

Let  $II$  and  $II'$  be the hour angles of the body and the ship's zenith measured from some fixed meridian, and let  $u, v$  denote the northerly and westerly components of the ship's velocity in knots; then  $\frac{dh}{dt} = \frac{dH}{dt} - \frac{dH'}{dt}$  and  $\frac{dl}{dt} = v$ . Also if the body's projection on the Earth's equator moves round at the rate of  $U$  knots,

$$\frac{dH'}{dt} - \frac{dH}{dt} = u \sec l/U;$$

and the above equation becomes

$$-2Ch \frac{dH}{dt} (1 - u \sec l/U) = v \mp \dot{\delta} \dots \dots (2)$$

Now this equation will assume different forms according as the body under consideration is the Sun, a star, or the Moon. For, since the motion of the ship is expressed in mean solar time, the motion of the body must likewise be expressed in that time.

The unit of time being a minute of mean time, and the unit of arc a second of arc, we have for the Sun

$$\frac{dH}{dt} = 1 \text{ and } U = 900,$$

so that (2) becomes

$$-2Ch(1 - u \sec l/900) = v \mp \dot{\delta}.$$

For latitude  $60^\circ$  and  $u = 20$  the value of  $u \sec l/900$  is about  $\cdot 04$ , so that we see for ordinary speeds and ordinary latitudes reached the term involving  $u$  may be neglected, and the equation reduces to

$$-2Ch = v \mp \dot{\delta} \dots \dots \dots (3)$$

For a star

$$\frac{dH}{dt} = \frac{\text{length of mean solar day}}{\text{length of sidereal day}} = 1$$

with sufficient accuracy, and as before we obtain equation (3).

For the Moon

$$\frac{dH}{dt} = \frac{\text{length of mean solar day}}{\text{length of lunar day}} = \frac{1}{1 \cdot 035}$$

and

$$U = 869,$$

so that in this case (2) becomes

$$-2Ch = 1 \cdot 035 (v \mp \dot{\delta}).$$

On giving  $C$  its proper value, and putting  $w$  for the velocity compounded of the velocity in latitude of the ship and the velocity in declination of the body (3) becomes

$$h = -w(\tan l \mp \tan \delta) \sin 1'' \operatorname{cosec}^2 15' \dots (5)$$

The reduction is therefore from (1)

$$x = -\frac{w^2}{2} (\tan l \mp \tan \delta) \sin 1'' \operatorname{cosec}^2 15' \dots (6)$$

Equations (5) and (6) therefore give the hour angle (from the ship's meridian) and reduction for the Sun or a star at the maximum altitude. For the Moon  $1 \cdot 035w$  must be substituted for  $w$ . The form of these equations has suggested the construction of the accompanying table, which gives the value of

1	'004	21	'098	41	'221
2	'009	22	'103	42	'229
3	'013	23	'108	43	'237
4	'017	24	'113	44	'245
5	'022	25	'118	45	'254
6	'026	26	'124	46	'263
7	'031	27	'129	47	'273
8	'035	28	'135	48	'283
9	'040	29	'141	49	'293
10	'045	30	'147	50	'303
11	'049	31	'153	51	'314
12	'054	32	'159	52	'326
13	'059	33	'165	53	'338
14	'063	34	'171	54	'350
15	'068	35	'178	55	'363
16	'073	36	'185	56	'377
17	'078	37	'192	57	'392
18	'083	38	'199	58	'407
19	'088	39	'206	59	'424
20	'093	40	'213	60	'441

$\tan x'' \sin 1'' \operatorname{cosec}^2 15'$  as far as  $x = 60$ . Thus in latitude  $l^\circ$  when a body (Sun or star) of declination  $\delta^\circ$  is at its maximum altitude, the sum or difference (according as  $l$  and  $\delta$  are of different or of the same name) of the arguments corresponding to  $l$  and  $\delta$  multiplied by  $w$  gives the hour-angle in minutes of time: the sum or difference multiplied by  $\frac{w^2}{2}$  gives the reduction in seconds of arc. For the hour angle of the Moon the sum or difference must be multiplied by  $1 \cdot 035w$ , and for the reduction by  $\frac{1}{2}(1 \cdot 035w)^2$ .

Example.—D.R. latitude  $48^\circ$  N. Moon's declination  $18^\circ 48'$  S. decreasing 120 per 10m., ship steaming S.  $20^\circ$  E. 16 knots.

Remembering that when the ship is in N. latitude, and steaming towards south

$$w = -v \mp \dot{\delta},$$

we have

$$w = -27,$$

and

$$h = 27 \times 1 \cdot 035(283 + \cdot 087) = 10 \cdot 3m$$

$$x = 144'$$

If a ship whose maximum speed is 20 knots does not reach a higher latitude than  $60$ , the greatest values that  $h$  and  $x$  can have, are for the Sun, 9m. 15s. and  $1^\circ 37'$ ; for the Moon, 17m. 20s. and  $5' 41$ .

I will now investigate the nature of a diagram from which the reduction in ordinary ex-meridian observations may be obtained, as well as the hour angle and reduction for maximum altitudes. It is found convenient for this purpose to express  $x$  in minutes of arc, when (1) becomes

$$h^2 = 2x(\tan l \mp \tan \delta) \sin 1'' \operatorname{cosec}^2 15' \dots (7)$$

Now if a circle of radius  $a$  be referred to a point in its circumference as origin, its equation is

$$r^2 = 2ax,$$

$r$  being the radius vector and  $x$  the abscissa measured along the diameter through the origin. Comparing this with (7) we see that if a system of circles be described passing through a common origin  $O$ , their centres being collinear and on the same side of  $O$ , the reduction  $x$  is the abscissa of the point whose radius vector is  $h$  on one of these circles: the particular circle on which the point lies being that whose radius is the sum or difference of the ordinates of the curve

$$y = \tan x \sin 1'' \operatorname{cosec}^2 15'$$

corresponding to

$$x = l \text{ and } x = \delta.$$

<sup>1</sup> A diagram based on the properties of the parabola was given by Prof. Foscolo, of Venice, and published by the Hydrographic Office, London, 1870.

It will be found that when

$$2 \tan \delta = \tan \delta' \sin 1' \operatorname{cosec} 15'$$

the above conditions are satisfied, and  $\alpha$  may be then considered as twice the abscissa of the point on the circle whose radius is

$$2 \tan \delta' = \tan \delta' \sin 1' \operatorname{cosec} 15'$$

In making a diagram on ruled paper, the distance between the lines being taken as unit, the difficulty of measuring  $\alpha$  and  $\beta$  is more or less overcome.

A portion of such a diagram is represented in the annexed figure,  $O$  being a portion of the curve

$$y = \tan \alpha \sin 1' \operatorname{cosec} 15'$$

described with  $O$  as origin,  $y$  being for convenience reckoned negatively.

As an example of its use, suppose it were required to find the reduction for latitude  $17^\circ$  N., declination  $9^\circ$  S., and hour-angle  $12m$ . By using a pair of dividers the sum of the ordinates of the curve  $O$   $D$  corresponding to  $9$  and  $17$  is found to be

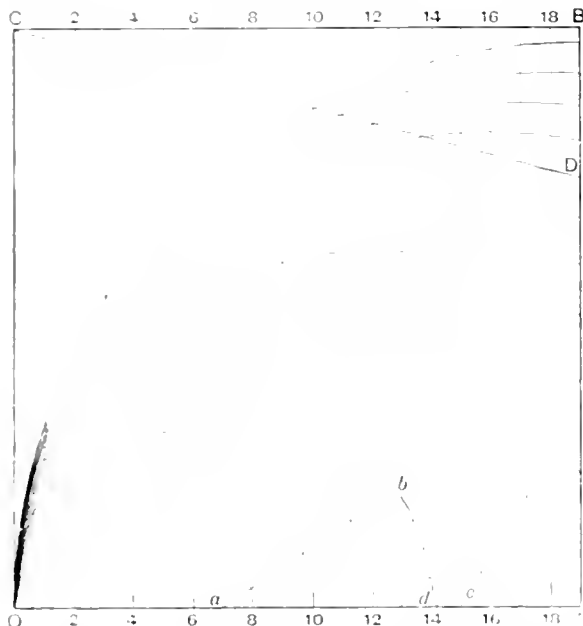

7 and a radius vector of length 12 meets the circle of radius 7 at a point whose abscissa is 10. The required reduction is therefore  $10'$ .

Again,  $\alpha$  being now expressed in minutes of arc ( $5'$ ) and ( $6'$ ) may be written

$$h = - \frac{70}{60} (\tan 17' \mp \tan 9') \sin 1' \operatorname{cosec} 15'$$

$$\left( \frac{70}{60} \right)^2 (\tan 17' \mp \tan 9') \sin 1' \operatorname{cosec}^2 15'$$

so that  $h$  and  $i$  are the lengths of the arcs of a circle and its involute respectively, corresponding to the angle at the centre whose circular measure is  $\frac{70}{60}$  in the case of the Sun, and  $1.03576 \frac{70}{60}$  in the case of the Moon. Now for the former body  $\frac{70}{60}$  will not in general exceed 20, and for the latter 38, so that we may assume for graphical purposes that in the case of the sun  $\frac{70}{60}$  is the number of degrees in an angle of circular measure  $\frac{70}{60}$ , and in the case of the Moon  $\frac{70}{60}$  is the number of degrees in an angle of circular measure  $1.03576 \frac{70}{60}$ .

Thus in both cases  $h$  is approximately the arc of a circle of radius

$$(\tan 17' \mp \tan 9') \sin 1' \operatorname{cosec}^2 15'$$

intercepted between the diameter and the radius which makes an angle  $\alpha$  degrees with it.

Having obtained  $h$ ,  $\alpha$  may be found as in the general case, or by drawing a tangent to meet the involute, as in the figure.

In the preceding example, suppose the ship to be steaming with 20 knots, the declination decreasing  $160'$  per 10m. Here  $\alpha = 36'$ . By laying off at an angle of  $36'$ , the intercepted

arc  $h$  is found to be about  $4'3$ , and by drawing the tangent at  $h$  the intercepted arc of the involute is about  $1'3$ . The hour angle and reduction for the maximum altitude are therefore  $4m.3$  and  $1'3$  respectively.

The graphical method considered above will be found to give results which, although approximate, are sufficiently accurate for purposes of navigation; in fact, if the diagram be constructed on a large scale, the reduction may be easily obtained within fifteen seconds of the truth.

H.M.S. *Harke*, Mediterranean.

J. WHITE.

Argon and the Periodic System.

THE annexed engraving is a copy, on a small scale, of a large diagram which I have used with advantage for some years in dealing with the periodic classification of the elements. It may prove of some little interest to your readers who are actively discussing the probable position of "argon," on the assumption that this remarkable substance is an element.

To the left of the illustration is a scale of equal parts, and the dots indicate the atomic weights of the elements the symbols of which are placed farther to the right. The latter are arranged in zig zag fashion so as to exhibit the periodic rise and fall in general properties, observed in each set of seven elements. A certain analogy may be traced between these periods and the loops into which a suspended cord of somewhat unequal weight can be thrown when set in vibration. Each small loop pictures for us a small period; and, just as the alternate loops are those which are in the same phase at any given moment, so the alternate periods of the elements are those between which the closest resemblances can be traced.

The members of Mendeléeff's eighth group, or the "triplets," as they are sometimes called, viz. Fe, Ni, and Co, with atomic weights from 56 to 59; Ru, Rh and Pd, 102 to 106; Os, Ir and Pt, 191 to 195, seem to form another system of elements which—to pursue the analogy of the vibrating cord—is related to that of the other elements somewhat as a given note to its octave. On carrying the eye along the curves it will be seen that the atomic weights of triplets occur nearly opposite to the points of maximum displacement of three of the greater loops. We know very little as yet about the elements the atomic weights of which lie between 140 and 180, hence we cannot recognise the triplets the atomic weights of which should be near to 150; and a similar remark applies to the elements above 210. But the distribution of the triplets throughout the whole of the best-known elements is so nearly regular that it is difficult to avoid the inference that three elements should also be found in the symmetrical position between 19 and 23, i.e. between fluorine and sodium. And further, that

TABLE OF ELEMENTS. IN ORDER OF ATOMIC WEIGHTS.

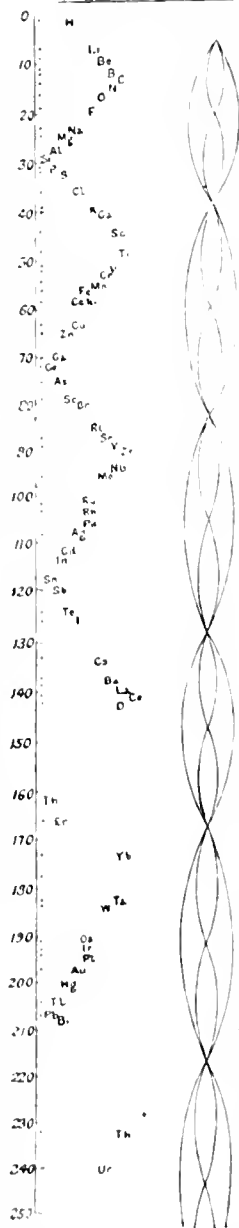

these elements—of which “argon” may be one—should exhibit properties differing chiefly in degree from the alternate palladium and platinum triplets; while hydrogen would appear as the primary of both systems of elements.

Dr. Gladstone's letter, which appeared in your issue of February 21, admirably puts the reasons for preferring an atomic weight of about 20 for argon to the higher number which Lord Rayleigh and Prof. Ramsay are now disposed to assign to it; but Dr. Gladstone seems to think that there is room for only one element, whereas three are possible, as I pointed out at the Oxford meeting, for the reasons given in the foregoing.

It will be seen from the illustration that an element with an atomic weight between 36 and 39 would belong to a third system of elements. But the sole ground for concluding that the atomic weight of argon lies between these points, is the ratio of the specific heats as determined by Kundt and Warburg's method. Lord Rayleigh and Prof. Ramsay found this ratio to be nearly equal to that afforded by mercury gas, the molecule of which is monatomic and density only half its atomic weight; hence they conclude that the argon molecule is monatomic, and that its density of nearly 20 represents but half the atomic weight. Now, while any opinion on this point, coming from the distinguished discoverers of argon, is of the highest value, it seems possible to attach undue weight to the very slender evidence afforded by the specific heats, for mercury at present is the only one of the known cases of monatomic elementary molecules in which the ratio of the specific heats has been determined. But, even admitting that the energy of the mercury and the argon molecules is chiefly translational, it is still conceivable that the argon molecule includes two atomic vortices so closely inter-linked as to have a common centre, and therefore to enable the molecule to simulate a monatomic character. Such a structure would be consistent with great stability and, consequently, with exceptional chemical indifference. J. EMERSON REYNOLDS.

Trinity College, Dublin, March 19.

Variation in *Caltha palustris*.

READING the notice of Mr. Burkill's paper on “Variations in Stamens and Carpels,” in NATURE of February 7 (p. 359), I remembered the following notes on *Caltha palustris*, which my wife and I made at Corfe, Dorset, June 11, 1891.

*C. palustris*: heads in pairs on a dichotomously branching stalk; number of follicles in each head, counted in several specimens, as follows:—

7 follicles on one, 4 on the other, of a pair. 8—5, 5—7, 5—6, 6—6, 6—7, 7—5, 9—9, 10—8, 11—8, 9—6.

Thus there is great variation. One stalk is longer than the other, of a pair, and it is presumed that in every case the shorter one flowers first. It will be noticed that in the above eleven instances, only two had the same number of follicles on both stalks. Of the remaining nine, three had most follicles on the longer of the stalks, and six had most on the shorter. Those on the shorter stalk were larger than those on the longer, presumably because older.

A second memorandum gives the results of fifteen more counts, all taken at random, thus (L. = longer, S. = shorter stalk):—

L. with most follicles.		L. and S. equal.		S. with most follicles.	
L.	S.	L.	S.	L.	S.
5—4	...	8—8	...	4—6	...
				4—8	...
9—8	...	5—5	...	6—7	...
9—7	...	10—10	...	8—10	...
		7—7	...	9—10	...
		10—10	...	7—8	...
				4—5	...

It accordingly appears that the later-flowering, longer-stalked head produced more follicles in just half the number of cases counted (13 out of 26), and the shorter-stalked head had a majority in only 5 cases, the remainder being equal.

In a *Bidens* found at Barbadoes (West Indies), on July 6 of the same year, there were similarly two heads, a long-stalked and a short-stalked, the latter flowering first. It would be interesting to get statistics of the numbers of akenes in the heads in this. The species was not certainly determined, but it is of the section of *B. bipinnata*. T. D. A. COCKERELL.

New Mexico (U.S.A.), February 24.

DR. M. FOSTER ON THE TEACHING OF PHYSIOLOGY IN SCHOOLS.<sup>1</sup>

THE teaching of science in schools has, it seems to me, two uses. The first is what I may call the “awakening” use. Many minds who feel no interest in the ordinary subjects of school learning, to whom the ordinary lessons appear as so much dull mechanical work, are at once stirred to intellectual activity when the teaching of this or of that science is presented to them. The second use is the more distinctly “educational,” training use.

The minds of the young being, happily, differently constituted, one mind is especially “awakened” by one branch of knowledge, another by another. One boy or girl dates the beginning of his or her intellectual activity from the day on which he or she had a first lesson in chemistry. Another starts in the same way with botany. And the number of those to whom physiology thus serves as “awakening” knowledge, is, it seems to me, sufficiently great to render it desirable, by the introduction of the teaching of physiology into schools, to afford adequate opportunities for its exercising this beneficial effect.

It follows that, taught from this point of view, physiology should be taught as a new independent subject, not demanding any previous knowledge; it should be presented as a wholly new field into which the natural mind may wander at will without any restrictions as to being qualified for entrance. It also follows that the teaching must be of a most elementary kind, that as much of chemistry or physics as is necessary for the comprehension of the physiological matters should be taught with the physiology, and, as it were, as a part of it, the pupil being led into chemistry and physics by his interest in physiology, and not being compelled to learn the one for which he or she perhaps does not, at present at least, care before beginning the other.

The instruction given, however elementary it may be, should consist in part of demonstrations and practical exercises. I need not enumerate these in detail, but they must necessarily be limited in scope; the dissection of a rabbit or some other animal to show structure, some little microscopic work, such as the microscopic study of the blood and of a few tissues, the examination of the structure and working of the heart, the mechanics and elementary chemistry of breathing, and the like. But all these demonstrations, like the rest of the teaching, I may repeat, should teach so much of chemistry, of mechanics, &c., as is needed, as a part of the physiological lesson.

As an “awakening” study, I am in favour of physiology being very widely taught; but, as almost necessarily follows from the view on which I have been dwelling, it ought not to be made a compulsory study. Made compulsory, it would as an awakening study lose much of its virtues. I do not hide from myself the fact that the present gross ignorance which prevails among most men and women as to the most elementary facts concerning their own bodies is most undesirable, especially perhaps as regards women; but I am most decidedly of opinion that it is better to meet this evil by encouraging the study of physiology than by making it compulsory.

Physiology, as a distinctly educational study, as a training for the mind, is a very different matter; and it is, in my opinion, in this aspect unsuitable for schools. The training for the mind which physiology affords is one, I venture to think, of no small value, but is one

<sup>1</sup> A short time ago, on my consulting him on behalf of a committee appointed by the Headmasters' Association, to draft regulations for major scholarships' examinations, Prof. Michael Foster was good enough to give me this statement of his opinion on the teaching of physiology in schools—a subject of great importance, but of great difficulty, regarding which much misconception prevails; it appears to me to be so valuable, that I have sought for and obtained his permission to publish it.—HENRY E. ARMSTRONG.

which, especially compared with that afforded by some other sciences, is relatively slight when the knowledge is elementary, increasing rapidly as the study becomes advanced. Further, while I have just urged that elementary physiology as an awakening study may be an indeed should be taught by itself, independent of other kinds of knowledge, I can now urge equally strongly that a study of physiology, beyond the mere elements, is impossible without a previous adequate knowledge of chemistry and physics. Again, while the practical teaching of the rudiments of physiology can be carried out anywhere and by any one, the further study of physiology demands no inconsiderable laboratory accommodation, complicated apparatus, and experiments on animals. Lastly, if the study of physiology is to be real, the whole body must be dealt with, no parts being excluded for special reasons; and this means that the real study cannot be taken up until after puberty. For these reasons it seems to be undesirable to press the introduction of physiology into schools as an educational subject; all the more so, since not only both chemistry and physics are admirably adapted for this purpose, but also a not inconsiderable knowledge of both these sciences is needed for the proper study of physiology; and I imagine that by the time a boy or girl is thus prepared to study physiology, it is time that he or she should leave school.

While I am thus opposed to physiology being placed in a false position in the school curriculum, I feel myself all the more free to urge the very general introduction of an elementary study of the subject on account of its awakening value. I cannot define the amount of physiology which should thus be introduced more closely than by saying that the ground covered should be about that covered by my Primer. I would add that so far as is possible the pupils should see for themselves everything which is talked about in the lesson.

As to "physiology being a proper subject to be included among subjects for scholarship examinations for young pupils," I am so impressed with the painful evils of the present scholarship system, that I am most loth to say anything that would in any way lead to an addition to that system. If the scholarship examination is to be a test of education, of intellectual training, it is obvious from what I have said above, that physiology cannot be put on the same level with chemistry and physics. At the same time, if such subjects as physiology or botany are excluded from scholarship examinations, no little injustice, it appears to me, is likely to be done in the following way. A lad, let us say, shows an early bent towards physiology, and acquires at school a very considerable knowledge of its rudiments. His future career depends on his gaining a certain scholarship. If in the examination for that scholarship his place depends solely on the way in which he has acquitted himself in chemistry and physics, in which his interest is of a secondary character—he regarding them merely as helps to physiology—the world may be robbed of an eminent physiologist. Hence I would say that if the evil of a scholarship examination must come, I would give an opportunity of an elementary knowledge of physiology being, in some way, rewarded.

#### NOTES.

DR. RAMSAY has been good enough to forward to us the following translation of a passage in a letter he has recently received from Prof. Olszewski: "I have at last succeeded in determining the critical temperature and the boiling-point of hydrogen. I have found for the former  $233^{\circ}$  and for the latter  $213^{\circ}$ . I have used the dynamical method, which I described in the *Philosophical Magazine*. A thermal couple proved of no use, and I was obliged to avail myself of a platinum-wire thermometer, measuring the temperatures by the

alteration in resistance of the wire. I have obtained satisfactory results, and intend to publish an account of them in English."

MR. FREDERICK WEBB has presented the sum of £1000 to the Medical School of St. George's Hospital, to found an annual prize in bacteriology.

PROF. VICTOR HORSLEY, F.R.S., has been elected into the Atheræum Club, under the provisions of the rule which empowers the annual election by the committee of nine persons "of distinguished eminence in science, literature, the arts, or for public services."

WE are glad to learn that there is no foundation for the report of the death of Prof. H. Wild, of St. Petersburg, noted in these columns on February 28. The mistake arose owing to the announcement of the decease of a German investigator of the same name.

AT the meeting of the Royal Irish Academy, on March 16, the following were elected honorary members. In the section of Science: Dr. Karl Weierstrass and Prof. du Bois Reymond, and Prof. E. Suess. In the section of Polite Literature and Antiquities: Prof. A. Erman, Dr. E. Zeller, Lieut.-General H. L. F. Pitt-Rivers, and Mr. S. R. Gardiner.

AT the Paris Academy of Sciences last week, a bronze medal, engraved by Chaplain, was presented to M. Bertrand, in honour of his jubilee. The medal has on one side a likeness of M. Bertrand, and the reverse side bears the following sentiment: "To Joseph Bertrand, member of the French Academy, Perpetual Secretary of the Academy of Sciences, in honour of fifty years' devotion to science and education, from his pupils, admirers, and friends. March, 1844-1894."

THE Anniversary Dinner of the Fellows of the Chemical Society will be held at the Hôtel Métropole on Wednesday, March 27, when Dr. Henry E. Armstrong, President of the Society, will occupy the chair. The Right Hon. A. J. Balfour, M.P., James Bryce, M.P., the Presidents of some of the learned Societies, and several other distinguished guests have accepted invitations to the dinner.

A NUMBER of organisations for scientific research in the leading cities of the American sea-board, including Philadelphia, Princeton, New York, Brooklyn, and Boston, have combined to organise an expedition to the west coast of Greenland. The expedition will be fitted out at Newfoundland, and will sail next June. Elaborate preparations are under way to insure important results to science. Each of the Societies participating will send a representative, including several who went last year, such as Profs. Libbey and Chamberlin. The Brooklyn Institute will send a representative, to be chosen hereafter.

THE death is announced of Mr. A. W. Beetham, at Dawlish, in his ninety-fifth year; he was elected a Fellow of the Royal Society in 1835. We also notice the death of Mr. J. C. Smith, president of the Institution of Civil Engineers of Ireland; of Dr. Hermann Grote, one of the most eminent experts in numismatics; of Mr. G. N. Lawrence, a leading American ornithologist; of General de Nasonty, founder and director of the Pic du Midi Observatory, which for twenty-one years has rendered great service to agriculturists in the French Pyrenees; and of Prof. Julien Brunhes, at Dijon.

THE Belgian Academy of Sciences offers a prize of 600 francs for the best essay on each of the following subjects:—(1) On the number of chromosomes before impregnation in an animal or a plant; (2) On the Quaternary Flora, especially that of peat-bogs; (3) Is there a nucleus in the Schizophyta? if so, what is its structure and its mode of division? The essay must contain a critical review of the publications existing on the subject. Each essay must be the result of original investigation.

THE Bologna Academy of Sciences offers a gold medal having the value of one thousand Italian lire (£40) as a prize to the author of a memoir which describes the best system or new apparatus for preventing or extinguishing fires, by chemical, physical or mechanical means. The competition is open to persons of all nationalities, and the memoirs must reach the Secretary of the Academy before the end of May, 1896. The descriptions should be written in Italian, Latin, or French, but memoirs will be permitted to compete if written in any other language, provided a translation in Italian accompanies them.

THE *Times* correspondent at Cairo reports that the Council of Ministers has approved Mr. Garstin's proposal for clearing Philæ of débris, in order to make a thorough examination of the bases of the temples, and explore the subterranean passages which intersect the island. This work, which is of high importance to the scientific world, will be done by the Public Works Department, an official from the Antiquities Department attending to insure that all objects of interest are preserved. The Ministry of War will be asked to lend Captain Lyons, R.E., to superintend the work.

THE United States Government is (we learn from the *British Medical Journal*) about to undertake an investigation of the climates of the country in connection with the indigenous diseases. The investigation will be conducted by the Weather Bureau of the Department of Agriculture, the Chief of which, Mr. Mark W. Harrington, has on many previous occasions given proof of an active interest in sanitary climatology. The precise manner in which the results of the investigation will be made public has not yet been decided upon, but it is hoped soon to publish a periodical devoted to climatology, and its relations to health and disease.

By the consent of her Majesty the Queen, a piece of ground—the Palace Meadow—about four and a half acres in extent, has been ceded to the Royal Gardens at Kew, for the use of the public. The concession is a great convenience, for the removal of the fences will allow visitors to make a direct, instead of a circuitous, access to the finest part of the Arboretum. The Gardens are 251 acres in extent. It is not generally understood (says the *Kew Bulletin*) that they were originally the private property of the Crown, and not acquired out of public funds. The building used for the Herbarium and Library was sold to the nation by George IV. Access to the remainder has been step by step conceded to the public by the liberality of her Majesty the Queen.

The annual general meeting of the Italian Botanical Society will be held this year in Palermo, from April 16 to 23. The opportunity will be taken of celebrating the hundredth anniversary of the foundation of the Botanic Garden at Palermo.

ON Thursday next, March 28, Dr. E. B. Tylor, F.R.S., will deliver the first of a course of two lectures at the Royal Institution, on "Animism as shown in the Religions of the Lower Races." The Friday evening discourse, on March 29, will be delivered by Dr. H. E. Armstrong, F.R.S. His subject will be "The Structure of the Sugars and their Artificial Production."

THE Zoological Society of France held its second annual reunion on February 28, under the presidency of Prof. Léon Vaillant. The meeting was a marked success, a number of zoologists from all parts of France favouring the Society with original communications. It has been decided to make these annual conferences, to which all naturalists are cordially welcomed, a permanent feature, and to arrange in future for microscopical and other demonstrations, as well as numerous social gatherings.

WHEN the Council of the Zoological Society of France voted to support the movement for the establishment of an international bibliographical bureau, it charged one of its members, Prof. E. L. Bouvier, to present a report at the annual reunion of the Society. Basing its decisions upon this report, the Society has nominated a central Committee of Management, composed of the following titular members:—Dr. Raph. Blanchard, Prince Roland Bonaparte, Prof. Ives Delage, Prof. Henri Filhol, Prof. Albert Gaudry, Baron Jules de Guerne, Prof. A. Milne-Edwards, and Prof. A. Raillet. Twenty zoologists, residing in various parts of France, have been nominated as associate members. To complete the organisation, eleven special correspondents have been appointed, whose duty will consist in reporting to the Bureau such works as are inaccessible to it. A preliminary inquiry among the various scientific societies and the leading publishers has shown, however, that nearly all the zoological publications of France will be sent gratuitously to the Central Bureau. Not a single failure to accept this invitation to co-operate has thus far been reported.

THE annual meeting of the German Zoological Society will be held this year at Strassburg, on Tuesday, Wednesday, and Thursday, June 4 to 6. A preliminary general programme of the meeting has already been issued, and in the list of papers promised for the occasion we notice one by Prof. Goette, "On the Ancestry of the Vertebrata," and another by Dr. Bürger, "On Nemertines." The mornings will be devoted to general business and the reading of scientific communications and reports, and the afternoons will be reserved for demonstrations and the inspection of the laboratories. The meeting should possess considerable interest, and many will probably be glad to avail themselves of the cordial invitation which the Society extends to zoologists of other nationalities to attend the meeting as guests, and to take part in the proceedings of the Society.

THE Paris Geographical Society has awarded its prizes for 1895, as follows:—Gold medals, to Lieut. L. Mizon, for his explorations in West Africa; E. Gautier, for his explorations in Madagascar; F. Foureau, for his explorations in the Sahara; E. Ponel, for his explorations in the region of the French Congo; Th. Moureaux, for his magnetic map of France; Father Colin, for his observations and triangulations in Madagascar; A. Courty, for the production of a map of the Congo; V. de la Blache, for his general atlas; and Dr. Thoroddsen, for his explorations in Iceland. Silver medals have been conferred upon E. D. Ponceis, for his journey from Turkestan to Kashmir by the Pamirs; J. Gaultier, for his works on the production of plans by photography; B. d'Attanoux, for his exploration in the Sahara; and J. Forest, for his studies on the breeding and habits of the ostrich in the Sahara. The Jomard prize has been awarded to L. A. Rainaud, for his memoir entitled "Le Continent austral: hypothèse et découverte."

SINCE the decision in the case of the Leeds Sunday Lecture Society, when it was held that the delivery of a lecture on a Sunday came within the meaning of the "Act for Preventing certain Abuses and Profanations on the Lord's Day, called Sunday," if the public were not admitted free, the Sunday Society has been exerting itself to procure an amendment of the vexatious Law as it now stands. Lord Hobhouse, who presided at a conference of Sunday Societies held last month, has introduced a Bill into the House of Lords for amending the Act in accordance with a resolution passed on that occasion. The Bill aims at securing that in future—"No action for the recovery of any penalty shall be commenced against any person in respect of the opening of any Museum, Art Gallery, Science or Art Exhibition, Garden or Library, as such, or the delivery of any lecture on science, literature, art, or kindred subject, or any recitation, or the giving of any performance of music,

either vocal or instrumental, on Sunday, provided that the same take place under the management and control of a Society, Committee, or other body of persons, for the public advantage and not for pecuniary profit."

It is proposed to hold an International Exhibition at Atlanta, Georgia, U.S.A., from September 18 next, to December 31. The classification includes the usual departments of International Exhibitions, the following being the divisions:—Minerals and Forestry; Agriculture, Food and its accessories, Machinery and Appliances; Horticulture, Viticulture, Pomology, Floriculture, &c.; Machinery; Manufactures; Electricity and electrical appliances; Fine Arts, Painting, Sculpture, and Decoration; Liberal Arts, Education, Literature, Music, and the Drama; Live Stock, Domestic and Wild Animals, Fish, Fisheries, and Fish Culture; Transportation. The United States Government have given permission for exhibits to be brought in free of Customs' duties, unless the goods are entered for consumption in the States. Exhibits are invited from foreign countries on the usual conditions. Further information may be obtained from the Director-General, Mr. C. A. Collier, Piedmont Park, Atlanta, Georgia, U.S.A. Copies of the classification and general regulations have been sent to the Secretary of the Society of Arts, and can be seen at the Society's offices by any persons interested.

At a recent meeting of the Oriental Club of Philadelphia Dr. D. G. Brinton writes in *Science*, Dr. J. P. Peters, whose researches among the ruins of the valley of the Euphrates are well known, mentioned his observations on the deposition of alluvium by the river as a chronometer for measuring the antiquity of some ruin mounds. The deposits from the known date of Alexander's conquests display marked uniformity; and taking the depths of these as a standard, the foundations of Ur (the "Ur of the Chaldees" of Genesis, the modern Machair) and of Eridu (the modern Abu-Shahreïn) must have been laid about seven thousand years B.C.

A SUBSTITUTE for wood is badly wanted in the construction of warships. In the recent actions between the Chinese and Japanese fleets, several ships were disabled by serious fires on board, and this has caused much attention to be given to the invention of artificial wood, both at home and abroad. A Board of experts, says the *Journal* of the Franklin Institute for March, was lately convened by direction of the Secretary of the U.S. Navy to consider the subject of dispensing with wood in the construction of the naval ships now building, and also for the purpose of finding some suitable substitute for wood where it is impracticable to use metal. The Board has decided that a substitute for wood should be light, or not heavier than wood, non-conducting, non-combustible, and, when struck by shot, should not fly into splinters. Wood has the very objectionable property of splintering from the effect of shot; and the fact is well known that, in wooden ships, frequently as many persons are wounded by splinters as by shot.

A SOLUTION of the problem of finding a substitute for wood, seems, in the opinion of the Board, to lie in the following direction:—Select something in the nature of cheap wood or vegetable fibre and fine sawdust; treat them chemically with some insoluble fire-proof substance, not too heavy; then press and roll into boards, more or less dense, according to the use for which the material is desired. Such a material will be non-inflammable all through, will not splinter, will not be heavy, and will be a non-conductor. Possibly this artificial board can be strengthened by enclosing within it a tough, fine wire netting. If sawdust, or other fine cellulose material, after being rendered non-inflammable, can, by mixing with other materials not too heavy—or, if heavy, in small quantities—be applied to

metal in a plastic state, so as to harden into a compact mass impervious to water, then it will be of great value. In other words, if a light, non-conducting, non-inflammable, insoluble cement can be discovered, it will be of great use in ship construction.

NUMEROUS objects made of wood and covered with copper have been found during the exploration of mounds in Ohio. Prof. F. W. Putnam has described specimens of this kind, and copper objects sheathed with silver. The examples found are quite sufficient to show that the American aborigines in the Mississippi valley and in South America had the art of cold-hammering copper, of heating it to overlie and fit upon a warped or curved surface, and of turning the edges under. This process must not be confounded with the mere hammering-out of implements, nor with the process of making a sheet of copper as thin and uniform as a ship's sheathing, and then producing figures by rubbing or pressure. A note by Prof. O. T. Mason, in the *Proceedings* of the U.S. National Museum (vol. xvii. No. 1015), shows that the Haida Indians, who occupy the Queen Charlotte Islands, and are famous for their carved work, also cover wood and bone with copper. He describes two figures of humming-birds carved in wood, and having their wings and tails overlaid with a covering of sheet copper. The surfaces are neatly engraved with the conventional wing and eye signs of the Haidas. These specimens, and those from the mounds of Ohio, throw some light upon the processes employed by the aboriginal metallurgists of America.

It will be remembered that in June last, Prof. C. V. Riley resigned his position as Chief of the Division of Entomology of the United States Department of Agriculture, and was succeeded by Mr. L. P. Howard. Owing to these changes, the publication of *Insect Life*—the premier of entomological bulletins—appears to have ceased for a time. The periodical has, however, been revived, and three numbers of a new volume (vol. vii.), edited by Mr. Howard, have come to us, together with the last number of vol. vi., published under the joint editorship of Prof. Riley and Mr. Howard. Each of the numbers contains a store of information, in the form of articles or notes, on the life-habits of insects, especially in relation to agriculture. In one (vol. vi. No. 5) we notice an address on "Bees," by Prof. Riley, and in another (vol. vii. No. 1) we have an illustrated description of the senses of insects, by the same writer. The second number of the new volume is devoted to the proceedings of the sixth annual meeting of the Association of Economic Entomologists, held in August 1894. The presidential address delivered by Mr. Howard on that occasion, dealing with the rise and present condition of official economic entomology, shows what official encouragement is given to the investigation of insect problems in all parts of the world.

MOST of the great advances in entomology have come from America, but, as Mr. Howard points out in the address referred to above, this progress would not have been possible without legislative encouragement. At the present time the amount of money expended for work in economic entomology is far greater in the United States than in any other country. There the regular annual expenditure in the support of entomological offices amounts to about one hundred thousand dollars. Probably the total sum expended annually in experiments and publications exceeds the entire amount expended in the same direction by the remainder of the world. No wonder, then, that the whole world looks to America for instruction in economic entomology. And the results obtained justify the money expenditure. Not a year passes, Mr. Howard remarks, in which the sum saved to agriculture and horticulture, as the direct result of the investigations



of entomologists, does not amount to many times that which the United States Government grants. The results have thus added greatly to the productive wealth of the world, and this fact alone should be sufficient to lead our own Government to a more generous recognition of work in economic entomology.

SEVERAL German periodicals have published an account of a remarkable balloon ascent made in the "Phœnix" by Dr. A. Berson, on December 4 last. The balloon was inflated with 70,600 feet of hydrogen, and ascended from Stassfurt (Prussia) in the morning, taking a north-westerly direction, the weather at the time being somewhat misty. The temperature at first increased up to a considerable height; at 4900 feet the thermometer stood at  $41^{\circ}$ , and at 16,400 feet it read 0, with a very dry air. At noon, an hour and half after starting, a height of 22,150 feet was reached, and the thermometer fell to  $-20^{\circ}$ . At this time Dr. Berson began the artificial inhalation of oxygen, with excellent results. At about 29,500 feet the balloon passed through a veil-like stratum of cirrus clouds; these did not consist of ice crystals, but of perfectly formed flakes of snow. About two and a half hours after starting, a height of about 31,500 feet had been reached, the thermometer dropped to  $-54^{\circ}$ , and indicated only  $-11^{\circ}$  in the sun's rays; at this height Dr. Berson, being alone, thought it prudent to commence the descent. At 4600 feet the highest temperature was recorded, viz.  $43^{\circ}$ , and between this point and the earth it dropped to about  $34^{\circ}$ . The ascent occupied 3 hours, and the descent 2h. 20m., the balloon having travelled 186 miles, notwithstanding that the wind was almost calm on the surface of the earth. Dr. Berson obtained observations at a greater altitude than they had before been made; in Mr. Glaisher's celebrated ascent of September 5, 1862, the last actual observation was at 29,000 feet, although it is supposed that the balloon rose at least 7000 feet higher. The above particulars are taken from an account given in the *American Engineer* for this month.

ABOUT three years ago, the Botanic-Garden at Cape Town was transformed into a town garden supported by municipal rates. A similar change has lately taken place at King William's Town, in the eastern province of the colony. The *Kew Bulletin* for March rightly condemns these changes, and the perfunctory manner in which botanic gardens in South Africa have generally been treated. It points out that, at the present moment, Cape Colony is the only important British possession which does not possess a fully-equipped botanical institution. It is true it possesses a fine colonial herbarium, under the competent charge of Prof. MacOwan, and an agricultural department which he efficiently advises on botanical subjects. But beyond this it has no central authority dealing with the practical aspects of the science of botany, and no gardens under technical control where careful experimental cultivation could be carried on, or where special seeds and plants could be obtained for starting new industries. This condition of affairs, the *Bulletin* holds, is scarcely credible to a large and wealthy community like that at the Cape. Something more than an ornamental garden, dotted here and there, is required in South Africa. A central establishment in the neighbourhood of Cape Town, devoted to the scientific study and experimental cultivation of plants, fully equipped to discharge its studies as a national institution on the lines of Kew, would alone be worthy of the future of South Africa. The flora of this part of the world is one of extreme interest. It deserves to be carefully and exhaustively studied, and numerous plants, now in danger of becoming extinct, should be preserved in some central spot for the observation of students. Of the economic influences of such a central institution it is needless to enlarge. There are hundreds of problems connected with the cultivation of in-

dustrial plants in South Africa awaiting solution, and these could only be dealt with at an institution specially devoted to scientific research, where careful trials could be conducted extending over many years.

IN a recent publication by Dr. L. A. Bauer, entitled "Beitrag zur Kenntniss des Wesens der Sæcular Variation des Erdmagnetismus" (Inaug. Diss., University of Berlin), some interesting and important contributions to our knowledge of that enigmatical phenomenon of terrestrial magnetism—the secular variation—have been made. The author has constructed the actual curve described in the course of centuries by the north end of a "free magnetic needle" at various stations (24) distributed over the globe. The result has been the establishment of a law governing the *direction* of the curve, which the author claims is the first law that has been established thus far with regard to the secular variation as applying to the whole earth. This law may be expressed as follows:—The north end of a freely suspended magnetic needle, as viewed from the point of suspension of the needle, moves, in consequence of the secular variation of terrestrial magnetism on the entire earth, in the direction of the hands of a watch. With regard to the period, Dr. Bauer believes that it has not yet been proved that the earth actually possesses a common secular variation period. The only way he thinks it possible to deduce a common period is by the supposition that the curve described by the magnetic needle is not a single closed one, but consists of loops. Indications of such loops, he says, make themselves apparent at various stations. A comparison is also drawn between the secular variation and the momentary distribution of terrestrial magnetism. A secular wave is followed around the earth with the aid of the projected curves. It would appear as though a continuation of the secular curve is obtained by going around the earth eastwardly. The fact thus revealed, the author says, would have, as a direct consequence, that if a survey be made along a parallel of latitude in an easterly direction, a similar motion of the magnetic needle would be encountered as in the case of the secular variation. Dr. Bauer has carried out this idea for three epochs, viz. 1780, 1829, and 1885, and along several parallels of latitude. The curves described by the needle are projected and given on a special plate. It has been found that in every case the north end of the needle, as observed from the centre of the needle, moves clockwise. Furthermore, by a comparison of both sets of curves—the secular and the momentary—it would appear as though they are subject to similar laws.

THE method adopted in the Physikalisch-Technische Reichsanstalt for turning true spheres is described by Herr von Liechtestein in the *Zeitschrift für Instrumentenkunde*. Three grinding cylinders, the diameter of which is less than that of the sphere, are mounted in a lathe, two of them being carried by one head and one by the other. They are disposed at angles of  $120^{\circ}$  to each other in a horizontal plane, and grasp the sphere between them. Their rotation produces a perfectly irregular motion of the sphere, and between the three cylinders it is ground to an extraordinary truth of figure. Iron and steel spheres of 25 mm. diameter thus produced showed errors of diameter not exceeding 0.0015 mm.

IN the yearly report of the Russian Geographical Society, we notice that M. Roborovsky, chief of the Tibet expedition, has made a careful survey of the Lukchun depression, the level of which, as is known, lies below the level of the ocean. It appears that the depression has a length of nearly 100 miles, and an average width of 50 miles, and that its level is from 100 to 150 metres below the level of the sea. The desert which is situated in the south of it was crossed in several directions, and M. Roborovsky succeeded in obtaining no less than six speci-

mens of the wild camel. After having reached Sa-chou, the expedition made extensive surveys in the Nan-shan highlands, and then went out for the exploration of the country in the east of Lake Kulanor.

WITH reference to Mr. Culverwell's recent criticism of the astronomical theory of the Ice age, the Rev. O. Fisher (*Geol. Mag.* for March) quotes the opinion of the late Prof. Adams, expressed to him in a letter dated February 28, 1866. He says: "I do not myself believe in the change of eccentricity of the earth's orbit being a cause of climatal changes on the earth. The effect, if any, would depend only on the *square* of the eccentricity; and this always remains so very small, that I believe the effect on the earth's mean temperature would be almost insensible. Depend upon it, geologists who look in this direction for the cause of glacial epochs are entirely on the wrong track. It seems to me much more likely that the actual act of emission of heat from the sun is variable, than that the change of eccentricity of the orbit should have any sensible effect."

PROF. F. BRIOSSI read before the Accademia dei Lincei, on March 3, a very full account of the life and works of the late Prof. Cayley, who was a Foreign Associate of the Academy.

A WORK almost entirely concerned with Insurance statistics is "Bourne's Handy Assurance Directory," now carried on by Mr. W. Schooling. Every one interested in statistical information relating to human life will find the volume useful.

IN the "Handbook of Jamaica" (Stanford) for 1895, compiled by Mr. S. P. Musson and Mr. T. L. Roxburgh, short biographical descriptions are given of the men of science who have been associated with the island, in addition to the historical, statistical, and general information concerning it.

THE number of the *Bulletin* of the Botanical Department, Jamaica, for January 1895, edited by the Director, Mr. W. Fawcett, is largely occupied with the insect enemies of the cocoa (*Theobroma*) and pine plantations, and some of the Coccidæ or scale-insects. It also contains a very interesting report on the services rendered in the island by the Botanical Department of Jamaica.

WITH the March number, *Science Progress* commences its third volume. Dr. E. Klein, F.R.S., contributes to the number an article on antitoxin, and Mr. J. E. Marr, F.R.S., summarises recent literature concerned with foreign work among the Precambrian and Palæozoic rocks. The subjects of the remaining articles are:—"Insular Floras," by Mr. W. B. Hemsley, F.R.S.; "Peptone," by Dr. W. D. Halliburton, F.R.S.; "Budding in Tunicata," by Mr. W. Garstang; and "The Reserve Materials of Plants," by Prof. J. R. Green.

THE first part of Mr. C. B. Moore's valuable report of his excavations in the prehistoric sand mounds of the St. John's River, Florida, was noticed in these columns last November (vol. li. p. 27). The second part, which has now reached us, contains the results of seven months' continuous work upon all the remains that could be found, and the complete report practically exhausts the study of the mounds on the banks of the St. John's River; for the river has been explored from the source to its outlet. The mounds described in the part of the report before us are, perhaps, not quite so interesting as those of which an account was given in the former part, but this does not diminish their value to archaeologists. Future workers among the mounds will find that all the objects found are recorded, instead of merely the rare ones, and those of unusual workmanship. The flint implements, curious types of earthenware, and human remains described, and finely illustrated, furnish material for much scientific study. The Philadelphia Academy of

Sciences, in the *Journal* of which (vol. x.) Mr. Moore's report appears, deserves much credit for the admirable illustrations.

METEOROLOGISTS and physicists have reason to be grateful to Mr. S. P. Langley for the valuable series of numerical tables which he has projected, to take the place of a series of meteorological tables compiled by Dr. Arnold Guyot, and published by the Smithsonian Institution in 1852. Dr. Guyot's tables were widely used and appreciated, but the new series will be of even greater service. The work will be completed in three parts: Meteorological Tables, Geographical Tables, and Physical Tables. The first of these volumes appeared in 1893; the second (Smithsonian Miscellaneous Collections, No. 854) lies before us. This has been prepared by Prof. R. S. Woodward, whose experience in geodetic work particularly qualifies him for the task. The introductory part of the volume is divided into seven sections, under the heads: useful formulae, mensuration, units, geodesy, astronomy, theory of errors, and explanation and use of tables. This section takes up a hundred pages, after which come tables running into one hundred and eighty pages. Every effort appears to have been made to avoid errors, and Prof. Woodward has made a judicious selection of matter from a vast amount of available material. It requires no great prophetic instinct to say that his compendium will be prized by geographer and meteorologist, as a standard work of reference.

THE Meteorological Society of Berlin has published its Report for the year 1895; the Society holds monthly meetings between October and May, and a summary of the papers read is regularly printed in our columns. Prof. Hellmann, the President, appends to the Report a discussion of the wind velocity at Berlin from ten years' anemometrical observations. The principal maximum, in the yearly period, falls in March, and the minimum in September; in the daily period, the maximum throughout nearly the whole year occurs between 11. and 2h. p.m., with a tendency to a second maximum during the night in the cold season. The greatest hourly velocity recorded was fifty miles an hour, which is about half the rate that has been registered in the greatest storms on our own coasts.

WE have received from Dr. Henry Bovey a paper of high technical value, containing the results of numerous experiments which have been carried out in the testing laboratories of the McGill University, on the strength of Canadian Douglas fir, red pine, white pine, and spruce. The tables given tend to prove that timber, unlike iron and steel, may be strained to a point near the breaking-point without being seriously injured. In almost all cases the increments of deflection and extension, almost up to the point of fracture, are very nearly proportional to the increments of load, thus showing that it is difficult to define a limit of elasticity for timber. This, Dr. Bovey thinks, probably accounts for the continued existence of many timber structures of wood in which the timbers have been, and are still, continually subjected to excessive stresses, the factor of safety being often less than one and a half. Whether it is advisable so to strain timber is another question, and experiments are still required to show how wood is affected by frequently repeated strains.

A FURTHER memoir concerning the interesting sodium derivative of nitro-ethane, and the sodium compounds of nitro-paraffins generally, is contributed by Prof. Victor Meyer to the *Berichte* of the German Chemical Society. The nature of these unstable compounds has not hitherto been satisfactorily determined, for in a communication to the *Annalen der Chemie*, J. U. Nef, some time ago, stated that they do not partake of the nature of true derivatives of nitro-paraffins, but contain an altogether differently constituted organic residue. The ex-

perimental evidence adduced in support of this view consisted chiefly of the observation which he made that the parent nitro-paraffin was not, or only to a slight extent, regenerated upon treating the sodium compound with dilute sulphuric acid, the compound being decomposed with evolution of nitrous oxide and formation of an aldehyde or ketone. Prof. Meyer has made further experiments in this direction, and their results definitely fix the nature of these sodium compounds, proving that they are indeed true sodium derivatives of the nitro-paraffins, being formed by the replacement of one of the hydrogen atoms of the alkyl radicle by sodium. It is a fact that when sodium nitro-ethane,  $C_2H_5NaNO_2$ , is dissolved in excess of dilute sulphuric acid at the ordinary temperature, a somewhat vigorous evolution of nitrous oxide occurs. But if the most elementary precautions are taken to prevent the decomposition of so unstable a substance by the thermal change involved in so energetic a reaction, the decomposition proceeds quite differently. If the sodium compound is first dissolved in a little water well cooled by ice, and then an equivalent added of dilute sulphuric acid similarly cooled to near  $0^\circ$ , only a very few bubbles of gas escape, and barely a trace of the odour of aldehyde is perceptible, while a layer of oil, consisting of nitro-ethane, separates out. Even after the operations of purification, which involve some loss owing to the volatility of nitro-ethane, over 60 per cent. of the theoretical quantity of the pure nitro-paraffin was isolated. Moreover, the small quantity of decomposition indicated by the few bubbles of nitrous oxide can be entirely avoided by employing acetic instead of sulphuric acid; the reaction is then less vigorous, and consequently produces at temperatures not far above  $0^\circ$  no dissociation of the nitro-paraffin. The observation of Nef, that the sodium derivatives of the nitro-paraffins are decomposed at the ordinary temperature by the stronger acids, even when diluted, into nitrous oxide and an aldehyde or ketone, is an interesting one; but Prof. Meyer's work now shows that this is due merely to the fact that the nitro-paraffin first regenerated is decomposed in all probability by the heat of the reaction between the sodium and acid, and that when the precaution is taken to prevent this rise of temperature by reacting with ice-cold solutions, the regenerated nitro-paraffin remains intact. Hence it must be concluded that the sodium compounds are true derivatives of the nitro-paraffins which can thus be regenerated from them.

The additions to the Zoological Society's Gardens during the past week include a Vervet Monkey (*Cercopithecus lalandii*, ♀) from South Africa, presented by Captain Scarlett Vale; a Macaque Monkey (*Macacus cynomolgus*, ♂) from India, presented by Miss K. Fleming; a Vulpine Phalanger (*Phalangista vulpina*) from Australia, presented by Mr. Richmond Allen; a Grey Ichneumon (*Herpestes griseus*) from India, presented by Mrs. Lewis; fifteen — Rats (*Mus*, sp. inc.) from Sunday Island, Kermadec Group, presented by the Countess of Glasgow; a Hooded Finch (*Spermestes cucullata*) from West Africa, a Chestnut-eared Finch (*Amadina castanotis*) from Australia, presented by Mr. C. H. Hastings; a Woodcock (*Scolopax rusticola*), British, presented by Mr. Charles Smoothy; a Long-necked Chelodine (*Chelodina longicollis*) from Australia, deposited; four Marbled Newts (*Molge marmorata*), European, purchased.

#### OUR ASTRONOMICAL COLUMN.

**PARTIAL ECLIPSE OF THE SUN, MARCH 26.**—On March 26 a small partial eclipse of the sun will, if the weather be favourable, be seen from all parts of the British Isles, with the probable exception of places which are to the east of a line joining Lowestoft and Hastings. At Greenwich the magnitude of the eclipse, sun's diameter = 1, will be 0.013, and the first contact will occur at 9.55 a.m., with a duration of only 27

minutes. At Oxford the magnitude will be 0.03, and the duration 40 minutes. At Dublin the magnitude will be 0.09, with a duration of 67 minutes, and at Edinburgh 0.08, with a duration of 62 minutes. The eclipsed part will be a maximum (0.36) as seen from the north-east of North America.

In the *Nautical Almanac* for the current year the eclipse is said to be *invisible* at Greenwich, but the error was corrected in the *Almanac* for 1897. The mistake, however, has not been corrected in many of the almanacs in common use.

**DISTRIBUTION OF MINOR PLANETS.**—An interesting diagram has been constructed by General Parmentier, to show the distribution of the minor planets at present known between the orbits of Mars and Jupiter (*Bulletin Soc. Ast. d. France*, March). Of the 390 planets for which sufficient data are available, 93 have a mean distance between 2.16 and 2.48; 152 between 2.52 and 2.82; 128 between 2.85 and 3.25; and 10 between 3.38 and 3.48. The interval between Brucia (at 2.16) and Mars, is occupied by a single asteroid, comparatively recently discovered, with a mean distance of 2.09. On the outer side of the dense swarm, there are only six minor planets in a zone very nearly as wide as that occupied by the group of 383, and extending to a mean distance 4.68. The region of greatest density of the asteroids so far discovered is at a mean distance from the sun very nearly equal to that indicated by Bode's law (2.80); Ceres, Pallas, and Juno fall a little short of this distance.

At the present rapid rate of discovery of minor planets by the photographic method, data will no doubt soon be available to determine if the outer zone between Camilla and Jupiter is really an almost deserted region.

**THE ROYAL OBSERVATORY, EDINBURGH.**—We are glad to hear that the new National Observatory for Scotland is making rapid progress towards completion. The buildings are quite finished so far as the outside is concerned, and it is hoped that the two equatorials and the transit instrument will be erected in the early summer. The library will be ready to receive the magnificent collection of twenty thousand volumes as soon as the heating arrangements are completed.

#### PHYSICAL WORK OF HERMANN VON HELMHOLTZ.<sup>1</sup>

##### II

KÖNIG has shown that in many cases, when two notes are sounded simultaneously, beats are heard, as though the most prominent phenomenon was the production of beats not between the two fundamental notes, but between the upper of these, and the nearest partial of the lower note. Inasmuch as these beats are heard when the lower note (as far as can be tested) is free from upper partials, this rule is not the explanation of the phenomenon, but it is a convenient way of expressing the results. In the experiment just described, the frequencies of the two notes were in the ratio 12 to 15. The first partial of the lower note (12) is therefore the nearest to the higher tone; that is to say, König's beat tone and the first difference tone are identical.

It is easy to arrange an experiment in which these conditions are not fulfilled. Thus let the notes be in the ratio 9:15. The second partial of the lower note is 18, which is nearer to 15 than to 9; hence the König beat-tone would have a relative frequency of  $18-15=3$ . If the siren rotates 10.6 times per second, the frequencies of the two fundamental notes are  $9 \times 10.6 = 96$  and  $15 \times 10.6 = 160$  respectively. As before, the difference tone is 64.

In this case we can use another method of determining the speed of the siren. In 1880 Lord Rayleigh constructed an instrument in which the mass of air enclosed in a tube is excited by resonance, and the fact of the excitation is indicated by a light mirror, which is set where the motion is greatest, inclined at  $45^\circ$  to the direction of the air-currents. In accordance with the general law that a lamina tends to place itself perpendicular to the direction of a stream, the mirror moves when the air vibrates. In the original apparatus the amount of the movement was controlled by magnets. Since that date Prof. Boys has modified the instrument by substituting a quartz thread suspension for a silk fibre, and using the

<sup>1</sup> A discourse delivered at the Royal Institution, by Prof. A. W. Rucker, F.R.S., on Friday, March 8. (Continued from page 475.)

tion of the siren instead of the directing force of the magnets. In a lecture delivered before the British Association, in Leeds, I exhibited the apparatus, which is sometimes called mirror resonator. Prof. Boys has been good enough to make two of these instruments for me, and for reasons, which I will not at present enter into, we decided that one of them should revolve to 160 vibrations per second. It so happens that this coincides almost exactly with the frequency of one of the notes in the experiment under discussion (160). It is thus possible to use the mirror resonator as an auxiliary instrument to test the speed of the siren. When the proper rate is reached the spot of light will move, and if the difference tone is objective the interference bands ought to disappear simultaneously. We tried this experiment several times. An observer, so placed that he could not see the interference bands, held his hand when the spot of light moved. It was quite extraordinary to note the absolute agreement between his movements and the behaviour of the bands.

By throwing the spot of light and the bands near together on the screen, the coincidences can be watched by a number of persons. We have tried whether the difference tone is objective in four cases, and in all have detected it by the disappearance of the interference bands. The details of the experiments are collected in the following table. In the first two experiments the first difference tone is, and in the last two it is not, coincident with König's lower beat note.

*Difference Tones.*

No. of holes in siren.	Interval.	Frequencies.	Difference—and König's beat-tones.
15 and 12	Major third	320 256	64 64
19 " 12	Fourth	256 192	64 64
15 " 9	Major sixth	160 96	64 32
18 " 8	An octave and a major tone	115.2 51.2	64 12.8

Of course the question at once arises, whether, when it can be distinguished separately, König's beat tone is also objective. I do not wish to express a final opinion on this point, but I may say that when the rows of eight and eighteen holes were opened the speed of the siren was increased till the notes corresponding to 256 and 576 vibrations were produced. König's note would in that case have a frequency of  $576 - 2 \times 256 = 64$ . We tried twice to obtain this. On the second occasion, especially, all the conditions were favourable, and the experiment was carried on for a long time. On neither occasion did we obtain the smallest sign of an effect on the fork and interference bands.

We must next turn to the summation tone which Helmholtz discovered. It has been almost universally denied that this note is objective. Without going into details, it is only necessary to remark that the late Mr. Ellis, the translator of the "Tonempfindungen," who took a dispassionate view of the controversy, thought that the position assumed by Helmholtz had been disproved. To the statement of Helmholtz that "it was formerly believed that the combinational tones were purely subjective and were produced in the ear itself," Ellis appended the note: "the result of Mr. Bosanquet's and Prof. Freyer's more recent experiments is to show that they are so."

In an experiment on the summation tone, as the total number of vibrations must not exceed 64, the notes will be too low to be well heard. I shall therefore use a third method of determining the rate of speed of the siren. A mirror attached to the lower plate of the instrument rotates with it. Concentric with, and lying on this, is a circle of paper with eighteen cogs. Light reflected from the mirror passes through holes in two pieces of tinfoil attached to the prongs of a tuning-fork. When the fork is at rest, these holes are superposed; but when the fork vibrates, they move apart, are closed by the tinfoil, and only cross each other twice in each complete vibration. The tuning-fork makes 27.2 vibrations per second, and thus allows the light to pass 54.4 times per second. But when the siren makes 3.048 revolutions per second, the rows of nine and twelve holes give a summation tone of 64 vibrations, and each cog moves over  $18 \times 3.048 = 54.9$ , or say 55 times the distance between two consecutive cogs. If the wheel were viewed 55 times a second, the cogs would appear

stationary, as in that interval each would be replaced by the next. As they are really seen about 54.4 times a second, they appear to move slowly forwards at the rate of about one inter-space in two seconds. When this speed is attained the bands disappear, thus proving the objective existence of the summation tone.

We have repeated this observation in various ways, and always with success. The results are summed up in the table.

*Summation Tones.*

Numbers of holes in siren.	Interval.	Frequencies.	Sum.
10 and 8	Major third	35.5 28.4	64
12 " 9	Fourth	30.57 27.43	64
16 " 9	Minor seventh	40.96 23.04	64

It is, perhaps, a drawback that all the notes in these experiments are very low. In order to remedy this, and also to put the matter to the test by means of another instrument, we have employed a mirror resonator, which responds to 576 vibrations per second.

The rows of 15 and 12 holes being opened, notes of 320 and 256 vibrations were produced. When they were sounded separately, the noise seemed just to make the resonator move. When they were sounded together, the spot of light was driven off the scale, when the upper note coincided with that of a 320-vibration fork, but immediately returned when this pitch was lost.

The summation tone of 576 vibrations was also obtained by two other combinations of holes. The 320-fork was used, and the disturbance occurred in the one case when the pitch of the upper note given by the siren was nearly the same as before, and in the other case when it was about a tone higher.

*Summation Tones.*

Numbers of holes in siren.	Interval.	Frequencies.	Sum.
15 and 12	Major third	320 256	576
16 " 12	Fourth	329.15 246.85	576
16 " 9	Major sixth	360 216	576

I venture to think that these experiments prove the accuracy of von Helmholtz. They show that the siren, at all events, does produce objective tones, the frequencies of which coincide with those of the first difference and summation tones, and that this statement is valid as regards the difference tone, whether it is or is not coincident with König's beat-tone.

I have now in one single case tried to convey to you some idea of the complexity of the problems with which von Helmholtz dealt. He was the first man who detected a relation between the surging mass of partials and combination tones and our sensations of concord and discord. The main facts of his theory are, I believe, generally accepted. On some points modern opinion has tended to stray from his views; one of these we have studied afresh this evening.

It was the fact that I had to deliver this discourse which led me to investigate the question anew, and therefore I felt bound to tell you the results we have at present attained. Had it not been for this, I should not have published them as yet. We have several improvements of the apparatus in view. We do not pretend to have covered the field. I do not, therefore, wish to generalise. My object has been to refute hasty generalisations. I am content if I have convinced you, as I have convinced myself, that Helmholtz was correct in stating that the siren produces objective tones, whose frequencies are equal to the sum and difference of their primaries, and that the methods we have employed have brought to light no facts opposed to his view that these notes cannot be explained as secondary effects of partials, but as phenomena of the first order—in other words, as real combination tones.

But brief space now remains to discuss the vast remainder of his work, and as I have already published an appreciation

of that (*Fortnightly Review*, November 1894), I must content myself with trying to give you, in a few sentences, some idea of the range of his intellect.

His investigations on optics were not less important than those on sound. He invented the ophthalmoscope, by which the oculist can study the inmost recesses of the eye. The theory of colour vision, the theory of binocular vision, the curious subjective effects which are produced when we deliberately deceive our own senses by the stereoscope; these subjects he made especially his own.

In the field of mathematics he was the first to define the peculiar rotatory motion of a liquid known as vortex-motion. Great men had laid the foundations of hydrodynamics before him, but all had overlooked the importance and laws of the vortex. Since the memoir of Helmholtz was published the subject has been widely studied. Lord Kelvin has originated the famous vortex-ring theory of matter; Prof. Fitzgerald has suggested that the ether may be a complex of vortices, or, as it has been called, a vortex-sponge.

On electricity he wrote much—on the theory of the galvanic cell, on electrolysis, on electromagnetism.

In England, at all events, we give the preference, as regards the last subject, to the theory and writings of our own Maxwell.

A lecture, or rather many lectures, might be delivered on each of these topics, but I prefer to devote the few minutes that remain to other subjects.

As I have already said, von Helmholtz, in an age of specialists, was a universal genius. His intellect could light on nothing which it did not illuminate. Hence his opinions on side issues are of more than ordinary importance, his "obiter dicta" are worth attention, his popular lectures acquire a special interest. Let us for a few moments turn to these.

The watchword of Helmholtz in dealing with educational problems is "freedom." Freedom for the student, freedom for the teacher.

In England we are fond of insisting that there are certain things which everybody who aspires to academic rank must know; of hedging in our students by prescribed courses of study. We make them feel that general culture is an iron-bound safe, which they must wrench open before they can attain the gem of real knowledge, rather than a setting, without which the most profound acquirements seem unattractive and dull. Yet von Helmholtz, one of the most highly educated men, one of the most comprehensive geniuses of the latter end of the century, will have no set courses, except as a preparation for a definite profession, is proved that Germany has "retained the old conception of students, as that of young men responsible to themselves, striving after science of their own free will, to whom it is left to arrange their own plan of studies as they think best." Not content with having made the attainment of this ideal almost impossible for English students, doctrinaire educationalists are now beginning to throw their net around the teacher. It is claimed that as the student must go through a prescribed course of study in order to learn, so the teacher must be drilled and examined before he is allowed to teach. Whatever can be said for this plan as regards the less advanced class of teachers, who are to devote themselves to the instruction of children—and in this case I believe there is something to be said for it—is quite opposed to von Helmholtz's view of what is best when the teaching is of university rank, and the students are men and women. Make it easy for whoever has given some proof of knowledge, and wants to teach, to try his hand; make it easy for the student to go to the teacher from whom he gains the most. Look for the best educational results, not necessarily from the best lecturer, but from the man who is in closest contact with his subject. Do not force your teacher on his audience, but do all you can to establish a bond of sympathy between them. Trust, in a word, to the free play of living forces, and not to the hampering restrictions of "necessary subjects" and "compulsory lectures." This is a paraphrase of the views which Helmholtz held, and he illustrated them by the history of this Institution itself.

"I have often," he said, "wondered that the Royal Institution of London, a private society, which provides for its members and others short courses of lectures on the progress of natural science, should have been able to retain permanently the services of men of such scientific importance as Humphry Davy and Faraday. It was no question of great emolument; these men were manifestly attracted by a select public, consisting of men and women of independent mental culture." And then he goes on to show that in a German university the teacher

is attracted to his work, because he has to deal with a body of students, who are capable of forming opinions, and of judging what is best for themselves.

And this leads us to another point. Von Helmholtz insisted that it is useless and dangerous to crowd the universities with students, who are not capable of taking advantage of the opportunities they offer. "The majority of students," he says, "must come to us with a sufficiently logically trained judgment, with a sufficient habit of mental exertion, with a taste sufficiently developed on the best models to be able to discriminate truth from the bubbling appearance of truth. . . . It would be very dangerous for the universities if large numbers of students frequented them, who were less developed in [these] respects. The general self-respect of the students must not be allowed to sink. If that were the case, the dangers of academic freedom would choke its blessings. It must, therefore, not be looked upon as pedantry, or arrogance, if the universities are scrupulous in the admission of students of a different style of education. It would be still more dangerous if, for any extraneous reasons, teachers were introduced into the faculty, who have not the complete qualifications of an independent academic teacher." ("Popular Lectures," vol. ii. 1881, p. 264-5.)

It would be out of place on this occasion to attempt to apply these views to existing circumstances in London; but with the knowledge that the final constitution of a Teaching University for the metropolis may be decided within the next few months, I cannot but feel that London will be happy if it escapes from the fetters which some of its so-called friends are forging for learning; and if, on the other hand, the wise determination of the Gresham Commissioners to include in the university only institutions of university rank, can be maintained against the attacks which will be made upon it.

Lastly, I wish to defend the memory of von Helmholtz from a possible misconception. Those who cultivate art may perhaps look upon him as the poet or the master of style look upon the grammarian, as a mere gerund-grinder, occupied with the study of the dead materials which they alone can use. Of course Helmholtz was not a great artist in the sense that he was a great scientific man, but it would be most unfair to picture him as interested only in the study of laws, and as insensitive to beauty, as occupied with sound and light, but careless as to music and painting. I could quote passage after passage from his works to prove his keen sense of the loveliness as well as of the order of nature, to show the homage that he paid, and the freedom he accorded to art. His object was not to lead art captive to science; but rather to unite them in an alliance of mutual confidence and support.

"The horizons of physics, philosophy, and art have," he said, "been too widely separated, and, as a consequence, the language, the methods, and the aims of any one of these studies presents a certain amount of difficulty for the student of any other of them." To smooth away these difficulties, to bridge over the separating gulf, to supply the common language, were the objects of the life-work of von Helmholtz. It was a noble ideal, nobly pursued, and crowned with as much success as could reward the efforts of one man. It is an ideal akin to that which dominates this Institution, where science, literature, and art are all heard in turns.

If it is possible to sum up in a sentence the teaching of von Helmholtz, and the work of his life, it is that, in spite of the apparent diversities between science and science, between science, philosophy, and art, there is a fundamental unity, and that the future is for those who detect, amid the seeming discords of the schools, the true harmony which underlies and dominates them all.

#### ELECTRIFICATION OF AIR AND OTHER GASES.<sup>1</sup>

§ 1. AT the meeting of the British Association in Oxford in August 1894, a communication was given to Section A, entitled "Preliminary Experiments to find if Subtraction of Water from Air Electrifies it." These experiments were performed during July of 1894, and were a continuation of experiments which were commenced in the Physical Laboratory of the University of Glasgow in December of 1868 with the same object, but which were then, for various reasons, discontinued before any decisive result had been obtained.

<sup>1</sup> A Paper by Lord Kelvin, P. R. S., Magnus Maclean, and Alexander Galt, read at the Royal Society on February 21.

§ 2. A glass U-tube with vertical branches (Fig. 1), each 18 in. long and about 1-inch bore, with the upper 8 inches of one of the branches carefully coated outside and inside with clear shellac varnish, was held fixed by an uninsulated support attached to the upper end of this branch. The other branch was filled with little fragments of pumice soaked in strong sulphuric acid or in water, and a fine platinum wire, with one end touching the pumice, connected it to the insulated circuit of a quadrant electrometer. A metal can, M, large enough to surround both branches of the U-tube without touching either, was placed so as to guard the tube from electric influences of surrounding bodies, the most disturbing of which is liable to be the woollen cloth sleeves of the experimenters or of servers moving in the neighbourhood. This metal can was kept in metallic connection with the outside metal case of the

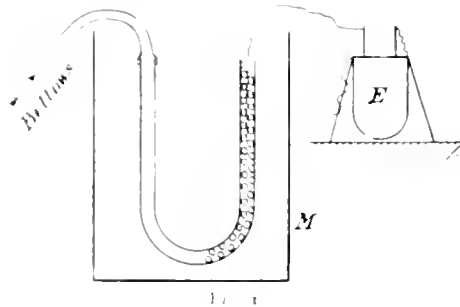

quadrant electrometer. The length of the exposed platinum wire between the U-tube and the electrometer was so short that it did not need a metal screen to guard it against irregular influences. An india rubber tube from an ordinary blow-pipe bellows was connected to the uninsulated end of the U-tube. Air was blown through it steadily for nearly an hour. With the pumice soaked in strong sulphuric acid in the other branch, the electrometer reading rose in the course of three-quarters of an hour to about 9 volts positive. When the pumice was moistened with water, instead of sulphuric acid, no such effect was observed. The result of the first experiment proves decisively that the passage of the air through the U-tube gave positive electricity to the sulphuric acid, and therefore sent away the dried air with negative electricity. A corresponding experiment with fragments of pure chloride of calcium instead of pumice in sulphuric acid, gave a similar result. In repetition

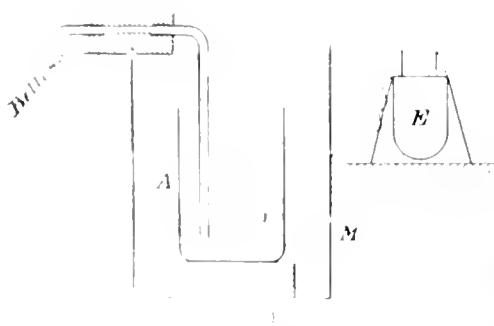

of the experiment, however, it was noticed that the strong positive electrification of the U-tube seemed to commence somewhat suddenly when a gurgling sound—due to the bubbling of air through free liquid, whether sulphuric acid or chloride of calcium solution in the bend of the U-tube—began to be heard. It has since been ascertained that it was because no liquid accumulated in the bottom of the U-tube that no electric effect was found when the pumice was moistened with pure water.

Arrangements were made to prevent any bubbling of air through liquid, by using a straight tube instead of a U-tube. In a large number of experiments with pumice, moistened with pure sulphuric acid in the straight tube, and air blown through for about half an hour, no definite electrification was obtained. In the straight tube, as formerly with the U-tube, pumice moistened with pure water gave no electrification. Chloride of

calcium in lumps, not specially dried, gave no effect in the straight tube; but if previously heated to 180° or 200° and put into the straight tube when still hot, it gave an enormous positive electrification immediately on the commencement of blowing. Strong positive electrification was obtained a second time, by discharging the electrometer to zero, re-insulating, and recommencing the blowing. But after discharging a second time, re-insulating, and re-commencing the blowing, no further electrification was found.

§ 4. In continuation of these experiments on September 25, the arrangement represented in Fig. 2 was set up. The outer metallic guard-vessel, M, was kept connected by a wire to the case, and to one pair of quadrants of a quadrant electrometer, E. The water in the inner glass jar, A, was connected by a platinum wire to the other pair of quadrants of the electrometer.

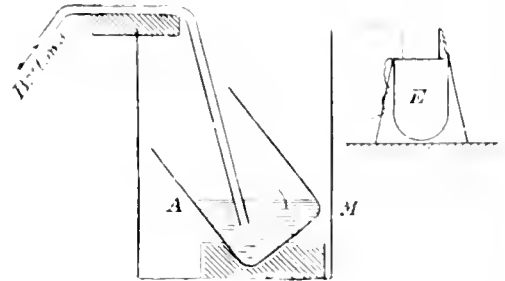

FIG. 3.

To have this inner jar well insulated, it was supported on a block of paraffin; and the other end of the glass tube dipping into the water was fitted into one end of a tube of paraffin, to the other end of which was fitted a tube for ingress of air, from bellows, as shown in the figure. The insulation of this arrangement was found to be good. When air was blown through the water it was found that the jar containing the water became positively electrified.

§ 5. To prevent splashing of water out of the jar, a paper cover was put on its mouth, or the jar was tilted, as shown in Fig. 3, so that the bubbles broke against the inside of the jar. In three experiments thus made, the same electrification was still found, amounting to about 6 volts positive in a quarter of an hour.

§ 6. As the jar was in every experiment positively electrified,

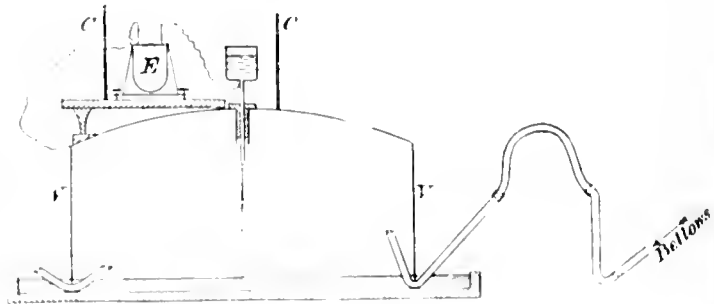

FIG. 4.

the air, if unelectrified when entering it, must have been negatively electrified when leaving it.

§ 7. To test if the air was negatively electrified after bubbling, on October 11 the apparatus shown in Fig. 4 was set up. The apparatus consists of a large sheet iron vat, V V, 125 cm. in diameter and 70 cm. in height, inverted on a large wooden tray lined with lead, and supported by three blocks of wood. By filling the tray with water the air is confined in the vat.

C C is a metal screen kept metallically connected with the

<sup>1</sup> Air was similarly blown from bellows into the vat (see § 7) without any bubbling, and no electrification was observed.

<sup>2</sup> The vat, the water dropper, and the electrometer are the same as in the apparatus described in the *Proceedings of the Royal Society*, vol. 56, year 1894, "Electrification of Air," by Lord Kelvin and Magnus Maclean.

case of the electrometer, and with the vat. It surrounds both the electrometer and the water-dropper, to prevent any external

was found that the water jet gave negative electricity to the ordinary air of the laboratory enclosed in the vat. The present experiments fully confirm this result, showing a gradual negative electrification of the enclosed mass of air rising to about 5 volts in an hour, once every day for the first few days. For twenty-eight days after the vat was set up, in October 1894, fifteen observations of an hour each were taken to find the effect of the water-dropper, with no other disturbing influence on the unchanged volume of air inside the vat. These experiments verify the conclusion (*Phil. Mag.*, August 1890) that the more the air inside the vat became free of dust, the less became the rate at which the air was negatively electrified by the water-dropper.

§ 9. On October 15 last the vat was lifted from the tray to remove some obstruction in the nozzle of the water-dropper, which was not then flowing freely. Curve (6) was obtained that afternoon. The air in the vat was the ordinary air of the laboratory, and the curve shows the effect of the water-dropper alone in electrifying the air negatively. For the next two days the water dropper was kept running continuously for about eight hours each day, to wash the dust out of the air, and on October 18 curve (7) was obtained. It shows a much less rate of negative electrification than curve (6). In the experiments of summer 1890 an aspirator was used to draw the air from the vat, and a tube full of cotton-wool was used to filter the air drawn into the vat.

Curves (1) to (5) are reproduced from the *Philosophical Magazine*, and they show that the more the air becomes free from dust the less is the rate at which the

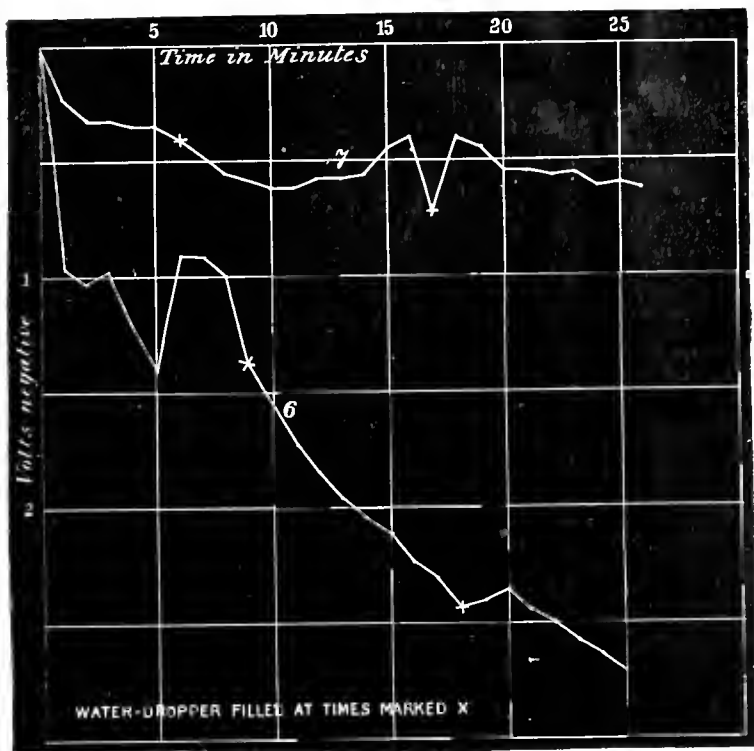

CURVES 1 AND 7

varying electrifications from vitiating the proper results of our experiments.

This screening of the electrometer is absolutely necessary when it is used with high sensibility (70 scale divisions per volt in our experiments) in a laboratory or other place where various other electric experiments may simultaneously be going on. Four years ago the electrometer, the vat, and the water-dropper, were set up on the class-room table without a metal screen. When the deflection indicated about 4 volts negative (see § 8), the negative lead of Lord Kelvin's house electric-light circuit, which passes through the class-room, was joined to earth. This changed the deflection of the electrometer suddenly by 1 volt in the positive direction. When the positive lead was "earthed," the deflection was changed suddenly by 6 volts in the negative direction. Putting on sixteen 8 c.p. electric lamps, eight on each side of the class-room, changed the deflection by two-thirds of a volt in the negative direction.

§ 8. In experimenting with the same apparatus<sup>1</sup> in 1890, it

<sup>1</sup> *Phil. Mag.*, August, 1890, "Electrification of Air by a Water Jet," by Maclean and Goto.

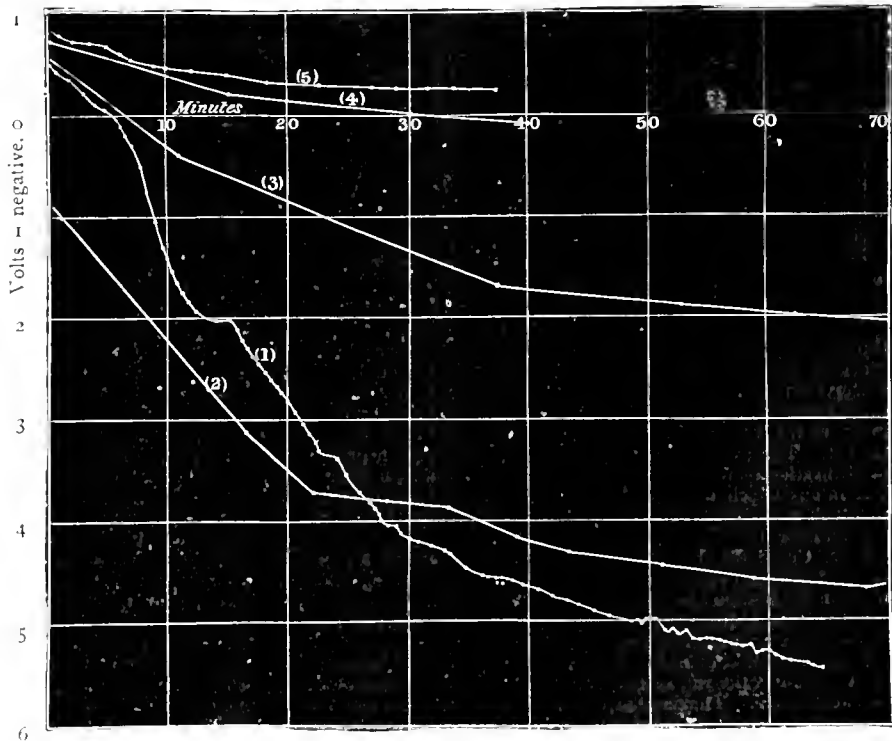

CURVES 1 TO 5

water-dropper electrifies. Thus curve (1) was obtained from the ordinary air of the laboratory in the vat, and curve (2) after the aspirator was working for some time. In this curve the water-dropper itself was running for some time before the first observation was taken. The other curves were obtained after further continuous working of the aspirator.

After curve (4) was obtained the aspirator was worked continuously for twenty-five hours, and then curve (5) was obtained.

§ 10. At the end of twenty-three days of October and November 1894 (§§ 8, 9, above), when the air inside the vat must have been fairly free from dust, and when the water-dropper of itself was giving little negative electrification, we bubbled air into it by a forked tube, one end of which was connected to a bellows, and three other open ends were below the water inside the vat. In five experiments thus made—two on November 7, two on November 8, and one on December 17, an average negative electrification of 5 volts in twelve minutes was obtained.

§ 11. We now arranged a U-tube with pure water in it (Fig. 4) outside the vat. Air from the bellows bubbled

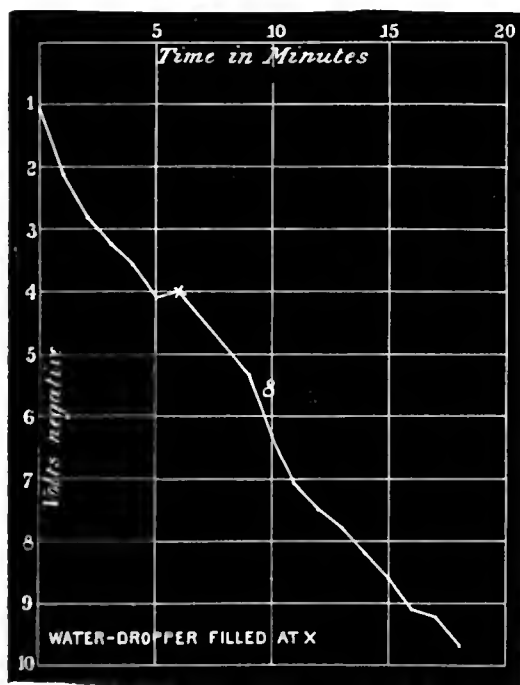

CURVE 8.

through the water in this U, and was carried thence by a block-tin pipe into the vat without any further bubbling. Observations by the quadrant electrometer, while the water-dropper was running and the bellows worked, gave us measurements of the varying state of the electrification of the air in the vat. The average of fifteen experiments gave a negative electrification of the air in the vat of  $8\frac{1}{2}$  volts in 25 minutes. The rate at which the air was blown in in these experiments was such as to displace the entire volume of air in the vat in half an hour.

§ 12. Curve (8) shows the rate of electrification of air, in one of the fifteen experiments, when thus bubbled through the water in the U-tube and then admitted into the vat.

§ 13. Two U-tubes, in series, with water in each, did not seem to give a perceptible cumulative effect.

§ 14. The effect of one or more wire gauze strainers between the U-tube and the vat, or between the U-tube and the bellows, was next tested. The gauzes were placed between short lengths of lead tube, which were held together by a rubber tube slipped over them. The arrangement is shown by longitudinal and cross sections in Fig. 5. Twelve wire gauzes, with or without

cotton-wool between them, placed between the bellows and the U-tube, did not prevent the subsequent electrification by bubbling of the air thus filtered. But when placed between the U-tube and the vat they almost entirely de-electrified the air, even without the cotton-wool, and still more decidedly when cotton-wool was loosely packed between the wire gauzes. A single wire-gauze strainer produced but little of de-electrifying effect.

§ 15. The interpretation of these experiments is complicated, and the time required for each is lengthened, on account of the large mass of air in the vat to start with, whether uncharged or retaining electricity from previous experiments, and also on account of the effect of the water-dropper itself. Hence, in our later experiments, we fell back on the arrangement shown in Fig. 2, by which we test the electrification of the liquid, and not directly that of the gas blown through it.

§ 16. In our first experiment with this apparatus the amount of the electrification did not seem much affected when a paper cover was put on the beaker, or when we tilted the beaker as shown in Fig. 3. We now made a large number of tests with different covers and screens (chiefly of sheet copper or sheet zinc, or brass wire gauze) at different heights above the liquids, and we concluded that, if the screens are not within a centimetre and a half of the liquid surface, they do not directly affect the magnitude of the electrification obtained. In nearly all of the subsequent experiments a horizontal circular screen of thin sheet copper, leaving an air space of about 3 mm. all round between its edge and the inner surface of the jar, about 3 cm. above the liquid surface, was used to prevent spherules of the liquid from being tossed out of the jar by the bubbling.

§ 17. In the following short summary of our results the duration of each experiment was ten minutes. The effect of blowing air through water and other liquids is summarised in §§ 18 to

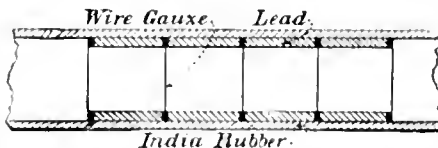

FIG. 5.

27, and of blowing other gases than air through water, in §§ 28 to 31.

§ 18. The jar contained 200 c.c. of the Glasgow town-supply water (from Loch Katrine). A mean of seventeen experiments showed an electrification of the jar to four volts positive when air was blown through it for ten minutes.

§ 19. A solution of zinc sulphate of different strengths was now used instead of the pure water. Three experiments, with 150 c.c. of water containing one drop of a saturated solution of the zinc sulphate, gave half the positive electrification that would, under similar circumstances, have been obtained from water only. With five drops no definite electrification was obtained. With greater proportions of the zinc sulphate solution up to saturation (twenty-four experiments altogether) the electrification was on the average slightly negative.

§ 20. Twelve experiments were then made to test the effect of adding a solution of ammonia to the water. One drop reduced the electrification to one-half; two drops brought it down to one-quarter. With larger proportions of ammonia than this, up to a saturated solution, we found a very slight positive electrification, never amounting to more than a small fraction of a volt, and therefore negligible in the circumstances.

§ 21. Seven experiments with sulphuric acid of different strengths all showed small positive electrification, the amount gradually decreasing from  $\frac{1}{2}$  volt, in ten minutes, with 0.5 per cent. acid in water to  $\frac{1}{10}$  volt, in the same time, with acid of full strength.

Seven experiments with hydrochloric acid solution of different strengths all showed a small negative electrification, the amount gradually increasing from  $\frac{1}{2}$  volt, in ten minutes, with  $\frac{1}{2}$  per cent. acid solution in water to  $1\frac{1}{2}$  volts, in the same time, with acid solution of full strength.

Nine experiments with calcium chloride solution were made. A saturated solution and a solution diluted to 75 per cent. of full strength gave no result; but solutions of gradually diminished strength, from 50 per cent. down to  $\frac{1}{10}$  per cent.,



showed a negative electrification from fully  $\frac{1}{2}$  volt, in ten minutes, down to  $\frac{1}{10}$  volt.

Additions of very small quantities of washing soda to water greatly reduce the positive electrification obtained.

Loch Katrine water, supersaturated with carbonic acid, and placed in the insulated jar, showed, when air was bubbled through it for ten minutes, a negative electrification of  $\frac{1}{4}$  volt.

§ 22. Ten drops of paraffin oil added to water reduced the electrification to about half of that obtained from water only. Thirty drops reduced it to about a tenth, which, as it amounted to only 0.4 volt during the time of the experiment is negligible.

§ 23. Ten drops of benzene reduced the electrification to half, and thirty drops to about a third of that taken by pure water.

§ 24. A saturated solution of granulated phenol (carbolic acid) was made, and small portions of it added to the water in the jar. Several experiments showed no diminution in the electrification as long as the quantity of the phenol solution present in the water was under 10 per cent. With 25 per cent. the electrification was reduced to a third. With strengths greater than this up to saturation the electrification was reduced to one-sixth.

§ 25. A saturated solution of common salt was prepared. Blowing air through 200 c.c. of water containing the quantities of the salt solution mentioned, gave us in ten minutes the following electrifications:—

Per cent. of saturated solution of salt in water.	Volts positive.
(a) 0.004	2.4
(b) 0.02	1.2
(c) 0.1	0.6
(d) 0.5	0.4
(e) 2.0	0.15
(f) 4.0	0.0

§ 26. Several experiments showed that with 200 c.c. of water containing not more than ten drops of absolute alcohol, practically the same amount of positive electrification (4 volts in ten minutes) is obtained as if pure water were used. With fifty drops less than 2 volts were got, and with 100 drops less than 1 volt. 25 and 50 per cent. alcohol in the water gave very small and hence negligible positive electrification.

§ 27. One drop of saturated solution of copper sulphate in 200 c.c. of water showed one volt positive in ten minutes. With  $\frac{1}{2}$  per cent. of it in the water, the electrification was reduced to a fraction of a volt positive. With greater proportions of copper sulphate present, up to saturation, slightly negative electrifications were obtained, but never amounting to more than about one-tenth of a volt, and hence negligible.

§ 28. On blowing carbonic acid gas from a cylinder obtained from the Scotch and Irish Oxygen Company, through pure water in the glass jar, the water became electrified to  $\frac{3}{4}$  volts positive in ten minutes. Blowing the breath through water gave an electrification of 3 volts positive in the same time: this diminished result is doubtless due chiefly to the diminished rate of bubbling.

§ 29. The blowing of oxygen from a cylinder, obtained from the Oxygen Company, through water, gave as a mean of four experiments a positive electrification to the water of half a volt in ten minutes. When continued for fifty-five minutes, it gave the very decided result of 5 volts positive.

§ 30. Hydrogen prepared from zinc and dilute sulphuric acid was passed into a large metal gas-holder; and was passed on from this to bubble through the water in the insulated jar. In two experiments this was done immediately after the preparation of the hydrogen; in another it was done after the hydrogen had remained eighteen hours in the gas-holder. In each of the three experiments the water was electrified to 2 volts positive in ten minutes.

When the hydrogen was allowed to pass direct through a tube from the Wolfe's bottle where it was generated, to bubble in the insulated jar, the magnitude of the effect obtained was very much larger. In one case a mixture of muriatic acid and sulphuric acid and water was used, and the reading went off the scale positive in thirty seconds (more than 10 volts). In other two experiments with dilute sulphuric acid and zinc in the Wolfe's bottle, the electrifications obtained were 6 volts positive in seven minutes, and 7.3 volts positive in thirteen minutes, in the last of which the hydrogen was allowed to bubble through

caustic potash contained in a small bottle between the Wolfe's bottle and the insulated jar.

The hydrogen was next generated in the insulated jar itself, the tube for ingress of air used in the ordinary experiments being taken away. 200 c.c. of pure water, along with some granulated zinc, was put into the jar. Then some pure sulphuric acid was added, and electrometer readings were taken. In two experiments with no screen in the jar (§ 16) the reading went off the scale *negative* (1) in two minutes and (2) in four minutes (more than 9 volts in each case). In another experiment in other respects the same, but with a copper screen 7 cm. above the surface of the liquid, the electrification showed 2 volts *negative* in two minutes, then came back to zero in five minutes, and in the next six minutes went 4 volts *positive*. The jar and pair of quadrants connected with it were then metallically connected with the outer case of the electrometer for a few seconds, and reinsulated; in five minutes the reading went up to 2 volts *positive*. A little more sulphuric acid was added to the jar, which was disinsulated for a short time and reinsulated; the reading went up to 7 volts *positive* in four minutes. The jar was again disinsulated for a few seconds and reinsulated; the reading went up in four and a half minutes to  $6\frac{1}{2}$  volts *positive*.

§ 31. Coal-gas, bubbled through water in the insulated jar, gave 1.4 volts positive in ten minutes.

§ 32. In the ordinary experiment of bubbling air through a small quantity of water in the bottom of the jar it was noticed that the electrification did not commence to be perceptible generally till about the end of the first minute; and that it went on augmenting perceptibly for a minute or more after the bubbling was stopped. The following experiment was therefore tried several times. One of us stood leaning over the jar, with the head about 10 inches above it, and the mouth so partly closed that breathing was effected sideways; another blew the bellows, and another took the readings of the electrometer. After bubbling had been going on for some minutes, and the readings were rising gradually (4 volts per ten minutes, as in § 18), blowing was stopped. As soon as the bubbling ceased, the first-mentioned observer, without moving his head or his body (see § 7, regarding the necessity to have the electrometer screened from outside influences), blew into the jar to displace the negatively electrified air in it. In every case the electrometer reading showed instantly a small rise in the positive direction.

In the carrying out of these experiments we have received much valuable help from Mr. Walter Stewart and Mr. Patrick Hamilton.

§ 33. The very interesting experiments described by Lenard, in his paper on the Electricity of Waterfalls (*Wiedemann's Annalen*, 1892, vol. 46, pp. 584-636), and by Prof. J. J. Thomson, on the Electricity of Drops (*Phil. Mag.*, April 1894, vol. 37, pp. 341-358), show phenomena depending, no doubt, on the properties of matter, to which we must look for explanation of the electrical effects of bubbling described in our present communication, and of the electrification of air by drops of water falling through it, to which we have referred as having been found in previous experiments which were commenced in 1890 for the investigation of the passage of electrified air through tubes.<sup>1</sup>

### UNIVERSITY AND EDUCATIONAL INTELLIGENCE.

CAMBRIDGE.—The Isaac Newton Studentship in Astronomy has been awarded to Mr. S. S. Hough, Scholar of St. John's College, Third Wrangler in 1892, and Smith's Prizeman in 1894.

Mr. C. T. Heycock, Lecturer in Chemistry at King's College, First Class in the Natural Sciences Tripos 1889 has been elected to a Fellowship.

The discussion by the Senate of the proposals for the encouragement of Advanced Study and Research, by the admission under special conditions of Graduates of other Universities, was on the whole favourable to the scheme. There seems little doubt that the preliminary resolutions on the subject will be passed early next term.

Mr. Arthur R. Hinks, of Trinity College, has been appointed Second Assistant at the Observatory for five years, from July 1, 1895.

<sup>1</sup> "Electrification of Air by a Water Jet." By Magnus Maclean and Makita Goto, *Phil. Mag.*, August 1890, vol. 3, pp. 147-152.

SIR JOHN I. has been elected President of the Land Society for the Extension of University Teaching, in succession to M. G. Schen, M.P., resigned.

MR. GEORGE K. REDGRAVE has been appointed Chief Senior Inspector of Schools and Classes under the Science and Art Department, and Mr. T. B. Shaw, Inspector of the North-Western District, has been promoted to a Senior Inspectorship.

### SCIENTIFIC SERIALS.

We have received two recently issued parts of the *Journal of the Asiatic Society of Bengal* (vol. lxxiii. part ii. Nos. 1 and 2) containing, *inter alia*, an important paper by Mr. Lionel de Nicville, the author of the admirable book on the butterflies of India, Ceylon, and Burma, now approaching completion, on new and little-known butterflies from the Indo-Malayan region, illustrated by five excellent coloured plates, representing species belonging to most of the principal families represented in the district. Among the species figured is a handsome new species of *Stictophtalma* (*S. sparta*) from Manipur, allied to the well-known Chinese *S. karyua*, of Westwood, belonging to a genus allied to the great blue Morphos of South America, and not inferior to some of them in size; a gynandromorphous specimen of the common, but very remarkable, Indian Fritillary, *Argynnis nife*, L., the female of which mimics the abundant, highly-protected, and much-imitated *Danais chryseippus*, L.; several species of *Laxita*, Butler, a beautiful genus allied to our Duke of Burgundy Fritillary, but much larger, and with rounded brown wings, generally suffused with crimson on the fore wings, and marked with metallic blue spots beneath; three species of *Papilio*, two of which mimic species of the widely-removed sub-family *Euplaina*; and many other interesting species. Several genera, as well as a large number of species, are described as new, and much fresh information is given relative to species already known. Several very useful lists and tables are also included in the paper, relative to the species of *Daphila*, allied to *D. teuta*, Doubleday and Hewitson, and those of the genera *Gerydus*, Boisduval, *Logania*, Distant, &c. When we look at the number of important books and papers that are now constantly issuing from the press on the butterflies of various parts of the British East Indies, it seems strange to remember that thirty years ago almost nothing had been published specially on the subject, except Horsfield and Moore's Catalogue of the Lepidoptera in the East India Company's Museum, and Westwood's "Cabinet of Oriental Entomology."

*Memoir (Trudy) of the St. Petersburg Society of Naturalists*, vol. xxiv. part 1, Zoology and Physiology.—Notes on birds found in the Melior Mountains of Podolia, by I. D. Mikhailovsky. Seventy-two species are mentioned.—On the structures and reactions of the cells of the digestive tube of the pupæ of *Musca Cesariæ vomitoria*, by N. Kholin, with one plate. The Natural History Museum of Great Britain, and other zoological institutions of West Europe, by A. Yashchenko.—Report on the cruise of the *Narydnik* in the Arctic Ocean in 1893, by N. Knipovitch. Leaving Reval, the cruise visited the Murman coast, the Dvina and Onega bays of the White Sea, and the west coast of Novaya Zemlya, entering the Matohkin Strait and the Yugorskiy Shar. No less than eighty successful dredgings, down to depths of 100 fathoms, as well as measurements of temperature, were made. The author's remarks on the differences of colour and density of the blue Gulf Stream water, which is easily traced along the Murman coast, and the more so along the coast of Novaya Zemlya, are especially interesting. The colour and the density better delineate the south-east limits of the Gulf Stream current than the differences of temperature which are affected in both the Gulf Stream and the cold current by various local causes. In the bay of the White Sea, M. Knipovitch found in the bottom mud, which has temperature of one or two degrees below zero, the *Polyarctica*, characteristic and known of the Glacial period deposits and the Arctic Sea; while the same has never been found in the Arctic Ocean off the Murman coast, nor in the eastern parts of the Barents' Sea. Report on the zoological collection of West Europe, by Prof. K. Saint-Hilaire.—In the *Proceedings* we notice a very interesting report, by A. A. Linnæus, on the part played by the phagocytes in the sexual

processes with the *Galeodes*, and A. K. Trotsin's report on his zoological journey to the Transcasian region and Russian Turkestan.

THE *Meteorologische Zeitschrift* for January contains a careful discussion of the rainfall of the Sandwich Islands, by Dr. J. Hann, based chiefly on observations supplied by the Director of the Weather Service at Honolulu. The amount of the rainfall is subject to great fluctuations. At Hilea, Kau (on the south side of Hawaii), 44.5 inches fell in 1886, and of this amount 51 per cent. fell in November. In 1889 the annual fall was only 13.9 inches, or about half as much as in November 1886. At Honolulu the average annual fall is 40 inches. The heaviest falls occur on the windward side of the largest of the islands, that is, on the north-east of Hawaii, and the smallest falls occur on the southern part of Oahu, and the south-west of Maui. The wettest period in almost all the islands is from November to March. The principal exception to this is on the leeward side of the mountains of Hawaii, where more rain falls in summer than in winter.

### SOCIETIES AND ACADEMIES.

#### LONDON

Physical Society, March 8.—Mr. Walter Baily, Vice-President, in the chair.—Mr. Naber exhibited, and shortly described, a new form of gas voltmeter. The chief advantages claimed for this instrument are that either the oxygen or the hydrogen can be collected separately, and that the level of the liquid inside and outside the burette can be made the same; thus no correction has to be applied to the volume of the gas on this account. Variations in the temperature and barometric pressure are allowed for by reading an air thermometer which is fixed alongside the burette. The inventor considers that this instrument will compare favourably in accuracy with the copper and silver voltmeters now in general use. Prof. S. P. Thompson considered that now so much care had been bestowed on the design of a gas voltmeter, this instrument might come into more general use than heretofore.—Dr. Johnstone Stoney, F.R.S., exhibited (1) the local heliostat, (2) an improvement in siderostats. By a local heliostat the author means one which can only be used in places the latitudes of which differ slightly from that of the place for which the instrument was specially constructed. The limits within which the instrument works with sufficient accuracy for ordinary spectroscopic work, are such that one instrument can be used in any place in the British Isles. The heliostat exhibited was a modification of one previously described by the author, which is now in very general use, and it is capable of sending a reflected ray in any direction in, or nearly in, a horizontal plane. In the new instrument the pendulum clock previously used to supply the motive power, is replaced by a balance-wheel clock; this change decreases the cost of the instrument, while it adds to its portability. A tangent screw, worked by a long rod, supplies a slow motion for adjusting the position of the reflected beam, and is of use when examining the spectra of the solar prominences, &c. The instrument is adjusted in the meridian by means of a gnomon and horizontal divided circle which form a sun-dial. This divided circle is so arranged that it is always horizontal when the polar axis is in adjustment, and can therefore be used whatever the latitude of the station at which the observations are being made. In connection with the use of a heliostat in conjunction with a spectroscope, the author recommends, when using a grating, the introduction of a large glass prism between the heliostat and the slit of the spectrometer. An impure spectrum is thus formed on the slit, and by moving the slit to the part of this spectrum corresponding to light of the wavelength under observation, the difficulties due to the overlapping of the spectra may in a great measure be overcome. After mentioning that the great difficulty in designing a siderostat which should work with "astronomical accuracy," is to get a form of sliding motion quite free from back-lash, and which will move perfectly regularly, Dr. Stoney exhibited a model of a form of mechanism for obtaining such a motion which he had devised. The principle on which the instrument depends is that, if you have a point fixed to a circle which rolls on the inside of another circle of double the diameter, this point will describe a straight line. The smaller disc does not, in the model exhibited, roll directly on the larger

disc, but an idle wheel is introduced which rolls on the *outside* of both the discs. Slip is avoided by placing steel bands between the idle wheel and the discs, one end of each of the two bands being fixed to the circumference of the idle wheel, while the other ends are fixed, one to the circumference of each of the discs. Back-lash is prevented by means of a spiral spring attached to a point on the smaller disc; this point being so chosen that it moves nearly perpendicular to the direction in which the spring acts. Hence the spring is always stretched to nearly the same amount, and no extra strain is brought to bear on the driving-clock in different positions of the instrument. Prof. S. P. Thompson considered that the best method to employ when using sunlight was to incline the telescope, &c., parallel to the polar axis, under which circumstance the mirror of the heliostat need only rotate about a vertical axis.—A paper, on a simple form of harmonic analyser, was read by Mr. G. U. Yule. At a former meeting of the Society, Prof. Henrici showed a form of analyser in which the paper on which the curve is traced was given a to-and-fro movement, a planimeter being used as an integrator. The author being struck with the advantages of the use of a planimeter, both as regards cheapness and simplicity, has devised another form of analyser in which a planimeter is used. The principle on which this instrument works is as follows:—Suppose we have a straight line (X X) which can move parallel to the base line of the given curve, so that every point in this line describes a perpendicular to the base; further, suppose that a disc, the circumference of which is some aliquot part of the base of the curve, say  $2l/n$  where  $2l$  is the base length, is capable of rolling on the line (X X) without slip. If the centre of the disc is brought over the initial point of the curve, and any point (D) at a distance  $r$  from the centre on a horizontal diameter is marked, then if the centre of the disc is made to describe the curve which is to be analysed, the area of the curve described by the point D is given by the equation

$$R_1 = a + \cos n\pi \frac{r n \pi}{l} \int_{-l}^{+l} y \sin n\theta dx,$$

where  $a$  is the area of the curve to be analysed. Similarly, if the point D is taken originally on a vertical diameter, the area of the curve traced out is

$$R_2 = a + \cos n\pi \frac{r n \pi}{l} \int_{-l}^{+l} y \cos n\theta dx.$$

In any practical case it is convenient to take  $r$  some multiple of  $l/\pi$  units of length, say,  $10$ , then the above equations become

$$R_1 = a + \cos n\pi \cdot 10n \cdot B_n$$

and

$$R_2 = a + \cos n\pi \cdot 10n \cdot A_n$$

where  $B_n$  and  $A_n$  are the coefficients of  $\sin n\theta$  and  $\cos n\theta$  in the Fourier series expressing the equation to the curve. The areas of the curves traced out by the point D ( $R_1$  and  $R_2$ ) are obtained by allowing the tracing-point on an Amsler planimeter to rest in a small conical hole at D. The line X X is the edge of a rolling parallel ruler which has a rack cut along it. A series of toothed wheels give the coefficients of the different terms in the series. In the instrument exhibited there were wheels to give the first four terms, but the author said it was possible to work with wheels which gave the sixth term. The above analyser was the outcome of a simple step-by-step integrator which the author had devised. In this case the base line of the curve having been divided into a number of equal parts, then, by means of a scale of sines attached to the instrument, the tracing-point of a planimeter is set at a point whose abscissa is  $\sin n\theta$ , while it is moved parallel to the axis of  $y$  through a distance  $\delta y$  corresponding to one of the elements into which the base was divided. Prof. Henrici said he had at one time considered the question of constructing an analyser which should employ a planimeter as the integrator, and he was particularly pleased with the instruments exhibited. Since the area required was the difference between the area of the original curve, which is traced out by the centre of the disc (K), and the curve traced out by the point D, and since this area is really the area swept out by the straight line K D, if we attach an integrating wheel to the disc, with its axle parallel to K D, the required area can be directly obtained from the reading on this wheel. In addition, if a second integrating wheel were fixed to the disc, with its axle perpendicular to K D, the coefficients of  $\cos n\theta$  and  $\sin n\theta$  could both be obtained by going round the curve once. The instrument devised by Mr. Yule was practically

the inverse of one he (Prof. Henrici) had invented. Dr. Burton pointed out some incorrect signs in the proof given; these, however, do not affect the final expressions obtained. Mr. Inwards suggested that errors due to back-lash might be avoided by using either a double wheel or a double rack, so that by means of a spring each side of the teeth which were engaged might be in contact at the same time.—Prof. Minchin gave a short account of a paper by Mr. H. N. Allen, entitled "The Energy Movements in the Medium Separating Electrified or Gravitating Particles." The object of the paper is to trace out the equipotential surfaces and lines of flow for two electrified points or gravitating particles, and then to consider the paths along which the "energy cells" move when the charged points or gravitating particles either move towards or away from one another. By energy cell the author understands the small volume of the dielectric bounded by the walls of a tube of force, and by two neighbouring equipotential surfaces, which can be looked upon as containing a certain definite amount of energy. The author gives two figures showing the paths of the energy cells: (1) when the charged particles come together and meet; (2) when they separate and move off to infinity in opposite directions. Using Maxwell's expression for the pressure along the lines of force, and the equal tension at right angles required by his theory to account for the attraction exerted by the sun on the earth, the author has calculated the energy density in the medium at the surface of the sun. The value obtained is 16-horse power-hours per c.c. Hence he concludes that, at a distance from all gravitating bodies, a c.c. of ether contains at least this amount of energy. Prof. Minchin showed how, by the use of polar coordinates the expressions given by the author could be simplified. He also gave a graphical method of obtaining the equipotential surfaces for any configuration having given those for any other configuration. He pointed out that by a similar line of reasoning to that used by the author, the energy per c.c. of the medium at the surface of Arcturus must be 8000 times as great as at the surface of the sun, so that the minor limit given above by the author must be multiplied by 8000 at least.

Entomological Society, March 6.—Prof. Raphael Meldola, F.R.S., President, in the chair.—Mr. B. G. Nevins exhibited a long series of *Heliothis peltigera*. He stated that the specimens were bred from larvæ found on the Dorsetshire coast during July 1894, feeding on the flowers of *Ononis arvensis*, which were extremely luxuriant. A few also were taken on *Hyoscyamus niger*. He added, that all the larvæ went down by the end of July. The first emergence took place on August 20, and they continued coming out at the rate of about five a day, through the rest of that month and September; only five emerged in October, and the last one appeared on November 11. Mr. G. T. Bethune-Baker, Mr. Eustace Bankes, Mr. B. A. Bower, the Rev. Seymour St. John, and Mr. H. Goss made remarks on the habits and distribution of the species in England.—Mr. Bower exhibited a variable series of *Scoparia basistrigalis*, Knaggs, showing light, intermediate and dark forms, taken at Bexley, Kent, from June 12 to July 7, 1891-94. He said the species appeared to be poorly represented in collections, and when present was almost invariably misnamed. Mr. Bankes commented on the rarity of the species, and said the specimens exhibited formed the most interesting collection of it and its varieties which he had ever seen.—Lord Walsingham, F.R.S., exhibited larvæ of *Pronuba yuccasella*, which he received more than four years ago from Colorado, and which were still living. One specimen of the moth had emerged two years ago.—Mr. Goss exhibited, for Mr. G. C. Bignell, a pupa of a Tortrix, with the larval legs, and also a specimen of a Sawfly, *Emplytus cinctus*, L., with eight legs. Mr. G. H. Verrall and Mr. McLachlan made some remarks on the latter species, and as to the insertion of the fourth pair of legs.—Prof. Meldola exhibited a wooden bowl from West Africa, from which, after arrival in this country, a number of beetles (*Dermestes vulpinus*) had emerged. Specimens of the latter were also exhibited. It was not clear to the exhibitor whether the larvæ had fed upon the wood, or had simply excavated the cavities which were apparent in the interior of the bowl for the purpose of pupating. Mr. McLachlan, Mr. J. J. Walker, Herr Jacoby, and Lord Walsingham made some remarks on the habits of Dermestes.—Mr. Champion read a paper entitled "On the Heteromeres Coleoptera collected in Australia and Tasmania by Mr. J. J. Walker, R.N., during the voyage of H.M.S. *Penguin*, with descriptions of new genera and species.

Part II.—Mr. Walker and Mr. Gahan make some observations on the determination of certain of the species described.—Mr. Kirby Freeman, F.R.S., contributed a paper entitled "On some new species of butterflies from tropical and extra-tropical South America."—Mr. G. A. James Rodney contributed a paper entitled "Notes on Indian Ants," and sent for exhibition a number of specimens in illustration of the paper, together with nests of certain species.

**Geological Society, February 20.**—Dr. Henry Woodward, F.R.S., President, in the chair.—The President announced to the Fellows the grievous loss which the Society had suffered in the decease of its Foreign Secretary, Mr. J. W. Hulke, F.R.S., President of the Royal College of Surgeons. He dwelt on the great value of Mr. Hulke's work in vertebrate paleontology, on his long services as a member of Council and an officer of the Society, and on his amiable personal qualities, which had endeared him to a wide circle of friends. He read the following resolution which the Council had that afternoon unanimously voted, and communicated to Mrs. Hulke with the expression of their heartfelt sympathy: "That this Council most deeply deplore the sad loss that the Society and all those interested in paleontology have sustained by the untimely decease of our Foreign Secretary, Mr. J. W. Hulke, F.R.S., whose investigations in various branches of science have led to such valuable results."—Contributions to the paleontology and physical geology of the West Indies, by Dr. J. W. Gregory. The earlier part of the paper was largely concerned with the corals of the fringed reefs of Barbados, and, on account of the confusion in the synonymy of the West Indian corals, the synonymy of the species was given in some detail. A list of the mollusca of the low-level reefs followed. In discussing the age of the Barbados rocks, the author stated that the following was the sequence (in descending order):—

	Low level: Pleistocene.	
Raised coral reefs	High level: Pliocene.	
Oceanic series ...	<i>Archæonites</i> - <i>ab-</i> <i>rupis</i> -limestone,	Miocene (and possibly partly Pliocene) and partly Oligocene.
Scotland beds ...	Ethiassic marls.	
	Oligocene (probably Lower).	

—The Whitehaven sandstone series, by J. D. Kendall. The Whitehaven sandstone, with its associated shales, is a purple-grey deposit sometimes having a thickness of 500 or 600 feet. The author gave details of a large number of sections of the series, which also contains thin coal-seams and occasionally *sporadic* limestone.—Notes on the genus *Murchisonia* and its allies, with a revision of the British carboniferous species, and descriptions of some new forms, by Miss J. Donald.

**Zoological Society, March 5.**—Sir W. H. Flower, K.C.B., F.R.S., President, in the chair.—The Secretary read a report on the additions that had been made to the Society's menagerie during the month of February, and called special attention to a fine female giraffe recently arrived from South Africa. This was believed to be the first example of the large, dark-blotched race ever seen alive in Europe; the giraffes previously exhibited having belonged to the smaller and paler form found in Northern Tropical Africa. The Society has also purchased a pair of Sabine Antelopes (*Hippotragus niger*) and a pair of Brindbill Gnu (*Cornuiceros taurinus*), all in excellent condition.—Dr. S. George Mivart, F.R.S., read a paper on some distinctive structural characters in the hyoid bone in certain parrots.—Mr. A. D. Michard read a paper on a new Freshwater Mite found in Cornwall, and belonging to the genus *Lhyra*, of which only two species were previously known. It is proposed to call it *Lhyra troglodytes*.—Mr. G. A. Boulenger, F.R.S., read a paper "on the living habits of two South-American Frogs," and exhibited a specimen of *Hyalinobatrachium* with eggs on the back. He also made remarks on a male specimen of *Phyllotates trinitatis* from Venezuela, carrying its tadpoles on its back, in the same way as had previously been observed in frogs of the genus *Dendrobates* from Surinam and Brazil.

**Royal Meteorological Society, February 20.**—Mr. R. Ingham, President, in the chair.—Mr. W. Merritt gave an account of the thunder storm and squall which burst over London on suddenly on the morning of January 23. It appears

that this storm passed across England in a south-south-easterly direction at the rate of about forty-seven miles an hour, being over Northumberland at 4 a.m., and reaching the English Channel by 11 a.m. Thunder was first heard in the vicinity of Leeds, and accompanied the storm in its progress across the country. One of the most remarkable features of the storm was the sudden increase in the force of the wind, for in London it rose almost at one bound from nearly a calm to a velocity of thirty-six miles an hour. This sudden increase of wind caused considerable damage, and at Bramley, near Guilford, twenty-eight trees were blown down along a track 1860 yards in length.—Mr. E. Mawley presented his report on the phenological observations for 1894. Between the third week in March and the third week in May plants generally came into blossom in advance of their usual time, and towards the end of April the dates of first flowering differed but little from those recorded at the same period in the very forward spring of 1893. The cuckoo made its appearance even earlier than in the previous year. The year 1894 was a very productive one, and both the hay and corn crops proved unusually heavy, but much of the latter was harvested under very trying conditions as regards weather. The frosts of May 21 and 22 entirely destroyed the previous prospect of a glorious fruit season. Indeed, the only really good crop was that of pears, which were singularly abundant throughout nearly the whole of England.—Mr. A. B. MacBollard read a paper on some gradual weather changes in certain months at Greenwich and Geneva.

## DUBLIN.

**Royal Dublin Society, November 21, 1894.**—Prof. W. J. Sollas, F.R.S., in the chair.—The following papers were read: On the occurrence of seiches in Lake Derravaragh, co. Westmeath, by Staff-Commander J. R. H. MacFarlane, R.N. This paper (communicated by Prof. D. J. Cunningham, F.R.S.) is interesting as being the first record of observations, from the United Kingdom, of these phenomenal changes of the level of the water in lakes. These singular rhythmic movements, somewhat resembling tidal ebb and flow, were found occurring in the Swiss lakes towards the close of the last, and beginning of the present, century, and many skilful observers devoted considerable time in the endeavour to elucidate the cause or causes; but, as yet, no distinct explanation has been given, although it would appear to have been generally noticed that they are accompanied by a low barometer. It also appears that the characteristics of the land, surrounding the observation spot, influence the time occupied by a complete rise and fall of the water, which has been termed the *duration of the seiche*; and, further, that it is probable such durations are constant for each observation spot, but the *amplitude*, or amount of rise above, and fall below the level, will depend on the amount of influence exercised in causing the seiche; this influence being at present unknown. The observations made at Lake Derravaragh were necessarily confined to one spot, no other observers being available for synchronous observations at different stations. The maximum amplitude recorded was 5.8 inches, and the duration of seiche, fairly constant, about 39 minutes.—A paper was communicated by Sir Charles Cameron, on the effect of poisons and antiseptics on germination, by Mr. F. H. Perry Coste.—The Rev. K. Bodkin described an "automatic image-finder," the object of which is (1) to show where the image of any object placed before any lens must be formed; (2) to prove that the image is found there; (3) to help to explain the construction of the various optical instruments in use such as the microscope, telescope, camera, and projection lamp.—December 19.—Sir Howard Grubb, F.R.S., Vice-President, in the chair.—The following papers were read: Mr. John R. Wigham described and demonstrated a method of increasing the power of continuous lighthouse lights.—Prof. W. J. Sollas, F.R.S., gave a description of a new fossil, resembling annelid tubes, from the Cambrian of Puck's Rocks, Howth, near Dublin. Upon this fossil the author has bestowed the name *Puckia Ma. Henryi*.

## PARIS.

**Academy of Sciences, March 11.**—M. Marey in the chair.—On argon, by M. Berthelot. The author announces the combination of the new element with benzene vapour under the influence of the electric discharge, and promises details to follow.—Remarks on the curves defined by a differential equation of the first order, by M. Emile Picard.—On the total

eclipse of the moon of March 11, by M. J. Janssen. The importance of observations of lunar eclipses by photographic photometry in connection with the constitution of the higher regions of our atmosphere is emphasised.—On the losses of nitrogen carried off by infiltrated water, by M. Schloësing. The loss of nitrogen by soils in the basin of the Seine through the elimination of nitric acid in drainage waters is discussed. In conclusion the author believes such losses not to be very important; they are roughly proportional to the richness of the soil in organic matter, and do not much impoverish already poor soils.—Analysis of oyster-shells, by MM. A. Chatin and A. Muntz.—Demonstration of a theorem of whole numbers, by M. de Jonquières. If  $a_1, a_2, a_3, \dots, a_n$  are  $n$  different whole numbers, the product  $\Pi(a)$  of all these numbers, multiplied by the product  $\Pi(a_i - a_j)$  of their differences by twos, is a multiple  $\lambda$  of the product of  $n$  first numbers  $1, 2, 3, \dots, n$ , multiplied by the product of their differences by twos, that is to say, is equal to  $\lambda(1^2 \cdot 2^2 \cdot 3^2 \cdot \dots \cdot n^2 \cdot 1^2 \cdot 2^2 \cdot \dots \cdot n^2)$ .—Observations of Wolf's planet BP (23 February, 1895) made with the great equatorial of Bordeaux Observatory, by MM. G. Rayet and L. Picart, noted by M. G. Rayet.—Volumes of salts in their aqueous solutions, by M. Lecoq de Boisbaudran.—On M. Darboux' method for the integration of equations to the derived partials of the second order, by M. E. Goursat.—On certain algebraical groups, by M. E. Cartan.—On "fonctions entières," by M. H. Desaint. The "fonctions entières" of the type 0, 1 or 2, of which the exponential multiplier of the infinite product of primary factors of M. Weierstrass is of the form  $Ae^{\alpha x^2 + \beta x + \gamma}$ , where  $A$  is a constant,  $\alpha$  and  $\beta$  real and  $\alpha$  positive, possess the property that, if their zeros are real, the zeros of their derivatives are also real.—On the direct measurement of the mean spherical luminous intensity of sources of light, by M. A. Blondel. A description of the instrument termed a *lumen-mètre* and its use.—On the analysis of silicon, by M. Vigouroux.—Action of formaldehyde on ammoniacal salts, by MM. A. Brochet and R. Cambier. The first action of ammonium chloride on formaldehyde may be admitted to be the production of  $(CH_2 \cdot NH_2 \cdot HCl)_3$ . This reacts on heating as follows:  $2(CH_2 \cdot NH_2 \cdot HCl)_3 + 3CH_2O + 3H_2O = 6(CH_2 \cdot NH_2 \cdot HCl) + 3CO_2$ , giving a theoretical yield.—On acid chlorides and aldehyde chlorides, by M. Paul Rivals. The thermal data are given for mono-chloroacetic chloride and trichloroacetic chloride, and are shown to vary in the same way as with the corresponding acids.—Optical resolution of  $\alpha$ -oxybutyric acid, by MM. Ph. A. Guye and Ch. Jordan. The synthetic  $\alpha$ -oxybutyric acid is a racemic form. The authors have successfully separated the levorotatory form from the dextrorotatory form by means of their brucine salts.—On lactic acid, by M. E. Gérard. The acid is shown to have a real existence, and forms definite metallic salts. It does not consist of a mixture of stearic and palmitic acids.—Glycogen in the blood in normal and in diabetic animals, by M. M. Kaufmann. Glycogenic matter is a constituent of normal blood. The blood of animals rendered diabetic by extirpation of the pancreas contains much more glycogen than that of healthy animals.—On the signification of the disengagement of carbonic acid by the isolated muscles of the body, compared to that of the absorption of oxygen, by M. J. Tissot. The total quantity of carbonic acid disengaged by a muscle placed in the air has no relation with the phenomena of physiological activity, of which the isolated muscle is yet the seat. The absorption of oxygen is alone related to the manifestation of physiological activity, the absorption being at the maximum when the muscular activity is greatest, and at the minimum when it is diminished or on the point of disappearing.—On the structure and affinities of *Microsporon*, by M. Paul Vuillemin. The author includes *Microsporon vulgare* among the Phycomycetes, and not among the Saccharomycetes. It is not a necessary parasite, is found on healthy skin, but is adapted for parasitism, and is most abundantly found in the epidermis of new-forming spots of simple psoriasis.—On the embryonic development of the Diromiacean genus *Dicranodromia*, by M. Eug. Cuvier.—On a new combination of forms on quartz crystals, by M. Fred. Wallerant.—On an approximate estimate of the frequency of earthquakes on the surface of the globe, by M. F. de Montessus de Billore.

BERLIN.

Physiological Society, February 1.—Prof. du Bois Reymond, President, in the chair.—After a discussion on Dr.

Cohnstein's communication on "intravenous infusion of sodium chloride," Prof. G. Fritsch discussed the simple principles on which he had for many years obtained stereoscopic photographs on an enlarged scale. He exhibited a series of these photographs, among which those of the inner ear excited particular interest.

February 15.—Prof. du Bois Reymond, President, in the chair.—Prof. Zuntz gave an account of experiments, made in conjunction with Staff-Surgeon Dr. Schumburg, on the effect of load on the metabolism and body-functions of soldiers on the march. Two students, feeding uniformly on a somewhat complicated but accurately analysed diet, made on alternate days marches up to 45 kilometres with a load increasing to 31 kilograms. Taking first the nitrogenous metabolism, it was found that the excretion of nitrogen through the urine and sweat was but slightly increased by even the most severe exertion. The slight loss of proteid thus noticed was made good in the subsequent period of rest. At the end of each experiment the consumption of oxygen was found to be greater than at the beginning. When the marches were made on three consecutive days with an increasing load, it was found that the consumption of oxygen was increased even at the beginning of the third day's march, and was still further increased at its end. The body-temperature rose to 38° C., and in some cases to 40° C. The heat production was three times as great as during rest, and the regulation of temperature to compensate for this was almost entirely brought about by the evaporation of sweat. The concentration of the blood was found to be but very slightly increased by exhausting marches; the red blood-corpuscles were scarcely more numerous than normally, whereas the white were markedly increased in number. The movements of the heart at the end of the experiments showed a lengthening of the systole and distension of the right ventricle, whose dull area on percussion, as also that of the liver, was extended during severe exertion. The respiratory activity was at first, and with light loads, improved, but later on difficulties of breathing made their appearance. The psychic condition, as measured by the reaction-time to simple stimuli, was not depressed by heavy marches; but when fatigued the patients reacted more slowly to complicated stimuli. Muscles not used in marching, were as readily excitable at the end of the most severe march as during complete rest. A high external temperature was found to exert the same influence with a light load, as the heaviest load did at more moderate temperatures, and some details of the experiments were found to depend on individual peculiarities.

Meteorological Society, February 5.—Prof. Hellmann, President, in the chair.—Prof. von Bezold spoke on the unstable equilibrium of the atmosphere which precedes a thunderstorm. The fact that in the interior most thunderstorms occur in the afternoon and during the summer, whereas near the coast they are most frequent at night and in the winter, shows that there must be different causes for the instability. As a matter of fact the speaker showed that not only over-heating of the lower layers of air, but also excessive cooling of the upper layers, must lead to unstable equilibrium and a correspondingly powerful upward current of air. A similarly unstable state is brought about by the sudden solidification of strongly cooled water-drops, or the condensation of air highly supersaturated with moisture. The conditions for the realising of the above states are different in the interior and at the coast or over the sea, and the mode of formation of a thunderstorm is also correspondingly different. He considered it very desirable that further observations of thunderstorms at sea should be collected.—Mr. Archenhold exhibited water-colour drawings, made by Captain Henning in 1884, of the unusual twilights then occurring, he being at the time ignorant of the abnormality as observed by others. One of the most remarkable features in the drawings were the sharp and straight lines of demarcation in the colours of the sky. The speaker further exhibited a photograph of a halo he had observed by moonlight.

Physical Society, February 8.—Prof. Schwalbe, President, in the chair.—Dr. Neuhaus exhibited a series of colour photographs taken by Lippmann's method with prolonged exposure. Spectra show, if the exposure is sufficiently long, a greenish band in the infra-red as well as in the ultra violet, in addition to the ordinary colours. The coloured band was very markedly displaced by both over- and under-exposure. The photographs of objects with mixed colours, such as fruits, flowers, butterflies, &c., were also good; but their production was extremely

...cut, and only one plate in twenty-five was, on an average, successful. It was found more easy to photograph naturally mixed than artificially mixed colours. When describing his methods, it was pointed out that some substance such as eosin or cyanin must be added to the films to make them more sensitive to red rays, and less sensitive to blue. When dealing with the theory of colour photography, which was expounded by Dr. Zenker as early as 1868, the speaker referred to a number of difficulties which had not yet been solved. Thus, in the first place, nobody has as yet demonstrated the existence of the superimposed silver films in the gelatine, although they should be visible under the microscopic powers now available. In the next place, the presence in the gelatine film of granules whose diameter is equal to several half-wave-lengths is not reconcilable with the usual theory of colour photography; so that, on the whole, a comprehensive theory of the phenomena has still to be established.—Mr. Archenholz gave some additional details as to the mechanical parts of the great telescope he had described in the previous meeting of the Society.

February 22.—Prof. von Bezold, President, in the chair.—Prof. Lummer spoke on the necessary corrections of dioptric systems, and developed theoretically the possibility of the law of points holding good for certain relations between focal length and aperture. Prof. Kaoul Pictet spoke on the "critical point," and explained his own views, according to which substances must still be in the fluid state at the critical point. This follows from the fact that the amount of heat which must be put into the substance, as reckoned from absolute zero, is less than the latent heat of the liquid, and the fact that solid bodies do not separate out from solution at the critical temperature. They must be still in solution in the fluid, since they separate out in the crystalline form by a further rise of temperature, and go into solution again as the temperature falls to the critical point. This last fact was demonstrated by the speaker on a solution of iodide of potassium.

AMSTERDAM.

Royal Academy of Sciences, January 26.—Prof. van de Sande Bakhuizen in the chair.—Mr. Franchimont communicated a paper on a new class of urea-derivatives, viz. the urea-alcohols or ureols, one of which, ureo-athanol, has been prepared by the author and Mr. Van Breukeleveen. This body, obtained from amino-ethanol through Wohler's synthesis of urea, forms colourless crystals, which fuse at 95°, and dissolve readily in water, methyl-alcohol and ethyl-alcohol, but very sparingly or not at all in most organic solvents. It appears to possess properties both of urea and of an alcohol. With nitric acid it forms a compound, which is decomposed by so-called real nitric acid at the ordinary temperature, with the formation of carbonic acid and nitrous oxide. With benzoyl chloride it yields a benzoate, which fuses at 129°, and is decomposed by nitric acid in the manner described above. With acetic anhydride and sodium acetate, a diacetyl derivative is obtained, which fuses at 102°.—Mr. Hoogewerff directed attention to an apparatus, devised last summer by Mr. J. Root. The object of the apparatus is to easily and quickly graduate retorts, pipettes, and burettes, especially such as are intended for technological researches. The firm of Kobb at Sutzerbach in Thuringen has been commissioned to make the apparatus. Mr. Van der Waal showed that the condition for the equilibrium between co-existent phases, viz. the equality of the thermodynamic potential, may be deduced from the kinetic theory by assuming that the two phases interchange an equal number of particles, and may be regarded as a particular instance of the more general law by which the kinetic theory expresses the density in different parts of a space, wherein the moving molecules are subjected to the action of forces.—Prof. Kamerlingh Onnes communicated the results of investigations in the Leiden laboratory by: (1) Dr. L. H. Siertsema on the magnetic rotational dispersion of oxygen and nitrogen at a pressure of 100 atm., giving the following relation between the rotation  $w$  and the wave-length  $\lambda$ : oxygen  $w = C \cdot \frac{868}{\lambda} \left( 1 + \frac{0.07202}{\lambda^2} \right)$ , nitrogen  $w = C \cdot \frac{560.41}{\lambda} \left( 1 + \frac{0.32424}{\lambda^2} \right)$  and proving again the superiority of Maskart's formula (see p. 476). (2) Dr. P. Zeeman on the Kerr effect in polar reflection on iron and cobalt at normal incidence, tending to the conclusion that none of the proposed theories completely explains Sissingh's phase difference. (3) Dr. P. Zeeman on the optic constants of

magnetite, determined with regard to the relation between Sissingh's phase in the Kerr phenomenon and the maximum of magnetisation. (4) Mr. A. Lebreton on the variation of the Hall effect in bismuth with temperature, it being found to be nearly linear between -38 and 239°.

BOOKS, PAMPHLETS, and SERIALS RECEIVED

BOOKS.—The Pygmies: A. de Quatrefages, translated by F. Starr (Macmillan).—The German Universities, their Character and Historical Development: Prof. F. Paulsen, translated by Prof. E. D. Perry (Macmillan).—A Treatise on Bessel Functions and their Applications to Physics: Profs. Gray and Mathews (Macmillan).—Meteorology, Weather, and Methods of Forecasting, &c.: T. Russell (Macmillan).—Diary of a Journey through Mongolia and Tibet in 1891 and 1892: W. W. Rockhill (Washington).—Bourne's Handy Assurance Directory, 1895 (Schoonling).—An Elementary Text-Book of Hydrostatics: W. Briggs and G. H. Bryan (Clive).—The Telegraphist's Guide to the New Examinations in Technical Telegraphy: J. Bell (Electricity Office).—The Source and Mode of Solar Energy throughout the Universe: Dr. I. W. Heysinger (Lippincott).—Handbook of Jamaica, 1895 (Stanford).—Im Reiche des Lichtes: H. Gruson (Braunschweig, Westermann).—Honest Money: A. F. Fonda (Macmillan).—Collected Papers on some Controverted Questions of Geology: Dr. J. Prestwich (Macmillan).  
PAMPHLETS.—N.S.W. Government Railways and Tramways—Annual Report of the Railway Commissioners for the Year ending June 30, 1894; Do., Supplement to the Railway Commissioners' Annual Report.—Die Reisen des Jason und der Heracles in das Antarktische Meer 1893-94: Dr. J. Petersen (Hamburg, Friederichsen).  
SERIALS.—Science Progress, March (Scientific Press, Ltd.).—Medical Magazine, March (Strand).—Proceedings of the Physical Society of London, Vol. xiii, Part 4 (Taylor and Francis).—Engineering Magazine, March (Tucker).—Memoirs and Proceedings of the Manchester Literary and Philosophical Society, 4th series, Vol. 9, No. 2 (Manchester).—Essex Institute, Historical Collections, Vol. 30 (Salem, Mass.).—Journal of the Franklin Institute, March (Philadelphia).—Internationales Archiv für Ethnographie, Band vii, Heft 4 (Leiden, Brill).—Himmel und Erde, March (Berlin).—Rendiconto delle Sessioni della R. Accademia delle Scienze dell' Istituto di Bologna, 1892-93, 1893-94 (Bologna).

CONTENTS

Modern Bacteriology. By Mrs. Percy Frankland . . . 481  
 Chemical Analysis. By J. W. Rodger . . . . . 482  
 Analytical Geometry. By R. L. . . . . 483  
 Our Book Shelf:—  
 Angot: "Les Aurores Polaires" . . . . . 484  
 Kennedy: "A Few Chapters in Astronomy" . . . . 484  
 Glazebrook: "Mechanics for Colleges and Schools: Statics" . . . . . 484  
 Bell: "The Telegraphist's Guide" . . . . . 484  
 Letters to the Editor:—  
 Corrections of Maximum and Ex-Meridian Altitudes. (With Diagram).—J. White . . . . . 485  
 Argon and the Periodic System. (With Diagram).—Prof. J. Emerson Reynolds, F.R.S. . . . . 486  
 Variation in *Calltha palustris*.—Prof. T. D. A. Cockerell . . . . . 487  
 Dr. M. Foster on the Teaching of Physiology in Schools . . . . . 487  
 Notes . . . . . 488  
 Our Astronomical Column:—  
 Partial Eclipse of the Sun, March 26 . . . . . 493  
 Distribution of Minor Planets . . . . . 493  
 Solar Phenomena in 1893 . . . . . 493  
 The Royal Observatory, Edinburgh . . . . . 493  
 Physical Work of Hermann von Helmholtz. II. By Prof. A. W. Rücker, F.R.S. . . . . 493  
 Electrification of Air and other Gases. (Illustrated.) By Lord Kelvin, P.R.S., Magnus Maclean, and Alexander Galt . . . . . 495  
 University and Educational Intelligence . . . . 496  
 Scientific Serials . . . . . 500  
 Societies and Academies . . . . . 500  
 Books, Pamphlets, and Serials Received . . . . 500

THURSDAY, MARCH 28, 1895.

## ORB-WEAVING SPIDERS OF THE UNITED STATES.

*American Spiders and their Spinning Work: a Natural History of the Orb-weaving Spiders of the United States, with Special Regard to their Industry and Habits.* By Henry C. McCook, D.D. Vol. iii., with descriptions of orb-weaving species and plates (pp. 1-284. pl. 1-30). (Published by the Author, Academy of Natural Sciences of Philadelphia, A.D. 1893.)

VOLS. i. and ii. of this work have been already noticed in these columns. (See NATURE, vol. xlii., p. 244, 1890; *Ibid.* xliii., p. 74, 1890.) The volume before us completes the work, and bears date 1893; but it was only issued to the public at the end of 1894. To the general reader this is a matter of little consequence, but to the specialist it is often important, for it frequently happens, as in this instance, that new genera and species are characterised and described; it then often becomes necessary to decide, on the questions of priority that may rise, as exactly as possible when such descriptions were made, and the date inscribed on the work, it is manifest, cannot be implicitly relied upon.

In the preface to the present volume, it is stated that the work has engaged the author's thoughts for more than twenty years, and to this the amount of research and observation testified to in three large volumes amply bears witness. The first six chapters of vol. iii. (pp. 1-131), being part i., are a kind of supplement to vols. i. and ii., and are "on various natural habits and physiological problems" of spiders. Part ii. (pp. 132-277) carries out the prospectus of the work at first issued, viz. *descriptions of the American "orb-weavers,"* illustrated by thirty coloured plates of great beauty and accuracy, especially in regard to the anatomical details; two, however, of these plates are of spiders of various groups and species alluded to in the foregoing part of the work, though without special description. The author speaks of this portion of his task (part ii.) as in many respects its most difficult part; but this may be taken as tolerably certain, that though vols. i. and ii. and the first half of vol. iii. will always be the most popular part, the latter portion of vol. iii. will prove of most value to the scientific world. The observation and detailing of habits, manners, and general economy, whether of spiders or any other group in the natural world, afford unlimited scope for imagination, sentiment, as well as popular and picturesque description, all of which the true scientific worker has resolutely and wholly to shun, or, at any rate, to repress with a strong hand. It seems almost a pity that these two distinct portions of Dr. McCook's work had not been issued separately, as the total cost of the whole—50 dollars—is a heavy sum to pay for the 136 pages and thirty plates, which will alone be indispensable to the systematic working araneologist. Nor will it be possible (we are told in this vol.) to obtain vol. iii. apart from the other two.

All that was said in the notices, above alluded to, of vols. i. and ii. can be again here repeated in praise of the

execution of the work in this third volume. Chap. i. is "on toilet, drinking, and social habits"; chap. ii. on "memory, mimicry, and parasitism"; chap. iii., "biological, miscellany"; chap. iv. "on weather prognostications, sundry superstitions, and the commercial value of spiders' silk"; chap. v., "on moulting habits of spiders"; chap. vi., "regeneration of lost organs, and anatomical nomenclature." On all these subjects there are many most interesting and useful observations.

In chapter i., p. 1, speaking of spiders' habits of cleansing themselves of objectionable matters by their having a spiny armature of the legs and mandibles (*fulcres*), so evidently well adapted for the purpose, it is asked, "Did the habit of cleanliness arise from the possession of these implements, or were the implements developed out of the vital necessity for a cleanly person?" In the first place, it suggests itself as hardly tenable to assume, *à priori*, such a vital necessity in respect to spiders, any more than with regard to some Acarids, or the larvæ of certain insects, whose habit it seems to be not only to need no cleansing, but to encourage the accumulation upon their bodies of various kinds of adventitious and, at times, of even excrementitious matter; but not to dwell on this view of it, the case of the spiders might perhaps be simply presented in this way. The accumulation of dust, or soil, or what not about them, arises mainly from their having clothing and spinous armature, in which those substances become entangled and retained, while at the same time those very causes of the inconvenience become the means of obviating it; for we may take it that the first efforts of a sentient being are to rid itself of whatever may adhere to it, to its hindrance or annoyance; in this process, whatever existing portion of structure came handiest would necessarily be the first used, whether, as in the case of cows and other horned cattle, the lashing of its sides by a heavily-tipped tail, or the muscular movements of the ears, or the action of the hinder hoofs; but it would scarcely be argued, either, that the ears, tails or hoofs of cows were developed just for the purpose of ridding them of insect or other inconveniences, or that the habit of so using them arose out of the animals' possession of ears, tails, and hoofs. Nor can we, it is conceived, argue either that spiders' habits of using hairs and spines in cleansing themselves arose from the possession of such implements, nor that these implements were developed from those habits. All that we can say with any certainty, seems to be that while hairs and spines, &c., were developed by various means and for various ends, the more perfect adaptation of some of them for special functions would no doubt be effected by natural selection: such, for instance, as the development of the calamistrum on the metatarsi of the fourth pair of legs in numerous widely separated genera, and even families of spiders, for the utilisation of the silk-matter of the supernumerary spinners, which last are always found correlated with the calamistrum. Under the heading of "Burrowing Spiders," pp. 31-35, we have a very interesting and important account of trap-door nests made by Lycosid spiders; those hitherto known as "trap-door spiders" having been exclusively of the family Theraphosidae. A remarkable account of a spider apparently voluntarily changing its

colour, is given at p. 51. This account, it seems, is taken from NATURE, April 13, 1893, p. 558: but it appears to need corroboration.

Among other points in respect to spiders' spinning work, the use and commercial value of the product is naturally referred to pp. 83-89, and the various experiments (already published from 1709 to the present time) made to ascertain their use and value are noted: but the subject does not seem to have attracted much attention since Prof. Wilder's experiments in 1855-1869. Some subsequent researches made by a Mr. Stillbers, an Englishman (quoted in a paper by M. Guatier), appear to need more circumstantial reference and explanation. It may, however, be mentioned here, that in 1884 a small mass of spider's silk was received, through Prof. Thiselton-Dyer, by the present writer, from Almora, Saharunpur, India. This was mixed up with the debris of dead insects and spiders, as well as with portions of the plants among which the silken webs were spun. Some of this mass was examined by Mr. Thomas Wardle, who reported upon it in the *Journal of the Society of Arts*, May 1885 (pp. 679-680). In an exhaustive paper in that journal, on "Researches on Silk Fibre," Mr. Wardle says, in the course of his report:—

"I believe, if it can be obtained in quantity, it might be packed in bales and sent to England, where it would readily find a market for being carded and spun into silk threads for sewing or weaving purposes. It is difficult to estimate its market value. I dare say it would, at any rate, realise one shilling to two shillings per lb. It is rather dirty, and this would to some extent detract from its value as compared with silk waste."

The spider to which this silken mass was referable is *Nephilengys Epeira Malabarensis*, Walck, a species of very wide tropical distribution, and apparently in great abundance where it occurs. There seems to be no reason why almost any amount of this silk should not be obtainable from the low plants and scrub on which the spiders spin their snares, and, with a little care in gathering, much less intermixed with dirt and other adventitious matter than the sample above alluded to. In fact, we may easily conceive that it would be possible, with a little trouble, to form a kind of spider-farm for the purpose of producing this silk in the greatest possible perfection and abundance. From Mr. Wardle's analysis and treatment of this silk, it may be seen that it possesses some very valuable and curious characters.

The chapter on "Moulting Habits" is full of exceedingly interesting details, both from published works and the author's own observations. Moulting is a critical operation in spider-life, and is usually attended with a great demand on the vital powers of the spider; and though spiders probably seldom succumb when in a state of nature, moulting, when in confinement, frequently proves fatal, especially when the spider is advanced in age. A large Theraphosid, for eighteen months kept in confinement in the gardens of the Zoological Society of London some few years ago, died at length in its last moulting process. After the last moult, which completes the structural development of the spider, it seems that no further ecdysis takes place, whatever age the spider may attain. The number of moults appears to vary, not only with the species, but with individuals of the same

species: food, temperature, and other conditions no doubt affecting it. Chapter vi., on "Regeneration of Lost Organs," is based chiefly on the researches of Voldemar Wagner ("La régénération des organes perdus chez les Araignées," *Bull. Soc. Imp. Moscou*, 1887, No. 4) and the observations of H. Heineken (*Zool. Journ.* iv. 1828-29). Papers on the subject by the late Mr. Blackwall are also noted.

Part ii. consists of "Descriptions of Genera and Species." In his introductory remarks to this part, Dr. McCook defines the extent of the group comprised in his "Orb-weaving Spiders." This is coextensive with the "Orbitelariæ" of Dr. Thorell, and includes *Uloborus*, which is far removed structurally from the *Epeiridæ*, as well as *Pachygnatha*, which, so far as known, spins no snare at all. The difficulty of drawing any decidedly marked line between the *Retitelariæ*, and *Orbitelariæ* is no doubt great. Witness the results arrived at by M. Eugène Simon in his work now in progress—"Histoire des Araignées," second edition, 1893-4—in which these two enormous groups are fused, and again subdivided: the materials being recast in a way which upsets all the previously conceived ideas of araneologists. However, until these new views are better understood and generally adopted, the old division into geometric web weavers and those whose snares are not geometric, but net-like, with exceptions such as the *Uloboridae* and *Pachygnatha*, are sufficient for popular as well as faunistic purposes.

At pp. 8 and 133, reference is made to drawings of American spiders made by John Abbott early in the present century, and the descriptions of which are contained in Baron Walckenaer's *Ins. Apt.*, A.D. 1837. It appears from Dr. McCook's remarks that he was under the impression that some drawings which he saw in the British Museum in 1887 were the original drawings of John Abbott's spiders. This, however, is not so. The British Museum set of drawings are either a copy of those of Abbott, or, may be, a duplicate set done by Abbott himself. The originals (or, at any rate, those from which Walckenaer drew up his descriptions of the spiders) are in the possession of the authorities at the Jardin des Plantes, Paris. Many years ago it was proposed to the present writer by the late Dr. John Gray, of the British Museum, to prepare and publish descriptions of the spiders from the British Museum copy, along with plates engraved some years previously from that copy, under Dr. Gray's orders. Such descriptions, however, it is quite obvious, could not possibly be done satisfactorily from the drawings alone—witness Baron Walckenaer's efforts—though no doubt numbers of the spiders delineated can, with more or less certainty, be specifically determined from them. The result of an inquiry made at that time, was that the French nation has Abbott's original drawings, which were presented, directly or indirectly, to Baron Walckenaer by Abbott himself; but what the British Museum set was, or how it was acquired, seemed to be very doubtful.<sup>1</sup>

In a general notice like the present, part. ii. of the vol.

<sup>1</sup> Dr. McCook evidently was not aware that the present writer, in a review of N. M. Heintz's "North American Spiders" in 1876 (*NATURE*, vol. xii, p. 272), mentions these facts and considerations respecting John Abbott's drawings.



under consideration needs but little remark. The descriptions are full and accurate, and the figures are nearly all engraved from drawings beautifully executed by Miss Elizabeth F. Bonsall, and leave but little to be desired. Three, however, of the plates—Nos. 2, 10, and 15—are from the author's own drawings, and are fully equal, if not superior, to the rest. 123 species of spiders of the orb-weaving group are described, and, of these, twenty-four are considered to be new to science. Four new genera are also characterised. In every way, part ii. will be of great use and importance to systematic araneologists. A portrait of Nicolas Marcellus Hentz (justly called the father of American araneology) forms a most appropriate frontispiece.

O. P. CAMBRIDGE.

THE SEA AND ITS COASTS.

*Sea and Land, Features of Coasts and Oceans, with special reference to the Life of Man.* By N. S. Shaler, Professor of Geology in Harvard University. Illustrated. (London: Smith, Elder, and Co., 1895)

IN more than one sense this book is a thinner one than "Aspects of the Earth." Of the seven essays which it contains—in the main republications—the first four deal with familiar subjects—the work of the sea, its beaches, its depths, and icebergs; the last three treat of harbours, and introduce some questions which are less hackneyed and more interesting. Prof. Shaler writes pleasantly, and his sentences flow easily, but it is sometimes possible to read through several paragraphs without much progress in knowledge, or to find a rather large number of well-turned phrases expended in stating what amounts to a truism. But as the preface informs us that the object of the book is "to introduce unprofessional students of nature to certain interesting phenomena of the sea-shore and of the depths of the ocean," it is very possible that babes in science will find well-sweetened pap more digestible than strong meat. We must, however, protest against the liberties which Prof. Shaler takes occasionally with our mother-tongue. He is too fond of "telephonese" or "telegraphese," as it might be called. This tongue may be good American, but it is not good English. We do not mean to assert that no improvements could be made in the latter, or to pose as prudes of etymological purity, but we object to the coinage of new words, or, rather, the misuse of old words, where grammatical expressions already exist, longer only by a few more letters or, at most, syllables. Brevity may be the soul of wit, but it is not always an adornment in speech. Is there any real gain (to take a few examples) in such an adjective as "pivotal," such participles as "fiorded," "forested," "peninsulated," "well-harboured" (*i.e.* with many harbours), and such a verb as to "raft off" in the sense of transport or carry off like a raft.

Prof. Shaler is a picturesque writer, and his descriptions usually are clear and vivid; but dangers lurk in the attempt to be graphic when a locality is known only at second-hand. Of this the book before us affords an amusing instance. Speaking of the advance of dunes, he quotes the well-known case of Eccles (Norfolk), saying: "Thus in Britain one of these dunes in the last century invaded the village of Eccles, and buried the

dw ellings and the parish church, so that even the top of the spire was hidden. After a number of years the summit of the church began to reappear on the leeward [? windward] side of the hill, and in time the remote descendants of the dispossessed people may be restored to their heritage." But the dwellings had practically disappeared before the dunes rolled over them: the church had been a ruin for at least two centuries: of its body only the foundations remained; there was no spire, and apparently never had been one; and the octagonal lantern of the tower was never wholly buried, unless the well-known engraving in "Lyell's Principles of Geology" represents an exceptional condition of the sandhills. So if the descendants of the original villagers do return to their ancestral domiciles, they will find themselves " Lords of the sands, an heritage of waves." Indeed, since Prof. Shaler wrote, even the old tower has tumbled down, destroyed by the waves during a gale last January.

We venture also to think that Prof. Shaler takes rather too much for granted in assuming, without a hint that this has been disputed, that great rock basins have been excavated by glaciers. Moreover, he is hardly correct in saying that fjords are restricted to ice-worn regions, for Cornwall can show more than one very respectable imitation of such an inlet, and on the Dalmatian coast they are not rare; yet we can hardly suppose that even in the coldest part of the Great Ice Age, precipitate glaciers descended from the Montenegrin Highlands to scoop out the Bocche di Cattaro. But perhaps an inlet of the sea only becomes a fjord when it shallows towards its mouth; if so, that should have been clearly stated. Doubtless these basin-like fjords are difficult to explain; but as Prof. Shaler admits the existence of submerged moraines, no excavation need be required. At any rate it would be well, as a preliminary step, to prove that glaciers are agents of excavation to any important extent, for this has been denied by many geologists, who vainly ask to be shown any proofs of such effects in the subaërial part of their course.

But we must not dwell too much on blemishes, which after all are light. Even the four earlier essays, already mentioned, exhibit a certain freshness, for Prof. Shaler, as an American, selects the majority of his examples from the other side of the Atlantic, instead of using those which have become the stock-in-trade of every European geologist. By this means more than one point is brought out more clearly than is usual in English books, because illustrations are difficult to obtain from our own islands, or any readily accessible part of the neighbouring continent. For instance, his remarks on the action of vegetation in a shallow estuary or bay, and particularly on the growth of "mangrove swamps" are valuable. He describes how the large tapering cylindrical seed of the mangrove, floats in a vertical position, settles down and becomes entangled on the bottom by means of the numerous hooklets which arm its lower extremity, then sends a shoot up above the surface of the water, from which come wide-spreading, low-growing branches. From these long runner-like processes are thrown off, which at last curve sharply downwards through the water till they strike root at the bottom, and then support new crowns, each having its own trunks

and branches. "Thus a single tree may rapidly march away from the original planting-point until its outer verge may be an indefinite distance from its place of origin." This method of growth enables the grove to resist even fairly strong waves, and facilitates the accumulation of organic debris and inorganic sediment.

Again, there are some striking remarks on the accumulation of molluscs, especially bivalves. Prof. A. Agassiz has already called attention to this process on the great Florida plateau, and Prof. Shaler particularly mentions the special importance of the oyster as a rock builder along the whole coast from New York southwards.

"In its maximum development" he says, "the larger part of the shallow bottom inside the ocean beach is occupied by beds of these shells. So crowded are these forms, that they push their growth above the level of low-tide mark, and in the region where the mangroves abound they cluster on the roots of the trees to such numbers as often to hide them from view. . . . Between Charleston, South Carolina, and Biscayne Bay, Florida, there is an aggregate area of nearly a thousand square miles which, when the shore assumed its present elevation, was occupied by tolerably deep water that has now become filled to near the level of high water, by sediments composed in large part of oyster-shells."

In fine, these three essays contain not a few interesting and suggestive passages. The illustrations often are very good.

#### THE CHEMISTRY OF COD-LIVER OIL.

*Cod-liver Oil and Chemistry.* By F. Peckel Moller, Ph.D. (London: Peter Moller, 43 Snow Hill, E.C., and at Christiania, Norway, 1895.)

THIS book is divided into two parts—the title of part i. is "Cod-liver Oil"; the title of part ii. is "The Law of Atomic Linking, diagrammatically illustrated," and the heading of the first chapter of the second part is "Chemistry." There is a separate preface to each part, and, though bound together in one volume, each forms an independent treatise, and is separately pagged. One hundred and eleven pages are devoted to "cod liver oil," and rather more than five hundred to "chemistry."

In the preface to the first part the author gives two reasons for the publication of the work: (1) to deal with all matters connected with cod-liver oil, and especially with those likely to be of interest to members of the medical profession; and (2) to give the results of the investigations lately undertaken by Mr. Heyerdahl, which "throw the first and only true light on that mystery, the real nature of the oil."

The first and second chapters give an interesting account of Norway, which is styled "the land of the midnight sun and cod-liver oil"; its people, past and present; its social customs; the Gothenburg system in every town; its land question; its fisheries, fishermen, and fishing boats, their tackle and bait; its tourist visitors, and its "oldest established visitor," the cod-fish.

The next chapter is on "cod-liver oil," and the reader is instructed, as pleasantly as in the preceding chapters, in the ancient and modern methods of preparing the oil for use. The older method, it appears, was in use until so late as the year 1853, when a

great improvement was effected by the introduction of the steam process of extraction, by which means the pure oil only is obtained from the livers, instead of oil mixed with a great number of decomposition products. This steam process was a great advance. The resulting oil had lost much of its objectionable taste and smell, but it still retained one very bad characteristic—it was still very apt to give rise to nauseous eructations. Unwelcome flavours continued to assert themselves after a dose of such oil, not once only but again and again, till, as the author says, the unhappy recipient was tempted to say, "life is not worth living if it is to be only at the cost of taking cod-liver oil." Hence the host of attempts that have been from time to time made to treat the oil so as to abolish these disagreeable properties. These are dealt with in the chapter called "Pharmaceutical Annotations," and some forty different ways of disguising or improving the oil are described in detail—the ingredients for mixing with the nauseous article including such diverse things as beer, iron-water, peppermint oil, coffee, eucalyptus oil, wood-tar, ammonia, ketchup, celery-seed infusion, vinegar, iodoform, saccharin, acetic ether, &c.; and, besides all these, every conceivable form of emulsion seems to have been tried. It will be welcome news to many that, in Dr. Moller's opinion, all these elaborate preparations are now quite uncalled for, and that Heyerdahl's investigations have at length led to the possibility of an oil being produced more curative than the old oil, and quite free from nauseating powers. These researches are fully described in a separate chapter, and are considered to have revealed the presence in the oil of two hitherto unknown glycerides, which have been named, respectively, *therapin* and *jeccolern*. They are both exceedingly unstable compounds, and easily become oxidised, and these oxidation products are believed to be the real cause of the too well-known unpleasant after-effects of the drug. As a result of these discoveries an apparatus has now been devised by which cod-liver oil can be produced on a large scale without even the slightest oxidation taking place. Air is excluded from the beginning to the end of the operation, the process being conducted in a current of carbonic acid from the moment the livers enter the apparatus until the oil obtained from them is safe within the bottles.

The chapter giving a synopsis of the chief researches on the oil since 1822 is very complete, and will no doubt prove of great interest to medical men and pharmacists.

The conclusion arrived at as to the therapeutic agent in cod-liver oil is that "it is the oil itself," and that its remarkable power as a nutritive food is the cause of its medicinal efficacy, and not any special active principle contained in it. This opinion is in agreement with that of the late Prof. J. Hughes Bennett, of Edinburgh, who published, in 1841, a pamphlet on cod-liver oil, which had much to do with the general introduction of the oil as a medicine into this country. It is one of the omissions in the present volume that no reference is made to the work of Dr. Bennett in this direction.

The object of the second part of this work, as set forth in the preface, is mainly to bring the facts of organic chemistry, freed from unnecessary difficulties,

within the grasp of busy medical practitioners. With this object graphic formulæ are profusely employed, so that "a glance will lay bare to the eye of the novice the whole details of the constitution of the most complicated compounds," and the practical preparation of the compounds has been generally omitted "because the much tried patience of medical men need not be burdened with things chiefly of interest to the chemist." With these exceptions a large proportion of organic chemistry is very fully treated, and a careful reading of the work in leisure moments would doubtless give any one, who had some previous knowledge of the science and some liking for it, a fair grasp of somewhat more than the outlines of this vast and ever-increasing field. Especially interesting, though demanding more than cursory reading, is the concluding chapter on atoms, linkage, and stereo-chemistry. In our earlier days chemists did not so much concern themselves with these things. The determination of mere composition and formulæ furnished enough occupation. But with advance of knowledge it has been found necessary to study what has been called the "atomic architecture of molecules." In the concluding pages this subject is very ably and lucidly discussed. A new hypothesis is suggested, to which the name of the "screw theory" is given, which, it is pointed out, may satisfactorily explain those cases of optical activity which are met with in certain bodies, e.g. some terpenes and glycerides, where there is no asymmetrical carbon-atom, and which are consequently not clearly met by van't Hoff's ingenious theory.

The volume is one in the production of which great labour and care must have been expended, and both parts are worthy of commendation. Possibly, however, it would have been advantageous to both, if they had been published separately. JAS. CAMERON.

#### OUR BOOK SHELF.

*Astronomische Chronologie.* By Walter F. Wislicenus. (Leipzig: B. G. Teubner, 1895.)

HISTORIANS, archaeologists, and astronomers will hail with delight this work, as it fills a gap which for some time past has been very apparent. At the present day, to take one case only, archaeologists are busy in Egypt deciphering and unravelling the legion of myths which are there recorded in the many forms and ways peculiar to that country. Many of these myths are, as has been recently more clearly pointed out, purely astronomical in their nature; and this is perfectly natural when one considers that the Egyptians, or, at any rate, the priests, for these were the chief writers, were astronomers. Archaeologists in fathoming these depths are perfectly at home when archaeology is in question, but as soon as the astronomical boundary is reached, and astronomy pure has to be attacked, then perfectly different problems are met with. In like manner, the astronomer himself, going from the astronomical to the archaeological side, is also nonplussed, unless he wishes to enter somewhat generally into the study of Egyptology. In the book which we have before us, Dr. Wislicenus gives the historians and archaeologists a helping hand, and presents them with the necessary means and ways of solving some of the problems which are generally encountered.

Without entering too minutely into the contents of these 150 odd pages, a general survey of the text will best give the reader an idea of their character.

The two parts, into which the book is divided, deal respectively with the fundamenta of astronomy, and the different methods of computation.

The former part is concise and brief, and the author in forty-four pages presents the reader with a general summary of the different systems of coordinates used, the different kinds of years, the course of the moon, eclipses, daily and yearly rising and setting of the heavenly bodies.

The methods of computation in the second part are so arranged that they follow, in the same order, the text in the first. At the commencement of this part Dr. Wislicenus brings together a list of the numerous tables which are used for the solution of chronological problems. These are here given with their full titles, and are explained further on. The remainder of the book is devoted to the solutions themselves, and these are arranged as follows: First, the known and the unknown quantities are separated, then the tables to be used in the problem in question are explained; following these, typical examples are taken and worked out by the use of the different tables.

A very full index makes reference easy, and completes what will prove a very useful book. W. J. S. L.

*Die ältesten Karten der Isogonen, Isoclinen, Isodynamen*  
By Prof. Dr. G. Hellmann. (Berlin: A. Asher and Co., 1895.)

THIS is the fourth of the elegant series of reprints devoted to classical contributions to meteorology and terrestrial magnetism. It contains seven maps, all excellently reproduced, and representing old standard charts of isogonic, isoclinic, and isodynamic lines. The maps portrayed are Halley's Declination Chart of the World, published in 1701; Whiston's two maps (1721), showing lines of equal magnetic Dip in the South of England; J. C. Wilcke's Isoclinic Chart of the World in 1768; a chart by Humboldt, published in 1804, showing Isodynamic lines over part of South America; and Hansteen's Isodynamic Charts (1825-26) of North-West Europe and of the world.

Halley's description of his "New and Correct Sea-Chart of the Whole World, shewing the Variations of the Compass," is reprinted, and brief descriptions are given of the other maps.

Whiston, it may be remembered, suggested that longitude might be determined from magnetic inclination, this element being preferred to declination for reasons which he stated as follows: "When, therefore, I considered that the Lines of equal Dip could hardly be more irregular than those of the Variation; I well knew that Mutation was a great deal slower; and that these might probably be useful over all the World; I conceived great hopes that this way of Application of the Power before us might very probably discover the Longitude."

Prof. Hellmann contributes a number of bibliographical notes, and these, with the maps, make the reprint a compact and useful work of reference.

*An Elementary Text-book of Hydrostatics.* By W. Briggs, M.A., and G. H. Bryan, M.A. Pp. 208. (London: W. B. Clive, 1895.)

THE portions of hydrostatics and pneumatics usually taught to beginners, and required for the matriculation examination of the London University, are concisely and clearly treated in this book. Though evidently constructed for examinal purposes, the book contains a number of good points. The mathematical formulæ are deduced from first principles instead of being stated dogmatically; so the student is led to rely more upon his real knowledge, and less upon mere memory. This and other commendable features distinguish the volume from ordinary text-books of hydrostatics, while the numerous problems, covering a wide field, furnish clear evidence of originality.

## LETTERS TO THE EDITOR.

[The Editor is not held himself responsible for opinions expressed by correspondents. Neither can he undertake to return, or to correspond with the writers of, rejected manuscripts intended for this or any other part of NATURE. No notice is taken of anonymous communications.]

## The Statistical Investigation of Evolution.

MR. THISELTON-DYER states that Prof. Weldon has shown that "selective destruction" takes place in early life amongst individuals which deviate from the "mean specific form." He further says that the actual statistical demonstration of the fact that "minimum destruction is in position coincident with the mean of the whole system," deserves to rank amongst the most remarkable achievements in connection with the theory of evolution. But, to judge from the paper by Prof. Weldon, printed in NATURE of March 7, he does not claim to have made this remarkable achievement. He says that, according to the results of the statistical investigation, in two dimensions of the shore crab, the frequency of deviations increased during an early period of growth, and that in *one* case the increase was followed by a decrease; in the other case it was not. Prof. Weldon states that if a certain law of growth can be shown to be true by experimental tests, *then* the result implies a selective destruction in the one case and *not* in the other. So that all we have is the possibility in the future of a statistical demonstration of selective destruction in the case of one particular dimensional character, and the rigid proof in the present that in the case of the other dimensional character selective destruction does not take place. Surely every man of science must admit that Prof. Weldon's results, on his own showing, have done more against selective destruction than for it.

Prof. Weldon says that if we know that a given deviation from the mean is associated with a greater or less percentage of death-rate, we do not require to know how the increase or decrease of death-rate is brought about, and all ideas of functional adaptation become unnecessary. This may be his own state of mind on the subject, but I venture to state that it is not Darwinism, and that he cannot shut out others from the most interesting and most important fields of biology in this way. Darwinism states that selective destruction is caused by the struggle for existence, and that a selected character confers an advantage in the competition to get food and beget offspring. If a certain deviation is shown to be associated with an increased or decreased chance of life, we want to know how it acts, and no statistical Gallo can prevent us trying to find out.

It does not require much search to find deviations which are associated with an increased death-rate. In the human subject cyanosis, due to the retention of the fetal communication between the two sides of the heart, is a well-known abnormality or deviation in the infant; but I believe few, if any, children born in that condition reach the age of 20. Here we have no difficulty in understanding the reason: the deviation necessarily leads to death. But now, in comparison, take the case of a child born blind, or deaf and dumb. Here there is no intrinsic reason why life should be shortened; but in a severe competition, if the individual depended entirely on his own exertions, he might be, probably would be, starved or trampled to death before he had lived very long. I think it is of some interest and importance to know of any given character or deviation, whether it is intrinsically harmful or beneficial, extrinsically so *i.e.* in the struggle for existence and reproduction, or quite indifferent.

Prof. Weldon is silent, to some extent, about the cases which tell against the idea of selective destruction. He found that deviations in *Aurelia* were as numerous in the adult as in the Ephyrae. He told me in conversation, and did not say it was in confidence, that he abandoned some experiments on the selection of *Daphnia*, because he found that the mere fact of keeping a large number in the same water caused a progressive disappearance of a certain conspicuous gene. His investigations also entirely ignore the diagnostic value of the characters he deals with. It seems to me that a more valuable result would be obtained if a parallel investigation were made of two characters—one obviously diagnostic, the other obviously adaptive. Such characters could be found in a swimming crab.

But above all, what we want is a comparative investigation of the results of selection without change of conditions, and of change of conditions without selection. I began, not long ago,

to try to inaugurate a society for carrying on a thorough investigation of this kind, but have not at present received enough support to carry out the scheme. The method of the investigation is fairly obvious and not difficult, but the difficulty is to get the money and the time to carry it out. I differ from Prof. Weldon in thinking that the questions raised by the Darwinian hypothesis are not purely statistical, but experimental, and I agree with Mr. Thiseleton-Dyer—that to talk of experimentally checking the hypothesis by the statistical method is a contradiction in terms.

J. T. CUNNINGHAM.

Cleethorpes, March 15.

## A True Spectrum Top and a Complementary One.

To make a true spectrum top—which is not copyright, so far as I know—take a disc of white paper, and one of black, of equal size. Spin the white one on a disc of cardboard mounted on a nail, and while it is spinning draw a small brush well charged with lamp-black water-colour paint, steadily and not too slowly from centre to circumference of the disc, thus describing a spiral line. Make a radial cut in each of the discs, and after interlocking them as in the well-known colour discs, place them on the top. We thus obtain a top in which the lines are spiral, and the relative sizes of black and of white areas are easily regulated by turning one disc to right or left, while the other is held still. If the lines be not too thin or too thick, and not too near together, and if the relative areas of black and white be adjusted suitably to the light, the top exhibits, when spun, broad bands of colour, each band containing all the colours of the spectrum in their natural order. The spaces between the lines should be not less than five times as broad as the lines themselves. The brightest effects are produced in my own case, by lamplight, with the areas of light and dark almost equal; by daylight, with the dark area about three times as great as the light. Other proportions, however, seem to give better results with other people.

A "complementary top," yielding colours complementary to those of the spectrum (*i.e.* the colours of mother-of-pearl) in a continuous band ranging from lemon-yellow, through puce to electric-blue green, is made in the same way, except that the spiral line is to be drawn in white on the black disc.

In both cases the colours are somewhat dilute, but the proper regulation of the relative areas of black and white reduces this defect very considerably, and I have obtained bands on my spectrum top brighter and purer than any which I could get by painting a spectrum with colours on paper.

I communicate this description before my experiments are complete, in order to prevent anyone who may make the same discovery, from obtaining a copyright for the design of either these tops or of earlier ones which I made, in which one half the disc was black and the other white, with a white spiral on the black, or a black spiral on the white, or with both at different distances from the centre on the same top. Anyone who wishes to do so may make as many tops or lantern-discs as he chooses from the above description, provided he does not attempt to hinder anybody else from making or selling similar ones.

C. HERBERT HURST.

Owens College, Manchester, March 24.

## A Foucault Pendulum at Dublin.

It may perhaps interest some of your readers to learn that Foucault's pendulum experiment has recently been performed in Trinity College, Dublin, with complete success.

Immediately under one of the glass domes, by means of which the hall of the New Building is lit, a cast-iron bar was securely bolted, which terminates in a cylindrically-shaped piece of metal the axis of which is vertical. Into this cylinder a steel plug was inserted, which was drilled to receive the upper end of the wire supporting the bob, which was fitted with a screw. By placing the upper end of the wire in this position, Prof. Fitzgerald and I secured a length of 45 feet for our pendulum; but, under the circumstances, we were unable to use the same weight as that adopted by Sir R. Ball when making the experiment, viz. 300 lbs., and were obliged to content ourselves with a bob weighing 16 lbs., which, however, answered admirably.

The experiment is made in the following manner: About two feet behind the position of equilibrium of the bob, we place the electric lamp, and at a suitable distance in front a lens, so

arranged that when the bob is swinging, and in the position of maximum amplitude nearest the lens, the shadow of a portion of the wire immediately above the bob, thrown on a screen some 32 feet distant, is clear and distinct, and coincides with a vertical black line thrown on the white screen.

The bob is drawn back towards the lamp about eight inches, by a loop of thread, and when we wish to experiment the thread is then burned in the usual manner.

When the pendulum completes its first oscillation, the shadow falls exactly on the black line traced on the screen. In about five minutes the shadow has moved to the left of the line, and in ten minutes conspicuously so. In this time the maximum amplitude has decreased so little that the image on the screen is still distinct and clear when the pendulum is in a position nearest the lens.

W. R. WESTROPP ROBERTS.

Trinity College, Dublin.

Snake Cannibalism.

HAVE read with interest the numerous accounts of snake cannibalism which have lately appeared in NATURE. During my residence in South Africa, I have come across several instances of a similar nature. A few weeks ago I received a large roughals (*Sepdon hemachate*) which had swallowed another one of the same kind and of nearly its own length. As the swallowed individual was too long to disappear completely before the front portion of its body was digested, its tail was sticking out of the mouth of the swallower by about six inches. I have dissected two yellow colras (*Naja haji*), each of which had swallowed a puff adder (*Viper arietans*) more than three feet long. This case is very interesting, as the puff adder has much larger fangs than the yellow cobra, and in a fight the latter would probably succumb. To mention only one more case, I received, some years ago, the skins of a cross-marked schaapsticker (*J ammophilis crucifer*) and a spotted schaapsticker (*Psammophilax rhombatus*), the former of which had swallowed the latter. In all cases which have come under my personal observation the swallowed snakes had entered head first, and thus probably they were simply drawn in after having caught hold of the same prey as the swallows. In conclusion, I may mention that cases similar to the above are frequently described in the South African newspapers.

J. SCHONLAND.

Grahamstown, South Africa, March 1.

American Fresh water Sponges in Ireland.

A SHORT time ago, Dr. R. F. Scharff, Dublin, sent me a small collection of Irish Spongillidae. The examination of the material resulted in the discovery of two or three American species, obtained from the West of Ireland, viz. *Heterogeneitya isleri*, Potts, *Tubella pennsylvanica*, Potts, and (?) *Ephydatia craterifermis*, Potts, the first of these three species having been identified by Dr. W. Weltner, Berlin. All these species are new to Europe, and as they were found in a small collection taken more or less at random, it is probable that if the fresh-water fauna of the West of Ireland were thoroughly investigated, a great many more American species would be discovered.

Details will be published in the May number of the *Irish Naturalist*.

R. HANITSCH.

University College, Liverpool, March 13.

Peripatus in the West Indian Islands.

WEST INDIAN records show that occasionally single specimens of various species of Peripatus have been found in the different islands. During the past week, Mr. Lunt, my assistant, found a single specimen, and a further search being organised, resulted in the capture, by two collectors, of fifty specimens. These, it is believed, belong to two different species, and a goodly number of the specimens have been sent for determination to the British Museum.

Either the animals are more numerous than usual, or the previous search for them has not been a very careful one, as the whole of our specimens were found within the precincts of the Gardens.

J. H. HART.

Royal Botanic Gardens, Trinidad, March 6.

Planetary Photography.

I UNDERSTAND that in photographing a planet, such as Mars, only a short exposure can be allowed, because there is no way of compensating the planet's axial rotation. But, while following the planet with the equatorial, would it not be possible to compensate this axial movement by slowly sliding the plate, so that certain features of the planet should fall always on the same parts of the plate? If this is so, an exposure of some length might be available for the more central portions of the disc, those portions for which, during the interval, no serious alteration due to foreshortening comes into play.

Cardiff, March 23.

C. T. WHITMELL.

Cleaning Tobacco Pipes.

I HAVE discovered a new method for cleaning pipes which have become foul. A shallow cork, through which a hole is bored large enough to enable it to fit tightly on to the nozzle of a soda-water syphon, is fitted into the bowl. The nozzle is inserted, the mouth-piece directed into a vessel, about a wine-glassful of soda-water forced through, and the pipe is clean!

This is not a scientific discovery, but it may be of use to those scientific men who are smokers. Rubber stoppers answer better than corks.

Cecil CARUS-WILSON.

THE HABITS OF LIMPETS.

SOME observations made by the present writer at the Scottish Marine Station during July 1884, were published in NATURE for January 1, 1885. These observations confirmed the statements previously made by various naturalists, from Aristotle onwards, that the common limpet (*Patella vulgata*) settles down on some eligible spot (its "scar") between tide-marks, and makes a home, to which it returns after having been out to feed. The conclusion was drawn from various data that this "locality sense" is independent of smell, sight, and touch so far as the head-tentacles are concerned. Prof. Lloyd Morgan, in a letter to NATURE ("Homing of Limpets," December 6, 1894), has shown that the limpet possesses an even greater power of "homing" than previous observers have suspected, and he believes that the head-tentacles are the sense-organs concerned.

Since 1884, I have made further notes, and aided by a grant from the Research Grants Committee of the Royal Society, to whom my best thanks are due, have pursued the subject with some care during the past year. The results, apart from those connected with histology, here follow.

The limpets observed live on a reef, which extends several hundred yards seawards (practically west) from the front of Aberystwyth College. The rocks are Silurian grits and imperfect slates, alternating in a very regular way, striking north and south, and tilted at high angles. At low tide the *Laminaria* zone is well exposed, and for some yards above this the rocks are somewhat bare, except that they are thickly encrusted with small *balani*. Nearer the land various brown seaweeds (mostly *Fucus serratus*, *F. vesiculosus*, and *Ozothallia nodosa*) thickly cover the reef, except towards high-water-mark, where they become scanty. Throughout this area limpets of all sizes abound, being specially numerous, however, on the barnacle-encrusted rocks above mentioned. Groups of them were here marked with enamel paint, and watched. A number of observations were also made on the small limpet, which lives on *Laminaria*, and has its shell marked by three diverging blue streaks (*Helicon pellucidum* = *Patella pellucida*).

*Food and Feeding.*—As before, the chief food noticed consisted of the minute alga coating the *balani* and rock-surfaces. Specimens were also found feeding on the calcareous seaweeds *Corallina* and *Melobesia*, on *Fucus*, and on *Laminaria*. It was suggested in the previous notes that the great length of the radula is perhaps

connected with the large amount of wear and tear entailed by the constant "scraping" of barnacles, &c. This appears to be confirmed by comparison with *Helcion*, in which *Laminaria* constitutes the chief, if not the only, food, and in which the radula is relatively somewhat shorter.

At Granton, in July, the larger limpets appeared to feed most frequently; but at Aberystwyth, during the cooler months, the small individuals are far more active. Sheltered corners and warm days afford the best chance of watching the movements. Tough limpets undoubtedly require their scars, or secure places, as the tide advances, I am inclined to think they must also often feed when covered by the water, for (1) the finest specimens are found low down, and their time for feeding when uncovered is limited; (2) I have seen a small limpet feed on *Corallina* in a tide-pool.

The scraping sound heard on the rocks during warm weather is not entirely due to feeding limpets. *Purpura lapillus* is also busy at work "sawing out" *balani* from their shells.

*Locality-Sense.*—I still think, *pace* Prof. Lloyd Morgan, that the head-tentacles are not indispensable to homing, though it must be admitted that they may commonly help in the process. One limpet observed homing by me, certainly seemed to be "feeling" its way along by means of these organs, which were extended and waved about and applied to the rock from time to time, not by the extreme tip only, but also laterally for about  $\frac{1}{4}$  of an inch from this. This individual was No. 2 of a small group living among the barnacles, and kept under observation from November 26 till the present time. The dimensions of these limpets are as follows:—No. 1,  $\frac{1}{16}$  ×  $\frac{1}{8}$ ; No. 2, ditto; No. 3,  $\frac{1}{16}$  ×  $\frac{1}{8}$ ; No. 4,  $\frac{1}{16}$  ×  $\frac{1}{8}$ ; No. 5,  $\frac{1}{16}$  ×  $\frac{1}{8}$ . On November 28, at 3:15 p.m., I found No. 2 feeding  $\frac{1}{2}$ " from its scar. About half of each tentacle was excised, *i.e.* the part previously noticed "feeling", and the animal was replaced where found. On November 29, at 2:55 p.m., it was found back on its scar. A similar operation was performed on No. 5, found feeding  $\frac{1}{2}$ " from its scar, on December 12, at 3:15 p.m. On my next visit, at 2:55 p.m. on December 14, the animal was found to have regained its scar, which, by-the-by, is permanently submerged, being in a small tide-pool. It is true the tentacles were not entirely removed, as was the case with the two Granton limpets which homed after excision. It now appears to me probable that the *mantle-tentacles* may help in homing. These are small conical structures lodged in pits in the mantle edge (Harvey Gibson, *Trans. R.S. Edin.* 1885), and capable of retraction and extension. About 100 of them are present. In submerged limpets I have seen these tentacles protruded for about  $\frac{1}{4}$ " beyond the margin of the shell, and executing active "feeling" movements. These were particularly noticeable in an individual which, having regained its scar wrong end on, was shuffling round into the right position. When the front end of the limpet came to point in the right direction, one side of the shell was lowered, and the mantle-tentacles on that side were withdrawn; the same events then happened on the other side. These tentacles appeared to be of two kinds, longer and shorter, the latter being two or three times as numerous. Prof. Herdman first suggested to me that the mantle-tentacles might have to do with the locality-sense, and it at any rate appears probable that they are concerned with accurate adjustment on the scar. It is worth noting that very small limpets home as well as large ones, *e.g.* No. 5 above, and much smaller ones which have fallen under my notice. Prof. Lloyd Morgan's observations, so far as they refer to knowledge of local directions, which limpets possess, are confirmed by an experiment in the case of No. 1. On December 16, at 4:5 p.m., the animal was busy scraping barnacles  $\frac{1}{2}$ " west of its

scar. It was removed and placed 10 inches from home, near the top of a nearly vertical barnacled surface (on which it had been seen feeding at 3:15 p.m., November 28), which rises north of its scar. The next visit was deferred till December 26, 12:25 p.m., when the limpet was at home.

The homing faculty is not confined to *Patella*, but is also possessed by *Helcion pellucidum*. This fact is new, so far as I am aware. The animal in question eats out a sheltered home in the bulb, or more rarely in the stalk of *Laminaria*, and wanders out from this along the thallus, rasping a "track" as it goes. I found, for example, one individual at the end of an "eaten road" 3 inches long, and at the other end a very snug dwelling-place drilled out in the side of the stalk. *Helcion* mostly feeds under water. Like *Patella*, it possesses mantle- as well as head-tentacles.

The object of homing appears to be protection from the assaults of the incoming or outgoing tide. There is no danger when the animals are completely covered or uncovered. In many cases the barnacles would otherwise completely cover the rock, and afford very insecure foothold. Once washed loose, a limpet presents a very large surface liable to injury, unlike its neighbour *Purpura lapillus*, which, withdrawn into its thick operculated shell, can stand a good deal of knocking about. The force with which limpets adhere is illustrated by the fact that the five small limpets to which allusion has been made were quite uninjured by the terrible gale and high sea of December 21 and 22, to which they were fully exposed. The much thinner shell of *Helcion* is explained by the sheltered position of its home. The depressed conical shape of a limpet-shell is probably better fitted than any other to resist the waves, but this statement is made under correction.

*Formation of, and Adhesion to, Scars.*—An examination of the 'tween-tide rocks at Aberystwyth would readily convince the most sceptical as to the power which *Patella* possesses of excavating depressed scars. Limpets are able to adhere very tightly to a smooth surface which is much smaller than the foot, and by examination of such cases, and of specimens allowed to fix themselves to a piece of plate-glass, I have come to the conclusion that fixation is neither due to secretion of a glutinous substance, nor to the formation of a vacuum under the foot. It appears, in fact, to be a case of "adhesion," like that between two smooth glass surfaces brought very close together. The muscular foot is, so to speak, rolled out on the rock, with which it is thus brought into close contact. Prof. Michael Foster suggested to me the possibility of this method of explanation, which is most probably the correct one.

J. R. AINSWORTH DAVIS.

#### TERRESTRIAL HELIUM.

WE have received the following statement from Prof. Ramsay:—

"I have been trying for clues to compounds of argon. Mr. Miers, of the British Museum, called my attention to Hillebrand's paper on Cleveite, a rare Norwegian mineral, which Hillebrand said gave off 2 per cent. of nitrogen on warming with weak sulphuric acid. Cleveite consists chiefly of uranate of lead, with rare earths. My idea was, if the so-called nitrogen turned out to be argon, to try if uranium could be induced to combine with argon.

"The gas, on sparking with oxygen in presence of soda loses a trace of nitrogen, probably introduced during its extraction; the residue consists of a mixture of Argon and Helium! The brilliant yellow line, of which Mr. Crookes makes the wave-length 587.49, is identical with the Helium line. I am collecting the gas, and shall shortly publish regarding its properties."

## NOTES.

THE Bakerian Lecture will be delivered before the Royal Society on Thursday, May 9. The research upon which the lecture is to be based has been conducted by Messrs. A. Vernon Harcourt and William Esson, and the title is announced as "The Laws of Connection between the Conditions of a Chemical Change and its Amount."

AN abstract of the paper in which M. Berthelot describes his investigations of chemical combinations with argon, will be found in our report of the meeting of the Paris Academy of Sciences (p. 527).

PROF. ADOLPHE CARNOT has been elected into the Paris Academy of Sciences, in the place of the late M. de Lesseps.

THE late Mr. William Bolitho, of Gulval, Cornwall, has bequeathed £500 to the Geological Society of Cornwall, the income of which sum is to be applied each year in "the production of a gold or richly-gilded silver medal, to be presented to the member of the Society whose attainments, labours, or discoveries in geological or mineralogical science are found most deserving." He has also left a like sum for the Penzance Library.

THE death is announced of Mr. E. Turner, Chairman of the Council of the Sanitary Institute.

WE also notice the death of Dr. E. D. F. Meissel, at the age of sixty-nine. He made a number of important contributions to mathematical astronomy, and his tables of Elliptic Functions, as well as the table of Bessel's Functions, published in the *Abhandlungen* of the Berlin Academy, stand as examples of his work.

MR. H. H. HAYTER, C.M.G., the well-known statist, died at Melbourne last week. He was the first president of the economic and social science section of the Australasian Association for the Advancement of Science. His numerous and valuable statistical publications earned for him the honorary membership of statistical societies in various parts of the world.

DR. CANINI, of Leghorn, a well-known Italian specialist in diseases of children, who died recently, has, says the *British Medical Journal*, bequeathed his entire estate, amounting to 2,300,000 lire (£92,000) for the foundation of a hospital in which poor children suffering from diphtheria may have the advantages of the serum treatment gratuitously.

WE take the following news from the same source:—The late Dr. Alfred L. Loomis, of New York, has left real estate to the value of 400,000 dollars (£80,000), and personal property amounting to 600,000 dollars (£120,000). The income of 25,000 dollars (£5000) is given to the Loomis Laboratory, and whatever part of the income is not used is to be paid to the Professor of Pathology of the University of New York. A sum of 10,000 dollars (£2000) is bequeathed to the New York Academy of Medicine, the bequest to be known as the Loomis Entertainment Fund, and the interest to be used in providing entertainment for the Fellows of the Academy.

M. NILS EIKHOLM, who was at the head of the Swedish astronomical and meteorological expedition for observing the transit of Venus in 1882, has accepted a place in the Andree balloon, which is to start from Spitzbergen for the North Pole in July 1896. The ascent is to take place from Norskoarna, the distance from which to the North Pole is about 600 miles. But it is not expected that the balloon will travel in a direct line. M. Andrée will visit France in July next, and he will

probably be present at the Ipswich meeting of the British Association.

DR. M. A. VEEDER writes: "In the table of 'Days with maximum temperature not over 32° at Greenwich,' on page 174 of NATURE (February 28), the curve rises sharply and decidedly at intervals of exactly twelve years—namely, in 1854, 1866, 1878, and 1890. These years also fell in the well-known period of sun-spot and auroral minimum, but did not comprise the entire periods of such minimum in each case. There seems to be a clue here that is important, and that is in a line with the study of current phenomena of this sort in which I have been engaged, some of the results of which were presented in a paper entitled 'Periodic and Non-Periodic Fluctuation in the Latitude of Storm Tracks,' read at the Chicago Congress of Meteorology in 1893."

THE following are among the lecture arrangements at the Royal Institution, after Easter:—Prof. George Forbes, three lectures on "Alternating and Interrupted Electric Currents"; Prof. E. Ray Lankester, four lectures on "Thirty Years' Progress in Biological Science"; Prof. Dewar, four lectures on "The Liquefaction of Gases"; Dr. William Huggins, three lectures on "The Instruments and Methods of Spectroscopic Astronomy" (the Tyndall Lectures); Mr. Arnold Dolmetsch, three lectures on "Music and Musical Instruments of the Sixteenth, Seventeenth, and Eighteenth Centuries: 1. English; 2. French; 3. Italian" (with illustrations upon original instruments). The Friday evening meetings will be resumed on April 26, when a discourse will be given by Dr. John Hopkinson, on "The Effects of Electric Currents in Iron on its Magnetisation." Succeeding discourses will probably be given by the Earl of Rosse, Veterinary-Captain Frederick Smith, the Hon. G. N. Curzon, M.P., Mr. J. Viriamu Jones, Prof. Alfred Cornu, and other gentlemen.

A STRONG earthquake shock was felt at 1.16 p.m. on Saturday last at Comacchio, in the province of Ferrara, Italy. Several houses and a church were slightly damaged. At Mirabella Imbaccari, in the province of Catania, in Sicily, the earthquake caused the collapse of a building.

DR. B. BRAUNER, Professor of Chemistry in the Bohemian University, Prague, suggests to us that argon possibly exists in nebulae. He points out that a strong argon line, measured by Mr. Crookes, has practically the same wave-length as the chief nebula line, and thinks that the line at  $\lambda$  3729.8 in the "blue" spectrum of the new substance represents the line at  $\lambda$  3730, found in the spectra of nebulae and white stars.

HERR W. SIEBE has started on a botanical exploration of Asia Minor, with the special object of making collections of the almost unknown flora of Cilicia Trachea. Setting out from Cyprus, he proposes to visit Mersina in southern Asia Minor, proceeding then to the Kalykadnos Valley and the adjacent mountains, the steppe-district of Konia, the maritime district of Egerdir, and finally, in the summer, the elevated alpine region of Geigldagh.

A STORM of unusual severity passed over these islands on Sunday last. At 5h. a.m. on that day it was central over the south of Ireland, and by 6h. p.m. of the same day the centre had reached Denmark, having traversed a distance of 600 miles in ten hours, which gives an average rate of progress of sixty miles an hour. Much damage was done to life and property over the whole country; but its greatest violence was felt over the southern and midland counties. The maximum force at Greenwich was at 2h. 20m. p.m., when the anemometer registered a

pressure of 1000 lbs. on the square foot, which is equivalent to an hourly velocity of eighty-five miles. Thunder and lightning occur at all places in the rear of the disturbance.

The plan of a great free public library in New York City has a peculiar shape, and been adopted by the several persons and boards of trustees interested. It contemplates the union of the Astor, Lenox, and Tilden funds, aggregating \$10,000,000. The site of the library is not yet determined, owing to some restrictions on the use of the block facing Central Park, in which the Lenox Library now stands. This site is preferred if available. Boston, with its 5,000,000 dollars free library, not completed, has already taken the lead. Brooklyn has in the library of the Pratt Institute the nucleus of an admirable free library, for which a new building is nearly ready.

We are glad to learn of the continued growth and development of the Brooklyn Institute, due in great measure to the stimulus imparted by the Brooklyn meeting of the American Association for the Advancement of Science last summer. Since that time the membership of the Institute has increased many hundreds, bringing it up to very near four thousand, and making it one of the largest scientific associations in the world. Plans for a new building and museum, to cost several million dollars, have been for some time ready, and only await funds. Probably work will begin during the present season. The site is secured, and it is hoped that aid from the city will be obtained as soon as the condition of finances justify it. Meanwhile the Institute, in its geographical section, is foremost in promoting far-reaching plans of exploration toward both poles. Besides the arctic expedition mentioned in NATURE last week (p. 488), a well-digested plan for antarctic exploration has been presented by Dr. Fred. A. Cook, who is already familiar with travel in the north. He proposes to start next September, equipped for a stay of three years, but with the intention of returning in two years unless accidentally detained. It seems probable that the expense of the expedition will be provided for, and that it will be the best equipped that has ever ventured into that region.

In the February and March numbers of the *Geological Magazine*, Miss Agnes Crane gives an account of the results of recent research on the geological distribution of the Brachiopoda, and their bearing on the evolution of the group. The simple *Paterina* of the Cambrian is regarded as the actual root-stock of the group, and the descent of the chief lines is traced from it, with some breaks here and there from imperfection of knowledge. According to Beecher, almost all Brachiopoda pass through a "paterine" stage of development. *Lingula*, which in the proper generic sense does not occur below the Ordovician stage in its development through a stage in which it resembles its predecessor *Obolus* of the Cambrian, and the latter is said to have a transient "paterine" stage. *Zonitoides* is also stated to pass through a "linguloid" stage, yet its branch is not regarded as derived from *Lingula*, but independently from *Paterina*. Numerous other genera are dealt with, and the paper is illustrated by two plates, one giving the genealogical tree of the Brachiopoda, and the other some examples of the relation of forms.

There is an interesting note in the *Fulletin* of the Royal Gardens, Kew, on the use of green glass in plant-houses. The use of glass of a green tint has been for half a century a characteristic peculiarity of the plant-houses at Kew, having been adopted in 1845-46 on the recommendation of Mr. Robert Hunt, F.R.S., on the ground that while admitting light and chemical power in the same proportions as white glass, it would prevent the passage of those rays which produce scorching. Recent investigations have, however, shown that the

green glass used at Kew intercepts about one-half of the effective influence of ordinary sunlight on the processes of plant-life. Of late years the increasing haziness of the sky, due to the smoke produced by the rapid extension of London to the south-west, has produced the same effect at Kew as the use of green glass; and it has become obvious that in the future the plant-houses must be so constructed as to exclude as little of the available sunlight as possible. Since 1886 the use of green glass has, therefore, been discontinued in all the houses except the fern-houses and the palm-house; and, it having been proved by experiment that even filmy ferns thrive better under white than under green light, if direct exposure to the sun is excluded, the use of green glass will now be altogether abandoned at Kew.

THE action of light in producing an electric discharge through a vacuum tube has been further investigated by Messrs. Elster and Geitel, who communicated some very suggestive results to the Berlin Academy at a recent sitting. They used a "photo-electric cell," consisting of an exhausted glass globe with an anode of platinum wire and a cathode of an alloy of sodium and potassium in equivalent proportions, which is liquid at ordinary temperatures. This alloy was illuminated by a beam of white light from a piece of zircon rendered incandescent by an oxy-coal gas blow-pipe flame. This was condensed and made parallel, and then sent through a Nicol prism so as to polarise it in a certain plane. It was then found that a current passed through the cell on connecting its terminals with a battery giving some 400 volts. The strength of this current depended very much upon the angle of incidence and upon the plane of polarisation. It was greatest when the plane of polarisation was perpendicular to the plane of incidence, *i.e.* when the electric displacements constituting light took place in the plane of incidence, and when the angle of incidence was about 60°, *i.e.* the polarising angle of the alloy itself. The phenomena have probably some connection with the fact discovered by Quincke, that light polarised normally to the plane of incidence penetrates furthest into metallic sheets.

OF late years' the transmission of electricity through gases has been attracting a considerable amount of attention, and numerous papers have appeared dealing with this subject, one of the last being by G. Vincentini and M. Cinelli. Their paper, which appears in the *Nuovo Cimento* (3) vol. xxxvi., deals with the transmission of electricity through the gas surrounding a wire heated to redness by an electric current. The authors first describe experiments they have made on a long platinum wire surrounded either by air or carbon dioxide. The wire was protected from draughts by a series of screens, and a movable platinum electrode, connected to a quadrant electrometer, gave the potential of the air at different distances above and below the heated wire. It was found that the potential assumed by the electrode connected to the electrometer was higher than the mean potential of the heated wire. When the current passed through the wire was sufficiently intense to heat it to incandescence, the potential of the insulated electrode when placed above the wire did not vary with the distance from the hot wire to any sensible extent, only the maximum electrification was attained at different times after starting the current, and the greater the distance from the hot wire the greater the time which elapsed before the steady state was reached. When, however, the insulated electrode is below the incandescent wire, the difference of potential decreases very rapidly with the distance, so that at 15 m.m. it almost vanishes. In order to carry on observations on other gases besides air and carbon dioxide, the authors have devised a modified form of apparatus in which the incandescent wire is placed inside a globe which is silvered on the inside. This globe has four tubuli, two of which serve for the introduction of the electrodes for the hot wire; while of the remaining two, one admits the insulated electrode, and the other a wire which is connected to



the silver coating of the globe, and serves to put this to earth. The authors consider that their experiments show that the gaseous molecules which leave the surface of the incandescent platinum wire in the case of hydrogen are positively electrified, their potential being about 0.25 volt higher than the mean potential of the incandescent wire. In the case of air and carbon dioxide the increase above the mean potential of the wire is about one volt. With hydrogen at a somewhat high temperature an inversion of the phenomenon takes place, since the potential of the insulated electrode becomes less than the mean potential of the wire.

A NEW phototheodolite is described by Herr O. Ney in the *Zeitschrift für Instrumentenkunde*. The novel feature about it is the geometrical clamp, which enables the surveyor to exchange the telescope and the camera on the stand with ease and accuracy. Both are provided with three spherical feet, which rest in a hole, a slot, and a plane respectively, made of hard steel, and fixed on the stand. This seems an admirable way out of the difficulty attending the simultaneous use of telescope and camera. Other instrument-makers combine the two by mounting a telescope at the side of the camera, with a counterpoise on the other side. In one instrument the telescope lens is also used for photographic purposes. But these instruments are either too small, or the adjustment is exceedingly unstable. In Ney's phototheodolite, which is made chiefly of aluminium, provision is made for securing the camera or the telescope on the stand after it is mounted in the hole-slot-and-plane clamp, and also for the constancy of the position of the sensitive plate. With these improvements, the instrument is likely to become a most valuable aid to surveying practice.

DR. C. G. DE DALLA TORRE'S useful "Catalogus Hymenopterorum" continues to make satisfactory progress. It is proposed to complete it in ten octavo volumes, exclusive of bibliography and index, which will form a separate volume; and five volumes have already been published, including vol. 1, *Tenthredinidae* and *Uroceridae*; vol. 2, *Cynipidae*; vol. 6, *Chrysididae*; vol. 7, *Formicidae*; and vol. 9, *Vespidæ*. The remaining families may be expected to follow shortly. The subject of entomology is so vast that little progress can be made without some entomologist from time to time devoting his life to the compilation of these great key-catalogues, which are landmarks in the study of the orders of which they treat, and stand towards them in the same relation as a dictionary to a language. Moreover, such catalogues involve an amount of patient and unremitting toil that no one can appreciate who has not himself experienced it; they are frequently published at a heavy pecuniary loss, and are peculiarly liable to criticism, which may be fair and friendly in tone, or may be just the reverse. Let us hope that Dr. Dalla Torre's labours will meet with the encouragement which he deserves from the hymenopterists, whose labours he has so much contributed to lighten.

THE discovery of the use of fire dates back to the very dawn of human intelligence; therefore the study of the rites and ceremonials which are found among every race in connection with the lighting of new fires, furnishes important facts for the discussion of the primitive history of human culture. But before it is possible to apply comparative methods of treatment to the subject, exact observations are required of the details of the new fire ceremony, wherever it survives, especially in less modified, savage, or primitive peoples. This requirement is fulfilled by an article, by Mr. J. W. Fewkes, descriptive of the new fire ceremony as it exists among the Pueblo Indians of Tusayan (*Boston Soc. Nat. Hist.*, vol. xxvi. pp. 422-458, Feb. 1895). Mr. Fewkes watched two such observances of the Tusayan Indians, one in 1892, and the other in 1893. In both years active ceremonials began on November 13, and continued five days. Two

other days, November 8 and 9, were devoted respectively to "smoke assembly" and "official announcement," and November 18, when all serious ceremonials had ceased, was a general holiday. On each of the five days, from November 13-17, various processions and rituals were observed, in many of which the element of phallic worship plays a not inconspicuous part. It is unnecessary to describe these performances, but one or two remarkable points in connection with the dates on which they take place, are of interest. The Tusayan Indians, says Mr. Fewkes, can neither read nor write, and are ignorant of our almanacs and calendars, nevertheless they manage to make the performances commence on the same date, within a day or two, every year, the time of year being obtained by observation of the stars. Another instance of the astronomical knowledge of such rude people as the Tusayan Indians, is afforded by the fact that the culmination of the Pleiades is used to determine the proper time for the beginning of certain rites. This is a further example of the widespread use of the Pleiades for the determination of the time for the celebration of primitive rites and ceremonials.

IT may interest our readers to know that a catalogue of the more important books published in Denmark and Norway during the year 1894 can be obtained from the Skandinavisk Antiquariat, 49 Gothersgade, Copenhagen. The catalogue contains the titles of a number of important works on various branches of science.

A NEW volume, containing the Biological Lectures delivered at the Marine Biological Laboratory, Woods Hole, in 1894, will shortly be published by Messrs. Ginn and Co. The lectures cover a wide range of subjects, most of which are prominent questions at the present time, and all of which are of special interest to teachers and students of biology.

MR. R. F. STUART, the new Director of the Meteorological Service of Canada, has commenced the publication of a monthly weather map, showing the mean temperature and the difference from the mean average temperature, also total rain and snow-fall for the month, and depth of snow on the ground on the last day of the month. It is interesting to note that an extremely cold spell prevailed over Ontario in the early part of February, some of the low readings being almost unprecedented.

MR. H. W. WILEY, the chemist to the United States Department of Agriculture, recommends the cultivation of the cassava, *Manihot utilisima*, in the most southerly of the United States. It furnishes an excellent food for men and for cattle; though, from the small proportion of nitrogen which it contains, it cannot take the place of bread-stuffs. A very good kind of tapioca may be made from it. The yield, in sandy soils, is from four to five tons per acre.

A COLOURED map, showing the density of the population of Ireland at the Census of 1891, has been prepared and published by Mr. E. E. Fournier, Bray, Ireland. The map exhibits at a glance the density of the population, and shows clearly that some of the oldest railways have had a beneficial influence in preserving or increasing the population of the districts through which they run. It is the first of a series intended to exhibit graphically the physical, social, economic, and religious features of Ireland.

"THE Statesman's Year-Book" (Macmillan and Co.)—that handy compendium of statistical and historical information relating to all the States of the world—has attained its thirty-second year of publication. Edited by Mr. J. Scott Keltie, with the assistance of Mr. I. P. A. Renwick, the volume is a standard work of reference in which the man of business can find the commercial statistics he needs, to which the politician can apply for trustworthy statements, and from which the

student of geography can obtain the latest geographical information.

DR. A. L. MEYER, of the Royal Zoological Museum at Dresden, has sent us a description of two new birds of paradise from New Guinea. (*A. N. u. Ber. d. K. Zool. u. Antiv.-Ethn. Mus. Dresden*, 1894-95, No. 5). One of the birds, shown in its natural size in one of the two coloured plates which illustrate the paper, possesses remarkable characteristics in the colour and colour of its plumage, and in the arrangement of two very long feathers which stretch out from the head to about twice the length of the body of the bird. This bird has been named *Paradisæa alberti* in honour of King Albert of Saxony, and the second one described and figured by Dr. Meyer has been called *Paradisæa caroline*, after Queen Caroline.

THE seventh volume of the *Proceedings* of the Royal Society of Victoria has reached us. The volume contains twenty-eight papers, many of them illustrated with plates, communicated to the Society during 1894. With two or three exceptions, the papers belong to the domain of natural science. Among the contributions we notice one on Tasmanian earthworms, by Prof. Baldwin Spencer, and a note, by the same author, on two new forms of marsupials obtained in Central Australia, during the visit of the Horn Scientific Expedition to the Macdonnell Ranges. The geology of Castlemaine is described by Mr. T. S. Hall, and geological notes on the country between Strahan and Lake St. Clair, Tasmania, are contributed by Messrs. Graham Officer, L. Balfour, and E. G. Hogg. The older tertiary rocks of Maule, and the paleontology of the older tertiary of Victoria, form the subjects of two separate papers, and a catalogue of non-calcareous sponges collected in the neighbourhood of Port Phillip Heads is given by Prof. A. Dendy. Mention must also be made of a paper, by Mr. R. H. Mathews, on rock paintings and carvings figured by the Aborigines of New South Wales, in caves and rock shelters; and also of one in which Mr. E. F. J. Love gives the results of observations with Kater's invariable pendulum, made at Sydney. The object of his investigation was to throw some additional light on the question of the difference between the values of  $g$ , at Melbourne and Sydney. A comparison of the results obtained by the United States Coast Survey officers at Sydney in 1883, with those obtained by Mr. Baracchi at Melbourne in 1893, has shown that a pendulum bearing seconds approximately should lose 8.55 in a year, per day, if transferred from Melbourne to Sydney. Lord Kelvin found, however, by swinging three of his standard pendulums at the two places, that the loss was 13.78 in a year, per day. Mr. Love comes to the conclusion that the difference between the vibration numbers at Melbourne and Sydney is 12.2 per day.

THE following are the Zoological Society's Gardens during the last week in March: Sand Badger (*Miles australis*) from Japan, presented by Mr. Frederik Ringer; two Polar Bears (*Ursus maritimus*), from the Arctic Regions, presented by Mr. John L. Hutton; Spotted Hyena (*Hyena crocuta*, juv.), a Verreaux's Sea Otter (*Lutra verreauxi*), a Black Kite (*Eurypyga melanoleuca*), from East Africa, presented by Mr. T. E. Pennington; a Black-faced Piping Crow (*Gymnorhinus melanurus*), from Australia, presented by Mr. J. D. Haggard; Raven (*Corvus corax*), Black, presented by Mr. W. Murray; a Bushy-tailed Woodrat (*Rattus*), from East Africa, presented by Dr. A. Thomson Smith; a Chimpanzee (*Pan troglodytes*), from West Africa, a Mountain Marmoset (*Myiomerops*), from South-east Brazil, and a Purple-breasted Flycatcher (*Myiophobus*), from Malaya; a Blue-faced Honey-eater (*Anthracoceros*), from Malaya, and a

OUR ASTRONOMICAL COLUMN.

THE MOON AND ATMOSPHERIC WAVES.—Lunar atmospheric waves, or air-tides, as they might be called, can, according to M. Bouquet de la Grye, be distinctly traced in the records of barometric pressure collected at insular stations or stations situated close to the sea, where there are no powerful local disturbances to obscure them. In a contribution to the *Annuaire du Bureau des Longitudes*, he reproduces curves of atmospheric pressure traced at Brest, St. Helena, Cape Horn, Batavia, and Singapore, which distinctly show a regular ebb and flow twice a day in accordance with the position of the moon. The amplitude depends upon the declination of the moon and upon its distance from the earth, and also upon the latitude of the place of observation. The maximum amplitude at Brest is about a quarter of an inch of water, which means a fiftieth of an inch of mercury, a small oscillation indeed, but one which is well within our limits of accurate measurement. At Batavia the maximum heights are half an hour after the passage of the moon through the upper or lower meridian. But the retardation is almost imperceptible in other places. This is probably due to the extreme mobility of the upper strata of the atmosphere, and contrasts with the great retardation experienced by the ocean tides. M. Bouquet de la Grye points out the striking analogy between the ocean tide, with an amplitude of 1 m. under the equator, in an ocean having a mean depth of 5000 m., and the atmospheric tide of 2 mm. of water in a sea of air the weight of which represents 10,000 mm. of water.

STELLAR PHOTOGRAPHY.—A remarkable illustration of the value of photography in astronomical researches is afforded by a recent comparison of one of Dr. Max Wolf's well-known photographs with the same part of the sky as seen with the 30-inch refractor of the Lick Observatory. Prof. Schaeberle finds that an enlarged photograph of the region about Algol, taken with an exposure of five hours, certainly shows stars down to mag. 16.5, assuming that stars of the 17th mag. are at the limit of vision of the telescope. Making due allowance for the loss of detail in the process of enlarging, "it appears probable that practically every isolated star visible at Mount Hamilton can be photographed by Dr. Wolf, at or near sea-level, with his comparatively small telescope." (*Astronomical Journal*, No. 338). The telescope employed by Dr. Wolf has a Voigtlander lens of six inches aperture.

STANDARD TIME IN AUSTRALIA.—The resolution as regards Australian standard time, adopted at Melbourne last October (see p. 278), has come into effect. Queensland, New South Wales, Victoria, and Tasmania are now all using the time of the meridian 150° E., that is, ten hours before Greenwich. Queensland was the first of the Australian colonies to take action, and there the new time came into force on the first day of this year. Mr. H. C. Russell, of Sydney Observatory, has sent us a copy of the Act which established the mean time of the meridian 150° E. of Greenwich as the standard time in New South Wales, on and after February 1. He says that "South Australia has adopted the time of the ninth hour before Greenwich."

NOVA AURIGÆ.—Notwithstanding the enormous velocities in the line-of-sight recorded by the spectroscope, Nova Aurigæ has given no signs of proper motion, such as can be perceived with the telescope and micrometer. Such at least, is the result of a comparison of the measurements made in 1894 by Prof. Barnard with those made by the same observer in 1893, and by Mr. Burnham in 1892. (*Ast. Mag.*, No. 3270.) The magnitude also remains pretty constant, being 10.5, on the scale adopted at the Lick Observatory. The Nova seems to be too far removed from our system to give any appreciable parallax.

NEW COMPOUNDS OF HYDRAZINE WITH FATTY ACIDS.

COMPOUNDS of several of the more important organic fatty acids with hydrazine, analogous to the aromatic hydrazides previously prepared, have been obtained by Prof. Curtius and his pupils Messrs. Schöfer and Schwab, and an account of them is published in the current issue of the *Journal für Praktische Chemie*. The hydrazides of the monobasic fatty

acids are distinguished from the aromatic analogues by their greater solubility in water. In all cases they are most advantageously prepared by reacting with one equivalent of hydrazine hydrate upon the ester of the acid rather than upon the free acid itself. The esters of dibasic fatty acids react analogously with two equivalents of hydrazine hydrate, producing hydrazides which contain two  $\text{NHNH}$  groups.

Formic hydrazide,  $\text{HCO.NHNH}_2$ , is produced when molecular equivalents of ethyl formate and hydrazine hydrate are mixed, considerable evolution of heat occurring. When the product is allowed to stand in a vacuum for some days large tubular crystals of the pure compound separate. The crystals are transparent, very hygroscopic, and extremely soluble in water, alcohol, ether, chloroform, and benzene. They melt at  $54^\circ$ . Formic hydrazide does not form salts with acids; even dilute acids at once decompose it in the cold with formation of formic acid and a salt of hydrazine. The solution of the crystals in water reduces Fehling's solution and ammoniacal silver nitrate readily at the ordinary temperature. Formic hydrazide forms a crystalline compound with benzaldehyde with considerable rise of temperature and with elimination of water. The crystals of the compound, benzalformyl-hydrazine,  $\text{HCO.NH.N:C}_6\text{H}_5$ , melt at  $134^\circ$ . When excess of ethyl formate is heated with hydrazine hydrate in a sealed tube to  $100^\circ$ - $130^\circ$  for some hours, another formic hydrazide, diformyl-hydrazine  $\text{HCO.NH.NH.CO.H}$ , is produced in the form of brilliant colourless prisms an inch or more in length. In the preparation of this beautiful compound care must be taken to strongly cool the tube during the filling with the two components, as their interaction is otherwise of a dangerously energetic character. The crystals of diformyl-hydrazine are very soluble in water, but difficultly so in alcohol, and practically insoluble in ether. They melt at  $159^\circ$ , and reduce ammoniacal silver solution upon warming. Dilute sulphuric acid decomposes them as readily as those of formic hydrazide into formic acid and hydrazine sulphate.

Acetic hydrazide,  $\text{CH}_3\text{CO.NH.NH}_2$ , is prepared by warming equivalent quantities of acetic ether and hydrazine hydrate in a sealed tube for a few hours at the temperature of a water-bath. The product rapidly solidifies in a desiccator to a white mass of crystals. The crystals are colourless needles aggregated in leaves, and melt at  $62^\circ$ . They deliquesce rapidly on exposure to moist air, and are also very soluble in cold alcohol. The aqueous solution reacts neutral to litmus, and is readily decomposed into the original component substances by either acids or alkalis. The compound cannot be distilled without decomposition. The solution reduces Fehling's solution very vigorously on warming. Like the formic compound, acetic hydrazide reacts with benzaldehyde to produce an analogous crystalline compound, acetyl-benzal-hydrazine,  $\text{CH}_3\text{CO.NH.N:C}_6\text{H}_5$ .

Oxalic hydrazide,  $\text{CO.NH.NH}_2$ , is produced by the action of two molecular equivalents of hydrazine hydrate upon ethyl oxalate. The reaction is a somewhat violent one, and is best moderated by the addition of a little alcohol.

The new compound separates as a white crystalline mass, which is much less soluble in water than the hydrazides of the monobasic acids, and is almost insoluble in alcohol and ether. It is deposited from solution in hot water in very long and thick needles, which decompose at  $235^\circ$ . The solution reduces Fehling's or ammoniacal silver solution much less vigorously than the monobasic compounds. Oxalic hydrazide is much more stable towards acids and alkalis than the last-mentioned substances. The compound may be recrystallised unchanged from dilute sulphuric acid, and concentrated sulphuric and hydrochloric acids only decompose it very slowly. If, however, concentrated hydrochloric acid is allowed to drop upon the powdered substance moistened with water, until the acid is in slight excess, a white crystalline powder is obtained which is found to consist of the hydrochloride of the hydrazide,  $\text{CO.NH.NH}_2\text{HCl}$ .

Oxalic hydrazide reacts in an interesting manner with nitrous acid (sodium nitrite and glacial acetic acid); an energetic evolution of gas occurs, and a white powder separates. The same white substance may be obtained by acting upon oxalic hydrazide suspended in water with mercuric oxide, and decomposing the mercury compound produced with sulphuretted hydrogen, the filtrate depositing the white powder

upon evaporation. Analysis indicates that the compound

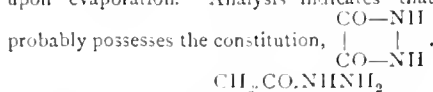

probably possesses the constitution,  $\text{CH}_2\text{CO.NH.NH}_2$ , is prepared similarly

Succinic hydrazide,  $\text{CH}_2\text{CO.NH.NH}_2$ , is prepared similarly

to oxalic hydrazide, and crystallises in silver-like crystal aggregates which melt at  $167^\circ$ , and which are more soluble in water than the crystals of oxalic hydrazide. Malonic hydrazide,  $\text{CH}_2\text{CONH.NH}_2$ , is likewise obtained in a similar manner,

the reaction between malonic ether and hydrazine hydrate being very vigorous even in the cold. The crystals melt at  $152^\circ$ . The aqueous solution reduces Fehling's solution, ammoniacal silver solution, and platinum chloride at the ordinary temperature. Both the succinic and malonic hydrazides are as stable towards acids as the oxalic compound, and each yields a hydrochloride with concentrated hydrochloric acid. Both hydrochlorides are obtained in the form of small crystals, and they melt at  $203$  and  $197^\circ$  respectively with violent evolution of gas. Succinic hydrazide reacts with nitrous acid to form an interesting compound analogous to that of oxalic hydrazide.

Its simplest possible constitution is  $\text{CH}_2\text{CO.NH.NH}_2$ .

Several other more complicated hydrazides are described in the memoir, but the above will afford a sufficiently comprehensive idea of the important addition to our knowledge of the hydrazine compounds which we owe to the labours of Prof. Curtius. A. E. TUTTON.

THE AURORA OF MARCH 13.

A NUMBER of letters referring to an aurora observed on March 13, have reached us. We select from these communications a few details of value and interest.

Writing from York, Mr. J. Edmund Clark says:—  
 "I was in a position for observing at 9.10; and the display finally ended soon after 10. The latter part was seen, very similarly, at Scarborough, 9.10. Arch, pure white (and so all through) just north of zenith; east end brighter, with well-defined, beak-like apex upon a Coronæ borealis (alt.  $17^\circ$ , az.  $13^\circ$  north of east). Upper edge just grazed  $\zeta$  and  $\eta$  Ursæ majoris, the lower some  $3'$  below Polaris, a little west of which it became double, the Pleiades lying in the fork,  $5'$  or  $10'$  from the finish at about altitude  $20^\circ$  or  $25^\circ$ , nearly due west. No auroral glow outside, nor later, except as stated. The outer curves, west end, would have met, if continued, in similar "beak" as at east end.

"9.15. Lower edge through  $\beta$  Ursæ minoris, Polaris, and a Persei. Streamers now traversing rapidly from east to west, pointing to magnetic anti-pole; passed from  $\eta$  Ursæ majoris to Polaris in 25 to 30 seconds by watch. Constant succession, as bars of light, for some minutes; then temporary cessation, but later intermittent, until 9.45. These were entirely distinct, as is obvious, from the ordinary far more rapid flickering from horizon to magnetic anti-pole. Three rough positions of stationary forms near the Plough, Auriga, and Jupiter, projected on the B.A. Meteor Star Chart, cross at altitude  $68\frac{1}{2}^\circ$ , azimuth  $35^\circ$  ( $1'$  and  $6'$  respectively from the true magnetic anti-pole, for York, at  $68\frac{1}{2}^\circ$  and  $18^\circ$ ).

"9.25. Streamers, often as curtain-like fringe on lower edge of arch, now less prominent. Others still streaming from east to west in the arch show no perceptible effect as they sweep by these. New set moved slowly westward, about  $1'$  or  $2'$  per minute.

"9.30. Lower edge again as at 9.25. Upper edge had covered Plough; arch double more or less entirely; varies fast; much fainter to east from 9.25.

"9.37. Lower edge through handle of Plough, Capella,  $1'$  north of Mars and  $\frac{3}{4}$  on from Mars to horizon. Fringe below now brilliant, but rapid fluctuations.

"9.45. Brilliant short streamers in fringe, from Mars to  $\alpha$  Aurigæ, and  $\frac{1}{2}$  on to Polaris.

"10.0. All gone but one long faint streamer from  $3'$  to left

<sup>1</sup> If others have thought of recording positions at the exact quarters, some altitudes might be obtained from the four given here.

of Allibran upper to left of Jupiter, moving slowly westwards as before.

Mr. G. W. Longhugh observed the display at Ramsay, Isle of Man, and to him the chief feature was "the predominance of a well-defined luminous bar extending across the heavens directly overhead from one horizon to the other—from magnetic east to west."

"The stars shone through this band of pale light with scarcely diminished brightness, but it was occasionally flecked by thin clouds. When I first saw it, at 9.20 p.m., there seemed to be traces of oblique striation crossing it, and Dr. Tellet, who called my attention to the display, states that ten minutes earlier, when the bar was at its brightest, these striations gave the effect of slightly twisted folds. Another informant remarked that the bar was formed shortly before 9 p.m. by the union overhead of rays which shot upwards for the east and west."

"The light waned rather rapidly with slight pulsations, and we thought that we could detect a slow southerly drift in the band before it vanished. The western portion died out before the eastern, which remained quite definite until 9.45 p.m. Meanwhile there had been a faintly diffused illumination of the northern heavens, with occasional suggestions of radiant streamers, but the whole quite subordinate in brightness to the band overhead."

"There was a westerly breeze and a nearly clear sky, with a low cloud-bank in the north-west, at the commencement of the display, but before 9.45 p.m. the wind had backed southward, and shortly afterwards the sky became suddenly overcast, though not before the aurora had faded to a scarcely perceptible glow. Half an hour later a slight shower fell."

The Rev. S. Barber says that the aurora was visible at West-Newton, Aspatia, in great brilliancy, as a band passing nearly over the zenith from the west to the east horizon at about 10 p.m. An arch of light was seen in the north from about 8.30, and some observers saw a shorter band almost north and south preceding the great band west and east.

Mr. J. Catherton saw the display at Kilmarnock, N.B., as early as 7.45, "as a broad arch of light crossing the heavens from east to west. About 7.50 it was a very luminous pencil of light in the upper part of the heavens, through which stars of the second and third magnitude were distinctly visible. As it condensed it grew brighter. About ten minutes after I first observed it, it began to fade, and was invisible before 8 o'clock, leaving a temporary brightness in the western sky."

The aurora appears to have presented features very similar to those of the aurora of November 23, 1894, observations of which were discussed by Prof. A. S. Herschel in NATURE of January 10.

#### THE U.S. UNITS OF ELECTRICAL MEASURE.

BY a law approved in the Senate of the United States, last July, it was enacted that the legal units of electrical measure in the United States should be as follows:—

1) The unit of resistance shall be what is known as the international ohm, which is substantially equal to one thousand million units of resistance of the centimetre-gram-second system of electromagnetic units, and is represented by the resistance offered to an unvarying electric current by a column of mercury at the temperature of melting ice thirteen and four thousand five hundred and twenty-one ten thousandths grams in mass, of a constant cross-sectional area, and of the length of one hundred and six and three tenths centimetres.

2) The unit of current shall be what is known as the international ampere, which is one-tenth of the unit of current of the centimetre-gram-second system of electromagnetic units, and is the practical equivalent of the unvarying current, which, when passed through a solution of nitrate of silver in water in accordance with standard specifications, deposits silver at the rate of one thousand one hundred and eighteen millionths of a gram per second.

3) The unit of electromotive force shall be what is known as the international volt, which is the electromotive force that, steadily applied to a conductor whose resistance is one international ohm, will produce a current of an international ampere, and is practically equivalent to one thousand four hundred and thirty-fourths of the electromotive force between the poles or electrodes of the voltaic cell known as Clark's cell, at a temperature of fifteen degrees Centigrade, and prepared in the manner to be in the standard specification.

(4) The unit of quantity shall be what is known as the international coulomb, which is the quantity of electricity transferred by a current of one international ampere in one second.

(5) The unit of capacity shall be what is known as the international farad, which is the capacity of a condenser charged to a potential of one international volt by one international coulomb of electricity.

(6) The unit of work shall be the Joule, which is equal to ten million units of work in the centimetre-gram-second system, and which is practically equivalent to the energy expended in one second by an international ampere in an international ohm.

(7) The unit of power shall be the watt, which is equal to ten million units of power in the centimetre-gram-second system, and which is practically equivalent to the work done at the rate of one Joule per second.

(8) The unit of induction shall be the Henry, which is the induction in a circuit when the electromotive force induced in this circuit is one international volt while the inducing current varies at the rate of one ampere per second.

The National Academy of Sciences was instructed to prescribe and publish the specifications necessary for the practical application of the definitions of the ampere and volt given in the foregoing, and, to meet this requirement of Congress, a special committee was appointed to consider the subject. The committee, selected from members of the Academy, was as follows:—Prof. H. A. Rowland, chairman, General H. L. Abbot, Prof. G. F. Barker, Prof. C. S. Hastings, Prof. A. A. Michelson, Prof. J. Trowbridge, Dr. Carl Barus.

The report of this committee was submitted to the Academy at a special meeting held last month, and was then accepted and unanimously adopted. We extract the following details from the report, a copy of which has just reached us.

#### The Ampere.

In employing the silver voltameter to measure currents of about one ampere, the following arrangements shall be adopted:

The kathode on which the silver is to be deposited shall take the form of a platinum bowl not less than 10 centimetres in diameter, and from 4 to 5 centimetres in depth.

The anode shall be a disc or plate of pure silver some 30 square centimetres in area and 2 or 3 millimetres in thickness.

This shall be supported horizontally in the liquid near the top of the solution by a silver rod riveted through its centre. To prevent the disintegrated silver which is formed on the anode from falling upon the kathode, the anode shall be wrapped around with pure filter paper, secured at the back by suitable folding.

The liquid shall consist of a neutral solution of pure silver nitrate, containing about 15 parts by weight of the nitrate to 85 parts of water.

The resistance of the voltameter changes somewhat as the current passes. To prevent these changes having too great an effect on the current, some resistance besides that of the voltameter should be inserted in the circuit. The total metallic resistance of the circuit should not be less than 10 ohms.

*Method of making a Measurement.* The platinum bowl is to be washed consecutively with nitric acid, distilled water, and absolute alcohol; it is then to be dried at 160° C., and left to cool in a desiccator. When thoroughly cool it is to be weighed carefully.

It is to be nearly filled with the solution and connected to the rest of the circuit by being placed on a clean insulated copper support to which a binding screw is attached.

The anode is then to be immersed in the solution so as to be well covered by it and supported in that position; the connections to the rest of the circuit are then to be made.

Contact is to be made at the key, noting the time. The current is to be allowed to pass for not less than half an hour, and the time of breaking contact observed.

The solution is now to be removed from the bowl, and the deposit washed with distilled water, and left to soak for at least six hours. It is then to be rinsed successively with distilled water and absolute alcohol, and dried in a hot-air bath at a temperature of about 160° C. After cooling in a desiccator it is to be weighed again. The gain in mass gives the silver deposited.

To find the time average of the current in amperes, this mass, expressed in grams, must be divided by the number of seconds during which the current has passed, and by 0.001118.

In determining the constant of an instrument by this method,

the current should be kept as nearly uniform as possible, and the readings of the instrument observed at frequent intervals of time. These observations give a curve from which the reading corresponding to the mean current (time-average of the current) can be found. The current, as calculated from the voltmeter results, corresponds to this reading.

The current used in this experiment must be obtained from a battery, and not from a dynamo, especially when the instrument to be calibrated is an electro-dynamometer.

#### The Cell.

*Definition and Properties of the Cell.* The cell has for its positive electrode, mercury, and for its negative electrode, amalgamated zinc; the electrolyte consists of a saturated solution of zinc sulphate and mercurous sulphate. The electromotive force is 1.434 volts at 15° C., and between 10° C. and 25° C., by the increase of 1° C. in temperature, the electromotive force decreases by 0.00115 of a volt.

*To set up the Cell.*—The containing glass vessel, represented in the accompanying figure, shall consist of two limbs closed at

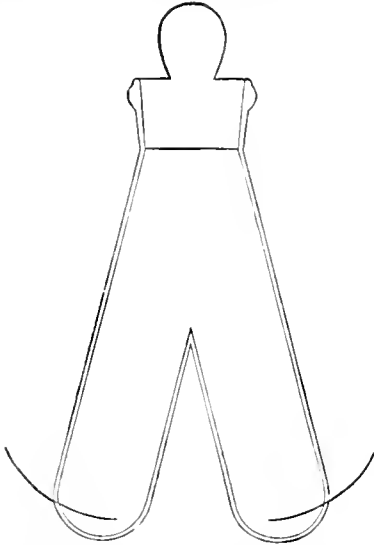

bottom and joined above to a common neck fitted with a ground-glass stopper. The diameter of the limbs should be at least 2 centimetres, and their length at least 3 centimetres. The neck should be not less than 1.5 centimetres in diameter. At the bottom of each limb a platinum wire of about 0.4 millimetre diameter is sealed through the glass.

To set up the cell, place in one limb pure mercury, and in the other hot liquid amalgam, containing 90 parts mercury and 10 parts zinc. The platinum wires at the bottom must be completely covered by the mercury and the amalgam respectively. On the mercury, place a layer one centimetre thick of the zinc and mercurous sulphate paste described in 5. Both this paste and the zinc amalgam must then be covered with a layer of the neutral zinc sulphate crystals one centimetre thick. The whole vessel must then be filled with the saturated zinc sulphate solution, and the stopper inserted so that it shall just touch it, leaving, however, a small bubble to guard against breakage when the temperature rises.

Before finally inserting the glass stopper, it is to be brushed round its upper edge with a strong alcoholic solution of shellac, and pressed firmly in place.

#### ON THE NATURE OF MUSCULAR CONTRACTION.

THE subject of this lecture is an inquiry into "The Nature of Muscular Contraction." Like all vital phenomena, muscular contraction is a most complicated process, composed of mechanical, chemical, thermal, and electrical changes in living matter. Hence it will be our task to become acquainted with

<sup>1</sup> The Croonian Lecture, delivered by Prof. Th. W. Engelmann, at the Royal Society, on March 14.

these changes as completely and exactly as possible, and to ascertain their causal connection. Our inquiry must not be restricted to one special kind of muscle: it will have to extend to all the different forms, for there can be no doubt but that in all these cases the principle of activity is the same. Nay, it will be necessary to deal even with the other phenomena of so-called contractility, such as protoplasmic and ciliary motion, for all these different types of organic movement, however much they may differ from each other in details, are yet so connected by gradual transitions, that, to all appearance, one principle of motion, essentially the same, is applicable to all of them.

The general mechanical principle on which muscular contraction is based, will be discovered when we shall have ascertained in what way the power of shortening proceeds from the potential chemical energy which disappears upon stimulation of the muscle.

There can be no doubt as to the fact that the potential chemical energy of the component parts of muscular substance is alone the ultimate source of this power, for the existence of any other source cannot be proved. The quantity of energy which is imparted to the muscle by the stimulus is too small to be taken into consideration. The early opinion that the power required for contraction was imparted to the muscle through the medium of motor nerves has been refuted by experiments, such as, *e.g.*, on the persistence of contractility after degeneration of the motor nerves, and on the effects of direct artificial stimulation of the muscles; and it had even been refuted long ere the law of conservation of energy had thrown its light on the mutual connection between the phenomena of the living organs.

This law teaches that all the actual energy which appears in the muscle in consequence of stimulation must originate in an *equivalent* quantity of some other form of energy.

Now this form of energy is, in fact, given in the muscular substance liable to physiological combustion. The quantity of the latter is not only theoretically sufficient to produce that actual energy, but it has even been proved experimentally that during contraction that material gives birth to combinations such as carbonic acid, in the development of which potential chemical energy must have passed into other forms of energy. As far as the phenomena have been examined *quantitatively*, they confirm the conclusion that all muscular force must be derived from chemical energy.

Hence there is no difference about all these points. But with this result we have as yet gained only a basis for the proper solution. So soon you inquire in what way, by what transformations, does the mechanical force of contraction arise from chemical energy, difficulties and differences of opinion begin to present themselves.

A great many physiologists hold, with Pflüger, Fick, and Chauveau, that muscular force is a direct manifestation of chemical attraction; others, *e.g.*, Solvay, think that it is produced through the medium of electricity; others again, following J. R. Mayer, believe that the muscle is a thermodynamic machine, not unlike our caloric or steam engines.

*The Chemiodynamic Hypothesis.*—The first hypothesis, according to which contraction of muscle is a *direct* manifestation of chemical attraction—we may call it the chemiodynamic hypothesis—has to assume that the molecules, on the chemical combination of which this contraction is based, are regularly arranged within the contractile substance in such a way as to make them approach each other at their combination in the direction of the axis of the muscular fibres.

I think that this hypothesis of the identity of chemical attraction and muscular force meets with a fundamental difficulty in the fact that, in a single contraction, only a relatively infinitesimal part of the muscular substance is chemically active; 70 to 80 per cent. of the muscle (and even more) consists of absorbed water, the rest contains substances (albumin, salts, &c.) which, for the greater part, so far as can be proved, are not chemically concerned in the contraction.

This quantitative composition and this minute consumption of the active muscle compel us to assume that relatively only very few molecules of the muscular substance can be considered as sources of energy; and of these again it is generally but a small part that at a certain moment perform their function.

With certain pre-suppositions we may calculate the quantity of matter through the chemical action of which the amount of actual energy, produced at a certain contraction, must have been generated.

If we prevent a muscle from doing external work during the contraction, the whole actual energy will present itself in the shape of heat. When there is but a slight contraction, the muscle of a frog, for example, will grow warmer by about 0.001° C. Supposing the specific heat of the muscle to be equal to that of water (in fact it is less), we find that for a rise of 0.001° C. in temperature a quantity of heat of 0.001 cal. is required for each gram of muscle. No matter whether this quantity of heat results from the combustion of carbohydrates, fats, or albumin, as matter, it can be but an infinitesimal part of the muscular substance that produced it. If, e.g., as is ordinarily supposed, the combustion of a carbohydrate into CO<sub>2</sub> and H<sub>2</sub>O produced that heat, taking the heat of combustion of one gram of carbohydrate to be broadly 4000 cal., no more than a four-millionth part of a milligram will have been consumed in each gram of the muscle. Hence only about a four-millionth part of the muscular substance could have been the source of the actual energy set free by the stimulus, and at the same time, according to the above hypothesis, have been the subject of direct attraction.

But whatever may be our conception of the size, form, position, and sphere of action of this four-millionth part in relation to the other soft, watery mass, only passively moved, I fail to understand how, through *direct chemical attraction*, this one minute part should bring about the movement of the rest of the four million parts in such a manner as it does.

The adherents of the chemico-dynamic hypothesis have not answered this objection as yet. And since they can give but an unsatisfactory account or no account at all of many other facts (I will refer to some of these facts further on), we may be allowed to cast about for some other explanation.

*The Electrodynamical Hypothesis.*—Since Galvani's discoveries, the electric phenomena of muscles have frequently been suspected to contain the solution of our problem. And, indeed, it is not so very difficult to mention a series of facts which seem to bear out the suggestion that the mechanical work done by the muscle may be created from chemical energy through the medium of electric forces.

There is, in the first place, the fact that muscles, when in action, produce regular electric effects. These effects are indeed the first phenomena we can observe after stimulation. They seem to begin at the very moment of stimulation, shortly before the contraction, hence they might in so far be the cause of the mechanical process.

Moreover, as du Bois-Reymond proved, the value of the electromotor force is very high, and in the active particles is probably much higher than the force of the currents we can derive from the surface of the muscle.

Add to this that the economic coefficient of the muscle may attain, just as in the case of electric motors, a considerable proportion. As much as 25 per cent. and more of the potential energy which has been consumed may be transformed into mechanical work.

However, there are weighty objections to this hypothesis also. In the first place, there is the fact that these very same electromotor forces, of equal intensity and direction, appear, under the same influences, not only in the muscles, but also in nerves, glands, and other organs, which do not possess the least contractility. Then there is the important discovery of Biedermann, that the contractility of muscles may be completely neutralised by water or etheric vapours, without doing any perceptible harm to the electromotor phenomena.

In the same way the development of the electric organs supplies us with important proofs of the independence of the electric and the mechanical processes. In most cases these organs are developed out of striped muscular fibres. Now, in this process of development, contractility is gradually lost, whereas the power of producing electrical effects attains a yet higher degree of perfection.

*The Thermodynamic Hypothesis.*—More probable than the chemical and the electrical hypothesis may be deemed a suggestion, first put forward by Jul. Robt. Mayer, though in an untenable form, according to which the muscle is a thermodynamic machine. Physiologists, however, generally object that this view is not compatible with the second law of thermodynamics, for we cannot expect differences in temperature in the muscle as great as this law requires they should be.

It is well known to think that, on the contrary, we must assume differences of very great differences of temperature in the stimulated muscle. What holds good of the whole body holds good of the

muscle also: the temperature, measured with our instruments, is but an arithmetical average, "comprising an infinite number of different temperatures, pertaining to an infinite number of different points" (Flügel).

From the fact that at the contraction an infinitesimal part only of the muscular mass is chemically active, we infer that the temperature of these particles must, at the moment of combustion, be an uncommonly high one. Great as the specific heat of muscular substance is, it would otherwise be impossible to account for a rise in the temperature of the whole mass even of 0.001° C. only.

Since each thermogenic particle is surrounded by a relatively enormous cool mass, conducting heat and diathermanous, the principal condition for the transformation of heat into mechanical work has been satisfied, and, on account of the enormous differences in temperature which we have to assume, satisfied to such a high degree, that even an economic coefficient of 30 per cent., nay, 50 per cent., and even more, seems to be theoretically possible.

Supposing we have to deal with a Carnot's cycle, the theoretical maximum  $Q_0$  of the mechanical effect is  $Q_0 = Q \frac{T_1 - T_2}{T_1}$ ,

where  $Q$  stands for the whole quantity of heat, which from the absolute temperature  $T_1$  is sinking down as far as  $T_2$ . Taking  $T_1 = 273 + 37 = 310$ , the mechanical effect might at  $T_2 = 410$  amount to 30 per cent., when the temperature of the active particles would consequently exceed the average temperature of the normal muscle by 100° C. only.

The objection that these high temperatures must necessarily destroy the life of the muscle, since the latter becomes rigid and dies even at 50° C., is, for the same reasons, of small importance only. For it is ever but an infinitesimal part of the muscular mass that is exposed to these high temperatures. At a small distance from these furnaces of heat the temperature must have fallen so low as to be harmless. The muscle will no more be destroyed by stimulation than a steamer will be destroyed by heating the furnaces.

However likely it may thus seem that nature should avail herself of these favourable terms in which mechanical work may result from muscular heat, we have up to the present time no direct proof that this is actually the case, nor do we know in what way it takes place, if in any. But I venture to think that the proof can now be given, inasmuch as it is possible to demonstrate how, through the medium of peculiar arrangements of the material of the muscle, a transformation of chemical energy into mechanical work by means of heat not only can, but actually must, be brought about.<sup>1</sup>

#### *Muscular Structure in relation to Contractility.*

*The Fibrils are the Seat of the Shortening Power.*—For this we need firstly to pay attention to the peculiarities of the microscopical structure of muscle. All muscular fibres of all animals are composed chiefly of two parts: extremely thin, long, albuminous fibrils, and an interfibrillar plasmatic substance, the so-called sarcoplasm. The quantitative relations of both vary, but the fibrils always occur in great number, forming very often the greatest part of the whole mass of the muscle. They always run parallel to each other throughout the length of the fibres.

This fibrillar structure is also presented by all the other formed contractile substances.

Direct microscopical observation during life teaches us that the fibrils, and not the sarcoplasm, are the seat of the shortening power. The fibrils in a state of relaxation are long and thin, and often run in winding curves, but grow short, thick, and straight, in consequence of stimulation. The sarcoplasm passively follows their movements. Moreover, completely isolated fibrils can shorten.

*The Fibrils are Contractile because they contain Doubly Refractive Particles.*—Thus the question arises: Can there be demonstrated in the fibrils such arrangements of their material as by their mediation contractile force may originate in a thermodynamic way?

Laghi—*lus optimum regens*, as Buys Ballot said—solves this

<sup>1</sup> The empirical foundations of the views developed in this lecture will be found in "Versuche über Aenderungen der Form und der elastischen Kräfte doppeltbreitender Geselelemente unter chemischen und thermischen Einflüssen," in the Appendix of my Memoir, "Ueber den Ursprung der Muskelkraft," 2te Auflage, Leipzig, 1891, S. 54-60, and in the literature cited in the same page.

question for us. If we examine the optic properties of contractile fibrils, with the aid of the polarising microscope, we find that all of them are double-refractive, with one optical axis parallel to the direction of contraction.

This general occurrence of double-refracting power is the more indicative of relations to contractility, since non-contractile cells, as a rule, lack double refraction, even where we meet with a fibrillar structure, as in the axis-cylinder of a nerve-fibre.

Our conjecture gains, I believe, a very high degree of probability by the following series of observations.

In the first place, the fact that contractility and double refraction in the course of ontogenesis always appear at the same time, e.g. in the heart of the chick, on the second day of incubation; in the muscles of the trunk and skin on the fifth or sixth day; in the muscles of the tails of tadpoles when the length of their body is 3 to 4 mm.; in the muscles of the stalk of *Vorticella*, and in cilia so soon as these organs become visible.

Another evidence seems to me to be afforded by the behaviour of the striated muscles. Here the fibrils consist of the doubly-refractive sarcous elements and the singly-refractive material which joins these, the two alternating regularly. The two are wholly different as regards their optical, mechanical, and chemical properties; and these properties, moreover, during contraction, change in an opposite way. Hence the functions of the two must be of a different kind. And since the changes of form, volume, &c., of the doubly-refractive parts during contraction prove that in each case the e parts must be the seat of contractile power, the single-refractive junctions will most probably have another function. We will come back to these changes further on.

A third evidence is afforded by the observation that the specific force of contraction in different muscles is, in general, greater, the better developed the power of double refraction, comparison, of course, in each respect being made with parts of the same thickness.

In the development of the pseudo-electric organs of *Raja* out of striated muscular fibres, one of the signs of the incipient change of structure and function is the vanishing of double refraction in the sarcous elements. In an early stage of development this vanishing is, with *Raja clavata*, the very first and the only sign that the fibre is about to be transformed from a contractile into an electric organ.

But particularly significant seems to me to be the behaviour of the obliquely striated muscles of Molluscs and other Invertebrata. Here the doubly refractive fibrils do not run parallel to the axis of the fibre, but describe spiral lines round it; and during a contraction the steepness of the curves decreases, so that the angle formed by the longitudinal axis of the fibril and the longitudinal axis of the fibre may increase from 5° in the relaxed state to 60°, and even more, in a state of powerful contraction. But the optic axis of the fibril, instead of assuming, in this case, a more oblique position also, as might be expected on morphological grounds, remains parallel to the longitudinal axis of the fibre, and consequently to the direction of shortening of the fibre. Hence it is not the morphological axis of the fibrils, but the optical axis of their doubly refractive constituents, which coincides with the direction of the contracting force.

*Contractility a General Property of Doubly Refractive Bodies.*—More than a score of years ago I pointed out the fact that even non-muscular elements, elements not possessing irritability in the physiological sense of the word, nay, even lifeless, unorganised elements which are uniaxial doubly refractive, may, under certain influences, contract in the direction of the optical axis, all thickening at one time, and contracting with a force and quickness and to an extent rivalling that of muscles, if not surpassing it. Instances of this are the fibrils of the connective tissue, of the tendons, and of the cornea, and others. The same contractile power was found by von Ebner in a great many other doubly-refractive histological elements, nay, even in substances capable of absorption and thereby made doubly refractive, e.g., dried colloid membranes; and finally by Hermann, in fibrils of fibrin.

I have in this way shown that singly refractive, or only feebly doubly refractive histological elements, such as the fibres of elastic tissue, obtain, in the same way as caoutchouc, the power, when made doubly refractive by extension, of contracting under certain influences, and further that the force of

shortening will generally be greater in proportion to the amount of the double refraction thus artificially produced.

Since, according to Mitscherlich's discovery, similar changes of form may be observed in doubly refractive crystals, we have apparently to deal with a property pertaining to all doubly refractive bodies as such.

*Heat as a General Cause of Contraction of Doubly Refractive Elements.*—Now, the influence which in all these cases is able to evoke the mechanical energy of shortening is *elevation of temperature*. Refrigeration has the opposite effect.

Particularly instructive is the thermal contraction of the fibrillar connective tissue, on account of its similarity to muscular movement, even with regard to details.

In tendons and many membranes the fibrils, as well as those of most muscles, are arranged into bundles, all or nearly all, parallel to each other. For this reason such objects are extremely well fitted for a closer examination of the phenomena of movement. The most suitable material I know is furnished by the catgut strings of violins, which chiefly consist of such bundles, running in steep spiral lines, round the longitudinal axis of the string. They are distinguished from the greater number of naturally occurring objects by their very regular cylindrical shape and their elasticity. On these properties is based their suitability for musical purposes, especially for the so-called "perfect fifth" ("Quintenreinheit").

*The Muscle-Model.*—With the aid of such a string we can compose a model which in a simple way explains how in the muscle mechanical energy of contraction may result from heat without any perceptible rise of the average temperature of the muscle.

A piece of an E string of a violin, about 5 cm. long and previously swollen in water, is fastened to the end of the short

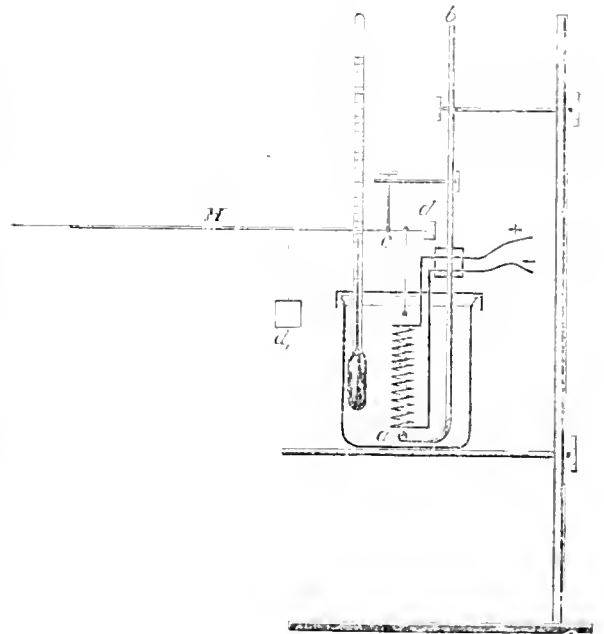

FIG. 1.

rigid arm of a steel rod, while the upper end of the string is fixed to the shorter arm of a lever, turning round a horizontal axis.

To this string different tensions may be imparted by weights or springs, acting upon the lever.

Round the string, but without touching it, runs for a length of about 20 mm., and in about twenty curves, a spiral of thin platinum wire. The ends of this may be connected with the two poles of a Grove or Bunsen battery of three or more cells. The rod, bearing the lever string and spiral wire, is placed in a glass of about 50 c.c. contents, filled with water of about 55°-60° C., and closed at the top by an ebonite lid. Through an aperture in the lid, a

thermometer is placed in the water in such a position that it will remain at a distance of about 1 cm. from the spiral wire.

The string is now observed for some minutes at a tension of 25 or 30 grammes and at a constant temperature until no further change in the position of the lever can be discerned. It will now close for some seconds the circuit of the battery driving the spiral, the lever rises. Upon opening the circuit, it falls. A thermometer in the glass indicates a hardly perceptible rise of temperature, or no rise at all.

We see the doubly-refractive string of our model corresponds to the doubly-refractive muscular particle, which we suppose to be the seat of the force of contraction, and therefore may be called "*inotagma*"; the water in the glass represents the watery isotropic substance round the inotagma, doing duty as refrigerant; the spiral wire supplies the place of the chemically active *ferromagnetic* molecules; the closure of the galvanic circuit corresponds with the process of the stimulation of the muscular element.

The movements may be inscribed on a rotating cylinder. We then obtain curves of the same character as contraction-curves of muscles.

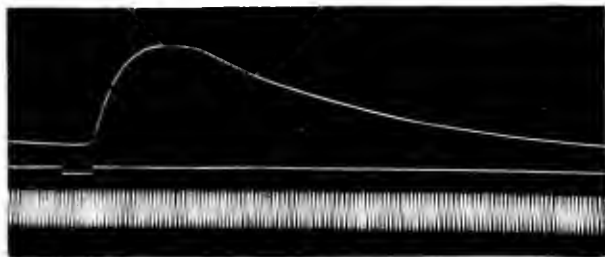

FIG. 2.

Such a *thermogram* presents, like a myogram, three periods, viz. :—

1. A period of latent energy, the duration of which, just as with the muscle, decreases with the increasing energy of the stimulus (i.e., with the intensity and duration of the electric current), with rising temperature and with decreasing load.

2. A period of augmenting energy, in which contraction takes place with a rapidity, first increasing, afterwards diminishing, the contraction being, within certain limits, more rapid and the larger in extent the stronger the stimulation.

3. A period of declining energy, in which the string relaxes with a gradually decreasing rapidity.

*Further Comparative Researches on the Thermal Contraction of Lifeless Double Refractive Bodies and the Physiological Contraction of Muscle.*—The points of resemblance between our model and a muscle extend much further yet, and amongst other points to peculiarities which seem to bear important testimony to the identity of the mechanical process in the two cases.

Such a resemblance I find, in the first place, in the fact that the strength of the shortening fever, developed by a certain stimulus, increases with the load within certain limits. Both muscle and string present the paradoxical phenomenon that, under a stimulus of equal energy, heavier weights may be lifted higher than lighter ones.

Neither the chemical nor the electrical hypothesis of the origin of muscular force can give a sufficient explanation of this fact. On the basis of our theory, on the contrary, it can be predicted, because every influence which augments the doubly-refractive power must raise the power of contraction.

Now, von Lieber has proved experimentally that the force of double refraction of tendon—and also, between certain limits, of muscles, increases with the load. The same is the case with fibres of elastic tissue and with caoutchouc, and with these also the contractile power increases with the load. The differences of force thus depending on the load are by no means insignificant.

Connected with this point is another fact, viz. that the force of shortening produced in our model by means of a given rise of temperature, is the smaller the more the string has already contracted. The maximum of force is, at all events, displayed when the extension of the string is brought by the whole load being applied at once at the very beginning of the heating, not after the string has already contracted with a smaller load.

The very same thing, as Schwann's experiments showed many years ago, holds good of muscle. On the hypothesis of chemical attraction we should decidedly expect the reverse: viz. increase of force with an increasing mutual approach of the combining molecules; so also in the same way on every other hypothesis which pronounces contraction to be caused by attractive powers increasing in inverse proportion to the square of distance.

In the fact discovered by Schwann, Johannes Müller thought he had found a refutation of the old electro-dynamic hypothesis of Prévost and Dumas, as well as a valid reason for assuming a fundamental relation between the vital power of contraction and physical elasticity.

However, as Hermann has observed, we might in this case get over the difficulty by supposing that between or in the length of the parts attracting each other, there are elastic layers opposing that attraction with increasing force. It is evident that our view of the matter does not require such an auxiliary hypothesis, because, in accordance with Eduard Weber, we regard muscular contraction as only a special case of elastic shortening.

A closer experimental comparison of the changes undergone, on the one hand, by the elasticity of our string during thermal shortening, and, on the other hand, by muscular elasticity during physiological contraction, will teach us that, in each case, the changes are of exactly the same kind.

As regards striated muscles, it was Eduard Weber who, by his classic researches, established that their extensibility increases during contraction. The same is now proved to hold good of strings and other organic doubly-refractive substances during thermal shortening.

The curve of lengthening of all these objects inclines more sharply towards the abscissæ of the loads the higher the temperature. Both curves converge, and may finally even cross, i.e. a certain load being exceeded we do not get contraction but lengthening as the effect of heating.

This circumstance explains the fact, sometimes observed by E. Weber, that living, tired, heavily-loaded muscles of frogs, lengthen instead of shorten as a result of electric stimulation. Considered from other theoretical points of view, this observation seems so paradoxical that its very validity has been questioned by some physiologists, but in the face of the direct and exact measurements of so scrupulous an observer and inquiring as Eduard Weber, we have no right to do this. According to our view of the origin of muscular force this fact is not paradoxical at all, but might be foreseen.

The decrease of the shortening power and the increase of extensibility with increasing thermal contraction is, in the case of our lifeless doubly-refractive objects, accompanied by a decrease in the power of double refraction. According to von Lieber's careful measurements, the same thing is the case with muscles during vital contraction. We may consider this fact, too, as an important proof of the fundamental resemblance between the process of contraction in our model and in the muscle, and at the same time as a further evidence of the existence of a causal relation between double refraction and contractility in general. But it is the physicist's task, and not the physiologist's, to penetrate further into the relations between optic and elastic properties. The physiologist may deem his purpose attained when he succeeds in tracing a certain vital phenomenon to processes which may also be observed in lifeless bodies.

However, though we should, perhaps, be inclined to infer from the foregoing that we have successfully acquitted ourselves of this task with regard to muscular contraction, we will be careful not to overlook the numerous important respects in which a muscle as a living body, that is, one subjected to constant chemical transformation, differs from our lifeless strings. The study of these differences is most instructive, since it throws a new light on a series of processes nearly allied to contraction, especially on the phenomena of *rigor mortis* and *tonus* of muscle.

But before entering into this we shall first have to meet another important objection to our views. It is based upon the absolute amount of muscular force. This amount may, as you know, be very high. Human muscles at the strongest tetanic contraction can shorten with a force of about 10 kilogrammes to 1 sq. cm. transverse section. Now such a force must, according to our view, be produced by a small part only of the transverse section of the muscle.

With a maximal tetanus, it is true, the temperature of the



whole muscle does rise  $1^{\circ}$  C. or more. Hence there are, perhaps, 1000 times more particles chemically active than with a moderate simple contraction, where the temperature rises 0.001° C. only. Consequently, during such a tetanus, a much greater part of the muscular substance—perhaps 1000 times as much—will be heated to such a degree as is required for an obvious contraction of the inotagmata. But even in this case the greater part of the whole substance will be only moved passively.

Can such very important mechanical powers as we are obliged to assume in the inotagmata be evolved through the thermal contraction of doubly-refractive bodies? Do we not, as Fick says, in making such a supposition, go too far beyond the bounds of legitimate analogy?

Of course nothing but the measurement of the forces developed by lifeless doubly-refractive bodies under thermal contraction will decide this question. I have made many of these measurements on various objects, and I think the results afford us a refutation of the objection. Strings, moist but not yet contracted through lying in water, with a diameter of 0.7 mm., and loaded with 1 kilogramme, lifted up the weight in a perceptible degree when rapidly heated up to  $130^{\circ}$  C.; that is to say, they exerted a force about twenty times at least as great as the maximum force of a human muscle of the same thickness.

Still greater forces may be exerted by strips of caoutchouc rendered in a high degree doubly refractive by strong extension. Even by merely heating from  $20^{\circ}$  to  $40^{\circ}$  C. powers could be produced sixty times as great as the maximum afforded by human muscles of the same transverse section.

Hence we may sufficiently account for the greatest display of force in the muscle, without having to attribute to the inotagmata higher elastic forces than we observe in highly extended threads of caoutchouc of the same thickness, nay, without even having to assume temperatures reaching the degree necessary for the coagulation of albumin.

It is a pity that we are not able to subject the isolated doubly-refractive parts of the muscle in an unimpaired condition to the influence of heat. Together with the elevation of temperature there occur changes in the chemical processes, and there with in the material composition and mechanical properties, of the whole muscle substance, which complicate the changes dependent only on the heating of the doubly-refractive particles, or even prevent our clearly recognising them.

*Tetanus and Rigor by Heat.*—Living muscles, when being gradually heated, will, as you know, contract tetanically so soon as the temperature has attained a height which is but little below  $50^{\circ}$  C. This so-called *tetanus of heat* passes by prolonged heating into the lasting contraction of *rigor*, in this case combined with definitive loss of irritability.

This contraction through heat agrees at so many points with physiological contraction, especially with physiological tetanus, that it was held to be a last manifestation of muscular life. Such points of resemblance are, e.g., the amount and the force of shortening, which in both cases are at least of the same order, and the increased production of heat, carbonic acid, and a fixed acid.

No doubt in this case a very important and general rise of temperature of the contractile particles will take place so soon as rigidity begins to announce itself. Consequently, according to our hypothesis, we must expect a strong and general contraction of the inotagmata.

That the force, with which the muscle as a whole will shorten, is not quite so great as with physiological tetanus, is sufficiently explained by the fact that the inotagmata do not contract simultaneously, and by the increase of internal resistance which occurs, due to coagulation and precipitation in the muscle plasma during the development of rigidity by heat. The latter circumstance seems to explain, too, why the rigid muscle does not perceptibly lengthen, or lengthens very little, upon cooling.

*Turgescence by Absorption as a General Cause of Contraction of Doubly-refractive Organised Elements.*—On a closer examination, however, we find that matters are still more complicated, and likewise that there is still an important circumstance which, besides the rise of temperature of inotagmata, may act as a cause of contraction, even of permanent contraction. This circumstance, the fundamental importance of which to muscular contraction was disclosed a score of years ago by a rigorous microscopical examination of the processes taking place in the

muscle fibres during contraction, is the *turgescence of the doubly-refractive elements by the absorption of watery liquids*.

All histological elements possessing doubly-refractive power tend, even at an ordinary low temperature, to shorten in the direction of the optical axis when their volume is enlarged by the absorption of a watery fluid, and to lengthen when their volume diminishes by loss of liquid. The extent, power, and rapidity of the changes of form depend on the nature and on the dimensions of the turgescence object, and on the nature and quantity of the absorbed liquid.

For the examination of these relations our violin strings again yield fit material. A long series of measurements has now shown that there is a very far-reaching resemblance between contraction by turgescence and thermal and physiological contraction. I may mention the marked extent of the shortening, the high value of the force of contraction, its increase with the initial tension and its decrease with increasing shortening, the increase of extensibility, the decline of refractive power and of doubly-refractive property. The resemblance is by no means exclusively of a qualitative, but also of a quantitative kind.

A change of form generally takes place when the composition of the absorbed liquid changes, and it is of great importance to our question that even the slightest changes of composition can cause marked contractions and great mechanical effects.

Unloaded E strings, e.g., contract in pure water to nine-tenths, and in water which contains 0.25 per cent. only of lactic acid to three-fifths of the initial length. At  $15^{\circ}$  C. they exert, in the first case, forces of about 80 g., in the second of about 110 g. By absorbing a 0.25 per cent. solution of lactic acid at initial tensions of 5, 215, and 425 g. there were exerted powers of 115, 350, and 400 g. respectively, i.e. forces very much higher than a muscle of the same thickness can produce during tetanus.

Upon neutralisation or dilution the old length and volume return. The doubly-refractive fibrils, or the sarcous elements of muscles, contract considerably also under the same conditions, swelling at the same time; this is the case even with muscles which have been killed in alcohol. In such instances I measured in the striated fibres of insects shortenings to 50 per cent. and more.

Since, according to many inquirers, lactic acid is formed during the rigor of striated muscles, and at all events the reaction of the muscular plasma becomes acid, the doubly-refractive elements must necessarily swell more and tend to shorten, and this contraction will remain until the acid has been neutralised or removed by diffusion.

Similar results will follow in other cases of rigor characterised by shortening and by the production of much acid. Nay, in the bloodless muscle even a physiological stimulation, when sufficiently strong and long, may be expected to produce a lasting shortening, on account of the gradual increasing acidity. Indeed, the well-known incomplete relaxation of such muscles seems to me to be a symptom of this *chemical contraction*, as it may be called, in contrast with the *thermal*.

In a muscle in which the blood stream is maintained this will not so easily take place, not even under a strong and prolonged stimulation, because the acid is immediately neutralised or removed through diffusion. Even in the isolated, bloodless muscle the acid, which is produced by stimulation, may, in the beginning at least, be rendered harmless through the very large quantity of non-acid fluid absorbed by the muscle. Consequently we must expect in these cases an immediate and complete relaxation after contraction. The facts agree absolutely with these suppositions.

It is, perhaps, not unnecessary to remark that all these observations would also hold good if the material affecting the turgescence were not lactic acid, but another substance arising during the chemical action in the muscle, e.g. water.

*The different parts played by "Thermal" and by "Chemical" Contraction in the different kinds of Muscular Contraction.*—But now the question may be raised, Is not physiological contraction due to turgescence solely?

We have all the more reason to put this question, since we can prove that in the physiological contraction of striated muscle-fibres the doubly-refractive layers swell at the cost of the watery isotropic layers. The microscopical examination of active living muscles and of fixed waves of contraction has proved this fact beyond all question, however much the opinions of different observers may diverge on other points. The well-

ing wall, more ver, account for the slight decrease of muscular volume of nerve in strong tetanic contraction. For, according to the experiments of Quincke, the absorption of water by crystallised bodies generally leads to a slight contraction. By this contraction farther heat is developed, and this heat might, by raising the temperature of the doubly-refractive elements, be partially transformed into mechanical energy, and in this way contribute to the production of muscular force.

I cannot consider this explanation as sufficient for all the facts. The same argument which in our eyes seems to dispose of the hypothesis of the identity of chemical attraction and muscular force, viz. the infinitesimally small quantity of substance which is chemically active during a simple contraction, seems to me to present a fundamental difficulty here also. It is hard to understand how through a change in the material composition, effected at one infinitesimal point within a soft watery substance, the whole mass should shorten and thicken, *unless the process is not a centre of chemical activity a condition of a heat of kinetic energy throughout the substance.*

The microscopic appearances which prove the turgescence of the doubly-refractive elements during a contraction, do not exclude a direct thermo-dynamical effect. For the almost complete identity in the changes of form, and of the optical and mechanical properties which the doubly refractive constituents of all histological elements undergo during chemical and thermal contraction, seems to bear out the hypothesis, that in the thermal shortening of doubly-refractive elements, through the absorption of watery fluid, we get a shifting of solid and liquid substances analogous to that of turgescence. With most of the microscopical appearances, especially the so called fixed contraction waves, we have, moreover, to do with a high degree of tetanic contraction, or even with rigor, in which, on account of the greatly increased chemical action, a chemically-caused turgescence may have combined in a considerable degree with the thermal contraction.

Hence, we may conclude that chemical contraction by turgescence of the inotagmata is most likely a constant concomitant of the thermal contraction of living muscle, but that compared with the latter, in a single contraction at least of striated fibres, the former is of little or no consequence as regards the shortening effect.

*Chemical and nervous.*—Both processes will probably also take part in varying proportion in the *tonus* of muscle, which in some cases will approach more to pure *chemiotonus*, in others more to pure *thermotonus*.

*Chemical Relaxation of Muscle. Theoretical Consideration.*—*Chemical.*—With regard to the relaxation of muscle, according to our theory this must be caused either by cooling, or by the withdrawal of water from the doubly-refractive particles. Indeed, we have found that generally doubly-refractive histological elements, even if they be lifeless like our *vitelline strand*, lengthen again upon cooling after they have been contracted by heat, and that they lengthen upon neutralisation or dilution, after they have been contracted by absorption at an ordinary temperature.

In a general relaxation the muscle seems to return completely to its normal state. Of course its store of energy has diminished in proportion to the quantity of mechanical work and heat which have been expended from it, but, on account of the relative influence of the quantity of substance which is thereby consumed, this return will normally seem to be complete even in the case of the *luteo-muscle*.

When analysing the phenomena of relaxation more exactly, we shall highlight several peculiarities, the discussion of which will be very interesting, with regard to the theory of muscular life. I shall not discuss here the phenomena of the relaxation following tetanic contraction.

Here, in the first place, we can conceive that the doubly-refractive inotagmata are not only in the thermal shortening, but also in the thermal lengthening, contracted once only. The shortening of the material in itself would then probably be caused only by the elastic power of the particles, passively extended to some extent by the heating of the inotagmata. The contraction after tetanic work, in consequence of the combination of other thermogenic molecules, be caused by the heat. The greater activity of the formative matter

of the living muscle-fibre, the place of the lost inotagmata would be continually or periodically filled by others, probably through the same process of organic crystallisation by which during ontogenesis the doubly-refracting particles in the muscle are produced and disposed.

Against this hypothesis, however, or at least against its general validity, various objections may be put forward. I will mention two only of the most important of them.

There seems to be no doubt but that the doubly-refractive particles of the muscle consist of an albuminous substance, and that they together make up a sensible part of the whole albumin of the muscle fibrils. In that case it would be most improbable that a great increase of muscular work should not at all, or very slightly only, increase the elimination of nitrogen. To account for this, we should have to recur to an auxiliary hypothesis, and assume either that the nitrogenous remainder of the destroyed inotagma is retained within the body—perhaps in the muscle—for purposes of anabolism, or, which is most improbable indeed, that other organs saved just as much albumin as was decomposed above the normal quantity during the contraction of the muscles.

A second objection consists in the fact that after heating tetanising muscles until they are rigid, the doubly-refractive power of the sarcois elements will be found still very great.

The other possibility is that the inotagmata may be preserved, and consequently on cooling may return to their former state, and therefore will do work by shortening as often as we choose. In this case muscle would not only seem to offer, but would offer in fact, a most striking resemblance to a thermodynamic machine, the solid particles of the framework of which are not destroyed through the chemical process producing the actual energy. No more than such a machine would the muscle require a perpetual renewal of the framework for the continuation of its activity; it would only want a periodic supply of fresh heating material.

This representation, as you see, will sufficiently account for the fact, which would otherwise remain surprising, that muscular work has such a small influence on the elimination of nitrogen. The facts of microscopic observation also agree with it.

But a farther discussion of the two possibilities would lead us too far. The purpose of this lecture was not to record a complete inquiry into all the phenomena of muscular activity. I have wished chiefly to draw attention to a series of facts which I hold to be of great importance for a deeper insight into the essence of muscular contractility, in so far as they prove the existence of certain material dispositions and processes admitting of closer experimental examination, by means of which mechanical work may be generated in the muscle by chemical energy.

THE SNAIL FAUNA OF THE GREATER ANTILLES.

THE West Indian Archipelago has long been known to present some interesting problems in the distribution of its land fauna. These peculiarities, it will be remembered, led Wallace to infer the previous existence of a land connection of the greater islands with one another and with the mainland; while others have claimed that the islands have always been distinct, and have been colonised by the agency of currents, winds, and other indirect means of dispersal. An interesting contribution on this subject has recently appeared in the form of a study of the distribution of the West Indian land and fresh-water molluscs, by Mr. C. T. Simpson, of the U.S. National Museum, from whose paper we extract the following conclusions. A considerable portion of the land snail fauna of the Greater Antilles seems to be ancient and indigenous. There appears to be good evidence of a general elevation of the Greater Antillean region, probably some time during the Eocene, after most of the important groups of snails had come into existence. At this time the larger islands were united, and were connected with Central America by way of Jamaica and possibly across the Yucatan Channel. There was then a considerable exchange of species between the two regions. At some time during this elevation there was probably a landway from Cuba across the Bahama plateau to the Floridean area, over which certain groups of Antillean land molluscs crossed. The more northern isles of the Lesser Antilles, if then elevated, have probably been since submerged. After the period of

elevation there followed one of general subsidence, and first Jamaica, then Cuba, and afterwards Haiti and Puerto Rico were separated. The connection between the Antilles and the mainland was broken, and the Bahama region, if it had been previously elevated above the sea, was submerged, the subsidence continuing until only the summits of the mountains of the four Greater Antillean islands remained above the water. Then followed another period of elevation, which has lasted no doubt until the present time, and the large areas of limestone uncovered (of Miocene, Pliocene, and post Pliocene age) in the Greater Antilles have furnished an admirable field for the development of the groups of land snails that survived on the summits of the islands. The Bahamas and the Lesser Antilles were subsequently raised above the surface, and have been colonised by forms chiefly drifted in the former case from Cuba and Haiti, and in the latter case from South America, while a few stragglers have been carried by sea no doubt from the Greater Antilles, and have settled on the more northern of the Windward Islands.

### UNIVERSITY AND EDUCATIONAL INTELLIGENCE.

A DEPUTATION from the Association of Head Masters of Higher-Grade and Organised Science Schools was received on Thursday last, by Mr. Acland, at the offices of the Science and Art Department; Major-General Sir John Donnelly being present at the interview. The deputation was the outcome of a very large and representative meeting of the association, held at Derby, to consider the new rules for organised science schools lately issued by the Department. The importance of the new regulations lies in the fact that under them a system of secondary schools will be inaugurated and carried on under the control of, and supported to a great extent by, the Science and Art Department. The organised science schools at present in existence include nearly all the more important higher-grade schools, the day schools of technical institutions, and a considerable number of grammar schools. The principal changes proposed in the new rules are the partial substitution of inspection for examination, the introduction of special courses of instruction for women students, the inclusion of a fair proportion of literary work in the curriculum, and the addition to it of practical work in physics and biology. A long discussion, lasting over two hours, took place, at the end of which Mr. Acland stated that he hoped to be able to meet the wishes of the deputation with regard to many of the points raised, and promised, at the end of a week or ten days, to make a definite statement of the alterations the Department would be prepared to make.

GEOMETRICAL Drawing has hitherto been included in Science Subject I. (Practical, Plane, and Solid Geometry) of the Science and Art Department. It has just been decided, however, to make Geometrical Drawing a separate subject under the Art portion of the Department's Directory; so the syllabus of the Elementary Stage of Science Subject I. will in future include only plane geometry, solid geometry, and graphic arithmetic. The changes will come into force for the session 1895-96.

THE Senate of Glasgow University have resolved to confer the degree of Doctor of Laws on the following:—Sir John Neilson Cuthbertson; Mr. James G. Fraser, Fellow of Trinity College, Cambridge; Mr. W. E. H. Lecky; Mr. David Robertson, Millport; Dr. T. E. Thorpe, F.R.S.; Surgeon-Major Lawrence A. Waddell, I.M.S., Bengal.

THE ninth Session of the Edinburgh Summer Meeting is arranged to take place in August. Prof. Geddes and Mr. William Sharp lecture in the section of Philosophy, Social Science, and Anthropology; and the prospectus also includes the names of M. Demolins, editor of the *Science Sociale*, of Dr. Wenley, Dr. Delius, and others. Under Civics and Hygiene are the names of Dr. Dyer, M. Paul Desjardins, M. Elisée Reclus, Dr. Irvine, Miss Jane Hay, and Dr. Stephens. Mr. Goodchild and Mr. Robertson undertake the department of Geography in its widest sense; while Mr. J. Arthur Thomson and Mr. Turnbull have charge of the Biology. There will be many other features of interest, including a series of educational conferences.

THE Professorship of Natural History at the Royal Agricultural College, Cirencester, rendered vacant in December last by the death of Prof. Harker, has now been filled by the appointment of Mr. Theodore T. Groom, late Scholar of St. John's College, Cambridge, and Lecturer and Demonstrator at the Yorkshire College, Leeds. Mr. Groom at one time occupied the Cambridge table at the Zoological Station, Naples, where he successfully carried out some valuable researches, the results of which were communicated to the Royal Society of London, and published in their *Philosophical Transactions*. The chair of Natural History at the College has been filled by a succession of very able men, among whom, in addition to Prof. Harker, may be mentioned such names as Buckman, McNab, and Threlton-Dyer.

### SCIENTIFIC SERIALS.

*American Journal of Science*, March.—The Appalachian type of folding in the White Mountain Range of Inyo County, California, by C. D. Walcott. In the broad paleozoic area between the Sierra Nevada on the west and the early paleozoic shore-line on the east (Colorado) a period of folding and thrust-faulting was followed by a period of vertical faulting, which displaced the strata that had been folded and faulted in the preceding epoch. The extent and character of this disturbance can only be determined by a careful study of each of these mountain ranges for a distance of over five hundred miles east and west, and probably one thousand miles north and south.—The succession of fossil faunas at Springfield, Missouri, by Stuart Weller. The rocks studied are beds of grey limestone with lenticular chert concretions, and form part of the Mississippian series. The faunas of the lower part of the section may be correlated with the Burlington faunas of Iowa, and those of the upper part with the Keokuk faunas. The whole series of faunas is continuous, and the whole series of rocks should be designated by a single name. The term Osage, suggested in 1891 by H. S. Williams, is recommended.—Dred boulders between the Mohawk and Susquehanna rivers, by A. P. Biigham. The Archaean and the more northern Paleozoic fragments are strewn over the whole district at all altitudes, but diminishing southward in size, and sparse in amount on the highest hills, especially to the southward, where the tops of the ranges are often surprisingly free from transported material. Actual reduction of the general surface towards base level doubtless proceeded rapidly during glacial time, but even then the process was rapid only in the geological sense, and the result a minute fraction of what has been accomplished since the region became a land surface.

*Bulletin of the American Mathematical Society*, vol. i. 5. (New York, February 1895).—On a certain class of canonical forms, by Mr. K. A. Roberts, is a paper, read before the Society at its December meeting, which treats of an interesting class of theorems occurring in the consideration of algebraical quantities.—"Hayward's Vector Algebra" is a review, by Prof. M. Bocher, of the algebra of coplanar vectors and trigonometry, which deals out praise and its opposite in about equal proportions.—Angular triangles on a conic is a very interesting paper by Prof. F. Morley.—The remaining short notices comprise an instance where a well-known test to prove the simplicity of a simple group is insufficient, by G. H. Miller, and an account of the Lobachevsky Memorial Volume, 1793-1893. Amongst the notes is a bare statement of Prof. Cayley's death.—The usual new publications list concludes the number.

*Symons's Monthly Meteorological Magazine* for March contains another striking proof of the severity of the frost in February last, as shown by the temperature of the earth at Camden Square, in the north-west of London. The thermometer with its bulb one foot below the surface was first read on January 1, 1871. Prior to 1895, it was never below 32°, and only reached that point in 1880. But in February last there were twelve consecutive days on which the thermometer was below 32°. In country districts, the frost penetrated to a much greater depth, and this subject will probably be referred to in a future number of the magazine. A careful observer at Berkhamsted states that the frost there penetrated to a depth of 1 ft 8 inches.

*Internationales Archiv für Ethnographie*, Band. vii. Heft v. and vi. 1894.—Prof. H. H. Gyllen, in his "Notes on some

remarkable Specimens of Old Peruvian 'Ars Plumaria,' gives a description of two very fine head-dresses in Ancient Peruvian feather work, which are illustrated by a beautifully executed coloured plate. It is strange, as the author points out, "that the specimens of Old Peruvian 'ars plumaria' unearthed from the tombs of Huacas, excavated but too often by vandalic treasure-seekers, have not attracted more attention." The best specimens of feather-roses were made in the sixteenth and seventeenth centuries, and the art has now practically died out.—Mr. S. H. Ray abstracts and annotates "Some Notes on the Language," by Rev. W. Gray. Mr. Gray has been a missionary in Tanna for twelve years, and so he can speak from adequate personal knowledge; he gives information on dress, circumcision, political organisation, war, kava, religion, social organisation and marriage, the calendar, the winds, and language. This is a valuable supplement to Dr. Codrington's monograph; the section on religion is of especial value. Dr. H. Ten Kate describes and illustrates a collection of ethnographical objects from the Timor Group. The supplement to vol. vii. of the *Archiv* is an account of the Narg, or the Siamese shadow-figures in the Völkerkunde Museum in Berlin, by Dr. F. W. K. Müller. A transcription and translation (in German) of the rhymes of the drama is given, which is a fragment of the Ramajana. It is illustrated by eleven plates, eight of which are coloured. Vol. viii. commences with the conclusion of Dr. Ten Kate's paper, which is illustrated by four plates. This part is of more general interest, as it deals partly with the religion and the sacred animals of the Timoree and other Indonesians; the author agrees with Pleyte, that the snake cult is indigenous to Indonesia, and is not borrowed from India. There is a useful little table of the distribution of certain objects.—S. K. Kusnezov writes on the death-cult of the Tscheremissie (a Ural-Altaic people on the Volga, near Kazan). These numbers of the *Archiv* contain the usual valuable notes and bibliography.

## SOCIETIES AND ACADEMIES.

### LONDON

Royal Society, January 17.—"On Slow Changes in the Magnetic Permeability of Iron." By William M. Mooney.

The conclusions to which the observations lead, so far as they have gone, are:—

(1) The effect is not fatigue of the iron caused directly by repeated magnetic reversals—it is not "progressive magnetic fatigue."

(2) Neither magnetic nor electric action is necessary to its production.

(3) It is a physical change resulting from long-continued heating at a very moderate temperature.

(4) It appears to be greater if pressure is applied during heating.

(5) It is not produced when the iron is not allowed to rise more than a few degrees above the ordinary atmosphere.

(6) It is similar to the effect produced by hammering, rolling, or by heating to redness and cooling quickly.

(7) The iron returns to its original condition on re-annealing.

(8) It does not return to its original condition if kept unused and at ordinary atmospheric temperatures, whether the periods of rest are short or long.

March 7.—"The Action of Heat upon Ethylene, II." By Prof. Vivian B. Lewis.

From the results of the experiments described in the paper it is stated that:—

(1) The initial decomposition of ethylene by heat is very rapid, and requires but a short flow through a heated containing vessel, although primary decomposition, however, being but slowly completed, owing to secondary reactions, which tend to reform ethylene.

(2) Dilution has but little effect in retarding the decomposition of ethylene, unless it be very large.

(3) Increase in rate of flow diminishes the amount of decomposition when the heated area is small, but rapidly diminishes in effect as the length of flow through a heated area increases.

(4) The decomposition of ethylene is chiefly caused by radiant heat, the effect of which is very great as compared with the decomposition due to contact with heated surfaces.

March 21.—"The Cause of Luminosity in the Flames of Hydrocarbon Gases." By Prof. Vivian B. Lewis.

The facts which appear to be established in this paper are:—

(1) That the luminosity of hydrocarbon flames is principally due to the localisation of the heat of formation of acetylene in the carbon and hydrogen produced by its decomposition.

(2) That such localisation is produced by the rapidity of its decomposition, which varies with the temperature of the flame and the degree of dilution of the acetylene.

(3) That the average temperature of the flame due to combustion would not be sufficient to produce the incandescence of the carbon particles within the flame.

In a paper on the action of heat upon ethylene, brought before the Royal Society this spring, the author showed that the decomposition of ethylene into acetylene and simpler hydrocarbons was mainly due to the action of radiant heat, and was but little retarded by dilution, whilst he has shown in this paper that the acetylene so produced requires a considerable increase in temperature to bring about its decomposition when diluted, and it is possible with these data to give a fairly complete description of the actions which endow hydrocarbon flames with the power of emitting light.

When the hydrocarbon gas leaves the jet at which it is being burnt, those portions which come in contact with the air are consumed and form a wall of flame which surrounds the issuing gas. The unburnt gas in its passage through the lower heated area of the flame undergoes a number of chemical changes, brought about by the action of radiant heat emitted by the flame walls, the principal of which is the conversion of the hydrocarbons into acetylene, methane, and hydrogen. The temperature of the flame quickly rises as the distance from the jet increases, and a portion of the flame is soon reached at which the heat is sufficiently intense to decompose the acetylene with a rapidity almost akin to detonation, and the heat of its formation, localised by the rapidity of its decomposition, raises the liberated carbon particles to incandescence, this giving the principal part of the luminosity of the flame; whilst these particles, heated by the combustion of the flame gases, still continue to glow, until finally themselves consumed, this external heating and final combustion adding slightly to the light emitted.

Any unsaturated hydrocarbons which have escaped conversion into acetylene before luminosity commences, and also any methane which may be present on passing into the higher temperatures of the luminous zone, become converted there into acetylene, and at once being decomposed to carbon and hydrogen, increase the area of the light-giving portion of the flame.

"On the Changes in Movement and Sensation produced by Hemisection of the Spinal Cord in the Cat." By C. D. Marshall.

"On the Analysis of Voluntary Muscular Movements by certain new Instruments." By Dr. W. R. Jack.

"On the Spark Spectrum of Argon as it appears in the Spark Spectrum of Air." By Prof. W. N. Hartley, F.R.S.

Chemical Society, March 7.—Dr. Armstrong, President, in the chair.—The following papers were read:—Dimethyl-ketohexamethylene, by F. S. Kipping. This substance is a colourless oil boiling at 174–176°, and is prepared by distilling calcium *aa*-dimethylmalate with soda-lime.—The use of barium thiosulphate in standardising iodine solution, by R. T. Plimpton and J. C. Chorley. Barium thiosulphate, BaS<sub>2</sub>O<sub>3</sub> · 11/2 H<sub>2</sub>O is well adapted for standardising iodine solution, inasmuch as it keeps well, has a high molecular weight, and is readily acted on by iodine.—The melting points of racemic modifications and of optically active isomerides, by F. S. Kipping and W. J. Pope. Dextro-rotatory and racemic  $\pi$ -monobromocampher melt at the same temperature, and the melting point of the one is not depressed by the presence of the other isomeride; the same is true of the inactive and dextro-rotatory  $\pi$ -monochlorocamphors.—Phenyl ethers of methylene- and ethylene-glycols. Synthesis of  $\alpha$ -methylbutyrolactone, by E. Haworth and W. H. Perkin, jun. A number of phenyl ethers of methylene- and ethylene-glycol have been obtained by the use of sodium phenate;  $\alpha$ -methylbutyrolactone has been synthesised from ethylic sodiummethylmalonate.—Methylsulbutylacetic acid, C<sub>11</sub>H<sub>16</sub>O<sub>2</sub>, C<sub>11</sub>H<sub>16</sub>O<sub>2</sub>, COOH, by W. H. Bentley and M. W. Burrows. This acid was prepared by the distillation of methylsulbutylmalonic acid, which in turn was synthesised from ethylic sodiummethylmalonate and isobutyl bromide.

Geological Society, March 6.—Dr. Henry Woodward, F.R.S., President, in the chair.—A new ossiferous fissure in Creswell Crags, by W. L. H. Duckworth and F. E. Swainson. The fissure explored by the authors is about 30 feet above the level of the artificial lake at Creswell Crags. At the top occurred a white earth (with human and other remains) passing down into a red sand with remains of fox, badger, roe-deer, and other mammals. Beneath the latter deposit, and separated from it by a fairly sharp line of demarcation, came the cave-earth proper with palæolithic implements and bones of *Rhinoceros tichorhinus*, *Bison priscaus*, *Ursus spelæus*, *Hyaena*, *crocuta* var. *spelæa*, and *Cervus tawandus*. The authors suppose that this cave-earth was derived from an older deposit, and had been transported to its present place by water, though there is evidence that the transport had been from no great distance. Consequently they followed the fissure inwards, until brought to a stop by a mass of travertine, which they penetrated with a small hole. They hope to explore the fissure beyond this travertine on a future occasion.—Notes on the chemical composition of some oceanic deposits, by Prof. J. B. Harrison and A. J. Jukes-Browne. The authors formerly experienced great difficulty in comparing their analyses of the oceanic deposits of Barbados with those of modern oozes made by Dr. Brazier. Since then Dr. Murray has placed samples of recent red clay and *Globigerina*-ooze at their disposal, and these were analysed by Prof. Harrison and Mr. John Williams. The results of analysis of the red clay were arranged as follows:—Argillaceous constituent 67.85 per cent., pumiceous matter 23.26 per cent., organic constituents 5.88, and adherent sea-salts 3.61 per cent. The authors found that the argillaceous constituent was not a mixture of an orthosilicate of alumina and hydrated peroxide of iron, having the proportion of silica to alumina as 14 to 12, but a more highly silicated compound in which the proportions were as 33 to 12. It was in fact a ferruginous earth, such as would result from the decomposition of palagonite and of a basic volcanic glass, fragments of which were frequent in the Pacific red clays. The pumiceous matter was the debris of an acid pumice containing 7 per cent. of soda, and apparently therefore the pumice of a sodi-felsite. Comparing the analyses of the recent red clay with those of Barbadian red clays, they find the differences to be such as would result from mixtures of the palagonitic earth with various acid and basic pumices. A mixture of the palagonitic earth with the pumiceous dust which fell on Barbados in 1872 would have a composition closely corresponding to that of the oceanic clay of Barbados. The recent calcareous ooze closely resembled the more calcareous "chalks" of the Barbadian oceanic series, but the latter contained much colloid silica and fine clay. The differences between the analyses of the recent ooze and of English chalk, when certain allowances are made, were found to be but small. The recent calcareous ooze contained many more *Globigerina*-tests than tertiary or mesozoic chalks, but it is suggested that this is due to our possessing only the surface-layers of the *Globigerina*-ooze. In one important respect all the different kinds of deposit which were examined resembled one another, namely, in the infinitesimally small quantity of quartz which they contained. The authors' examination of the recent oceanic deposits, and a comparison of them with the raised Barbadian deposits, only increased their conviction that the latter were of truly oceanic origin.

Linnean Society, March 7.—Mr. C. B. Clarke, F.R.S., President, in the chair.—Mr. A. Henry was admitted a Fellow.—On behalf of Sir Joseph Hooker, the Secretary exhibited a bronze medal struck in honour of the late Alphonse de Canolle.—Mr. J. E. Harting exhibited a remarkable head and horns of *Cupra agagrus* recently obtained by Mr. F. C. Selous in Asia Minor, and made remarks on the geographical distribution of this and other allied species.—Mr. G. F. Scott Elliot, who had been absent from England since September 1893, on a botanical exploration of Mount Ruwenzori and the country to the north of the Albert Edward Nyanza, gave an account of his journey and of the results, geographical, botanical, zoological, and political, obtained by him. The country lying north-east of the Victoria Nyanza was described as a large, rolling, grassy plain, some 6000 feet above sea-level, and well adapted for colonisation. He went west from the Victoria Nyanza to Mount Ruwenzori, which is said to have an altitude of 18,000 feet, and spent four months in exploring that district under the great disadvantage of a dense cloud hanging over the mountain the greater part of the day, which often pre-

vented the party from seeing more than fifty feet ahead. The sides of the mountain were clothed at the base with a thick growth of trees resembling the laurel of the Canary Islands; above that, bamboos to the 10,000-foot level; and above that again what the explorer could only liken to a Scotch peat moss in which the traveller sank at every step a foot or more. Large trunks like those of *Erica arborea* of the Canary Islands, but indicating trees 80 feet high, were noticed. Amongst other plants found were a *Viola*, a *Cardamine*, a gigantic *Isobelia* attaining a height of five or six feet, and a species of *Hypericum* resembling that found in the Canaries; indeed, the similarity of the flora to that of the Canary Islands was remarkable. Mr. Scott Elliot ascended Mount Ruwenzori to the height of 13,000 feet, finding evidence of animal life and numerous insects to a height of 7000 feet. Above 10,000 feet his Swahili porters could not sleep without injury to their health, and it was only with a reduced number of men that he was able to ascend another 3000 feet. Amongst the animals specially mentioned was a species of water buck (*Cobus*), a new chameleon, a new snake, and several new insects.—The Secretary then read an abstract of a paper by Dr. Maxwell T. Masters, on the genus *Cypripedium*, illustrated by a number of plants and cuttings which had been forwarded by Messrs. Veitch, Mr. Moore, of Glasnevin, and Dr. Acton, of Kilmacurragh.—Dealing with the zoological collections made during the recent expedition of Mr. Theodore Bent to Southern Arabia, Messrs. Kirby, Gahan, and Pocock presented papers on the insects and arachnida which had been obtained, some of which were described as new.

Royal Meteorological Society, March 20.—Mr. W. N. Shaw, F.R.S., delivered a lecture on "The Motion of Clouds considered with reference to their mode of formation," which was illustrated by experiments. The question proposed for consideration was how far the apparent motion of cloud was a satisfactory indication of the motion of the air in which the cloud is formed. The mountain cloud cap was cited as an instance of a stationary cloud formed in air moving sometimes with great rapidity; ground fog, thunderclouds, and cumulus clouds were also referred to in this connection. The two causes of formation of cloud were next considered, viz. (1) the mixing of masses of air at different temperatures, and (2) the dynamical cooling of air by the reduction of its pressure without supplying heat from the outside. The two methods of formation were illustrated by experiments. A sketch of the supposed motion of air near the centre of a cyclone showed the probability of the clouds formed by the mixing of air being carried along with the air after they were formed, while when cloud is being formed by expansion circumstances connected with the formation of drops of water on the nuclei to be found in the air, and the maintenance of the particles in a state of suspension, make it probable that the apparent motion of such a cloud is a bad indicator of the motion of the air. After describing some special cases, Mr. Shaw referred to the meteorological effects of the thermal disturbance which must be introduced by the condensation of water vapour, and he attributed the violent atmospheric disturbances accompanying tropical rains to this cause. The difference in the character of nuclei for the deposit of water drops was also pointed out and illustrated by the exhibition of coloured halos formed under special conditions when the drops were sufficiently uniform in size.

## PARIS.

Academy of Sciences, March 18.—M. Marey in the chair.—Attempts to produce chemical combinations with argon, by M. Berthelot. Argon has been submitted to the action of the silent discharge under the conditions described in the author's "Essai de Mécanique chimique," t. ii., pp. 362-363. The apparatus used was that described in the "Annales de Chimie et de Physique" [5], x., pp. 79, 76, and 77. With benzene vapour, argon is absorbed though more slowly than nitrogen. 87 per cent. of the volume of argon employed in the experiment entered into combination. As the total volume of argon at disposal was but 37 c.c., the products were too small in quantity to allow of any extended investigation into their nature. They appear to be similar in character to the products obtained with nitrogen and benzene. A yellow, resinous, odorless substance condensed on the surface of the two glass tubes; this substance decomposed on heating, yielding an abundant carbonaceous residue and volatile products which reddened litmus paper.—On the lacunæ in the zone of small planets, by M. O. Callandreaux.—Transformations of fibrin by

or prolonged action of dilute saline solutions, by M. A. Dastre.—On the variations of terrestrial latitudes, by M. F. G. ... —On the theory of a system of differential equations, by M. A. J. Stofkiewicz.—On a general definition of friction, by M. Paul Painlevé.—On Fourier's problem, by M. Le ... —Absorption of light in uniaxial crystals, by M. G. ... —The symmetry of uniaxial absorption is not so complete as the theory of the ellipsoid of absorption indicates. The symmetry is greater as the crystal is more birefringent.—On the potential of an electrified surface, by M. Jules André.—Apparatus imitating the movements executed by certain animals in turning round without external fulcra, by M. J. Im. Fouché.—The explanation of the movements of a cat, landing, always fall on its feet, given by M. Guyou, is completely borne out by the successful reproduction of the rotatory movement with a strictly mechanical model. The electric and symmetrical objective, by M. Ch. V. Zenger.—On the cells of secondary batteries, by M. Lucien Poincaré. The author describes a secondary battery with mercury for poles and sodium iodide in concentrated solution for electrolyte. The mercury electrode remains in solution, and the sodium forms an amalgam with the mercury. On discharge the yield is more than 60 per cent. of the theoretical. The battery is not affected by short circuiting or the particular manner of its discharge, but is unlikely to be practically used on account of the expensive nature of the materials, and the necessity of removing the amalgam from contact with the liquid if the battery is to remain long charged.—On the effect of an alternating electromotive force on the capillary electrometer, by M. Bernard Brunhes.—Thermochemical carbon battery, by M. Désiré Korda.—By the action of carbon on barium peroxide during the reduction of the latter to baronite, an E.M.F. of nearly 1 volt is produced when arranged as a cell. In the case given an internal resistance of 130 ohms was found. A similar arrangement with copper peroxide, the latter being separated from the carbon pole by dry, pure potassium carbonate, gave 1.1 volt with an internal resistance of 32 ohms.—Action of nitrous oxide on metals and metallic oxides, by MM. Paul Sabatier and J. B. Senderens. A table is given showing the comparative reactions of  $N_2O$ ,  $NO$ , and  $NO_2$  and air on a series of metals and oxides. The reduction is drawn that oxidations by means of  $NO$  are caused by the direct action of this gas without preliminary decomposition into its constituents.—Researches on the heats of combination of mercury with the elements, by M. Raoul Varet.—On the isomeric states of the oxides of mercury, by M. Raoul Varet. It is shown that yellow and red oxides dissolve in dilute  $HCN$  with liberation of the same amount of heat, and hence the transformation of yellow to red oxide gives no appreciable thermal effect. On the heat of formation of some compounds of iron, by M. H. Le Chatelier.—On the chlor-aldehydes, by M. Paul Rivals. A thermochemical paper.—On a mercuric combination of thiophene, permitting the estimation of the latter in commercial benzene and its extraction therefrom, by M. G. Denigés. A very stable combination of mercury and thiophene, having the composition  $SO_2.Hg.H_2O.SCl_2.H_2O$ , is obtained by treatment of thiophene with an acid solution of mercuric sulphate (made by dissolving fifty grams of mercuric oxide in 200 c.c. of pure sulphuric acid diluted with a litre of distilled water). On account of its insolubility and ease of formation, this compound may be used for the detection of traces of thiophene in benzene and for the purification of benzene.—On the amorphous state of melted substances, by M. C. Laurent.—Derivatives of active  $\alpha$  hydroxybutyric acid; by MM. Ph. A. Guye and Ch. Jordan. A paper giving optical relations and products of symmetry.—The production of wine and the utilisation of fertilising principles by the vine, by M. A. Muntz.—On the decortication of wheat, by M. Ballard.—On the parts taken respectively by purely physical and by physiological actions in the disengagement of carbonic acid by muscles isolated from the body, by M. J. Tissot.—Therapeutic action of currents of high frequency autoconduction of M. d'Arsonval, by MM. Apostoli and Dubioz. These currents have a powerful influence on the nutritive activity of the tissues, and hence are of first importance in the treatment of many functional troubles, caused by defective nutrition.—New application of the graphi. method to music, by M. A. Binet and J. Courcier.—Histological researches on the development of the Mucorini, by M. Maurice Leger.—On the ecology of *O. sola* (*Life Argentine*), by M. S. Traverso.—On the application of photography to oceanography, by M. J. T. ...

BOOKS, PAMPHLETS, and SERIALS RECEIVED

BOOKS.—Bird Notes: late J. M. Hayward (Longmans).—Statesman's Year Book, 1895 (Macmillan).—Qualitative Chemical Analysis of Inorganic Substances (American Book Company, New York).—Annals of British Geology, 1893: J. F. Blake (Dulau).—A Handbook of Systematic Botany: Dr. L. Warming, translated and edited by Prof. M. C. Potter (Sonnenschein).—Illustrations of the Zoology of H. M. Indian Marine Surveying Steamer *Zurich*. Part 1 (Quaritch).—Stanhord's Compendium of Geography and Travel (new issue)—Africa, Vol. 1: North Africa: A. H. Keane (Stanford, Enke).—Text Book of Anatomy and Physiology for Nurses: D. C. Kimber (Macmillan).—Chemical Analysis of Oils, Fats, Waxes, &c.: Dr. R. Benedict, revised and enlarged by Dr. J. Lewkowitzsch (Macmillan).—Taschenbuch für Flugtechniker und Luftschiffer: H. W. L. Moedebeck (Berlin, Kuhn).—Le Petrole, L'Asphalte et le Bitume: A. Jaccard (Paris, Acan).

PAMPHLETS.—Madras Government Museum, Bulletin No. 3: Rámévaram Island and Fauna of the Gulf of Mannaar: E. Thurston, 2nd edition (Madras).—Die Entwicklung: Dr. G. Pfeffer (Berlin, Friedlander).

SERIALS.—Royal Natural History, Part 17 (Warne).—Proceedings of the Royal Society of Victoria, Vol. vii, new series (Melbourne).—American Naturalist, March (Philadelphia).—Astrophysical Journal, March (Chicago).—Journal of the Institution of Electrical Engineers, No. 115, Vol. xxiv (Sp. n.).—Economic Journal, March (Macmillan).—Botanische Jahrbücher, Neunzehnter Band, v. Heft Leipzig, Engelmann).—Transactions of the Astronomical and Physical Society of Toronto for the Year 1894 (Toronto, Kowalew).—Zeitschrift für Physikalische Chemie, xvi, Band, 2 Heft (Leipzig, Engelmann).—Minnesota Botanical Studies, Bulletin No. 9 (Minneapolis).—Notes from the Leyden Museum, Vol. xvi, Nos 3 and 4 (Leyden, Brill).—Good Words, April (Isbister).—Sunday Magazine, April (Isbister).—Longman's Magazine, April (Longmans).—Quarterly Journal of Microscopical Science, No. 147 (Churchill).—Bulletin of the Geographical Club of Philadelphia, Vol. 1, No. 3 (Philadelphia).—Bulletin of the U.S. Geological Survey, No. 12 (Washington).

CONTENTS.

	PAGE
Orb-Weaving Spiders of the United States. By Rev. O. P. Cambridge, F.R.S. . . . .	505
The Sea and its Coasts . . . . .	507
The Chemistry of Cod-liver Oil. By Jas. Cameron	508
Our Book Shelf:—	
Wislicenus: "Astronomische Chronologie."—W. J. S. L. . . . .	509
Hellmann: "Die ältesten Karten der Isogonen, Isoclinen, Isodynamen" . . . . .	509
Briggs: "An Elementary Text-book of Hydrostatics" . . . . .	509
Letters to the Editor:—	
The Statistical Investigation of Evolution.—J. T. Cunningham . . . . .	510
A True Spectrum Top and a Complementary One.—Dr. C. Herbert Hurst . . . . .	510
A Foucault Pendulum at Dublin.—W. R. Westropp Roberts . . . . .	510
Snake Cannibalism.—J. Schonland . . . . .	511
American Fresh-water Sponges in Ireland.—Dr. R. Hanitsch . . . . .	511
Peripatus in the West Indian Islands.—J. H. Hart . . . . .	511
Planetary Photography.—C. T. Whitmell . . . . .	511
Cleaning Tobacco Pipes.—Cecil Carus-Wilson . . . . .	511
The Habits of Limpets. By Prof. J. R. Ainsworth Davis . . . . .	511
Terrestrial Helium (?) . . . . .	512
Notes . . . . .	513
Our Astronomical Column:—	
The Moon and Atmospheric Waves . . . . .	516
Stellar Photography . . . . .	516
Standard Time in Australia . . . . .	516
Nova Aurigæ . . . . .	516
New Compounds of Hydrazine with Fatty Acids. By A. E. Tutton . . . . .	516
The Aurora of March 13 . . . . .	517
The U.S. Units of Electrical Measure ( <i>With Diagram</i> ) . . . . .	518
On the Nature of Muscular Contraction ( <i>With Diagram</i> ). By Prof. Th. W. Engelmann . . . . .	519
The Snail Fauna of the Greater Antilles . . . . .	524
University and Educational Intelligence . . . . .	525
Scientific Serials . . . . .	525
Societies and Academies . . . . .	525
Books, Pamphlets, and Serials Received . . . . .	525

THURSDAY, APRIL 4, 1895.

## VERWORN ON GENERAL PHYSIOLOGY.

*Allgemeine Physiologie. Ein Grundriss der Lehre vom Leben.* Von Max Verworn. (Jena: Fischer, 1895.)

THIS handsome and well-illustrated volume of some six hundred large octavo pages, by a young German physiologist already favourably known by his special researches, is ambitious in design but praiseworthy in purpose. The author complains of the too narrow character of most of the physiological inquiries and writings of the present time; and not without some justice. A cursory reader of a modern text-book of physiology (of my own, for instance), might easily come to the conclusion that most of our current physiological doctrines had been arrived at by the exclusive study of the frog, the rabbit, and the dog, with occasional help from that of the horse, of a fish, of a bird, and of man. All the wealth of opportunity for observation and experiment offered by the innumerable other forms of life, seems to be neglected. And there follows naturally the inference that physiology would gain a healthier tone and broader grasp, by widening the field of its study. Years ago the great Johannes Müller, in his immortal work, took such a broad survey; later on, Carpenter followed the same course in his "Comparative Physiology," a work to which I, at least, owe much; and now Dr. Verworn attempts to present, in a general view, the light which the multitudinous special researches of more recent days have shed on the fundamental phenomena of life.

A very little reflection will show that when the meaning of the term physiology is carried beyond the bounds which academic conditions have fixed for it, it becomes difficult to say what parts of the knowledge of living beings are not embraced by it. A physiologist, withdrawing himself from the immediate demands of the schools, and brooding over the many aspects of his science, cannot help feeling that all inquiries into the phenomena of life end by taking the form of physiological inquiries. While morphological facts may, in the first instance, and for a while, be regarded by him chiefly as helps towards the solution of special physiological problems, he cannot help believing that the ultimate interpretation of the phenomena of form must be based on the principles of that fundamental physiology, which, for want of a better word, we may call molecular. And, even at the present time, imperfect as physiology as yet is, some of us may think that some modern morphological speculations have gone astray, through heed not being given to what even a narrow imperfect physiology is already able to teach.

Hence, Dr. Verworn, taking as the title of his book "General Physiology," has naturally been led to dwell on many topics which are not to be found in a treatise of narrower scope. After a very brief historical sketch, and a chapter on the composition or nature of living matter, in which he discourses on the "cell" and its constituents, and on the physical and chemical properties of living matter, as well as on the differentials of living and lifeless matter, he proceeds to the consideration of

the elementary phenomena of life. These he treats under the heads of change of substance (metabolism), change of form, in which such topics as heredity, adaptation, cell division, reproduction and the like are dealt with, and change of energy. Then follows a chapter on "The General Conditions of Life," in which, among other matters, he treats of the origin of life on the globe, and the history of death. "Stimuli and their effects" are next discussed, and the final chapter is headed the "Mechanism of Life."

Even six hundred goodly pages furnish all too small a room for such a treatment of each of the many and varied topics handled in them as would in each case appear adequate to those who had made them the objects of special study. Moreover, the author, as he states in the preface, has striven to write in such a way that the reader should not be easily wearied; and the practised writer knows that a simple way of not wearying the reader is by a light touch, so to brush away all difficulties as to lead the reader to think he grasps clearly that which, in reality, no one truly understands. The author further, as he also states, addresses himself not to physiologists, or even to biologists, exclusively, but also to the cultured general reader; and when a discussion about an abstruse physiological topic has to be so conducted as to please the ear of the cultured general reader, the special physiologist naturally finds the discussion spoiled by things which to him seem essential, being left out, and by things which to him seem unimportant, or even irrelevant, being dwelt upon at length. It would be ungracious, therefore, to find fault with the particular way in which the author handles that or that of the many themes with which he deals. For the same reason, hesitation may be felt in objecting to the prominence given in the work to definitions, some of which a captious critic might urge had something of the mark of barrenness, or to the frequently occurring judicial "summing up" in paragraphs emphasised by spaced type; or to the abundant "generalisations," some of which may be contested, while others appear to draw perilously near to platitudes. The work, as a whole, must commend itself highly to those morphologists who desire to learn the more general and fundamental results of recent physiological inquiry; for the author has woven into his work the very latest news from the physiological laboratory. On the other hand, the physiologist, whose activity has been too much limited to the study, by complicated instruments of precision, of the phenomena of the higher animals, who has moved too exclusively in what some take pleasure in hall-marking as "horological physiology," will largely profit by having his attention directed to the many physiological questions which arise in the course of morphological investigations, started by observations recorded, for the most part, in periodicals or works not falling within his ordinary reading. As especially interesting, perhaps, may be mentioned the chapter on stimuli and their effects, as illustrated by the study of the simplest forms of life, and the discussion on the part played by nuclei in the development of physiological phenomena, in both of which matters the author is able to appeal largely to his own observations. Very suggestive also is the exposition of the doctrine of assimilation and dissimulation and of its applications,

which forms a large part of the chapter dealing with "the mechanism of life."

The author claims for his work, that it is essentially an exposition of "cellular physiology." I am myself inclined to think that he exaggerates the value of this point of view. The idea of the cell, important as it has been, and still is, when we deal with the cell as a morphological unit, seems to me of much less importance when we deal with it as a physiological unit. But I pass this over, in order to join issue with the author on two other matters. He speaks "of the impotence of the physiology of to-day, when brought to face the simplest processes of life," and writes as if all the knowledge which, especially during the last thirty years, has been gained by the application of exact physical and chemical methods to the study of the phenomena of life, simply led to the end of a blind alley. He urges that, while we are rapidly approaching perfection in these things, we yet are impotent in face of the deeper problems. He even goes very near repeating the taunt of the Philistine, "With all your boasted progress, you are still unable to tell us *what life is*," with, however, the difference that he uses the taunt in order to incite physiologists to adopt other methods of inquiry. I venture to think that in this the author is quite wrong. Not only has the progress of physiology, due to the use of exact methods, been remarkable during the last half-century or so, but also by those methods we have been drawn measurably nearer the inner and hidden mysteries. To take one instance among many, the application of exact physical methods to the study of muscles, so far from having brought us to a point beyond which we cannot go, seems just now to be opening up the way to fruitful conceptions of the intimate nature of muscular contraction—conceptions which would have been impossible in the absence of the knowledge gained by the graphic method. Two armies, from two different sides—one physical, the other chemical—are attacking that difficult—to some it seems impregnable—fortress. They have already gained many of the outworks: they are pressing on, drawing nearer to each other; and when they touch hands, they will do that which will put to shame all scoffs at their impotence.

Then again, the author finds fault with the preponderant attention given by physiologists to the study of the higher vertebrate animals; he blames them for their comparative neglect of the lower and, especially, of the lowest invertebrate forms. It is not for me, who in my rash youth had wild dreams of building up a new physiology by beginning with the study of the amoeba, and working upwards, to say one word against the experimental investigation of the lower forms of life. But experience and reflection have shown me that, after all, the physiological world is wise in spending its strength on the study of the higher animals. And for the simple reason that in these, everything being so much more highly differentiated, the clues of the tangles come, so to speak, much more often to the surface, and may be picked up much more readily. Taking again, as an instance, the molecular processes which give rise to the movements of animals, and which appear under such forms as that of amoeboid movement, and that of the contraction of a striated muscle, I venture to think that the very apparent simplicity of the former is an obstacle

to our getting a real grasp of its inner nature, and that by our studies of the complex muscle, we are drawing nearer to such a grasp than we could ever have done by observations confined to the phenomena of the amoeba itself. And so in many other instances. The study of the lower forms of life is, in reality, more difficult than that of the higher forms: and the latter naturally comes first. At the same time the author will have the sympathy of all, if his contention be limited to the assertion that the full fruition of physiological truth can only be reached by the careful study of all forms of life, whether high or low: this, indeed, his own special investigations have already shown, and in this sense the contribution to a "general physiology," which his present volume offers, is gladly welcomed by us all. M. FOSSIER.

#### NERNST'S THEORETICAL CHEMISTRY.

*Theoretical Chemistry, from the Standpoint of Avogadro's Rule, and Thermodynamics.* By Prof. Walter Nernst, Ph.D. of the University of Göttingen. Translated by Prof. Charles Skeelee Palmer, Ph.D. of the University of Colorado. Pp. xxv. 697. (London: Macmillan and Co. 1895.)

NO one can compare the knowledge we possess to-day of the conditions and general laws of chemical change with the state of our knowledge ten years ago, without being much impressed by the enormous advances made in the last decade. Accurate and generalised knowledge of physical chemistry did not exist ten or twelve years ago. What is practically a new science has arisen, based on the work of such men as Guldberg and Waage, van't Hoff, Ostwald, Arrhenius, Nernst, Raoult, Gibbs, and Thomsen, who built upon the foundations laid by Dalton, Avogadro, Berthollet, Faraday, Helmholtz, Thomson, and Clausius. The special mark of the new science is that it has been produced, to use the words of Nernst, "by the co-operation of two sciences which hitherto have been, on the whole, quite independent of each other." One hardly knows whether to speak of *physical chemistry* or *chemical physics*.

The text-book of this new science is Ostwald's "Lehrbuch der Allgemeinen Chemie." Notwithstanding the thoroughly satisfactory character of that work, there was room for another book which should treat the subject in less full detail, and which should pay especial attention to the data and the conceptions that have been systematised and applied in a general way. Prof. Nernst has written exactly the book that was wanted; and this book now appears in a form which brings it within the reach of all English-speaking students.

The *Theoretical Chemistry* of Prof. Nernst deals with (1) the universal properties of matter, (2) the atom and the molecule, (3) the transformations of matter, and (4) the transformations of energy. The first section treats of (1) the gaseous, (2) the liquid, (3) the solid, state of aggregation, (4) the physical mixture, and (5) dilute solutions. The second section is devoted to (1) the atomic theory, (2) the kinetic theory of the molecule, (3) the determination of molecular weight, (4) the constitution of the molecule, (5) physical properties and molecular structure, (6) the dissociation of gases,



(7) electrolytic dissociation, (8) the physical properties of salt solutions, (9) colloidal solutions, and (10) the absolute size of molecules. Sections three and four are concerned with the subject of affinity. The author treats that part of this subject which is connected with the transformations of matter under the headings: (1) the law of chemical mass-action, (2) chemical statics in (a) homogeneous, and (b) heterogeneous systems, (3) chemical equilibrium in salt solutions, and (4) chemical kinetics. In dealing with the energetics of chemical affinity, Prof. Nernst treats of (1) the applications of the first law of heat, (2) temperature and (a) complete, (b) incomplete, chemical equilibrium, (3) temperature and the velocity of reactions, (4) heat and chemical energy, (5) electrochemistry, (6) photochemistry. An appendix contains accounts of the more important developments of theoretical chemistry in the year 1893.

The ground covered by the book is evidently very large, and very different from that traversed by the books on theoretical chemistry published ten years ago.

Theoretical chemistry, as understood by Nernst, is based on Avogadro's law, and van't Hoff's extension of that law to dilute solutions, the law of mass-action, and the laws of thermodynamics. It would not be very far from the truth to say that the book is concerned with the meaning of the sign of equality in chemical equations, and that the connotation of that sign is elucidated by applications of the laws of Avogadro and van't Hoff, and the law of mass-action, bound together and lighted up by the laws of thermodynamics.

The essential characteristics of the book, so far as I can judge, are the exceeding clearness in the statement of each problem of theoretical chemistry, the cutting out of irrelevant issues, and then the binding together of the apparently detached discussions into an harmonious whole by the application of the general principles of the molecular-atomic theory, and of chemical energetics.

The treatment of *osmotic pressure* may be chosen as an illustration of these characteristics of Prof. Nernst's book. The meaning of the term *osmotic pressure* is made clear on pp. 118-119, by the description of a theoretical experiment on the diffusion of sugar in aqueous solution through a semi-permeable partition fitted with a movable piston. Unfortunately, the translator has rendered *Lösungsmittel* by "solvent material"; had he used the term "solvent" (as he does in some other passages), the meaning would have been better conveyed. Then follow lucid paragraphs on the methods of measuring osmotic pressure (I wish the translator had not allowed the phrase to pass, "ether containing considerable benzene"), admirably illustrating the bearings on this problem of determinations of vapour-pressures, boiling points, and freezing points. Having thus, by adhering strictly to the problem under discussion, arrived at a clear conception of osmotic pressure, the author proceeds, in a few brief and clear paragraphs, to consider the circumstances which condition the osmotic pressures of solutions, viz. the concentration of the solution, the temperature, the nature of the dissolved substance, and the nature of the solvent. The outcome of the matter is then summed up in the statement—*the lowering of the freezing point of a dilute solution is proportional to the number of molecules of the dissolved substance*. This

summary at once suggests an inquiry into the range of applicability of the law of osmotic pressure, and the laws of solution in general; and the inquiry leads to a statement of van't Hoff's extension of the law of Avogadro. The experimental determination of molecular weights by the application of the van't Hoff generalisation is described (pp. 224-231) in that part of the book which deals with the determination of molecular weights. When the author comes to treat of dissociation he returns to the subject of osmotic pressure, and shows how an application of the hypothesis of dissociation to salts in dilute aqueous solutions leads to a far-reaching theory of chemical change, and he propounds this theory in a clear and practical manner. In one of the chapters dealing with thermochemistry (pp. 565-567), the author, following van't Hoff, brings the subjects of osmotic pressure and electrolytic dissociation within the range of thermodynamical methods, and, by a fundamental equation, connects the equilibrium of a chemical system with such conditions as temperature, pressure, and dissociation. Had Prof. Nernst been tempted to discuss such a side issue as the part played by the solvent in bringing about electrolytic dissociation, he could not have arrived at the very general results to which his strictly accurate and limited method of inquiry have led him. He does, indeed, devote a paragraph or two to this matter of the action of the solvent (e.g. pp. 232, 444). He is careful to note the great interest and importance of the question; at the same time he draws attention to the fact, often overlooked, that no definite answer can be given to questions regarding the existence of compounds of molecules of the solvent with molecules of the dissolved substance by the study of the osmotic pressures of dilute solutions, because the existence of such compounds would not affect the osmotic pressures of fairly dilute solutions.

Prof. Nernst dismisses the so-called *hydrate theory of solution* in a short and somewhat contemptuous paragraph (p. 444); he speaks of this conception as having no theoretical basis, as having led to no general laws, and as based on an uncritical examination of experimental data.

A very admirable feature of the book is the care taken to warn the student against drawing unsound and inapplicable deductions from sound generalisations. For instance, at the beginning of the chapter on the physical properties of salt solutions (p. 331), the statement is enunciated that *the properties of an aqueous solution of a salt are made up, additively, of the properties of the free ions*. And then the illegitimate and misleading inferences which may be, and some of which have been, deduced from this generalisation are noted in a few sentences, before the true meaning and applicability of the statement are developed.

I should like to deal at length with the author's treatment of the law of mass-action, and the many applications and developments of this law; but space forbids. Among the applications of the law of mass-action I would ask the student to note that which serves to explain the discrepancies among the values for the *strengths* of acids obtained by Ostwald by employing different methods of measurement (p. 438).

The volume literally abounds in suggestions; new light is thrown on almost every question of theoretical

chemistry. When this book becomes generally known and studied by English chemists, it seems to me it will be impossible for any of them to refuse to acknowledge the marvellous advances which have been made in the science by the introduction of the conception of electrolytic dissociation.

I would recommend every student of advanced chemistry to study this work. Merely to glance through it is little use: it must be studied laboriously; and it will well repay the labour. Of course there are weak parts in the book. I think the treatment of *the constitution of the molecule* is too sketchy; and chapter vi. of Book iv., on *electrochemistry*, should, in my opinion, have been either expanded or omitted.

Of the translation it is difficult to speak advisedly. I think the translator has attempted an impossible task, the task, namely, of literally changing German into English. If the meaning of sentences in one language is to be conveyed in another language, it seems to me that a paraphrase, not a so-called literal translation, is needed. The task of translation must have been extremely difficult; the subject-matter is complicated, and German is not a language distinguished by its lucidity. The meaning of the original is conveyed on the whole; but the sentences read strangely. See, for instance, the most peculiar sentence near the bottom of page 501. There is an extraordinary sentence about plucking fruit from stepping-stones, on p. 354. Several cases of absolute mistranslation are to be found; for instance, the sentence in italics in the ninth and tenth lines from the bottom of p. 254, and the sentence at the beginning of Book iii., p. 353. *Beliebig* is sometimes translated "casual," sometimes "selected."

I admit the great difficulty of the task undertaken by the translator: as I have said, he has generally succeeded in conveying the meaning of the original; but I think the rendering into English might have been at once more accurate, more elegant, and more readable.

M. M. PATTISON MUIR.

#### OUR BOOK SHELF.

*Bird Note.* By the late Jane Mary Hayward. Edited by Emma Hubbard. Pp. 181. (London: Longmans, Green, and Co. 1895.)

*Catalogue of the Birds of Prey (Accipitres and Striges).* By J. H. Gurney, F.Z.S. Pp. 56. (London: R. H. Porter, 1894.)

A Dainty book is Miss Hayward's, the pretty little process-blocks, representing a number of our common birds, matching the short sketches of avian habits. The lamented author had a "deep-rooted love of the beauty of the world." She was a close and unwearied watcher of bird traits, and her notes possess the charm of all original observations. From a scientific point of view, the chief failing of many of the notes is that they endow the birds too largely with human consciousness. Mrs. Hubbard recognises the objection, and says something in favour of this "anthropomorphism"; but while such fancies are poetically attractive, and may be psychologically justifiable, they must always be of less value than the facts which give them birth.

The ornithological papers of the late Mr. J. H. Gurney were both numerous and important, and in the volume

under notice we have further evidence that the son worthily carries on his father's interest in the collection at Norwich Museum. All the birds of prey (hawks and owls) in the Museum were catalogued by Mr. J. Reeve, the veteran custodian, and from this MS. catalogue, and his father's "List of Diurnal Birds of Prey," Mr. Gurney has compiled the list of Accipitres and Striges. According to the list of the former order, the total number of existing species of diurnal birds of prey is now 470, of which at least 89 are only sub-species. The total number of existing species of owls is placed at 268, of which 87 appear to be only sub-species.

Before each bird's name, in the two lists, a letter is placed to mark the zoological region to which it belongs, on Mr. Scater's classification. A striking testimony to the efficiency of this system is given by Mr. Gurney, in the following words: "The way in which these several divisions [Mr. Scater's] are justified by the Birds of Prey, and especially by the Diurnal Birds of Prey, is remarkable, and if they were to be decided afresh by that class of birds alone they could not very well be improved upon. Seven-eighths of the Raptores are found in one region only—*i.e.* not in more than one; and the region which has the greatest number is the Neotropical or South American region, which contains 181 Hawks and Owls."

The whole of the Raptorial collection of Norwich Museum is now being transferred to Norwich Castle; and the completeness of the collection can be judged from the fact that it comprises 403 out of the total of 470 accepted species and sub-species of Accipitres, and 195 out of 268 known species and sub-species of the order of Striges. Mr. Gurney may well be proud of the collection, and of the fine Castle Museum in which it is housed.

*Prince Henry the Navigator.* By C. Raymond Beazley, M.A., F.R.G.S. (Heroes of the Nations Series.) (Putnam's Sons.)

IN this most interesting and valuable book, Mr. Beazley shows us clearly the growth of geographical knowledge, carrying his researches back earlier even than 130 A.D., he tells us that the first maps and charts of the old world are due to Eratosthenes and Strabo. Ptolemy succeeded them, improved their work, and, where knowledge failed him, made errors himself; the author writes thus of his great chart: "Never was there a clearer outrunning of knowledge by theory, science by conjecture, than in Ptolemy's scheme of the world (c. A.D. 150)."

We gather much information concerning Greek and Arabic geographers, of the early Christian pilgrims, and of the discoveries of the Norsemen. Throughout the book, we watch, as it were, the growth and improvements of the maps and charts. We see the expansion of geography due to the crusades and land travel. Finally we are brought to Prince Henry the Navigator himself. From youth upwards, retired and studious, he withdrew himself at the age of twenty-one to his Naval Arsenal at Sagres, and devoted the rest of his life to the accomplishment of his three chief objects—"to discover, to add to the greatness and wealth of Portugal, and to spread the Christian faith." We can but marvel at this great man, at the untiring energy with which he worked, but still more at the greatness of that work.

Mr. Beazley has treated the subject in a very thorough and interesting manner, and the numerous maps form a most important part of the book; they date from 130 A.D.-1492. No pains have been spared to make the subject quite clear to the student. All through the book we see how the dominion of the sea has been continuously enlarged by the perpetual application of science to the art of navigation.

W.

*An Elementary Treatise on Theoretical Mechanics.*  
Part iii. Kinetics. By Alexander Ziwet, Assistant Professor of Mathematics in the University of Michigan. (New York: Macmillan and Co., 1894.)

THE first two parts of this excellent treatise have already been noticed in these columns; this third part keeps up to the same excellence, and we look forward to a sequel, in the absence of any indication that the treatise is yet complete.

We think the author would have done well to have followed the opinion of his American colleague, Prof. T. W. Wright, and to have reserved absolute measurements to the Metric system of units, while using gravitation units only with the British foot and pound. These last units are too insular and provincial ever to be employed in cosmopolitan problems where results have to be translated into absolute measure; and James Thomson's word, *poundal*, is never likely to be of any practical use.

Lagrange's and Hamilton's general dynamical equations are expounded with clearness and elegance; the application of the principle of the Conservation of Areas to the paradoxical motion of a kitten, let fall by his feet a short distance above a table, has excited considerable discussion recently at the Paris Academy of Sciences; this problem would provide the author with an illustration of the methods of generalised coordinates.

The copious list of authorities at the end of the chapters is a valuable feature of the book.

G.

LETTERS TO THE EDITOR.

*The Editor does not hold himself responsible for opinions expressed by his correspondents. Neither can he undertake to return, or to correspond with the writers of, rejected manuscripts intended for this or any other part of NATURE. No notice is taken of anonymous communications.*

Destruction of the Seismological Observatory at Tokio, Japan.

I REGRET to say that a letter, which has just arrived from Tokio, informs me that Prof. John Milne has lost all his valuable seismographic instruments, with his library and many manuscripts, through a fire which has occurred at his house and observatory. Prof. Milne wishes me to announce that his address-book has been destroyed, but he will be able to forward vol. iv. of the *Seismological Journal* to those entitled to it, if they will send in their names to him, "care of the *Japan Mail* office, Yokohama." He further wishes me to state that he has 600 damaged copies of the Seismological Society's *Transactions*, and that from these he will be bappy to complete sets. Applicants for the copies of the *Transactions* should address Prof. Milne, care of the Geological Society, Burlington House, London, W.

I am sure that scientific men all over the world will feel the deepest sympathy with Prof. Milne in his great and, indeed, irreparable loss. He was preparing to return to Europe when the fire occurred, and he wishes to appeal to all who can furnish him with separate copies of papers relating to earthquake phenomena, to replace, so far as is possible, those he has lost by the destruction of his library.

JOHN W. JUDD.

April 1.

On Mersenne's Numbers.

IN 1644 the mathematician Mersenne asserted that out of the 56 primes not < 257, there were only 12 primes, viz. :-

$$q = 1, 2, 3, 5, 7, 13, 17, 19, 31, 67, 127, 257,$$

which, taken as exponent ( $q$ ), make the number  $N = (2^q - 1)$  also prime. No proof was published, and even up to now, this statement has only been partially verified: the verification is still one of the difficult problems of higher arithmetic. According to a paper by Mr. W. W. Rouse Ball, in the *Messenger of Mathematics*, vol. xx. p. 34, Mersenne's statement has been verified for the 18 prime values of  $q < 60$ , and for 14 higher values, and one additional number  $N$  has been shown to be prime by Prof. Seelhoff, viz. when  $q = 61$ . This left 23 cases

unverified, viz. 3 supposed to be prime (when  $q = 67, 127, 257$ ), and the remaining 20 supposed to be composite (when  $q = 71, 89, 101, 103, 107, 109, 137, 139, 149, 157, 163, 167, 173, 181, 193, 197, 199, 227, 229, 241$ ).

I have recently discovered the verification of one of the latter viz. that

$$(2^{197} - 1) \text{ is divisible by } 7487.$$

This can be readily verified directly by the method of Congruences.

It has also been verified by actual division by Mr. R. Tucker (Sec. London Mathematical Society), who has kindly sent me the quotient consisting of 56 figures. The mode of discovery of this factor has been communicated to the London Mathematical Society, and will be sent to one of the mathematical journals.

ALLAN CUNNINGHAM.

March 23.

Tan-Spots over Dogs' Eyes.

I TRUST you will allow me to point out that the drift of my letter on the above subject in NATURE, vol. l. p. 572, has not been fully apprehended. Hitherto we seem to have no very clear cases in which we can actually trace the operation of "natural selection." I think, when examined, this will be found to be an instance.

The spots appear to have arisen in the dog as comparatively recent permanent markings—for protective purposes—after semi-domestication. As Mr. Worthington G. Smith says, they are not seen among wild animals allied to the dog.

They appear to have arisen since the original Red Dog—he he Dhole, Pariah, or Dingo—became pied, and at times *black*, through domestication. It is only on a black coat that the tan-spots would be conspicuous, and simulate eyes.

Perhaps Mr. A. R. Wallace may throw light on the matter. The spots seem to be the only really permanent marking among dogs, and are now being bred out.

S. E. PEAL.

Sibsagar, Asam, February 19.

MR. PEAL's suggestion appears to be a probable one, and is supported by Mr. Worthington Smith's observations (NATURE, vol. li. p. 57). The spots may have been protective to the animals during sleep, causing them to look as if awake. The reason that they do not occur in wild dogs may be that the latter conceal themselves when sleeping, which the half-domesticated animals were not able to do.

ALFRED R. WALLACE.

THE AGE OF THE EARTH.

SINCE physicists do not seem to be in complete accord on the question of the time which has elapsed since the earth first permanently crusted over, it may perhaps be as well to investigate the evidence to be obtained from a study of stratified deposits.

One of the first to raise a remonstrant voice against the philosophers who demanded practically unlimited time was Sir Archibald Geikie, whose original discussion of the data known regarding the present working of rivers gave us the fraction  $\frac{1}{5000}$  as representing the annual rate at which the Mississippi is lowering its basin. The surprise with which this result was received is now almost forgotten, in an unquestioning acceptance. The question of the rate of deposition was next treated by Dr. Haughton, in the year 1880, with his usual mathematical severity. Dr. Haughton, however, preferred to take into consideration six other great rivers besides the Mississippi, and thus obtained the fraction  $\frac{1}{5000}$  as representing the average thickness of rock which is annually worn away from the terrestrial surface by the denudation of rivers. But the proportion of sea-bottom to land surface is as 145:52, so that if the suspended sediment be spread evenly over the sea-floor, the average rate of accumulation will be  $\frac{1}{5014}$  of a foot per annum. The maximum thickness of the stratified series was estimated by Dr. Haughton to be 177,000 feet, and thus if the rate of deposition in the past was on the whole

uniform and the same as that of the present, this thickness of rock would have required a period of 1,520,750 years for its accumulation. Dr. Haughton is not a uniformitarian, consequently he divided this number by 1. Dr. Wallace next made what must be considered a great step in advance, by pointing out that the sediment which is carried into the sea is not deposited uniformly over the whole sea-floor, but, as the *Chesapeake* dredgings clearly showed, along a comparative narrow marginal tract. Instead, therefore, of multiplying  $\frac{1}{1000}$  (the yearly rate of denudation) by  $\frac{1}{1000}$ , he divided it by  $\frac{1}{1000}$ , the proportion of the area of maximum deposition to the area of denudation, and thus obtained 28 millions as the number of years required for the accumulation of 177,000 feet of rock.

A further correction was next made by Mr. C. Davison, who showed that the fraction  $\frac{1}{1000}$  is obtained by an error in arithmetic, and that the true value is  $\frac{1}{1000}$ . Introducing this fraction into Mr. Wallace's calculation, we obtain in round numbers 22 millions of years, a close approximation to the result, deduced from physical considerations, by Mr. Clarence King.

Of late years considerable additions have been made to our knowledge of the thickness of the systems of stratified rock, and I present the following table as representing the maximum thickness of all known formations down to the base of the Cambrian, a definite horizon marked, as is well known by the occurrence of fossil remains of most of the great subdivisions of the Invertebrata:—

System	Thickness in feet.	First appearance of
Cambrian ...	16,000	
Ordovician ...	14,000	
Silurian ...	14,000	Fish
Devonian ...	20,000	
Carboniferous ...	21,000	Amphibians
Permian ...	12,000	Reptiles
Trias ...	13,000	Mammals
Jurassic ...	8,000	
Cretaceous ...	14,000	
Eocene ...	12,000	Eutheria
Oligocene ...	12,000	
Miocene ...	6,000	
Pliocene ...	2,000	
	164,000	

The total thickness is 164,000 feet, lying in a fairly continuous series, and calculating by Mr. Wallace's method, this leads to the conclusion that, in round numbers, 22 millions of years have elapsed since the beginning of Cambrian times. The truth of Mr. Wallace's argument depends on the assumption that an area of maximum deposition retains a constant position during the existence of a geological system. This is no doubt approximately the case, but so far as it is not, the deviation from stability will render Mr. Wallace's estimate deficient. On the other hand, as Mr. Wallace himself recognised, the area of maximum deposition does not extend uniformly round the coast line, but is concentrated, if one may so speak, near the mouths of rivers; the effect of taking this into account will far more than compensate for any shifting of the area. It is unnecessary to do more than point out that deposits, where they attain their maximum thickness, are of a more or less detrital nature, and were probably deposited near the mouth of large rivers, in seas more or less land-locked. From investigations in which I am now engaged, I am led to conclude that where systems attain their maximum thickness, accumulation may have proceeded at the rate of one foot in a century, or even more rapidly.

The question largely depends on the relative size of areas of denudation and deposition; an objector to my estimate may urge that accumulation at this rate involve the existence of areas of denudation of much

larger dimensions than the map will find room for. It is worth while to inquire into this, and a single example will suffice. Let us consider the coal measures of the British Isles. Suppose they cover, to the depth of half a mile, a circular area 300 miles in radius, having its centre somewhere over Anglesey, their volume will thus be 141,372 cubic miles; add to this 15,876 cubic miles for the deposits of greater thickness occurring over the North of England, and South Wales and Somersetshire. This gives a total thickness of 157,248 cubic miles. But since the maximum thickness is 12,000 feet, these will have accumulated, according to our assumption of 1 foot in a century, in 1,200,000 years. The coexistent area of denudation affords  $\frac{1}{1000}$  of a foot of sediment per annum, or  $\frac{1}{1000000}$  cubic mile per square mile yearly. In 1,200,000 years this will amount to nearly  $\frac{1}{1000}$  cubic mile per square mile; and thus the 157,248 cubic miles of sediment in the coal measures will have required a land surface 1572,480 square miles in area for their supply. This will be represented by a circular area with a radius of 707 miles, and that an area of land several times these dimensions may have existed north and west of the British Isles during carboniferous times, is an assertion which most geologists will be prepared to defend.

So far as I can at present see, the lapse of time since the beginning of the Cambrian system is probably less than seventeen millions of years, even when computed on an assumption of uniformity, which to me seems contradicted by the most salient facts of geology. Whatever additional time the calculations made on physical data can afford us, may go to the account of Pre-Cambrian deposits, of which at present we know too little to serve for an independent estimate.

No one can regard without satisfaction the introduction into Lord Kelvin's argument of well-ascertained data as regards the melting points and other properties of rocks. Dr. Joly finds the melting point of basalt to be even lower than that of diabase, viz 815 C., a result in accordance with that found by other investigators. These facts, though of great assistance in supporting the short chronologists of the earth's age, may prove embarrassing when the question of the physical state of the interior of the earth is ready for reconsideration. Dr. Joly finds the value of  $dt/dp$  for basalt to be 0.006, and for diabase, according to Carl Barus, it is 0.021 at 1200 C.; in either case the temperature gradient gains on the melting point gradient rapidly enough to show that, at no great distance beneath the surface of the earth, the interior, if it consist of such rocks as these, is in a state of liquidity. Geologists in general would probably be glad to purchase an internal liquid shell at a cost of several millions of years. Would not, however, the admission of the existence of liquid shells in the interior of the earth, deprive the mathematical argument, as at present formulated, of all validity?

W. J. SOLLAS.

#### THE ANNIVERSARY OF THE CHEMICAL SOCIETY.

THE anniversary meeting of the Chemical Society was held at the Society's rooms, on Wednesday March 27, when the following officers and Council were elected:

President, Dr. A. G. Vernon Harcourt, F.R.S. Vice-Presidents (who have filled the office of President), Sir F. A. Abel, K.C.B., F.R.S., Dr. H. E. Armstrong, F.R.S., Dr. A. Crum Brown, F.R.S., W. Crookes, F.R.S., Dr. E. Frankland, F.R.S., Sir J. H. Gilbert, F.R.S., Dr. J. H. Gladstone, F.R.S., Dr. H. Müller, F.R.S., W. Odling, F.R.S., Dr. W. H. Perkin, F.R.S., Lord Playfair, K.C.B., F.R.S., Sir H. E. Rose, F.R.S., Dr. W. J. Russell, F.R.S., and Dr. A. W. Williamson, F.R.S. Vice-Presidents—Dr. E. Atkinson, Horace T. Brown, F.R.S., Prof. F. R. Japp, F.R.S., Ludwig

Mond, F.R.S., C. O'Sullivan, F.R.S., and Prof. W. C. Roberts-Austen, C.B., F.R.S. Secretaries, J. Millar Thomson, and Wyndham Dunstan, F.R.S. Foreign Secretary, Prof. Raphael Meldola, F.R.S. Treasurer, Dr. T. E. Thorpe, F.R.S. Council, Dr. P. Phillips Bedson, Bennett Hooper Brough, Prof. Harold Dixon, F.R.S., Dr. Bernard Dyer, R. J. Friswell, Otto Hehner, Dr. F. Stanley Kipping, Herbert McLeod, F.R.S., W. A. Shenstone, Dr. Thomas Stevenson, Dr. W. P. Wynne, and Prof. Sydney Young, F.R.S.

Prof. Armstrong, F.R.S., the retiring President, delivered his address, in which he gave an account of the work of the Society during the past year. The Faraday Medal was presented to Lord Rayleigh for the distinguished services he has rendered to chemical science through the discovery of argon. Lord Rayleigh responded in a few words, sharing the honour bestowed on him with Prof. Ramsay. The President then called on Prof. Ramsay, who laid before the Society an account of the discovery of Helium in Clèveite, and on Mr. Crookes, who described it spectroscopically. (These two communications will be found in another column.) In the evening the Fellows and their guests dined together at the Hôtel Métropole. Among those present were:—

Dr. H. E. Armstrong, the Right Hon. Jas. Bryce, M.P., President of the Board of Trade; the Right Hon. A. J. Balfour, M.P.; Sir Henry Roscoe, M.P., Mr. A. Vernon Harcourt, Lord Rayleigh, Sir Walter Puleaux, Clerk of the Goldsmians' Company; Dr. W. J. Russell, Mr. T. F. Blackwell, Master of the Salters' Company; Prof. Odling, Sir Owen Roberts, Mr. Carteige, Mr. Lavers Smith, Dr. W. H. Perkin, Prof. Thorpe, Dr. J. H. Gladstone, Mr. W. Crookes, Dr. Stevenson, Mr. C. E. Groves, Prof. McLeod, Prof. Percy Frankland, Prof. Kucker, Prof. Dunstan, Dr. Atkinson, Prof. Ramsay, Prof. Emerson Reynolds, Prof. Dewar, Sir H. Gilbert, Prof. Smithells, Prof. Tilden, Dr. Wynne, Mr. Alex. Siemeas, Prof. Thomson, Mr. Thiselton-Dyer, Dr. Hugo Muller, Mr. Norman Lockyer, Sir P. Magnus, Prof. Meldola, Dr. W. H. Symons.

A full report of the speeches made at the dinner appeared in the *Times* of the following day, and we are indebted to it for the following extracts:—

In proposing the toast of the Houses of Parliament, the President, Dr. H. E. Armstrong, remarked with reference to argon, that the discovery which Lord Rayleigh and Prof. Ramsay had made was not a chance discovery, but was the outcome of twelve years of hard work on the part of Lord Rayleigh in pursuit of the fourth decimal. The interest in the newly-discovered argon would undoubtedly be an abiding one, and it was believed that its development would be one of the most extraordinary discoveries that had been made in our time. He also referred to the discovery of Helium by Mr. Norman Lockyer, and its recent identification by Prof. Ramsay and Mr. Crookes.

Mr. Bryce, in responding to the toast, said: Physical science, and particularly chemical science, very frequently came in contact with the work of the administrators of the Government, and hardly a day passed by when they were not connected in some way with electricity or chemistry. He had been greatly impressed by the progress made in the quantity of science teaching, which had in some places almost ousted the literary side of teaching. In spite of that large quantity of science teaching, however, the Universities had not yet provided adequate means for the preparation of science teaching; and although there were a great many men teaching scientific knowledge and teaching it well, enough had not been done to give them a systematic training and to make them not only scientific men, but skilful, finished, and experienced teachers of science as a special branch of instruction. A good deal remained to be done in that way.

Mr. Balfour made the speech of the evening in proposing "Prosperity to the Chemical Society." In the course of his remarks, he said: In the last speech to which we listened with so much pleasure, the President of the Board of Trade reminded us that his department—one of the most important departments in the Government—was brought face to face and in the closest relation to science almost every day in connection with one or other of the great practical questions with which it has to deal. Undoubtedly that is so, but I think he will probably agree with me when I say that we politicians—he and I who are engaged

in the work of every-day political conflict—cannot boast that we or those whom we represent are in the position of using science as the handmaid of great national purposes, or that we have the power to turn it and direct its great forces whither we will. For my own part, though the last thing I wish to do is to suggest that the work of practical politicians is other than a work which takes the highest qualities of a man, still I have to admit, on looking back on the history of civilisation, that if we want to isolate the causes which, more than any other, conduce to the movements of great civilised societies, you must not look to the politicians of the hour on whom, it may be, all eyes are fixed; you must look to those who, often unknown by the multitude, whose work, it may be, is never properly realised by the men of their country till after they are dead—you must look on them and on their labours to find the great sources of social movements. It is to those who, very often with no special practical object in view, casting their eyes upon no other object than the abstract pure truth which it is their desire to elucidate, penetrate further and further into the secrets of nature and provide the practical man with the material upon which he works—these are the men to whom, if you analyse the social forces to their ultimate units, we owe most, and to produce such men, and to honour such men, and to educate such men, does the Society, whose health I am now proposing, devote its best energies. I do not think, so far as I am acquainted with scientific history, that Englishmen need fear that they have been behind the rest of the world in evolving those root ideas which are the sources of great discoveries, which are themselves great discoveries, and which are, too, the sources and roots of other great discoveries. It may be, however, that though, as a nation, we have been as productive as other nations—I put it modestly

in the men of genius who have made these fundamental discoveries, we have not, as a nation—and I do not think we have—sufficiently realised how great a bearing theory in these modern days must necessarily have upon practice if we are to keep pace with the rest of the world. We have produced great theorists—none greater. We have produced men of great practical genius—none greater. I am not sure, however, that at this moment we are not behind one at least of the great nations of the continent, perhaps more than one, in the art of combining theory and practice—in the art of so welding together in a great organic and self-supporting whole the man of genius, who at one end of the scale discovers a new law of nature, and the man of practice, on the other hand, whose business it is to turn these discoveries to account. I do not venture upon a subject upon which, after all, I am not wholly competent, and I will not develop this subject at greater length; but I should like to do what I can to dispel the prejudice which certainly exists at this moment in certain influential quarters against technical education properly understood. Technical education properly understood, suffers greatly under technical education improperly understood, and there is so much nonsense talked upon this subject, there is so much money uselessly spent, there are so many things taught to persons who do not want to learn them, and which, if they did want to learn them, they could by no possibility turn to practical account, that it is no matter of astonishment that some persons are disposed to say that "technical education is only the last bit of political humbug, the last new scheme for turning out a brand new society; it is worthless in itself, and not only is it worthless, but it is exceedingly expensive." While I think that those who object to technical education have their justification, it yet remains true that if you include, as you ought to include, within the term technical education, the really scientific instruction which would turn scientific discoveries to practical account—if that is what you mean, or what you ought to mean, by technical instruction, then there is nothing of which England has at this moment any greater need, and there is nothing which, if she, in her folly, determines to neglect it, will more conduce to the success of her rivals in the markets of the world, and to her inevitable abdication of the position of commercial supremacy which she has hitherto held. I do not deny that manufactures and commerce have received an immense amount of gain from theoretical investigations, and, as everybody will admit who has even the most cursory acquaintance with, let us say, the history of discoveries in electricity and magnetising power, science has been the means of great gain through industrial development. While both these things are true, I am the last person to deny that it is a poor end, a poor object for a man of science to look forward to of merely making

money for himself and other people. After all, while the effect of science on the world is almost incalculable, that effect can only be gauged in the future, as it has only been gained in the past, by men of science pursuing knowledge for the sake of knowledge and for the sake of knowledge alone; and if I thought that by anything that had dropped from me to-night I had given ground for the idea that I looked on science from what is commonly called a strictly utilitarian point, that I measured its triumphs by the number of successful companies which it had succeeded in starting, or by the amount of dividends which it gave to capitalists, or even by the amount of additional comfort which it gave to the masses of population, I should greatly understate my thought; but I know that this great Society, while it has in view these useful objects, still puts first of all the pursuit of truth as its object and as the cause to which every man of science pays his devotion. Truth, not profit, must necessarily be the motto of every body of scientific men who desire to be remembered by posterity for their discoveries. These things can be done only from a disinterested motive, and it is because I believe that societies like the great Society I am addressing do more than any other organisation to attain that great object, because I think they bring together men engaged in congenial pursuits, because the stimulus of minds brought close to other minds with honourable motives, and the honourable rivalry of men engaged in the same great task, must lead to an enormous expansion of our knowledge of the secrets of nature, that I, as an outsider, not belonging to your body, but in the name of the public for which I venture to speak, wish you all success and all prosperity.

The President briefly responded to the toast.

Mr. Vernon Harcourt proposed "Learned Societies," coupled with the name of Lord Rayleigh, who briefly responded.

Sir Henry Roscoe proposed "The Visitors," and Sir Owen Roberts and Prof. Rucker responded.

Dr. W. J. Russell proposed "The President," who concluded with the toast of "The Secretaries," coupled with the name of Prof. Thomson.

#### SIR HENRY CRESWICKE RAWLINSON, BART.

HENRY CRESWICKE RAWLINSON was descended from the family of Rawlinsons who, in the last century, settled down at Chadlington, in the county of Oxford; he was born April 11, 1810, and in 1862 he married Louisa Caroline Harcourt, daughter of Henry Seymour, of Knoyle, Wilts, and he died on March 5 last. At the early age of seventeen he went out as cadet to India, and in a very short time made himself an excellent Persian scholar; in 1833 he was sent to Persia, his fine command of the language of that country, no doubt, influencing his selection by "John Company." For six years he served diligently, and filled many military posts in the great cities of Persia, and he succeeded in infusing something nearly akin to order in the forces of the "King of Kings." In 1839 the relations between England and Persia became "strained," and Rawlinson left the country for Afghanistan; in 1840 he was appointed Political Agent of the Indian Government in Kandahar, a post which he held until 1842. During these years he wielded the sword as often as the pen, and his courage and personal bravery in the field made him a terrible opponent of the wily Afghan. In 1844 he was sent to Bagdad as H.B.M.S. Consul for Turkish Arabia, and in 1851 he was made Consul General, the importance of Bagdad being, thanks to Rawlinson's labours, fully recognised. In 1855 he was made Crown Director of the East India Company, and in 1856 he was promoted to the dignity of K.C.B.; two years later he was elected Member of the India Council, and in 1859 he was sent to Teheran as Minister Plenipotentiary. He represented in Parliament for a short time (1865-1868) the borough of Trone, but a Member's life offered no attractions to him.

The above brief statement of facts will indicate sufficiently the abilities of Rawlinson, who was a man equally able as a statesman, diplomat, and soldier; but there is

yet another side of him of which nothing has been said, and it is that of the scholar. Before Rawlinson had been five years in India, he had read the greater part of the literature of Persia, and he was even at that time (1832) a skilled and fluent talker in Persian; long passages from the finest poets he had learned by heart, and his conversations were so full of extracts from them, that a native once described his talk as "a garden of pearls in metre." From modern Persian to the ancient language is, relatively, but a step, and when Rawlinson found himself in Persia in 1833, he turned his mind to the study of the remains of the kings who had cut their records in the rocks in the cuneiform characters. So far back as 1835, he copied the tablets at Hamadan, and without the help of books, or even any knowledge of the alphabet worked out by Grotefend in 1802, by making the same guesses as Grotefend, he identified correctly the names of Hystaspes, Darius, and Xerxes. In 1836 he collated the first paragraphs of the great Behistun inscription with the tablets at Elwend, and identified the old Persian forms of the names Arsames, Ariaramnes, Teispes, Achaemenes, and Persia; by this time he had made an alphabet of eighteen characters. Early in 1837 he had copied all the other paragraphs of the Behistun inscription, and in the winter of that year he sent to the Royal Asiatic Society his translation of the two first paragraphs which recorded the genealogy and titles of Darius Hystaspes. Without any desire to belittle the work of other investigators, we must say that these would have been inexplicable if the systems of transliteration followed by Grotefend and Saint Martin had been employed, and whatever else may be theirs, Rawlinson's discovery at this period of the phonetic values *kh*, *b*, *m* and *n* is beyond all doubt. About this time he decided that the translation of the Persian cuneiform texts could only be effected by a knowledge of Zend, and he set to work to master the contents of the work of Anquetil du Perron and M. Burnouf's commentary on the Yacna, which was, however, not in his hands until 1838; he obtained some assistance, too, from a priest of Yazd, who translated for him some Zend MSS. In 1838 Rawlinson discovered the phonetic values of *h*, *w*, *i*, *e*, *th* and *jh*, and in 1839 he had practically settled the alphabet, which in all essential points agreed with that of Lassen, published in his *Alt-persischen Keilinschriften*. Here must be noted the fact that Rawlinson never contested the priority of alphabetical discovery with Lassen, even though there is abundant proof that all he owed to Lassen was a single phonetic value; but what he did claim, and claim rightly, was the credit of having translated literally and grammatically two hundred lines of cuneiform writing which contained historical statements of the greatest value, for the first time, as early as 1839. In this year, while he was putting the final touches to his work, political necessity caused him to be sent from Persia to Afghanistan, and his studies were so much interrupted during the next five years, that he was unable to publish the result of his labours until 1847.<sup>1</sup>

Meanwhile the mound of Kouyunjik, which marks the site of the palaces of ancient Nineveh, was being explored by Mr. Layard, and the mound of Khorsabad, some few miles off, had begun to yield splendid results to its talented excavator, M. Botta. That Kouyunjik formed part of old Nineveh was always well known, and so far back as 1829 Mr. Rich picked up three fragments of clay tablets inscribed in cuneiform writing. As soon as Rawlinson could obtain copies of the inscriptions dug out by Mr. Layard he devoted himself to the study of them, and the practical outcome of these labours were his publications: "A Commentary on the Cuneiform Inscriptions of Babylonia and Assyria; including readings of the inscription on the Nimrud Obelisk, and

<sup>1</sup> In the tenth volume of the *Journal of the Royal Asiatic Society*. (London, 1871.)

a brief notice of the ancient kings of Nineveh and Babylon," London, 1850; and "Outline of the History of Assyria," London, 1852; and "Notes on the Early History of Babylonia," 1854. He had also in 1850 and 1851 revised the "Inscriptions in the Cuneiform Character from Assyrian Monuments," which Mr. Layard published in 1851. Curiously enough, though Rawlinson's translation of the Behistun inscription was accepted generally, there were many, and Sir G. C. Lewis was among them, who stated unhesitatingly that the cuneiform inscriptions had not yet been accurately deciphered, and we owe it to Mr. Fox Talbot that this view was proved to be erroneous. Rawlinson had undertaken to publish a series of cuneiform texts with English translations of the same for the Trustees of the British Museum, and Talbot, having obtained a set of the plates of the text of the great Tiglath Pileser inscription, began to work at an independent translation which, when finished, he sent in a sealed packet to the Council of the Royal Asiatic Society, pointing out that if his own translation and that of Rawlinson, when it appeared, should agree, a strong proof of the accuracy of Rawlinson's system would be established. The Council appointed a Committee consisting of Dean Milman, Whewell, Gardner Wilkinson, Grote, Cureton, and Prof. Wilson as examiners, and they asked Rawlinson, Oppert and Hincks to send in versions of the same inscription by a certain date. Talbot's arrived first, Rawlinson's next, Hincks's next, and Oppert's next; the last two scholars could not, however, translate all the inscription for want of time. The four independent translations were carefully examined, and it was found that they agreed as to general sense in a marvellous manner, and the Committee rightly judged that the decipherment of the cuneiform inscriptions was a *fait accompli*; Rawlinson, however, translated the whole text, while his three competitors left passages here and there unrendered.

In the matter of publication, Rawlinson's greatest work was undoubtedly the "Cuneiform Inscriptions of Western Asia" in five vols. folio, which he prepared for the Trustees of the British Museum; here he supplied material for generations of workers, and gave the proofs of his knowledge and ability in cuneiform matters, which have justly earned for him the title of "Father of Assyriology." Between the years 1858 and 1875 he largely assisted his brother Prof. Rawlinson in his works on Oriental history, and a large share of whatever credit attaches to them is due to him. His last published translation was that of the cylinder of Cyrus, which recorded his conquest of Babylon; it appeared in the *Journal of the Royal Asiatic Society*, new series, vol. xii. (1880 p. 70. As was to be expected, honours were showered upon Rawlinson from all parts of the civilised world. He was elected to a Trusteeship of the British Museum—a much coveted honour—in 1876; Oxford, Cambridge, and Edinburgh gave him honorary degrees; Prussia awarded him the "Ordre pour le Mérite"; and the Academies of other countries elected him to Memberships. In summing up his labours, it is hard to say whether he did most for cuneiform scholarship, or to advance the interests and empire of Her Britannic Majesty in the East. Small-minded men, wishing to lessen Rawlinson's merits, have harped upon the fact that Lassen made his alphabet before Rawlinson; but this he freely admitted, only saying in reply that he never saw it until 1839. That Rawlinson was the first European who translated cuneiform inscriptions, is beyond all doubt, and from first to last, *i.e.* from 1835 to 1895, he exercised a wise and beneficent influence over cuneiform studies which cannot be over-rated. His position in Persia gave him unrivalled opportunities, which he used to the best of his ability,

<sup>1</sup> See Rawlinson, "Inscription of Tiglath-Pileser I., King of Assyria, about 1150 B.C." (London, 1857.)

and as Consul of Bagdad from 1844 to 1855, his strong but silent power was freely exerted on behalf of Mr. Layard while carrying on his work at Kouyunjik; beyond all doubt is it the fact that he has done more for cuneiform research and excavation than any other man living or dead. It must never be forgotten, too, that he was the only early excavator who had fully qualified himself to understand his work, and of them all he was the only one who could read cuneiform. He was a fine example of the English soldier, now only too rare, for to the bravery of the warrior he added the courtesy of the diplomat, and a wide knowledge of Oriental countries, languages, and history; his modesty was as great as his learning was deep. His ready wit and honest straightforwardness made him a favourite at every Oriental Court, and helped greatly to bring his plans to a successful issue; and his fearless bearing and manly love of warlike exercises attracted to him the admiration of the Indian and Persian soldiers who came in contact with him. His tolerance led men, both in the East and in the West, to confide in him, while his natural good-heartedness often made them like him as much as they trusted him. Other Englishmen have left behind them in the East fame for a certain exploit, or renown as great horsemen, &c., but no man was more feared and liked throughout the East than Henry Creswicke Rawlinson. He was a thorough Englishman, and with him English interests were paramount everywhere; he never forgot, too, in spite of his gracious bearing to all, that he was a trusted servant of the "Right Honourable John Company Sahib Bahadur." Wherever he went he impressed his personality in a marvellous degree, and an idea of the reputation which he left behind him in Bagdad may be gained from the remark which an old native of that city made to a British merchant some years ago. "Sahib, in the days of Rawlinson Sahib, may God lengthen his life, if you had put an English hat on the head of a dog and sent him through the bazaar, the Turks would have made way for him and bowed to him on the right and left as he passed, and now they spit on us as they pass us."

#### NOTES.

WE are glad to learn that Prof. Huxley is now rapidly recovering from his recent attack of influenza.

REFERENCE was made last week to the activity and great development of the Brooklyn Institute of Arts and Sciences. Among the most successful of its recent enterprises must be counted the establishment of a summer school of biology by the sea. The first session was held in July and August 1890, at Cold Spring Harbour, on the north shore of Long Island, in a building lent by the New York Fish Commissioners. The school annually increased in size and importance, and a specially designed laboratory, capable of accommodating fifty students, was last year opened for work in the same locality. The laboratory is well arranged for the purposes of lectures and practical instruction, and possesses private laboratories for investigators, a library, aquaria with running water, both salt and fresh, boats, microscopes—indeed everything needed to make profitable a summer at the sea-shore. It is impossible to over-estimate the advantages which marine laboratories afford for the purpose of biological instruction; and America may be congratulated upon the successful inauguration of an institution specially adapted to subserve this important end.

WE drew attention a short time ago (*NATURE*, vol. xlix. p. 597) to the fact that the late Sir W. Macleay had willed to his executors the sum of £12,000, for the foundation of a chair of Bacteriology in the Sydney University. The terms of the

to be provided for a six months' course on the subject, to be binding on every student before being admitted to a science or medical degree at the University. Pending the inability of the Senate to accept, within a month after notice of the legacy, the condition contained in a memorandum annexed to the will, the legacy was to be void, and the sum given over to the Linnean Society of New South Wales, for the endowment of research in bacteriology. On receiving the money, the senators, the majority of whom are lawyers, have sought a judicial interpretation of the words "six months' course," and have secured the handsome endowment to themselves, on the ruling of Court, for disposal on their own terms. What they will do with it remains to be seen. Sir W. Macleay had been a member of the Senate, and his impression of its conduct may be gauged from the fact that in bequeathing this very legacy he took especial pains to protect his executors against that which he termed "its very uncertain views." In this he has failed! "Sharp practice" may be a conventional, but it is hardly a befitting term for the behaviour of the Senate, which thus expresses the gratitude of a colony for the devotion of a life and fortune to the advancement of science and scientific education.

WE understand that the Macleay memorial volume is selling very slowly. Its promoters are considerably to the bad on the undertaking.

DR. DOBEREK would be glad if astronomers who notice shooting stars having radiant south of the equator, will send their observations for discussion to the Hong Kong Observatory, where some attention is being paid to southern shooting stars.

GENERAL SIR GEORGE CHILNEY, to whom belongs the credit of originating and organising the Royal Indian Engineering College at Coopers Hill, died on Sunday.

PROF. LUDWIG SCHWAB, the well-known Swiss mathematician, has just died at Berne, at the age of eighty. In 1853 he was appointed professor of mathematics at the University of Berne, where he first acted as *privat-docent*, but some time ago he gave up his post on account of his advanced years.

MESSES. SOUHERY, WILKINSON, AND HODGE will include the original autograph manuscript of Gilbert White's "Natural History and Antiquities of Selborne" in their sale commencing April 22. Several passages in the manuscript have not been published, and the whole has never passed out of the possession of the lineal descendants of the author.

THE Geologists' Association have arranged an excursion to the Tertiary Beds of the Isle of Wight, during Easter, under the direction of Mr. R. S. Herries and Mr. H. W. Monckton. The party will leave London next Thursday, and will return on the following Tuesday.

THE Liverpool Marine Biology Committee have appointed Mr. J. C. Sumner, from the Biological Laboratory of the Royal College of Science, South Kensington, as Curator of the Port Erin Biological station.

DR. JENTINK, of Leyden, has recently drawn attention to the scantiness of trustworthy evidence concerning the distribution of the two species of *Rhinoceros* which inhabit the Malay archipelago. It is sometimes stated that both species, *R. sumatrensis* and *R. sondaicus* are to be found in Borneo, Sumatra, and Java; but it appears that nothing can be maintained with absolute certainty at present, except that *R. sondaicus* inhabits Java, and *R. sumatrensis* both Sumatra and Borneo. It is clearly desirable that any authentic information bearing upon this point should be brought to light, if yet unpublished.

THE Biological and Microscopical Section of the Academy of Natural Sciences of Philadelphia have just sustained a severe

loss by the sudden death of Dr. George A. Rex. Dr. Rex was the highest authority on the Myxomycetes in the United States. He was the author of numerous species, which, owing to his extreme conservatism, will doubtless continue to bear his name. Many forms, new to him, remained in his collection unnamed for years, and were only published when he had thoroughly convinced himself that they were really new to science. Although he was interested principally in the Myxomycetes, he was an earnest student of the lower orders of fungi, and an ardent admirer of everything beautiful in microscopic nature.

WE have also to record the deaths of a number of other scientific workers in the United States. Dr. Darwin G. Eaton died in the evening of March 17, aged seventy-two. He was prominent as an instructor in the Packer Institute and in the Long Island College Hospital. His works belong chiefly to chemistry and astronomy. He was twice a member of Government parties to observe eclipses of the sun. Dr. P. H. Van der Weyde died a few hours later, on the 18th ult. He was born at Wymeguen, Holland, in 1813, and removed to New York in 1849. He taught in the University of the City of New York, at Cooper Union, and Girard College. Dr. Henry Coppee, acting president of Lehigh University, died March 20, at Bethlehem, Pa., aged seventy-five years. He was elected Regent of the Smithsonian Institution in 1874. Mr. Isaac Sprague, well known as a botanist and artist, and illustrator of botanical works, died at Wellesley Mills, Mass., March 13.

WE notice the announcement of the death of Mr. A. G. More, who for many years exercised an influence of a special kind on the zoologists and botanists of Ireland as an authority to whom they implicitly referred questions on the subject of the determination of the species of Irish birds and Irish plants. Under the modest title of "Contributions towards a Cybele Hibernica," in conjunction with the late Dr. David Moore, he published in 1866 an excellent account of the geographical distribution of plants in Ireland. Another good piece of work by him was his list of Irish birds, published in the year 1885, in connection with the collection in the Dublin Science and Art Museum, and in 1887 he published an excellent guide to the Natural History Department of the Museum. He succeeded Dr. Carte as Curator of that department, but illness compelled him to retire in 1887, after twenty years' service.

THE annual banquet of the Institution of Civil Engineers took place on Wednesday, March 27, a distinguished company being present. Sir Robert Rawlinson, K.C.B. (the President) occupied the chair, and among the guests were the Duke of Cambridge, the Duke of Teck, the American Ambassador, the Marquis of Salisbury, Sir John Fowler, Sir Frederick Bramwell, Sir Redvers Buller, Mr. C. T. Ritchie, Sir F. A. Abel, Sir George Stokes, Sir Courtenay Boyle, Sir John Donnelly, Mr. Henry Kimber, M.P. (Master of the Merchant Taylors' Company), Dr. Anderson, Sir B. Baker, Mr. C. Barry, Prof. Forbes, Dr. Frankland, Mr. Hawksley, Dr. Kennedy, Sir G. L. Molesworth, Mr. Preece, Mr. Rennie, Prof. Roberts-Austen, Sir David Salomons, Prof. Unwin, Mr. Walmisley, and Mr. Yarrow. The Marquis of Salisbury, in proposing the toast of "The Institution of Civil Engineers," dwelt upon the system of sanitary military reform set on foot by Sir Robert Rawlinson, and which has had such beneficial results. He continued:—The system has yet some advance to make, and I hope some day the civil engineers, if the military engineers do not do it, will remove the reproach of typhoid fever from our barracks. But an enormous distance has been traversed by the genius of civil engineers, and by none more than by the President who occupies your chair; and I think it has reacted on civil society. We never really took in hand the sanitation of our civil popu-



lation until we had been taught by necessity, by the evils attacking our military forces, and the remedies that were adopted, to confront those evils; and the result of the last forty years of sanitary exertion on the part of civil engineers, is one of the most splendid triumphs in the history of any profession which has adorned this country. You have done what many a continental nation wishes it could imitate you in doing. You have driven cholera from your shores. It can no longer make any impression upon us, and year by year the health of the population grows, the sanitary reforms increase, and you have converted all those who once doubted to believe in the sanitary character of the maxims which you inculcate and the methods which you propose.

MAJOR CARDEW'S report on the circumstances attending the accidents which have lately occurred in London, in connection with electric light mains, has been published in a Parliamentary paper. The accidents were of two kinds—those due to severe electric shocks caused by strong electrification of the surface of the ground, and those resulting from explosions in the street boxes through which the electric light mains run. In the City cases investigated by Major Cardew, the immediate causes of the accidents were: the breaking down of the insulation of a high pressure main in a street box, causing the formation of a powerful electric arc between the outer conductor of this main and the end of an iron pipe, forming a conduit for the mains, which projected into this box, and the consequent charging of this pipe to a dangerous extent; and the presence of gas in the Electric Light Company's pipes and street boxes to an amount which formed a highly explosive mixture afterwards fired by the electric arc. In the case of explosions in the St. Pancras district, it was suggested that the explosive gas was derived from the sewers, and also that it was hydrogen generated by electrolytic action. Major Cardew could find, however, no trace of such action, and, after careful consideration of the evidence and his own investigations, he concludes that the explosions were caused by the firing of a mixture of coal-gas and air by an electric spark. No time should, therefore, be lost in removing these two existing causes of danger, namely, the possibility of an accumulation of coal-gas in the conduits and that of the occurrence of an electric spark at the mains, whether the mains be insulated or of bare copper strip, such as is used by the St. Pancras Vestry. This Vestry has previously had their attention drawn to the necessity of efficient ventilation, but have failed to remedy the defects. The inquiry elicited the fact that there are only eleven ventilating pipes and three ventilating covers to street boxes for a total length of six and a half miles of conduit, a proportion quite inadequate for the immediate escape of gas from the conduits. Major Cardew recommends that accumulation of gas should be prevented by thorough ventilation, by making the sides and bottoms of street boxes impervious to gas, and by filling up the boxes as far as practicable with incombustible material. It is to be hoped that the Board of Trade will see that his recommendations on this and other sources of danger are acted upon.

THE New York Academy of Sciences, on Wednesday, March 13, repeated the experiment, begun last year, of giving an annual exhibition, with very gratifying results. Numerous scientific instruments were exhibited; the apparatus which excited most general interest being one for testing and photographing the voice.

A MEETING of the Institution of Mechanical Engineers will be held on Wednesday evening, April 24, and Friday evening, April 26, at 25 Great George Street, Westminster. The discussion will be resumed, on the Wednesday evening, upon the governing of steam engines by throttling and by variable expansion, by

Captain H. Kiall Sankey. The third report to the Alloys Research Committee will be presented by Prof. W. C. Roberts-Austen, C.B., F.R.S., and also appendices to it on the elimination of impurities during the process of making "best selected" copper, by Mr. Allan Gibb, and on the pyrometric examination of the alloys of copper and tin, by Mr. Alfred Stansfield. The anniversary dinner will take place on Thursday evening, April 25.

THE New York signal service office, a branch of the United States weather bureau, has just been removed from the Equitable building, No. 120 Broadway, which has been its headquarters for twenty-four years, to the new Manhattan Life Insurance Company's building, No. 66 Broadway, which is now one of the highest buildings in the world. The bureau will occupy the twenty-first, twenty-second, and twenty-third stories in the tower, and the observations will be made at a height of 356 feet above the street, or 380 feet above tide water. The old quarters were only 185 feet from the street. The equipment will all be new, and will include electric signal lights, which can be seen as far as Asbury Park and Fire Island. When the weather bureau was established in 1870, it occupied the top floor of a building in Wall Street for a few months. On the completion of the Equitable building, that was selected as then the highest in the city, but the rapid growth of tall office buildings all around has made it undesirable as an observing station. Even the present lofty quarters will soon be overtopped by the building of the American Surety Company, twenty-seven stories high, on the corner of Broadway and Pine Streets, between the Equitable and the Manhattan buildings.

EXTENSIVE geological researches have been made by Russian mining officers, as well as by professors of the Tomsk university, in connection with the Siberian railway, which, as is known, has already been completed as far as the Irtysh, opposite Omsk. Numerous layers of coal have been found in the basin of the Irtysh, but none of them have any industrial value. Rich palæontological collections, which very well characterise the age of the coal-bearing deposits of the Kirghiz Steppe, have, however, been made out at Bez-tyubz. The best coal was found at Kuu-ehoku, 40 miles from Karaganda, but it is too far from the railway (375 miles) to have an immediate practical value. The great difficulty which the builders of the railway have to contend with is the total absence of building stone in these lowlands, covered with clays and sands. Thus, for the building of the bridge over the Irtysh, near Omsk, new earlies had to be opened higher up the river, but the cost of extraction and transport was so great that most of the stone required for the bridge is brought by rail from Chelyabinsk, a distance of nearly 500 miles.

THE Society of Naturalists at the St. Petersburg University which celebrated last year its twenty-fifth anniversary, has issued an excellent volume containing a review of its five-and-twenty years' activity. Each branch (zoology, physiology, botany, and geology) is treated by a specialist, and the reviews show at a glance what has been done in each of these divisions of science; while the work of botanical, zoological, &c., exploration of the Russian Empire which has been accomplished by members of the Society, is represented on two maps. It is sufficient to say that the White Sea, the Caspian Sea, the Aral Caspian and the Altai expeditions, which have so often been mentioned in these columns, the Crimea and the Neva Permanent Committees, and the Solovetsky biological stations, are the work of the Society. The volume is adorned by a good portrait of the late Prof. K. Th. Kessler, the founder of the Congresses of the Russian Naturalists, and Doctors, and also of the Societies of Naturalists at all the

Russian Universities. The Society, which began twenty-five years ago with 71 members only, has now 374 active and 25 honorary members.

THE Russian Society of Naturalists at the Kazan University, which was founded in 1869, has also issued a similar anniversary volume, in which the review of work done in botany is especially valuable, as it has been written on the above plan. The volume contains also an index of all papers published in the twenty-five volumes of its *Bulletin* and *Memoirs*, the titles of the papers being given both in Russian and German.

AN old estimate of the frequency of earthquakes was that no day passed without a shock being felt somewhere on the earth. In a new determination (*Comptes rendus*, vol. cxx, pp. 577-579), M. de Montessus de Ballore obtains a much higher figure. Dividing all the registers we possess into historical, seismologica and seismographical, and assuming the latter to be perfect, he finds, by comparing the different classes for the same region, that in the first 96.24 per cent., and in the second 84.48 per cent., of the total number of shocks escape record. In a group of well-studied earthquake districts, with a combined area of 11,691,000 sq. km., the average yearly numbers of shocks for the three classes are 341.35, 878.57, and 2222.24 respectively. Hence, multiplying by the proper factors for the first two classes, it would appear that the total number of shocks actually occurring in the above area must be estimated at 16,957 a year, or one in every half-hour.

IN several papers of great interest (*Atti della R. Acc. dei Lincei*, Roma, vol. v., 1894), Prof. G. Vicentini describes his new seismometrograph erected at Siena, and the seismic record obtained with it from February to July, 1894. The instrument consists of a heavy pendulum,  $1\frac{1}{2}$  m. in length and 50 kg. in mass, the base of which is connected with one end of a very light vertical magnifying lever. The other end of this lever is connected with the ends of two light horizontal levers placed at right angles to one another. These magnify the original movement of the ground seventy times, and trace fine lines on two strips of smoked paper moving at the rate of 2 mm. a minute. With this arrangement the heavy mass, it is found, remains stationary during vibrations of the ground, and the trace ceases simultaneously with the removal of the disturbing cause. For seismic purposes, the instrument possesses several advantages, especially the small cost of working and the rapid movement of the paper bands. In the plates accompanying the papers, copies are given of the traces produced by passing carriages, by strong gusts of wind, and by several earthquakes, the most beautiful being those of the Japanese earthquake of March 22, the Greek earthquake of April 27, and the Constantinople earthquake of July 10.

SERGE NICHOLAI R. H. LILLIOT, of the Indian Medical Service, has recently reinvestigated the value of strychnine as an antidote against snake poison in the most thorough manner. He experimented chiefly with cobra poison, but also with the venom of Russell's viper and the krait, using frogs, lizards, ducks, fowl, hares, guinea-pig, dog, goats, pigs, and monkeys as test animals. He confirms the results of Drs. D. D. Cunningham and A. A. Kanthack, that strychnine is not an antidote against snake poison.

THAT the German Cholera Commission has worked most energetically is shown by the voluminous documents now appearing in the *Arbeiten aus dem Kaiserlichen Gesundheitsamte*. A detailed inquiry has been held into all the various outbreaks of cholera which occurred in Germany between the latter part of 1892 and 1893, respectively, and the mass of

minute incidents thus collected have been brought together, and cover considerably over 600 quarto pages. The Hamburg inquiry not unnaturally occupies the largest volume, and is extensively illustrated with diagrams, &c. The Commission has succeeded in producing a most important and valuable contribution to the study of epidemiology, and their labours on cholera must long be regarded as the standard work on the subject. We only wish that influenza, which is now far more constantly with us, and claims such an increasing number of victims, might be subjected to the same crucial inquiry; possibly then, as in the case of the later outbreaks of cholera in Germany, we might be in a position to take some steps to effectually check its apparently capricious career.

A NEW contrivance for reading the position of the pointer in sensitive balances is described by W. H. F. Kuhlmann in the *Zeitschrift für Instrumentenkunde*. It has often been attempted to save time by accurate readings with the aid of a telescope or microscope, but none of those methods have been found to answer the purpose of the practical chemist or physicist. Herr Kuhlmann's contrivance is at once simple and effective. The pointer moves *behind* the divided scale, and the face of the latter is turned towards a concave cylindrical mirror attached to the central column of the balance. This mirror can be adjusted to face the observer, who sees in it a magnified image of the pointer rapidly moving across the magnified scale. It is thus made possible to graduate the scale much more finely than heretofore. The pointer must be very fine at the end, but any danger of its being damaged on that account is obviated by the fact of its moving between the scale and the mirror. Another improvement, described by Dr. Classen in the same number, is an arrangement for exchanging objects and weights without opening the balance case. This is accomplished by making a portion of the scale pans detachable. Each scale pan consists of a set of bent rods. One of these, bent into an irregular shape, can be lifted out and conveyed on a circular rail to the other scale pan, the latter undergoing this operation at the same time. A double weighing is no more troublesome than a single weighing, and the advantages of the method, especially when absolute weights are required, are obvious.

THE phenomenon of polyembryony, or the development of two or more embryos in a single seed, has been the subject of several investigations. It has been shown that it may be due to the division of the nucellus, or to the fusion of two ova, or to the presence of several embryo-sacs in one ovule. Further, Strasburger has found that it is often to be accounted for by the ingrowth of some cells of the nucellus into the embryo-sac, which then develop into adventitious embryos; in other cases he ascertained that two egg-cells are normally present in the embryo-sac, which on fertilisation give rise to two embryos. Finally, Dodel and Overton showed that it was possible for the synergidae to develop into embryos. More recently, M. Tretjakow, in a short but interesting paper (*Ber. d. Deutsch. Bot. Gesell.*, February 1895) describes yet another cause of polyembryony. In *Allium odoratum*, in addition to the normal embryo formed from the egg-cell, not infrequently the antipodal cells also give origin to embryos. Sometimes only one of these develops, but M. Tretjakow has observed all three antipodal cells start into growth and give rise to three embryos. These antipodal embryos commence their development immediately after the fertilisation of the egg-cell, and the cell-divisions, at least in the earlier stages, correspond exactly with those in the embryo formed from that cell. The Russian author, accepting the view that the antipodal cells are homologous to the vegetative cells of the prothallia of ferns, compares these antipodal embryos with those arising by apogamy on fern prothallia.

IN the course of a few remarks made by Prof. D. E. Hughes, F.R.S., at the recent banquet given by the staff of the National Telephone Company, some points in connection with the early history of telephony were mentioned. The text of the speech is published in the *Electrical Engineer* for March 22, and the following note from it is interesting. Prof. Hughes said:—The earliest record of a perfect theoretical electric telephone, was contained in Du Moncel's "Exposée des Applications," Paris, 1854; when M. Charles Bourseul, a French telegraphist, conceived a plan of conveying sounds and speech by electricity. Suppose, he explained, "that a man speaks near a movable disc sufficiently flexible to lose none of the vibrations of the voice, that this disc alternately makes and breaks the current from a battery; you may have at a distance another disc which will simultaneously execute the same vibrations." Unfortunately M. Bourseul did not work out his idea to a practical end, but these few words contain the shortest possible explanation of the theory of the present telephones.

IT is now exactly thirty years since Prof. Hughes first experimented with a working telephone. In 1865, being at St. Petersburg in order to fulfil his contract with the Russian Government for the establishment of his printing telegraph instrument upon all their important lines, he was invited by his Majesty the Emperor Alexandre II. to give a lecture before his Majesty, the Empress, and Court at Czarskoi Zelo, which he did; but as he wished to present to his Majesty not only his own telegraph instrument, but all the latest novelties, Prof. Philipp Reis, of Friedericksdorf, Frankfort-on-Maine, sent to Russia his new telephone, with which Prof. Hughes was enabled to transmit and receive perfectly all musical sounds, and also a few spoken words, though these were rather uncertain, for at moments a word could be clearly heard, and then from some unexplained cause no words were possible. This wonderful instrument was based upon the true theory of telephony, and it contained all the necessary organs to make it a practicable success. Its unfortunate inventor died in 1874, almost unknown, poor, and neglected; but the German Government have since tried to make reparation by acknowledging his claims as the first inventor, and erecting a monument to his memory in the cemetery at Friedericksdorf.

SINCE the enunciation by Virchow, in 1858, of his theory of cellular pathology, much attention has been given to the study of this unit. Nearly all the unsolved problems of medical science involve, in one way or another, the consideration of some one of the functions of the cell. At the Philadelphia Academy of Natural Sciences, on February 5, Dr. C. L. Leonard directed attention to a new method of studying one of these functions. The method consists in making a consecutive series of instantaneous photomicrographs of the same microscopic field, taken at definite intervals, so that a comparative study of the series can afterwards be made. The results obtained by this method are the elimination to a greater extent of the personal equation of the observer, the procuring of incontestable proof of phenomena observed, the extension of the observations over any length of time, and the possibility of studying the changes occurring over the entire field at any one moment. The method also enables the student to study the condition of a fresh, living, unstained specimen for any length of time, in fields taken at definite intervals. So far Dr. Leonard has confined the greater part of his study to cell motion as exemplified in the movements of the red and white blood corpuscles. He exhibited to the Academy a number of photomicrographs illustrating the amoeboid motion of the white blood corpuscle, and also showing motion in the red blood corpuscle. Some of the photographs seem to show that

diapedesis is not a filtration due to pressure, but is due to a truly amoeboid motion and power of the red blood corpuscles. Further photographs illustrated the position of the corpuscles within the capillaries, and showed the presence of nuclei in the red corpuscles of the frog while in the living tissues.

AT a recent meeting of the Paris Academy, M. Désiré Korda read a paper on a "thermo-chemical carbon cell." The author finds that if barium peroxide is heated to redness in contact with a carbon plate, the oxide becomes reduced to baryta, and a difference of potential of about one volt is produced, the carbon plate being negative. A similar result was obtained with cupric oxide as soon as a layer of potassium carbonate was placed between the oxide and the carbon, the difference of potential in this case amounting to 1.1 volts. The experiments were in each case performed by connecting a plate of gas-retort carbon by means of a platinum wire to one terminal of a Richard voltmeter, and placing on the carbon a few c.c. of the salt. A platinum wire dipping in the salt served to complete the circuit. On heating the carbon to a dull red heat in a Bunsen flame, a violent effervescence takes place, carbon dioxide being evolved, and the volt meter shows a deflection corresponding to about 1 volt. This deflection remains constant as long as any of the higher oxide is left.

READERS of Mr. Edward Step's books and magazine articles on popular botanical subjects, will be pleased to learn that he has written a pocket-guide to British wild flowers, to be published by Messrs. Frederick Warne and Co. The title of the book will be "Wayside and Woodland Blossoms."

THE fourth part of "Dissections Illustrated" (Whittaker and Co.), by Mr. C. Gordon Brodie, containing sixteen magnificent plates drawn and lithographed by Mr. Percy Highley, has just appeared. Students of human anatomy could hardly desire a handbook in which typical dissections are more clearly displayed than they are in Mr. Brodie's work, which has now been completed. The whole work contains seventy-three coloured plates, drawn to two-thirds natural size.

THE Zoological Society of France has just published a new edition of the "Rules of Nomenclature of Organised Beings adopted by the International Congresses of Zoology (Paris, 1889; Moscow, 1892)." A copy will be sent gratis to every professor of zoology or comparative anatomy, director of a museum, library or laboratory, or assistant in the same, also to every learned society, upon application to the general secretary, M. le Dr. R. Blanchard, 7 Rue des Grands Augustins, Paris.

THE valuable work in zoology, carried on in H.M. Indian Marine surveying steamer *Investigator*, under Commanders A. Carpenter and R. F. Hoskyn, is already known to many biologists, and Part I. of the illustrations referring to it, now obtainable through Mr. Bernard Quaritch, should make it known to more. The Part contains seven splendid photo-etchings representing twenty-six remarkable fishes, and five illustrative of Crustacea. The former were prepared under the direction of Mr. A. Alcock, and the latter under the direction of Mr. J. Wood-Mason.

PROF. S. H. VINES' "Students' Text-book of Botany" (Swan Sonnenschein and Co.), the first half of which was reviewed in these columns in October last (vol. 1. p. 613), has just been published in its complete form. In addition to the sections mentioned in our notice, the work now contains descriptions of the Phanerogams, and the part on the physiology



planet's centre was  $24''.4$ . Prof. Schaeberle now somewhat reluctantly publishes these facts in connection with his measures of the known satellite, as he has not on any subsequent occasion been able to detect any object in the neighbourhood of Neptune in apparent orbital motion about the planet. The unusual clearness and steadiness of the night of September 24, 1892, however, is not considered to have been equalled in the later observations.

#### PROFESSOR MENDELÉEFF ON ARGON.

AT the meeting of the Russian Chemical Society, on March 14, Prof. Mendeléeff made some interesting remarks on the relations of argon to the periodic system. His views are summed up as follows in a proof-issue of the *Proceedings* of the Society:—

"As regards argon we must consider, first, whether it is a chemical individual, or a mixture, and then, whether it is a simple or a compound body. The supposition that it be a mixture, lies beyond all probabilities; it is contradicted by the researches of Olzewski into the liquefaction and solidification of argon. The supposition that it may be a compound has also little in its favour. The remarkable inactivity of argon testifies in favour of its being a simple body, although there are, of course, some compounds, also endowed with the same property to some extent. The spectrum of argon, too, is characteristic of a simple body.

"Taking it as a simple body, we must then consider its possible atomic weight, the weight of its molecule being near to 40 (although, probably, a little over 40, because of a slight mixture of nitrogen with the argon). The atomic weight of argon evidently depends upon the number of atoms which its molecule contains. We must, therefore, consider the series of possible molecular formulæ:  $A, A_2, A_3, \dots, A_n$ .

"Upon the first supposition,  $A$ , the atomic weight of argon would be about 40, and, like cadmium and mercury, it would be a monatomic gas.

"In favour of this supposition we have the specific heat ratio at constant volumes and pressures,  $K$ , found by Rayleigh and Ramsay to be near to 1.66, *i.e.* to the value which is considered as characteristic for monovalent gases. It must, however, be borne in mind that  $K$  varies for compound molecules, even when these last contain the same numbers of atoms: thus, for most bivalent gases (nitrogen, oxygen, &c.)  $K$  is near to 1.4, while for chlorine it is 1.3. This last figure makes one think that  $K$  depends not only upon the number of atoms in the molecule, but also upon chemical energy, that is, upon the stock of internal motion which determines the chemical activity of a body, and the quantity of which must be relatively great with chlorine. If, with the chemically-active chlorine,  $K$  is notably less than 1.4, we may admit that for the inactive argon it is much more than 1.4, even though the molecule of argon may contain two or more atoms.

"If we admit that the molecule of argon contains but one atom, there is no room for it in the periodic system; because, even if we suppose that its density is much below 20 (although this is very unlikely to be the case, and the contrary could rather be surmised), and that the atomic weight of argon should fall between the atomic weights of chlorine and potassium, the new body ought to be placed in the eighth group of the third series; but the existence of an eighth group in this series could hardly be admitted. In fact, an eighth group is characteristic of the large periods; and it establishes a link between the metallic elements of the seventh groups of the even series, with the metallic elements akin to them, of the first groups of the uneven series. It appears, therefore, very unlikely that the atomic weight of argon might be about 40.

"Upon the second supposition ( $A_2$ ), its atomic weight would be about 20, and in such a case argon would find its place in the eighth group of the second series, *i.e.* after fluorine. But the same objections as above could then be raised. Fluorine and sodium are, moreover, strikingly unlike to each other. However, it must be said in favour of this hypothesis that it would have the advantages of analogy, by giving a new eighth group to an even series. If we take also into consideration that the typical series are possessed of several peculiarities, we may be justified, to some extent, in supposing that the atomic weight of argon is 20, this hypothesis being already much more probable than the former ( $A = 40$ ).

"If we suppose, further, that the molecule of argon contains three atoms, its atomic weight would be about 14, and in such case we might consider argon as condensed nitrogen,  $N_3$ . There is much to be said in favour of this last hypothesis. First of all, the concurrent existence of nitrogen and argon in nature; then, the fact that many of the bright lines of the two spectra are very near to each other. Then, again, the inactivity of argon would be easily explained, if it originates from nitrogen,  $N_3$ , with giving up heat. And finally, the fact of its having been obtained, though in a relatively small quantity, from artificially obtained nitrogen. The supposition of Rayleigh and Ramsay, according to which argon has been disengaged in this last case from water, is very probable, but at any rate it is not yet proved. The hypothesis of argon being condensed nitrogen might be tested by means of introducing boron, or titanium, into an atmosphere of argon, strongly heated, and through which electric sparks would be passed.

"If we suppose, next, that the molecule of argon contains four or five atoms, its atomic weight will be 10, or 8, and in such case there is no room for argon in the periodic system.

"And finally, if we admit that its molecule contains six atoms, and that its atomic weight is 6.5, we must place it in the first series. In such case, it would probably take its place in the fifth group. Accordingly, the suppositions that argon is condensed nitrogen,  $N_6$ , or that, containing six atoms in the molecule, its place is in the first series of the system, appear to be the more probable ones, if it is a pure simple chemical body.

"From a letter received by D. I. Mendeléeff from Prof. Ramsay, it appears that the investigation of argon is being continued, and that the body finds its place in the periodic system; but the ultimate results of the researches of the two authors, who have brought before chemistry such an important new problem, and given it such an exemplary investigation, are not yet known."

#### TERRESTRIAL HELIUM (?).

WE referred last week to Prof. Ramsay's discovery of another new gas obtained from cleveite. The following papers, by Prof. Ramsay and Mr. Crookes, on this subject were communicated to the Chemical Society at its anniversary meeting.

Prof. Ramsay's paper was as follows:—

In seeking a clue to compounds of argon, I was led to repeat experiments of Hillebrand on cleveite, which, as is known, when boiled with weak sulphuric acid, gives off a gas hitherto supposed to be nitrogen. This gas proved to be almost free from nitrogen; its spectrum in a Plucker's tube showed all the prominent argon lines, and, in addition, a brilliant line close to, but not coinciding with, the D lines of sodium. There are, moreover, a number of other lines, of which one in the green-blue is especially prominent. Atmospheric argon shows, besides, three lines in the violet which are not to be seen, or, if present, are excessively feeble, in the spectrum of the gas from cleveite. This suggests that atmospheric argon contains, besides argon, some other gas which has as yet not been separated, and which may possibly account for the anomalous position of argon in its numerical relations with other elements.

Not having a spectroscope with which accurate measurements can be made, I sent a tube of the gas to Mr. Crookes, who has identified the yellow line with that of the solar element to which the name "Helium" has been given. He has kindly undertaken to make an exhaustive study of its spectrum.

I have obtained a considerable quantity of this mixture, and hope soon to be able to report concerning its properties. A determination of its density promises to be of great interest.

The spectrum of the gas was next discussed by Mr. Crookes, who said

By the kindness of Prof. Ramsay I have been enabled to examine spectroscopically two Plucker tubes filled with some of the gas obtained from the rare mineral cleveite.<sup>1</sup> The nitrogen had been removed by "sparking." On looking at the spectrum, by far the most prominent line was seen to be a brilliant yellow one apparently occupying the position of the sodium lines.

<sup>1</sup> Cleveite is a variety of uraninite, chiefly a uranate of uranyl, lead, and the rare earths. It contains about 1.5 per cent. of the rare earths, and about 2.5 per cent. of a gas said to be nitrogen.

Examination with high powers showed, however, that the line remained rigorously single when the sodium lines would be widely separated. On throwing sodium light into the spectro-scope simultaneously with that from the new gas, the spectrum of the latter was seen to consist almost entirely of a bright yellow line, a little to the more refrangible side of the sodium lines, and separated from them by a space a little wider than twice that separating the two sodium components from one another. It appeared as bright and as sharp as  $D_1$  and  $D_2$ . Careful measurements gave its wave-length 587.45; the wave-lengths of the sodium lines being  $D_1$  589.51, and  $D_2$  588.91. The differences are therefore—

	Wave-lengths.	Differences.
$D_1$ ...	589.51	0.60
$D_2$ ...	588.91	1.46
New line ...	587.45	

The spectrum of the gas is, therefore, that of the hypothetical element Helium, or  $D_3$ , the wave-length of which is given by Angstrom as 587.49, and by Cornu as 587.46.

Besides the Helium line, traces of the more prominent lines of argon were seen.

Comparing the visible spectrum of the new gas with the band and line spectrum of nitrogen, they are almost identical at the red and blue end, but there is a broad space in the green where they differ entirely. The Helium tube shows lines in the following positions:—

	Wave-length.	
(a) $D_3$ , yellow ...	587.45	Very strong. Sharp.
(b) Yellowish green ...	568.05	Faint. Sharp.
(c) Yellowish green ...	566.41	Very faint. Sharp.
(d) Green ...	516.12	Faint. Sharp.
(e) Greenish blue ...	500.81	Faint. Sharp.
(f) Blue ...	480.63	Faint. Sharp.

I have taken photographs of the spectrum given by the Helium tube. At first glance the ultra-violet part of the spectrum looks like the band spectrum of nitrogen, but closer examination shows considerable differences. Some of the lines and bands in the nitrogen spectrum are absent in that from the Helium tube, whilst there are many fine lines in the latter which are absent in nitrogen. Accurate measurements of these lines are being taken.

#### ISOLATION OF FREE HYDRAZINE, $N_2H_4$ .

M. LOBBRY DE BRUYN contributes a memoir of special interest to the current issue of the *Revue des Travaux Chimiques des Pays-Bas*. It is not long since the distinguished Amsterdam chemist succeeded in preparing for the first time free anhydrous hydroxylamine, and now he announces that he has likewise been successful in isolating free hydrazine by a similar method. Eight years ago the important discovery of hydrazine was made by Prof. Curtius, and since that time the amount of knowledge which has been accumulated concerning the base and its compounds by Prof. Curtius and his assistants is so large that a separate volume might well be devoted to it. Nevertheless, the free anhydrous base itself has not hitherto been satisfactorily prepared; indeed it would now appear, in the light of M. de Bruyn's remarkable work, that it has not hitherto been in any way isolated. The hydrate of the base has been obtained in the pure state and fully described by Prof. Curtius, but in his later communications he has expressed the view that the free base is so unstable that most probably it is incapable of separate existence. The hydrate only is produced when the salts are decomposed by a caustic alkali, and even digestion in a sealed tube at 170° with anhydrous baryta, has failed to detach the water and liberate from its combination with hydrazine. It appeared, however, to M. de Bruyn that the nature of the salt and other compounds of hydrazine rendered it scarcely probable that the base was less stable than hydroxylamine, and he considered it not unreasonable to hope that it might therefore be isolated in an analogous manner to the latter base, namely, by reacting upon the chloride with sodium methylate in methyl alcohol solution. The experiments made in this direction are only preliminary, but their result is so convincing that an account of them is at once published.

The salt employed was the chloride  $N_2H_4 \cdot HCl$ , prepared as described by Prof. Curtius. Ten grams of this salt in powder were added to 200 c.c. of pure methyl alcohol, and a solution of the calculated quantity of sodium methylate  $CH_3ONa$  in methyl alcohol were subsequently added. Common salt was immediately precipitated without any perceptible rise of temperature. The mixture was consequently boiled for half an hour in a flask fitted with an upright condenser. After cooling the sodium chloride was removed by filtration, and the solution submitted to distillation. At first mainly methyl alcohol passed over, but after a time the distillate began to contain augmenting quantities of hydrazine; the pressure was then reduced, and four further quantities separately collected. The temperature of ebullition rose to 55°, although the pressure was materially reduced. The last 20 c.c. contained the greater portion of the base. This last fraction was then again distilled at the ordinary pressure, until a residue was left which contained 73 per cent. of hydrazine. The hydrate of hydrazine only contains 64 per cent. of the base, hence it was evident that some free hydrazine had been obtained, and that hydrazine is a comparatively stable substance boiling at a temperature higher than that of methyl alcohol.

In a second experiment 42 grams of chloride of hydrazine were treated in a similar manner with methyl alcohol and sodium methylate. This larger quantity evinced some rise of temperature after the admixture, and the heat caused by the reaction of the hydrazine chloride, which at first had not all dissolved, was just sufficient to keep the liquid boiling for several minutes, when once it had been brought to the boiling point by extraneous heating. After the conclusion of the reaction the contents were cooled, avoiding the access of moisture and carbon dioxide, the sodium chloride filtered off as before, and distillation proceeded with, at first in an ordinary distillation apparatus and afterwards with the aid of a Le Bel-Henninger apparatus. A residual 40 c.c. was again fractionated under reduced pressure and six portions collected. The sixth fraction contained no less than 82.6 per cent. of  $N_2H_4$ . A smaller quantity passing over after removing the sixth fraction contained over 84 per cent. The fifth and sixth portions solidified when cooled by a freezing mixture of ice and salt. The crystals melted about 4°. Although the crystals when exposed to the air exhaled dense white fumes, owing to the attraction of moisture, a number of them were quickly pressed between cooled blotting paper, weighed, and volumetrically analysed. The analytical numbers corresponded to 92 per cent. of  $N_2H_4$ , a result which, considering the extremely hygroscopic nature of the crystals, would appear to indicate that they consisted of practically pure  $N_2H_4$ . The dried crystals melted at  $-1^\circ$  to  $-2^\circ$ .

A drop of the liquid obtained by fusion of the crystals did not explode when heated with a naked flame; a yellow flame was produced, however, accompanied by a hissing noise. The liquid base is heavier than water and considerable heat is evolved upon mixing it with a small quantity of the latter liquid. Dry oxygen slowly oxidises it. When paper is moistened with a drop of hydrazine and exposed to the air, it becomes hot spontaneously and fumes strongly. Crystals of sulphur dissolve promptly in the liquid base with considerable rise of temperature and formation of a reddish-brown liquid whose odour reminds one of ammonium sulphide; upon the addition of water to this liquid, sulphur is precipitated. The halogens react very violently with hydrazine, producing their acids, and liberating nitrogen. Iodine disappears instantly, and a quantitative experiment showed that the reaction proceeded in accordance with the equation  $N_2H_4 + 2I_2 = N_2 + 4HI$ . Potassium permanganate or bichromate act with great violence upon the liquid base, but the reaction is unaccompanied by either incandescence or explosion. The liquid appears to possess the further property of readily dissolving many salts, such as the potassium salts of the halogen acids, and nitric.

It would thus appear that, instead of being a gas, as at first supposed by Prof. Curtius, free hydrazine is at the ordinary temperature a liquid, which, however, solidifies at a temperature in the neighbourhood of that of the freezing-point of water, to colourless crystals. The base is, moreover, endowed with a very much higher degree of stability than was supposed. M. de Bruyn is now engaged in preparing it upon a very much larger scale, in order more completely to study its properties.

A. E. TUTTON.

## SCIENCE IN THE MAGAZINES.

MR. CHAS. DIXON has discovered a new law of geographical dispersal of species, and he expounds its capabilities in the *Fortnightly*. Here is a statement of his conclusions:—"Species in the northern hemisphere never increase their range in a southern direction; they may do so north, north-east, or north-west, east or west. Species in the southern hemisphere never increase their range in a northern direction; they may do so south, south-east, or south-west, east or west. The tendency of life is to spread in the direction of the poles. Among the six corollaries which I have drawn from this law, mention may be made of the following. By the fourth corollary, species never retreat from adverse conditions. If overtaken by such they perish, or such portion of the species that may be exposed to them. By the fifth corollary, extension of range is only undertaken to increase breeding area. By the sixth corollary, contraction of range is only produced by extermination among sedentary species, and probably also by extermination (through inability to rear offspring among migratory species that are neither inter-polar nor inter-hemisphere. . . . If this law of geographical distribution be true, polar dispersal of species—in other words, from the direction of the poles towards the equator—is a myth." Mr. Dixon brings forward a number of facts in support of his theory, which will no doubt be given the consideration it deserves.

An address by Mr. Leslie Stephen, on the choice of books, appears in the *National*; but, to prevent mis-conception, it is just as well to state at once that scientific literature is altogether ignored. Yet it is difficult to understand why this should be, for writings of men of science are apparently included in the definition stated by Mr. Stephen himself. "Literature, in short," he writes, "is one utterance of Matthew Arnold's *Zelusist*—the vague but real entity which is a summary of all the sympathies and modes of thought and feeling characteristic of the best minds at a given stage of human progress." A few natural history notes will be found in the *National*, in an account, by Miss Balfour, of a journey through the British South Africa Company's territory, in 1894.

Among other popular articles on natural history in the magazines received by us, we notice "Nestlings," by the Rev. Theodore Wood, in the *Sunday Magazine*, and "Snake-Taming" in *Chambers's Journal*. This periodical also contains a very readable elementary description of the great Indian Trigonometrical Survey. Mr. L. N. Badenoch describes a number of species of Plasmide in *Good Words*. In the same magazine Sir Robert Ball writes on the life and works of Copernicus. Under the title, "Tesla's Oscillator and other Inventions," a good account of some of Mr. Tesla's recent electrical work is given in the *Century*, by Mr. T. C. Martin. The article "discloses a few of the more important results he has attained, some of the methods and apparatus which he employs, and one or two of the theories to which he resorts for an explanation of what is accomplished." It is illustrated with fifteen figures, all of which possess points of interest. Mention must be made here of a short biographical sketch of Helmholtz, contributed by Mr. Martin to the March number of the *Century*, but overlooked at the time. The sketch is illustrated by a fine engraving from a photograph of Helmholtz, taken in 1893. A brief note in *Cassell's Family Magazine* describes some curious tubular dwellings constructed against the side of a small aquarium by the species *Amphith. littorina*. The tubes are semicircular, and composed of sand and small pieces of seaweed, cemented together with a glutinous matter secreted by these shrimps.

The practicability of constructing a railway from the Mediterranean to India is discussed by Mr. C. E. D. Black in the *Contemporary*. Over India proper there are 18,500 miles of lines open to traffic. But westward these lines break off at Peshawar, Chaman, and Kurrachee. It is proposed that a line should be constructed from Port Said, through Northern Arabia, along the edge of the Persian Gulf, to Kurrachee—a distance estimated at 2400 miles.

In addition to the magazines mentioned in the foregoing, the *Humanitarian*, *Scribner*, and *Longman's Magazine* have been received. A portrait of Prof. Bonney accompanies an article on "Science and Faith" in the first of these magazines.

PRECIOUS STONES, AND HOW TO DISTINGUISH THEM.<sup>1</sup>

AMONG the duties which fall to the lot of an official in the Mineral Department of the British Museum, in his otherwise unromantic and sternly studious life, is one which is not altogether devoid of human interest. It may happen, for example, that a lady having inherited a priceless heirloom in the shape of a large emerald, travels from the Antipodes in order to sell it in England for its true value, and desiring to display its charms brings it to the Museum. To inform such a person that the stone is but green bottle glass cannot be a pleasant task.

Only within the last few months came an Afghan prince who had sold his worldly goods, travelled to the coast of India, and worked his passage to England, having secreted about his person a stone which he supposed to be of enormous value. His story was that as he slept upon the hillside, Mahomet had appeared to him and told him that he would find a rare jewel under his hand. The poor man could not be convinced that a stone with this celestial guarantee could be anything common; for, as he said, "Mahomet cannot lie." Be this as it may, the stone was quartz, and its princely owner could only be advised to repair his fallen fortunes in some Oriental fashion at Constantinople—Kensington.

It is curious that the stones brought by such people are always, in the opinion of their owners, gems of the greatest value and rarity. Could they but have consulted some competent expert nearer home, they would have been saved time and money and bitter disappointment.

But after such interviews, I have always been very forcibly impressed by the fact that even the experts do not seem in the least aware of the simple and certain methods which have been placed at their disposal by recent mineralogical research. There is, perhaps, no subject in which experts have been so slow to take advantage of practical methods supplied by science as in the manipulation and discrimination of precious stones.

The stones brought by these chance visitors have often been bought and sold over and over again under totally false names. There is, I suspect, scarcely a collection, public or private, in which some of the jewels are not wrongly described.

Mistakes are constantly made; and these are sometimes of considerable commercial importance. It may be remembered, for example, that a few years ago much excitement was caused by the discovery of rubies in the Macdonell Range in Southern Australia. Much time and money was wasted in their extraction before it was discovered that, like the so-called Cape rubies, they were merely garnets.

I should be the last person to underrate the great value of that knowledge which results from long experience, or to deny that in ninety-nine cases out of a hundred an expert may be absolutely right. Every one must admire the confidence with which a practised eye can even pick out from several packets of diamonds those which came from a certain mine.

Such a professional expert may in five seconds pronounce a judgment which it might require half an hour to establish by scientific methods, and one which may be equally correct.

But there is a vast difference between "may be" and "is," and scientific men are not satisfied with that sort of judgment, but require actual proof.

One ought to distinguish between two sorts of expert knowledge—that which results from long experience and the training of eye and hand, and that which results from familiarity with scientific methods. To have confidence in the non-scientific expert, one must place reliance upon his personal character and the soundness of his senses, and be sure that his actual experience has included problems similar to the one submitted to him, and even then he may fail in that hundredth case.

But the scientific tests cannot err; moreover, they furnish a proof which carries conviction to all who see it. The opinion of the expert need *convince* none but himself.

An exact parallel is to be found in medical practice. It is no doubt often possible for a doctor of experience to diagnose diphtheria and phthisis by their symptoms. But in recent years new methods have been made available by the discoveries relating to bacteria, and at the present time no diagnosis of diphtheria or of the early stages of consumption would be cen-

<sup>1</sup> A lecture delivered at the Imperial Institute, by Mr. H. A. Miers.

sider, I cannot think which did not include the bacteriological evidence; that is to say, the isolation and microscopic examination in each case of the specific bacillus. What is more, such evidence is not conclusive of the existence of the disease.

Numerous characters at all generally employed by persons engaged in the trade in precious stones are two—namely, hardness and the specific gravity or weightiness.

Topaz scratches quartz, and is scratched by topaz, it is said to have a hardness between that of quartz and that of topaz; topaz scratches topaz, but is scratched by sapphire, it is said to have a hardness between that of topaz and that of sapphire. Many minerals, including the gem-stones, have been tabulated according to their hardness with reference to ten standard stones, of which the diamond, the hardest of all known substances, is the first in the list. If, for example, a red stone, supposed to be a ruby, is found to be only about as hard as topaz, it cannot be a true ruby, but must be a spinel ruby, which is quite a different thing; or if it is sufficiently soft to be scratched by rock-crystal, it is probably a red garnet.

This test is obviously a very rude one in more senses than one. Not only does everything depend upon the nature of the scratching part, whether it is a sharp corner or a curved surface, and upon the direction in which the scratch is made; but, to say the least, the surface of a gem is certainly not improved by scratching.

The second test—that of the weightiness—is a really accurate and scientific one, provided that it be made by means of a delicate chemical balance. A stone which is, bulk for bulk, three times as heavy as water, is said to have a specific gravity of 3; one such as topaz, which is three and a half times as heavy as water, is said to have a specific gravity of 3.5. The ordinary method is to weigh the stone, suspended by a thread, first in air, and then immersed in water. The difference is exactly the weight of the water displaced by the stone, and so the specific gravity is easily found.

The objections to this method are, firstly, that it is too laborious; and secondly, that it is not applicable when the stone is very small, because it is then impossible to weigh it with accuracy under water. I should not rely upon the specific gravity of a stone under two carats in weight as determined by this method. A method which I shall presently describe is perfectly free from both these objections.

Incredible as it may seem, the estimation of hardness and the specific gravity are the only attempts at anything like scientific measurement ever made in the ordinary course of business applied to stones; and even then the weightiness is usually estimated merely by poising the stone in the hand. For the rest they are identified by their colour, their fire or sparkle, their lustre and their general appearance.

In a lecture delivered to the Society of Arts in 1881, Prof. Church drew attention to the necessity of scientific methods for this purpose, and has more than once, on subsequent occasions, reiterated his plea. I propose to dwell more particularly on improvements which have been introduced since the date of his lecture, and to indicate how one may, by simple practical tests, which require little special knowledge, distinguish with certainty all gem-stones without in any way injuring them.

Chemical analysis, by the very nature of the problem, out of the question; for in order to make an analysis, or to apply the simplest chemical test, it is necessary to destroy a part of the material; and this cannot be done, at any rate in the case of a cut stone.

We can begin by dismissing the hardness as a character which it is really unnecessary to determine, except to identify diamond or to distinguish a real stone from paste; here, I know, I shall earn a rebuke from the orthodox mineralogist who, in order to pursue the study of what should be a peaceful science, arms himself with a knife, and proceeds to scratch everything which he comes across.

The weapons which I would recommend are of a milder nature: the microscope, the spectroscope, the goniometer, and the refractometer.

Among the available characters of gems, first and foremost are the optical properties; that is to say, the appearances seen when we look at them, or through them, in various ways.

The extent to which a ray of light is refracted on entering and on leaving a transparent stone, is a characteristic property most useful for determination. As everyone knows, a stick half immersed in water appears bent owing to the refraction of light on passing

out of the water; if it is immersed in a more highly refractive liquid, it appears more bent.

To ascertain the refractive power of any transparent substance like glass, a prism-shaped piece is cut from it, and the extent to which a ray of light is refracted on passing through the prism is measured by the goniometer, an instrument found in every physical laboratory.

I have not seen this recommended as a method to be practically used, because it is commonly supposed that a special prism must be cut from the stone for the purpose. For the benefit of those who possess a goniometer, I may say that it is a method which I constantly apply, and find most useful for unmounted cut stones. It is always possible to find two of the facets which form a convenient angle, and, after inking over the remainder of the stone, to trace the ray passing through these two facets, and so to measure with absolute accuracy not only the refraction but the double refraction of the stone; moreover, this method is applicable to any stone, however great its refractive power.

Another simple plan which can be used by any one, but unfortunately only for stones of comparatively low refractive power, has been invented during the last few years. This delightfully simple little instrument, known as the reflectometer, consists of a hemispherical glass lens viewed by an eye-piece containing a graduated scale; it need only be pressed against the plane surface of a cut stone previously touched with a drop of liquid of higher refractive power than the stone itself. On looking into the eye-piece a shade is seen over half the field of view, and its edge crosses the scale at a point which gives the exact refractive index of the stone. The best available liquid is monobromo naphthalene, which has a refractive power higher than that of topaz, and enables one at a glance to distinguish a cut topaz or any less brilliant gem-stone.

Most useful, again, are the so-called interference figures—the appearances seen on looking through a transparent stone by means of a polarising microscope, such as is used by every geologist. There is, of course, nothing new in these figures; they are now employed by geologists in the study of rocks, and even sometimes by those whose business it is to distinguish precious stones.

Without endeavouring to explain the nature of these figures, except to say that they are due to the double refraction of the crystal, it is easy to show that by looking at a stone through a microscope, one may see something very characteristic.

(The interference figures of several minerals were thrown upon the screen by means of a projection apparatus lent by Prof. Ayrton; sapphire, tourmaline, and emerald were shown to give coloured circular rings intersected by a black cross; sphene and chrysoberyl, coloured oval rings intersected by a hyperbola; and quartz, coloured circular rings with a black cross having a tinted centre.)

This beautiful method is not employed nearly so largely as it deserves, because most people find it difficult. In order to see the figure it is necessary to look through any given crystal in one certain direction. (The stones used for projection were plates appropriately cut for the purpose). Now it may happen that a faceted stone is so cut that to look along the required direction would be to look through an angular corner; and every one knows that it is not possible to look through a pointed corner, owing to the refraction of the light. For this reason when an unmounted cut jewel is held under the polarising microscope, and yields no interference figure when turned about into various positions, it is usually given up as hopeless. But obviously we have only to immerse the stone in some liquid having nearly the same refractive power as itself, in order to eliminate the difficulty due to refraction. I find that if the stone be placed in a small tube filled with oil or glycerine, and held in various positions, the interference figure can always be seen. Little more than a year ago, a small faceted stone of peculiar appearance was sent to me, which had deceived the experts to whom it had been shown, although agreeing in some respects with quartz, and was supposed to be a new stone. But by immersing it in oil in a hollow glass sphere, I was able to see the characteristic interference figure of quartz. When a stone has the refraction, the double refraction, the specific gravity, and the characteristic interference figure of quartz—it is quartz and nothing else.

Other optical characters of great value are those resulting from the absorption of the light in its passage through a crystal;



some of the colours contained in ordinary daylight are more absorbed than others, and the light emerges more or less coloured; in consequence of differences of absorption, some gem-stones appear differently coloured according to the direction in which one looks through them. I need not dwell upon this curious property because the instrument used to observe it is the one piece of scientific apparatus sometimes, but by no means generally, used by gem experts—I mean the instrument known as the dichroscope. (A diagram, kindly lent by Prof. Judd, illustrated the appearance seen with this instrument.) Far less familiar is the method of studying the absorption by means of the spectroscope, although the value of this extremely simple method was pointed out many years ago by Prof. Church. Every one knows the colours of the spectrum seen by daylight through a glass prism, and it is also well known that if light transmitted through various vapours be appropriately observed through such a prism by means of the spectroscope, certain black lines are seen in the spectrum, indicating that the vapour has absorbed light of a certain colour; in this way astronomers are able, by merely looking at the sun and stars, to ascertain many of the elements which they contain.

But it is not commonly known that a precisely similar effect is produced by many transparent minerals. It is only necessary to look through a pocket spectroscope in a bright light at any transparent mineral containing the rare element didymium, and certain black bands characteristic of that element are at once seen in the spectrum.

(A diagram of the spectrum of the phosphorescent light emitted by ruby when made to glow in the electric discharge in a vacuum tube, lent by Prof. Crookes, though not a picture exactly of what is here described, served to illustrate the appearance of the black bands in the spectrum of a red mineral.)

Now, there are two gem-stones which give very characteristic black bands when looked at through a spectroscope, namely, the jargoon or jacinth, and the variety of garnet known as almandine, commonly called carbuncle. When a stone, say one set in a ring, is looked at in this way, and gives the characteristic spectrum of zircon, it is at once known to be a jargoon without further trouble.

When one remembers how many pocket spectroscopes are bought by people who wish to see the rain-band and predict the weather, it is surprising that it has not also come into use for the examination of gems.

To pass from optical to other characters, there is a very remarkable property possessed pre-eminently by one mineral which has not, so far as I know, been previously recommended as a practical test.

A crystal of tourmaline while being warmed or cooled becomes electrified; one end becomes charged with positive, the other end with negative electricity. The fact has long been known. But a few years ago an extremely pretty and ingenious way of showing the electrification was devised by Prof. Kundt. If a mixture of powdered red lead and sulphur be shaken or blown through a sieve, the particles become electrified by mutual friction, and if it then be dusted upon a crystal of tourmaline which is being warmed or cooled, the positively electrified end of the crystal attracts the negatively electrified yellow sulphur, and the other end attracts the positively electrified red lead; one end of the crystal becomes red, and the other end yellow; and so the difference of electrification is made visible. Now every crystal of tourmaline behaves in this way, and I find it perfectly easy to show the property in an ordinary small jewel, even when mounted in a setting. All that is necessary is to warm the stone, and then, while it is cooling, to dust it with the mixture; at once one part of the stone becomes red, and another part yellow.

(A faceted stone treated in this way was shown upon the screen by reflected light.)

The last character which I have to mention is the one to which I alluded at the beginning, namely, the heaviness or specific gravity. The use of the balance is, as I said, too laborious; but within the last few years an entirely different method has been introduced.

Cork and wood float in water because, bulk for bulk, they are lighter; stone and iron sink because, bulk for bulk, they are heavier than water. But find some substance whose density is exactly that of water, and it will neither rise nor sink, but will remain poised in the water like a balloon in mid air.

Several liquids have been discovered which are more than three and a half times as dense as water, in which, therefore,

amethyst, beryl, and other light stones will actually float. Prof. Church strongly recommended mercuric and potassium iodide; but a still more convenient liquid is now available, namely, methylene iodide. This liquid has a specific gravity of 3.3, so that tourmaline readily floats in it; further, it is not corrosive or in any way dangerous, which is more than can be said for several of the other liquids which have been recommended.

Now it is scarcely possible to prepare a number of liquids, each having the specific gravity of one gem-stone, in order to identify each stone, but methylene iodide is easily diluted by adding benzene to it; each drop of benzene added makes the liquid less dense, and so it may be used to separate tourmaline and all the lighter gem-stones from each other. Nothing can be easier or more satisfactory than this method; no matter how minute the stone may be, it can be identified by its density in a few moments. Suppose it be doubtful whether a certain gem is aquamarine or chrysoberyl, all that is necessary is to place it in a tube of the liquid, together with a small fragment of true aquamarine to serve as an index; if it be a chrysoberyl, which has a specific gravity of 3.6, it will sink like lead; if it be an aquamarine, which has a specific gravity of 2.7, it will float; and if the liquid be then stirred and diluted until the index fragment is exactly suspended, the gem also will neither float nor sink, but will remain poised beside it.

The delicacy and simplicity of the method is marvellous; the only reason why it has not been more generally adopted is that, unfortunately, the greater number of gem-stones are heavier than methylene iodide. What is the use of employing such liquids when they cannot float jargoon, carbuncle, sapphire, ruby, chrysoberyl, spinel, topaz, peridot, and diamond, to mention only those stones whose names are familiar?

But this objection is now entirely removed, thanks to a discovery made quite recently by the distinguished Dutch mineralogist, Retgers. He has found a colourless solid compound which melts, at a temperature far below that of boiling water, to a clear liquid five times as dense as water; and therefore sufficiently dense to float any known precious stone.

This compound is the double nitrate of silver and thallium, and it further possesses a most remarkable property; it will mix in any desired proportion with warm water, so that by dilution the specific gravity may be easily reduced. The fused mass may be reduced in density by adding water drop by drop so as to suspend in succession jargoon, carbuncle, sapphire and ruby, chrysoberyl, and spinel.

This wonderful compound should certainly be employed by all who wish to distinguish gems with ease and certainty.

Let me now remind you how one could apply the methods which I have been describing, to identify with absolute certainty some gem-stone. Take, for example, a cut tourmaline. Dropped into methylene iodide it would just float, and, when the liquid is diluted, it would remain suspended beside an index fragment of tourmaline, and no other gem-stone. Examined with the dichroscope it would show two coloured images, indicating remarkable differences of absorption characteristic of tourmaline, and no other mineral; the absence of absorption bands, when it is viewed through the spectroscope, would show that it is neither garnet nor jargoon; in the polarising microscope it would show the interference figure of tourmaline.

Even if the stone were mounted in a setting so that these tests could not be applied, it could be examined with the reflectometer, the boundary of the shade would cross the scale at a point exactly corresponding to the refractive power of tourmaline; and lastly, it could be warmed and dusted with red lead and sulphur, when the two coloured patches would betray the electrical properties of tourmaline. There is enough evidence here to satisfy any one but an English jury hearing expert witnesses, and everything can be done without inflicting even a scratch upon the stone.

Another mineral character of great value in distinguishing gem-stones in the rough I have not alluded to, because it can only be made use of when they are more or less well crystallised; I mean the shape of the crystals. (This feature was illustrated by some very beautiful photographs of gem-stones and other minerals in their natural state, which were taken from specimens in the British Museum by the distinguished photographic expert, Mr. Hepworth.)

It might be asked, with some show of reason, why should we require all these scientific tests which I have described, when the varieties of precious stones are so few in number? In reality, however, gem-stones are far more numerous than is commonly

supposed, although they often pass muster under erroneous names. Tourmaline is sold as ruby, cinnamon stone as jacinth, white zircon and phenacite as diamond, while green garnets are universally known in the trade as olivine or peridot.

That the varieties of available gem-stones are not far more numerous, is due mainly to the prejudice of purchasers, who judge the changes on diamonds, rubies, sapphires, and emeralds, and have heard of nothing else; estimating the stones, as the public estimates popular actors or authors, not by their real excellence, but by their names.

In the mineral gallery of the British Museum are many examples of cat stones which have rarely or never been employed in jewellery, but should certainly win favour on their own merits.

One very curious example is a little gem cut from a crystal of the ordinary tin-stone, the same ore which is worked for tin in the Cornish mines. This is a stone which, when cut from a sufficiently transparent crystal, possesses a most beautiful lustre and colour.

As another example, I may mention a stone which, I suspect from its appearance, would make a very beautiful gem. It was sent with some other fragments from the ruby mines of Burmah; it is only a single rough fragment, and has completely puzzled every one to whom I have shown it. By means of the very tests which I have been describing, and without sacrificing more than a pin's point of the stone, I have been able to identify it as the boro-silicate of lime known as Danburite. This mineral, if it has ever been used in jewellery, which is most unlikely, has certainly never been rightly named.

(A number of faceted stones lent by Mr. Gregory, who has made many interesting experiments in this direction, were thrown upon the screen by reflected light; among these were several of the less familiar gems, such as tourmaline, chrysoberyl, phenacite, felspar, andalusite, axinite, spodumene, sphene, and idocrase.)

I do not know whether the final impression produced by what I have said, is that the determination of stones is an easy or a difficult thing. The impression which I wished to convey, is that where these scientific tests can be applied, it is an absolutely certain thing; and where they cannot be applied, there is no such certainty.

The crystals from which these gems are cut are changeless and imperishable, their beauty has been enhanced by the art of man, but they have lost none of their wonderful properties in the process; in fact, it is only by utilising these very properties that the lapidary converts them from dull stones to flashing jewels, and it is by these properties that we have to recognise them.

The ruby formed countless ages ago in the heart of Burmah, is the same thing in all essentials as the ruby formed to-day in a Paris laboratory.

It is curious to reflect that the diamond which to-day glitters in a London ball-room, may have adorned the crown of some Oriental monarch centuries ago—may have been picked from the shores of an Indian stream in the dawn of civilisation—may have been the silent witness of the growth and decay of empires—but by its own unchanging existence has always borne steadfast evidence to the everlasting laws of nature.

H. A. MIEES.

### THE OBSERVATION OF EARTH-WAVES AND VIBRATIONS.

THE object of this communication is to call attention to the apparently high velocity with which motion is transmitted from an earthquake centre to places distant from it a quarter of the earth's circumference, and to the importance of instituting an extended systematic observation of these movements.

During the last few years Dr. E. von Rebeur-Paschwitz and other observers in Europe have recorded earth movements which had their origin in Japan or in other distant countries. Beyond a radius of a few hundred miles from their origin these disturbances are often too feeble to be sensible or to be recorded by ordinary seismographs. Their presence is, however, made known by the use of specially contrived nearly horizontal pendulums, and by these and other instruments we find that they usually have a duration of from ten to thirty minutes, and then they last one or two hours. On June 3,

1893, the writer obtained a record lasting 5 hrs. 24 min. In Europe what was probably the same disturbance indicated a movement which continued for about fifteen hours. From observations hitherto made, it seems extremely likely, as Dr. E. von Rebeur-Paschwitz has suggested, that these earth-waves could be recorded at almost any point upon the surface of our globe, while the phenomena they present are such that it is probable that their extended study would throw light, not only upon the manner in which motion is transmitted through the superficial portions of the earth, but also across its interior.

As illustrative of the results to which these records lead, I take those derived from diagrams of several seismographs in Tokyo, and from that of a long pendulum seismograph at Rocca di Papa in Italy, which on March 22, 1894, together with many other instruments in Europe, exhibited considerable motion. The origin of the disturbance was off the N.E. coast of Yezo (Lat. 42° N., Long. 146° E.).

From observations made in Tokyo, distant about 600 miles from the epicentrum, not only upon the initial disturbance, but also four after-shocks, it seems that motion was propagated at an average rate of about 2.3 km. per second. Inasmuch as the instruments from which these records were obtained, are not capable of recording movements of small amplitude, probably this velocity was that of the pronounced vibrations of the quasi-elastic nature characteristic of most earthquakes. There are reasons for believing that such waves outside an epifocal area are practically confined to the surface of the earth. A movement which from the manner in which it slowly affected ordinary or horizontal pendulum seismographs, had probably a similar character, travelled from Japan to Italy with a velocity of from 2.7 to 3 km. per second, the larger waves travelling at the slower rate.

Preceding these decided motions, minute tremors were observed, which, if they originated at the epicentrum and travelled on the surface of the earth, must have done so at a rate of 11.5 km. per second, while if they were created by the transformation of the energy of the partially elastic undulations as they passed from medium to medium, then their velocity of propagation must have been still more abnormal. If it is assumed that they reached Italy by direct radiation through the earth, or that in consequence of refraction they followed curvilinear paths, the observations indicate a velocity of 9 or 10 km. per second.

Considering the influence of gravity upon the propagation of surface undulations, the observed velocities may possibly be a little lower than what might have been expected. The minute tremors, however, seem to have a velocity which is roughly twice that for a condensational rarefactional wave in glass.

Observations upon other earthquakes, although none of them can claim any great degree of accuracy, point to the same general results.

At present, the diversity of instruments employed in Europe, and the various degrees of sensibility given to the few instruments which are approximately similar, apparently results in the recording of different phases of motion, and it is not likely that our knowledge will be increased or made more accurate until there is greater uniformity in the methods of observation.

Now to determine whether the disturbances created by large earthquakes are propagated to distant localities in the manner suggested, much might be learned by establishing twelve or fourteen similar instruments at an equal number of selected stations round the northern hemisphere. It is yet premature to indicate the class of instruments to be employed, but if their chief function is to record the time of arrival and the different phases of these wide-spreading movements, it is the writer's experience that many difficulties may be avoided in installation, adjustment and management, by using a type that is not too sensitive to extremely minute changes of level, such as accompany fluctuations in temperature and changes in atmospheric conditions. All of them should admit of adjustment to a similar degree of sensibility, and so far as possible be attached to similar foundations in localities or places where the effects of tremor storms, which often eclipse the effects due to earthquakes, are not likely to be pronounced. Photographic surfaces on which records are received, should move at a rate of not less than two inches per hour, which will enable an observer to determine time intervals to within 30 seconds.

It would seem advisable that the first attempt to make a seismic survey of the world should be tentative. Having ob-

tained the co-operation of observers in selected localities, each of these should be furnished with a similar instrument, and if possible receive personal instruction as to its installation and working. If this is done, then an inexpensive type of apparatus may be employed, which in an ordinary foundation will yield results not much inferior to those obtained from more elaborate arrangements, which subsequently it may be thought desirable to establish.

Although it may only be possible to minimise the effects of tremors, the records of these over extended areas may perhaps present new features. Other movements which are likely to be noted, but which will not influence the recording of movements resulting from distant earthquakes, will be diurnal and other periodic displacements of the pendulums. The records of these, together with those of local earthquakes, could hardly fail in adding to the knowledge we possess about earth movements.

The principal object of the proposal made in the foregoing remarks, is to determine the velocity with which earthquake motion is propagated over the surface of the earth, and possibly through its interior. If it is established that vibratory motion is transmitted with a measurable velocity through the earth, it will be difficult to over-estimate the value of the knowledge we shall have gained. The rigid scrutiny of the records bearing on this latter point have to be left to European observers.

At present the writer is engaged in drawing up a report upon the state of our knowledge respecting the velocity with which earth vibrations and waves are transmitted through rock and earth, and in making experiments to determine a form of simple instrument which shall be not only sensible to slight changes of level, but which is also capable of recording vibrations of small amplitude.

Since writing the foregoing, which was printed for circulation amongst a few of my friends interested in this branch of earth physics, I have received NATURE of December 27, 1894, in which, on p. 208, Dr. E. von Rebeur-Paschwitz gives a description of the remarkable disturbance of June 3, 1893, to which I have already briefly referred. In July of that year I sent photographs of this record to various acquaintances in Europe. One of these, together with a description of the same, because it was illustrative of a great number of unfelt earthquakes which I had recorded, was sent with the fourteenth report to the British Association on seismological work in Japan during 1893-1894. This report is, I believe, now in the press. The object in calling attention to this matter is to show that this disturbance, wherever it originated, was also pronounced at places far distant from Strasburg, Nicolaiew and Birmingham.

Mr. C. Davison, who writes the introduction to the description of the European records of this earthquake, makes a brief reference to the desirability of having a few well-chosen stations in various parts of the world where earth pulsations might be recorded—a matter on which I have had considerable correspondence with my friend Dr. E. von Rebeur-Paschwitz. At present Mr. Davison considers that Europe is fairly well provided with instruments. Instruments are certainly fairly numerous, but at the same time in many instances they vary in their sensibilities and also in their objects. Judging from the report of the Committee on Earth Tremors to the British Association in 1893, p. 294, it would seem that the instruments in Birmingham and Edinburgh are arranged to be unaffected by rapid tremors, and register "slow earth tilts only," while the tromometers of Italy are, I presume, constructed to record what this name implies. Whether they are able to record "elastic" tremors is a debatable matter. A very good illustration of what the heterogeneity of the instruments at present employed in Europe leads to, is given by Mr. Davison in the records of two earthquakes, contained in the report of the above-mentioned Committee for 1894, which may have had velocities of propagation varying between 1 and 12 km. per second, according to the type of instrument from which records were obtained. The apparent explanation of these anomalies is that different instruments have recorded different phases of motion, and for this reason I have been led to say that it is not likely that our present knowledge will be increased until there is greater uniformity in the methods of observation.

Mr. Davison's remark that "in Japan Prof. Milne's tromometer (as described in British Association Report, 1892,

pp. 207-209) leaves little to be desired," requires qualification. As a "tremor" recorder it is excellent, but even as such I have improved it by reducing its length to 30 mm. and its total weight to 0.39 grms. Unfortunately however, because it is a tremor recorder, its movements are such that even on a photographic film only one metre distant, it may during a severe "tremor storm" give a trace which appears as a band two inches in breadth, which eclipses any effects due to distant earthquakes, for the recording of which it is therefore useless. At various times I have experimented with at least a dozen of such contrivances, which from the nature of their construction have necessarily short periods of vibration, and are therefore not sensible to slight tilting. Although I condemn these instruments for the recording of distant earthquakes, I must admit that I am indebted to a pair of them for having first made visible to me the diurnal wave.

In the *Seismological Journal*, vol. iii. p. 60, a sketch is given of a horizontal pendulum, such as I have used to record the daily wave and unfelt earthquakes since November 1893. One of these, which has a boom 5 feet in length, has usually a period of about 50 or 55 seconds. Altogether I have six sets of such apparatus with photographic recording surfaces, together with one or two others, which are read once per day.

These have been installed at and given records from eighteen localities—in caves, in the solid rock, in an underground chamber, and on substantial columns rising from the natural soil.

Although these instruments are exceedingly bad forms for tromometers, by these experiments—each of which continued over several months, during which time continuous records were obtained—much was learned about the localities where "tremor" effects might be avoided.

To solve the problem under consideration it does not seem necessary to have an instrument sensible to less tilting than 1°, and it is certainly undesirable to have one sensible to the phenomena called earth tremors or microseismic disturbances, which appear to have the character of earth pulsations. What is required is an instrument which is susceptible to the tilting produced by the undulatory slow travelling quasi-elastic disturbances of an earthquake, and at the same time is sensible to the minute, and possibly truly elastic vibrations which, both in Japan and Europe, outrace the more pronounced movements. The first object, and to some extent the second, is certainly attained by many instruments in Europe. From the records given by the long pendulum of Dr. Agamennone, of which I have not had an opportunity to see a full description or drawings, I take it that for the preliminary vibrations, the pendulum acts as a steady point, relatively to which the movements are magnified by means of a pointer arranged like that of a seismograph. The larger movements, which have periods of about 16 seconds, may be due to the slow heaving over of the pendulum following the motion of the supporting tower. About these latter movements we already know a great deal, and their velocities of propagation, as determined by the most accurate methods in Japan, do not materially differ from the rate at which the same disturbances continue on their journey to Europe.

What we most require is an investigation of the velocities of propagation of the elastic movements which apparently go from Japan to Europe in 15 or 20 minutes.

If such phenomena exist, and if the European records are correct, their existence is a reality, the instruments to record their repetition must be sensible to small but rapid vibrations; and for the results to be comparable, these instruments must not only be similar in construction, but they must be similarly adjusted and similarly installed.

Within a few days the writer will have completed two instruments differing only in their size, which may be described as conical pendulum seismographs in which the multiplication relatively to their centres of oscillation will be adjustable from about 20 to 40. The registration will as usual be photographic. It is hoped that because the multiplication is large, and because everything is as light as possible, the preliminary tremors (elastic vibrations) may be recorded; while because the booms are long, it is not unlikely that the sensitiveness to tilting will be sufficient to record the slower waves. They will be tested upon a foundation the diurnal tilting of which is known, and where it is also known that tremors (earth pulsations) are seldom met with.

JOHN MILNE.

SOCIETIES AND ACADEMIES.

LONDON.

Royal Society, March 21.—“A possible Explanation of the two H Spectra of Oxygen and Nitrogen.” By E. C. Cady.

The two spectra of oxygen are shown to be of a different nature. They behave differently, and reasons are given for their being in all probability the spectra of different gases. They may either be two spectra produced by different vibrations of the oxygen molecule, or they may be the spectra of two different modifications of oxygen, or the spectra of two distinct gases resulting from a dissociation of oxygen, a combination of which is called oxygen.

It appeared worth while to undertake experiments with a view of testing the last of these. Oxygen was sparked in an apparatus similar to that used by Prof. J. J. Thomson in his experiments on the electrolysis of steam. Hollow platinum electrodes were used, each one of which was connected with a Sjergel mercury pump. In the first experiments, the distance between the electrodes was 35 mm., and the highest pressure compatible with the appearance of the two spectra was made the starting point of the experiments. In these first experiments it was 380 mm. The density of the oxygen before sparking was determined, and taken as a test of its purity. The fractions obtained from the anode and cathode were weighed and the results are given. They follow the lines of J. J. Thomson's results, inasmuch as with long sparks a lighter fraction was obtained at the cathode, and with short sparks a heavier fraction. The fractions from the anode were not so definite as from the cathode, though the difference was in the right direction. The probable maximum error of weighing was 0.0001 gram. This meant exactly one in the second decimal place of the density obtained. The general accuracy of the results may be gauged from the densities of unsparked oxygen obtained.

Density of cathode fraction with long sparks.	Density of oxygen unsparked.	Density of anode fraction with short sparks.
15.78	15.88	16.00
15.79	15.87	16.01
15.80	15.89	16.02
15.79	15.88	16.04
	15.88	16.09
		16.05

Mean of results of other observers 15.887.

Density of cathode fraction from oxygen, previously for three days faciliated with short sparks, 15.75.

The experiments are still in progress.

Physical Society, March 22.—Mr. R. T. Glazebrook, F.R.S., in the chair.—On the objective reality of combination tones. By Prof. A. W. Rucker and Mr. E. Eisler. The question as to the objective or subjective nature of combination tones has excited much scientific controversy, and the authors have devised some experiments to elucidate this point. These experiments, some of which were exhibited before the Society, show that under certain conditions difference and summation tones are produced which are capable of disturbing resonating bodies. A resonator (cylinder, in the first instance, employed a tuning-fork). A piece of tin wood, about 5 m. square, is attached to one of the prongs of the fork, while a silvered glass mirror is attached to the other, so that the pitch of the fork is very accurately adjusted to sixty-four complete vibrations per second. In order to detect any movement due to resonance set up in this fork, the mirror carries a spring forms part of a system of mirrors for producing Michelson's interference bands. By this means a movement of the prong of the fork of 1/8,000 of an inch will change the length of the path shown by the disappearance of the interference bands. The appearance of sound is a siren was employed, this being one of the instruments which Helmholtz recommends as giving the best results. The pitch of the notes given by the siren was adjusted by changing the disappearance of the interference bands by one of the notes with a bowed lark, or by a diatonic oboe. A large wooden cone, placed before the siren and the resonating cylinder, served to concentrate the sound on the wooden cone at each of the latter. The sensitivity of this arrangement is such that when a large Koenig tuning-fork, giving sixty-four vibrations per second, is struck with a mallet, a resonator, which is connected to the fork, cannot be heard. When the fork is struck with a hammer, the bands instantly disappear.

The apparatus, however, is unaffected by any other note, except one of sixty-four vibrations per second. A number of experiments have been made, using various rows of holes on the siren, and in every case when the summation or difference tone corresponded to sixty-four vibrations per second, the interference bands vanished, showing that under the conditions of the experiment these tones have an objective existence. An experiment has also been made to determine whether Koenig's lower beat tone when the interval is greater than an octave is objective. In this case, however, the authors entirely failed to get any evidence of such an objective existence. A number of experiments have been made with a view to elucidating the cause of the production of the summation tone, which tend to show that it is not the difference tone of the partials of the fundamental notes. In addition to using a tuning-fork to detect the combination tones, the authors have made use of an instrument originally devised by Lord Rayleigh. A light mirror is suspended by means of a fine quartz fibre, and hangs in the neck of a resonator, tuned to the given note, and when at rest is inclined at 45° to the axis of the resonator. Under these circumstances, when the resonator responds the mirror tends to turn and set itself at right angles to the direction of motion of the air in the resonator. The results obtained with this instrument are in complete accord with those obtained by the first method. Up to the present the authors have failed to obtain any evidence of the objective reality of the combination tones produced by organ-pipes and tuning-forks (see p. 474). The discussion on this paper was postponed till after the reading of the next paper.—Some acoustical experiments, by Dr. C. V. Barton. (1) On the subjective lowering of pitch of a note. The author has noticed that if a tuning-fork, mounted on a resonator, is strongly bowed, then if the ear is placed near the opening of the resonator the pitch of the note heard appears lower than when the fork is bowed very gently or is held at some distance. This subjective lowering of pitch is most marked with forks of low pitch; and in the case of a fork giving a note of 128 complete vibrations per second, amounts to about a minor third. The author suggests an explanation depending on the supposition that the basilar membrane of the ear behaves as if it consisted of a number of stretched strings of various lengths, each resonating to a given note; and that the appreciation of the pitch of a note depends on the localisation of the part of the basilar membrane which resonates most strongly. Further, he shows that in the case of a stretched string, for finite displacements, the string which most strongly resonates to any note will have a "natural" period longer than the period of the disturbance; the greater the disturbance the longer will be the natural period of the strings most strongly affected. Hence when the intensity of a note increases, the tract of the basilar membrane most strongly affected is displaced in the direction which corresponds to the perception of lower notes. (2) Objective demonstration of combination tones. Where two organ-pipes are sounded and alternately separated and brought close together, an observer, at some distance, hears the difference tone much more clearly when the pipes are close together than he does when they are separate. As the position of the pipes with reference to his ear does not appreciably change, the change in the intensity of the combination tone indicates that it has a real objective existence. The author mentioned that he had sounded his two pipes, which give a difference tone of 64 vibrations per second, before the collector of Prof. Rücker and Mr. Edser's apparatus, but without obtaining any motion of the interference bands, and that he was therefore less confident of the correctness of his deductions than he had been before. Mr. Edser mentioned that Dr. Burton had suggested an explanation of the production of objective tones in the case of the siren, which depends on the production of the tones in the wind-chest of the instrument itself when two rows of holes are simultaneously opened. They had made an experiment which seemed to show that the above explanation was incorrect, for on connecting together the wind-chests of two sirens, fixed on the same spindle, by means of a short length of wide metal tubing, no effect was observed on the hands when the two notes were produced on different instruments having what was practically a common wind-chest.—Prof. Everett (communicated) said he considered the experiments described in the paper proved conclusively the objective existence of the summation tones as distinguished from supposed beat tones. He had lately been investigating the pitch of the lowest combination tone obtained when two notes having frequencies as 3 to 5 are sounded. Is

the frequency of this tone 2, *i.e.* the first difference tone, or is it 1, which corresponds to the first term of the Fourier series for the periodic disturbance? In the chords 2 to 3, 3 to 4, 4 to 5, &c., the difference of the integers being unity, the first difference tone is identical with the first Fourier tone. When the difference of the two integers which express the chord is not unity, then the writer considers that experiments he has made with strings and pipes, show that the first Fourier term is usually the only combination tone that is audible. Prof. S. P. Thompson considered that care should be taken to define what we mean by the subjective or objective existence of a note. There are two very delicate methods which have already been employed for detecting the existence of a given note in the air. (1) The formation of ripples on a soap-film stretched over the opening of a resonator tuned to the required pitch (Sedley Taylor); (2) the sounds produced in a telephone connected to a microphone placed on a thin elastic membrane stretched over the neck of the resonator (Lummer). It was very important to limit our acceptance of the demonstration of the objectivity of combination tones, given by the authors of the paper, to the case actually proved, *i.e.* to tones produced by the polyphonic siren. It did not necessarily follow that if pure tones produced by tuning-forks were used, the same results would be obtained. A number of experiments had been made by Zantedeschi in 1857, in which two notes were sounded, and skilled musicians were asked to record their impression of the third tone present. In 75 per cent. of the cases the note recorded was the difference tone; in the remaining 25 per cent. it corresponded to König's beat tone. König himself had never heard the summation tone in the case of lightly-bowed forks. Voigt in a theoretical paper has shown that if there are two disturbances whose mean kinetic energy differ, the Helmholtz tones will be produced; but that if the mean kinetic energy of the two disturbances are equal, the Helmholtz effects soon die out, and you get beat tones or beats. He (Prof. Thompson) considered that Dr. Burton had allowed his perception of tone to be governed by the quality of the note, and that the apparent lowering of pitch was due to the variation in the intensity of the overtones present. In reply to Prof. Thompson, Dr. Burton said he did not merely perceive a lowering of pitch, but he was able to estimate the change in pitch, and say at what instant, as the vibrations of the fork died out, the lowering amounted to a tone or half a tone, &c. Mr. Boys said he found that by careful attention he could apparently persuade himself that the note in Dr. Burton's experiment was lowered or raised in pitch, or that it remained unaltered. A similar effect in the case of the eye could be obtained with a stereoscopic picture. The Chairman considered that, while Helmholtz' explanation of the production of combination tones might be real, it did not follow that this explanation gave the sole cause of their formation. In particular, Helmholtz does not explain why the tones should only be produced by some sources of sound. Prof. Rücker, in his reply, said he did not deny the existence of König's beat tones; in fact, he had heard them. They did not lay much stress on the negative result of the experiment they had made to test the objective existence of these beat tones.

**Zoological Society, March 10.**—Sir W. H. Flower, K.C.B., F.R.S., President, in the chair.—Lt.-Col. H. H. Godwin-Austen, F.R.S., presented a paper on behalf of Mr. Walter E. Collinge, and himself, "On the Structure and Affinities of some new Species of Molluscs from Borneo." Three new species were described, *vir. Damayantia mithi*, *Microfarmaria pollonerai*, and *M. simrothi*. Details were given of their structure and comparisons instituted with other members of the genera and allied Indian genera. One of the most interesting features, perhaps, was the similarity they show anatomically to shell-bearing molluscs of Borneo. That these slug-like forms of Borneo have the same close relationship to the shell-bearing mollusca among whom they are now found living, as the Indian forms bear to *Macrochlamys* and allied shell-bearing genera, there can be little doubt, and any true attempt at classification must be based on these lines, and would place a wide gulf between *Uvula* and *Austenia* on the one side, and *Parmaria* and *Microfarmaria* on the other.—Mr. F. E. Beddard, F.R.S., read a preliminary account of new species of earthworms belonging to the Hamburg Museum. These worms belong chiefly to the genera *Acanthodrilus* and *Microscolex*, and had been collected in South America.—Prof. F. Jeffrey Bell communicated, on behalf of Prof. Alphonse Milne-

Edwards, Jardin des Plantes, Paris, the description of a new species of crab of the genus *Hyastenus*, obtained near the Straits of Magellan during the Challenger Expedition, and proposed to be described as *H. comobrinus*.—Dr. A. G. Butler gave an account of two collections of Lepidoptera received by the British Museum. One from Zomba, made by Mr. J. McClounie, remarkable for the number of specimens of the fine Butterfly genus *Charaxes* it contained. The other made at Fwambo, Lake Tanganyika, by Mr. Alexander Carson, interesting as including not only rare species previously only received from Zomba and Lake Mweru, but several novelties, the finest of which was *Junonia pavonina*, a new form allied to *J. artaxia*.—Mr. P. Chalmers Mitchell read a paper in which he gave a description of the prov. articular crypts he had found in a specimen of the African Tantalus (*Pseudotantulus ibis*) recently living in the Society's Gardens.

**Entomological Society, March 20.**—Prof. Raphael Meldola, F.R.S., President, in the chair.—Mr. H. St. John Donisthorpe exhibited a living female of *Dytiscus marginatus*, with elytra resembling those of the male insect. Dr. Sharp, F.R.S., said he had seen this form before, but that it was very rare in this country, though abundant in some other parts of the palæarctic region. Prof. Stewart asked if the genitalia had been examined. Mr. Champion stated that Mr. J. J. Walker had collected several females of an allied species (*Dytiscus circumflexus*) at Gibraltar with elytra resembling those of the male.—Dr. Sharp exhibited specimens of *Brenthos anchorago*, from Mexico, showing extreme variation in size. He remarked that the males varied from 10 $\frac{1}{2}$  mill. in length to 51 mill.; the female from 9 $\frac{1}{2}$  mill. to 27 mill. In the male the width varied from 1 $\frac{1}{2}$  mill. to 4 mill. The length therefore varied from about 5 to 1, and the width from 3 to 1 in the male.—Mr. Blandford commented on the difficulty of mounting minute Lepidoptera, Diptera, Neuroptera, &c., and exhibited samples of strips of material which he had found most suitable for the purpose of staging minute insects. He said his attention had been called to this method of mounting by the receipt of specimens from Dr. Frië, of Prague. On examination of the material he found it to be a fungus, *Polyphorus tetulinus*. He stated that Lord Walsingham had expressed his satisfaction with this material, and had sent him specimens, similarly mounted, from Zeller's collection. Mr. McLachlan, F.R.S., remarked that he thought the material exhibited preferable to artichoke pith, which had been used for a similar purpose.—Mr. Goss exhibited a species of a Mantid, *Pseudocrobotra Wahlbergi*, Stal, received from Captain Montgomery, J.P., of Mid-Down, Natal.—Mr. Frederick A. A. Skuse communicated a paper, entitled "On a colour variety of *Heteronympa meope*, Fab., from New South Wales," and sent coloured drawings of the typical form and the variety for exhibition.—Mr. Oswald H. Latter read a paper, entitled "Further notes on the secretion of potassium hydroxide by *Dicranura cinula* (imago) and similar phenomena in other Lepidoptera." The paper was illustrated by the oxy-hydrogen lantern. Prof. Meldola congratulated Mr. Latter on the thorough way in which he had worked out his experiments, and said that in view of the small quantity of material at his disposal, the concordance in the results was remarkable. He added that Mr. Latter had, for the first time, proved the secretion of free potassium hydroxide in the animal kingdom. Mr. Blandford, Mr. Merrifield, and Dr. Dixey continued the discussion.—Mr. Merrifield read a paper, entitled "The results of experiments made last season on *Vanessa C-album* and *Limenitis silybia*." This was illustrated by an exhibition of specimens of *L. silybia*, and a long series of *V. C-album*, to show the effects of temperature in producing abnormal forms. Dr. Dixey said that many of the forms of *V. C-album* exhibited reminded him of *V. C-aureum*, a Chinese species, which he believed to be one of the oldest forms of the genus. He thought that much of the variation shown in this series of specimens was due to atavism, and was not directly attributable to the effect of temperature. Mr. Barrett said he was interested to find that one of the forced forms of *L. silybia* was similar to a specimen he had seen which had emerged from the pupa during a thunder-storm. In connection with Mr. Merrifield's paper, Mr. F. W. Frohawk exhibited a series of 200 specimens of *V. C-album*, bred from one female taken in Herefordshire, in April 1894. The series consisted of 105 males and 95 females, and included 41 specimens of the light form, and 159 of the dark form. Prof. Meldola, in proposing a vote of thanks to Mr. Merrifield, Dr. Dixey, and Mr. Frohawk, said that he was glad to think

that the subject of seasonal polymorphism, which had been first investigated systematically by Weismann, was receiving so much attention in this country. He was of opinion that the results which had arrived at were quite in harmony with Weismann's theory of reversion to the glacial form, and all the evidence pointing in a similar way by the excellent observations of Mr. Merrifield and others went to confirm this view as opposed to that of the direct action of temperature as a modifying influence.

**Mathematical Society, March 14.**—Major P. A. MacMahon, F.R.S., President, in the chair.—The President announced that he had written letters of condolence to Lady (Mrs.) and Mrs. Cayley, and had received the acknowledgments of receipt of the same, which he communicated to the meeting.—Prof. Hill, F.R.S., communicated a paper, by Mr. P. H. Jackson, entitled "Certain B Functions," and the President (Mr. A. B. Kempe, F.R.S., in the chair) read a paper on the important inventions of binary quantities.—Lieut.-Col. Allan Cunningham, R.E., gave a proof that  $2^{57}-1$  is divisible by 547.—The President read a letter from the Rev. T. C. Simmons, announcing what the writer believed to be a "new theorem in Probability."

PARIS.

**Academy of Sciences, March 25.**—M. Marey in the chair.—On the theory of surfaces and of algebraical groups, by M. Émile Picard.—New researches by Prof. Ransay on argon and on Helium, communicated by M. Berthelot. A letter from Prof. Ransay was read describing the spectrum of argon obtained from chlorine and the discovery of Helium.—Remarks on the spectra of argon and of the aurora borealis, by M. Berthelot.—During the author's recent experiments on the condensation of argon with benzene vapour under the influence of the silent discharge, a magnificent greenish-yellow fluorescence was observed. Its spectrum consisted of a series of lines and remarkable bands. So far as the experimental conditions allowed of comparison, this spectrum recalled that of the aurora borealis. It is suggested that this phenomenon may possibly be due to the formation of some fluorescent combination of argon in the upper regions of the atmosphere under electrical influence.—Researches on the metals of Cerite, by M. P. Schlenkerger. The preparation of cerium sulphate in a state of such purity as to admit of accurate determinations of the atomic weight of cerium is described. The value 139.45 is obtained for this constant by a special process of estimating the sulphuric acid in this sulphate. It is shown that other methods of obtaining the atomic weight give unreliable results. Taking various fractions of the sulphate on recrystallisation, the later fractions give a much less value for the atomic weight of cerium than the earlier ones.—Observations of Charlois' planet BC, made at Toulouse observatory, by MM. E. Baillaud and Rossard.—Observations of Wolf's planet BT (March 16, 1895), made at Besancon observatory, by M. H. Peitit.—A general property of axoids, by M. A. Mannheim.—On lines of curvature, by M. Thomas Craig.—On the theory of equations to the derived partials, by M. Whitlair de Tannenber.—On linear variation to the derived partials, by M. Émile Borel.—On the movement of projectiles in the air, by M. Chapel.—A series of four equations are given which supply a complete solution to the ballistic problem for speeds ranging between 300 m. and 1100 m.—On the extension to magnesia of a method of synthesising chlorides and nitrates, by M. A. Duboin. The compounds  $MgCl_2 \cdot 4H_2O$ ,  $MgF_2 \cdot 2KF$ , and  $MgO \cdot K_2O \cdot 3SiO_2$  are described and their general chemical properties given.—On a new method for the preparation of chloroplatinous acid and its salts, by M. Leon Pigeon. Reduction of chloroplatinic acid in accordance with the equation,



is employed. Following the method given in detail, the yield is almost theoretical.—Heat of formation of calcium ice yale, by M. de La Grand. The heat of formation of solid  $C_2Ca$  from amorphous and solid  $Ca$  is  $-7.25$  Cal., subtracting an amount of  $-0.65$  Cal., for passage of carbon it is  $-7.905$  Cal. Action of ortho-amidobenzene acid on benzoin pinone, by MM. A. G. and Ch. A. D.—Alterations in saccharine matters during the germination of barley, by M. P. Petit. The conclusions are drawn: (1) There is a relation between the quantity of roasting, fungus and of saccharose existing in barley and the germination. (2) The formation of glucose comes immediately following the dawning, whereas in the sugars remain in the same amount during the same period. (3) The variation

of reducing power represents the activity of respiration.—Chemical process for the purification of water, by MM. F. Bordes and Ch. Girard. Calcium permanganate is employed to oxidise the organic matters, and the excess of this salt is removed by treatment with lower oxides of manganese. The treatment recommended removes organic matter also by physically precipitating it from the water, which, after treatment, contains no micro-organisms, and very little calcium carbonate.—On the wheat produced on a saliferous soil in Algeria, by MM. Berthault and Crochetelle.—On the abnormal fronds of ferns, by M. Ernest Olivier.—Origin and division of granular nuclei in large sarcomatous cells, by MM. O. Van der Stricht and P. Walton.—A note, by M. Delaurier, concerning an easy method of obtaining a perfect vacuum without mechanism, deals with the production of a vacuum by absorption, as with oxygen and iron at a red heat.

BOOKS, PAMPHLETS, and SERIALS RECEIVED.

**BOOKS.**—Birds, Beasts, and Fishes of the Norfolk Broadland; P. H. Emerson (Nutt).—Balistique des Nouvelles Poudres; E. Vallier (Paris, Gauthier-Villars).—La Théorie des Procédés Photographiques; A. de la Plante (Paris, Gauthier-Villars).—La Distillation; E. Sorel (Paris, Gauthier-Villars).—Dissections Illustrated; C. G. Brädie, Part 4 (Whittaker).—Methoisisches Lehrbuch der Elementar Mathematik; Dr. G. Holzmüller, Dritter Teil (Leipzig, Teubner).—A Primer of Evolution; E. Clodd (Longmans).—Geometrical Conics; F. S. Macaulay (Cambridge University Press).—Standard Dictionary, Vol. 2 (Funk and Wagnalls).—Outlines of Zoology; J. A. Thomson, 2nd edition (Pentland).—The Book of the Dead; The Papyrus of Ani in the British Museum; Dr. E. A. W. Budge (Irish Museum).

**PAMPHLETS.** Report of the Meteorological Council to the Royal Society for the Year ending March 31, 1894 (Eyre and Spottiswoode).—Stonyhurst College Observatory. Results of Meteorological and Magnetic Observations, 1874. Rev. W. Sidgreaves (Clitheroe).—12th Report of the State Entomologist on the Noxious and Beneficial Insects of the State of Illinois (Springfield, Ill.).

**SERIALS.**—Cassell's Magazine, April (Cassell).—Chambers's Journal, April (Chambers).—Century Magazine, April (Unwin).—Natural Science, April (Kail).—Zeitschrift für Wissenschaftliche Zoologie, lx. Band, 1 Heft (Leipzig, Engelmann).—Gazzetta Chimica Italiana, 1895, Fasc. 2 (Roma).—Humanitarian, April (Hutchinson).—Contemporary Review, April (Isbister).—National Review, April (Arnold).—Fortnightly Review, April (Chapman).—Bulletin de l'Académie Royale des Sciences, &c., de Belgique, tome 20, No. 2 (Bruxelles).—Geographical Journal, April (Stanford).—Journal of the Royal Agricultural Society of England (third series), Vol. vi. Part 1 (Murray).

CONTENTS.

	PAGE
Verworn on General Physiology. By Dr. M. Foster, F.R.S.	529
Nernst's Theoretical Chemistry. By M. M. Pattinson Muir	530
Our Book Shelf:—	
Hayward: "Bird Notes"	532
Gunney: "Catalogue of the Birds of Frey ( <i>Acridites</i> and <i>Strigids</i> )"	532
Beazley: "Prince Henry the Navigator."—W.	532
Ziwet: "An Elementary Treatise on Theoretical Mechanics."—G.	533
Letters to the Editor:—	
Destruction of the Seismological Observatory at Tokio, Japan.—Prof. John W. Judd, F.R.S.	533
On Mercator's Numbers.—Lieut.-Colonel Allan Cunningham, R.E.	533
Tan-Spots over Dogs' Eyes.—S. E. Peal; Dr. Alfred R. Wallace, F.R.S.	533
The Age of the Earth. By Prof. W. J. Sollas, F.R.S.	533
The Anniversary of the Chemical Society	534
Sir Henry Creswicke Rawlinson, Bart.	536
Notes	537
Our Astronomical Column:—	
Comet of 1894 (Swift)	542
A Possible New Satellite of Neptune	542
Prof. Mendeléeff on Argon	543
Terrestrial Helium(?)	543
Isolation of Free Hydrazine, $N_2H_4$ . By A. E. Tutton	544
Science in the Magazines	545
Precious Stones, and How to Distinguish them. By H. A. Miess	545
The Observation of Earth-waves and Vibrations. By Prof. John Milne, F.R.S.	546
Societic and Academies	550
Books, Pamphlets, and Serials Received	552

THURSDAY, APRIL 11, 1895.

PHYSIOLOGY OF THE EXCITABLE  
TISSUES.*Electrophysiologie.* Von W. Biedermann, Professor der Physiologie in Jena. (Jena: Fischer, 1895.)

PROF. BIEDERMANN, who was not many years ago promoted to the chair of Physiology at Jena, is well known as having co-operated with Prof. Hering in a very extended series of researches on the "general physiology of muscle and nerve," of which the results have been communicated to the Vienna Academy from time to time during the last twenty years. The present work will be welcomed by physiologists in the hope that it will not only place at their disposal the rich harvest of the author's persevering labours in this field of inquiry, but that it will afford to him the opportunity of dealing more completely than has hitherto been possible with one of the most fundamental characteristics of the animal organism—its power of responding in a specific way to stimulation. This being, as we learn from the introduction, the purpose of the book, the title "Electrophysiologie" may seem scarcely suitable, for however intimate and essential may be the relation between vital processes and the electrical phenomena which accompany them, these, after all, are only concomitants, and must be thought of apart from the process itself. However this may be, the author makes it quite clear that his scope is not electrical, but purely physiological. Referring to the "Muskel-physik" and the "Nerven-physiologie" of Prof. Hermann, published in 1880, he declares it to be his purpose to bring the subjects therein treated up to date, and in doing so to follow the true physiological method.

"In morphology it is obvious that we must proceed from the simple to the more complicated, but in physiology . . . the opposite is in a certain sense the case. Under the apparent simplicity of an amœba manifold physiological functions are latent." "The most various duties are performed by the same protoplasm, whereas in the higher animals each particular cell is devoted to a specific function, and consequently affords a better subject of study than the protozoon, when the nature of that function is to be determined." It is for this reason that "our knowledge of contraction and of the processes which are associated with it have been advanced infinitely more by muscle physiology than it ever could have been by the microscopical examination of the lower organisms." (p. 1.)

The volume before us is the first part of a work which is to include the whole of the physiology of the "excitable tissues." Its 440 pages relate directly to muscle, but also comprise the electromotive properties of epithelial and gland cells. In accordance with the general principle that the study of structure must precede that of function, the book opens with a very useful chapter of anatomical prolegomena, in which, beginning with a section on the contractile fibres of the stem of vorticella, the author proceeds to the epithelial nerve-muscle cells of the cœlenterates, and so on to those of the worms. Then come in order the muscular elements of Mollusca (Lamelli-

branches and Gasteropods), of interest as showing the striking relation of structure to physiological endowment. Next we have before us the simplest forms of muscle-cells in vertebrates, and finally the structure of striped muscle, with reference to which we again find that the relations between anatomical characteristics and functions receive more attention than the endless questions of histological detail which, in the minds of most students, are associated with this subject.

Of the 340 pages given to the physiology of muscle, scarcely a third relate to its electrical properties. These comprise four sections. The first and second deal with the electromotive phenomena of muscle at rest and in action: the third relates to the so-called "positive variation": the fourth to secondary electromotive actions. Throughout it is felt that Biedermann writes as a physiologist, not as a physicist, availing himself of the best physical methods to investigate phenomena, but regarding them not as the thing itself, but merely as indications, by the aid of which the time and place relations of vital processes become known to us. In this tendency to take things as they are, postponing theoretical speculations, until the results of the more exact methods of observation which we are now only beginning to know how to use, have been systematised, Biedermann is happily at one with all the leaders of thought and work in this field of inquiry.

Among the most interesting of the observations by which Prof. Biedermann has contributed to the advance of what may, in the truest sense, be called *elementary* physiology, are those by which, in co-operation with his master, and, it may be added, in language not unfamiliar to English students, he has sought to work out that notion of *ana* and *cata*, or of A and D, as Hering puts it, in accordance with which the influences exercised by one part of the organism on another through the nervous system, are regarded as manifestations of two antagonistic tendencies, the one quelling, the other exciting in its nature. This principle, which Prof. Hering first invoked to explain certain antagonisms relating to the perception of colour, has served Biedermann as a guide in the study of similar antagonisms in the behaviour of muscles, and he has furnished us with several instances showing that in the responses of muscles to the stimulation of their nerves, we may have to do not with spur only, but with a mixture of spur and bridle, a co-operation of quelling and exciting influences conveyed to the responding muscle by the same channel—its motor nerve.

In Biedermann's very interesting third section, the reader will find this subject fully discussed. The gist of what he has observed is as follows:—The change of form by which a muscle responds to stimulation of its nerve is not always, as is ordinarily the case, of the nature of shortening or contraction. Under certain well-ascertained conditions the "normal" effect is reversed: the muscle relaxes. By comparison of the instances in which this happens, we learn that the anomaly (if we are to call it so) depends on the terminal organ, not on the nature of the stimulus, or on the channel by which it is conducted. For it is found that muscles which normally exhibit no tendency to respond by relaxation, acquire that tendency when they have undergone "modification," either by the persistent action of

certain external causes or under exceptional physiological conditions; and, moreover, that in certain invertebrates the constant contraction of the muscles corresponds rather to the modified than to the ordinary state of the muscles of the higher animals. If we proceeded to inquire in what this modification consists, Biedermann's answer would be that it may be distinguished in all cases by its electrical concomitants—all "modified" parts being relatively negative to similar parts which are unmodified. Thus when the adductor muscle of the nipper of the crayfish, which is normally in a state which resembles the "modified" state of an ordinary muscle, passes into a condition corresponding to that which is normally present in the muscles of the frog, a change takes place in the electrical relations of the structure of such a character that the sign of the electrical response to stimulation is reversed; it becomes negative instead of positive. Comparing these facts with others relating to vision, with the processes of secretion, and with other processes under the immediate control of the nervous system, one is encouraged in the hope that the relations between *ana* and *cata*, between rest and activity, between restoration and exhaustion, between integrity and hurt, will eventually be linked together by their electrical concomitants, and that by these characters it may be possible to ascertain with exactitude and certainty in how far these various antagonisms may be referred to a common principle.

Space will not allow us to give an account of the last chapter in Prof. Biedermann's book, which contains much that is new and important relating to the electro-motive phenomena of secreting cells. Enough has been said to satisfy the physiological reader that the book is one which will have permanent value. It is, moreover, readable. The author tells us in his preface that he has done his best to get rid of "lehrbuchmassige Trockenheit." We think that he has fairly succeeded.

J. BURDON SANDERSON.

#### THE PHYSIOLOGY OF PLANTS.

*A Popular Treatise on the Physiology of Plants, for the use of Gardeners, or for Students of Horticulture and of Agriculture.* By Dr. Paul Sorauer, Director of the Experimental Station at the Royal Pomological Institute in Proskau, Silesia. Translated by F. E. Weiss, B.Sc., F.L.S., Professor of Botany at the Owens College, Manchester. London: Longmans, 1895.)

IF all the sections into which the teacher of botany must divide his subject, perhaps the most difficult for him to deal with is that of vegetable physiology. No adequate elementary text-book has hitherto existed in English, the classical works of Sachs and Vines being, by their very completeness, too bulky and too full of detail for the student who is beginning the study of the subject. The work of Dr. Sorauer is intended to supply this deficiency. It is written especially for those whose interest in the matter is a practical one, and it deals, consequently, mainly with those questions which are of interest to the horticulturist, as bearing on the problems of cultivation. Approaching the matter, however, from this side only, the book, as a work on physiology,

to a certain extent comes short of what is needed, as many important sections of the subject are left untouched.

The author deals almost entirely with the problems of nutrition and their bearings on the details of horticultural practice. At the outset he strikes a rather heavy blow at what has hitherto been, unfortunately, the prominent idea of most agriculturists and horticulturists as to what constitutes the scientific side of agriculture. The latter has been held to embrace little or nothing beyond the chemistry of the soil, and everything not directly connected with this has been pushed into a secondary position, the metabolism of the plant and the chemical changes of its constituents being generally very superficially treated and held of not very great interest. It certainly seems strange that those who have been engaged especially in the cultivation of sensitive organisms under very varied and rapidly changing conditions should have given so little attention to the physiological peculiarities which these organisms present, and to their power of availing themselves of the various advantages that their environment offers to them. Dr. Sorauer, at the outset, strikes the right line when he points out that the chemistry of the soil, important as it is, plays only a secondary part in the development of the various plants which that soil supports, and directs his readers' thoughts chiefly to the problems of nutrition which the plant itself offers for consideration, showing that it is the business of the cultivator to endeavour to guide the natural development of the plant towards the special ends which are the needs of horticulture.

This idea, put prominently forward in the opening chapters, runs throughout the whole of the book. In developing it, the interactions between the soil and the plant, or between the plant and the atmosphere, are kept in the foreground, so that the gardener may realise that he is face to face with an actual struggle that is going on continuously between the organism and its environment, and that he is working to secure that in this contest those conditions of the latter may be secured which are most favourable to the success of the organism, and hence to its most complete development.

In the earlier chapters of the book, the author treats successively of the several members of the plant, the root, stem, leaf, flower, and fruit. Without going very deeply into their anatomical structure, he explains it sufficiently for the student to get an adequate comprehension of the duties or functions which are especially discharged by each. Again his mode of procedure is sound, as it is only function that gives the clue to the right interpretation of structure. The method, as carried out by Dr. Sorauer, is, however, open to a little objection, as it has led him rather to push too far the idea of the several members of the plant living for themselves, and to relegate a little to the background that of the plant being an organic whole, differentiated in different directions for the carrying out of different functions. Thus the leaf is spoken of as passing off into the vascular bundles of the axis only such materials as it cannot at once employ for its own growth, leading the student probably to the conception that the latter problem is for the leaf the primary one, and that the nutrition of the



whole organism is only subsidiary when the relation of leaves to the rest of the plant is considered.

The chapters on the general processes of horticulture; the correlation of stems and roots, and their separate treatment; the principles of manuring; the theories of the proper supply of water to the plant, the aëration of its roots, &c., will be read with much attention, and will be found very useful in actual practice. The deposition of nutritive material in various parts of the plant, and the ways in which this can be influenced by different modes of treatment of the shoot at different ages, deserve careful study. The relation of such questions to the operations of pruning, grafting, &c., is discussed at some length, and the development of vegetative or fruiting branches respectively, is shown to be capable of great modification in the hands of the skilled horticulturist.

The book, however, though a valuable one for practical gardeners, leaves something to be desired as a contribution to the literature of vegetable physiology. Indeed some of the fundamental facts of the metabolism of the cell are, if not inaccurately, at any rate not clearly stated. The absorption of water is certainly one of the most important processes which it carries out. As described on p. 127, the early changes in the young cell connected with this process are stated as follows:—

“Very soon there arise within the protoplasmic mass which fills up the cells, very small quantities of liquid substance (cell sap) which collect together to form small vesicles (vacuoles), and these give to the protoplasm a foam-like structure. Now, as the protoplasm becomes used up during the elongation of the cells, the vacuoles increase in number, run together, and force the remainder of the protoplasm outwards towards the cell wall.”

Put in this way, the student would get the idea that the elongation of the cells takes place apart from the entry of water, and that the formation of the vacuole, that is, the increase of the cell-sap, is rather the result than the cause of the extension of the cell. No statement is made as to the cause of the entry of the water, the osmotic activity of the cell-contents, which really underlies all cell-growth.

Another strange statement is that the main cause of the growth in length of a young stem is the longitudinal tension in the pith, which “drags the young ring of wood with it, as long as the latter is still soft and thin-walled.” This will be a new view to most physiologists.

Dealing with the absorption of nitrogen by certain leguminous plants, and the recently established fact that the atmosphere is a source of supply of this constituent, the author commits himself to the view that this absorption is carried out by means of their leaves.

In section 23, which treats of the substances formed by the leaves, we find several statements to which exception must be taken. The classification of the vegetable proteids is inaccurate, the latter being said to consist of albumins, caseins, and fibrins. Albumins are extremely rare in plants, and fibrin resembling animal fibrin is unknown. Globulins, which are numerous and varied, and albumoses, which have comparatively recently been investigated, are not even mentioned. The formation of starch grains in the leaves is thus described

“When the light shines on the leaf its transpiration is exactly increased, and its cells lose some of their water;

then we may imagine the starchy substance to be forced out of the thickened (concentrated) cell-sap, and the latter will become more liquid.”

The nutrition of the cell is summed up in the remarkable sentence:

“The nutrition consists in this, that the raw materials which enter the cell are attracted, now by one, now by another of the constituents of the cell, and adopt its specific movements, and are thus transformed with the same substance (assimilated).”

These drawbacks to an otherwise valuable work make one regret that Prof. Weiss has confined himself to translating Dr. Sorauer's text. Had he rather edited than translated it, no doubt we should have found the English edition free from these defects.

#### MINES AND MINERALS.

*Traité des Gîtes Minéraux et Métallifères. Cours de Géologie appliquée de l'École Supérieure des Mines.*

By E. Fuchs and L. de Launay. (Paris: Baudry, 1893.)

*Étude industrielle des Gîtes Métallifères.* By George Moreau. (Paris: Baudry, 1894.)

IN these days, when memoirs and papers follow in rapid succession, the geologist and the miner are justly grateful to any careful compiler who will aid them to keep pace with the ever-widening flood of technical literature. The debt of gratitude is increased when the task is undertaken by a writer like Prof. de Launay, who brings together into one colossal work the results of the labours of his master, the late Prof. Fuchs, and of his own personal researches.

The book is a treatise upon applied geology, which Fuchs defined as the application of geological knowledge to seeking and working mineral deposits. Very rightly Fuchs took a wider basis for his course of lectures at the Paris School of Mines than mere ore deposits. He recognised the fact that the mining engineer of to-day must be a man of wide attainments, capable of giving an opinion upon all sorts of mineral workings, reporting upon gold mines in one journey, upon gem-diggings in the next, and a little later being asked to determine the value of deposits of phosphate of lime or other earthy minerals. For work of this description Prof. Fuchs' lectures formed an admirable kind of training, which has too often been neglected in the past; in fact, until this treatise appeared, many geologists may have failed to realise the vast importance of the subject.

While admitting that various systems of classification may be adopted, Prof. de Launay says that he felt bound to arrange his minerals according to the metalloid or the metal, and he chooses the so-called chemical order. In a huge book of this description, alphabetical order would have been more convenient, and would have prevented some of the anomalies which cannot help striking the reader. The chloride, carbonate, and sulphate of sodium appear under the head of that metal, whilst the borate and nitrate are classed respectively under boron and nitrogen; again, chalk and gypsum are brought under calcium, whilst apatite is placed under phosphorus, no doubt for the reason that the non-metallic element is the

one to which the mineral more especially owes its commercial importance. Waite slate is sandwiched in between the gems, under the heading "Silica and Silicates," clay is relegated to "Aluminium."

In a general treatise upon mineral deposits, exception may fairly be taken to the absence of any mention of coal; the author excuses himself on the ground that fuel forms a special subject too vast to be included within the compass of his book. The overwhelming importance of coal seems, on the other hand, an additional reason for finding it a place in a work which is practically an encyclopædia of applied geology; besides, if fuel is to be omitted, why are natural gas and petroleum inserted?

In a gigantic work of this description, it is impossible for an author to avoid some errors. Five mistakes in spelling Welsh words in the first three lines of p. lxxviii. will not be looked upon as a heinous crime by the average Englishman, who himself feels that he is skating upon thin ice when he is dealing with the orthography of names of places in the Principality; however, these are not the only cases of misprints which might be noticed.

The geographical tables, occupying forty-five pages, form a useful feature in the book; an alphabetical list is given of the principal minerals worked in each country, together with references to the pages where they are described. These tables and the index of localities take the place of a general index, which is not supplied. Small maps inserted in the text are of much assistance in enabling the reader to follow the author's descriptions; the total number of woodcuts, 390, may seem large, but, scattered as they are through more than 1800 pages, they are not as numerous as one would like. Great pains have been taken with the bibliography, and Prof. de Launay's lists will often bring into notice original papers which would otherwise have passed unnoticed.

Though too expensive for the pockets of ordinary students, the book will find a place in the libraries of all mining schools and geological and engineering societies, and it is sure to be frequently consulted with profit by geologists and mining engineers.

Moreau's work has a totally different object to that of de Launay; the latter is a record of observed facts, whilst the former, dealing solely with metallic ores, is mainly devoted to general principles. After describing briefly the classifications of ore deposits proposed by von Groddeck, de Lapparent, Phillips, Whitney and Raymond, the author suggests one of his own, viz:

- A. Stratified deposits.
- B. Eruptive deposits.
- C. Deposits in pre-existing cavities.
- (D) Substitution deposits.

Mineral veins are classed under the head (C), and apparently Moreau does not admit that they may sometimes be substitution deposits.

Two chapters are devoted to dispositions upon the origin of mineral veins, and are based upon the works of De la Roche, Lyell, Eug. de Beaumont, De la Beche, Haaswood, Mousenet, Geikie, and others; Vogt's recent researches, and the mines remain unnoticed.

Chapter v., which treats of the chemical and physical characteristics of ores, and the earthy minerals which accompany them, should have been omitted; and the same remark applies to the chapters upon qualitative testing, quantitative assaying, dressing and smelting. These subjects cannot be taught in a few pages, and are better studied in the ordinary text-books.

Chapter vi., largely borrowed from von Groddeck, Phillips, Fuchs and de Launay, contains descriptions of well-known characteristic ore deposits. The important iron ores of the Secondary rocks are dismissed in a very cavalier fashion, for, strange to say, no mention is made of the great iron-field of the Department of Meurthe and Moselle, Lorraine and Luxemburg.

The most valuable part of the book for mining men will be found in two of the concluding chapters, which deal with the study of ore deposits from a purely commercial point of view. They are full of useful hints and warnings, not only to the engineer who is examining mining properties offered for sale, but also to the capitalist who is meditating their purchase. M. Moreau is evidently imbued with many of the ideas which were running through the brain of Mr. J. H. Collins when he delivered his recent presidential address to the Institute of Mining and Metallurgy. The more deeply counsel of this kind is taken to heart, the better will it be for investors in mining enterprises.

A few errors in the names of well-known geologists are inexcusable. It is strange that any one should write "Sir Richard Lyell"; "Sir Logan Foster, Whitney," is evidently meant for "Sir William Logan, Foster and Whitney"; even Elie de Beaumont's name is not always spelled correctly. "Gossan" is a Cornish and not a Welsh term, as supposed by the author.

#### OUR BOOK SHELF.

*Elementary Text-book of Metallurgy.* By A. Humboldt (Sexton, F.I.C., &c. London: Griffin and Co., 1895.)

THIS book is intended, for those who are commencing the study of metallurgy, as a kind of preparatory course to that of Prof. Roberts-Austen, as given in his "Introduction to the Study of Metallurgy," which the student is advised to read after digesting the contents of Prof. Sexton's manual. The work is got up in good style by the publishers, and printed in a clear and distinct manner. With the general arrangement there is very little to complain of; but the same by no means can be said of the subject-matter, which contains many errors, and the definitions are often expressed in such crude language that a student might be easily misled in taking his first lessons in metallurgy from its pages. The following examples may be cited:—P. 3: Malleability. This is the property of being expanded into sheets. Ductility: This is the property of being drawn into wire. A small quantity of antimony in lead is said to make it quite brittle. P. 4: Lead may be drawn into wire if means be taken to prevent the metal being subject to stress. P. 5: With regard to tensile testing, the author says that elongation takes place mostly near the point of fracture. P. 40: There are but two neutral substances in general use, graphite and chrome iron ore. P. 89: Fluor spar is said to be used to increase the quantity of slag. On pp. 92 and 121: C below 75 is termed wrought iron, and steel when C is between 75 and 175; while on

p. 110, it is stated that, in puddling, the carbon is reduced to 1 per cent.; and also that during the melting-down stage there is little chemical action. P. 111: Puddled bloom is chemically wrought iron with intermingled slag. P. 123: Steel is made by *carbonising* malleable iron. P. 128: Mild steel, not more than 5 per cent. carbon, does not harden when heated and quenched in water. P. 134: The slags from the acid Bessemer process are *very basic silicates* of iron and manganese. P. 138: In Open Hearth process it is stated that the iron ore should be as free as possible from silica, whereas the Spanish hematite usually employed is very siliceous. P. 143: The strength increases as the diameter of the wire decreases. Also cake or tough copper may contain any amount of impurities. P. 223: An alloy of 80 per cent. copper and 20 per cent. zinc is called *red brass*. P. 229: Electro refining of copper; the anode is a thin sheet of copper; the cathode is a bar of blister copper. P. 230: The passage of the electric arc through the carbons produces a very high temperature. It is a great pity that a work which has been so judiciously compiled as the present one should be marred by so many mistakes, when by a more careful supervision of the proof sheets they might have been easily detected and corrected.

*Annals of British Geology, 1893.* A Digest of the Books and Papers published during the Year. By J. F. Blake, M.A., F.G.S. (London: Dulau and Co., 1895.)

ONCE more has Prof. Blake overcome all the obstacles of prolonged research among publications that are many of them difficult of access. Once more has he braved the disappointment of inadequate support, and following his own independent course in the selection and arrangement of his material, he has now given us the fourth volume of his "Annals of British Geology." Every addition to the series renders the whole of greater value, and we sincerely hope that the present volume will be self supporting, as he ventures to anticipate. To all geologists, and to the provincial worker especially, these "Annals" must be of the greatest service, for the author contrives to give so much of the substance of each paper, that the reader will gain a very fair notion of the additions made to our knowledge during each year. Except in the student's special department of work, there will be no occasion to consult the originals.

Altogether 730 papers and books are noticed, being an increase of 180 over those recorded in the previous volume. The author's introductory review, occupying twenty-four pages, gives a summary of the chief geological news of the year. Although not essential to the Annals, this review acts as a safety-valve for the escape of some few of the critical remarks which arose while the author was perusing the 730 works. New forms of Ammonites and Corals come in for critical observations, so also do the "hemera" of the Inferior Oolite, and various glacial theories.

In Paleontology the place of honour is rightly given to the Elgin Reptiles described by Mr. E. T. Newton, and an excellent illustration of *Elginia mirabilis* forms the frontispiece of the book.

*The Origins of Invention.* By Otis T. Mason, A.M. Ph.D. Pp. 419. (London: Walter Scott, Limited, 1895.)

To trace our modern industries to their origins, to show how they have evolved, and to point out the changes from naturalism to artificialism that mark the course of civilisation, is a difficult task, but an attractive one; and few ethnologists are better equipped with facts relating to this development than the Curator of the Department of Ethnology in the United States National Museum, who is the author of this book.

Dr. Mason lays down the following as the order in which kinetic energy has been commanded: (1) man-power in every pursuit; (2) fire as an agent in cooking, pottery, metallurgy, &c.; (3) the power of a spring, as in a bow or trap; (4) beast-power, for burden and traction; (5) wind-power, on sails and mills, and in draught; (6) water-power, as a conveyance and a motor, and gravity or weight generally; (7) steam-power, utilisation of an expanding gas; (8) chemical power, in the arts of the civilised; (9) electric power, motors, message-bearers, in mechanics and illumination; (10) light as a mechanical servant, only beginning to be domesticated.

Prominent among inventions are tools and mechanical devices—objects employed as means to ends. Many of these have come down from remote antiquity. Following M. Adrien de Mortillet's classification, Dr. Mason describes the tools and appliances used by primitive peoples for cutting; abrasion and smoothing; fracturing, crushing, pounding; perforating, grasping, and jointing. At the basis of tool-using, lie the systems of counting and weighing and measuring, all of which receive attention.

The invention and uses of fire, forms the subject of a very interesting chapter. Other matters treated in separate sections are stone-working, pottery, primitive uses of plants, the textile industry, inventions belonging to the chase, methods used for the capture and domestication of animals, means of travel and transportation, and instruments of warfare.

The work is readable throughout; it is a valuable history of the development of the inventive faculty, and has, therefore, an important relation to the history of humanity. The ethnologist will find in the volume much that is interesting in regard to the relationship between man's activities in different regions.

*Short Studies in Nature Knowledge.* By William Gee. Pp. 313. (London: Macmillan and Co., 1895.)

FOR boys in the upper standards of our elementary schools, this forms an ideal reading-book. It is simply worded, is not too full of details, contains numerous illustrations, and is likely to create and foster a love of natural knowledge. The book is intended to be used as an introduction to physiography, and it covers the ground usually understood to belong to that science. Copious extracts from the poetical and prose writings of standard authors are introduced into the text wherever possible, and serve to lighten it. The author appears to have spent a deal of care upon the work, and we think he has succeeded in producing a volume which will be welcome to teachers, as well as readable to all who find pleasure in the study of inanimate nature.

*Organic Chemistry. The Fatty Compounds.* By R. Lloyd Whiteley, F.I.C., F.C.S. Pp. 291. (London: Longmans, Green, and Co., 1895.)

THIS is another elementary science manual "written specially to meet the requirements of the elementary stage of science subjects as laid down in the syllabus of the Directory of the Science and Art Department." It is hardly a book that we could recommend to followers of departmental organic chemistry, and certainly not one to be adopted by other students of the science. It is most unequal in structure, and very deficient in parts: Chapter iv., on percentage composition and empirical formulae, consists of less than one and a half pages. As well-known standard works have been "freely employed" in the preparation of the volume, it is difficult to recognise the sections for which the author is responsible, and therefore undesirable to impeach the accuracy of some of the information.

## LETTERS TO THE EDITOR.

## The Age of the Earth.

I am surprised to observe, in the article which Prof. Sillias has written on this subject in your issue of the 4th inst., p. 533, that he writes with approval of Dr. A. R. Wallace's method of calculating the earth's age. About two years ago (I have only the *Illustrated London Review* at hand) I wrote to you on this subject, and was under the impression that I had proved the complete fallacy of Dr. Wallace's method of calculation.

In support of Dr. Wallace's view briefly, he assumes that deposition over a limited area of, if I remember rightly, 3,000,000 square miles goes on 11 times as fast as denudation over the whole land area, which is 19 times as great, and then argues that the whole maximum thickness of the stratified rocks (and hence the time taken) could be deposited in 1/10 of the time required to carry away from an equal area of land an equal bulk of material.

The fallacy consists in assuming that a great rapidity of deposit over a limited area can in some way allow of the deposit or formation of sedimentary rocks at a greater rate than that of denudation.

It is obvious that, in a given time, no greater volume of deposits can be formed than the volume of material denuded in the same time. If, therefore, as Prof. Sillias assumes, 1/2400 of a foot of sediment per annum is denuded from the land area, by no arrangement can a land area of equal extent, consisting of sedimentary rocks of the same composition and thickness as those which actually constitute the land area, have been formed as a whole more rapidly than 1 foot thickness over 57,000,000 square miles area in 240 years. Taking the estimate of Prof. Sillias, viz. 164,000 feet, as the maximum thickness of the sedimentary rocks, and taking the existing land area to be accounted for as 57,000,000 square miles, the time required to form an area of 57,000,000 square miles of rock 164,000 feet thick, at 1/2400 of a foot per annum, is 393,000,000 years, unless the area undergoing denudation was greater or less than it is at present (and it could not be four times as great as at present). No concentration of the deposit over a small area would shorten the time required by a single moment. BERNARD HOBSON.

If, in the compass of a short article, I did not allude to the controversy which followed the attack made by Dr. Hobson *NATURE*, vol. xlvii, p. 175, 226, on Dr. Wallace's method of estimating the age of the stratified series, it was because I thought, as I do still, that the honours of that controversy rested entirely on the side of Dr. Wallace.

There is no fallacy in Dr. Wallace's argument, but a strange misconception on the part of Dr. Hobson, which arises from his consistent disregard of the word *maximum* as prefixed to the estimated total thickness of stratified rocks. It is obvious that stratified systems cannot have a *maximum* thickness everywhere over the whole 57 million square miles of the land surface. As a matter of observation, a system attains its maximum thickness over a very limited area, and over a large part of the 57 millions of square miles of land surface it has no thickness at all, or, in other words, is entirely absent. If "*maximum*" could be made to mean the same as "average," no doubt Dr. Hobson's contention would hold, but those who have made use of a *maximum* in estimating the age of the stratified series have observed a strict distinction in the application of the two terms.

Bathgar, April 9.

W. J. SILLIAS.

## Polyembryony.

In connection with the note in the last number of *NATURE* on the identity of *Arceuthobium* some two years ago in the red beet *Arceuthobium* by the late Mr. Rouines and myself. We found that a single seed might produce as many as four distinct plants, and as far as our observations went, polyembryony was quite a normal condition. It seems to be more characteristic of the Gymnosperms than the Angiosperms, and has of course been suggested in the former, and in the latter among the Monocotyledons (Eriopogon) and Dicotyledons (e.g. *Citrus* Strasburger). The fact of its occurring in such a common type as *Arceuthobium*, I think, has been taken advantage of by some writers, as the results could not be both interesting and important. The obvious discovery that the supernumerary embryos in Monocotyledons may be produced by the antipodal cells certainly suggests, by comparison with such embryos as those produced by [parthenogenetic?] apogamy in the production of the lower plants.

FRANK J. COLE.

## IMPROVEMENTS IN PHOTOMETRY.

NEARLY sixty years have passed since it first occurred to the philosophic mind of Sir John Herschel to attempt an arrangement of the relative brilliancy of the stars, upon a method that should be more secure than the eye estimations that had done duty for many centuries. It is not necessary to enter into any description of his method, which may be regarded now as entirely superseded. Doubtless, had he been surrounded by skilled workmen, furnished with better tools, the cumbrous method employed would have been simplified, but the establishment of an observatory remote from the assistance and contrivances of the workshop is not without drawbacks, as he and others since have discovered and regretted. About the same time, Seidel, in Germany, was at work on the same problem, and the fact that two astronomers, independently of each other, undertook the solution of the same problem, is a proof that it was ripe for mature consideration, while the series of astronomers who have laboured in the same path confirms the suspicion that this kind of investigation too long neglected offered a field having a rich prospect of reward.

But a photometer at once convenient and capable of general application to the stars remained to be invented, and this want was effectually supplied by Zollner, who proposed a form of construction which has certainly obtained the most general use of any of the suggestions that have been from time to time put forward by astronomers, who have recognised its deficiencies and tried to remedy them. The distinguishing characteristics of the Zollner photometer are the introduction of an artificial star formed from a lamp shining through a small aperture, and the controlling of the light of that star by means of polarisation. This principle is now of such general use that no lengthened description is necessary. But to explain the reason for the introduction of other forms of photometer, it is necessary to point out what are, or what were, considered to be its defects by those who first used the instrument, defects which it is believed care and experience have since done much to diminish, if not entirely to remove. A source of error might be anticipated in the varying brilliancy of the lamp employed to form the artificial star, and in the early days of the instrument this was a fruitful source of annoyance. Next, the light of the lamp had to strike no less than twenty-eight surfaces, and apart from the difficulty of getting so many surfaces true, and ensuring the parallelism of the Nicol prisms by which the diminution of the artificial star is effected, there is also to be considered the inevitable loss of light at so many surfaces. One consequence of this is that the brightest stars of the heavens are apt to be brighter than the artificial star, and since the observation is made by reducing this light to match that of the real star, it is necessary to have recourse to some such expedient as reducing the aperture of the telescope. And then a difficulty is encountered which has not yet met with a complete explanation. The light deducted from the star, as seen with a reduced aperture, does not coincide with that which would be predicted from theory. In some of the recent series of observations the differences between observation and theory are as great as they are perplexing. "There can be no doubt," wrote Mr. C. S. Peirce, of Harvard, twenty years ago, "that the errors introduced by the use of these diaphragms are by far the most serious of those by which my observations are effected." Dr. Wolff met with similar difficulties, and doubtless anomalies such as these have encouraged the production of other photometers which should be free from the suspicion of error. Having regard to the photometric work actually accomplished, we may confine attention to two forms of apparatus known as the Pickering Meridian Photometer and the Pritchard Wedge

Photometer. In the first of these the principle of polarisation is still used, but the artificial star is discarded. This is apparently an advantage, but it is a question if it does not introduce an error as large as that which it seeks to eliminate. An image of a star, as Polaris, is used as the constant of comparison, and this image can be reduced by polarisation till it equals that of the star of which the magnitude is sought. A lack of resemblance between the stars under consideration is removed, but the removal is effected by the introduction of a second object-glass with evidently different optical capacity, requiring a fresh constant to be determined. Prof. Pickering's photometer consists practically of two telescopes, placed at right angles to the meridian, and over each of the object-glasses is placed a right-angled prism. By means of the northern prism the image of Polaris is reflected, and by suitable adjustment can be made to occupy any convenient position in the field of view, while the prism on the other object-glass can be set to any declination so as to bring the image of any other star, when on or near the meridian, into juxtaposition with that of Polaris. Ingenious arrangements are introduced to ensure the coincidence of the pencils forming the images to be compared, and a control over the accuracy and efficiency of the whole is secured by contrasting the brilliancy of Polaris with itself—that is, by comparing the images formed by either object-glass. This is effected in all cases by rotating a Nicol prism in the eye-piece of the telescope through a measurable angle, and thus equalising the lights of the stars by means of varying the planes of polarisation. How effective this instrument has proved itself in the hands of Prof. Pickering, we shall presently see.

But either of these forms of photometer is necessarily a special production, and therefore the object-glasses are small and the light-gathering powers limited. In Prof. Pickering's first photometer, the aperture was only 4 cm., with a magnifying power of only fifteen diameters. Prof. Pritchard, considering this limitation a defect, directed his attention to the construction of a photometer which should be readily available on any instrument, and be applicable to stars of very varying degrees of brightness. For this purpose he had recourse to the principle of extinction of the light of a star, by means of a wedge of neutral-tinted glass, which could be moved over the image of a star till its rays were lost by the gradual increasing thickness of the medium through which they had to penetrate. This principle had been used by the late Mr. Dawes, and also by Capt. Abney, but the long-continued use of such an apparatus by the late Savilian Professor is likely to connect his name with this form of photometer. The main defects in its construction arise from the difficulty of obtaining an absorbing medium equally operative throughout the entire length of the spectrum, and also that of determining with certainty the coefficient of absorption—in other words, how much light is lost by the difference of thickness corresponding to one inch in length of the wedge. Recent and more exact methods than those employed by Prof. Pritchard seem to show that the constant used in his work is in error, and that a correction to his magnitudes so obtained is necessary. But it is a peculiarity of the form of construction and method of observation adopted that such a correction can be very easily applied.

These forms of photometers, the Zöllner, the Pickering, and the Wedge, are the three instruments which have been most generally in use, and with which the modern work has been accomplished. The rapidity and the progress of this class of observation can easily be shown by a few statistics. Previous to their introduction, exact photometry was limited practically to two catalogues. Exact photometry is, of course, a relative term; it is meant to include observations other than eye estimations, and therefore Herschel and Seidel, the one with 69 stars,

the other with 208, are the only two observers to whom it is necessary to refer. Since the introduction of the more rapid methods, and possibly from a better appreciation of the importance of the inquiry, we have had many extensive catalogues. Leaving out Zöllner himself, who did not attempt to condense his observations into catalogue form, we have—

Pearce's Harvard Catalogue of	494 stars.
Wolff's First Bonn Catalogue of	475 „
Wolff's Second Catalogue of	923 „
Potsdam Photometric Catalogue of	3522 „

All these catalogues have been made by means of a Zöllner photometer, but the list in no way exhausts the photometric work that has been done by this instrument. For instance, Lindemann, at Pulkova, has carried out a long series of observations with the view of determining the scale that has been unintentionally adopted in the record of eye estimations in various catalogues. Ceraski and others have been at work on variable stars, while interesting inquiries into the extinction of light by the atmosphere and other physical investigations have been made by its aid. A debt of gratitude, therefore, of no common kind is due to the ingenuity of Dr. Zöllner. Confining our attention, however, solely to the compilation of catalogues, we have with the Pickering meridian photometer a collection of the relative magnitudes of 4260 stars, followed by a photometric revision of the Durchmusterung of Argelander, in which are given the magnitudes of some 17,000 stars. This leaves out of the summary a quantity of miscellaneous work on the Pleiades, on the Asteroids, on double stars, standard stars, &c. In fact, Prof. Pickering has placed it on record, that the number of measures made with the Nicol prism was up to 1890 slightly under half a million. Finally we have the more modest catalogue of Prof. Pritchard, embracing 2647 stars, and, to complete the record with this particular instrument, we must add a small item of some 45,000 extinctions made at Harvard under Prof. Pickering's direction. Of course, many stars are common to all the catalogues, but the record shows that in the last few years instrumental photometry has been applied to something like 30,000 stars. It is not easy to form an adequate conception of so much activity.

But if the numbers have increased in such welcome proportions, it may be asked is there an equally gratifying advance in the accuracy of the observations? This question is not so easily answered. Doubtless there is a much greater accord among the observations found in the same catalogue, and made by the same observer, employing the same instrumental means. But when these catalogues are compared with one another, large and provoking differences are sometimes encountered, and not a small portion of time has been given by various astronomers to the investigation of these differences, and the attempt to systematise the various recorded values of lustre. But when all has been done, there still remain individual differences which baffled explanation. They seem to point either to irregular variations of brilliancy in the stars themselves, or to baffling meteorological influences, which it is impossible entirely to eliminate. The suggestion has been made by others, and it is intended here to give it the fullest support, that a far larger number of stars exhibit variations of lustre than are included in our variable star catalogues. It must be remembered that these catalogues have been formed, and the variations detected, by the eye alone—that is to say, without the advantages of a photometer. Consequently it is only the larger variations that have attracted attention. It is not easy to establish the fact of an alteration in brilliancy, if it be small, either with or without a photometer; but it seems not unlikely that as star magnitudes gain in trustworthiness, a larger addition will be made to the stars recognised as variable. To

come, however, to actual facts, it is recorded in the latest published catalogue of magnitudes, that of Potsdam, that the probable error of the concluded magnitude is  $\pm 0.1$  mag. This amounts to the same thing, practically, as deciding between the illuminating power of 25 and 27.5 (or 28 g. s.). It is not known whether such a problem will offer any difficulty to gas experts, but even they sometimes fail to gain full credence from the public.

The record of photometric research is by no means enriched by this catalogue of work, limited to the registration of specially devised photometers to the stars themselves. Another and entirely different method of investigation has been actively prosecuted in the last few years, and apparently with the greatest success. This method avails itself of the refinements and the results of photography. Every one knows the appearance of a photographic plate on developing it after it has been exposed in the focal plane of a telescope for a longer or shorter time. It is seen that the circular images of the stars impressed differ greatly in size, and it may be in depth of deposit, according to the magnitude of the stars impinging on the plate. Consequently, by appropriate means of discussion we are able to determine the relative magnitudes of the stars themselves. And since we have here to contemplate the measurement of a sensible area, it may not be unwise to recall the fact that the term "magnitude" of a star is strictly limited to its brilliancy. Magnitude, therefore, in its accurate astronomical sense, is not easy of definition; difference of magnitude, involving as it does difference of brilliancy, is, however, easily apprehended, and it is a difference of magnitude that is sought to be determined by measurement of the blackened area corresponding to the star images on the sensitised film.

The problem here offered for solution is not precisely the same as that in the direct application of a photometer to the light of the stars. The eye ceases to be the actual photometer employed. For the impression on the retina we have substituted the impression recorded on the photographic film. This film may be more or less sensitive to some of the rays that go to make up the whole of the light of a star than is the ordinary retina, and consequently the record will differ in individual cases from that obtained by photometric means in the more ordinary sense of the word. Leaving out of the question orthochromatic plates, which are not usually employed in recording the positions of stars, the films are prepared so as to be most sensitive for the violet light of a star, whereas the eye is generally most sensitive to the yellow. If object-glasses are employed, this difference is usually aggravated again, for the optician seeks to make this coloured light most operative, according to the direction in which the telescope is to be employed. In the case of a photographic telescope, the rays about G in the spectrum are most important; in the visual telescope, those rays about D. In whatever way the photographic observations are discussed, with the view of ensuring a general agreement with photometric results, it must be anticipated that exceptional cases will differ, especially when the star light is rich in violet rays. Speaking generally, while a photometer, as usually employed, seeks to arrange the stars according to their appearance to a normal eye, a photographic determination of relative brilliancy exhibits the stars as they would appear to an eye most keenly sensitive to violet rays.

The method of deriving the photographic magnitude of a star according to the manner in which the observations have been made. In the first place the ordinary method, whether it be taken with the view of producing a general chart of the heavens, or the accurate representation of any small selected area on the sky, will contain generally the magnitudes of the stars impressed. Consequently, if we measure the diameter of the circular

images produced by the stars of known magnitude, we have a relation between diameter and stellar magnitude. Such attempts end in the derivation of a convenient formula of interpolation. We may find that an expression of the form  $m = a \log d$  or  $m = a + b \log d$  (where  $m$  and  $d$  are respectively magnitude and diameter and  $a$  and  $b$  constants applicable only to that plate, and available only through a small range of magnitude) is serviceable practically, but has no physical meaning. The determination of the constants  $a$  and  $b$  is troublesome, and demands a previous knowledge of the photometric magnitudes of some of the stars on the plate information not always at hand. For these reasons attempts, more or less successful, have been made to assign the magnitude of a star from a knowledge of the diameter of the image and the duration of exposure. To be completely successful such an inquiry demands an acquaintance with the manner in which the image grows on the sensitised film, and this inquiry has progressed but slowly, and is still incomplete. In the early days of photography, it was supposed that the diameter varied as the square root of the time of exposure; later, with the modern dry plate, the fourth root of the time was thought by some to more nearly express the rate of growth; but Prof. Turner and the Astronomer Royal have both shown that neither of the suggestions is satisfactory. The character of the plate, the steadiness of the image, and the accuracy of "driving" (that is, the successful removal of the effects of the earth rotation), all enter as perplexing variables in a research of this character. The Astronomer Royal has suggested that the square root of the diameter of the photographic image increases as the logarithm of the time of exposure. This may be applicable to a particular telescope and through a definite range of magnitudes, but is scarcely likely to express a physical law. But, accepting such a result as a working hypothesis, we cannot pass directly to the magnitude of stars without making another assumption with regard to the diameters. This is usually summed up in the expression that for equal diameters--

$$\text{Exposure} \times \text{brightness} = \text{constant.}$$

That is to say, in order to get equal diameters of the images of two stars, one of which has four times the light of the other, we must expose the plate to the fainter star four times as long as to the brighter. This sounds almost axiomatic, and was for a long time accepted as a demonstrated fact. So much so, that at the Paris Conference in 1889 it was decided that the proper time of exposure to photograph eleventh magnitude stars was six and a quarter times that required for a ninth magnitude star. This decision of six and a quarter was adopted because this number expresses the ratio of the light in a ninth magnitude star to that in the eleventh. Probably no great harm will come from the adoption of such a resolution, but Captain Abney has given good reasons for doubting the assumption that length of exposure and intrinsic brightness are equally operative in producing the same photographic effect. All this goes to show that the determination of magnitude from an examination of the small circular dots on a "star plate" is not at all a simple problem. There is, too, another fact which should be borne in mind. All the discs are small, and yet in a range of five magnitudes, one hundred times more light has gone to make up the larger than the smaller of the two discs. This means that the scale is much contracted, and will probably interfere with final accuracy, quite as much as a want of definiteness at the edge of the disc, or distortion from a circular shape by being photographed at a distance from the optical axis, or other causes which make the measurement of the exact size of the blackened area, uncertain.

It is a question if the problem be materially simplified when the plates are photographed with the direct purpose of determining magnitude. We should then

probably adopt a plan which has been extensively employed by Prof. Pickering, but so far has had few imitators. This consists in photographing the trail of a star. If we leave a phototelescope at rest with a plate exposed, the stars describe circular arcs on the plate having the pole as a centre, and having a length of 15' for each hour of exposure. The linear length will vary according as the star is near or remote from the equator, and since the energy is distributed over this varying length, polar stars will produce more intense trails than those stars of equal brightness near the equator. Effectively if two stars are found giving trails of equal density, the brightness of the two stars varies as the cosine of the declination. But if it be found that the stars near the equator travel, by reason of the earth's rotation, so rapidly across the plate that the fainter among them leave no trail, it is possible to give such a rate to the driving clock that the trail may be of any definite length, and the energy concentrated for a longer or shorter time over this space.

The method of deriving the stellar magnitude from an examination or measurement of these trails will be best understood by considering the case of the polar stars. A plate was exposed to the pole for ten minutes, and the telescope left stationary. The aperture was then reduced by successive amounts, so that theoretically any star would appear one magnitude fainter. In the case of a selected star, therefore, we have the thickness of the trail corresponding to known magnitudes, which could at once be compared with the trails formed on other plates. Actually these trails, corresponding, it is presumed, to stars of known magnitudes, were brought into juxtaposition with the trails of stars whose magnitude was sought, and the brilliancy was decided by equality of appearance. Of course similar practices could be and have been pursued when the stars are represented on the plate by means of circular discs. By varying the length of exposure in the photograph of a star of known magnitude, we can approximate to the appearance that stars of any magnitude would present for known durations of exposure. But here difficulties connected with the sensitiveness of the plate, and the meteorological circumstances of the night affecting the transparency of the atmosphere, have to be taken into the account, and the effects eliminated from the observation as carefully as possible, so that it is doubtful if a higher degree of precision results than in the case of photometric observation. There is, however, the obvious advantage that the photographs remain, and greater leisure and further experiment may suggest improved methods of observation and reduction, that shall ultimately give us all the accuracy needed in investigations of this character. The process as at present employed by Prof. Pickering appears to be fairly rapid. Three or four years ago he could report that he had applied his method to over 60,000 images, and the accuracy appears to be about as great as in the case of photometric observations. The chances of systematic error are probably greater.

#### NOTES.

AT Marlborough House, on Tuesday, in the presence of the Council of the Society of Arts, the Prince of Wales presented to Sir Joseph Lister, Bart., the Albert Medal accorded to him by the Society for "The discovery and establishment of the antiseptic method of treating wounds and injuries, by which not only has the art of surgery been greatly promoted and human life saved in all parts of the world, but extensive industries have also been created for the supply of materials required for carrying the treatment into effect."

NO. 1328, VOL. 51]

PROF. CHRISTOPHER HEATH has been elected President of the Royal College of Surgeons, in the place of the late Mr. J. Whinaker Hulke, F.R.S.

DR. G. S. BUCHANAN has been appointed to the office of Medical Inspector of the Local Government Board.

THE Croonian Lectures at the Royal College of Physicians will be delivered by Dr. W. Macet, F.R.S., on June 18, 20, 25, and 27, the subject being the "Respiration of Man."

THE grants lately made by the United States Congress, for the Geological Survey during the fiscal year 1895-96, amount to 515,000 dollars, or £103,000. This sum includes all field and office expenses and salaries.

LAST week, the colleagues and former pupils of Sir William Turner, Professor of Anatomy in the University of Edinburgh, presented him with his portrait, as a mark of appreciation of his services in the cause of science and to the University.

IN connection with the Goldsmiths' Company's grant for researches on the anti-toxin treatment, a Committee of the Royal College of Surgeons of England have recommended a grant of one hundred pounds to Dr. Sidney Martin, for the purpose of working out the action of the anti-toxic serum, when used to counteract the effects of various poisons separated by him from the membrane, and from the spleen, in cases of diphtheria.

WE have already noted that the London Chamber of Commerce are promoting a Bill for legalising the use of metric weights and measures for export trade purposes. In connection with this, the London County Council has just resolved to do all in its power to secure the passing of the Bill during the present Session. In the meantime the Council's inspectors will not interfere with the use of metric weights and measures in the execution of foreign orders.

AMONG the men of science who have died during the past week is Theodor Brorsen, whose name is so well known to astronomers. He was born in 1819, and was the discoverer of five comets, as well as the author of a number of writings on astronomical subjects. Since 1879, he lived in retirement at Norburg, his native place. Mr. J. H. Greener, the constructor of several early lines for telegraphic communication, and one of the most able of practical telegraph engineers, died on Sunday, in his sixty sixth year.

THE President of the German Meteorological Society has issued invitations for a general meeting of the Society, to be held at Bremen on the 17th, 18th, and 19th inst., when various matters of interest to meteorologists will be discussed. The time of meeting has been fixed so as to fall in with the geographical conference, which will be held at the same place during Easter week, and in which oceanography and maritime meteorology form a prominent part. The subject of south polar investigation is also included in the geographical programme, so that it is anticipated that a large number of scientific men will take part in the proceedings.

THE spring meeting of the Iron and Steel Institute will be held in London on Thursday and Friday, May 9 and 10 next, in the rooms of the Society of Arts. The presidential address will be delivered by Mr. David Dale, and the Bessemer gold medal will be awarded to Mr. H. M. Howe, who will contribute a paper on "The Hardening of Steel." Mr. Stead, of Middlesbrough, will contribute a paper on "The Effect of Arsenic on Steel"; Mr. Sergius Kern, Metallurgist to the Russian Admiralty, will discuss the manufacture of armour-

percing projects in that country. Mr. Herbert Scott will communicate a paper on the iron ore mines of Elba; and Mr. W. J. Keepe, of Detroit, will contribute a paper on "Tests of Cast Iron."

DR. CARLO SCHEINFORTH, the distinguished African traveller and biologist, has passed the winter at H'ulun, near Harbin, where he is engaged in mapping and describing the various mountains and "walis," for a memoir to be communicated to the Institut Egyptien. Dr. Scheinforth has just published the text of an interesting lecture on Erythraea—the Italian colony on the Red Sea—delivered before the Geographical Society of Berlin in July last year. This paper gives an account of a four-months' expedition which he made to Erythraea in the early spring of 1894, in company with Dr. Max Schöeller. It gives a most favourable report of the progress of the new Italian colony and of its future prospects.

A CORRESPONDENT has sent us particulars of an explosion which occurred at Providence, Rhode Island, U.S.A., on March 8, in connection with the electric light mains of that city. The explosion resembles those recently investigated by Major Cardew (see p. 539). Through a leak in the gas mains, the conduits became full of an explosive mixture, which suddenly exploded with great violence. The street was blown up for some thirty feet, all the glass in neighbouring houses wrecked, and missiles of wood and iron thrown to some distance. The noise and shock are said to have been felt all over the city.

THE circumstances connected with the formation of the dangerous alkaline deposits found by Major Cardew on the mains of the St. Pancras electric light supply, and the presence in this deposit in some cases of the alkaline metals in an unoxidised condition, have been inquired into by a Committee of the Royal Society and the Institution of Electrical Engineers, and the results have been issued in a report, which states that "the Committee are of opinion that the explosions which have occurred were caused by the firing of an explosive mixture of coal-gas and air by sparks caused by means of the above-mentioned incrustation. It has been proved that sparks may be caused either by the incrustation itself acting as an imperfect electrical conductor, or by moisture coming into contact with metallic sodium or potassium, both of which metals have been found to exist within the incrustation. These metals have been produced by the electrolytic decomposition of alkaline salts, chiefly derived from the soil and conveyed by moisture along the fibres of the woollen bearers towards the negative conductor. To avoid a repetition of these accidents, the bearers of the insulators at present in use should be replaced by other bearers through which moisture is prevented from travelling, and it is recommended that the pattern of insulator in use should be changed, and a pattern adopted in which a larger insulating surface is interposed between the conductors at the bearers. The Committee are also of opinion that it is desirable that means should be provided by which the conduits can be inspected throughout their length, so far as is necessary to detect any incrustations on the insulators. The Committee have recommended that the provincial authorities investigate the causes of the formation of coal-gas within the electric lighting conduits, and they advise that this is the primary cause of danger."

THE following report with reference to the recent explosion of a gas cylinder with compressed oxygen at Finchurch Street is the result of the coroner's inquiry on Thursday. An examination showed that the inner surface of the cylinder was incrustated with the oxide of iron which the valve was the surface

was incrustated with magnetic oxide of iron, which was easily removable, and which under the microscope showed in many places the globular form assumed by the magnetic oxide produced by the burning of iron or steel. The lower end of the brass screw, by means of which the valve fittings were screwed into the bottle, was also incrustated with magnetic oxide of iron, much of which was in the form of small globules produced by fusion at very high temperature. They were evidently fused to the material of the screw, and it in some cases even slightly pitted the metal. These facts lead Dr. Dapre to conclude, first, that the bottle at the time of the accident contained an explosive gaseous mixture; and that, secondly, this mixture was fired by some portions of finely-divided iron, or perhaps grease, igniting in the compressed gas. That some iron had actually been on fire in the cylinder the condition of the screw sufficiently proved. The coroner, in summing up, spoke strongly in favour of a Government test being imposed with regard to the cylinders; and the jury included in their verdict the recommendation that all compressed gases of an explosive nature should be scheduled under the Explosives Act, that all cylinders should be tested by the Government periodically, that no cylinder should be allowed to be used or conveyed about unless bearing the Government stamp, that all manufacturers should be licensed by the Board of Trade in the future, and that separate hydraulic pumps should be used in the apparatus in filling the cylinders, and also recommended a Board of Trade and railway inquiry.

AT the Institution of Civil Engineers, on April 2, Mr. J. I. Thornycroft, F.R.S., and Mr. S. W. Barnaby, in a joint paper, expressed the belief that the speed of vessels had now approached within measurable distance of that at which propulsion by screws became inefficient. For a given pitch-ratio and slip, the thrust per unit of area varies as the square of the speed. Certain conditions of pressure on the screw-blades cause the formation of cavities, filled with air and vapour driven off from the water, behind the blades. Experiments carried out by the authors, with screw-blades of elliptical form, show that this "cavitation" does not commence suddenly, but appears to become detrimental when the mean negative pressure on the forward side of the blades exceeds about  $6\frac{1}{2}$  lbs. per square inch, or when the whole thrust exceeds  $11\frac{1}{2}$  lbs. per square inch. Cavitation can only be avoided at very high speed by increasing either the immersion of the screw or its blade-area. Immersion is limited by considerations of draught. Increased area, the authors remarked, can be obtained in three ways: (1) by increasing the ratio of surface to disc-area, (2) by employing a larger diameter than that theoretically best for the given conditions, (3) by increasing the pitch-ratio, which involves a larger diameter with a reduced rate of revolution. Either tends to a waste of power if pursued beyond somewhat narrow limits, and it appears inevitable that reduced efficiency must be submitted to as the speed of vessels is increased.

A FEW noteworthy points were brought out last week in evidence before the Select Committee of the House of Commons appointed to consider the advisability of adopting the metric system of weights and measures. Captain H. R. Sankey, R.E., director of the engineering firm of Willans and Robinson, Thames Ditton, said that the metric system of measurement had been adopted by his firm for the last two years. The reason of the change was the advantage of working interchangeably with manufacturing engineers on the continent. His firm's trade was mainly British, but no objection had been made to metrical measurements by British customers. The workmen were agreed that the metric system was much more easy to work with than the English measures, and was much less liable



to error. The inconvenience of the change to the metric system was only felt by the workmen for a few days. In his evidence, Dr. Gladstone estimated that in the elementary schools about 350 hours were occupied in teaching our cumbersome system of weights and measures. As the children had to learn decimals, very little more time would be needed by them for learning the metric system. A chart explaining the metric system was now to be found in nearly all the London schools, and lately it had been decided to supply actual examples of the metre and litre to such schools as asked for them. The metric system was but partially taught in the schools, for the teaching involved additional labour, and was not insisted on by the inspectors. The introduction of the metric system would be much facilitated if the system were compulsory in the elementary schools.

In a paper read before a recent meeting of the Académie des Sciences (*Comptes rendus*, exx. p. 611), M. Lucien Poincaré described some experiments on secondary batteries he has been performing. With a view of reducing the losses that take place in the ordinary lead accumulator, the author has tried to obtain a battery with *liquid* metallic electrodes. For this purpose mercury has been employed, and as it would not do to employ an acid as the electrolyte, since the hydrogen would be liberated and thus cause a waste of energy, a solution of a salt is used. Under these circumstances an amalgam is formed at the cathode, which, together with the mercury of the anode, forms a secondary cell. Of all the different salts tried, the most interesting results have been obtained with the haloid salts of the alkaline metals. With these salts the electromotive force of the secondary battery is about two volts, but in the case of the chlorides and bromides, the chlorine or bromine combines with the positive mercury, forming a badly-conducting layer, so that the output of the cells is not satisfactory. With a solution of iodide of sodium, however, very satisfactory results are obtained, for as long as the solution is kept sufficiently concentrated, the current density during the charging is not too great, and the positive electrode has a larger surface than the negative electrode, no deposit is formed on the anode. Hence by this arrangement a secondary cell is obtained in which the two electrodes remain, after the charge, entirely metallic, so that the internal resistance does not increase as the cell is charged. The efficiency of these cells amounts to very nearly 90 per cent., the electromotive force, when fully charged, being 1.85 volts. The capacity per kilogram does not differ much from that obtained with ordinary lead accumulators, being about 10 ampere-hours. A very important point about this form of cell is that the density of the *discharge* current is immaterial, and they may be completely discharged without in any way deteriorating.

We have received from Prof. G. Hellmann an interesting pamphlet entitled "Contribution to the Bibliography of Meteorology and Terrestrial Magnetism in the Fifteenth, Sixteenth, and Seventeenth Centuries." The work was prepared for the Report of the Chicago Meteorological Congress, and contains a list and brief bibliographical notes of 272 old books in Dr. Hellmann's library, arranged under the authors' names, with cross references under subjects and dates. This pamphlet is of considerable value to meteorologists, as the early literature of this subject is as yet little known, and no meteorological institute is as rich in the older literature as the library in question. Arranging the books according to the language in which they were written, Dr. Hellmann shows that the authors comparatively seldom employed their native language, as 157 of the works are in Latin. There is also a preponderance of Italian works, as in the seventeenth century Italy probably contributed more to meteorology than all the other nations of Europe. Many of the works described are exceedingly scarce.

SINCE the great Japanese earthquake of 1855, the strongest shock felt in Tokyo was that of last June 24. No house was absolutely destroyed, but in the lower parts of the city many brick buildings were damaged and chimneys thrown down. The total land-area disturbed was 42,000 square miles. The diagram of the earthquake, taken by a large-motion seismograph at Tokyo, is given by Messrs. Sekiya and Omori in a short but valuable paper (*Journ. of the Coll. of Science, Imp. Univ., Tokyo, Japan*, vol. vii. part v. 1894). This diagram being on the natural scale, the preliminary tremors are not shown, and during the first two seconds of the record the motion was already strong. It then became suddenly violent, the ground moving 37 mm., followed by a counter-movement of 73 mm., the maximum horizontal displacement during the earthquake. At about the same time, the maximum vertical motion of 10 mm. occurred. The movement, which lasted altogether 4½ minutes, soon became comparatively weak, and it is no doubt to the small number of violent oscillations that the slight amount of damage is due. As usual, the direction of motion changed during the earthquake, but the maximum horizontal motion was directed towards S. 70° W., and this is identical with the mean direction of overturning of 245 stone lanterns in different parts of Tokyo.

THE Natural History Society of Queensland, established in the beginning of 1892, has progressed so well that it is able to issue a volume of *Transactions*. The volume should prove to be a useful contribution to the literature on the natural history of the colony.

THE fifteenth volume of observations of "Rainfall in the East Indian Archipelago," published by the Government of Netherlands, India, has been received. The volume is edited by Mr. Van der Stok, the director of the observatory at Batavia, and it comprises observations made at 194 stations, of which 104 are in Java and Maloera, and ninety in Sumatra and the different islands of the Eastern Archipelago.

In the *Geological Magazine* for April appears a translation of a Swedish paper by Prof. Lindström, on the discovery of *Cyathaspis* in the Silurian formation of Gotland. In the cutting of canals for the drainage of marshy tracts of the island, many good exposures have been made of the fossiliferous marl-shales that underlie the famous limestones with the operculate coral *Rhizophyllum*. Among the fossils obtained from these shales were a pair of dorsal shields of a Pteraspidian fish. Hitherto the oldest known indubitable fish-remains date from the Ludlow epoch, but the Gotland beds are of Wenlock age. It is pointed out that since the vertebrate character of the Cambrian conodonts has been disproved, and the supposed Ordovician fish-remains of North America are very doubtfully of that age, these Gotland fossils are, for the present, the oldest known Vertebrates.

FIRST among the new editions received within the past few days is Prof. James Dana's "Manual of Geology," published by the American Book Company. The appearance of this fourth edition of Prof. Dana's classical work, makes us marvel at the energy of the eminent author who, though now eighty-three years of age, could rewrite the whole of the matter in such a ponderous volume as the "Manual," and add one hundred and fifty pages to what was published in the third edition. It is hardly necessary to say that a multitude of new principles, new theories, and new facts, in all branches of geology, have been included in the new edition. "The Partition of Africa" (Stanford), by Mr. J. Scott Keltie, has reached a second edition, after two years of life. The many events that have taken place in Africa during this time are all given consideration. Another volume which has attained the eminence of a



THE SUN'S PLACE IN NATURE.

III.

THE next question that we have now to consider has to do with the connection between nebulae and stars, and I shall show that the more the facts are studied the closer does this connection prove to be. You remember that that was the idea which lay at the bottom of the hypotheses both of Kant and of Laplace. In the last lecture I referred to some of the earliest observations which had been made of the nebulae by means of the spectroscope, and it so happened that Dr. Huggins, to whom we owe this work, came to the conclusion that the result of his inquiries was rather to show that this connection, which had been asserted both by Kant and Laplace, and which had been accepted by everybody up to then, really did not exist. In a paper which detailed these spectroscopic observations, published in 1865, Dr. Huggins stated his conclusion that the nebulae, instead of having anything whatever to do with any evolutionary line along which both nebulae and stars might be traced, possessed a structure and a purpose in relation to the universe altogether distinct and of another order. So that you see the first apparent teaching which we got from the spectroscope practically put us in a very considerable difficulty; if it had to be accepted, of course the views of Kant and Laplace would have to be rejected.

When I commenced my general survey in 1887, this view held the field, and further, it was imagined that the observations of Dr. Huggins justified the idea that the nebulae were masses of

of these singular bodies, the nebulae, and the simplicity of their composition, one is led to see in them only the residuum of the primitive matter after condensation into suns and into planets has extracted the greater part of the simple elements which we find on the earth and chemically in some of the stars."

It was perfectly clear then to Dr. Wolf that, if the constitution of the nebulae was anything like what was supposed to have been revealed by early spectroscopic observation, we were dealing with a residuum. There was one kind of action in space, bringing together one class of elements with which we are familiar here, and forming them into stars, suns, and planets; but there was another kind of matter which declined to form part of these aggregations, which remained by itself, and finally put on the appearance of the so called nebulae.

The first thing I have to say concerning this view is, that the discussion of the spectroscopic observations which I told you, in the last lecture, had been undertaken with a view of seeing what really could be determined in relation to this question, showed, beyond all question, that there was no ground whatever for it; that there was no real ground for supposing that there was this enormous difference between the nebulae and the stars. In the year 1887, the year following the course of lectures to which I have already referred, after testing the views on this question by an appeal to all the available observations, I stated that the facts taken in all their generality showed that the nebulae simply represent early stages of evolution; that is to say, that we have a continuous and orderly progression from the nebulae to the oldest star, and

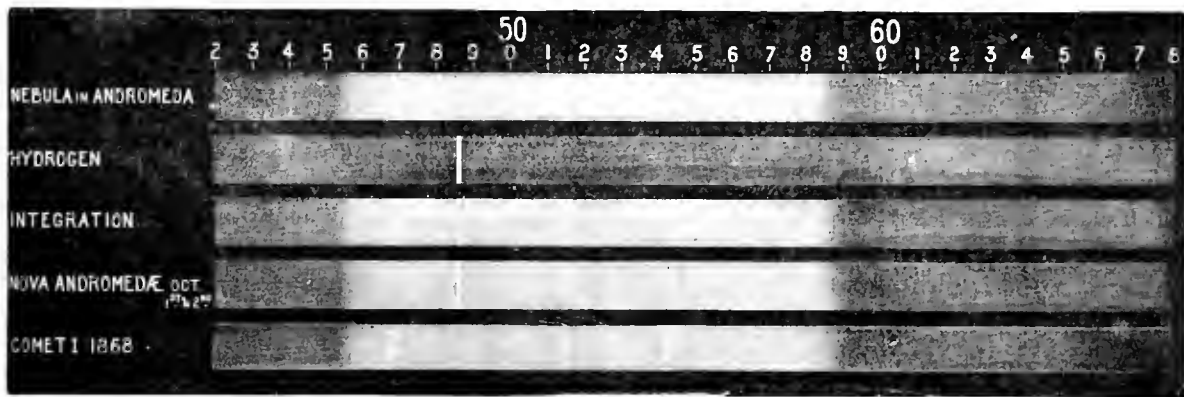

FIG. 12.—Spectrum of the nebula in Andromeda compared with Nova Andromedæ and comet. The flatings common to all are those of carbon.

gas; what particular gas will concern us a little later on, but for the moment I need only say that these statements announcing the nebulae to consist of one or two gases, at once led to several most remarkable views of the general constitution of the heavens.

Near the end of this nineteenth century chemists claim to know something of the materials which have built up the planet on which we dwell, and if you consult any of the books which have been written about spectrum analysis, giving the results of the work during the last thirty years or so, you will find it stated over and over again that the spectroscope has put it for ever beyond doubt that the chemistry of the skies, *i.e.* the chemistry of the various bodies which people space, and which are at a sufficiently high temperature to enable us to examine them spectroscopically, exactly resembles the chemistry of the earth. So that, if this were true, we should have a common chemistry of the earth, of the stars, and among the stars of course our own sun. On the other hand, we should have, according to Dr. Huggins, absolutely and completely distinct from these bodies another class, the nebulae, in which the chemistry is absolutely and completely unique. This was so clearly the idea suggested to philosophical students of these questions, that Dr. Wolf, a famous French astronomer, who has written an all-important book for those who are interested in these inquiries, "Les hypothèses cosmogoniques," published in 1886, writes: "If we admit the data of spectrum analysis as to the gaseous state

that the nebulae represent the first stage, and the oldest star or planet represents the last. It seemed to be perfectly clear from the discussion that we were justified in stating that every nebula which is visible now will some time or other, owing to the condensation of its various parts, become a star of some order or another; and that it is equally true to say that every star which we see now in the heavens, knowing it to be a star, has really been a nebula at some time or another.

I told you that the first suggestion of a possible condition which would enable an evolution to take place from nebulae to stars had been made by Prof. Tait, when he thought that probably cool meteoritic particles might have something to do with it. The complete inquiry shows that these meteoritic particles might account equally well both for the luminosity of comets and of nebulae. This association is important because it is generally conceded that comets are swarms of meteorites.

It seemed so obvious that there was this close connection that in 1888 I predicted that, if the nebulae were carefully observed, we should find in them sooner or later indications of that same substance which makes the comet's spectrum so very distinct and special. In almost every comet which has been observed, the spectrum of carbon, or of some compound of carbon, is the strongest and most obvious feature which is presented to us. In 1889, *i.e.* only the next year, matters were made very much clearer by the discovery, by Mr. Fowler and Mr. Taylor, of the spectrum of carbon in the nebula of Andromeda (Fig. 12), so that there, you see, was a prediction verified, and such verification is always a very precious

1 Revised from a shorthand notes of a course of Lectures to Working Men at the Museum of Practical Geology during November and December, 1894. (Continued from page 397.)

...st, since it ... know whether one is going right or wrong, and it seem ... strengthen very much the view under consideration. ... not only do we find carbon both in ... but it is recognised by ... the stars the same substance ... quantities. Here, then, we ... of the fact that the state ... an enormous chemical differ ... between nebulae and stars is ... to be unfounded, while ... goes to show that there is a ... between nebulae and comets. ... the argument is very much ... here fall round, because, as we have seen, ... agrees that comets most ... consist of meteoritic stones or particles. ... I am glad to say that among the first to ... the new evidence proving that nebulae really early stages of evolution of stars was Dr. Huggins himself, the observer whose statement which I have quoted I had been fighting for years. That you see was a great victory. He says now not only that these bodies may represent early forms; places them in the line of evolution where I had placed them, but he even adduces the same evidence which I had brought forward in several of the arguments which I had employed. Dr. Huggins made a reference to this question as President of the British Association in the year 1891, and if any of you read that you will see that it is really an argument in favour of the views that I have been insisting upon since 1886, and his agreement seems all the more important since Dr. Huggins appears to have arrived at these conclusions quite independently. Not one word is said throughout the address of any arguments which I may have used, or of any line of thought or observation on which I had

course you will acknowledge that that was a very extraordinary change of opinion, so extraordinary indeed that it is clear that Dr. Huggins felt that it was of importance

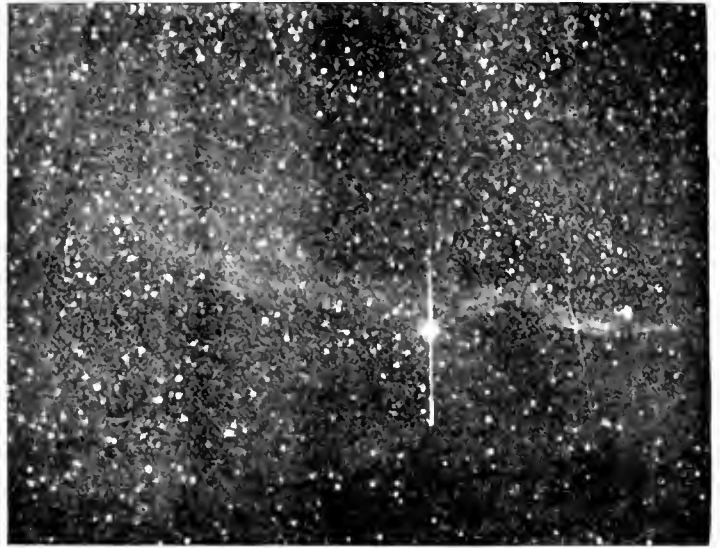

FIG. 13.—The nebula near  $\epsilon$  Cygni, from a photograph by Dr. Roberts

to himself that the change should be explained; and he confesses in the address, to which I refer, that the communication he made to the Royal Society in 1864 was not entirely

founded on scientific evidence, but partly made under, to use his own words, "the undue influence of theological opinions then widely prevalent."

So after all I had been fighting partly an expression of a theological opinion. If we had known that before, probably some trouble might have been saved.

It is a very important thing to know that now, from east to west, those who dwell upon this planet are all perfectly convinced that nebulae are early forms in the evolution of the heavenly bodies. The more one knows of the history of human thought, especially during the last two centuries, the more important does it seem that that result should be acknowledged as one of the most important truths established during the present century.

Before I go further, let me refer to two or three typical examples of these strange bodies, as I can do by the kindness

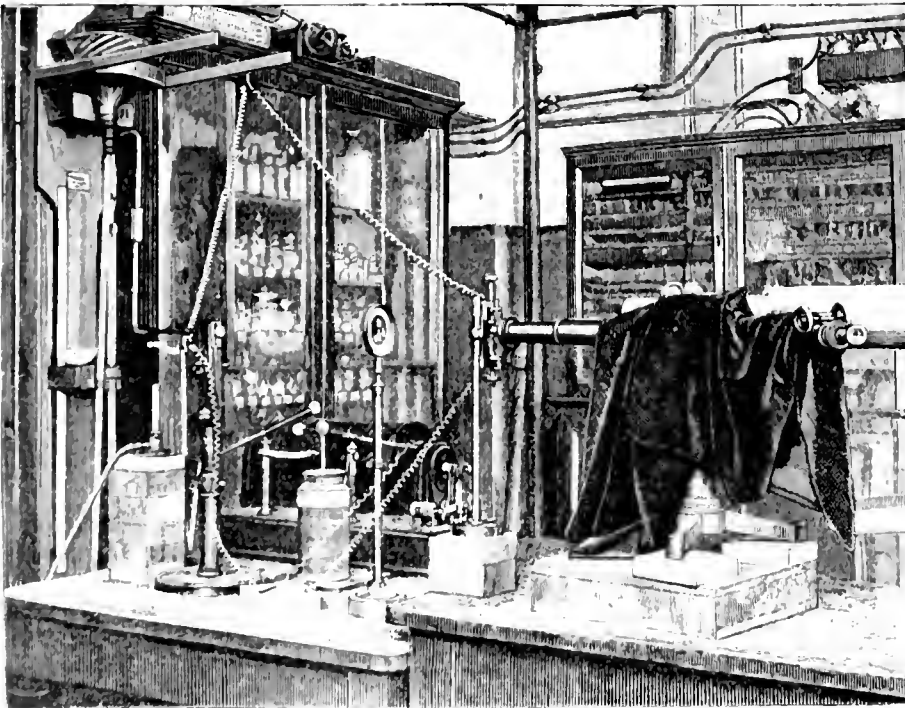

FIG. 14.—Spectrograph, as described in the lecture.

of Dr. Roberts, whose method of work I described in the last lecture. First of all we have a representation of a form of nebulae ... statements which I had made; and there ... unable to suppose that he was unacquainted ... was given to the world. [OF NO. 1328, VOL. 51]

of Dr. Roberts, whose method of work I described in the last lecture.

First of all we have a representation of a form of nebulae

which is not very common, but the study of which is all important for our present purpose. It is called a spiral nebula, it is one of the nebulae in the constellation of the Great Bear. I wish to point out that in the centre we have a condensation, and from the centre of the condensation the luminosity gradually gets less and less until at last we have no luminosity greater than that of the surrounding sky. In the nebula itself we find exquisite spirals, starting apparently from different points, and gradually coming towards the centre, and if you look along these spirals you will see that the star-like masses, which may not be stars, are in many cases located on the spirals, representing apparently minor condensations, each spiral itself being probably brighter than the other parts because it is more disturbed.

Next we have an absolutely untouched photograph of the famous Dumb-bell Nebula. I am certain that many here have studied the drawings of this nebula given in encyclopædias and in books of astronomy during the last forty years, and that it is a great comfort to you to see, as it is to me to be able to show you, the autobiographical account that it gives of itself, because if you refer to those drawings it will be very difficult to find any two alike, even if it is distinctly stated that one has been copied from the other. In this again we find a central condensation, and associated with it arcs in which the luminosity is greater than in the adjacent regions.

The other nebula that I have to exhibit is one remarkable for its difference from the other two, inasmuch as no condensation is suggested. This nebula, which you see stretching across the screen like a sort of celestial river (Fig. 13), seems to be careering through space, and I call your attention specially to this because it is well to remember that, if we have meteoritic swarms in space, *i.e.* swarms which are condensing, it is quite possible that we may have meteoritic streams. I think you will consider that it is not any misuse of words to say that we have there a possibility of a meteoritic stream.

So much then for some typical representations of some of the different forms of nebulae.

While, however, Dr. Huggins in his presidential address, apparently from quite independent inquiry, announced my main contention, *viz.* that nebulae and stars *do* belong to the same order of celestial bodies, and withdrew his unfortunate statement as having been made on theological grounds, I am compelled to say, but wish to say it with the utmost courtesy, that a complete study of the literature shows that he was quite familiar with my work all the time, and that while he thought fit to republish my main contention as his own on the one hand, on the other he was engaged in attempting to throw discredit on my work, and to conceal his retreat after the manner of the sepia by a

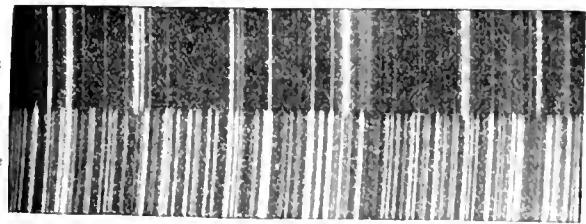

FIG. 13.—Line-spectra of barium and iron. 1. Barium. 2. Iron.

great cloud of ink—printer's ink, referring to a minor point. He endeavoured to suggest to anybody who was not really completely acquainted with my work, that the methods employed by my assistants and myself for something like three years were inaccurate, and that the conclusion reached, which must have been right because he had come to agree with it, had been got at in the wrong way. Although the charges of inaccuracy which Dr. Huggins thought fit to make were general, in his printed papers the chief stress has been laid upon a statement I had made with regard to a matter of secondary importance in the general discussion, I refer to the possible origin of the chief line in the nebular spectrum.

I propose to go into this matter in some detail, because it will enable me to indicate the closeness with which the skill of trained observers and the magnificent instruments of modern research that I have already referred to, enable us now to deal with facts, and to replace the imperfect observations of the past with others of which the accuracy may be relied upon.

Among the many lines of evidence which had been brought forward, it was stated by myself that in following up the suggestion of Prof. Tait and experimenting upon meteoritic dust, a line had been seen very near the position of the chief line which Dr. Huggins had discovered in the year 1864 in the spectrum of the nebulae. In fact, after accumulating all the spectroscopic



FIG. 14.—Flutings of carbon.

observations which I could lay my hands on, I went on to experiment myself, and I have here some apparatus which will give you an idea of the kind of experiment which was undertaken (Fig. 14.) Meteoritic dust is placed in a horizontal spectrum tube connected with a Sprengel air-pump, so that an electric spark can be passed through the dust; an image is formed on the slit of the spectroscope, and an arrangement for an ordinary electric spark in air serves for a comparison spectrum. The point was to see whether there was any probability that Prof. Tait's suggestion was right, by examining the spectrum of meteoritic dust. For this purpose some dust was placed in a tube resembling the one now on the table, and an electric current was sent through it. Now it had long been known that when one heats meteoritic dust, it gives out compounds of carbon, and also hydrogen gas; what I did was to observe the change in the spectrum of that tube under different conditions. For instance, if it were wished to expose the dust to a higher temperature, a Bunsen burner was placed underneath it.

You will be able to see that, in a little time, the heat will make a considerable difference in the phenomenon observed in the region which comes under its influence, and I think you will also see that in some parts we get a distinct indication of green colour. Now what I found was that in the spectrum of dust from several meteorites so examined, there was a line very near the position which had been stated by Dr. Huggins to represent the actual position of the chief line seen in the spectrum of the nebulae. That line I was able to trace home by comparative work to olivine, a substance which occurs in almost all meteorites, even in iron meteorites, and not only to olivine, but to one of the constituents of it, which is magnesium. I have here a diagram of some of the results obtained in the green part of the spectrum, and it will be seen that we get in the nebula of Orion, and in the comets of 1866 and 1886, a bright line apparently in the same position. When I say line I should correct myself, this luminosity given out by magnesium does not take the form of a line as ordinarily so called. I will throw on the screen photographs of two spectra of the vapours of two metallic substances, barium and iron (Fig. 15), and you will then see what is meant by men of science when they talk about a line spectrum.

But besides what we call line spectra, there is another thoroughly well-recognised class, which we call fluted spectra. Because it reminds one of the flutings of a column. Here, for instance, is a fluting of carbon (Fig. 16). In these flutings, instead of the lines being distributed irregularly, as in the case of iron and barium, we get a beautiful rhythm from one part where the light rapidly degrades to another where there is an enhancement of the light, followed by another degradation, and so on. Indeed, we not only get main flutings, but we get subsidiary flutings.

J. NORMAN LOCKYER.

(To be continued.)

THE INSTITUTION OF NAVAL ARCHITECTS.

THE annual spring meeting of the Institution of Naval Architects was held on Wednesday, Thursday, and Friday last week, in the theatre of the Society of Arts. There was a large number of papers set down for reading and discussion as follows:

"Notes on further Experience with first-class Battle-ships," by Sir William White, Director of Naval Construction.

"The Elements of Force in a Warship," by Vice-Admiral P. H. Colomb.

"On Steam Pipes," by J. T. Milton, Chief Engineer Surveyor, H.M.S. Registry of Shipping.

"Eight Draught River Steamers," by George Rickard.

"On Solid Steam Forms and the Depth of Water necessary to avoid abnormal Resistance of Ships," by D. W. Taylor, Senior Assistant to Chief Constructor of U.S. Navy.

"On the Method of initial Condensation and Heat Waste in Steam Engine Cylinders," by Prof. R. H. Thurston, Sibley College, Cornell University, New York.

"Description of an Aluminium Torpedo Boat built for the French Government," by A. F. Yarrow.

"On Vibrations of Higher Order in Steamers, and on Torsional Vibrations," by Otto Schlick.

"On the Vibrations of Ships and Engines," by W. Mallock.

"On a Method of Extinguishing Vibrations in Marine Engines," by Mark Robinson and H. Riall Sankey, Captain (retired) R.F.

"On the Transverse Stability of Floating Vessels containing Liquids, with special Reference to Ships carrying Oil in Bulk," by W. H. K.

"Induced Draught as a Means for developing the Power of Marine Boilers," by W. A. Martin.

After the usual formal proceedings had been transacted, and the President, Lord Brassey, had given a brief address, Sir William White's paper was read by his colleague at the Admiralty, Mr. W. E. Smith, the author being absent owing to serious illness; from which, every one will be glad to hear, he appears in a fair way of recovery. This contribution dealt chiefly, indeed almost wholly, with the question of steadiness in the large battle-ships of the *Royal Sovereign* class, and the effect of fitting them with bilge keels. This paper may be said to be the complement of another memoir by the same author, read before the Institution last year, in which the experience gained with the big line of battle-ships was recorded. When the *Royal Sovereign* was designed, it was thought that the period of oscillation would approximate to that of the *Inconstant*, *Heracles*, and *Sultan*, which were all remarkably steady ships. The *Heracles* and *Sultan* had only shallow side keels from 9 to 10 inches deep. It was thought that the great inertia due to the large dimensions of the new ships would render them so steady that these small bilge keels might be omitted. That the expectations formed in this respect have not been fulfilled, shows that even the best-informed naval architects, even when supported by the best scientific evidence at their command, may be wrong at times. The performance of the ships of the *Royal Sovereign* class at sea led to the fitting of bilge keels to one of them—the *Republie*. These keels are each about 260 feet long and 3 feet deep. Four of the class were at a point on the west coast of Scotland in company. There was a long low swell, 30 to 40 feet from crest to crest, and with a period of about ten to twelve seconds. The *Resolution*, without bilge keels, rolled 23, and the *Republie* 10. The sea was on the quarter, and the speed such as to produce heavy rolling. The records of angle of roll were obtained by the pendulum, an instrument not commonly trustworthy, but in the present case the results obtained were probably fairly accurate. A very rough, there was no doubt that the behaviour of the ship was immensely improved by the bilge keels, and it was decided to attach other ships of the class in a similar manner to the *Republie*. The consensus of opinion of naval officers is that rolling has been generally reduced. Sir William White very frankly admits that the steady effect of bilge keels has greatly exceeded that which was anticipated; and, indeed, the opinion of naval officers at large will now have to be reversed, and the question upon which ship designers will well require to be reconsidered. For a complete paper on the exact information was obtained could be obtained by trials at sea, on which, as is so often the case, it is generally impossible to obtain accurate records.

It was therefore arranged that still-water rolling experiments should be made with the sister ships *Revenge* and *Resolution*. Mr. R. E. Froude, whose father's work is so well known in this field, had charge of these trials. One series of experiments was made before bilge keels were fitted, and another after the keels had been attached. Each series was divided into two sections, the ships having a metacentric height of 3½ feet in one case, and a little under 4 feet in the other. The conditions approximate to those of maximum and minimum stability on service. The oscillation of the ships was produced by training the heavy guns and running men across the deck in the usual way. The results of these trials were shown by means of diagrams hung on the walls of the theatre. Curves for the older ships *Sultan* and *Inconstant* were also placed on the diagram. Starting from an angle of inclination of 12° from the vertical, it was seen that in order to reduce the corresponding inclination of 6°, the *Revenge*, without bilge keels, required to make 18 to 20 swings, and the *Sultan* about 17; there being a remarkable similarity between the curves of declining angles of the two ships. The *Sultan*, as already stated, has always been considered a satisfactory vessel in regard to steadiness. Starting from an angle of inclination of 6° from the vertical, it required 45 swings in the *Revenge* without bilge keels to reduce the corresponding angle of inclination to 2°. After bilge keels were fitted, an equal reduction was obtained by only 8 swings. For the *Sultan* and *Inconstant*, 32 to 20 swings respectively would be required to produce the same reduction. The *Revenge*, before the bilge keels were fitted, could be rolled up to an angle of inclination of 13° to the vertical by moving her barquette guns. After the keels were in place it was difficult to exceed an inclination to the vertical of 6° to 8°, even with 300 to 400 men running across the deck, and acting in conjunction with the movement of the guns.

The variation in the periods of swing (from out to out) brought to light by these trials are instructive. Without bilge keels, the author continues, the rolling was practically isochronous at large as well as small angles. The period for a single swing was 7.6 seconds for maximum stiffness, and 8 seconds for minimum stiffness, for large as well as small arcs of oscillation. With bilge keels, within the range of experiment up to a swing of about 12° (6° each side), the period of a single swing decreased as the angle of inclination became smaller; the reduction being about 2½ per cent. in going from a mean inclination to the vertical of 5° to one of 1°. When the metacentric height and radii of gyration of the ship were appreciably unchanged, there was an increase of about 5 per cent. in the period due to the action of the bilge keels.

A study of the action of bilge keels on a ship's performance not only involves questions of the greatest practical importance to the ship designer, but also problems of high scientific interest. From whichever point of view we consider Sir William White's paper, it is one of exceptional value. It is seldom that the naval architect has the opportunity of making trials or experiments on so grand a scale as that afforded by the big battle-ships of the *Royal Sovereign* class, and for this reason we are giving unusual space to this paper. Nevertheless, we are unable to follow the author in his comparison of the experiments under consideration with those previously made both by French and English engineers. For these we must refer our readers to the original memoir, confining ourselves to the main results, from which a comprehensive view of the scope of the paper may be formed. One of the most important of these results is the increased extingutive effect shown by the experiments to be produced by bilge keels when the ship has headway, compared to the effect when she is not progressing. The experiments under way were limited in number, and, as the author points out, are perhaps not so definite as those with the ship not having headway. "Still they are very suggestive," to once more quote the author's words, "and confirmatory of the conclusions from previous experience that the rate of extinction is sensibly increased by headway, the ship entering undisturbed water while oscillating, and the inertia of that undisturbed water having to be overcome." We can only quote the broad results. Starting at 5° from the vertical the angles of inclination reached, after a certain number of swings, were as follows:—After 4 swings, 10 headway 2.95; at 10 knots 2.35; at 12 knots 2.2. After 10 swings, no headway 1.15; 10 knots 2.0; 12 knots 2.5.

It will be remembered by students of this subject that the late Mr. Froude assigned a coefficient of resistance of 1.6 lbs.

per square foot for deadwood and keels moving at 1 foot per second, and this was confirmed by the behaviour of the *Sultan*. Accepting Mr. Froude's formula, the extingive effect due to bilge keels, such as have been added to the *Revenge*, was calculated, with the result that, in an extreme case, supposing the ship to be rolling to 20° on each side of the vertical, the extinction value due to the bilge keels would appear to be not quite 2". This, it will be seen, is far short of the observed results obtained from the vessels themselves. Working on the data that have been obtained in this way, new coefficients have been calculated for bilge keel resistance, it being assumed that the whole increase of work were credited to the bilge keel area. For an angle of swing of about 10° instead of the coefficient being 1.6 lbs., it would be about 11 lbs. for a swing of 4°, the coefficient would reach as high a value as 15 or 16. It must be remembered that these coefficients are not put forward as truly representative, they only hold good if the assumptions made are accurate.

In any case the difference is very great. Mr. R. E. Froude, who contributed a most interesting speech to the discussion, confessed that the results look him, when he first had them put before him, entirely by surprise, and, indeed, he did not credit the statements made as to the improved behaviour of the ships; or, rather, he could not attribute this improvement to the presence of the bilge keels. We judged, however, from his remarks that he now accepts the observed data and the truth of the recorded experimental conditions, but still considers the phenomenon one for which he can offer no adequate explanation. He himself had made tank experiments which agreed fairly well with the results obtained by his father, and was quite at a loss to account for the great difference between these experiments and the results of the trials now recorded. The only explanation he could suggest was that bilge keels, on a rolling ship, meet on the return roll with water set in motion by the previous roll; but this, he thought, was quite insufficient to account for an increase in resistance of as much as, say, ten times that which would be calculated on the 1.6 coefficient. Naval architects will be glad to hear that the whole question is to be made the subject of exhaustive inquiry at Harlow. The principal reasons that bilge keels are not fitted—putting aside expense and difficulties as to docking—are that they add to the immersed surface, and are thus likely to decrease speed. It is, therefore, satisfactory to learn that "the practical tests of actual service prove there is no sensible reduction in speed for power." As it is also stated that the keels have not sensibly reduced diameter of circles made by the vessels, and, further, that additional steadiness in steering has been obtained, it is not hazarding much to say that in future ships of this class in the Royal Navy will all be fitted with bilge keels, unless exigencies of docking forbid their application.

The space which we have devoted to Sir William White's paper will compel us to dismiss most of the other contributions briefly. Mr. Milton's paper on steam-pipes was an excellent practical contribution, and was followed by a no less excellent discussion. The general conclusion arrived at appeared to be that, with high pressure, steel steam-pipes are likely to take the place of those of copper. Mr. Taylor's paper was read in brief abstract, and as it was not in the hands of members until a few minutes before the meeting, we must pass it by. The same thing may be said of Prof. Thurston's paper. It is very gratifying to the members of an English institution to receive papers from foreign members of such eminence as the two American gentlemen just mentioned. We regret we have not yet been able to devote the time to their contributions which their merits doubtless demand. Mr. Yarrow's paper on the aluminium torpedo boat he had built for the French Government, was a very interesting contribution. The boat appears to have been thoroughly successful, so much so that she is to be the prototype of a class. The discussion turned largely on the form of test pieces for copper alloys, it being generally conceded that there is a want of standard conditions for tests. The micro-sections of various alloys thrown on the screen were also very interesting.

The last day of the meeting (Friday) was devoted chiefly to the vibration question, the sitting proving one of the most instructive of the series. As will be seen, three papers were contributed on this important and interesting subject.

These three papers on vibration of steamers formed, with Sir William White's paper on steelliness, the two distinctive features of the meeting. It is hardly necessary to insist on the import-

ance of these two features in steam-ship performance, both of which affect alike the comfort of the passenger in mercantile vessels, and fighting efficiency in a war vessel. Since engine power has increased so greatly and speeds have been raised, the vibration question has become one of extreme importance in passenger steamers. Two of the most recent largest and costliest of our ocean liners were almost unfitted for carrying passengers—in any rate, they were fast acquiring an uneveable reputation—in account of excessive vibration. By the application of scientific principles the cause of this defect was traced, and the evil cured; a circumstance, if measured by money value, now worth many thousands of pounds to the owners. The extremely interesting paper and series of experiments performed two or three years ago by Mr. Yarrow, at a meeting of this Institution, will be remembered by our readers; and since then Herr Schlick has read two papers on the subject. Records of these will be found in previous volumes of NATURE. The seriousness of vibration in steam vessels is largely dependent upon the period of the hull as a structure synchronising with the beats of the engines, and thus it is that a vessel may vibrate excessively at speeds less than the highest speed she can attain. That is the elementary fact upon which a study of the problem is based. Herr Schlick, in his previous papers, has already considered the case of vibrations of the first order—that is to say, such oscillations of the longitudinal axis of a ship in a vertical direction as have two nodular points. Vibrations of this order claim most attention because they are most common, and are more violent than those of higher orders. It is in vessels with engines running at high speeds that vibrations of a higher order are sometimes observed. It would, as the author of the paper points out, be very advantageous if the naval architect could ascertain beforehand the position of the nodular points of a ship in getting out the design; but this, he is of opinion, cannot be done directly in a satisfactory manner. Mr. Mallock also enters into this question, as will be seen when we deal with his paper later on. As the question cannot be treated directly in a satisfactory manner in the case of a ship, Herr Schlick has recourse to the mathematical investigations of the vibrations of an elastic, prismatic rod. Such investigations have been made by several authorities, and the author quotes at some length the formulæ that have been constructed for vibrations of the first and higher orders. These it is not necessary to repeat.

It is evident that in a complex structure like the hull of a vessel, the vibrations will be of a very different nature to those of a prismatic rod. Treating only of vibrations of the first order—for the author has not yet succeeded in correctly ascertaining coefficients for the second order—Herr Schlick finds that in a ship they are at a greater distance from the ends than in a vibrating prismatic rod; a circumstance which is explained by the fact that a ship is less weighted in the ends than in the middle. For ships of very fine lines, the only class investigated, for vibrations of the first order the distance of the after nodular point from the after perpendicular is 0.231 to 0.253 times the length of the ship. The distance of the fore nodular point from the fore perpendicular varies from 0.310 to 0.365 times the length. The author had already shown that an ordinary engine with three cylinders cannot produce vibrations of the first order when the moving weights (pistons, &c.) of each cylinder are in such proportions to each other that the products obtained by multiplying these weights by the distance between the axis of the cylinder and the next nodular point are the same for all three cylinders. The same engine, therefore, will produce vibrations of the second order when the number of the revolutions increases accordingly. The new nodular point, moving away from the engine, causes the moments of the moving weights to be no longer equal to each other. The author considers, therefore, that as the nodular points can only be determined after the ship is completed, it is necessary to alter the moving weights of the engines in such a manner that their moments respecting the nodular point are made equal to each other. The vibrations will thus be considerably reduced, if not entirely avoided. The influence of the screw in producing vibration, owing to the impulses it imparts at the extreme end, is also discussed in this part of the paper; and the author then proceeds to deal with the so-called "horizontal vibrations," which he considers really consist of a twisting action on the ship's axis, due to the turning moment of the engines, acting on a screw, in the case of a single propeller. An

apparatus, constructed for the purpose, illustrated this fact by showing that the horizontal oscillations at the deck and bottom of the ship respectively are in opposite directions at the same instant of time. At a certain height above the keel there is no horizontal oscillation, this being therefore the *locus* of the axis of rotation. Maxima and minima of the turning moment at each revolution depend on the number of cranks, the amplitude of the oscillations being mostly dependent on steam distribution. These oscillations are periodic, and likewise have their nodular points. The author next proceeds to treat the points mentioned mathematically in the case of a prismatic rod. He shows that the number of vibrations is proportional to the speed of progress of vibration. Substituting a ship's body, he finds that this speed of progress remains constant for similar ships, and also that the number of torsional vibrations varies in an indirect proportion with the length of the ship. For a better understanding of these points, we must refer our readers to the original paper and the diagrams by which it is illustrated. That engines of special construction will cause no vibration if placed just above the nodular point, is also true for torsional vibrations.

Mr. Mallock, who, it may be stated, has done much excellent work for the Admiralty in connection with this subject, dealt in his paper with "the determination of the direction and magnitude of the forces and couples which arise from the unbalanced moving parts of marine engines." Something may be done, the author said, towards balancing an engine by the proper disposition of the pistons, connecting-rods, and cranks; but it does not seem practicable to produce a complete balance in any ordinary engine without having recourse to counterbalance weights. In order to determine the weights required, the author has produced a geometrical construction showing, by the aid of arithmetic only, the resultant force and couple due to the unbalanced moving parts of any engine. Without the aid of the diagrams shown at the meeting, it would be impossible to make the explanation clear, even if space permitted us to give the details in full. It will be sufficient to say that the engine is divided up into its component parts, to each of which a value is given, and in this way the resultant force is found and the resultant couple determined. Having got all the information necessary to assign the magnitude and direction of the force and couple which will completely balance the engine, if the force could be applied at the centre of gravity of the moving parts, it would merely remain to decide what weights should be used to produce the required effect. In general the construction of the engine makes this inconvenient, if not impossible, and other positions for the counterbalance weights must be found. This aspect of the problem is then considered in detail by aid of the figures.

The second part of the paper was devoted to showing how the frequency of vibration of any ship, loaded in any manner, can be found by models, and that all the data for shaping these models can be readily obtained from curves which would be in the hands of the ship designer. An example of the apparatus used was shown, the author giving a practical illustration of its working. The course pursued is to make an exact copy of the ship on a very small scale, exactly proportional in all dimensions and identical in material. It is known by theory that the frequency of vibration of the model and ship will be inversely proportional to their lengths. The model is replaced by an exact copy on the same scale, made of some other material—wood, the frequency of the new model differing from that of the former in the ratio

$$\frac{E_1}{E_2} \sqrt{\frac{L_2}{L_1}}$$

where  $E_1$  and  $E_2$  are the respective elasticities, Young's Moduli, and densities of the wood and the material of the model. Next the wooden model is replaced by a plank of the same wood of uniform thickness but variable breadth, the length being such that the stiffness of the plank against bending at every cross section is proportional to the stiffness of the model at the corresponding position. Weights are fixed to the plank in such a manner that the weight at any cross section is proportional to the weight at the corresponding section of the model. Then the frequency of the plank, compared with that of the model, can be ascertained by a formula.

In the apparatus shown the plank was supported by two rollers, one from two similar rollers, the latter resting on an electrically driven fly. The plank was kept vibrating by a magnetic motor, and a recording device was added. The rollers

supporting the plank gave the position of nodes. It is only when the rollers are at the positions where the nodes would be, if the plank was free from all constraint, that the frequency of the plank will be related to that of the ship as given by the author's formula. The natural nodes are found by varying the position of the rollers until the frequency is a maximum for the type of vibrations under consideration.

The method here introduced by Mr. Mallock is interesting and ingenious, but how far it is applicable to the needs of the naval architect, or whether the average ship builder, if he wish to reduce vibration, will prefer the former method of adjusting the engine to the known conditions of the ship after she is built, are questions which experience alone can decide.

The paper of Mr. Robinson and Captain Sankey dealt largely with the question of vibration in connection with electric light engines, the problem of vibration in the hull of a vessel being thus eliminated. Here again a number of diagrams were used which we cannot now reproduce, and our abstract of this paper must be therefore brief. Investigation showed that in the case of an electric light station the high speed vertical engines, each 200 indicated horse-power, with two cranks set opposite each other, and run at 350 revolutions per minute, were mounted on a large slab of concrete. The engines being vertical, the moving parts had to travel through a greater distance during the upper half of the revolution of the crank pin, than during the lower half. Calculation showed that each line of parts singly tended to lift the engine at up-stroke by about 3½ tons, and it tended to depress it 2½ tons. Therefore twice in a revolution a net lifting power of one ton acted upon the engine, and changed an equal number of times into a depressing power of about 1½ tons. The result was a "pumping action" on the water-soaked soil beneath the concrete slab, and in this way vibration was conveyed to surrounding buildings. The action, it will be seen, was due to the angular movement of the connecting rods, a feature which Herr Schliek said might be neglected; a point in which the authors, naturally, and also Mr. Mallock, by no means agreed with him.

An arrangement of two engines with their framings rigidly connected, and having three cylinders each, was proposed, the object being to neutralise the endways rocking or tilting tendency, and also to give freedom from tendency to vary the downward pressure.

A discussion followed the reading of these papers.

Mr. Hook's paper described a new way of carrying out a known investigation. Whether the new way is better than the old way, is a point which may be decided by experience. The last paper of the meeting, that by Mr. Martin, was of a disappointing nature. Marine engineers have long been asking for an explanation of the hitherto unexplained fact—if fact it be—that "in-duced draught" is so much better for boilers than "forced draught." Mr. Martin's experiments were quite beside the mark.

The summer meeting of the Institution will be held in Paris, commencing on June 11.

#### QUESTIONS BEARING ON SPECIFIC STABILITY.

AT the suggestion of your President, I beg to submit three questions to the notice of this Society. They bear on a theoretical problem of much importance, namely, the part played in evolution by "organic stability."

The questions are especially addressed to those who have had experience in breeding, but by no means to breeders only; nor are they addressed only to entomologists, being equally appropriate to the followers of every other branch of natural history. I should be grateful for replies relating to any species of animal or plant, whether based on personal observation or referring to such observations of others as are still scattered through the wide range of periodical literature, not having yet found a place in standard works. The questions are for information on:—

(1) Instances of such strongly marked peculiarities, whether in form, in colour, or in habit, as have occasionally appeared in a single or in a few individuals among a brood; but no record is wanted of monstrosities, or of such other characteristics as are clearly inconsistent with health and vigour.

A paper read at the Entomological Society, April 3, 1895, by Francis Galton, F.R.S.



(2) Instances in which any one of the above peculiarities has appeared in the broods of different parents. In replying to this question, it will be hardly worth while to record the sudden appearance of either albinism or melanism, as both are well known to be of frequent occurrence.

*Note.*—The question is *not* asked now, whether such peculiarities, or "sports," may be accounted for by atavism or other hypothetical cause.

(3) Instances in which any of these peculiarly characterised individuals have transmitted their peculiarities, hereditarily, to one or more generations. Especial mention should be made, whether the peculiarity was in any case transmitted in all its original intensity, and numerical data would be particularly acceptable, that showed the frequency of its transmission (*a*) in an undiluted form, (*b*) in one that was more or less diluted, and (*c*) of its non-transmission in any perceptible degree.<sup>1</sup>

It is impossible to explain to a general meeting the precise way in which the desired facts would be utilised. An explanation that would be sufficiently brief for the purpose could not be rendered intelligible except to those few who are already familiar with the evidence, and the technical treatment of it by which the law of Regression is established, and with the consequences and requirements of that law. Regressiveness and stability are contrasted conditions, and neither of them can be fully understood apart from the other.

I may as well take this opportunity of appending a list of my various memoirs on these subjects. They appeared from time to time in various forms as the inquiry progressed and as suitable openings occurred for writing or speaking. The more important of these are Nos. 1, 3, part of 6, 7, and 8 in the following list. Nos. 1 to 5 refer to regression only.

LIST OF MEMOIRS, BY MR. F. GALTON, ON REGRESSION AND ORGANIC STABILITY.

(1) Typical Laws of Heredity. *Journal of the Royal Institution*, 1877. (This was the first statement of the law of Regression, as founded on a series of experiments with sweet peas.)

(2) Presidential Address, Anthropological Section of the British Association, 1885. (Here the law of Regression was confirmed by anthropological observations.)

(3) Regression towards Mediocrity in Family Stature. *Journal of the Anthropological Institute*, 1885. (A revised and illustrated reprint of No. 2.)

(4) Family Likeness in Stature. *Proc. Roy. Soc.*, 1886.

(5) Family Likeness in Eye Colour. *Proc. Roy. Soc.*, 1886.

(6) Natural Inheritance. (Macmillan and Co., 1889.) (This volume summarises the results of previous work.)

(7) Patterns in Thumb and Finger Marks . . . and the Resemblance of their Classes to Ordinary Genera. *Phil. Trans. Roy. Soc.*, 1891.

(8) Discontinuity in Evolution. *Mind*, 1894. (An article on Mr. Bateson's work.)

A NEW DETERMINATION OF THE OHM.

A FRESH determination of the value of the ohm in absolute measure has been made by F. Himstedt (*Wiedemann's Annalen*, liv. p. 305). The method employed is that which the author had used in a previous determination, and consists of passing through a galvanometer all the make or break currents induced in a secondary coil when the current in a long primary helix is interrupted a known number of times per second. A known fraction of the primary current is then passed through the same galvanometer. The primary helix in these experiments consists of a single layer of uncovered copper wire, wound, by means of a screw-cutting lathe, in a regular spiral on a glass cylinder. The turns of wire are held in their place, and the insulation improved, by being coated with shellac. As the mean of a number of determinations, the author obtains the value 106.28 cm. as the length of the column of mercury at 0° C., having a cross section of one square millimetre, which has the resistance of 10<sup>9</sup> C.G.S. units. In connection with the above-described experiments, the author has been led to measure some coefficients of self-induction, using for this purpose a modification of the Rayleigh-Maxwell method. The great difficulty in measuring a coefficient of self-induction by this method is

that, in order to get a throw of sufficient magnitude to be accurately measured, it is necessary to employ a somewhat strong current. The result is that the temperature of the coil, the self-induction of which is being measured, rises rapidly, and thus the balance of the Wheatstone's bridge for steady currents is upset. Herr Himstedt gets over this difficulty by using the commutator, which he employs in his determination of the ohm, to break the battery circuit a known number of times per second, and to cut the galvanometer out of circuit while either the make or break is taking place. In this way a steady deflection is obtained of sufficient magnitude to be readily measured, even when the current employed is between 0.001 and 0.002 amperes. The above method only differs from that employed by Profs. Ayrton and Perry in their secohmmeter, in that the author takes two separate readings, one with the bridge balanced for steady currents, the other when the commutator is working, instead of bringing the galvanometer deflector to zero by upsetting the steady current balance.

THE SMITHSONIAN INSTITUTION REPORT FOR 1894.

MR. S. P. LANGLEY'S report of the operations of the Smithsonian Institution for the year ending June 30, 1894, has just reached this country, and it furnishes interesting reading on a number of points relating to the U.S. National Museum, the Bureau of Ethnology, the Bureau of International Exchanges, the National Zoological Park, and the Astrophysical Observatory.

The total permanent funds of the Institution are now 911,000 dollars, and interest at the rate of 6 per cent. per annum is allowed upon this by the Treasury, the interest alone being used in carrying out the aims of the Institution. The total receipts during the fiscal year covered by the Report amounted to 69,967 dollars, and the entire expenditure, including a sum of eight thousand dollars added to the permanent fund, was 67,461 dollars. The Institution also disbursed the Treasury grants of 14,500 dollars for International Exchanges; 40,000 dollars for North American Ethnology; 154,000 dollars for the U.S. National Museum; 50,000 dollars for the National Zoological Park; and 9000 dollars for the Astro-Physical Observatory.

It appears to be an essential portion of the original scheme of the government of the Institution that its secretary should be expected to advance knowledge, whether in letters or in science, by personal research; but the increasing demands of time for labours of administration has greatly limited the possibility of doing this. Mr. Langley has, however, found time to continue his researches upon the solar spectrum (see *NATURE*, November 1, 1894). This work, carried on in the Astro-Physical Observatory, is certainly of more than common importance. His investigations upon aerodynamics have also been continued intermittently. They are not complete, but they appear to point to conclusions of general and unusual interest.

A wide-spread interest seems to have been awakened in the Hodgkins competition, with reference to investigations appertaining to the nature and properties of atmospheric air. A letter printed in *NATURE* of June 21, 1894, announced that the time within which papers might be submitted was extended to the end of last year. The Report informs us that, up to June 30, 1894, 250 memoirs, printed and manuscript, had been received in connection with the competition, representing correspondents in the United States, Mexico, England, Scotland, Norway, Denmark, Russia (including Finland), France, Belgium, Germany, Austria-Hungary, Servia, Italy, and British India.

A few grants have been made from the Hodgkins Fund, in aid of certain important researches. In this connection we notice that Prof. E. W. Morley's work on the determinations of the density of oxygen and hydrogen, aided by special apparatus provided by the Institution, is approaching completion.

The investigations undertaken by Dr. J. S. Billings and Dr. S. Weir Mitchell into the nature of the peculiar substances of organic origin contained in the air expired by human beings, has been continued under a grant from the Hodgkins Fund, and also the researches by Dr. O. Lummer and Dr. E. Pringsheim, of Berlin University, on the determination of an exact measure of the cooling of gases while expanding, with a view to revising the value of that most important constant which is technically termed the "gamma" function.

Mr. Langley refers again to the unsatisfactory condition of the National Museum. The collections have increased so

<sup>1</sup> Written communications should be addressed to F. Galton, 42, Rutland Gate, London, S.W.

greatly that additional space is provided for their proper administration and exhibition, the efficiency of the Museum will be greatly improved; but though the collections are growing rapidly in all directions, they are not increasing as symmetrically and consistently as is manifestly desirable—a very common cause of complaint. A defect which calls for instant attention, however, relates to the most undesirable and largest storage of collections in wooden sheds, near the Smithsian building, and in the basement of the building itself, where large alcoholic collections in bottles containing, in the bulk, many thousands of gallons of alcohol, have been put away, as space cannot be found for the specimens in the Museum. It appears that a fire communicated to these rooms would sweep through the entire length of the building, and although the building itself is fireproof as against any ordinary danger, it may well be doubted whether any of the collections therein exhibited can be regarded as safe, if the rooms immediately below should be exposed to so peculiarly severe a conflagration as would be caused by the ignition of these large quantities of inflammable material. Such a calamity would affect the whole scientific world, and we trust that the appeal for a change of the present condition of affairs will not be disregarded.

The investigations relating to the ethnology of the American Indians were carried forward during the year, under the efficient control of Major J. W. Powell, the director, aided by Mr. W. J. McGee, ethnologist in charge, as executive officers. These researches of the Bureau of American Ethnology embrace the subjects of archaeology, descriptive ethnology, sociology, pictography and sign language, linguistics, mythology, psychology, and bibliography, and the results obtained during the year have never been exceeded in value.

The Smithsonian Exchange Service was inaugurated nearly half a century ago, with the object of carrying out one of the purposes of the founder of the Institution in the diffusion of that knowledge which the Institution itself helped to create. For this purpose it established correspondence with scientific men all over the world, until there is no civilised country or people, however remote, upon the surface of our planet, so far as is known, where the Institution is not thus represented. These correspondents have grown in numbers until at the present time those external to the United States alone number nearly 17,000. More than one hundred tons of books passed through the exchange office during the fiscal year 1893-94.

It was only five years ago since an appropriation was made for the National Zoological Park at Washington. The park has an area of nearly 167 acres, but there are as yet only four permanent buildings, while the animals number 510, of which 210 are of the larger size. Comparing this with similar establishments at other capitals, it is noted that the Gardens of our Zoological Society cover about 36 acres, are crowded with buildings, and that the magnificent collection of animals, some 2300 in number, is housed in a fairly comfortable manner. In Paris the portion of the Jardin des Plantes assigned to animals is a plot of ground some 17 acres in extent, crowded with 900 animals. In Berlin the portion of the Thiergarten appropriated for animal accommodation is about 60 acres. Fifteen hundred animals are accommodated and, necessarily, much overcrowded. In the United States the principal collections are in Philadelphia, where the grounds occupy about 40 acres, and the collection comprises 881 animals; in Cincinnati, where 36 acres are occupied with about 860 animals; and in New York, where the city maintains about 700 animals in Central Park, occupying an area of approximately 14 acres. In none of these collections are the grounds of sufficient size to give any extensive range for the animals.

Appended to Mr. Langley's general account of the affairs of the Institution and of its burdens, are the detailed and statistical reports from the officers in charge of the different branches of the work. The whole shows how very great and valuable is the work done in the United States for the increase and diffusion of scientific knowledge.

#### UNIVERSITY AND EDUCATIONAL INTELLIGENCE.

DR. GEORGE H. S. SARGENTON, F.R.S., has been appointed to the George Hart Chair of Physiology in University College, London.

DR. A. W. CROSSLEY, Berkeley Fellow, and Demonstrator of Organic Chemistry, in the Owens College, Manchester, has been elected Demonstrator of Chemistry in the Medical School of St. Thomas's Hospital, in succession to Dr. W. H. Ince, who has been appointed Government Chemist at Trinidad.

SIR DINSHAW MANOCKJEE PEET, BART., has, through the Principal, Mr. S. Cooke, offered to the Indian Government the sum of 5000 rupees towards the cost of providing residential quarters for Parsee students attending the College of Science at Poona.

THE Governors of Colfe's Foundation have selected Mr. F. W. Lucas to be Head Master of Colfe's Grammar School, Lewisham, from September next. Mr. Lucas is at present Head Master of Hipperholme Grammar School, Yorks, and was formerly Senior Assistant and Science Master at Roan School, Greenwich.

WE learn from the *Lancet*, that in accordance with the will of the late Dr. G. Y. Heath, Professor of Surgery in the University of Durham, and President of the University of Durham College of Medicine, the trustees of the Heath Scholarship, Prof. W. C. Arnison and Mr. Frederick Page, will award and pay to the writer of the best essay on Surgical Diseases of the Jaws the sum of £200. All graduates in medicine or in surgery of the University of Durham are eligible to compete for this prize. The essay must be typewritten or printed, and delivered to the trustees not later than March 31, 1896. The essay, together with any specimens, drawings, casts, microscopical preparations, or other means of illustration accompanying it, will become the property of the College of Medicine, Newcastle-upon-Tyne, but by permission the essay may be printed for general circulation by the Heath Scholar. Mr. Stephen Scott, of Harrogate, has generously presented to the College of Medicine the sum of £1000, which has been devoted, in accordance with Mr. Scott's wish, to founding a scholarship to promote the study of hernia and allied subjects. Any graduate in medicine or surgery of the University of Durham, or any student of the University of Durham College of Medicine is eligible to compete for the scholarship, provided that such student shall have had at least one academical year in attendance at the College, and that in any case his age does not exceed thirty years at the time when the essay is sent in. The competition takes place every year. Essays for this year's competition must be sent not later than July 31, 1895, to Prof. Arnison, University of Durham College of Medicine, Newcastle-upon-Tyne.

ON Friday last, Mr. Acland received a deputation at the Education Office, from the representatives of the Association of Head Masters, respecting the recent regulations which have been issued by the Science and Art Department with reference to organised science schools. After hearing the views of the deputation, Mr. Acland, in reply, said it was not desired to make an upheaval of the arrangements for these schools, but to join together in improving the method and the system on which the teaching was carried on. They were all agreed that to lessen too frequent examination, and to introduce the element of inspection, if reasonably carried on in a friendly spirit, would be of great value to these schools. One of the objects of the Department had been to make it clear that, besides the teaching of science, which was the primary object of these schools, they also desired fully to recognise the element of literature and the teaching of special subjects. In order to meet a point which had been raised, as to the change from the old system of organised science schools to the new, the closing words of the syllabus would be:—"Reasonable latitude will be allowed for two years in any departures which may be made from the prescribed course while the changes from the present to the new system are being brought about." Taking these words, together with the words in the earlier part of the syllabus, as to reasonable latitude being allowed to teachers as to the nature of the course which they might pursue, provided that the instruction was sound, satisfactory in amount, and combined with proper practical work, it would be seen that the Department had no intention of being too despotic, and that if really good and reasonable work was done under some more elastic system, these organised science schools would be found to even more benefit in the future than they had been in the past.

SCIENTIFIC SERIALS.

*The Mathematical Gazette*, No. 4 (Macmillan). This is the first number of the enlarged series. We are glad to find that the support accorded to the first year's issue has been sufficient to warrant this enlargement; but to make the *Gazette* a success, and not a drag upon the funds of the Association, it is imperatively necessary that a much larger measure of support should be rendered by the general body of mathematical teachers. The opening paper is one on algebra in schools, which was read before the Association at its annual meeting in January of this year. In this article the author, Mr. Heppel, drawing upon his wide experience as a "coach," states that when pupils have come to him he has found that the work in algebra has usually to be done all over again. The reason of this appears to him to be "the ever-growing divergence there is between the conception of the nature and objects of algebra that dominates school teaching and the conception that regulates the application of algebra to more advanced mathematics." Many of the suggestions are likely to be useful, and we commend them to the notice of our brethren in the craft of teaching. Mr. T. Wilson contributes a note on mathematics for astronomy and navigation, in which he suggests that the elements of spherical trigonometry might occupy a more prominent place in school teaching than they do, and to cover all ages he winds up with, "let no one despair that he is too old for mathematics."—Mr. Rouse adds a second chapter to his previous interesting article on conics.—"Some old text-books" is a review of John Ward's "The Young Mathematician's Guide" (1747), by Mr. J. H. Booker, which brings before us matter that was served up for the food of students in the time of "good Queen Anne." The rest of the number is taken up with more extended articles (than before) entitled notes, solutions, new questions, and titles of new books. These latter pages should be of general interest, as they are likely to be useful both to students and teachers.

*Bulletin of the American Mathematical Society*, series 20, vol. 1, No. 6, March 1895.—The notice of "Arthur Cayley," pp. 133-141, which opens this number, is a warm appreciation of the character and writings of our great mathematician, by Dr. Charlotte Scott, and is due to her "intense admiration for his work and personality, and to the fact that for the last fourteen years" she has "been privileged to know him and experience his kindness." It is the fullest account we have yet read, and has many more points of interest for an Englishman than Signor Briosebi's *Hagi*, which is naturally confined more closely to an appreciation of his mathematical work. One extract we must make:—"Any sketch of Prof. Cayley is self-condemned if it leaves out of account the child-like purity and simplicity of his nature, the entire freedom from the professional touchiness on the score of priority to which mathematicians are as liable as other men. He was ever ready to say what he was working at, to indicate the lines of thought, to state what difficulties he was encountering . . . but his greatness and his simplicity cannot be enshrined in anecdotes."—Prof. Osgood (pp. 142-151) on "The Theory of Functions," analyses, chapter by chapter, Dr. (now Prof.) Forsyth's brilliant work on "The Theory of Functions of a Complex Variable," and winds up thus:—"The book is not one that can safely be put into the hands of the immature student for a first introduction to the study of the theory of functions. But the student who is already familiar with the elements, and who has acquired some degree of critical power, will find its pages incentive to valuable work in this wide field."—A short note follows on the introduction of the notion of hyperbolic functions, by Prof. Haskell, which was read before the Society at its December (1894) meeting.—The second summer meeting of the Society is to be held at Springfield, Mass., on August 27.

*Internationaler Archiv für Ethnographie*. Band vii. Heft iv. 1894. This part commences with a long and thorough study (in German) on the hair-cutting customs of the Southern Slavs, by Friedrich S. Krauss. Several songs are reproduced in the

original, which are also translated into German. In this study two elementary ideas of mankind are met with, but imbued with the local colour of the Southern Slavs, and varied in tint according to the stage of culture. Hair cutting is a means of adoption into kin-ship, and also as a redemption from the sacrifice of the body or life to the spirit of disease. It is a rite performed for social obligations and for good luck.—Prof. P. J. Veth concludes his exhaustive account (in Dutch) of the Mandrake, which is a valuable contribution to signature-lore or sympathetic magic. The most interesting of the "Notes" is an illustrated communication by A. Hermann, on the cupping and blood-letting appliances of the wandering gypsies.

SOCIETIES AND ACADEMIES.

LONDON.

Royal Society, March 21.—"On the Dielectricity of Air." By Lord Kelvin, P.R.S., Magnus Maclean, and Alexander Galt.

§ 1. The experiment described in § 14 of our paper on the "Electrification of Air and other Gases by bubbling through Water and other Liquids" (*Roy. Soc. Proc.*, February 21, 1895), proves that air, electrified negatively by bubbling through water and caused to pass through a metallic wire gauze strainer, gives up some, but not a large proportion, of its

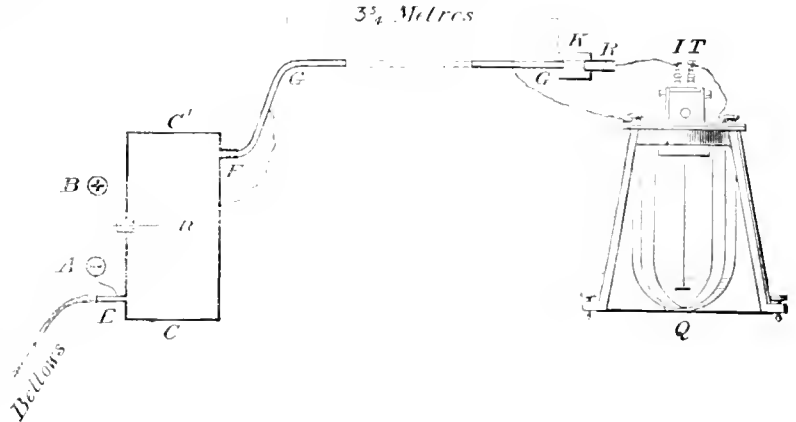

FIG. 1.

electricity to the metal. We have now made a fresh experimental arrangement for the purpose of investigating dielectricity of air which has been electrified, whether positively or negatively, by other means than bubbling through water: with apparatus represented in Figs. 1 and 2, which is simplified from that of our former paper by the omission of the apparatus for electrification by bubbling, and for collecting large quantities of electrified air.

§ 2. In Fig. 1, A B represent the two terminals of a Voss electric machine connected, one of them to a metal can, C' (a small biscuit canister of tinned iron), and the other to a fine needle, of which the point *n* is in the centre of the can. The wire making the connection to the needle passes through the centre of a hole in the side of the can, stopped by a paraffin plug. Air is blown from bellows through a pipe, E, near the bottom of the can, and allowed to escape from near the top through an electric filter, F, called the tested filter, from which it passes through a long block-tin pipe, G G, about  $3\frac{1}{4}$  metres long and 1 cm. internal diameter, and thence through a short tunnel in a block of paraffin, K. From this, lastly, it passes through a second electric filter, R, into the open air. This second filter, which we sometimes call the testing filter, sometimes the electric receiver, is kept in metallic connection with the insulated terminal, *t*, of a quadrant electrometer, O. The metal can and the block tin pipe are metallically connected to the outer case and uninsulated terminal, T, of the quadrant electrometer.

§ 3. The testing filter or electric receiver consists of twelve discs of brass-wire cloth fixed across the mouth of a short metal pipe supported on the end of the paraffin tunnel in the manner

represented in Fig. 2, on a scale of twice the size of the filter which we have actually used, *r* of true size for a filter on a tube of 2 cm. diameter, which for some purposes may be better. The eleven similar discs, of size adapted to a tube of 2 cm. diameter, and an outermost disc with projecting lugs, are shown, true size, and with the gauge of the wire-cloth which we have actually used, shown true size, in Fig. 3. The seven little circular discs of wire cloth are held in position by sliding over them the four lugs belonging to the outermost disc, and all are kept compactly together by a short piece of

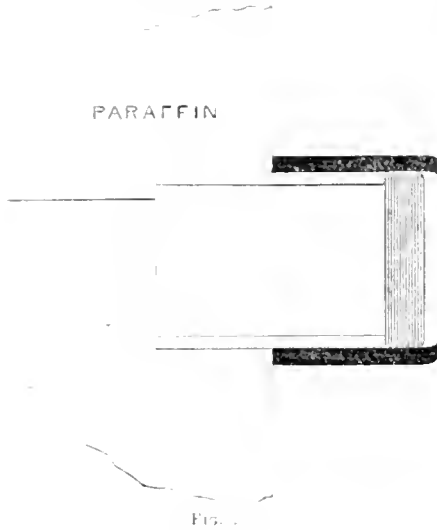

FIG. 2.

India-rubber tube stretched over them outside, as shown in Fig. 2.

§ 4. We commenced with a few experiments to test the efficiency of the testing filter, *K*, with no tested filter at *F*, and merely continuous block-tin pipe, *E* & *G*, from the can to the paraffin tunnel. First, working the bellows with no electrification of the needle point, we found no sensible electric effect on the electrometer, which proved that, whether from natural electrification of the air of the laboratory, or by the action of the bellows, or by the passage of the air through the long metal pipe, no electrification sensible to our test was produced. After

began with a filter of 12 wire-gauze discs, placed at *F* and kept in metallic connection with the tin pipe outside. This nearly halved the electricity shown by the electrometer. We then tried 24, 48, 72, 96, 120 wire-gauze discs, successively, placed in groups of 24, and separated from one another by short lengths of 2 cm. of lead tube, in the line of the flow of the air between *F* and *G* (Fig. 1), all kept in metallic connection with the block-tin pipe and the outer case of the electrometer. We were surprised with the smallness of the additions to the dis-electrifying efficiency of the 12 strainers first tried: for example, the filter of 120 wire gauzes only reduced the electrical indication to a little less than one-half of what it was with the 12 which we first tried.

We found that cotton-wool between the spaces in the groups of 24 wire gauzes largely increased the dis-electrifying effect. Thus, with 72 wire gauzes and cotton-wool we succeeded in reducing the electrical effect to about one-twelfth of what it was with only a filter of 12 wire gauzes; but hitherto we have not succeeded in rendering imperceptibly small the electricity yielded by the outflowing air to the testing filter *K* in our method of observation.

§ 6. We intend trying various methods of obtaining more and more nearly complete dis-electrification of the electrified air flowing out of the can at *F*; and this for air electrified otherwise than by the needle point, as shown in the diagram: for instance, by an electrified flame in place of the needle point; or again by bubbling through water or other liquids. Meantime, the mere fact that the electricity, whether positive or negative, given to air by an electrified needle point, can be conveyed through 3 or 4 metres of small metal tube (1 cm. diameter), and shown on a quadrant electrometer by a receiving filter, is not without interest. We may add now that, with the receiving filter removed and merely a fine platinum wire put in the mouth of the paraffin tunnel, we have found that enough of electricity is taken from the outflowing air to be amply shown by the quadrant electrometer; which renders even more surprising the fact that the dis-electrifying power of 120 strainers of fine wire-gauze should be so small as we have found it.

"On the Question of Dielectric Hysteresis." By Alfred W. Porter and David K. Morris.

The experiment described was intended to test whether the dissipation of energy that occurs in the dielectric of a condenser is due to true hysteresis (as claimed by Riccardo Arnò), or simply to viscosity. To discriminate between them it is essential that the condenser be put through a cyclic series of states at such a slow rate that all viscous effects shall have had time to subside before a measurement of the charge corresponding to a certain potential difference is made. It is essential also to arrange



FIG. 3. Diagram of the filter, *K*, of diameter of each which has been actually used.

the needle point, *a*, to be either positively or negatively electrified, at a time, by turning the little wheel, and we found large differences amounting to about 34 per cent. in the positive or negative, according as *a* was positively or negatively.

§ 5. We are now ready to test the efficacy of filters of various kinds placed at *F* for the purifying air which has been electrified, whether naturally or by the electrified needle point *a*. We

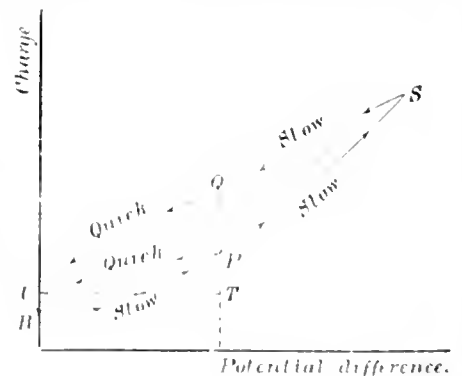

FIG. 1.

that any test of the charge which involves a change of state should itself form part of the cycle. This was accomplished by making the cycles as shown in the figure, the cyclic order being P, Q, R, P, Q, R; the portions P, Q and Q, R representing discharges through a galvanometer. If hysteresis exists, the change of charge Q, T will be greater than the change P, T. As the result of twelve cycles the ratio Q, T/P, T comes out 1 - 8700; a second series of twelve gives 1 - 10350.

Hence the charge is sensibly the same for a given value of the potential difference, whether that value has been arrived at from lower or from higher values than itself.

Fresh evidence is also given of the presence of viscosity.

Thus while the condenser here experimented upon exhibits marked viscous effects, yet the authors could detect no hysteresis.

**Entomological Society, April 3.**—Prof. R. Meldola, F.R.S., President, in the chair.—Mr. C. J. Gahan exhibited two examples, male and female, of a rare Prionid beetle, *Charax cyanea*, Serville, which had been kindly sent to him for examination by M. René Oberthur; and stated that Lacordaire was mistaken with regard to the sex of the specimen which he described in the "Genera des Coléoptères." He pointed out that the elytra of the male were relatively much shorter than those of the female; and that the joints of the antennæ from the third to the tenth were biramous. Mr. Gahan also exhibited two species of the genus *Decarthria*, Hope, and said he believed these were the two smallest species of Longicorns known.—Dr. Sharp, F.R.S., exhibited the soldiers and workers of a species of Termites found by Dr. Haviland in South Africa. He stated that these insects possessed eyes and worked in daylight like Hymenopterous ants, and that in habits they resembled harvesting ants by cutting grass and carrying it into holes in the ground. Dr. Sharp said that although these holes were probably the entrance to the nests, Dr. Haviland was unable to find the actual nest, even by prolonged digging, so that the winged forms were still unknown. He thought this species was probably allied to *Termes viarum* of Smeathman, in which the soldiers and workers possessed eyes, and had been observed by Smeathman to issue from holes in the ground, but whose nests could not be discovered. Mr. McLachlan observed that it was possible there might be species of Termites without any winged form whatever.—Mr. Rye called attention to the action of one of the Conservators of Wimbledon Common, who, he stated, had been destroying all the aspens on the Common. He inquired whether it was possible for the Entomological Society to protest against the destruction of the trees. Mr. Gos said he would mention the matter to the Commons' Preservation Society.—Mr. Francis Galton, F.R.S., read a paper entitled "Entomological Queries bearing on the Question of Specific Stability." (See p. 570.)—Mr. Merrifield stated that he received some years ago, from Sheffield, ova of *Selenia illustraria*, the brood from which produced, in addition to typical specimens, four of a dark bronze colour, and from these he bred a number of specimens of a similar colour.—Dr. F. A. Dixey referred to a variety of the larva of *Saturnia carpi* with pink tubercles. He said the imago bred from this larva produced larvae of which 10 per cent. had pink tubercles. Prof. Poulton, F.R.S., said he had found larvae of *Smerinthus ocellatus* with red spots, and that this peculiarity had been perpetuated in their descendants. Mr. McLachlan, Canon Fowler, and Prof. Meldola made some further remarks on the subject.—Mr. G. F. Hampson read a paper by Mr. C. W. Barker, entitled "Notes on Seasonal Dimorphism in certain species of Rhopalocera in Natal." Mr. Merrifield said he was of opinion that a record of the temperature at different seasons would be a very desirable addition to observations of seasonal dimorphism. Mr. Hampson said he believed that temperature had very little to do with the alteration of forms. At any rate, according to his experience, in India the wet season form succeeded the dry season form without any apparent difference in the temperature. Prof. Poulton remarked that the apparent temperature as felt must not be relied upon without observations taken by the thermometer. Dr. Dixey, Mr. Barrett, Dr. Sharp, and Prof. Meldola continued the discussion.

**Zoological Society, April 2.**—W. T. Blanford, F.R.S., Vice-President, in the Chair.—Mr. Boulenger exhibited the type specimens of two new chameleons from Usambara, German East Africa. Special interest attached to them from the fact that they appeared to be more nearly related to the Madagascar species than to any of the numerous forms now known from Continental Africa.—Mr. Walter E. Collinge read a paper on the sensory canal system of fishes, treating of the morphology and innervation of the system in the Physostomous Teleostei.—Dr. Mivart, F.R.S., read a paper descriptive of the skeleton in *Lorius flavopallidus*, comparing it with that of *Psittacus erithacus*, and pointed out a number of differences in detail.—Mr. G. A. Boulenger, F.R.S., made remarks on some cranial characters of the salmonoid fishes, and expressed the opinion that there was no justification for separating *Coregonus* and *Thymallus* from the Salmonidæ, as had been proposed by Cope

and Gill.—Prof. T. W. Bridge read a paper in which he pointed out certain features in the skull of *Osteoglossum*. The author directed attention to the existence of a peculiar oral masticatory mechanism in *Osteoglossum formosum*, distinct from that furnished by the upper and lower jaws and their teeth. The existence of an essentially similar mechanism in the Ganoid *Lepidosteus osseus* was also described, and the conclusion suggested that the two genera offer in this respect an interesting example of parallelism in evolution.

**Linnean Society, March 21.**—Mr. C. B. Clarke, President, in the chair.—Prof. Stewart exhibited and made remarks upon a series of corals, dwelling upon certain characteristic features which illustrated their structure.—Mr. S. Pace brought forward a collection of shells belonging to the genus *Columbella*, and made some observations concerning the peculiarities and the geographical distribution of some of the species exhibited. A paper was then read by the President, "On the terminal flower in the *Cyperaceæ*." After remarking that the order *Cyperaceæ* had been newly arranged by Dr. Pax in Engler's "Jahrbücher" (1886), and in Engler and Prantl's "Pflanzenfamilien," the character taken for primary division of the order being the inflorescence, he pointed out that in the first sub-order *Stirpoides* with an axillary flower were placed *Cyperus*, *Scirpus*, *Psilocarya*, *Dichromena*, and *Hypolytrum*; in the second sub-order *Caricoideæ* with a terminal flower were placed *Schenus*, *Rynchospora*, *Mapania* and also *Carex*, *Scleria*, and their allies. The disruption of *Hypolytrum* from *Mapania*, of *Dichromena* and *Psilocarya* from *Rynchospora*, he thought, proved either that the modern method pursued by Dr. Pax was of limited systematic value, or that he had grievously erred in his ascertainment of the fact whether in such genus the flower is terminal or not. Mr. Clarke exhibited his own analyses of the spikelet in the larger genera in dispute. He held that in *Carex*, *Scleria*, and their allies, the flower, male and female, was strictly axillary; that in *Rynchospora* it was axillary—exactly as in *Dichromena* and *Psilocarya*—while in *Hypolytrum* the flower is terminal exactly as in *Mapania*. He further maintained that these facts could be sufficiently shown by the aid of a penknife and pocket-lens, and that no results which might be hereafter obtained by studies in development could affect either the weight to be attributed to the character of "terminal flower," or to the real affinities of the genera. The paper was illustrated by lantern slides illustrating dissections, and, in the discussion which followed, criticism was offered by Sir D. Brandis, Mr. A. B. Renfrew, Dr. Prain, and Dr. D. H. Scott.—On the conclusion of this paper, Dr. H. Field, of Brooklyn, New York, made some remarks on the proposed establishment of a central international bureau for zoological bibliography, and the annual publication of an international Zoological Record.

**Mathematical Society, April 4.**—Major MacMahon, R.A., F.R.S., President, in the chair.—The Rev. T. C. Simmons read a paper on a new theorem in Probability. The author replied to numerous questions put to him by Messrs. G. H. Bryan, Burton, Cunningham, and the President.—The President (Mr. Kempe, F.R.S., in the chair) communicated a note on the linear equations that present themselves in the method of least squares.—The following paper was taken as read: On the Abelian system of differential equations and their rational and integral algebraic integrals, with a discussion of the periodicity of Abelian functions, by the Rev. W. R. W. Roberts.

**Geological Society, March 20.**—Dr. Henry Woodward, F.R.S., President, in the chair.—On fluvioglacial and interglacial deposits in Switzerland, by Dr. C. S. Du Riche Preller. This paper is the outcome of one published in the *Geological Magazine* of January 1894, on the "Three Glaciations in Switzerland," in which the author described various glacial deposits near the lake of Zurich. He now describes a series of fluvioglacial conglomerates and interglacial lignite-deposits near the lakes of Zurich, Constance, Zug, and Thun, which, together with analogous deposits at the base of the Eastern, Western, and Southern Alps, constitute further evidence of two interglacial periods, and therefore of three general glaciations, the oldest of these being of Upper Pliocene, and the others of Middle and Upper Pleistocene age respectively. As regards the origin, age, and the time required for the formation of several of the Swiss deposits referred to in the paper, the author arrives in several respects at conclusions differing from those



THURSDAY, APRIL 18, 1895.

## THE EXPERIMENTAL PHYSIOLOGY OF PLANTS.

*Practical Physiology of Plants.* By Francis Darwin, M.A., F.R.S., and E. Hamilton Acton, M.A. Cambridge Natural Science Manuals, Biological Series. (Cambridge: University Press, 1894.)

THE physiological course which Mr. Francis Darwin gave at Cambridge in 1883, was the first systematic effort, in this country, to teach the phenomena of plant-life to students by means of actual experiments. As we are told in the preface to this book, the experiments were at first demonstrated in the lecture-room; some years later, the students were required to do the practical work for themselves in the laboratory. The example set at Cambridge has been followed in other universities and colleges, to the great benefit of botanical teaching. We all recognise now that practical laboratory work is no less necessary in physiological than in morphological botany, though in the former it is certainly more difficult to organise. The present book, which embodies the results of the experience gained in practical teaching, is in two parts. Part i., on General Physiology, is the more elementary, and therefore the more widely useful; Part ii., on the Chemistry of Metabolism, is of a more advanced character, and is adapted to those students who desire to make a special study of the chemical physiology of plants. The former, we believe, is mainly the work of Mr. Darwin; the latter, of Mr. Acton.

A volume of this kind was very much needed, and it is a matter for congratulation that the work has fallen into the most competent hands. There was nothing of the kind in English before, and the book will be of the greatest service to both teachers and students. It must be clearly understood that it is a strictly practical laboratory guide, which can only be used by those who are willing to experiment for themselves. The volume is in no sense a treatise on physiology, and thus differs from its German predecessor, Detmer's "*Pflanzen-physiologisches Practicum*," which is to some extent a compromise between a practical guide and a theoretical text-book. The thoroughly practical character of Messrs. Darwin and Acton's book seems to us a great merit; every word in it is of direct use to the experimental worker, and to him alone.

We cannot attempt to give anything like a summary of the contents of the work, which, in spite of its moderate bulk, covers a great deal of ground. Thus in part i. alone, no less than 265 distinct experiments are described. Of course they vary very much in character, some being quite simple and elementary, while others are more of the nature of original research. It goes without saying that a large proportion of the experiments are of Mr. Darwin's own devising, and that nearly all have been practically tested by the authors. Wherever this is not the case, the reader is told so; and if the

experiment is, from any cause, at all likely to fail, he is warned of the possible disappointment. The candour with which the student is treated all through, is a very pleasant feature of the book.

The first chapter is on some of the conditions affecting the life of plants, and as the presence of oxygen is among the most important of these conditions, respiration is taken first. Besides the more usual experiments, ingenious demonstrations of intramolecular respiration, and of the excessive consumption of oxygen by germinating oily seeds, are given.

In the second chapter assimilation takes the first place, and many beautiful experiments are described, including Gardiner's ingenious modification of Sachs's iodine method, in which the sun is made to print off, in starch, a copy of a photograph, from a negative placed on the leaf. An experiment proving that excess of carbon dioxide stops assimilation, is especially interesting. When a second edition is called for, Mr. Blackman's new and important experiments on the function of stomata will no doubt find a place.

In the next chapter, which is also concerned with nutrition, particularly good and complete directions are given for the management of water-cultures; these are quite the best we have met with, and will save the experimenter from many failures. The use of Duckweed (*Lemna*) for demonstrating the effect of various food-solutions on growth, is, we believe, new, and is a very neat method. The same chapter includes experiments on the nutrition of the carnivorous plant, Sundew, a subject on which Mr. Darwin's investigations have become classical.

The question of the movement of water in plants is still unsolved. The data of this problem, however, are very thoroughly taught, by means of the experiments described in the sections on the functions of roots, and on transpiration. The latter process is investigated, in the first instance, by means of the potometer, an instrument devised by Mr. Darwin and his pupil Mr. Phillips, in which the speed of the transpiration-current is measured by the rate of ascent of an air-bubble, which is drawn up a capillary glass-tube by a transpiring shoot connected with it.

A particularly ingenious experiment is one in which the hygroscopic twisting and untwisting of an awn of the grass *Stipa*, is made use of as an index of transpiration.

A chapter on physical and mechanical properties treats of such phenomena as imbibition, turgor, osmosis, and the tensions of tissues. It may be pointed out that in the description of Traube's artificial cells, copper sulphide is evidently a misprint, either for copper chloride, or sulphate (p. 111).

The next chapter is on growth, and contains, among many other things, full directions for the use of the various kinds of auxanometer.

The remaining chapters are concerned with curvatures (geotropism, heliotropism, traumatic curvature, &c.), and with other movements. Some of the most fascinating experiments come in this part; we will only mention those on the decapitation of roots, an operation which, as Charles Darwin discovered, prevents the root from perceiving the geotropic stimulus, though it does not hinder

the curvature of the growing region which may have been induced by a previous stimulation. Attention is here called to the brilliant experiments of Prof. Pfeffer, which have demonstrated conclusively that the tip of the root is alone sensitive to gravitation, thus finally confirming the conclusion drawn by Darwin from less decisive experiments. The announcement of this discovery by Prof. Pfeffer was one of the most interesting incidents in the Biological Section at the Oxford meeting of the British Association.

A self-recording method for studying the sleep-movements of leaves, strikes us as especially valuable.

The second part of the book, on the chemistry of metabolism, is of quite a different character from part i., and is evidently intended for students with an advanced chemical knowledge, who alone can make intelligent use of it. The object aimed at is sufficiently explained in the opening paragraph :

"The practical study of the transformations which plastic substances undergo in metabolism, is an application of organic chemistry: the immediate problem is generally to determine whether certain substances are present or absent, and, if present, in what amounts in particular tissues."

The mode of determination of all the important organic bodies occurring in plants, such as protein, amides, oils, carbohydrates, tannins, acids, and enzymes, is concisely explained.

There are two appendices, the first of which gives examples of quantitative results obtained in actual experiments, in order to show the degree of accuracy which may fairly be expected; the second is a list of reagents.

Within the short space of ninety small pages, which is all that the second part occupies, it is obviously impossible to give full instruction in such a difficult and complicated subject as the practical physiological chemistry of plants. Those, however, who are already good chemists, will no doubt derive great help from the terse directions given here, especially as these are supplemented by abundant references to the more special literature.

The authors are much to be congratulated on their work, which fills a serious gap in the botanical literature of this country. We think it very desirable that a smaller edition of the book should be published for use in schools, bearing somewhat the same relation to the present handbook as Prof. Bower's "Practical Botany for Beginners" bears to his larger manual on the same subject. It is most important, now that physiological botany is supposed to be taught in so many schools throughout the country, that it should really be taught in the only efficient way, namely by experiment, and that it should no longer be made a mere matter of "cramming," as is now too often the case. A selection from the present book of the simplest and most fundamental experiments, such as could be performed with tolerable certainty of result in ordinary science-schools, would, we are sure, be of the greatest service to conscientious teachers, who desire to make their scientific instruction

D. H. S.

### MUSSEL CULTURE.

*Mussel Culture and the Bait Supply, with reference more especially to Scotland.* By W. L. Calderwood. (London: Macmillan and Co., 1895.)

THIS little book has been written for the useful purpose of calling public attention to the urgent need of an increased supply of mussel bait in the interests of the line fishermen, and in order that the food supply of the country may be increased. It does not contain new facts, but it summarises many old ones, and puts the results of some biological inquiries in a form in which they will be readily available for consultation by members of County Councils and others who ought to be interested in fish-culture. The general conclusion arrived at is one which has been recently pointed out in the pages of NATURE, viz. that a systematic cultivation of our foreshores, such as is now carried on in several European countries—notably France and Holland—must soon be resorted to if we wish to stop the rapid depletion of our shellish beds.

Sixty years ago the supply of mussels for bait must have seemed almost inexhaustible, but now that larger boats with more men and much longer lines are employed, the supply of bait is rapidly failing at many places round the coast, with the result that we have to import at considerable expense large quantities of mussels annually from Holland. The fact that it is necessary thus to import a mollusc which grows naturally in great abundance on our own shores, is in itself significant of the mismanagement—or total absence of management—of our bait beds in the past. Mr. Calderwood gives an account of the various mussel scalps or beds round the Scottish coast, describes their former extent and their present condition—in most cases a sad story of wicked waste resulting in woful want—and says: "We have seen our public oyster fisheries slowly decline, and all but expire; we now are watching our mussel beds as they diminish in the same way."

It is a pleasant relief to notice that some few beds really are regulated and well managed, with the result that they are in a flourishing condition. For example, those at Montrose, where "the grounds now under cultivation were at one time all but destitute of mussels, but by the exertions of the Ferryden and Usan Society of Fishermen, led by Mr. James Johnston, 'seed' was collected and bedded, and the system of cultivation adopted which has since yielded such excellent results" (p. 24). The interesting account of the enterprise of the fishermen at Nairn, in experimenting with mussel culture on their own account, shows how readily new beds may be formed and important results obtained. If such work is to be done, however, to any great extent, we must adopt the French system of renting, on easy terms, the sea-bottom and foreshore to such individuals as will cultivate the beds, and so render them of increased value to the country.

We are reminded by Mr. Calderwood, as a proof of the enhanced value of bait, that the sands of Dun, in Scotland, which were not considered by the fishermen to be worth £5 a year at the beginning of the century, are now let for £500 per annum. Of



the various baits for the long lines—mussel, scallop, squid, lugworm, whelk, cockle, &c.—mussel is the most generally distributed, the most easily grown, and altogether the most serviceable and important. The Mussel Commission stated in 1889 that “nearly all the 50,000 fishermen of Scotland use mussels as their bait during some part of the year.” It has been calculated that the fishing lines used in Scotland in 1893 would, if tied together, nearly encircle the world twice, and probably about 47,000,000 hooks have to be baited (each with two mussels) every time all the lines are set. These statements give some rough idea of the magnitude of the demand for this bait. If squid could be obtained in sufficient quantity, it would probably be even more valuable than mussels, but its price is usually prohibitive to most fishermen. A fishing firm in Aberdeen paid during this last winter over £200 for squid bait for a single boat’s lines for the three months October to December, and there are fifty to sixty of such boats north of the Tyne.

One section of this book gives a short account of the anatomy, and the reproduction, and an outline of the development of the mussel. Most of this is very simple; but it is not easy to understand the following statement (p. 44), where, speaking of the kidneys, Mr. Calderwood says: “Two internal openings also communicate with the cavity in which the heart is situated, and in this way the organ has a more powerful action in aerating the blood!” Whether “the organ” in question is the heart or the kidney is not very clear, and in either case the statement is equally mysterious.

As a single female mussel produces two or three million young, and as innumerable young mussels all round our coast perish miserably every year for want of suitable objects to attach to, there can be no reasonable doubt that the judicious erection of simple stakes, or “bouchots,” would serve a useful purpose, at any rate in the collection of seed, even if the further rearing be carried on by means of the bed system. The importance of transplanting, of cropping the beds by rotation, of exterminating enemies such as starfish and whelks, and of avoiding overcrowding, is pointed out; and we are reminded of the opinion of Prof. McIntosh, endorsed by the Scottish Fishery Board, that “if properly and wisely managed, a mussel fishery will rapidly repay the small initial expense, and might, indeed, be made largely profitable.”

The book concludes with a chapter on the legal aspects of the matter, extracts from the Acts in regard to mussel fisheries, and information on the methods of obtaining fishery “orders” in England, Scotland, and Ireland. Some of these legal processes seem unnecessarily complicated and expensive, and it is certainly unfortunate that our local fishery committees can make regulations in regard to their mussel beds, but cannot improve them by cultivation; and yet in parts of England the mussel is even more important than in Scotland, as it is used not merely as bait, but very largely as food in some districts. The book seems singularly free from typographical errors—a curious slip on p. 11 suggests that the author’s mind was so full of his subject that he has mis-spelled Mr. Bateson’s name. W. A. H.

#### HISTORICAL EPIDEMIOLOGY.

*A History of Epidemics in Britain.* By Charles Creighton, M.A., M.D. Vol. ii. From the Extinction of the Plague to the Present Time. (Cambridge: University Press, 1894.

THE first volume of this work was reviewed in these columns about three years ago, and Dr. Creighton has now brought his difficult task to completion. The labour of disentangling the facts of epidemiological history from the scattered chronicles in which they lie hidden is very considerable, and, when this is accomplished, the historian is further confronted with the difficulty of identifying, under the confused nomenclature of by-gone days, the various pestilences described, and of assigning to them their proper place in modern nosology.

Dr. Creighton has undoubtedly earned the thanks of all students of epidemiology for the painstaking and laborious compilation of facts and references which he has brought together in the present volume. The magnitude of the labour has been immense—the more so since, as the author remarks in the preface, he has had little help from predecessors in the same field. He has at times incorporated with the strictly historical portions of the work ætiological considerations which, we fear, will hardly commend themselves as of equal merit with the rest; these, however, form but a small part of the whole, and though they call for comment, should not be allowed to interfere with our appreciation of the value of the book.

The opening chapter deals with typhus and other continued fevers, and its historical interest is very great. It well illustrates the close connection which exists between the epidemic prevalence of this group of diseases, and the physical environment and social conditions of the population, nor could an instructive lesson in hygiene have been better presented. It is interesting, too, to trace the gradual rise of more exact pathological notions, whereby the old medley of spotted, putrid, miliary, and comatose fevers has been resolved into our modern typhus, enteric, and relapsing fevers. The grouping together of influenzas and “epidemic agues” in another chapter seems warranted by the etymology of the term ague (Latin: *acutus*), the expression being used in early times for any sharp fever: the term “influenza” did not reach England till 1743.

Small-pox naturally receives a full measure of attention. The statements put forward to show that during the seventeenth century the mortality from this disease had not that excessive incidence on infants which afterwards became the rule, are not, in the necessary absence of any statistical evidence, sufficiently convincing. The history and practice of inoculation are treated of at great length, and the account is full of interest. Dr. Creighton’s opinions on the subject of vaccination are well known, and it is a pity that in a purely historical work, any bias should have been allowed to appear. He has perhaps done his best to avoid it by treating vaccination, after the year 1825, as “*ex hypothesi* irrelevant,” though this proceeding may raise a smile on the faces of many of his readers. Even in the preface the assumption that variola

and vaccinia are two perfectly distinct diseases, calls for some comment: in the light of recent investigations, and the omission of any reference to the statistics of the Sheffield epidemic of 1887-8 is a serious blot on any work dealing with the history of small-pox. The immunity from small-pox which infants and children enjoy at the present day, receives the not very satisfying explanation that they now have measles, whooping-cough, scarlatina, and diphtheria instead!

In the later chapters the author deals with the last-mentioned diseases and with infantile diarrhoea, dysentery and cholera, the history of which is traced with great care and accuracy. It would indeed be difficult to praise too highly the pains which the author has taken in the collection and arrangement of his historical facts. But he has chosen to add, in many places, considerations as to the nature and causes of the diseases he chronicles, which frequently do not cover all that is known about the subject, and would have been better omitted or treated separately from the historical portions of the book. It is true that, in some cases, there are strong reasons for believing that the virus of a disease may reside in the soil, but it is by no means true for others. It is true that we are ignorant of the precise nature of the virus of many of the diseases discussed in the book; but it is not the case with all. Yet in no single passage dealing with aetiology do we find any reference to even well-established bacteriological facts. It may be that much studying of the records of the past begets a tendency to a mediæval frame of mind. Certainly Dr. Creighton's views on telluric influences will not commend themselves to the modern pathologist, though, like the subjects he treats of, they may possess a historical interest.

But it is a great merit of the book that it can be read with pleasure and instruction by all, however the reader may differ from the author in pathological creed; and Dr. Creighton may be congratulated upon the completion of so excellent and thorough a history of epidemic diseases in this country.

#### OUR BOOK SHELF.

*Grundzüge der mathematischen Chemie.* Von Dr. G. Helm. (Leipzig: Wilhelm Engelmann, 1894).

THE treatment of the subject-matter of this book is based on the view that in its present state of development, that branch of physical chemistry which relates to chemical change can be discussed from a general standpoint, inasmuch as it affords the clearest and most complete confirmation of the principle of the conservation of energy.

The applications of this principle to chemical interactions are first illustrated by means of the different kinds of thermal measurements, numerical examples being given, the solutions of which, here as elsewhere in the book, are particularly neat. Mechanical forms of energy attending chemical change, in particular the volume energy of gases, are also discussed. The author next points out that the measures of the different forms of energy are composed of two factors, one of which is all-important in determining the direction of the energy flow, e. g. Temperature and entropy are shown to be the factor of heat energy, and a clear and concise account of the thermodynamics of perfect gases is given, in order

to arrive at the shape of the entropy function, which is of course known in this particular case. The relations between heat energy and volume energy, and between heat energy and electrical energy, are then set out at length.

The author here indicates how terms involving what he calls the "chemical intensity" of the reacting substances enter into the energy equations. Chemical intensity is what Gibbs originally termed the "potential" of the substances, and this function, it is hoped, will eventually be shown to be the mathematical expression of chemical affinity.

The third section of the book is devoted to the properties of chemical intensity. The general method of deriving the law of mass action is given, and chemical equilibrium, the properties of dilute solutions, and the velocity of chemical reactions are brought under the sway of the energy equations. The last section contains the treatment of the phenomena which may be grouped around Gibbs's phase rule, and of reactions depending on several parameters.

The book is the only one which is exclusively devoted to chemical energetics, and to the student possessed of sufficient mathematical knowledge it offers an admirable account of the present state of the subject. J. W. R.

*Die Bearbeitung des Glases auf dem Blasetische.* Von D. Djakonow und W. Lermantoff. Pp. 154. (Berlin: R. Friedländer and Sohn, 1895.)

THE original edition of this book was in Russian, and the authors, one of whom, D. Djakonow, is now dead, were demonstrators in chemistry at St. Petersburg University. The instruments and methods employed by glass-blowers are set forth in detail, together with descriptions of the kinds of glass best suited for different work. A very full and practical account is given of the construction, graduation, and calibration of thermometers; but to carry out these operations thoroughly, some experience is required. Work more suitable for the 'prentice hand fills the greater part of the book. Every operation in glass-blowing and manipulation likely to be needed in physical and chemical laboratories, appears to be described; while the diagrams illustrating the stages in the construction of the different pieces of apparatus, will greatly assist in training students to become skilled workers.

*Problems and Solutions in Elementary Electricity and Magnetism.* By W. Slingo and A. Brooker. Pp. 108. (London: Longmans, Green, and Co.)

MODEL answers to examination questions may prove a blessing or a curse, according to the way in which teachers use them. Herein are answers to questions in electricity and magnetism (elementary stage), set at the Science and Art Department's examination from 1885 to 1894, together with a series of original questions. The teacher who wishes to train his class to answer questions clearly and concisely, will find suitable exercises in composition in this book, and he will also find the volume an inducement to cram his students with undigested information.

*Qualitative Chemical Analysis of Inorganic Substances.* (New York: American Book Company, 1895.)

THIS work consists of a series of analytical tables, supplemented by explanatory and descriptive notes, and working directions. It makes no pretence to originality, and is hardly a book we should like to see widely adopted by students of elementary practical chemistry. The tables, which were prepared for use in Georgetown College, Washington, D.C., present few points of interest or value to teachers of chemistry in our schools.

## LETTERS TO THE EDITOR.

The Editor does not hold himself responsible for opinions expressed by his correspondents. Neither can he undertake to return, or to correspond with the writers of, rejected manuscripts intended for this or any other part of NATURE. No notice is taken of anonymous communications.]

## Professor Boltzmann's Letter on the Kinetic Theory of Gases.

IN common, I am sure, with all the physical readers of NATURE, I have read Herr Boltzmann's letter with great interest. And I am glad to observe that, though he appears to think I differ from him, that part of his letter which chiefly deals with my criticism on Dr. Watson's idea of what "Boltzmann's Minimum Theorem" is, is simply putting forward, with all his great authority, the view for which I contended. But it is a little hard that Dr. Boltzmann should represent me as endeavouring to *disprove* his theorem when I expressly stated that while I did not know his proof, I supposed that it was all right. True, I said that I found it hard to conceive how any proof on the lines of Dr. Watson's could be valid because that proof appeared to me to be a purely dynamical proof, and I applied the reversibility argument to show that a purely dynamical proof was impossible, so that the H-theorem could not be a purely dynamical theorem; and after indicating the lines on which it appeared that there might be an average dynamical theorem, I asked if some one would say what the H-theorem really was.

Thereupon Mr. Burbury wrote a helpful letter, which he followed up by a still more helpful correspondence, in which verbal misunderstandings were gradually cleared away, which showed that the proof of the H-theorem considered as a dynamical theorem, not as a theorem in probabilities, assumed that in one respect the configuration was, before each set of collisions, already perfectly average, and that this condition is violated in the reversed motion; so that the theorem, regarded as a dynamical theorem, is not proved for configurations in general, but for those possessing a certain amount of "average" already—a restriction which comes to the same thing as the limitation imposed by Prof. Boltzmann when he says *the theorem is not a dynamical theorem, but one in probabilities*.

Shortly after Mr. Burbury's letter appeared, Dr. Watson wrote denying that the criticism from reversibility applied, and claiming that the theorem was a general dynamical theorem, in the sense that it applied to all configurations. Enlightened by Mr. Burbury, I now see that Dr. Watson's reasoning is not open to the objection that it proves a general dynamical theorem; but I cannot blame myself for thinking that it did, for that was what Dr. Watson himself believed it to do, and what his language naturally implies. Moreover, after perceiving the oversight which vitiates the proof in its present form, I did not examine it further.

Prof. Boltzmann has mis-understood Mr. Burbury and me in one or two particulars. He denies that there are as many configurations for which  $dH/dt$  is positive as there are for which it is negative. He evidently thinks that we mean something different from the bare meaning of the words, which are certainly true. It is easy to explain what we do not mean (I say we, for I am sure Mr. Burbury will agree with me). Suppose  $H=10$  to be the minimum value of H for a given system of molecules, we do not mean that among all the configurations for which  $H=50$ , there are as many which will, if left to themselves, turn into configurations for which  $H=60$ , as will turn into configurations for which  $H=40$ . The illustration, which to my mind has most clearly removed the apparent contradiction in the statement that there are as many configurations for which H will increase as decrease, while yet the probability is that H will on the whole decrease, is that of a  $y$  turned upside down, thus  $\Lambda$ . For every downward path there is an upward path, *i.e.* the reversed direction; yet starting from the angle there are two ways down for one way up, so that there is a greater probability of going down than up. If in the reversibility argument one could assert, not merely that there are as many configurations for which H tends to increase as to decrease, but that for any given value of H there were as many configurations which tend to increase as to decrease, then the conclusion that H was as likely to increase as to decrease could be deduced. But the argument is quite invalid when we set off a configuration for which H increases against one for which it decreases, although

the values of H for each are different. As an illustration more closely allied to the case of a gas, we might take a tree turned upside down, with an infinite number of branches passing through each point of its substance in all directions, there being at every point more branches tending downward than upward (because those whose tangents are horizontal may be said to tend downward on each side), and every upward branch finally turns downward and tends to become nearly horizontal at last, when H is near its minimum value.

To my mind this appears a far better way of meeting the difficulty than Prof. Boltzmann's illustration of the dice, for so far as I can see, all that he has shown is that if you start from an exceptionally high ordinate, *i.e.* one over the average, you are likely, after a considerable time, to get to lower ordinates in whichever direction you go, and an opponent might answer that if you start from an exceptionally low ordinate you are likely to get higher ones in whichever direction you go, and that there must of course be as many deviations below the average as above it, so that if you start from an arbitrary point in an arbitrary direction, you are just as likely to get to higher as to lower ordinates. In point of fact this appears to be the case for his curve, while it is not true for the tree or for a gas.

Prof. Boltzmann must have put an entirely wrong construction on something or other, which I suppose I have written, when he says I object to the Maxwell Law of distribution because it would ultimately lead to the total kinetic energy of the universe being equally distributed among every degree of freedom of every particle in the universe. Instead of considering that to be *a priori* improbable, I hold exactly the view put forward by Prof. Boltzmann.

With regard to the first portion of Prof. Boltzmann's letter, there is so much that is speculative in it that any discussion would occupy more space than I feel entitled to claim. I will only say that the idea that a gas takes years to come to thermal equilibrium seems hardly consistent with vibrational portion of the kinetic theory being of practical value, when applied to gas which has only had a few hours to settle down.

EDWARD P. CULVERWELL.

Trinity College, Dublin, March 6.

It seems to me that my meaning has not been expressed quite clearly; therefore, it may be worth while to add one remark. Not for every curve, but only for the particular form of the H-curve, disymmetrical in the upward and downward direction, can it be proved that H has a tendency to decrease. This particular form is very well illustrated by Mr. Culverwell's suggestion of an inverted tree. The H-curve is composed of a succession of such trees. Almost all these trees are extremely low, and have branches very nearly horizontal. Here H has nearly the minimum value. Only very few trees are higher, and have branches inclined to the axis of abscissæ, and the improbability of such a tree increases enormously with its height. The difficulty consists only in imagining all these branches infinitely short.

Finally there is the difference between the ordinary cases, where H decreases or is near to its minimum value, and the very rare cases, where H is far from the minimum value and still increasing. In the last cases, H will reach, probably in a very short time, a maximum value. Then it will decrease from that value to the well-known minimum value.

Paris, April 6.

LUDWIG BOLTZMANN.

## The Recent Auroral Phenomenon.

ON the evening of March 13, from 7.35 to 8.5, Greenwich mean time, I was a spectator of the abnormal display of Aurora Borealis which attracted so much attention at various places throughout the country. It appeared here as a belt of light spanning nearly the whole sky in a great circle from east to west. When first noticed by me at 7.35, the streak extended from near the hind quarters of Leo to the head of Aries, or from R.A. 169°, Decl. + 16° to R.A. 24°, Decl. + 22°.

At the time the streak was altogether cometary in appearance, beginning in a fine point, but it gradually changed in form, moving at the same time towards the south. Eventually it also shortened so considerably that just before my last view of it, it only extended from  $\gamma$  Geminorum to  $\gamma$  Ceti. Its greatest breadth was about 12°.

THE AGE OF THE EARTH.

The streaks represent the most striking phases, as nearly as I could see, in intervals of five minutes.

Fig. 1. The streak extended from the cometary head in a long wavy tail, and represents also the streak seen in the night. As indicated in the sketch, there was a much more brilliant part than the rest, running parallel to the head of the streak.

Fig. 2. The streak is seen when it had more the appearance of a comet's tail, with a head; and it was very noticeable that the head, which was towards the north—was much brighter than the tail.

Fig. 3. As low the "head" began to shrivel up—shortening the tail. The glimmering appearance of the "shrivelling" part came very much in mind of the motion of the air over a "heap" of slag; the tail end began to broaden out somewhat.

Fig. 4. The streak has taken a very pronounced arrow-head shape, and, as if to complete the resemblance, the

Fig. 1.

Fig. 2.

Fig. 3.

Fig. 4.

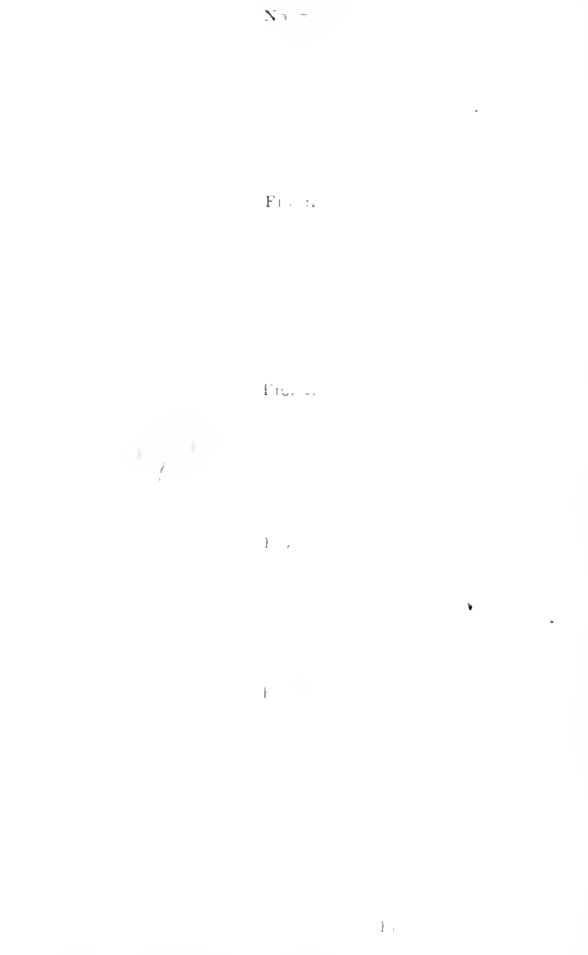

part of the form of the feathering; whereas in the latter case I note the appearance of comb teeth, the rounded parts are indicated by darker shading.

Fig. 5. The streak has considerably shortened and broadened in the west, where it soon afterwards mingled with the auroral rays, which had come round from the northern horizon.

In general, that the appearances were singularly beautiful and brilliant. The sky was very clear at the time, and it was visible through the most brilliant parts of the aurora. During the time the streak was visible there was a heavy shower of aurora on the northern horizon, which, as I have already mentioned, would round to the west and caught the

J. G. RICHMOND.

ILL-HEALTH has hitherto prevented my making the comments which seemed called for by Lord Kelvin's friendly article of March 7, in reply to my communication of January 3. Perhaps I may be allowed not merely to restrict my remarks to this article, but to deal more generally with the subject, in the hope of clearing away the misapprehensions which exist between modern geologists and palæontologists, who are no longer uniformitarians, and physicists who are represented by Lord Kelvin.

The arguments as to the age of life on the earth are based on considerations of (1) geology and palæontology; (2) tidal retardation and shape of the earth; (3) the cooling of the earth from an initially hot condition; (4) the age of the sun.

1) From geology. The leading geologists declare that the great thickness of sedimentary rocks created since the Lower Cambrian, which are almost the oldest fossiliferous rocks, can only have been produced during many millions of years.

It is difficult to get geologists to give even wide limits for the age of the Lower Cambrian.<sup>2</sup> Their calculations are based not upon the rate of accumulation of sediment in one of our quiet oceans, but upon the rate of degradation in valleys where the rate is greatest at the present time. They make this declaration, thinking that for the last thirty three years it has been authoritatively declared by physicists that such an estimate is absurdly great. I have no doubt that they have done their best to keep this estimate as low as possible, for they have a great interest in making geological theory agree with physics. Some physicists tell them that the flaw in the geologists' reasoning consists in their not taking into account the much greater tidal actions of the past. When tides rose and fell many hundreds of feet, and swept over tens or hundreds of miles of foreshore, there must undoubtedly have been a more rapid formation of sedimentary rock than anything of which we now have experience. The geologists' answer is: We acknowledge that all nature's actions were on the whole, possibly, more intense in the past. We know from Prof. Darwin's development of Prof. Pariser's theory that the moon was undoubtedly nearer the earth in palæozoic times, and the tide influence was therefore greater. But there seems to be no method of even approximately calculating how much greater the tidal influence was. Whilst one great astronomical authority speaks of tides of 500 feet deep in palæozoic times, Prof. Darwin himself thinks that two or three times as great as at present may be an excessive estimate. There is a good deal of geological evidence for much smaller seas than at present, and even if tidal influence were greater the actual tides may have been much smaller than now. Of positive evidence in our favour, we have the fact that numerous examples exist of palæozoic rocks which are identical in almost every physical way with tertiary rocks, and it is difficult to believe that they can have been deposited under very different conditions. Again, nearly all the old sedimentary rocks were laid down near coasts where tidal action would be most violent. Yet even low down in the Cambrian we find the remains of creatures

<sup>1</sup> In this paper free use has been made of many suggestions from Prof. Fitzgibbon.

<sup>2</sup> Their data are of this nature:—Of fossiliferous rocks, successively raised the total thickness may be taken as not less than 1,000 feet. Over the area of the basin, raised by many rivers the rate of denudation is known with sufficient accuracy for approximate calculation. Of the basin of the Mississippi a thickness of one foot of rock is removed in 100 years; of the Ganges, 2 1/2 ft. the Hoang Ho, 1 1/2 ft.; the Rhone, 1 1/2 ft.; the Danube, 1 1/2 ft.; the Po, 2 ft. the Nile, 4 1/2 ft. (S. A. Geikie, Geol. Soc. of Glasgow, 1874). I have heard that Prof. Silliman demands less time than other geologists, but since this paper was written, I have seen (NATURE, April 4) that even he does not care to put the age of the Lower Cambrian at much less than 17 million years.

which still have attached to them delicate antennæ. In sandstones we find most delicate ripple marks and the marks of rain-drops. But over and above all this, denudation along coast-lines can hardly be regarded as of much importance compared with subaerial denudation (Sir A. Geikie, *Trans. Geol. Soc. of Glasgow*, 1868). Was there more rain? and did it fall more suddenly? Did the wind blow more strongly? Were atmospheric actions more vigorous in the past? There is no great reason for believing that they were. As Prof. G. Darwin observes, fossil trees do not seem to have been built more strongly than modern trees, and this gives some evidence as to the relative violence of aerial forces.

All the geological evidence points to rates of denudation and deposition in the past which may, on the average, have been greater than the average rate at present, but which were not on the average greater than the greatest rates at present.

The palæontologist now comes in. A study of fossils shows that there has been a gradual development, sometimes more quickly perhaps, and sometimes more slowly, but on the whole a continuous development of animal life in the past. We believe from all our study of nature that the development has been continuous. As more and more strata are studied, many of the apparent discontinuities are being converted into continuities. Now even in the lower parts of the Cambrian, *Brachiopoda* are found. Biologists tell us that in all probability these were gradually developed from creatures like worms; their structures are sufficiently complex for us to know that the time taken to develop the Brachiopod from the worm may have been as great as the age of known fossiliferous rocks. There are many rocks, evidently sedimentary, enormously older than the Cambrian, and when laid down there was certainly water on the earth, and hence it was neither too hot nor too cold for animal life. In these lower formations there are conglomerates containing pieces of still older rocks. Although in pre-Cambrian strata traces of animal remains are said to occur, we may say that the palæontological record is almost lost below the Cambrian, most of the earlier rocks having been subjected to great metamorphic action. If we keep to our principle of continuity in nature's actions, we see that the first beginning of life must have taken place at a date many times earlier than the very earliest geological record.

But the most experienced geologists and palæontologists state that they are satisfied with a few hundred million years as the possible age of life or the existence of water on the earth.

2. The considerations drawn from tidal retardation are as follows:—

(a) The shape of the earth now is the same as its shape when it solidified. (b) The shape of a liquid earth tells us its rate of revolution on its axis, therefore we know the rate of revolution of the earth on its axis when it solidified. (c) Assuming that we know, with a fair amount of accuracy, the rate at which the length of the day is altering, we know the date of the earth's solidification, and certainly this is later than 1000 million years ago.

When I referred to the fallacy in this argument, I did not know that it had already been pointed out by the Rev. M. H. Close and Mr. Clarence King and Prof. George Darwin. It lies in the fact that (a) is certainly wrong. A solid body like the earth will, under the action of great forces, alter its shape in time. Such alteration is continually going on. Again (c) is very doubtful.

(3) I now come to the considerations from the cooling of the earth. Lord Kelvin proved that, if the earth was once at a uniform temperature of 7000° F. or 3870° C., of material the heat properties of which are the same as the average of three rocks experimented upon at Edinburgh—these remaining constant throughout—and if the rate

of increase of temperature downwards in the crust is now 1 Centigrade degree for every 90 feet, 100 million years have elapsed since cooling began: but there is a possible maximum of 400 millions.

In the article on this subject, published in *NATURE*, January 3, 1895, I showed that, if we assume greater conductivity in the interior than at the surface, we increase this limit of age. I took a number of examples, which could be worked mathematically. I did not pretend that any one of these represented the actual state of the earth. They merely proved that there were possible internal conditions which might give enormously greater ages than physicists had been inclined to allow. Of my various results, I did not give one as more correct than another, although some may have seemed more probable than others. It was not my object to obtain a correct estimate. Indeed I tried to show that it was impossible for a physicist to obtain such an estimate, as there were all kinds of possible assumptions which led to many different answers.

The validity of my reasoning in no degree rests upon the accuracy of R. Weber's results as quoted by me. Indeed, I only discovered these results when writing to Prof. Tait. In *NATURE*, February 7, p. 341, I have shown the extent to which the possible limit of the earth's age is increased if  $k$  and  $c$  increase with temperature and  $k/c$  remains constant. But I published this as an interesting mathematical result, and was careful to add—“It must be understood that my conclusions are really independent of whether R. Weber's results are correct or not.” It is comparatively unimportant, but R. Weber has published another set of results which confirm those which I quoted. The results, published on March 7 for the first time, differ so utterly from the two previous sets, that I venture to think there may be mistakes in transcribing. However that may be, I am not concerned either to support or refute them.

I mentioned the possible great quasi-conductivity due to the interior of the earth being a honey-combed mass containing liquid, and to the possible greater conduction due to the presence of iron and other metals. Almost anything is possible as to the present internal state of the earth. Dr. Ramsay seems to think that there must be great quantities of sulphides inside, and these would probably be much better conductors than the surface rocks.

Prof. Schuster, in discussing the diurnal variation of terrestrial magnetism (*Phil. Trans.* 1889, p. 497), comes to the conclusion that the electric conductivity of the earth must be considerably greater inside than at the surface.

In all probability there are no great masses of liquid inside the earth at the present time, but it is quite possible that until recent times convection in such masses may have been conveying heat from the very inner earth towards its surface, and the latent heat given out by such masses of liquid as they solidified would be another potent factor. Some distinguished geologists say that the excessive folding which has occurred on the earth's surface cannot be accounted for by the current assumption of physicists, which involves the result that, practically, no cooling has yet taken place below the depth of 125 miles: my assumption is that cooling has taken place to much greater depths.

All these things, like the numbers published by R. Weber, support the argument if they are correct, but they do not in any way destroy it if they are wrong. I was not looking for a probable age of the earth from the point of view of mere physics. I wished to show that the physics' higher limit was greater than a few hundred of millions of years.

Mr. Clarence King's paper appears somewhat inconclusive. He assumes, possibly rightly, that the earth's crust may have the properties of *Diatase*; experiment has

shown what is the rate of increase of the melting temperature with an increase of pressure of this rock: Laplace's hypothesis of a law of increase of density downwards in the earth could be very wrong, and from this a law of increase of pressure downwards may be formulated. From these data Mr. King finds what are the temperatures at various depths, which if exceeded would mean liquidity. A liquid layer inside the earth's crust being assumed to be impossible, Mr. King, trying all sorts of Kelvin solutions of a solid earth of uniform conductivity and uniform temperature, initially finds a maximum age of 25 million years, the initial temperature being not greater than 2000 C. Furthermore, higher initial temperatures are not possible!

Now it is evident that if we take any probable law of temperature of convective equilibrium at the beginning and assume that there may be greater conductivity inside than on the surface rocks, Mr. King's ingenious test for liquidity will not bar us from almost any great age.

4. There remain, lastly, considerations drawn from the age of the sun. On the assumption that all the energy possessed by the sun was that due to the mutual gravitation of its parts, and that the sun is now of uniform density, Helmholtz found that the sun may have in the past radiated as much as 22 million times his present annual loss. Langley found that the sun's present rate of radiation was under-estimated, and the statement of Prof. Newcomb may be taken as that of Helmholtz, corrected. Newcomb says ("Popular Astronomy," p. 523): "If we take the doctrine of the sun's contraction as furnishing the complete explanation of the solar heat during the whole period of the sun's existence, we can readily compute . . . It is thus found that if the sun had, in the beginning, filled all space, the amount of heat generated by his contraction to his present volume would have been sufficient to last 18 million years at his present rate of radiation."

Lord Kelvin pointed out pp. 364-65, vol. i. "Pop. Lectures" that Helmholtz had assumed a sun of uniform density, whereas the sun's density must increase very much towards his centre, and as a result of calculation on the assumption that only half of the original energy was available (p. 374), that the radiation was greater in the past, and that the original collisions occurred practically simultaneously, he says: "We may therefore accept as the lowest estimate for the sun's initial heat 10,000,000 times a year's supply at present rate, but 50,000,000 or 100,000,000 as possible, in consequence of the sun's greater density in his central parts." And again p. 375: "It seems therefore, on the whole, most probable that the sun has not illuminated the earth for 100,000,000 years, and almost certain that he has not done so for 500,000,000 years. This last number, then, is Lord Kelvin's higher limit. After six years, in 1868, Lord Kelvin returned to the question, and he says p. 53, vol. ii. "Pop. Lect. and Addresses": "The estimates here are necessarily very vague, but yet vague as they are, I do not know that it is possible, upon any reasonable estimate, founded on known properties of matter, to say that we can believe the sun has really illuminated the earth for five hundred million years."

In his R.I. address of 1887 Lord Kelvin gave no higher limit. I think that, on his specified assumptions in giving these large numbers, he has been very generous; for, taking Mr. Homer Lane's determination of the internal density of the sun, I find that the Helmholtz total energy need only be multiplied by about 2. If, however, instead of taking, as Mr. H. Lane did, 11 as the ratio of specific heat, we take a less number, and there is no reason why we should not, we find much greater densities towards the centre, and a much greater total energy and age. Still, I think that it

is only when we escape from the above assumptions that we can see our way to increase the higher limits which have been quoted.

To justify the Helmholtz hypothesis of mere mutual attraction, initially, between the portions of matter which form the sun, Lord Kelvin ("Pop. Lect.," vol. i., pp. 411-3) dwells upon the great improbability that any parts of the sun possessed much initial velocity. He shows that if two bodies, A and B, came together to form the sun, when the bodies were still far apart before collision, the motion of the centre of B relatively to A, must have been directed with great exactness to pass nearly through the centre of A (as the sun has a comparatively small moment of momentum), and this was very improbable if the bodies had initial velocities. But this argument is only satisfactory when the bodies coming together are two in number. For example, let us imagine in early times a sun of half the mass of the present one, but of many times its diameter. It is possible that its radiant energy was supplied by meteors. If the meteor feeding was in excess, the sun became larger in volume. If there was too little meteor feeding, the sun became smaller. Even if there was a very excessive supply for a short time, say by the incoming of a huge meteor, we need not assume excessive radiation in consequence. Such meteors may have come from stellar space with great initial velocities, and may have possessed before collision many times the kinetic energy which a mere solar system meteor of the same mass would possess.<sup>1</sup> If there were many such meteors, their paths might be enormously out of line with one another and with the centre of the sun, and yet we need not imagine them to alter much the moment of momentum of the sun about its axis. If we look for the *probable* age of the sun as deduced from mere physics, we ought to take Helmholtz' condition of mere mutual attraction, the Helmholtz calculation being corrected of course for greater internal density; but if we look for a higher limit to the age of the sun, it is difficult to see why we may not multiply Lord Kelvin's total energy and age of 500 million years.

Again, the ages determined by Von Helmholtz, Prof. Newcomb, and Lord Kelvin, are given on the uniformitarian assumption that the sun has been radiating energy always at his present rate. If we may imagine that for long periods the sun radiated at a smaller rate, whether because his mass was smaller, or because of his atmosphere, we again have an increase to the calculated age. Prof. Newcomb seems to have noticed this, and to meet the objection (p. 525, "Popular Astronomy") he says, "that a diminution of the solar heat by less than one-fourth of its amount would probably make our earth so cold, that all the water on its surface would freeze, while an increase by much more than one-half would probably boil the water all away." On account of this exigency, indeed, he reduces his previous estimate in the ratio of nine to five. This statement ought to have the careful consideration of men who know more about astronomical physics than I do. It means that if the earth were now 15½ per cent. further away from the sun, there would be no water and no life, only ice; and if we were 18¼ per cent. nearer the sun, there would be again no water and no life, only steam. It becomes an important question, is there no life, is there no water on the planet Venus which has twice our solar radiation? Is all its water in its atmosphere as steam? Again, Mars has only 40 per cent. of our solar radiation; is there no life, no water, only ice upon Mars? I have no right to speak on such a subject, but I understood that the atmosphere of Venus was much like that of our own planet, and that the water of Mars is not all ice, for his polar

<sup>1</sup> The velocities of stars are probably much less than the possible velocities of smaller bodies.

snow-caps are seen to melt in summer. True, they may be solid carbonic acid, but I have recently read that the green colour of vegetation had been observed to appear and disappear regularly on the planet. If there is little water on the surface of Mars, I should imagine that this is rather due to its having soaked into the crust, which is probably colder underground than ours. Prof. Newcomb has evidently not thought of Mars in this connection, for elsewhere he says: "If there are any astronomers on Mars . . ." On this question I venture to quote Lord Kelvin, who said, in 1887 ("Pop. Lect." vol. i. p. 376), that "the intensity of the solar radiation to the earth is  $6\frac{1}{2}$  per cent. greater in January than in July; and neither at the equator nor in the northern or southern hemispheres has this difference been discovered by experience or general observation of any kind." It is difficult to imagine that if the effect of  $6\frac{1}{2}$  per cent. cannot be detected, 25 per cent. should convert all the water to ice and destroy all life.

Even if a small diminution of the solar radiation produced a very cold climate on our present

heat convectively from considerable depths, this heat again being carried about convectively by the earth's atmosphere, keeping the solid parts of the earth's surface in a fit state for the existence of low forms of animal life. It is possible that at the present time the surface of Jupiter, which receives a very small intensity of solar radiation, may have solid parts surrounding watery lakes and oceans capable of supporting life because of the existence of many lakes of melted lava.

To sum up, we can find no published record of any lower maximum age of life on the earth as calculated by physicists (I leave out the estimates based upon the assumption of uniform density in the sun, and also that of Mr. Clarence King than 400 million years. From the three physical arguments, Lord Kelvin's higher limits are 1000, 400, and 500 million years. I have shown that we have reasons for believing that the age, from all three, may be very considerably under estimated. It is to be observed that if we exclude everything but the arguments from mere physics, the *probable* age of life on the earth is much less than any of

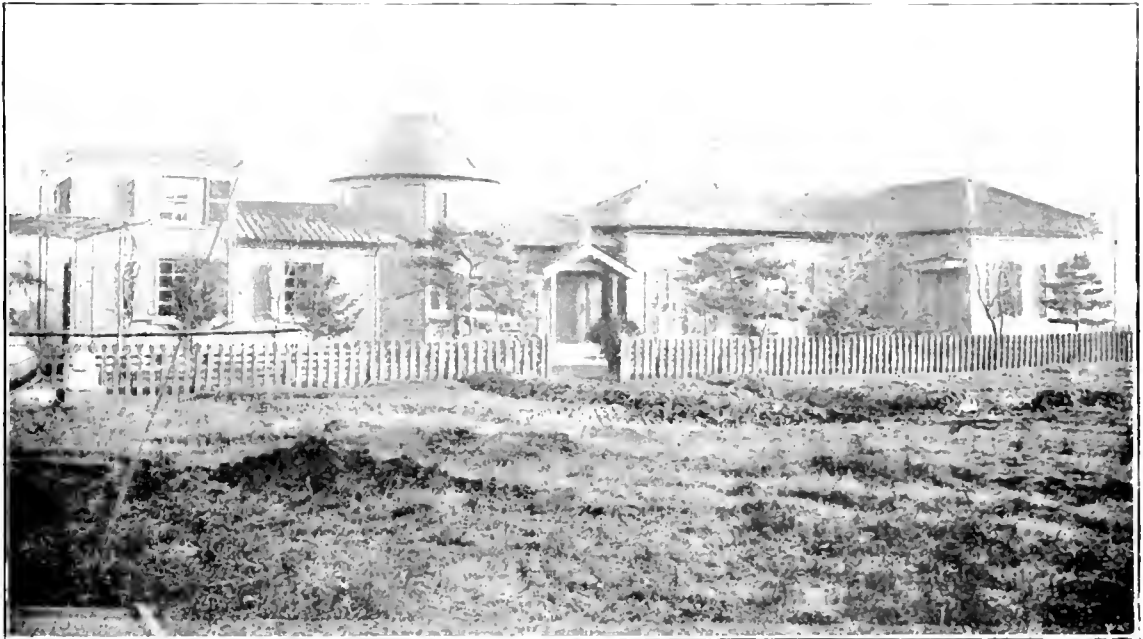

The Tokio Seismological Observatory.

earth, we must remember that the earth's atmosphere may have been very different in the past; the earth may have been very greatly blanketed, and the surface may have been actually warmer, although there was much less solar radiation. That the atmosphere is far more important in this connection than the amount of solar radiation, is evident if we consider Langley's determination that in the tropics, if there were no atmosphere, the temperature of the surface of the earth would be  $200^{\circ}$  C. Any addition to the quantity of air in our present atmosphere means an increase of the temperature of the rocky surface. But in the past, not only may there have been more atmosphere, but there may have been a very different kind of atmosphere. Again, we must consider a possible great amelioration of climate due to the earth's internal heat. It could not occur by mere conduction, but it is quite possible that for many millions of years there was great blanketing by clouds of watery vapour, and that underneath these blankets half the surface of the globe may have been a lake, or a number of lakes, of melted lava, which may have carried large amounts of

the above estimates; but if the palaeontologists have good reasons for demanding much greater times, I see nothing from the physicist's point of view which denies them four times the greatest of these estimates.

JOHN PERKY.

#### THE SEISMOLOGICAL OBSERVATORY DESTROYED AT TOKIO.

THE destruction by fire of the Seismological Observatory and Library, at Tokio, Japan, has already been referred to in these columns (p. 533). The valuable work which Prof. Milne has accomplished during his long stay in Japan is well known to our readers; and it is to be hoped that means for its continuance will be fully provided. By the kindness of Japanese friends, Prof. Milne has been able to make observations in a temporary home since the fire, and it will not be for lack of enthusiasm and activity if a new observatory is not soon in working order. We print below extracts from Prof. Milne's

optical apparatus of the fire, and accompany it with a view of the observatory buildings and house.

"All this at last. On Sunday morning, the 17th February, 1895 a.m., I was alarmed by the cry of fire, and I went back I was looking at smoking ruins in the street, my two armful of salvage (which I took to the fire) would include my last year's photographic records, and a score of cards of condolence from high personages and presents from the neighbouring shop-keepers—like bottles of beer, boxes of eggs, and oranges—and all this while the fire-engines were vigorously pumping. I saw that nothing more was to be saved, but before the flames were out, my colleague, Mr. C. D. West, set to work to take a series of snap-shots with his hand-camera. The results look like fogged plates, but they show amongst other things the effects of heat upon my big stone column. On Tuesday, I used some of the pieces as illustrations to a geological class as illustrative of the action of lava streams upon rocks they occasionally flow over. The President of the University, who very kindly had hurried from his house to see me and my ruins, had a new house ready for me before my own had done smoking, and I am now in it arranging furniture I have hired, sorting through heaps of charred paper, and getting ready to set up two new pendulums. These latter, if they work well, I hope to bring with their records to England, to show as a type of instrument which may be able to record movements which go round the globe and possibly through its interior. When earthquakes are recorded throughout Great Britain, it will not be necessary to always introduce a conversation with remarks about the weather.

"As nearly all the *Transactions* of the Seismological Society were packed up to go to Europe, a few that had middle places in the boxes may be saved, but I doubt if even out of 2500 copies I shall get more than two or three hundred. All my old earthquake books, some of which even dated from 1500 and 1600, but which were perhaps more curious than useful, seem to have gone.

"Instruments were fused or vapourised. Sixteen specially-constructed clocks, which would turn drums once a day, once a week, or drive a band of paper for two years, together with seismographs and horizontal pendulums, self-recording thermometers and barometers, microscopes, and a museum of old and new contrivances, are now on the scrap heap. Until to-day, I felt that I had the observatory I intended to put up in England completely furnished, and I was proud of the furniture.

"The fire broke out in the midst of a pile of wood in an out-house, and this with a nice wind blowing on a Sunday morning when there was no one near to help.

"And now I have next to nothing—decorations, medals, diplomas, clothes, manuscripts, extending over twenty-five years, and everything else has gone to smoke; still it is not altogether a misfortune.

"Looked at in the right way, like an earthquake, a fire may after all be a blessing in disguise; but, of course, it is sometimes pretty well wrapped up.

"Dies ire, dies illa,  
Solvat cælum in favilla."

#### TERRESTRIAL HELIUM

I HAVE received the following letter and enclosure from Prof. Thorpe:

"University of Glasgow, April 16.  
MY DEAR LOCKYER. The enclosed extract from a letter just received from Cleve of Upsala may be of interest to you. I am, ever yours,  
T. L. THORPE."

I have also received from Mr. Crookes a letter in which he writes that the gas in Cleveite contains the long-sought-for helium.

NO. 1329, VOL. 51]

"This letter arrived exactly the very day one of my pupils, Mr. Langlett, tried to get the gas of Cleveite in my laboratory. The gas given off from my mineral did not contain a trace of argon. The spectrum has been examined by Thalcin, who found an exact coincidence of the line of the gas with the helium line and besides some others:—

Wave-length.	Intensity.
6677 ... ..	half-strong
5875.9 ... ..	strong: helium
5048 ... ..	half-strong
5016 ... ..	strong
4922 ... ..	half-strong
4713.5 ... ..	weaker

"I have sent a letter about it to Berthelot. If you like, you may communicate the result to the Chemical Society, Mr. Ramsay, Crookes, and other friends. . . . An experiment to determine the specific gravity did not give trustworthy results, but seems to indicate that it is a very light gas, still more heavy than hydrogen. Will this gas fill the gap between hydrogen and lithium? It will become very interesting to see. What makes me much curious is that our helium gas was free from argon, and that Mr. Ramsay's (according to *Comptes rendus*) did contain that curious stuff. Is there any relation between argon and helium, and are we facing a new epoch in chemistry?"

Although my results are not yet complete for publication, the foregoing communication makes it desirable that I should state at once that immediately on the publication of Prof. Ramsay's statement, by the kindness of Mr. L. Fletcher I was enabled to study the gases given off by Cleveite by heating in vacuo, a method I have used for metals and meteorites.

A very small quantity of Cleveite is all that is necessary to obtain a considerable volume of the new gas, which comes off associated with hydrogen.

I have now examined several tubes. I have found no argon lines; I have not found the lines, other than the yellow one, given by Crookes; but lines have been recorded near some of the wave-lengths given by Thalcin, especially the one at 677, near a line I discovered in the chromosphere in 1868. So far the sky has not been clear enough to enable me to determine by direct comparison with the chromosphere the position of the line in the yellow with great dispersion.

J. NORMAN LOCKYER.

#### NOTES.

IN honour of M. Berthelot, and as a demonstration of the power and progress of science in France, a banquet was held at Paris a few days ago. Nearly eight hundred guests were present, among them being M. Brisson, President of the Chamber of Deputies, and M. Poincaré, Minister of Public Instruction. Upon the invitation cards were printed the words: "Hommage à la science, source de l'affranchissement de la pensée." M. Poincaré made an eloquent speech in praise of the work done by the eminent Secretary of the Paris Academy of Sciences, and M. Berthelot, in his reply, dwelt, at some length, upon the beneficial influence of science on social and moral, as well as material, progress. Science, he said, had for its only guide the love of truth, and confidence in its final triumph. Proved under all circumstances, and strengthened every day by success, the scientific method had become the principal source of the moral and material progress of society. In fact, science was the source of all progress accomplished by the human race. Every one knew that, during this century



science had conferred great benefits upon civilised peoples by the application of its results and laws to mechanical, chemical, and electrical industries. But M. Berthelot held that material progress was the least of the fruits of scientific work: he claimed for science the more extensive domains of the moral and social world, and vindicated the position taken up by him in his article on "Science et la Morale," which appeared in the *Revue de Paris*. The speech and the banquet may be taken as an effectual reply to those who question the benefits of scientific investigation in France.

ONLY last week, in announcing the publication of the fourth edition of Prof. James D. Dana's "Manual of Geology," we referred to the extraordinary activity of the author. We regret this week to have to record his death, at eighty-three years of age. Another eminent man of science who has just passed away is Prof. Lothar von Meyer, at the age of sixty-five.

REUTER'S correspondent at Toronto reports that the Provincial Legislative Assembly of Ontario has authorised a grant of 7500 dollars towards defraying the expenses of a meeting of the British Association for the Advancement of Science to be held in Toronto in 1897, should the Association accept the invitation to hold a meeting there.

MR. R. FITCH, whose name is especially well known among archaeologists and geologists of Norfolk and Norwich, and who, three years ago, presented his collections to the Norwich Museum, and provided cases for them, has just died, at the advanced age of ninety-three.

JOHN ADAMS RYDER, Professor of Embryology at the University of Pennsylvania, died on March 26.

PROF. JAMES E. OLIVER, the mathematician, who was connected with the Cornell University faculty for twenty-five years, died at Ithaca, on March 27. He was born in Portland, Me., July 27, 1829. He graduated at Harvard in 1849, and received in the same year the appointment of assistant editor in the office of the American Nautical Almanac. He became in 1871 assistant professor of mathematics at Cornell University, and in 1873 was appointed to the chair as Professor. He was a member of the American Academy of Arts and Sciences, the American Philosophical Society, and the National Academy of Sciences.

A MONUMENT to the late Prof. Villemin, who added so much to the knowledge of the nature of tuberculosis, has just been unveiled at Val de Grâce. A monumental souvenir of the late Prof. G. Feuchet was also unveiled a few days ago, at Père-Lachaise.

THE Home Secretary, on the application of the East Riding County Council, has made an order prohibiting the taking or destroying of wild birds' eggs on the promontory of Spurn for a period of five years. Spurn Point is one of the chief places of deposit by sea birds of their eggs on the Yorkshire coast, and of late years there has been wanton destruction of both sea-gulls and their eggs.

A CORRESPONDENT informs us that a very bright meteor was seen at Tappan, N.B., at 10h. 4m. p.m., on Saturday, April 13. It started at a point a little to the east of Vega, and was moving almost directly towards Saturn. It was visible for about six seconds, and seemed to have a jerky motion. It was more brilliant than Venus, and was elongated in shape. The weather was very clear and quiet at the time of observation. The meteor's direction of flight was, approximately, from  $270^{\circ} + 40^{\circ}$  to  $221^{\circ} - 7^{\circ}$ .

SIR JOSEPH FAYRER, Sir Guyer Hunter, and Mr. Jonathan Hutchinson, the adjudicators, have (says the *British Medical Journal*) awarded a prize of fifty guineas to each of the following essays, sent in in response to the invitation of the Leprosy Fund: "On the history of the decline and final extinction of leprosy as an endemic disease in the British Islands," by Dr. George Newman; "On the conditions under which leprosy has declined in Iceland and on the extent of its former and present prevalence," Dr. Edward Ehlers (Copenhagen); "On the facts as to the recent increase of leprosy at the Cape and its present prevalence in South Africa," Dr. S. P. Impey (Medical Superintendent, Kolbin Island); "On the reputed recent increase of leprosy on the Australian Continent; its extent and possible causes," Dr. Ashburton Thompson; "On the conditions under which leprosy prevails in China, Cochin China, Batavia, and the Malay Peninsula," Dr. James Cantlie (Hong Kong). On some of the subjects for which prizes were offered no essays were sent in, and some of the essays sent in were held not to meet the terms of the competition. The successful essays will be printed and published at the expense of the Fund.

ABOUT 11.15 on Sunday night, shocks of earthquake of varying intensity were felt over a considerable portion of Austria-Hungary, extending from Vienna to the Adriatic coast and the adjoining islands in one direction, and from Salzburg to Agram in another. In Vienna, according to the *Times* correspondent, the shocks were slight. Clocks were stopped, however, in parts of the town, and windows were heard to rattle. The vibrations are reported to have proceeded from south to north. The earthquake would seem to have reached its greatest intensity within a triangle formed by Laibach, Trieste, and Fiume. At Laibach no fewer than twenty-five shocks were noticed, and they continued until seven o'clock on Monday morning. The collections in the Laibach Museum are said to have been almost entirely destroyed. At Trieste several vibrations were felt, one of which was of ten seconds duration. Many buildings have been more or less damaged. Tremors of still longer duration are reported from Krainburg. Shocks of less violence occurred at Klagenfurt, Leibnitz, Luttenberg, Agram, and elsewhere. Four distinct vibrations were felt at Venice: the first, which took place at 11.17 p.m., was very severe, and lasted twelve seconds. Severe shocks of earthquake were also felt in Italy, at Ferrara, Udine, Treviso, and Padua.

WE have on various occasions given short descriptions in these pages of experiments carried on by different investigators with a view to discovering a practicable method of telegraphing over a considerable distance without metallic wires connecting the two stations. Among the observers who have devoted a considerable time to this problem may be mentioned Mr. Preece, the chief engineer of the Telegraph Department of the Post Office; and it is to this gentleman we owe the first practical application of the method of telegraphing by induction. During last week the submarine cable connecting Oban with Auchnacraig broke down, and the telegraphic messages have since been passed between these two places (distant about six miles) by means of Mr. Preece's inductive method. A gutta-percha insulated wire, one and a half miles long, was laid along the ground from Morven, whilst on the Island of Mull use was made of the ordinary overhead line connecting Craignure with Aros. The distance between the two parallel wires was about 3½ miles, the Sound of Mull being here at its narrowest. Using a vibrator as transmitter, and a telephone as receiver, the usual messages were successfully dealt with until the cable was repaired, the whole experiment forming a very interesting event in the annals of telegraphy.

A PAPER which will have considerable interest for those who have to design and use electrical apparatus, where wood or slate is often used as the insulator, appears in the *Proceedings* of the American Academy. The subject of the paper is the electrical resistance of certain poor conductors, such as wood and stone, and is by Mr. B. O. Peirce. The author has examined a great number of samples of different kinds of woods and stones under different conditions as to dryness, a most important point, and although, as might be expected, the individual results differ somewhat widely, he considers the mean results give a very fair idea of what may be expected in practice. The author has also tried the effect of soaking the different materials in hot melted paraffin, and finds in every case, especially if the specimen has been previously well dried, that such treatment not only increases the specific resistance, but by preventing the absorption of moisture prevents the falling off in the resistance otherwise observed when such bodies as stone or wood are exposed in a damp place. The following are some of the results for the specific resistance obtained in megohms; the first number denotes in each case the lowest value observed, and the second number the mean value:—Mahogany 310, 610; hard pine 17, 1050; white pine 360, 1470; vulcanised fibre 3, 60; slate 184, 280; white marble 2000, 8800. The samples of wood were all well seasoned, and the resistance was measured in the direction of the grain, the resistance across the grain being generally from 20 to 50 per cent. higher. The samples of stone were dried in the sun for about three weeks before being tested.

A SIMPLIFIED phonograph is described by A. Koltzow in the *Centralzeitung für Optik und Mechanik*. A conical tracing point is used for recording the sound waves. This has the advantage of durability, and if it should wear out on one side, it need only be turned round its axis. The tracing-point is attached to one arm of a lever, the second and longer arm being provided with a membrane. For some purposes the membrane is replaced by a stretched string. The cylinders consist of a very hard soap. They will stand several hundred renderings. After use they can be turned down by 0.02 mm., so that one cylinder will suffice for 200,000 words.

IN the *Comptes rendus* of the Paris Academy of Sciences of the 1st inst., as briefly stated in our abstract last week (p. 576), Prof. Mascart presented a note by the Abbé Maze, stating that in a collection of astronomical documents at the National Observatory, a register had been found containing thermometrical and other observations made by the astronomer I. Boulliau, between 25 May, 1658, and 19 September, 1660. Up to the present time, it was not known that observations had been made at Paris prior to those of Lahire. These observations are of some interest, being among the earliest thermometrical readings on the continent, and they fill up a gap in the climatological history of Paris. It is also noteworthy that the thermometer used was one of the Academy del Cimento.

A RECENT number of *Modern Medicine and Bacteriological Review* contains a notice of Dr. Pictet's interesting experiments on the application of intense cold as a therapeutic measure. According to this investigator's observations, calorific radiations of a lower temperature than  $-65^{\circ}$  pass through all the ordinary conductors of heat; a fur overcoat or a wooden board offering no more resistance than a pane of glass or other transparent medium to the passage of a sunbeam. Dr. Pictet experimented upon himself in a frigorific well, in which a temperature of  $-100^{\circ}$  C. to  $-110^{\circ}$  C. was maintained. He was wrapped in warm clothes and thick furs, and at the end of four minutes he stated that he experienced intense hunger, which increased; after eight applications of eight or ten minutes

duration his appetite became normal, and his digestion greatly improved.

THE last number of the *Bollettino* of the Italian Geographical Society criticises the proposed nomenclature of some of the rivers of East Africa, as given in a sketch map in the *Geographical Journal* illustrating the explorations of the American traveller, Dr. Donaldson Smith. The names to which the Italian Society objects are those of Dr. Smith himself and of his English companion, Mr. Gillett, which have been applied to the upper and middle course of the Webi Shebeli and the Web respectively. We are bound to admit that the criticism is well-founded, as it is contrary to authorised usage to apply European names when the native names can be ascertained. We have little doubt that Dr. Smith will, before the end of his explorations, discover some features still unknown which may fitly be called after him and perpetuate the memory of his excellent geographical work.

MR. H. RUTGERS MARSHALL, whose work on "Pain, Pleasure, and Esthetics" was reviewed in NATURE (vol. 1. p. 3), contributes to the April number of *Mind* an article, "Emotions versus Pleasure-Pain," in further elucidation of his views. Mr. Marshall is fully alive to the importance of evolutionary development, and his treatment of the emotions is therefore of interest to students of comparative psychology. It is unfortunate, however, that the term "instinct" is used in an extended sense which will scarcely be acceptable to those who approach the subject from the biological side. The phrases, "imitation impulse," "art impulse," "benevolent impulse," would appeal to them as more satisfactory than "imitation instinct," "art instinct," &c., since they have grown accustomed to the application of the term instinct to the manifestation of particular activities. But a consensus of opinion on psychological nomenclature seems at present impossible. And in any case, Mr. Marshall's views are well worthy of careful consideration.

AN experiment of considerable interest in connection with the transmission of optical signals has been performed by M. Charles Henry at the *Dépôt des Phares*. The question was whether rhythm in a succession of signals increases or diminishes their visibility? This was solved by means of a revolving drum, the surface of which contained sixty holes illuminated by a source of light placed at the axle. The drum was 3 feet across, and was driven by clockwork. By varying the speed of the drum and the brightness of the light, and by closing some of the holes at regular or irregular intervals, all the conditions of the experiment could be varied at pleasure. The chief difficulty in this, as in most physiological experiments, lay in bringing the eye back to its original state after each experiment. It was sometimes found impossible, even after keeping in the dark for close upon half an hour, to restore the observer's eye to its original state of sensibility. But it was conclusively shown that it is possible to increase the range through which an optical signal will carry by arranging the succession of flashes according to a sufficiently complex non-rhythmic law.

PROBABLY no better example of an invention borrowed or adapted from nature could be found than is afforded by the sand-blast. As is well known, the invention, now a quarter of a century old, consists of a stream of sand or other abrasive powder, usually dry, but sometimes mixed with water, projected with more or less force and velocity to strike and pulverise the surfaces of glass, stone, metal, and other materials upon which it is directed. The many applications of this method of abrasion were recently described by Mr. J. J. Holtzapffel, at the Society of Arts. It appears that glass is almost immedi-

ately depolished by the blasts now in use, and but a comparatively short time is required to pierce and cut apertures through sheet and plate glass. Stone, marble, slate, and granite are just as amenable to the action of the sand-blast. Iron, steel, and other metals have their surfaces easily reduced, and smoothly or coarsely granulated, according to the force and abrasive powder used. It is remarkable that it is by no means necessary that the abrasive be harder than the material to which it is applied; thus, hardened steel and corundum are readily pierced with sand. The blast is not only in use for producing a uniform granulation on sheet glass; it is also employed for frosting the bubbles of incandescent lamps; and the like; for the decoration of glass ware, and the labelling of graduated measures. In metal, the hard scale, so destructive to cutting tools, is removed from castings and forgings by the blast. On stone, slate, and granite the sand-blast is used for incised carving and inscriptions in intaglio or relief, and for delicate drawing for lithography. A print of a child's head, exhibited by Mr. Holtzapffel, was an astonishing example of the delicacy of treatment obtainable by the process. Among other purposes, the blast is employed for removing fur and deposits in tubes and tanks; for cleaning off accumulations of paint and dirt within iron ships for decorating coat and other buttons; for piercing the apertures in glass ventilators; for marking pottery, and in the manufacture of ornamental tiles; for refacing grindstones, emery, and corundum wheels; for granulating celluloid films for photography; and on wood, to bring out the grain in relief, and, latterly, for blocks for printing. These many and various applications of sand-blast processes show that the art has developed in an extraordinary manner since it was introduced by Dr. Tilghmann in 1870.

DR. H. WILD has published, in the *Zapiski* of the St. Petersburg Academy of Sciences, a very important investigation, entitled "New Normal Air-Temperatures for the Russian Empire." In a former paper upon this subject, the data for the monthly, yearly, and five-yearly means were brought down to the year 1875, while in the present work observations have been included to the year 1890, and comprise materials from no less than 575 stations, of which 44 are new.

THE additions to the Zoologica Society's Gardens during the past week include an Irish Stoa (*Putorius hibernicus*) from Ireland, presented by Viscount Lwescourt; a Grey Parrot (*Psittacus erithacus*) from West Africa, presented by Mr. A. A. Dowty; a Cape Viper (*Causus rhombatus*) from South Africa, presented by Mr. J. E. Matcham; two Elephantine Tortoises (*Testudo elephantina*) from the Aldabra Islands, Seychelles; four Indian Pythons (*Python molurus*) from India, deposited; a Barbary Wild Sheep (*Ovis tragaphus*), born in the Gardens.

### OUR ASTRONOMICAL COLUMN.

LUNAR RIVER BEDS AND VARIABLE SPOTS.—The highly favourable atmospheric conditions at Arcuipa have enabled Prof. W. H. Pickering to make numerous observations which have a special bearing on the question of the existence of water on the moon (*Annals Harvard College Observatory*, vol. xxxii. part 1). In addition to the ordinary rills, Prof. Pickering has catalogued thirty-five narrower ones, which, from their resemblance to terrestrial watercourses, he does not hesitate to regard as "river beds." These are wider at one end than at the other, and the wide end always terminates in a pear-shaped craterlet. Most of them are only a few miles in length, and a few hundred feet in width at the widest part, and except when very deep, they are very difficult objects. The largest and most readily observed has its origin in the Mount Bradley range in the Apennines; its course lies a little north of east, and its total length is about sixty-five miles. There does not appear to

be any reason to suppose that these formations actually contain water at the present time, but Prof. Pickering brings forward other evidence in favour of the presence of a small amount of moisture on the lunar surface.

Certain variable dark spots have been detected in different regions, many of them lying inside craters, others symmetrically surrounding craterlets, and others in the dark *maria*, or "seas." In the central craters, such as Alphonsus, the spots are darkest just after full moon, when shadows are geometrically impossible, and they are invisible when the shadows are strongest. "If called upon to offer an explanation of the phenomenon, we seem forced to call in the aid of water as an active agent." Still, the dark spots cannot be simply ponds, as one of the spots in Alphonsus for a portion of the time covers and darkens the slopes of a small hill near the crater-wall. "This seems to effectually overthrow the hypothesis of a free liquid surface, as well as the suggestion that the dark colouration may be due to frozen ground that has partially thawed. . . . Vegetation would undoubtedly explain away all our difficulties; but before we resort to such an extremity, it is evident that we need more facts upon which to base our theories."

The Mare Tranquillitatis is said to be almost covered by these variable spots, and Prof. Pickering states that the changes may be seen with the smallest telescope, or even with the naked eye; until past first quarter this area is lighter than the Mare Crisium; it then rapidly becomes the darker of the two until after full moon, when it again becomes lighter.

The changes in some of the spots are readily seen in the beautiful photographs which illustrate the memoir.

THE ULTRA-VIOLET SPECTRUM OF THE CORONA.—With spectroscopes in which the optical parts are made of glass, it is only possible to photograph the spectrum in the ultra-violet as far as wave-length 360; but when the spectroscopic train consists of quartz and Iceland spar, a more refrangible region is open to investigation. One of the spectroscopes employed in Africa by M. Deslandres during the total eclipse of the sun on April 16, 1893, was of the latter form, and a plate exposed for four minutes gives for the first time some information as to the coronal spectrum in the extreme ultra-violet (*Comptes rendus*, April 1). The slit of the spectroscope cut the image of the corona along the equatorial diameter, and to facilitate the reduction of wave-lengths, the spark-spectrum of iron was photographed on the same plate. The photograph shows the spectrum of the corona to consist of bright lines superposed on a continuous spectrum. In the blue, the continuous spectrum reaches a height equal to two-thirds the sun's diameter, but it diminishes both in height and intensity until about  $\lambda$  300 it is almost reduced to zero. Forty lines are tabulated from  $\lambda$  308 to  $\lambda$  362; one at  $\lambda$  3170.9 appears to reach a great height in the solar atmosphere, and others at  $\lambda$  3164.5, 3189.5, and 3237.1, are comparable with the hydrogen lines  $H_2$ ,  $H_3$ , and  $H_4$ . The remaining lines may belong either to the chromosphere or corona; but M. Deslandres considers the fact that they are shown with a small image on the slit, to be in favour of the view that they are coronal. Most of the lines cannot be identified with known substances, and they probably represent gases of low atomic weight.

STELLAR PARALLAXES.—A very suggestive investigation of stellar parallaxes in relation to magnitudes and proper motions, has been carried out by Mr. T. Lewis (*Observatory*, April). The parallaxes adopted are the means of the values obtained by various observers, and from these the velocities across the line of sight have been derived by dividing the proper motions by the parallaxes and reducing to miles per second. The conclusions suggested by the tables given are: (1) Leaving out a few of the brightest stars, the parallaxes are constant down to 2.7 magnitude. (2) After 2.7 mag. is reached, the parallaxes are doubled and remain practically constant to 5.4 mag. (3) Up to the 3rd mag. the velocities are very small, averaging about 9 miles per second, while after the 3rd mag. the velocity is 38 miles per second." It seems probable that in our immediate neighbourhood there are a few stars of exceptional brilliancy (about 8) and a few smaller stars, of which nearly 40 are at present known; while stars of mag. 1 to 3 are as a class far outside this inner space, and have very small velocities. The investigation confirms the accepted idea that a measurable parallax accompanies a large proper motion, and shows, further, that this holds good whatever the magnitude of the star may be.

THE SUN'S PLACE IN NATURE.

IV.

THE appearance of the appearance of spectral lines and the fluting having been explained, I now go on to state that the fluting referred to, as seen in the meteorite experiment was not the lines in the spectrum of magnesium, but one of the lines of the spectrum of magnesium (Fig. 17), and we shall see the point. Here is the spectrum of magnesium at the lowest temperature at which we can get any light from it. We have a fluting, which resembles closely the carbon fluting, but in a different part of the spectrum. We see that its brightest part is coincident with a certain part of the spectrum, and it so happens that the position of the line which Dr. Huggins had observed in the nebula lies very near the position of the solar spectrum.

There was one argument out of a great number in favour of the view that the luminosity to which the bright line of the nebula was due, might really be produced in the nebula by collisions of meteorites among themselves, rendering luminous the vapours of magnesium which we knew to be wherever there are meteorites.

Now, an additional argument for that view was found in the fact that almost every observer, including Dr. Huggins himself, had stated that as seen in the spectrum of a nebula the line did not seem to be somewhat brighter on one side to what it did on the other, and references were made to its being more degraded on the left-hand side than it was on the right. I had frequently

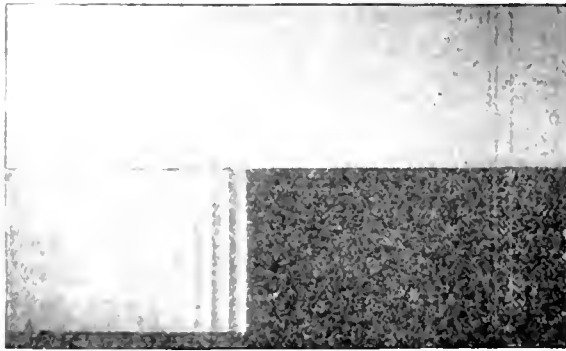

Fig. 17. Spectrum of magnesium at the lowest temperature at which we can get any light from it.

observed myself that the line representing the chief line of the nebula was degraded to the left, never to the right, over parts of the nebula of Orion which were more brilliant than the others; and at the same time that another line—about which more presently—instead of being degraded to the left, like this one, was equally raised off on both sides (Fig. 18), so that the argument was complete that the appearances presented by this line were not due to any instrumental defect, because, in that case, all the lines would have behaved in the same abnormal manner. Hence then I found myself justified in concluding and subsequently stating (1) that the position of the meteoritic dust-line was coincident with the line of the nebula in the apparatus which I used, and (2) that it resembled it in appearance.

What I had next to do in the matter was, of course, to carry the thing as far towards the truth as I could. We can never get to the whole truth, but it is better to have a part of the truth than none at all. Hence I started a new method of attack, which, you will note, differs very considerably from anything you have seen before. I have here a beautiful instrument invented by that eminent Frenchman Foucault, called a "siderostat." The essential part is a plane mirror (Fig. 19) which, when it is properly adjusted to the sun or moon or any star in any part of the sky, lays hold of a beam of light from it about twelve inches in diameter, and sends that beam in a horizontal direction to a telescope, and keeps it there; so that the light falls fairly on the slit of the apparatus, and we can go on observing it for a long time. Next the instrument was adjusted to throw the

light from the nebula of Orion on a powerful horizontal telescope placed in front of a large spectroscope, both rigidly fixed. In order to check the observations as far as possible, I placed in front of the object-glass of the telescope an arrangement by which the light from a magnesium wire might enter the slit of the spectroscope at the same time as the light of the nebula, so that if the light from the nebula and the light from the magnesium wire perfectly agreed in wave-length, we should get one line; if it differed, we should get two.

The slit of this spectroscope was exactly in the focus of the ten-inch object-glass, and then the light was passed through four dense prisms, so that we got a considerable amount of dispersion, and the exact position of the line, whether single or double, was observed. That of course was a very much more powerful dispersion than had been employed by Dr. Huggins in his first observations, and much more powerful than had been employed by myself in my first investigation. But what I wished to do in those first investigations was to understand and to clearly follow the observations which had been made previously by others: if therefore I had attempted to go over the ground with instruments ten times better, giving me ten times finer results than my predecessors had obtained, it would have been the worst possible way to go to work, because it was essential for me to make the necessary comparisons with the old observations while not exceeding the instrumental means which had been employed to obtain them.

The long and short of my various methods of observation was that they seemed entirely to confirm the idea which I got in the first instance from using telescopes and spectroscopes of very much smaller power. That, however, fortunately for

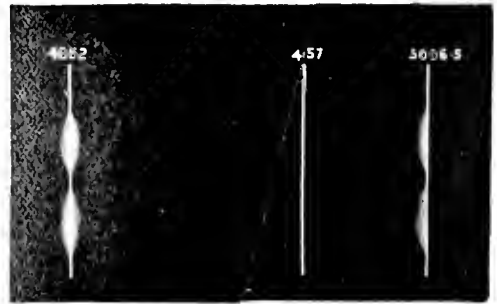

Fig. 18. Appearance of principal lines in spectrum of Orion nebula, as observed at Westgate-on-Sea.

science, did not satisfy Dr. Huggins; he very wisely appealed to the American astronomer, and I am glad to say that the skilful astronomers of the Lick Observatory took up this work with interest, and employed instruments in the investigation more powerful than I possessed, thus carrying matters a stage further. There were really two distinct bits of work to be done: first of all, we wanted the exact position of the line in the nebula, and after having got its right position, its origin could be thought out. We wanted also to see what the real physical appearance of the line was, *i.e.* whether it was most likely a line or fluting. It is not a little curious to note that all the statements which had been made suggesting a fluted character of the line were at once withdrawn when I referred its origin to the magnesium fluting.

The Lick telescope is one of very considerable power indeed, and it is so solidly built that a very powerful spectroscope can be put on one end of it and used under almost the best possible conditions for determining the position of lines. Still the Lick telescope is not the best possible telescope to employ for any branch of work connected with nebulae, if the work requires a great amount of light, because the longer the telescope, the larger the image which the object-glass gives; for instance, if you are dealing with a nebula one degree in diameter, if your one degree is written on a circle with a radius of sixty feet, it will be a very much bigger thing than if on a radius of ten feet, so you get a large image without increasing the light, and therefore are spreading your light over a very large area. As the slit of the spectroscope is a very small thing, all the light which is thrown outside the slit is of no use for your spectroscopic observation, so, whatever the size of the spectroscope may be, you want to deal with the smallest and

brightest possible image in order to get the best use out of your spectroscope, and that cannot be done with a long focus telescope. However, the important question for the American observers was to determine the exact position of the line; and we have lately been given some very interesting results.

Fig. 20 represents the way in which Dr. Keeler puts his last result. The upper part is a reproduction of the solar spectrum; the numbers represent wave-lengths on Rowland's scale. According to his latest value the wave-length of the nebular line is 5007.05. He also shows in relation of the lines of nitrogen as well as the fluting of magnesium, and you see at once that, although according to this drawing the magnesium does not quite correspond with the line of the nebula, it is very much nearer to it than is either the line of lead or the lines of nitrogen. The publication of this result necessitated a fresh investigation, to see what the exact facts were when we no longer compared the nebula with magnesium, but compared the magnesium with the solar spectrum, and therefore sought the true position in which to place the magnesium line in relation to the solar spectrum.

Here is the result. You will see that there is a very small difference between the position of the magnesium fluting and the nebular line. In short, the more the work done on this

nitrogen like that with which we are familiar, but an unknown form of it. There was no doubt from the beginning that another line was a line of hydrogen, although there was some slight doubt as to whether the hydrogen in the nebula behaved exactly like hydrogen on the earth.

Nobody believes in the nitrogen constituent of the nebula now; and I presume Dr. Huggins has withdrawn in fact, if not in words, his statement concerning the coincidence, for in his address as President of the British Association, in which, as I have already stated, he with few his published statement as to the position of the nebula among the various bodies that people speak, he remarks, "the progress of science has been greatly retarded by resting important conclusions upon the apparent coincidence of single lines in spectroscopes of very small resolving power," an *adage* of which every one will see the propriety, for you will gather from Dr. Keeler's diagram that the nearest nitrogen line is three times farther removed from his position of the nebula line than is the magnesium fluting. I trust I shall not be thought to be exceeding the bounds of decorous criticism when I remark that while Dr. Huggins has referred to the inaccuracy of my work in relation to this line, which is apparently indicated by Dr. Keeler's results, he has never pointed out the three times greater inaccuracy of his own.

In order to give you an idea of the relative accuracy which all these references to wave-length indicate, let us suppose that we are trying to define the position of a place in London on an E. and W. line running through Charing Cross, and then you will see exactly how matters stand. Assuming Dr. Keeler's value to be absolutely true—and I expect it is as near the truth as we are likely to get for some time—we will suppose that it represents the nebular line situated on the statue of King Charles at Charing Cross. When Mr. Huggins first measured it, he brought it to the East India Docks; his next attempt brought it to Hammersmith. Dr. Keeler's first observation brought it to Albert Gate; his next, in 1891, brought it to St. James's Palace. Subsequent work at Kensington, not yet completed, has brought it nearer still.

There is another argument in favour of the now accepted view which may be gathered from a careful examination of the forms of these different nebulae, and by endeavouring to reason out from the form what the actual conditions at work may be. One of the most wonderful spiral nebulae in the heavens is that in the constellation of Canes Venatici, which has been photographed by Dr. Roberts (Fig. 7, p. 377). This is a nebula which

we look down upon; we see it in plan; we are, so to speak, at the pole of the system, so that it is not foreshortened.

There is no question about the wonderful spirals being connected with the central condensation and stretching away from it, and the point which I made with regard to the one in Ursa Major is even more decided here, when I call your attention to these points of condensation right along one of the spiral branches, and when you get the possible intrusion of two spirals one on the other you see a confused mass of light. Now, if we imagine ourselves dealing there with a mass of pure gas, whether it is hydrogen or nitrogen or ammonia that is, a combination of both—or any other, it would be extremely difficult to see why there should be any change in temperature in different parts of that mass; but the moment you assume that you are dealing with cool materials—meteoritic dust—you will see that such a picture as this is important to us, for the reason not that it shows us what is there, but because it shows us what is going on there. These bright spots do not represent the presence of matter, and the dark ones the absence of matter; but these brighter portions represent the stream lines where collision is possible—the intervals those regions where collisions are less likely, and you will see from the very configuration of this

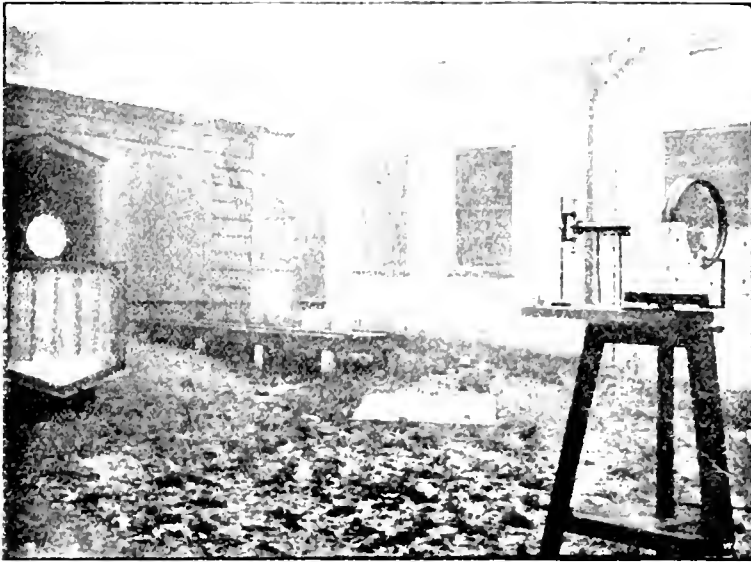

FIG. 16.—Showing obliquity of horizontal telescope used with siderostat.

question the more and more coincident have these lines become, and there are some considerations which have not yet been taken into account.

I have referred to this point somewhat at length, although the coincidence with the fluting of magnesium is not fundamental for the establishment of the view which even Dr. Huggins has now accepted, in the way I have already stated.

Now, what was the chemical constitution of the nebula stated to be as a result of the first spectroscopic observations? Dr. Huggins, in his paper of 1865, to which I have already referred, was of opinion that the chief line was due to nitrogen.

Here are two tubes, one containing hydrogen, the other nitrogen. You will see at once that these two gases, when I set them glowing by the passage of an electric current, are very different in colour; we get in one an excess of red light, in the other we have a purple tinge. When nitrogen is observed by means of a spectroscope, a double line is seen very nearly coincident with the line of the nebula. Dr. Huggins thought that one of the constituent lines was exactly coincident with it, and because there was apparently no line whatever corresponding with the other, he thought also that the nitrogen might not be

system, that if all the dust, or meteorites, or conglomerations of particles, whatever they may be, are going the same way, there will be a condition in which we shall get a minimum of collisions, and therefore a minimum of temperature.

The probability, therefore, is that we are not dealing with gas, but with masses of matter in certain regions of which, in consequence of general action, there is greater luminosity given off by the particles of which the nebulae are composed; in

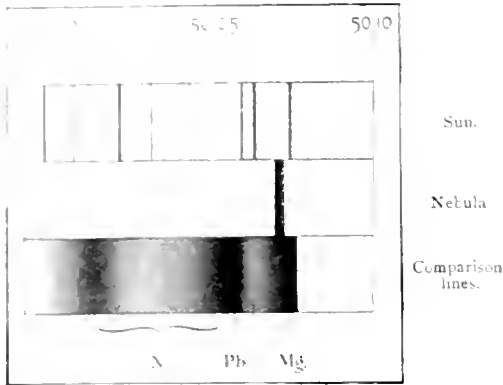

FIG. 20.—N and position of the chief nebular line, according to Keeler.

other regions where there is less action, we have lower temperature and less light.

If, as was at first imagined, these nebulae are gases at enormous temperatures, it would be a question of seeing them or not seeing them; there would be no special parts to be picked out at all. But, in the case of those nebulae to which modern photographic methods have been applied, we find that

the same scale, in which the nebula that we usually see occupies only a very small portion; the only difference between the two photographs is that one has been exposed for a very long time to enable us to fix and to study the very dim reproduction of certain parts of it, whilst the first one was exposed only for a short time, in order that we might dwell effectively on that part only of the nebula which is generally visible to the human eye with an ordinary telescope. (Fig. 2.) If we were dealing with incandescent gas, the incandescent gas ought to leave off suddenly; but all round this nebula, where there appears to be nothing at all, the longer exposure brings before us other portions of the nebula just as rich in details, just as exquisite in their variety and tone as those ordinarily seen with the naked eye. Such a condition as that cannot be brought about by a mere homogeneous mass of gas at high temperature, but we can explain it quite easily by assuming that in such a nebula as that we are dealing with, the luminosity is brought about by disturbances, these disturbances giving rise to collisions among the particles which are apt to collide and give out luminosity. The nearer they are to the centre of gravity of the swarm, the greater will be their chance of collision, and the greater will be the luminosity of their central portion.

Still another consideration. Astronomers, since the time of Kutherford, who was the first to begin stellar spectroscopic work in the United States, between 1860 and 1870, have established many different classes of stars as defined by the chemical substances of which their atmospheres seem to be composed, so far as spectroscopic observations enable us to determine their composition. One group of stars is remarkable for the presence of hydrogen in enormous quantities; we assume that because the lines of hydrogen are inordinately thick. In another we get not so much hydrogen, although it is still there, but the predominant substance is iron. In other stars we get little hydrogen, if any, apparently no iron, but carbon in enormous quantities, and again there is another substance, the quantity of which varies enormously, and that is calcium. Now, if stars contain all these different substances, and if they represent epochs of evolution, they must be produced from something which actually or potentially contained these substances, so that there again you get a considerable argument in favour of the chemical complexity of the nebulae.

Finally, we reach the second point. It is now generally conceded that the first stage in the development of cosmic bodies is not a hot gas, but a swarm of cold meteorites. From the point of view of evolution, keeping well in touch with the laws of thermodynamics, the nebulae must begin cool if they are to develop into hot stars.

J. NORMAN LOCKYER.

(To be continued).

NEW COMPOUNDS OF PHOSPHORUS, NITROGEN, AND CHLORINE.

A SERIES of new compounds of phosphorus, nitrogen, and chlorine, and likewise a series of acids derived from them, have been discovered by Mr. H. N. Stokes, and an account of them is contributed to the *American Chemical Journal*. A familiar compound of the three elements in question, the chlorophosphurett of nitrogen, discovered by Liebig in 1832, has been the subject of frequent study, and its nature has comparatively recently been very fully demonstrated by Dr. Gladstone. It has been shown, from vapour density determinations, that this remarkably stable compound, which may be distilled in steam and boiled with acids and alkalis without appreciable change, possesses the molecular composition  $P_3N_3Cl_6$ . Mr. Stokes now shows that this substance is only one of a homologous series of compounds having the general formula  $(PNCl_2)_n$ , and that these are the chlorides of a series of acids  $(PNO_2H_2)_n$ , which he terms metaphosphimic acids. The second member of the series,  $(PNCl_2)_2$ , has been isolated from the product of Dr Gladstone's reaction for the preparation of  $(PNCl_2)_3$ , that be

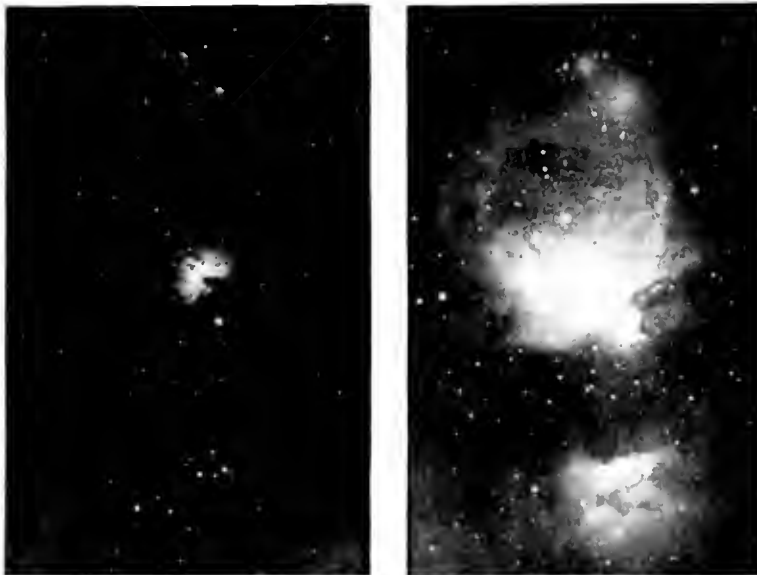

FIG. 21.—Orion nebula photographed with short and long exposures.

the nebula which we see ordinarily in our telescopes is only a very, very small fraction of the real nebula as it really exists, when we can get at it under the best possible observing conditions. Many of you, I hope, have seen the nebula of Orion in an ordinary telescope. Here it is as it has been photographed by means of a telescope powerful enough to give us the brighter portion. Here is another photograph of the nebula exactly on

tween phosphorus pentachloride and ammonium chloride; it is a substance almost as stable as the triple compound, and yields on saponification the acid  $(\text{PNO}_2\text{H}_2)_3$ , which is likewise a stable body. Moreover, the acid corresponding to the triple compound has been isolated, and also a higher chloride  $(\text{PNCl}_2)_x$  of an oily character, and whose molecular weight has not yet been ascertained. In describing his repetition of Dr. Gladstone's work, Mr. Stokes incidentally mentions the interesting circumstance that the triple compound readily forms enormous crystals, well-developed prisms several inches long and of considerable thickness being frequently deposited from benzene, and indeed their size appears only to be limited by that of the containing vessel and the bulk of solution. These crystals melt at  $114^\circ$ . The quadruple compound melts at  $123^\circ 75$ , and boils at the normal pressure at  $256^\circ 75$ . It crystallises well in colourless prisms, which are usually much smaller than those of the triple compound, and exhibit great tendency to develop an acicular character. It is less soluble in alcohol and benzene than the latter compound; it may be recrystallised from glacial acetic acid, but it exhibits a great aversion for water, not being wet by it, and consequently the crystals float on water. It dissolves in hot concentrated oil of vitriol, but upon boiling most of it sublimes unchanged, an evidence of its great stability. Its vapour is endowed with a pleasant aromatic odour, but inhalation of more than traces is followed in two or three hours by alarming difficulty in breathing and persistent irritation of the air passages. Its vapour density was determined in an atmosphere of hydrogen, and indicated the quadruple formula. Even boiling water exerts only a very slight action upon it; but a smooth decomposition is effected by dissolving in ether, and repeatedly agitating with water. The acid produced is deposited from the water in crystals having the composition  $(\text{PNO}_2\text{H}_2)_4 + 2\text{H}_2\text{O}$ . This interesting acid readily decomposes soluble chlorides, nitrates, and sulphates, forming three series of salts, in which respectively one-fourth, one-half, and all the hydrogen is replaced by the metal. The free acid is so highly stable that it may be boiled for hours with nitric acid or *apua regia* without decomposition. Further details concerning it, and the other compounds isolated, will shortly be published.

#### BIOLOGICAL WORK ON THE ILLINOIS RIVER.

ILLINOIS possesses a good Laboratory of Natural History, in which Prof. S. A. Forbes, with a number of assistant entomologists and zoologists, carry on investigations of value to science and the State. A report on the work of the Laboratory during the past two years has recently been issued. To us the points of special interest with which it deals are (1) the establishment, in 1894, of a biological station for the continuous investigation of the aquatic life of the Illinois River, and its dependent waters, near Havana; and (2) an elaborate experimental research carried on during the past year to determine means for the destruction of the chinch bug, and especially for the dissemination of the contagious diseases of that insect. This investigation was undertaken by the Laboratory staff, with the co-operation of the State Agricultural Experiment Station.

We have already noted the establishment of the biological station (*NATURE*, vol. 1, p. 275, 1894), but as it is the first inland aquatic biological station in America, manned and equipped for continuous investigation, the following further details are interesting. By the kindness of Prof. Forbes, we are able to illustrate the description with two of the fifteen fine process plates contained in his report.

The Station was opened just a year ago. Its general objects are to provide additional facilities and resources for the study of the natural history survey of the State, now being carried on by the State Laboratory of Natural History; to contribute to a thorough scientific knowledge of the whole system of life existing in the waters of this State, with a view to economic as well as educational applications, and especially with reference to the improvement of fish culture and to the prevention of a progressive pollution of Illinois streams and lakes; to occupy a rich and promising field of original biological investigation hitherto largely overlooked or neglected, not only in America but throughout the world; and to increase the resources of the zoological and botanical depart-

ments of the University of Illinois, by providing means and facilities for special lines of both graduate and undergraduate work and study, for those taking major courses in these departments.

The Station differs from most of the small number of similar stations thus far established in the United States, in the fact that its main object is investigation instead of instruction, the latter being a secondary, and at present an incidental, object only. It has for its field the entire system of life in the Illinois River and connected lakes and other adjacent waters, and it is Prof. Forbes' intention to extend the work as rapidly as possible to the Mississippi River system, thus making a beginning on a comprehensive work in the general field of the aquatic life of the Mississippi Valley, in all its relations, scientific and economic.

The special subject which Prof. Forbes fixed upon as the point of direction towards which all the studies shall tend, is the effect, on the aquatic plant and animal life of a region, produced by the periodical overflow and gradual recession of the waters of great rivers, phenomena of which the Illinois and Mississippi rivers afford excellent and strongly marked examples. This field of research is entirely fresh, and at the same time is highly interesting and important.

As an incidental, but by no means unimportant, result of the work, material will be accumulated for a comparison of the chemical and biological conditions of the waters of the Illinois River, at the present time, and after the opening of the Chicago drainage canal.

The practical importance of the undertaking, as affording the only sound basis for a scientific fish culture, will be fully recognised by all who are seeking to apply scientific methods of investigation to economic problems.

It is pointed out that the Station will also serve as a centre of interest and activity for University students engaged on zoological and botanical subjects. Not many years ago biological instruction in American colleges was mostly derived from books; of late it has been largely obtained in laboratories instead; but Prof. Forbes believes that the mere book-worm is hardly narrower and more mechanical than the mere laboratory grub. Both have suffered, and almost equally, from a lack of opportunity to study nature alive. One knows about as much as the other of the real aspect of living nature, and of the ways in which living things limit and determine each others' activities and characters, or in which all are determined by the inorganic environment.

Means are provided by which students, and intending teachers of biology, may be given a wider knowledge of their subject, and where they may investigate experimentally the problems of mutual influences and relationship in the living world.

Possibly still more important is the opportunity which the Station will offer, when permanently established and fairly well developed, to the independent student and investigator, zoological or botanical, who may desire to pursue his studies in the field covered by the operations. It is a part of the plan of organisation and equipment to receive and assist in every practicable way advanced students and investigators of this description, from whatever place they may come.

Havana was selected as the site of the Station because of several unique advantages offered by that locality. Streams and lakes illustrating practically all the typical Illinois River situations are to be found there, convenient of access from a central point, and from each other. An extensive sandy bluff, commonly well shaded and oozing spring water at its foot, borders the river bottom on the east, and introduces several unusual features of interest to the oecologist, besides affording a clean and hard shore to work from, dry, shady, and well-drained camping ground, and an abundance of very pure cold water at all times of the year.

A "cabin boat" was used as a field headquarters, and stationed on Quiver Lake, two and a half miles above Havana. It carried the seines, sounding lines, aerial and aquatic thermometers, dredges, surface nets, Birge nets, insect nets, plankton apparatus, and other collecting equipment, together with microscopes, reagents, a small working library, a large number of special breeding cages for rearing aquatic insects, and a few small aquaria. This boat was provided with sleeping accommodation for four men, and with a well-furnished kitchen.

The greater part of the field work was done on seven regular stations, visited periodically throughout the year; two on the



Fig. 1. View of Hill of Quarries, West Side.

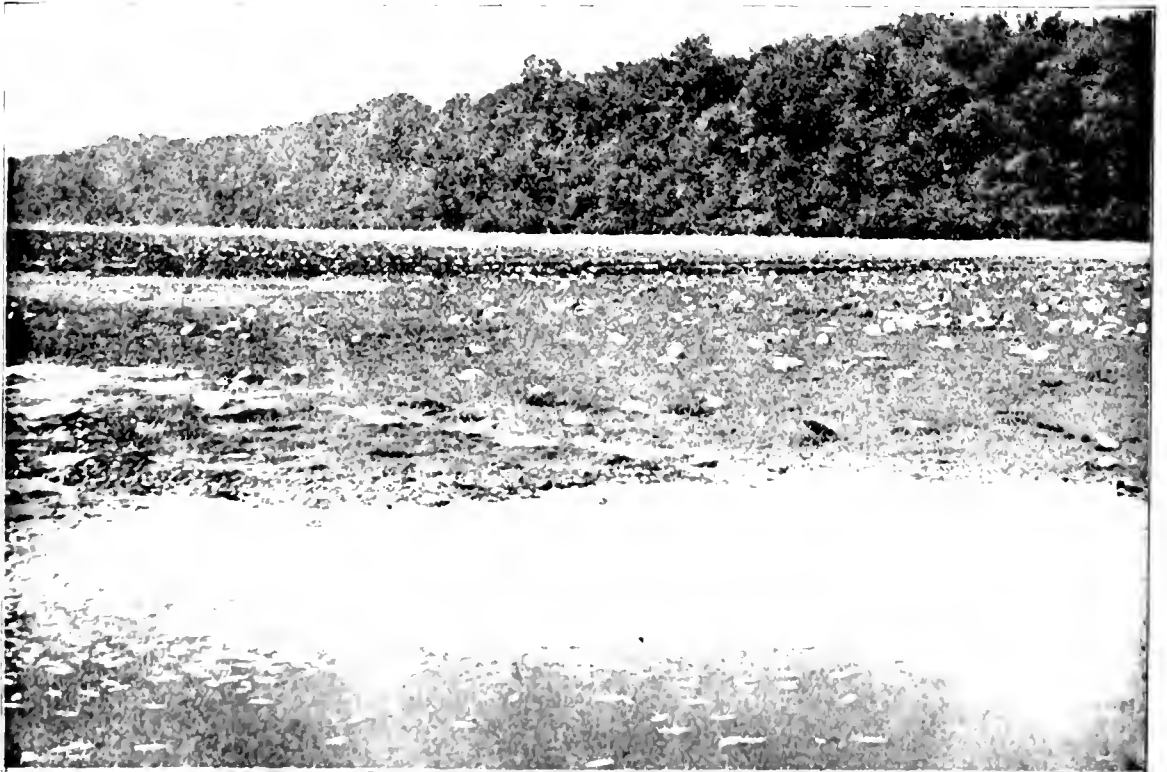

Fig. 2. View of Hill of Quarries, East Side.



Illinois River, three on Quiver Lake, and one each on Phelps and Thompson's Lakes.

Quiver Lake (Fig. 1, in which the headquarters' boat was placed, is an abandoned portion of the old bed of the river. It varies in length (when the water is low enough to define it clearly) from one and a half to two and a half miles, and has a usual width of about five hundred feet at low-water mark. It lies nearly parallel with the main river, into which it opens, even in the lowest stage of water, at its lower or southern end, by about half its greatest width.

Thomson's Lake lies wholly within the bottom lands of the main river, and its banks are consequently everywhere low and flat. It is five miles in length by about half a mile in width at an average midsummer stage. Neither this nor Quiver Lake ever goes dry, the water in the deepest places being not less than three and a half or four feet during the driest seasons. Phelps Lake (Fig. 2), on the other hand, is a pond about half a mile long by a fourth as wide, having neither inlet nor outlet after the overflow has receded, rarely drying up entirely, but not infrequently being reduced to a few shallow pools. It is completely surrounded by a bottom-land forest, and its bed is a mere shallow depression in the mud.

The results of the first season's work are, of course, but just beginning to appear. Indeed, the problems to be solved in such situations have scarcely more than dimly shown themselves as yet, but the promise is nevertheless already very interesting. Notable contrasts in kind and number appear between animals of the springy shore of river or lake, and those of the muddy bottom, only a few rods away on the other side; between river and lake; between Quiver and Thompson's Lakes; between each of these and Matanzas Lake; and between all the other lakes and the temporary pond distinguished locally as Phelps Lake—contrasts sometimes easily comprehensible; and sometimes peculiarly puzzling, like that between Quiver Lake on the one hand, the waters of which are choked in mid-summer with a dense growth of aquatic vegetation, but contain fewer of the smaller animal forms (Entomostraca, and the like) than the open current of the river itself, and Thompson's Lake, on the other hand, where the water is relatively clear of aquatic plants but abounds in rotifers and Entomostraca. Still more curious is the contrast between the similarly situated and very similar lakes, Quiver and Matanzas, the waters of one loaded and clogged with plants, and swarming with small molluscs and insect larvae, and those of the other with scarcely a trace of even microscopic vegetation, and with a correspondingly insignificant quantity of animal life.

One surprising result is the abundance of minute life in the main stream, which sometimes contains a greater abundance of animal forms than most of the lakes connected with it; and another is the relatively small difference between the animals frequenting widely unlike situations in the same body of water. A large number of new forms were found, especially among rotifers, worms, and insect larvae. The collections of the season, preserved for detailed study, are included under nine hundred and fifty-eight collection numbers, representing as many different lots of specimens. In connection with these, Prof. Forbes and his assistants are now engaged upon determination work and other laboratory studies, and the preparation of reports. The papers and reports embodying these studies will be printed in the *Bulletin* of the Illinois State Laboratory of Natural History. So far as possible, each general taxonomic paper will be preceded by a thoroughly practical synopsis of genera and species, illustrated by figures of typical forms, and intended to open up to the student and teacher of natural history in Illinois many interesting and important parts of the local zoology.

### THE VARIETIES OF THE HUMAN SPECIES.<sup>1</sup>

IN man, as in other animals, we find physical characteristics of two kinds, external and internal. The first are principally those pertaining to the cutis and certain cutaneous appendages, and include the colouring of the skin and hair, the structure and form of the hair, and also the colouring of the eyes. The chief internal characteristics are the bones from which the form and figure of all the members are taken, as well as those of the

separate parts of the body clothed with soft tissues, such as muscles and fat. The cranium is the most important and most characteristic part of the entire human skeleton.

The cranium is a bony case which encloses a viscous of the first order, the brain, which in man is, in relation to the animal series, better developed, both in its forms and functions. It is known that the brain and cranium, from the embryological to the adult state, are in a parallel manner and gradually connected in evolution, and the external form of the one corresponds to that of the other. Most certainly it is not the cranium which gives form to the brain of man; it is more probable that it is the brain which moulds its organ of protection. Given hereditary conditions, we may affirm that the form of the cranium is correlative to that of the brain. If we could discover why the brain takes or has taken different forms, we would possibly understand better its correspondence with the exterior structure of the cranium by which it is surrounded. We might be able to learn also what functional and especially what psychological characteristics are united to the cerebral forms which are revealed by cranial forms. All that is obscure for us, and also unexplored, because unsuspected; for in place of that, and in an inexact manner, the volume has been taken into account, and therefore the weight of the brain, as being the only means of making an anthropological diagnosis of its functional value, the volume and weight corresponding to the capacity of the cranium.

But besides the cranium commonly called cerebral, there is the face, which, from the morphologic point of view, is not less important. The face has generally given more positive means for distinguishing human groups, not only on account of the colouring of the skin, but on account of the form and disposition of its parts, of the nose, of the cheeks, of the molar teeth, and on account of other characteristics which, when considered together, disclose differences not immediately revealed by the cerebral cranium.

The other parts of the skeleton also have differences more or less profound in the different ethnic groups, the stature, the length of the extremities both absolutely and relatively to the stature and to the trunk; the thoracic form, and so on. But such differences are but slightly characteristic in comparison to those presented by the cranium and the face; until now, moreover, they have had but slight value, the reason being that they are derived from characteristics which are merely secondary.

We are ignorant what may have been the primitive type or the primitive human types, considered in all their internal and external characteristics; that is, what skeletal forms certain ethnic groups of differently coloured skin possessed; or, on the other hand, what colour of skin and hair belonged to certain skeletal forms. That difficulty is caused by a fact easy to understand, by the mingling of different types among each other, and by the hybrid forms from which man is derived. It is true, however, that certain hybrid results seem to be limited to certain regions and to a few human groups; and that, on account of this, the elements which have furnished such products may be learned up to a certain point; but in the beginning, at least, it will be necessary to learn the structures of the parts from which hybrids are derived.

It is impossible not to admit human hybridism, since it is demonstrated clearly by all anthropologists; in this direction America alone shows us a perfect example of experimental anthropology. It has been determined from observations that human hybridism is multiform among all peoples; but what we learn from the facts relates to the exchange of external characteristics and their mixture with those internal, that is, the union of the external characteristics of one ethnic type with the internal characteristics of another type. Thus, one may observe the colour of the skin and hair with its special form united to characteristics of skeletons which do not generally belong to types of that colour, and *vice versa*. That may be observed concerning certain characteristics, and not of all; such as the stature, or the face, with its soft covering, or the form of the cranium only.

If we study our European populations which are called white, but which have many gradations of whiteness, we may note the great mixture of characteristics, a mixture which is changeable, from which results a great variety of forms of individual types, constituted of characteristics differing from each other. An analysis must be very accurate and very minute to discriminate these different elements which exist in the composition of the ethnic characteristics of individuals

<sup>1</sup> Extracted from a translation of Prof. Giuseppe Sergi's "Le Variet  Umane," published by the Smithsonian Institution.

and peoples. These mixtures and these combinations of characteristics differ according to the character and number of elements existing in the various nations of the south, the centre, or the north of Europe. They arise from different relations with mixed peoples.

What is most important in this human hybridism, so various and so complex, is the lack of the blending of the external and internal characteristics from which new human varieties may be had. Among the different ethnic elements there exists only a relation of position, called syncretism, or propinquity of characteristics, and therefore a facility for forming small groups. Such a phenomenon has already been recognised in America, and it is evident in Europe among peoples who appear little homogeneous, if a careful observation separates the characteristics constituting ethnic types and those of individuals in a mixed population.

If there were no other cause for such an absence of blending among the characteristics of human hybridism, this cause would exist, that the relations which produce the mixtures are not equal and constant, but are varied and inconstant. If there should be the union of two pure ethnic types only, for several generations, we should be able to derive a hybrid product constant and fixed, as among animals and plants; but a third element, either pure or mixed, arrives in the second or third generation of man, and so on indefinitely. Thus it is easy to understand how unstable must be the characteristics of the hybrid, for they can scarcely survive in one individual for a generation. The hybrids which follow may have characteristics of different types, with the tendency each time to have these reappear by heredity, although not blended and not fixed in the individual.

To this should be added another fact, that of individual variation, which is present in man, as in other animals, increased by his constant interminglings, which may be considered stimulants of this phenomenon, as has been suggested by Darwin and Wallace.

Hence, I conclude from my observations, that human hybridism is a syncretism of characteristics belonging to many varieties, and that these do not modify the skeletal forms as do individual variations, and that hybridism may affect different parts of the skeleton, constituting characteristics in themselves distinct. The stature, the thoracic form, the proportion of the long bones, may be united with external characteristics differing from each other, as well as from different cranial structures. The cranial form may be associated with different facial forms, and inversely. It happens, however, that the structures taken separately remain in part unvaried in the hybrid constitution. The face preserves its own characteristics in spite of the union of different cranial forms; so also the cranium preserves its structures, associating them with different facial forms. The stature preserves its own proportions in spite of its associations with different cranial and facial types, and in spite of the different colouration of the skin and the form and colour of the hair. All this may be affirmed, particularly of much larger human groups which, according to external characteristics, may be considered much nearer than they really are in geographical position, as the so-called white races in Europe, the negroes in Africa, in Melanesia, and so on.

Now, granting that all peoples exhibit the characteristics of hybridism in the manner just described, it will be necessary to learn how races, groups and human families may be classified. Let us observe for a moment the classification by means of external characteristics, most common among anthropologists from Linnæus to Quatrefages and Flower, and we shall see:

(1) That the colour of the human skin in one great group of a type, such as yellow, black, or white, is of different gradations, and not uniform.

(2) Since, as above stated, all peoples, at least in a great measure, are composed of hybrid elements, it happens that different elements are united under one category, which is, in this instance, the colour of the skin.

(3) We must not forget that the external characteristics are more easily lost, and much easier to acquire, by intermixture and heredity.

A curious example of what I state is found in human classification according to Quatrefages, which perhaps is now the only complete, considered only as a classification by external characteristics. He places the Abyssinian within the white race with nothing that they have the negro colouring, and he says he can believe that the characteristic form of the

skeleton or internal characteristics of the Abyssinians are those of the white race. This is without doubt inconsistent when the principle of classification by colour is accepted. This inconsistency itself shows the defect of the method and of the principles mentioned as applied to human characteristics and their combination.

(4) Finally, as we perceive, the theory is not justified that man be classified as a single species with three, five, or more variations.

If the characteristics which present greater stability are internal or skeletal, they should serve for human classification:

(a) Because, notwithstanding amalgamation and consequent hybridism, the characteristics originating in the skeleton are persistent.

(b) Because they may be taken as fixed points with which other characteristics may be associated, and may be also external, as I shall demonstrate.

(c) Because, finally, the internal characteristics can demonstrate the full number of divisions and subdivisions in classifying ethnic groups, and in analysing peoples which are a combination of a great number of hybrids.

It remains to determine which internal characteristics should have the preference in deciding the value of types for classification. If we consider the human skeleton, with that object in view, we find three parts which may serve for that purpose, the cerebral cranium, the face, and the stature, with the long bones.

*Stature.*—The stature is a good, but an insufficient characteristic, because it gives only linear differences, and in its value resembles greatly other external characteristics, and is associated with all the most dissimilar derived from the skeleton.

*Face.*—The face offers very important characteristics for classification, because it shows typical differences in the ethnic groups. The face has given more points for the distinction of human types than the other parts of the human body, and would appear better adapted for that purpose than the cerebral cranium. But the face is more disposed to individual variations than any other part, because it is very complex, being composed of numerous small bones, clothed with muscles which have continuous and important functions relating to the physiognomy, to the expression of psychical conditions, and to the nutritive functions. These facts render its typical form less constant, and are, or may be, the cause of a multiplication of types.

*Cranium.*—The cerebral cranium is itself also liable to variations. More than any other organ, it exhibits a phenomenon often observed and clearly demonstrated by me, that is, the persistence of forms from immemorial epochs, and their reproduction through numerous generations notwithstanding amalgamation with other types. I have demonstrated such a persistence of cranial forms in the varieties of the Mediterranean from the Neolithic and from the most ancient Egyptian epochs; other anthropologists have recognised such persistence in European types of the Quaternary epoch, and in others, very ancient, from America. This cannot be said of the structure of the face.

Therefore if the human cranium is accepted as a basis for the classification of human groups, positive results may be had:

(a) In groups which have been subjected to mixture in whatever epoch or however many times, the distinctive ethnic elements may be discerned by examining the cerebral cranium only, which, remaining unaltered in type, may be found united by hybridism with other internal and external characteristics. For the cranium is the point about which revolve all other variations of form, either in hybridism or in the human form itself.

(b) Knowing the cranial types of a people who seem more or less homogeneous, we are sure of learning of what and how many ethnic elements it is composed, notwithstanding the hybridism present.

(c) Having classified all the cranial types in different regions and among different peoples, we may learn by their geographical distribution the numerical extension of types and also their geographical origin; that is, the place of departure and the course of emigration and dispersion of such forms.

(d) Then it will be easy to learn what cranial characteristics are found among populations which already have ethnic names, ancient and modern, and to discover among them points of similarity and difference.

Being, therefore, obliged on account of universal human hybridism to select as a guide to classification the most important and the most useful of the internal characteristics, we find

greater advantages in choosing the human cranium, about which all the other characteristics, internal and external, are grouped. If we select one characteristic, or a number of variable characteristics, we shall find ourselves in the same position as other anthropologists who classify by external or accessory traits. It follows that, accepting the cranium as the principal internal characteristic, we impliedly accept the brain in its various forms, and the brain is the most important of human organs.

The classification of man by means of the cranium alone is by no means new. It will be well to consider these schemes, from that of Retzius down to the last, that of Kollmann. Nor, indeed, is the conception of the importance and superiority of the cranium for distinguishing ethnic groups by any means recent. To show that, we have but to refer to the enormous work which has been done, from Morton to Davis and Thurman, from Broca to G. Retzius, to De Quatrefages, to von Horder, to Ecker, to His and Rutimeyer, to Virchow, to Ranke, to others still more numerous, in Italy, from Nicolucci to Mantegazza.

Notwithstanding so much labour expended on the human cranium, satisfactory results were not reached, nor, indeed, I may affirm, have we yet reached them, at least not in the significance which I intend these results to have. The fault lies in the nature of the method of studying the human cranium, and in the value attributed to craniometry.

The classification of Retzius is based upon a single characteristic of the cranium, which, however, is merely the numerical expression of the *norma verticalis* of Blumenbach, that is, the cephalic index.

According to Retzius we have only two forms of crania, the long and short; though, in fact, many forms of short and long crania are found differing very much from each other.

When craniometry was developed in a systematic manner, following principally the work of Broca, it appeared the key of anthropology, and took the first place among means of investigations, as being the most effectual method for distinguishing human races. The French exaggerated its value; the Italians followed with zeal, in spite of the scepticism of Mantegazza, the head of the Florentine school of anthropology; the Germans have been more rational, and with them the Swiss, represented by His and Rutimeyer. At the head of them I would place Blumenbach, who based his small but valuable book upon a rational foundation.<sup>1</sup> The Germans try to establish cranial type almost or entirely independent of the cephalic index; as one may see from the works of von Horder, of Ecker, of His and Rutimeyer, of Virchow, of Kollmann, of Ranke and others. In my opinion the German method is an approximation to the truth, but unfortunately the conception of type is undeveloped and, I should say, has remained rudimentary, because craniometry, like a pernicious weed among the grain, injures the harvest. Virchow, the most pronounced scholar in anthropology, and the man who has studied more than all others the crania of all peoples, believes that the germ of a sound anthropology should develop from it, and concedes only a secondary value to craniometry.

According to my observations upon craniometry, which has now become cabalistic, especially in France, on account of the abuse of measures and numerical ciphers, the indices of the cranium and face are taken as a means of distinguishing races, human groups, as we might call them, and other measures are either omitted or applied only to individuals. In order to be convinced we should carefully and conscientiously study the craniometrical works of Dr. Danielli, of Florence, upon the Nias and Bengalese. The author has not been able to find satisfactory results after persevering researches, but whoever would seek evidence of individual variations will find more than enough. It seems to me, therefore, that the method by measurement may serve this purpose, that is, to discover numerically individual differences, but never those typical of a race. But such a discovery is useless, since we are all convinced of the existence of individual differences. I will therefore add that such differences, to be valuable, must be sought, not among forms differing from each other, but among individuals of the same type. That implies, therefore, necessarily and always, the search for types and their distinction, which is not possible by means of the craniometrical method.

If it were true, and there were no doubt respecting the value of the celebrated cephalic index in determining cranial forms, it would follow that all human crania of whatever type and volume

should be placed in the three categories of dolicho-, meso- and brachycephalic, or of hypsi-, ortho-, and chamacephalic. Thus all the populations of the earth, either of white, yellow, black or red skin, would have crania belonging to the three categories. A classification solely according to the cephalic index is therefore an absurdity. It is incoherent and without meaning, as are those of Retzius and Kollmann.

This conclusion is so true that such anthropologists are obliged to add descriptions to the forms of each part of the cranium, in order to distinguish it, recognising the insufficiency of cranial data. Such descriptions can, to a certain degree only, supply the defect of the method, but they always remain incomplete, and leave the forms or types of the human cranium of various populations and regions indefinite. The French school has gone still farther, and has supplied the deficiency with an infinite number of measurements, which only increase the obscurity, leaving the conception of the form more uncertain, and fatiguing the most patient student, who becomes convinced of never reaching any satisfactory result from such a confused accumulation of numbers.

In order to render classification more definite, or for the sake of finding a second characteristic which might be associated with the cephalic index, Retzius turned his attention to the prognathism and the orthognathism of the molar teeth; Kollmann to the facial index. Use could be made of the nasal index instead of the facial, or the orbital index, or any isolated characteristic, and we should have the same results. The combinations given by Retzius and Kollmann are possible, but cannot indicate races or varieties, from the fact that they are hybrid associations.

I need not make a longer demonstration of what I have affirmed, that classifications of human groups have been attempted by means of the cerebral cranium, but have not been successful on account of deficiency of method; and that the craniometrical method, still so undeveloped, has not yet, nor cannot, give those results while there is an exaggeration of an exact principle, that of expressing numerically facts relating to the cranium. It seems to me, after several years of study, and after having adopted the accepted form of craniometry, for want of a better, that it is time to establish for our use and for the study of the variations of man, a natural method, resembling that which is used in zoology and botany, and of which I laid the foundation about two years ago.

With the observations and the methods which I propose, I believe that many errors will be eliminated from anthropology. Those errors have been accepted because we have never possessed natural scientific methods for the study of human classification, such as we have in zoology. Blumenbach, in a valuable little book, attempts to apply the zoological method to man, not only for classification, but for the explanation of the causes of animal and human varieties. De Quatrefages, in his last work, employs the same method and the same scientific freedom. Unfortunately the followers or successors of both have only followed their masters in form, but not in method. Blumenbach, who, after various researches, reduces the human species to five varieties, finds, however, that human variations are infinite in number. If his method had been followed strictly, the number of human varieties would long ago have been increased, both in respect to the structure and the cranial forms.

The neglect of such methods and the failure to distinguish human varieties by means of the cranium has caused a curious error, that of regarding certain forms which are typically normal, as pathological, as I shall have occasion to demonstrate in the future when I speak of classified forms. This is apt to happen when new and unrecognised forms are placed before the observer.

One of the important characteristics in classifying the cranial varieties of man is the *cranial capacity*, which has a direct relation to the volume and weight of the brain; hence classification by crania means the classification of brains estimated by their form and external configuration. Its importance is for us increased by the fact that that which we find among races of animals occurs also in man; that there are races of small and large animals, races differing in size. This is also repeated in man, and we therefore have large, medium and small varieties, as measured by stature. The origin of such varieties is perfectly analogous to that in other animals. Nor is it an accidental phenomenon, because it is confirmed by heredity, through numerous and indefinite generations.

I have concluded, in studying cranial varieties morphologic-

<sup>1</sup> "De generis humani varietate nativa." IIIa edit. (Göttingen, 1795)

ally as human varieties, that is, by their characteristic structures, that the volume has a direct relation to the form, in other words, many forms have limited and definite capacities, while other forms have sub-varieties differing in capacity. Such varieties are analogous to the stature of the large and small varieties of animals. The cranial capacity, therefore, while it is one of the integral characteristics of the cranium in regard to its classification, is also the indication of different varieties according to size. I discovered this fact when I classified for the first time the crania of Melanesia, and subsequently I defined it more accurately when I examined and classified thousands of other human crania.

This fact points to a correction of the value of cranial capacity and, therefore, of the weight of the brain, until now calculated by the average without distinction among different varieties. The cranial capacity of man varies from 1000 cc. to about 2000 cc. in the masculine sex; this enormous difference is admitted as individual variation, and it is thus conceded that there may be a least limit of normality possible which can be ascribed to the function of the brain, crania which descend to 1150 cc. being considered as pathological microcephali, according to Broca, and more or less according to other anthropologists; giving, on the other hand, a great value to a large capacity. Both conclusions are contrary to the real significance of the facts. I have found normal masculine capacities of 1000 cc. and a little greater, representing small human varieties, not being sporadic and individual phenomena; and, on the other hand, anthropologists have registered for eminent men, like Dante, Gauss, and others, very mediocre capacities, even very low, while for ordinary men they have recorded a much higher capacity. I have found in Melanesia normally constituted heads of absolutely microcephalic, together with megalcephalic heads, belonging to varieties which have the same social value; they are both inferior, some anthropologists, and live mixed together as one people. That which I have asserted concerning Melanesia may be said of the ancient and modern populations of the Mediterranean, among which are the Sicilians, the Sardinians, and the inhabitants of Central and Southern Italy; and I do not believe it can be said that there are no signs of human superiority in those regions. There are not, therefore, individual differences so great as from 1000 to 1500 cc., and from 1500 to 2000 cc., but characteristic differences of variety in human forms. The general average I theretofore maintain is inexact and also arbitrary, because it is the average of incommensurate quantities. The exact average is that between individuals of the same variety, and the difference is the true individual variation.

But there is another error to correct, due to the signification which I am able to give to varieties distinguished by means of my method. It is considered by some a demonstrated fact that the cranial capacity has been increased in the course of social evolution from prehistoric epochs to historic times. Eminent men have affirmed it, but I have already placed their conclusions in doubt, because the facts do not appear to me evident and alternative. I wrote some years ago: "The most important physical evolution of man would be that which related to the organ of the mental functions, the brain. But the facts are still very doubtful and very obscure which relate to the weight and volume of the brain, and consequently to the cranial capacity. In a recent work of Prof. Schmidt, I find that the cranial capacity of the ancient pure Egyptians is 1394 cc. in the masculine, and 1257 in the feminine sex; in the pure modern Egyptians it is 1421 in the males, 1206 in the females. Accordingly, therefore, there would be an increase of the cranial capacity of the modern over the ancient males, but a decrease in the females. The reverse would be true of the Egyptian population, which in 1355 B. C. the modern males, and 1205 B. C. the females. Broca found that the Egyptians of the IV. Dynasty had males 1574, females 1307 cc.; those of the XI., males 1443, females 1228; and finally, those of the XXIII., males 1060, males 1411, females 1122. There would be, therefore, an increase, but a decrease, but that is not the case, if we consider the facts in the mixture of races, as we find in the modern Egyptian population."

Broca's conclusions may be corrected upon the Egyptians by the following example, from the middle ages to the present. The average of my method of classification of these capacities is 1170 cc. of 1459, of 1350, of 1710, and still other figures, according to the varieties determined. A

is easily understood, a general average necessarily alters the facts, according to the number of varieties which enter as components of the average in the different series in anthropological museums; hence the curious results above indicated.

Another important point is as follows:

"But the fact which surprises us is the high figure of the capacity given by prehistoric crania. The masculine crania of Lozère have given 1606 cc., the feminine 1507; also of Lozère, masculine 1578, feminine 1473; crania from the *pietra levigata*, masculine 1531, feminine 1320; the contemporaneous Parisians, masculine 1559, feminine 1337. The approximate average of crania from the *pietra levigata* is 1560, equal to that of modern Europeans, as is related by Topinard."

In another of my recent works, I have demonstrated that of the crania of the neolithic age<sup>2</sup> the *Isobalypistoccephalus* has a capacity from 1230 to 1405 in the feminine, and the *Eucampylos* varies from 1470 to 1564 in the masculine. The two varieties, still persistent in Sicily, do not vary in capacity in the modern series, and at the same time show that in the neolithic epochs, as among modern populations, large and small varieties are found, just as the same types are now found through persistence of forms.

From this it is evident how much there is to reform in anthropology when we study by natural methods facts until the present misinterpreted, respecting the classification as well as the physical and psychological characteristics of man in time and space. Perhaps in the future, when we know all cranial forms by natural classification, it will be possible to find a correspondence of psychological characteristics in populations according to the predominance or superiority of types, a fact which has until now escaped research, because the capacity of the cranium in its absolute sense is not in correlation to the development of the mental functions, notwithstanding what is commonly affirmed.

The following are the varieties into which Dr. Sergi classifies the forms of skulls in the *norma verticalis* of Blumenbach:—

- (1) Ellipsoid (*ellipsoides*); (2) Pentagonoid (*pentagonoides*); (3) Rhomboid (*rhomboides*); (4) Ovoid (*ovoides*); (5) Sphenoid (*sphenoides*); (6) Spheroid (*spheroides*); (7) Byrsoid (*byrsoides*); (8) Parallelepipedoid (*parallelepipedoides*); (9) Cylindroid (*cylindroides*); (10) Cuboid (*cuboides*); (11) Trapezoid (*trapezoides*); (12) Acmonoid (*acmonoides*); (13) Lophcephalic (*lophcephalus*); (14) Chomatocephalus (*chomatocephalus*); (15) Platycephalic (*platycephalus*); (16) Skopeloid (*skopeloides*).

### UNIVERSITY AND EDUCATIONAL INTELLIGENCE.

WE have received a verbatim report of the interview which a deputation from the Association of Technical Institutions recently had with Mr. Adland. Several suggestions were made, some of which have already received the attention of the Science and Art Department. Prof. Wertheimer pleaded for an advisory voice in the construction of the Department's schemes before they were finally adopted, in a manner similar to that by which the Education Department allowed the managers of public elementary schools to express their views on the Code under which they had to work before it was finally adopted. Mr. Adland, in the course of his reply, said it was the intention of the Department not to publish near the summer months anything which will be in the nature of an important change. The recent form dealing with organized science schools had been issued early, with a view to embodying it in the Directory next autumn, the Department in the meantime being open to suggestions. During the course of the Vice-President's remarks, the question of the publication of the dates of the May examinations was raised, and, in reply to an inquiry, Sir John Donnelly said he saw no difficulty, if the schools wanted it, in publishing in May the dates of the subsequent May examinations. As to the question of the proper basis for the calculation of the Government grant, Mr. Adland expressed the hope that some day a part of the principle, which is shortly to be applied to organised science schools, will also be applied to evening classes; that is to say, there is every prospect that the grants will in a year or two be awarded in re on the Inspector's reports as to the soundness of the teaching and on the results of examination.

THERE are 119 Universities in the world, says the *Oxford University Extension Gazette*. Dr. Kukula in his list names

<sup>1</sup> See "Human Evolution."   
 <sup>2</sup> "Crania of the Neolithic Age" (Bull. Paleont. Italiana, Parma, 1892.)

114, but he omits the Universities of Louvain, of Paris, of the State of New York and of Wales, and the New University of Brussels. Excluding the first three, which, being of the Napoleonic type, have no residential students, the unalleged true population of the Universities of the world is estimated by this academic statistician as amounting to 157,513 persons. Berlin is the most populous University, Urbino the smallest. The first has 7771 students, the latter only 74. In point of numbers Oxford comes tenth on the list; Cambridge, twelfth; Victoria, sixty-fourth, and Durham ninety-eighth.

## SOCIETIES AND ACADEMIES.

### LONDON.

**Royal Society, March 21.**—"On the Development of the Branches of the Fifth Cranial Nerve in Man." By A. Francis Dixon.

In this paper "detailed descriptions of the fifth nerve branches are given for five different stages of the human embryo, beginning with an embryo of four weeks, at which time merely the three main divisions of the nerve are represented, and ending with one of the eighth week. The observations on the human embryo have been checked by further observations on rat embryos, and an almost complete correspondence between the two has been made out." In mammals, the three divisions of the fifth nerve are found to rise independently from the Gasserian ganglion, and the nasal nerve is found to be the first representative of the ophthalmic division, the frontal being formed later. In like manner, the inferior dental nerve represents the first formed inferior maxillary nerve, the lingual branch appearing later. No special ganglion is present either for the nasal or for the ophthalmic nerve in mammals in the sense of a ganglion of a posterior nerve root. The ciliary ganglion does not represent such a ganglion, and when first found is more closely connected with the fourth and frontal than with the third and nasal nerves. The fourth and frontal nerves from an early period are closely connected. At the beginning of the sixth week nearly all the named branches of the fifth nerve of the adult are represented in the embryo; also at this time the accessory ganglia of the fifth nerve are recognisable. No evidence was found to show that the cells of these smaller ganglia are derived directly from those of the Gasserian. None of the different nerves which in the adult connect the fifth with the other cranial nerves are to be considered branches of the fifth nerve; thus the chorda tympani and the Vidian are found to be derived from the facial, and the nerve of Jacobson from the Glossopharyngeal.

"On the Conditions affecting Bacterial Life in Thames Water." By Dr. E. Frankland, F.R.S.

Since May, 1892, the author has been making monthly determinations of the number of bacteria capable of development on a peptone-gelatin plate in a given volume of Thames water collected at the intakes of the metropolitan water companies at Hampton. The number of microbes per cubic centimetre of water varied during this time between 631 and 56,030, the highest numbers having, as a rule, been found in winter or when the temperature of the water was low, and the lowest in summer or when the temperature was high.

The complete observations demonstrate that the number of microbes in Thames water depends up on the rate of flow of the river or, in other words, upon the rainfall, and but slightly, if at all, upon either the presence or absence of sunshine or a high or low temperature.

With regard to the effect of sunshine upon bacterial life, the author remarks that the interesting researches of Dr. Marshall Ward leave no doubt that sunlight is a powerful germicide; but it is probable that its potency, in this respect, is greatly diminished, if not entirely annulled, when the solar rays have to pass through a stratum of water even of comparatively small thickness before they reach the living organisms. If this be the case, it is held to be no matter for surprise that the effect of sunshine upon bacterial life in the great mass of Thames water should be nearly, if not quite, imperceptible.

**Geological Society, April 3**—Dr. Henry Woodward, F.R.S., President, in the chair.—Dr. K. d. Kroustchhoff, St. Petersburg, was elected a Foreign Correspondent of the Society.—Physical features and geology of Mauritius, by Major H. de

Haga Haig, R.E. The author gave full details of the physical geography of the island, including the nature and composition of the mountain ranges, the depth of the ravines, the occurrence of caverns in the lavas, and the character of the coral reef surrounding the island. Information was furnished concerning the neighbouring islands, and reference made to the possible former existence of an extensive tract of land at no great distance from Mauritius.—On a comparison of the Permian freshwater Lamelli-branchiata from Russia with those from the Karoo formation of Africa, by Dr. Wladimir Amalitsky, Professor of Geology in Warsaw University. The freshwater shells from the Russian Permian deposits belonging to the genus *Palæomutela* are also known from the Karoo beds of South and Central Africa, as pointed out by the author in 1892. He had recently had the opportunity of studying the actual specimens from the Karoo beds, and found in them species of the groups *Palæomutela Inostranzewi*, *P. Keyserlingi*, *P. Vernoulli*, and *P. Murchisoni*; also of a new-genus, the forms of which he had previously referred to *Naiadites*, Dawson. All these groups are found also in Russia, and a list was given of species found in the upper horizons (A, B, and C) of the Permian beds of Russia and in the Karoo beds. These upper beds of Russia have been determined by the author as the freshwater equivalents of the Zechstein; consequently the Beaufort beds of the Karoo series, if considered as the homotaxial equivalent of the European strata referred to above, should be regarded as Upper Permian. The Upper Permian group of freshwater lamelli-branchiata of Russia, which bears traces of genetic relationship with the Carboniferous Anthracosites, and which was already well represented in Permo-Carboniferous and Lower Permian times, is, according to the author, much older than the African fauna of the Beaufort beds. These may be concluded to have migrated from Russia, the Gondwana beds of India having probably been the connecting-link between all these deposits. The author gave a description of the fossils of the Karoo series which he had examined, including a diagnosis of the new genus in which he placed the fossils already alluded to as having been previously referred to the genus *Naiadites*.

### PARIS.

**Academy of Sciences, April 8.**—M. Marey in the chair.—On the fluted spectrum, by M. H. Poincaré. A mathematical paper in which it is shown that a complete analysis of the phenomena of Fizeau and Foucault's experiment confirms Fizeau's deduction concerning the permanence of luminous movement during a large number of oscillations.—Official plans and reports relating to the removal of the capital of Brazil to a new site, by M. H. Faye. A series of reports printed in Portuguese and French. The district in which the proposed new site for a Brazilian capital is situated lies between the parallels 15° 49' and 16° 8' and the meridians 3° 18' and 3° 24' at an altitude of above 1000 metres.—Structure of the hymen in a species of *Muræmus*. An abstract of a memoir by M. J. de Seynes.—On substitutions, by M. Zechios. An algebraical paper.—Removal of the Brazilian capital. A letter to M. Faye, by M. Cruls. A short account of the main features of the survey work undertaken on the new site.—On geodetic work in the basin of the Anour, by M. Venukoff.—On the determination of the mass of the cubic decimetre of distilled water at 4°, by M. J. Mée de Lepinay. This datum is yet imperfectly determined. Shackburg and Kater give 1000.480 grams, whereas Stumpfer finds the value 999.053 grams. The author proposes a new method of determination by which he expects to determine this constant within 6 mgm. The proposed method includes (1) the study of the geometrical form and dimensions of a certain solid as related to the standard metre, (2) the measurement of the loss of weight of this solid immersed in pure air-free water at its temperature of maximum density in terms of the standard kilogram. The solid taken is a parallelepipedon formed of transparent quartz. Its thickness in different directions will be examined optically by means of Talbot's fringes.—New apparatus for the measurement of the specific inductive power of solids and liquids, by M. H. Pellat.—On a new form of spectroscope termed the "héma-spectroscope comparateur," by M. M. de Thierry.—On a simple experiment demonstrating the presence of argon in atmospheric nitrogen, by M. Gantz. The author obtains argon by replacing magnesium by electrolytic lithium. Owing to the lower temperature at which lithium completely absorbs nitrogen, it is possible to pass atmospheric nitrogen over several heated



THURSDAY, APRIL 25, 1895.

## CONTROVERSIAL GEOLOGY.

*Collected Papers on some Controverted Questions of Geology.* By Joseph Prestwich, D.C.L. (Oxon), F.R.S., F.G.S., Corr. Inst. France (Acad. Sci.); Acad. R. Lyncei, Rome; Imp. Geol. Inst., Vienna; Acad. Roy., Brussels; Amer. Phil. Soc., Philad.; &c. (London: Macmillan and Co., 1895.)

WITH respect to the main facts of Geology, we geologists are in general of one opinion, but with respect to the explanation of many of those facts, we hold very divergent opinions." In these opening words of his preface, the author explains and justifies the publication of this collection of essays. Prof. Prestwich's position, as the acknowledged *doyen* among British geologists, demands that these articles—the latest fruits of his ripe experience—should receive the most thoughtful consideration from his fellow geologists; but, quite apart from the position and authority of their author, all of the memoirs included in this volume are of the greatest value as contributions to science; and in reading them it is difficult to say whether we are more impressed by the wealth of knowledge or the literary grace which they display.

The key-note of the volume is struck in the first article, "The Position of Geology—a Chapter on Uniformitarianism," published in the *Nineteenth Century* of October 1893. In this short and admirably written essay, the author clearly defines his own attitude with respect to the doctrine of uniformity. He credits most English geologists with a belief in an absolute uniformity *both in kind and degree*, while he and many continental geologists, who fully accept uniformity *in kind*, altogether reject the notion that the actions going on at the present day can be accepted as *measures* of the rate of similar changes in the past. We cannot help thinking, however, in reading this essay, that the issue is not quite so simple as the author implies. The strictest uniformitarian would never maintain that no action that has taken place in past geological times could possibly have exceeded in violence, or in the effects produced by it, the phenomena which we may have happened to have witnessed during that century or two, in which systematic studies of terrestrial changes have been carried on. In 1783 a volcano in Iceland threw out lava having a volume equal to that of Mont Blanc; and in 1883, another volcano in the Sunda Straits projected materials to the height of sixteen miles into the atmosphere. Now no geologist would maintain that there could not possibly have occurred, in the long periods of the past, more violent eruptions than these. The uniformitarian only asks that in the explanation of the past we confine ourselves to operations of the *same order of magnitude*, as those now occurring upon the earth. We should be surely justified, for example, in asking for very definite evidence that in past times a single geological eruption had thrown out materials equal to the volume of the whole Alpine chain, or that another had projected materials to the height of 150 miles. If a gorge can be shown to have been cut by an existing river in 1000 years, it would hardly be legitimate to infer that a

similar gorge was cut in ten years by a river of 100 times the volume, unless at the same time it were shown that there were very strong reasons for believing that rivers of the proportions assumed actually existed in the past.

Prof. Prestwich puts what he conceives to be the position of the uniformitarians in the following simile:—"What if it were suggested that the brick-built pyramid of Hawāra had been laid brick by brick by a single workman? Given time, this would not be beyond the bounds of possibility. But nature, like the Pharaohs, had greater forces at her command to do the work better and more expeditiously than is admitted by the uniformitarians." We cannot accept the parallel as a just one. Large brick structures are not at the present day erected by a single bricklayer, and the historian—who is equally uniformitarian in his practice with the geologist—does not feel called upon to suggest any such improbable origin for a pyramid. But if, on the contrary, it were asserted that the pyramids are so vast that they must have been erected by a race of beings of larger stature and greater physical strength than the men of the present day, a position would be taken up similar to that of the opponents of a rational uniformitarianism. The historian justly asks that before such a view be accepted, it shall be shown that the work of pyramid-building could not be performed by ordinary men working in sufficient numbers for a long period of time. Nor would the historian be very greatly concerned if it were argued that by ordinary men such a task of pyramid building might extend over several reigns, or would even require centuries for its accomplishment. Every historian, in fact, takes up the same attitude as the uniformitarian geologist when he refuses to credit the men of bygone ages with gigantic stature, prodigious strength, abnormal wisdom, or extraordinary longevity.

While, however, we demur to the principles and ideas ascribed by the author of this volume to the uniformitarians, we gladly accept his work as an additional proof, if such were required, that old-fashioned "catastrophism" in geology is now quite extinct. More than this, we think that the protests and cautions of so distinguished and able a reasoner as Prof. Prestwich will render a real service to geology in calling attention to somewhat unwarrantable assumptions that have been made by some theorists. With our author's complaint against what he justly compares to *the closure*, as applied by physicists and mathematicians to the legitimate speculations of the geologist, we entirely sympathise. "It would," as he justly says, "be an unfortunate day for any science to have free discussion and inquiry barred by assumed postulates, and not by the ordinary rules of evidence as established by the facts, however divergent the conclusions to which those facts lead may be from the prevailing belief."

The second essay in the volume is a weighty criticism of the astronomical theory of glacial epochs. The only objection which we think can be taken to the essay is that the author identifies the upholders of this theory with the uniformitarians. The late Sir Charles Lyell never accepted the theory of Mr. Croll, and many holding the strongest uniformitarian views have always maintained that geological facts are opposed to any of those

explanations of vicissitudes in climate in past geological times, which are based on astronomical considerations.

In the third article, Prof. Prestwich discusses "the primitive characters of the flint implements of the chalk plateau of Kent, with reference to the question of age and make." The author of this essay, thirty-six years ago, took a leading part in making known the evidence in the Somme Valley and elsewhere, which is now universally accepted as establishing the antiquity of man. In the essay before us, he insists that, before the times when men fashioned the beautifully chipped implements of our river valleys and caves, a still more primitive people employed rough flints as scrapers, just as did the recently extinct race of Tasmanians. The beautiful series of plates accompanying this article will, we think, carry conviction to the minds of most archaeologists and geologists, that the existence of such primitive races has been established by the author. Prof. Prestwich, however, argues that the antiquity of the men of the river valleys and caves, and of still more primitive people who used the flints of the Plateau period, though very great, was probably less than some theorists have imagined.

The three last articles, "On the Agency of Water in Volcanic Eruptions," "On the Thickness and Mobility of the Earth's Crust," and "On Underground Temperatures," are well known to all geologists; but for the present volume these memoirs have been revised, and some very important and valuable additions have been made to them. They will be much more convenient for purpose of reference than in the journals in which they originally appeared.

There is one aspect of the work before us to which we cannot avoid alluding before concluding this notice. All the articles are controversial, as indicated by the title; but the work might fairly be cited as an example of the spirit in which scientific discussions ought to be carried on. No geologist, who takes up this work, but will find cherished ideas reasoned against, or pet notions boldly assailed. But from beginning to end of the volume, he will find that no word has been written which is calculated to give pain to the most sensitive opponent. This is high praise; but it is not higher than might have been anticipated as the due of one who has in a long career inspired such universal admiration, esteem, and affection as the successor to the chair of Buckland and Phillips in the University of Oxford. JOHN W. JUDD.

#### POPULAR WEATHER FORECASTS.

*My Weather-wise Companion.* Presented by B. T. Edinburgh and London: William Blackwood and Sons, 1895.

**D**OES "B. T." stand for Barometer and Thermometer, the instruments which some people are foolish enough to think necessary for forecasting the weather, or is this simple guise does modestly shelter itself from too great publicity and the evils that popularity brings? The connection is curious, but probably accidental, for the book is free from all scientific technicalities, and the author would like us to forget that such things existed, and adopt processes that can be practised by all, without any outlay on costly apparatus, without telegraphic

information, and the weariness of preparing synoptic charts. Herein "B. T." is wise, for he is assured of a much larger audience, since the instruments with which he works are in the hands of every one, and no previous knowledge is required for their use. The sky, the clouds, the moon, animals, plants, &c., these are the tools our author uses; but even these may at times be a little inconvenient and difficult in their application. For instance, some of us might very well have wished to know that the winter through which we have just passed was likely to prove more than ordinarily severe, in order to take necessary precautions about water-pipes and such-like necessary evils. Here is the method of test: "If the mole dig his hole two feet and a half deep [this sounds like a sum in simple proportion, but such a conclusion would be premature], expect a very severe winter; if two feet deep, not so severe; if one foot deep, a mild winter." No one would probably care to contradict this; it may be perfectly true, but then as a rule people do not go about the country with pickaxe and shovel, looking for mole-holes, and laboriously and exactly determining their depth. Such severe exercise would be undertaken only by a very ardent meteorologist, and even he might be discouraged, for the author does not say that the winter will be severe or otherwise, but only that it may be expected.

In another respect our author shows much worldly wisdom. It may be assumed that what the public look for from the maintenance of Weather Bureaus and Meteorological Offices, is to know whether it is going to rain. A forecast that says that the wind will be from the south-east, possesses little general interest; what a man wants to know is whether it be possible to dispense with an umbrella, or whether one must submit to the extra care and anxiety the carriage of one entails. It may be to some a matter of the keenest excitement to know whether a depression exists on the coast of Ireland; while some, again, will even speak disrespectfully of an anticyclone in Central Europe; but the "man in the street" will be perfectly satisfied if he can be assured that the next hour or two will remain fine. Hence the author wisely concerns himself principally with the signs that make for rain. This kind of information, as the author is careful to point out, is welcome alike "to the prince and peasant, to the anxious hostess who trembles for the success of her garden-party, to the tinker who seeks the friendly shelter of a wayside hedge, down to the dandy in Pall Mall, who hates to carry an umbrella." And on the subject of this umbrella we think we have some right to complain. He, it would seem, has carried one and the same umbrella through a period of fifteen years, carried it, nay used it, amidst aristocratic surroundings, and occasionally under circumstances likely to test the constitution of the most carefully constructed; and yet we gather that it is still a presentable article, and one that could be unfurled in Piccadilly with confidence by the most fastidious. Why could he not have given us the recipe that preserves to an umbrella such a long life of usefulness? This contribution to economics would have been a valuable testimony to the accuracy of his conclusions and the keenness of his observation, since it might be fairly inferred that this protection was not carried when it was not wanted. But, alas, we have to



content ourselves with a collection of rules and portents. The belief in which we fondly thought the Education Act and the School Board had utterly abolished.

And even here our old friends, when brought out for our edification, are not in the form in which they are familiar, and have been long beloved. Look at the baldness of the assertion—"Expect bad weather if cats wash their faces and lick their bodies." Contrast it with the majestic roll of the well known couplet:—

Puss on the hearth, with velvet paws,  
Sits, wiping o'er her whiskered jaws.

We distinctly feel that we are robbed of something; there is such a pleasant jingle in the old rhyme, that it is carried conviction with it. How disappointing, too, to be told only to *expect*. We may just mention, in passing, that this is not the conclusion which we should expect the average fourth standard boy to draw from witnessing the operation on the part of "puss." We should expect that young gentleman to remark that "cat's hair appeared to be slightly hygroscopic."

Altogether this little book reminds us of those admirable compilations in which the theory of whist is sometimes exposed: a vast number of rules is given, which if one could remember and select at the right time he would never make a mistake: but, unfortunately, the combinations on which the rules are founded have a knack of eluding the unlucky player, and never seem applicable to the hand in play, with the consequence that in his efforts to remember some rule, he trumps a thirteenth at an inopportune moment, and earns the contempt of a long-suffering partner. In the same manner one can conceive the city man, armed with this collection of precious and invaluable rules for determining the weather of the coming day, debating with himself whether it was last night or this morning that the sky was red; did he, while shaving, see his dog eating grass on the lawn; and what is the exact age of the moon—finally getting confused by the knowledge that the train is nearly due, rashly selling his mackintosh and umbrella in the middle of a well-determined summer anticyclone, and so forfeiting his hard-earned position of a trustworthy weather prophet and a man of keenness and nicety of observation.

#### THE MYCETAZOA.

*A Monograph of the Mycetozoa, being a Descriptive Catalogue of the Species in the British Museum.* Illustrated with seventy-eight plates and fifty-one woodcuts. By Arthur Lister. Printed by order of the Trustees. London: 1894.

ALTHOUGH this is an official publication of the Natural History Department of the British Museum, that part of the title referring thereto is somewhat misleading, because the author includes everything published belonging to this curious group of organisms. At the same time it is not a monograph in the strict sense of the word, because the author had no opportunity of examining a large number of the reputed species inhabiting Central Europe, Scandinavia and North America. Thus, out of 15 species of *Badhamia*, only 9 came under his observation; of *Physarum*, 30 out of 45; of *Didymium*, 8 out of 17, and so on all through. It is true that he repeats,

in English, the authors' descriptions, and frequently suggests the affinities of the species in question.

Further, apart from the fact that the book was published under the authority of the Trustees of the British Museum, and the fact that "every species of which I have given the characters can be examined either in bulk, or as a mounted object in the British Museum," it might with equal propriety have been entitled a descriptive catalogue of Mr. Lister's own herbarium, or of the Kew herbarium, because, as he acknowledges, he had full use of the Kew set, including all Berkeley's numerous types.

However, this does not affect the character and quality of the work. Mr. Lister's previous contributions to the literature of these curious and debatable organisms were a sufficient guarantee of good and really original work, and he has no doubt met all reasonable expectations on this point. Indeed few works have recently been issued embodying so much original research. The *Mycetozoa*, as limited by De Bary, Rostafinski, Lister, and others, are essentially the same as the *Myxogastres* of Fries and the *Myxomycetes* of Wallroth. The first name was substituted for the older ones because it was discovered that the spores, instead of producing a mycellum as in fungi, gave birth to swarm-cells which coalesce to form a plasmodium; thus indicating a relationship with the lower forms of animal life. Mr. Lister adopts this designation, and defines the group as follows:—

"A spore provided with a firm wall produces on germination an amoeboid swarm-cell which soon acquires a flagellum. The swarm-cells multiply by division and subsequently coalesce to form a plasmodium which exhibits a rhythmic streaming. The plasmodium gives rise to fruits which consist of supporting structures and spores; in the *Endogonia*, these have the form of sporangia, each having a wall within which the free spores are developed. A capillitium or system of threads forming a scaffolding among the spores is present in most genera. In the *Exogonia* the fruits consist of sporophores bearing numerous spores on their surface."

He then proceeds to describe in detail the development and various stages, in fact the life history of these organisms, and this he has done in a simple and lucid style worthy of all admiration. The movements of the swarm-cells—creeping and dancing movements—are most interesting, as well as that of the plasmodium, or aggregation of cells; but the feeding of the swarm-cells is most exciting. Mr. Lister had previously published accounts of his observations of the ingestion of food-material by the *Mycetozoa* in this stage of their development; yet a short extract relating to this process is not out of place:—

"If bacteria are introduced into a cultivation of swarm-cells on the stage of the *mycetozoa*, they are seen to be laid hold of by the pseudopodia and drawn into the body of the swarm-cells, where they are enclosed in a digestive vacuole. Several bacteria are brought in turn to the same chamber, or fresh captures are conveyed into one or more additional vacuoles. The protrusion of pseudopodia usually ceases after such ingestion, and that part of the swarm-cells takes a rounded form. In the course of an hour or two the bacteria are assimilated and the digestive vacuoles disappear. Unassimilated and inorganic matter are sometimes taken in, which after a time are again discharged. Both ingress and egress are observed to take place only at the posterior end."

It should be explained that an ordinary swarm-cell in the feeding stage is an elongated body tapering at one end into a long cilium or lash, and more or less truncated at the end with several short cilia, the so-called pseudopodia. Within the body of the cell is a nucleus and several vacuoles.

With regard to hybrids between the plasmodia of different species, Mr. Lister is in accord with De Bary, and doubts the accuracy of Mr. Masee's observations.

Another point of great interest is the very wide geographical distribution of most of the species; and the main characters, Mr. Lister states, are remarkably constant in specimens gathered in all parts of the world. Mr. Lister gives a number of instances in which specimens obtained from Europe, India, and North and South America are identical in the most minute microscopic detail. But there are exceptions, in which individuals of the same species from tropical and temperate regions exhibit differences in form; the tropical ones being of more elegant growth.

In his description of the sclerotium, or resting stage, of the plasmodia, Mr. Lister states that the sclerotium of *Budkhamia utricularis* can be revived, after preservation in a dry state for three years, by being placed in water. He also gives the results of a number of interesting experiments on the vitality of various other *Myxozoa*. Altogether Mr. Lister's "Introduction" is most instructive, and his descriptions are so clear, that this book should go far to popularise the study of these organisms. The plates, which are colotype reproductions of water-colour drawings, are very good, but much of the beauty of the originals is lost in the process. It is a pity that they were not reproduced in colour. And this leads one to ask why the coloured figures in Masee's "Monograph" are not cited. It is true there are references to the pages of that work, which would lead one to the figures, if one knew of their existence. It is disappointing, too, that the author has attempted no review of the previously existing literature, and has not even thought it necessary to devote two or three pages to bibliography. These omissions are all the more surprising when one considers the facilities the author enjoyed in the prosecution of his studies.

#### A NEW WORK ON DYEING.

*Le Pratique du Teinturier*. By Jules Garçon. Two vols. Pp. 148 and 391. (Paris: Gauthier-Villars et Fils, 1893 and 1894.)

THE art of dyeing has in recent years developed so rapidly—having been practically revolutionised and to a large extent remodelled during the last thirty years—that text-books and works of reference dealing with the subject rapidly become defective. We are therefore always glad to welcome any new work which, as far as possible, epitomises the information up to date.

The great energy and enterprise exhibited by the large firms of colour manufacturers in such a marked degree, has, moreover, a tendency to develop what may be distinguished as the *art* of dyeing, more rapidly than the *science*. It is, therefore, pleasant to note that, as an engineer, the author of the book under review fully appreciated the importance of the manipulative and

mechanical side of the subject, and gives a lucid description of many of the recently introduced appliances.

The plan of the book differs somewhat from that usually found in works on dyeing. There is, for instance, no description of the character and properties of the textile fibres or of the colouring matters; but the various theories which have been put forward to account for dyeing processes, although of necessity based on such facts, are discussed at considerable length. Again, chemistry, as expressed by symbols and equations, is conspicuous by its absence; but a lengthy chapter on the elements of chromatics is introduced. However, as the book is as yet incomplete (a third volume being in course of preparation), it is too early to definitely consider these as omissions.

Volume i. contains a very short and sketchy historical introduction, followed by a few notes regarding the relative advantage of the natural and artificial dye-stuffs. A classification of the colouring matters—following the usual lines—is then given, with some very general notes with regard to the application of each class of colours to the various fibres. This section of the book might certainly have been considerably extended with advantage, since undue compression necessitates a too-free generalisation and an inadequate explanation of the facts. For instance, it is not sufficient to state p. 13 that the acid used in dyeing with sulphonie acid colouring matters (always employed as salts) serves to liberate the free colour acid. This is really a very secondary action requiring only a small fraction of the amount of acid used, the principal function of which is to prepare the wool for combination with the dye.

The methods of dyeing linen, jute, China grass, feathers &c., are also noticed, a useful bibliography on the dyeing of feathers being introduced. This commendable feature is also noticed in several other sections of the book.

The second part of the first volume is concerned with the actual processes of scouring, dyeing, and finishing. The space allotted to this is again very small; a description of the bleaching of cotton and of wool occupying less than half a page. Some useful hints are, however, given with respect to the choice of dye-stuffs, the storing, dissolving and examination of colours, the causes of defects, &c.

M. Garçon devotes considerable attention to the question of the fastness of colours, and discusses the influence in respect to this property, of the nature of the fibre and the colouring matter employed, of the method of applying the colour, of the character of the light and the atmospheric conditions. With regard to the relationship between the chemical constitution of the colouring matter and its behaviour on exposure to light, it is noted that although most members of any particular group act in a similar manner, a slight difference in constitution is sometimes sufficient to cause a great difference in permanence; thus, although most of the anthracene colours are "fast," and all the triphenylmethane derivatives "fugitive," pallein is much more resistant than the closely allied eosin dyes, and by simply sulphonating indigotin, one of the most permanent dyes is changed into a very fugitive colour. It may be added that derivatives of methyl anthracene appear to be comparatively fugitive to light.

It is thus not safe to put forward any assumptions, based either upon chemical relationship or similarity of general properties, concerning the behaviour of colouring matters in this respect; and therefore, recognising the value of a systematic examination, the author gives, at considerable length, the results obtained in recent years by Hummel.

When discussing certain experiments in which arc lamps have been employed as the source of illumination, it is stated that the electric light behaves similarly, but less energetically, than sunlight; the average bleaching action of sunlight having been estimated at 30 per cent. of its total luminosity, while that of the electric arc is only about 6 per cent.

The third section of the first volume deals with operations subsequent to dyeing, such as soaping, milling, steaming, &c. It is very short, extending only to four pages. Two appendices, the first dealing with theories of dyeing, and the second with the elements of chromatics, are added, and the volume ends with a very complete bibliography of the works on dyeing published during the last 100 years.

The second volume is devoted to a description of the machinery used in dyeing and allied processes, a very large space, equal in fact to the whole of the first volume, being occupied by the subject of water purification; which, although of great importance to the dyer, certainly receives undue prominence. The great fault of the work, as a whole, is indeed a certain lack of proportion; many essential points receiving scant attention, while valuable space is occupied to smaller advantage by long descriptions of less important subjects—such, for instance, as the Westinghouse air-pump. Nevertheless, the book should prove a valuable reference work for managers of works, or students of dyeing, to whom it can be heartily recommended.

WALTER M. GARDNER.

#### OUR BOOK SHELF.

*The Fauna of British India, including Ceylon and Burma.* Published under the authority of the Secretary of State for India in Council. Edited by W. T. Blanford. "Moths," Vol. iii. By G. F. Hampson. (London: Taylor and Francis, 1895.)

We have already noticed the two preceding volumes of this work in some detail; and it is therefore unnecessary to say more respecting the general execution of this volume than that the letterpress is arranged in a similar manner, and that the execution of the woodcuts is equally good. The present volume includes the last two sub-families of the *Noctuidæ*, the *Focillinæ*, and the *Deltoidinæ*, and one or two small families of the *Geometridæ*. Respecting the *Deltoidinæ*, Mr. Hampson remarks: "It exhibits a gradual development from forms with straight palpi fringed with hairs above, such as *Hypenæ*, which is closely allied to the *Sarothripinæ*, and to the ancestors of the *Noctuidæ* and *Nalinæ*, through forms with oblique palpi, to a group possessing palpi of an extremely curved sickle-shaped type; from this group arose the stouter-built, more typically noctuiform and nocturnal *Focillinæ* and *Quadripinæ*." We seriously doubt the advisability of speaking in such a positive manner on questions which cannot, in the present state of our knowledge, be anything more than very doubtful inductions, at the best.

NO. 1330, VOL. 51]

After the *Noctuidæ*, Mr. Hampson places the families *Eproctidæ*, *Uranidæ*, *Epipleminæ*, and *Geometridæ*, for the last of which he has followed Mr. Meyrick's classification. Under the *Uranidæ* he includes a considerable number of genera, most of which, except *Nyctalemon*, were included by previous authors in the *Micronidæ*, and other families of *Geometridæ*. A fourth volume is to conclude the Indian *Macro-Lepidoptera*, and to contain the *Pyrallidæ* and a supplement; and we are glad to learn that Lord Walsingham is working at the *Micro-Lepidoptera* of India.

Mr. Hampson speaks of the difficulty of the sub-family *Boarmiinæ* in the *Geometridæ*; and under the genus *Boarmia* itself he includes no less than eighty-five species, divided into several sections, to some of which sub-generic names are applied. As, however, no less than twenty-eight generic names are included as synonyms of *Boarmia*, we think it would have been better to have treated some, at least, as provisionally entitled to generic rank. And this leads us to a consideration of the most serious defect in all Mr. Hampson's work, which has already been pointed out in more than one quarter. He is too much inclined to place forms together as varieties, and then to treat them as actual synonyms. It is true that in a few instances in the present volume he discriminates between named varieties; but far more frequently he gives a description of a species in a few lines, preceded by a string of half-a-dozen or more names, without any hint of how far these names represent distinct forms, or which names represent his idea of the species he is describing, even when he notices that the species is variable. While making allowance for exigencies of space, this is hardly fair to those who will use his books; for even if we assume that Mr. Hampson is always correct in his views as to which forms are entitled to specific rank, and which are only to be regarded as varieties, it is not to be supposed that every one will take exactly the same view of a doubtful case; and we greatly fear that if an entomologist meets with an insect which does not correspond with the description of a species given by Mr. Hampson, he will at once describe it as new, and, in many cases, redescribe one of the forms which Mr. Hampson has rejected, with a light heart, as a mere synonym.

Apart from this serious defect, we can recommend the book as a most useful and, indeed, quite indispensable manual for all who are interested in East Indian Moths.

W. F. KIRBY.

#### LETTERS TO THE EDITOR.

*The Editor does not hold himself responsible for opinions expressed by his correspondents. Neither can he undertake to return, or to correspond with the writers of, rejected manuscripts intended for this or any other part of NATURE. No notice is taken of anonymous communications.*

#### The Origin of the Cultivated Cineraria.

RETURNING from abroad, I have just seen Mr. Dyer's letter in *NATURE*, March 14. Of the matters there treated I ask leave now to deal with one only, that numbered (18). This is a point of fact—the origin of the cultivated Cineraria. At a meeting of the Royal Society, on February 28, Mr. Dyer exhibited a specimen of *Cineraria cruenta* from the Canaries, side by side with a plant of the common cultivated form. With the object of minimising the value of "sports" in evolution, this exhibition was made to illustrate what can be done "by the gradual accumulation of small variations." Mr. Dyer stated, if I rightly understood him, first, that of the two forms exhibited, the one had been produced from the other; secondly, that, as far as is known, this process of evolution had been accomplished by the gradual accumulation of small variations, and not by the selection of "sports" or seedlings presenting notable and striking variations. That in the case of a plant much modified by gardeners in recent times such a history would be highly unusual, Mr. Dyer will, I think, admit.

Doubting the account, and searching records of the early culture of *Cineraria* for my own satisfaction, I found a good deal of miscellaneous information on the subject. The history is not yet quite complete; but as Mr. Dyer's account has now appeared in print, the following notes may be of use.

In the ordinary manuals (e.g. Burbidge, *Propagation*, &c., 1877, p. 25) it is said that the florists' *Cinerarias* are *hybrida*, obtained by crossing and recrossing several species of *Cineraria* or more strictly *Sonchus*. As to the exact parentage, there is not entire certainty. Burbidge gives *C. cruenta*, *aurita* and *lanata* as the parents. Other writers mention *C. maderensis*, *multiflora*, *tussilaginis* and *populifolia* as having contributed to the parentage (e.g. *Jour. hort. Gand*, ii. 1846, p. 231). General statements of a like nature are made by many. For the account given by Mr. Dyer I find no authority except one, an article by Rolfe (*Bot. Chron.* 1888-9, p. 553). Here *C. cruenta* is given as the sole parent, and a figure of this species raised at Kew, from wild seed, is shown beside two extreme flowers of the modern type. Excepting this statement, it seems agreed that the species originally concerned are at least four: *cruenta*, *aurita*, *populifolia* and *lanata*. The first three have comparatively small flowers in corymbs or cymes. Those of *cruenta*, introduced from Canary by Masson to Kew in 1777, are purple. This species was originally described from Tenerife by L'Heritier, *Sot. Anc.* 1788, pl. 33, and is figured *Bot. Mag.*, t. 46, and elsewhere. The lower surface of the leaves is purplish. The petioles have auricular expansions. *C. aurita*, sent to Kew from Madeira 1790, figured by L'Heritier, pl. 31, and *Bot. Mag.*, t. 1786, is a somewhat different plant, of more slender habit, said to be more akin to *populifolia*. The flowers are purple. Ray-florets few and irregular. Petiolar expansions variable, mostly much smaller than in *cruenta*. *C. populifolia* L. Her., Canaries, brought by Masson from Tenerife 1780, is a form with yellow flowers. *C. lanata*, L'Her., pl. 30, and *Bot. Mag.*, t. 53, is a plant very different from any of the others. It bears large purple flowers, some two inches across, only one to a peduncle. The leaves are cordate-subrotund and septangular, and woolly underneath. L'Heritier gives it as from Tenerife. The *Bot. Mag.* wrongly says it had been introduced from Africa (perhaps confusing with *lanosa*, DC. = *lanata* Thunb.). The large flowers and peculiar leaves at once distinguish this species from the rest.

It should be added that *populifolia* in its native state showed considerable diversity in the forms of its leaves, three varieties being specified by Decandolle, *Prodr.*, vi. p. 409. A natural variety of the same species with white flowers was brought from Tenerife by Webb. This is the *B. leu-anthus* DC. It is figured in *Flor. Cal.*, i. p. 73, from a specimen grown in Birmingham Botanic Garden. As to these species, references to further information may be found in Decandolle, *Prodr.*, and in Webb, *Phytogr. Cinar.*, &c.

These four species with others were at the beginning of this century pretty generally distributed in greenhouses in England, France, and Germany. They are enumerated in most of the horticultural treatises of the period, with directions for their propagation. *C. lanata* was thought the best. "It far exceeds all others cultivated here in the beauty of its flowers. . . . It is valuable on account of its hardiness, its readiness to flower, and the facility with which it may be propagated." Rees' *Cycl. of Arts and Sci.*, viii. 1819. Others speak to like effect.

The first mention I have found of any distinct garden form is that of Willdenow, who in "Enum. Pl. Berol." 1809, p. 893, gives *C. hybrida*, saying that this plant is grown in gardens under the name of *C. cruenta*, but that it in reality differs much from the latter, and has flowers almost like those of *C. lanata*.

Between 1820 and 1830 definite efforts were made to improve the *Cineraria*. The first published is that of Bouche'. Writing in the "Verh. zur Beford. d. Gartenbauers, Berl.," i. 1824, p. 130, he says that having grown *C. lanata* L'Her., *C. cruenta* L'Her., and *C. hybrida* Willd., and noticed that the first two seeded freely, it occurred to him to try to raise varieties or sports (*Agathes*), and at the same time to test the distinctness of the species. His seedlings flowered in the following year. "One from *C. cruenta* had the flowers rose-red, except one which was quite white, the flowers of the parent being dark red. The other from *C. hybrida* varied so much that they might be mistaken for separate species. His words are as follows:— "Unter denen von der *Cin. hybrida* zeichneten sich besonders fünf Abänderungen aus, welche eine ganz eigenthümliches Ansehen bekommen haben, und leicht von Botanikern, denen

die Entstehungsart derselben nicht bekannt ist, für neue, noch unbeschriebene Arten dieser Gattung gehalten werden konnten." His description follows. In particular, the foliage had varied greatly from the parent form, somewhat resembling *lanata*, suggesting to Bouche' that there may have been hybridisation with that species.

About the same time Mr. Drummond, then Curator of the Botanic Garden, Cork, published a paper in the *Gard. Mag.*, ii. 1827, p. 153. He says that *Cinerarias* are favourites with him, especially *cruenta*, "for besides the great beauty and variety in the flowers, its fine purple blossom form a beautiful contrast, &c." "We seldom see it cultivated to the extent it merits. The following account of the method I have followed for some years of growing this plant. . . may turn the attention of your readers to the cultivation of the *C. cruenta*, the effects of which will, in all probability, be the production of fine double and single varieties of different colours, as it sports greatly from seed. [Italics are mine.] Except in cases when it becomes desirable to preserve any particular variety for its superior beauty, I prefer raising the *C. cruenta* from seeds. . . . Care should be taken to select the finest varieties, and those that produce the largest and finest heads or corymbs of flowers." "The other greenhouse species I cultivate are *lanata*, *hybrida*, *geifolia* and *amelloides*. These I increase by cuttings, &c."

It happens that in the same year (1827) of the *Gard. Mag.*, p. 446, there is a reference to Bouche's paper. Not improbably Drummond may have read the latter, for in Loudon's *Ladies' Mag. of Gard.*, 1842, p. 111, I find this passage: "Most of the purple *Cinerarias* are varieties or hybrids of *C. cruenta*. . . . It was long a favourite in greenhouses, and was generally propagated by dividing the roots; but about 1827, Mr. Drummond, Curator of the Botanic Garden in Cork, having raised it from seed, and found the seedlings vary considerably, conceived the idea of hybridising it with *C. lanata*, *C. geifolia* and *C. ameloides*. The trials, however, with *C. geifolia* [a true Cape *Cineraria*] and *C. [Agathes] ameloides* do not appear to have succeeded; but between *C. cruenta* and *C. lanata* some handsome hybrids were raised. Since that time numerous experiments have been made and hybrids have been raised, &c." A summary follows.

Soon after this a number of definite seedlings or "sports" came into existence. Of some of these there are good records. I will mention four which are represented by good coloured plates. *C. waterhouseana* is said to have been a hybrid, the result of the seed of *C. tussilaginis*, fertilised by the pollen of *cruenta* (*Paxton's Mag. of Bot.*, iv. 1838, p. 43, and *Ladies' Mag.*, &c.). In general appearance it rather resembled *tussilaginis* (one of L'Heritier's species which had died out, and was introduced again in 1832 by Webb. See *Bot. Mag.*, t. 3215.) This must have been a very fine plant. It had large red flowers, about two and a half inches across, with long narrow ray-florets something like *lanata*.

The next case I shall take is a plant which first flowered in a garden near Belfast, called var. *cyanocephalus* in *Bot. Mag.*, 1840, t. 3827. It had long white rays and a blue disc. Sir W. J. Hooker says of it: "Notwithstanding the very unusual colour of the flowers for one of the Compositæ, I have little hesitation in referring it to . . . the old *C. lanata* of our gardens. The foliage is the same, and the structure of the flowers; but the colour of the blossoms is very different, and in our variety of a most unusual character." He then recalls Decandolle's well-known remark that yellow in Compositæ may vary to red or white, but not to blue, and, on the other hand, that blue may vary to red or white, but never into yellow. He adds: "Not only in our plant is the lilac-coloured ray of the flower changed to white, and the deep lilac or blood-red purple of the ray [disc] changed to a very bright blue, but the stigmas, which are deep orange in the original stock, are also intensely blue, and the anthers are purple-black."

Another seedling of a very different type, famous in its day, was *soehleriana*. It was figured in *Paxton's Mag. Bot.*, ix. 1842, p. 125. The flowers were of a deep blue, the rays being short and wide, compared to those of *waterhouseana*, for example. "It was raised from seed ripened promiscuously on a number of plants of various kinds blooming together, &c." In the *Gard. Chron.*, 1842, it was advertised at 10s. 6d. a plant.

Another sport, pinkish and white, is figured in the *Botanist*, v. 1841, No. 215. "It came up accidentally, some years ago, from self-sown seeds, in one of the pots of the greenhouse, so that I cannot say anything certain about its parentage." The

writer conjectures it to be a hybrid between *lanata* and *populi-olia*, var. *leucanthus*.

If any one will look at the plates to which I have referred, he may satisfy himself of the astonishing diversity of these forms. In *Gard. Mag.* 1839, p. 439, is an early record of the appearance of the new seedlings at shows. At the Caledonian Horticultural Show, the Cinerarias "were very brilliant, and partook of novelty." The names of the seedlings successful, including *waterhousiana*, are given. At the beginning of the forties the named kinds became very numerous, and were at first offered at high prices in the trade advertisements. Henderson and Ivery were the two chief English cultivators at that time.

During this period, 1830-1840, the progress was very rapid, and there can be no doubt that the florists' Cinerarias came into existence within some ten or twelve years. Such a plate as that in *Four. d'hort.* Gand, 1846, shows the ordinary kinds much as we know them. From those plants up to the perfected plants of ten years ago, the change was undoubtedly slow and gradual. The alterations have consisted chiefly in increase in size and symmetry of the flower, and in promotion of compactness of habit (see, e.g., Glenny, *Ann. of Hort.* 1850, p. 37, also *Gard. Chron.* 1879 (1), p. 532).

The next point is of some interest. As compared with other "improved" herbaceous plants, the Cineraria is a little peculiar in the fact that it is now generally raised from seed. This is done partly to ensure that the plants shall not be overgrown, and partly to avoid green fly, a pest to which these plants are specially liable. In consequence of this, the old "named" kinds, that is to say, kinds propagated by asexual methods, went out of fashion, though till lately they still had supporters. It was found that seeds of good strains could be fairly relied on—not, of course, to reproduce the form of their particular parents, but to give fine plants. For instance, Henderson, *Scot. Gard.* i. 1852, p. 22, says: "in raising seedlings you should select three or four dwarf varieties, which number is quite sufficient to produce all the different colours." In *Gard. Chron.* 1887 (1), p. 549, are some interesting particulars of the methods used by Mr. James, to whom the later improvement of the plant in England is largely due. The plants of each colour are grouped in blocks, and the bees are freely admitted to the houses. It is not found necessary to separate the plants further, and in saving seed all the colours are mixed together. In the case of the Cineraria therefore, as in that of *Calceolarias*, *Begonias*, and other plants much grown from seed, it is desirable not only to create a fine variety of which the stock can at once be multiplied asexually, but also to raise a good strain of which the seedlings come fairly true. The latter process may undoubtedly often take time.

Even in recent times a "sport" has been recorded. In *Gard. Chron.* 1880 (1), p. 277, it is stated that Mr. James "has succeeded in obtaining a new 'break' that promises to be the forerunner of another host of new flowers. The colours of the flower do not shade off into one another, as is usually the case, but are arranged in bold and well-defined belts. . . . We understand that it flowered for the first time last season, and that it has reproduced itself from seed." A figure is given.

These particulars might be added many more, relating to the origin of double varieties, variations in the foliage, and other matters. The foregoing notes of the history must, I think be taken to show (1) that the modern Cinerarias arose as hybrids derived from several very distinct species; (2) that the hybrid seedlings were from the first highly variable; (3) that "sports" of an extreme kind appeared after hybridisation in the early years of the "improvement" of these plants; (4) that the subsequent perfection of the form, size and habit has proceeded by a slow process of selection. Mr. Dyer's statement that the modern Cinerarias have been evolved from the wild *C. cruenta* "by the gradual accumulation of small variations" is therefore, in my judgment, misleading, for this statement neglects two chief factors in the evolution of the Cineraria, namely, hybridisation and subsequent "sporting."

I have ventured to deal with this case because it seems to be generally supposed by those not acquainted with the facts, that the origin of the modern florists' flowers has in general been very gradual. As a matter of fact it would, I believe, be more true to say that the new departures have in general been at first very rapid, subsequent improvement being commonly slow. "Sporting," usually after hybridisation, has been the chief factor in the production of these new developments, just as in

the case of the Cineraria. To speak of no more, I may refer to the new forms of *Begonia*, of *Gladiolus*, and of *Erica* now so familiar. With what special propriety the Cineraria was chosen by Mr. Dyer to support his contention is not evident to me.

Whether any of these sports exhibit the phenomenon of organic stability I cannot now discuss. W. BATESON.

St. John's College, Cambridge, April 17.

#### The Age of the Earth.

IN Dr. Hobson's letter on this subject, he confuses the argument by the introduction of a new factor (never alluded to in the former discussion, or in my theory as stated in "Island Life"), the *bulk* or *volume* of the matter deposited. This has nothing whatever to do with the practical problem, because it is admittedly impossible to form any estimate of the total bulk of all the stratified rocks of the earth during all geological time; while it is equally impossible to form any estimate of the total bulk of the denuded matter, since we have no clue whatever to the number of times the same areas have been again and again denuded. But the maximum *thickness* of the same rocks, compared with the average *rate* of denudation, and the coincident maximum *rate* of deposition, do furnish materials for an estimate, since they can all be approximately determined from actual observation; and the result is what I have given. If Dr. Hobson had referred to the former discussion he would have avoided imputing to me "fallacies" which I never made. I never said a word about "equal bulks" of material being deposited in less time than they were denuded. But, as the only available data are those of *thickness*, not *bulk*, then it is clear that, if the area of deposition is one-nineteenth of the area of denudation, the *rate* of deposition of a known *thickness* of rocks will be nineteen times as great as the known *rate* of denudation. It was necessary for me to point this out when first discussing the subject, because one eminent writer had made the rate of deposition *less* than the rate of denudation, because the water-area is greater than the land-area of the globe; while an eminent geologist has quite recently taken the rates of denudation and deposition as being *equal*. If, however, the area of deposition is very much *less* than the area of denudation, which is now admitted to be the fact, then the *rate* of deposition *per foot of thickness* will be many times *greater* than the *rate* of denudation.

I should not have thought it necessary again to state this very obvious conclusion, had not Prof. Sollas, while so clearly pointing out Dr. Hobson's misconception as to the area over which the maximum thickness of the strata extended, omitted to refer to the confusion he has now for the first time introduced into the problem, by references to the *bulk* or *volume* of the sedimentary rocks, a factor which all previous writers have seen to be wholly beyond even an approximate determination.

ALFRED R. WALLACE.

So little is really known about the earth's age that any additional mode of approximating to it, however rough, may possess some value. The following method of finding a lower limit is, with one or two alterations, the same as that given in a paper in the *Geological Magazine* for 1887 (p. 348). It depends, not on the rate of denudation, but on the rate of subsidence within the area of sedimentation.

Part of the sediment brought down by a river is used for keeping the surface of the delta close to the level of the sea; and the fact that the deposits formed from it are generally shallow-water deposits, shows that the amount of sediment is, as a rule, sufficient or more than sufficient for the purpose. The remainder of the sediment is carried out seawards, and enlarges the delta laterally.

If there were no surplus sediment, it is evident that the mean rate of subsidence over the delta would be obtained by dividing the volume of the sediment brought down annually by the river by the area of the delta. But if there be an excess of sediment, then the same quotient will give a value greater than the mean rate of subsidence, for only part of the sediment is used for keeping the delta-surface in shallow water. In the case of the Mississippi, the amount of sediment brought down annually is 7,459,267,200 cubic feet, and the area of the delta 12,300 square miles, or 342,204,320,000 square feet; so that the mean rate of subsidence is not greater than  $\frac{1}{4}$  of a foot per year, or 2.18 feet per century.

Prof. Sollas estimates the total maximum thickness of the different layers of sediment since the beginning of Cambrian

times at 164,000 feet (NATURE, vol. li. p. 534). If these layers tapered off uniformly in either direction from the region of maximum deposit, the total mean thickness would be half this, or 82,000 feet; and if the mean rate of subsidence were never greater than 2.18 feet per century, the total time required for the accumulation of Cambrian and post-Cambrian rocks would be not less than 3,700,000 years. But there may have been large unknown gaps in the process of their accumulation; the lower margin of the deposits may have extended far beyond the limit of subsidence, and the mean rate of subsidence may have been at all times considerably less than the upper limit given above. On these accounts, as well as on others that might be mentioned, it seems possible that much more than 3,700,000 years has elapsed since the beginning of the Cambrian period.

Birmingham, April 8.

C. DAVISON.

#### The Burmese Chipped Flints Pliocene not Miocene.

IN the *Geological Magazine* for November of last year, p. 525, is a review by Prof. T. Rupert Jones, of the important paper, published in the *Records of the Geological Survey of India*, by Dr. Fritz Noetling, the Palaeontologist of the Survey, "On the occurrence of Chipped (?) Flints in the Upper Miocene of Burma." Another paper, by Prof. T. R. Jones, on "Miocene Man in India," appeared in *Natural Science* for the same month.

From the fact that the mammals *Rhinoceros goimensis* and *Hipparion antelopinum*, of which bones were found associated with the flint chips, have only been found in India in Pliocene beds, and from a slight acquaintance, gained, it is true, more than thirty years ago, with the Burmese strata in which Dr. Noetling's most interesting discovery was made, I felt assured that there must be some error in believing that the flint chips occurred in Miocene deposits, and I wrote to Dr. Noetling on the subject. I have just heard from him in reply. In a letter from Upper Burma of March 11, he tells me he has now definitely ascertained that the bed containing the chipped flints is Pliocene.

Further particulars will, I hope, be published before long by Dr. Noetling; and I should not have written on the subject but that a serious error is caused by its being supposed that "Miocene Man" has been shown to have existed in India, and it is desirable that this error should be corrected without delay. The importance of the discovery is in no way diminished by the correction of the geological date to which the flint-bearing stratum is referred.

W. T. BLANFORD.

April 17.

#### The Mandrake.

WITH regard to Prof. Veth's exhaustive account of the mandrake (referred to in NATURE of April 11, p. 573), it may be useful to students of folklore to call their attention to the occurrence in the Chinese literature of a similar superstition, wherein *Phytolacca aconitifolia* (Shang-luh) takes the place of *Mandragora officinarum*. Sie Tsai-Kang's "Wu-tsah-tsu," written about 1610 (Japanese edition, 1661, tome x. p. 41), contains the following passage:—"The Shang-luh grows on the ground beneath which dead man lies; hence its root is mostly shaped like a man." . . . In a calm night when nobody is about, the collector, offering the ox's flesh roasted with oil, propitiates the spirit of the plant until *ignis fatuus* crowd about the latter; then the root is dug out, brought home and prepared with magic paper for a week; thus it is made capable of speech. This plant is surnamed 'Ye-hu' (i.e. Night Cry) on account of its demoniacal nature." There are two varieties of it: the white one is used for medicine, the red one commands evil spirits, and kills men when it internally taken by error."

KUMAGUSU MINAKATA.

April 16.

Here the author says: "It is popularly called 'Chang-hu-Kan' (Wang-tse-chen). The name shows that the root was used in witchcraft, as is with that of the Mandragora." Here, "The Year Book," Dec. 1894, p. 26.

Another explanation suggested for the name is that, as long as the fruit *Phytolacca aconitifolia* is ripe, the suckers continue to cry every night (i.e. at night). However, seeing that the belief in the shriek of Mandragora is more current among the European ("Encyclopædia Britannica," 9th ed. vol. x. p. 477), it would be more correct to derive the name "Night Cry" from an analogous origin.

#### A Claim for Priority.

I SEND you, under separate cover, a copy of an address, "Radiant Matter," &c., delivered at the International Electrical Exhibition, held in Philadelphia in 1884, reprinted from the *Journal* of the Franklin Institute, September 1885, and would call your attention to the description of the method of preparing films of gold and other metals of extreme thinness, far exceeding in tenuity those described in NATURE as novelties in metallurgical methods (prepared in identically the same manner), and exhibited at a conversazione of the Royal Society, June 13, 1894. The first published note regarding this subject may be found in the *Proceedings* of the American Phil. Soc., vol. xcix. February 16, 1877. Later and fuller notices will be found in *Journ. Franklin Institute*, April 1877, June 1877, September 1885, and September 1894. In addition to the above, the process was fully described in *U.S. Patent*, 198, 209, December 18, 1877. ALEX. E. OUTERBRIDGE.

Philadelphia, April 5.

#### AN IMPROVED METHOD FOR THE MICROSCOPIC INVESTIGATION OF CRYSTALS.

A MEMOIR of considerable importance to all who are interested in the microscopic determination of the characters of crystals, is contributed by Prof. Klein to the *Sitzungsberichte* of the Berlin *Akademie der Wissenschaften* for January 31, 1895. The two essential points of the communication are that a form of stage goniometer is described, which permits of the most complete examination of many of the principal zones of the crystal with one and the same setting of the crystal upon its holder, and that the crystal is immersed during the observations in a liquid whose refractive index is about the mean of the refractive indices of the crystal. The idea of the "Universaldrehapparat," as the new stage goniometer is termed, appears to have suggested itself almost simultaneously to Prof. Klein and to Herr von Federow, for the former described an earlier form of it in the *Sitzungsberichte* of April 1891, while the latter published a description of an "Universaltischen" for the microscope in the *Zeitschrift für Kristallographie* of May in the same year. Herr von Federow had previously contributed to the *Zeitschrift* a remarkable memoir concerning a theodolitic universal goniometer, and the application of the principle of that instrument to the microscope goniometer followed naturally therefrom. The present memoir of Prof. Klein affords so admirable a description of the improved instrument, which has been constructed for him by the well-known Berlin crystallographical optician, Herr Fuess, and likewise of the mode of employing it in connection with the immersion method, that readers of NATURE may find a brief account of it not uninteresting. Unfortunately this description cannot well be illustrated, as Prof. Klein's illustrations are photographic reproductions which are unsuitable for further reproduction.

The microscope should of course be one of the petrological type, fitted with the usual accessories for the examination of crystals in parallel and convergent polarised light. The particular instrument constructed for Prof. Klein is somewhat similar to the largest Fuess model. It is so arranged with respect to the centre of gravity that it can be rotated into the horizontal position whenever desired, a point of some importance with regard to the use of an immersion liquid. The stage is of course circular, and is divided so as to read with the aid of a pair of verniers to single minutes; it is further provided above with two graduated rectangular traversing movements, one of which is supplied with a micrometer registering 0.01 m.m., while the other is capable of much more rapid motion. The advantages of the simultaneous rotation of the polarising and analysing nicols, as adopted in the microscopes made by Mr. Swift under the direction of Mr. Alan Dick, have been so well appreciated by

Prof. Klein, that this has been arranged for in the new Fuess instrument. The carriers of the nicols are each furnished with a toothed flange capable of gearing with a smaller pinion, and the two pinions are arranged at the ends of a connecting rod furnished at a convenient height near the upper pinion with a milled flange by means of which rotation can be effected. Provision is made for the lengthening of the connecting rod when the focussing of the microscope by the rack and pinion or by the fine adjustment is effected, and care is also taken that the rotation by means of the connecting rod shall occur without dead-space or backlash. Prof. Klein states that some important details in connection with improvements in the mode of carrying out this simultaneous movement of polariser and analyser will shortly be published by Herr Fuess. Provision has likewise been made for correcting at any time the setting of the nicols in their carriers, experience having shown that the setting invariably alters slightly in course of time. In addition to the eyepiece nicol capable of being connected with the polariser in the manner just described, there is likewise provided the usual nicol capable of sliding in or out of the microscope tube just over the objective. Above this, and just below the eyepiece, a Bertrand lens for observing interference figures in convergent light is capable of sliding in and out of the tube, and is intended to be employed in conjunction with a converging system of lenses capable of being carried in a tube attachment beneath the level of the stage. The remaining details of the microscope are the same as are usually supplied with the No. 1 Fuess instrument.

The stage goniometer is intended to be employed with the microscope arranged horizontally, as it is found inconvenient to employ an immersion liquid with a vertical arrangement. The base-plate of the goniometer, consisting of a stout metal plate with fairly large central aperture, is fixed by a suitable clamping arrangement upon the now vertical stage of the microscope. The plate is continued into a short arm on that side which is uppermost when fixed in position, and this arm carries near its end, and at right angles to it (horizontal when in position), a projecting piece terminating in the supporting cone for the goniometer circle, and which also carries the vernier reading to five minutes and the fine adjustment. The circle is hollowed in its upper central part, and perforated with a central aperture; this permits of the sliding movement within the hollow, for centering purposes, of a disc which carries the axis of the instrument. To the lower end of this short axis are attached the movements for adjusting the crystal, and the lower of which carries the crystal. The adjusting movements are a pair of circular quadrants arranged at right angles to each other and graduated. They are simpler in construction, and lie much closer together than those of the best forms of goniometer now in use for ordinary goniometric and spectrometric work, and are therefore particularly suitable for use in connection with the microscope. The upper quadrant is fixed to the axis; over it a slider is capable of moving, which carries a vernier, and below it the lower quadrant, which in turn is fitted with a slider terminating in the holder which carries the crystal cemented by wax. The verniers enable readings of five minutes to be obtained, the same degree of accuracy as in the case of the circle.

The glass cell containing the immersion liquid is supported in position normal to the axis of the microscope by means of a stand with an adjustable arm placed to the left of the microscope. It is recommended to have a series of cells, ready for filling with various media of the most frequently required refractive power. The advantages of Adams' method of determining optic axial angles may also be combined with those of the method now described, by use of a cell consisting of an upper cylindrical portion terminating below in a sphere filled

with the liquid. As regards suitable liquids, an admirable list is given by Herr Pulfrich in his book descriptive of the construction and use of the total-reflectometer recently devised by him (p. 64). Two errors in that list, however, are corrected by Prof. Klein; he has been unable to prepare the solution of mercuric iodide in aniline and quinoline of refractive index 2.2, and the refractive index of the phenyl sulphide kindly supplied by Prof. Klein's colleague, Prof. Emil Fischer, is only 1.56 instead of 1.95. If the dangerously poisonous and inflammable liquids are excluded, the list consists chiefly of oils, the well-known Thoulet solution, monobromonaphthalene, and methylene iodide. The solution of iodine in the latter frequently renders it insufficiently transparent for the purpose.

The determination of the true angle,  $2V$ , between the optic axes within the crystal, supposing it to be biaxial, can at once be determined with the aid of the new apparatus, by immersing the crystal in a liquid whose refractive index is equal to the  $\beta$  (the intermediate) refractive index of the crystal. The condensing system of lenses is first inserted between the polarising nicol and the stage, and the Bertrand lens above the analyser; as objective, either the ordinary wide angle combination usually employed for convergent light work, or a specially constructed one supplied for the particular purpose of convergent light observations through an immersion liquid, is employed. This objective is so constituted that as large a field of vision as possible is afforded, while the distance between objective and crystal is considerably greater than with the ordinary systems in use. The apparent angle of the optic axes in air,  $2E$ , may first be measured, if desired, after adjustment of the crystal by means of the adjusting movements, by bringing the hyperbolic brushes to the cross wire of the microscope eyepiece in the usual manner. The immersion cell not being in position while this is being achieved, the objective can be approached nearer to the crystal and one of the ordinary forms of convergent light objective employed, which affords a larger angle of vision, reserving the special objective for the determination of the true angle of the optic axes. If, however, the Adams spherical cell is employed, there is no necessity even here to use the special objective, as the older wide angle form serves admirably. With the parallel sided cells it is preferable to use the special objective. The Adams sphere is not supported similarly to the rectangular cells, but is conveniently held by its cylindrical neck in a small support directly attached to the lower quadrant of the adjusting apparatus. The measurement of the true angle of the optic axes is then carried out in the usual manner, similarly to the determination of the apparent angle in air, while the crystal is immersed in the liquid contained in one or other of the two forms of cell. Monochromatic light should of course be used in making the observations, a sodium flame some little distance in front of the polariser being employed by Prof. Klein.

The great advantage of this method of determining the true inner angle between the optic axes lies in the fact that it is totally unnecessary to prepare section-plates of the crystal, the whole crystal itself being employed, and thus material saved. Prof. Klein does not claim for it the highest attainable accuracy, and for the class of work such as that with which the writer of this article has become identified, the determination of the crystallographic characters of series of isomorphous compounds closely resembling each other, where every endeavour must be made to attain the upper limits of experimental accuracy, such a method is of course inadequate. But for the ordinary description of minerals and the crystals of isolated chemical preparations unlikely to be injured by the immersion liquid, and particularly for laboratory teaching, the method is one of

the simplest and most interesting yet described. The accuracy depends entirely upon the closeness of the approximation of the refractive index of the liquid to the  $\beta$  index of the crystal. Of course it will rarely happen that coincidence of these values will occur for all colours of the light employed, the dispersion of the crystal and the liquid in general being different. So that although the values may be coincident for sodium light, they would in all probability be different for other colours. But if the observations are only conducted for sodium light, a process which is frequently sufficient for the purpose in view, then this objection entirely disappears. Moreover, the errors introduced by the discrepancy for different wave-lengths of light would not be sufficiently large in most cases, if observations for other colours were made, to materially reduce the value of the method for the purposes for which it was designed.

A consideration of the simple formulæ connecting the optic axial angle with the  $\beta$  refractive index and the refractive index of an immersion liquid will at once render the value of the method, within the above specified limits, clear. Representing as usual the real semi-acute angle between the optic axes within the crystal by  $Va$ , the semi-obtuse angle by  $Vo$ , and the apparent semi-acute and obtuse angles in the immersion liquid by  $Ha$  and  $Ho$  respectively, the refractive index of the medium for light of the same wave-length being  $n$ , then :

$$\sin Va \cdot \frac{n}{\beta} \sin Ha \text{ and } \sin Vo = \frac{n}{\beta} \sin Ho.$$

These two equations are of the same kind, for both  $Va$  and  $Vo$  are less than  $90^\circ$ ; and the only variables are  $n \sin Ha$  and  $n \sin Ho$ , for  $\beta$ ,  $\sin Va$ , and  $\sin Vo$  are constant quantities for this wave-length of light. If, now, the sum of the angles  $2Ha$  and  $2Ho$  is greater than  $180^\circ$ , the common factor  $n$  must, in order to bring the sum of these angles down equal to  $180^\circ$ , be increased, that is, a liquid of higher refractive power be employed. Conversely if the sum is less than  $180^\circ$  the refractive power of the liquid must be diminished in order to bring the sum of the angles up to  $180^\circ$ . For the specially interesting intermediate case where  $n = \beta$ , the sum of  $2Ha$  and  $2Ho$  will be exactly  $180^\circ$ , and  $\sin Va = \sin Ha$  and  $\sin Vo = \sin Ho$ , when also  $Va = Ha$  and  $Vo = Ho$ .

From the above theoretical considerations one can immediately deduce the course to be taken to render the immersion liquid exactly equal to the  $\beta$  index of the crystal; if the measured values of  $2Ha$  and  $2Ho$  add up to over  $180^\circ$  a liquid of higher refraction must be obtained, and *vice versa* if the sum is less than  $180^\circ$ . There are, however, several ways of determining the closeness of approximation of the indices without going to the trouble of actually making preliminary measurements. In the first place the crystal will disappear in the liquid, that is to say, will be invisible, provided that it is colourless, when its refractive power is equal to that of the surrounding medium, especially when the line of the observer's vision lies in the plane of the optic axes. This is very beautifully observed when calcite is immersed in monobromnaphthaline, and particularly when it is arranged so that the observer looks along the direction of the vertical axis of the crystal; under these conditions the latter is completely invisible. In the second place, instead of hyperbolic curves passing through the positions occupied by the optic axes, the brushes will take the form of almost straight lines when the refraction of crystal and liquid is about the same.

In choosing crystals for observation by the new method, Prof Klein recommends that individuals or fragments should be selected which are equally thick in two perpendicular sections in the plane of the optic axes, that is, which are almost cylindrical in appearance, and not too large to prevent the interference figures being observed. When immersed in the liquid, it is as if at each

moment, and for every position during rotation of the crystal, a parallel section-plate were being examined, the natural faces of the crystal—however rich in faces the zone may be—not entering into consideration whatever.

The advantages of the use of an immersion liquid of equal refractive power in the examination of crystals have been pointed out by several previous observers, as Prof. Klein is careful to state. So long ago as 1841 Biot, in his memoir concerning lamellar polarisation, describes the use he made of it. The method has long remained dormant, however, as far as is known from the literature of this branch of study. In the eighth edition, however, of the *Lehrbuch der Physik und Meteorologie* of Joh. Muller, edited by L. Pfaunder in 1879, it is stated that if the refractive index of the liquid in which a plate perpendicular to one of the medium lines is immersed is equal to that of the crystal, the true angle between the optic axes is at once afforded. Latterly, however, the evident advantages of the method have suggested themselves to several crystallographers. M. Fouqué mentions it in his memoir in the *Bulletin of the French Mineralogical Society* of 1894 on the feldspars.

The writer of this article has frequently made use of the method for certain specific purposes, and it may be of use to other workers to give a brief indication of one or two modes of extending its sphere of usefulness not touched upon by Prof. Klein. In the course of the investigation of the normal sulphates of potassium, rubidium, and cesium, the results of which were laid before the Chemical Society last year (*Journ. Chem. Soc.* 1894, 628, and *Zeitschrift für Kristallographie*, 1894, xxiv. 1), a difficulty was found in determining the true optic axial angle of rubidium sulphate by means of the very accurately orientated section-plates prepared by use of the new grinding goniometer described to the Royal Society (*Phil. Trans.* 1894, Series A, 887) earlier in the same year. The difficulty, which is one not uncommonly met with, was owing to the fact that the extremely low double refract  $n$ , necessitating the use of very thick section-plates, combined with the slight separation of the optic axes, rendered it impossible to measure the obtuse angle in monobromnaphthaline, and so to calculate the true angle by means of the formula  $\tan Va = \frac{\sin Ha}{\sin Ho}$ . The

difficulty was surmounted, as fully described in the memoir referred to, by measuring the acute angle by means of section-plates perpendicular to the first median line immersed successively in two liquids, benzene and cedar oil, whose refractive indices were nearly, and the mean of them exactly, equal to the mean refractive index of rubidium sulphate. The two series of values obtained for six wave-lengths of light (the monochromatic light producer recently described by the writer, *Phil. Trans.* 1894, Series A, 913, being employed) were almost identical, differing only by a very few minutes, and the mean for each wave-length was taken as representing the true angle of separation of the optic axes for that particular wave-length. The method is applicable to all cases where it is found impossible to see the hyperbolic brushes through a section perpendicular to the second median line on account of the slight separation of the optic axes. The suggestion to employ it was made to the writer by Mr. Miers, of the British Museum, who has had a goniometer constructed for the express purpose of studying the use of an immersion liquid.

Another case in which observations in such a liquid are of great value is when it is found desirable to confirm, in some independent manner, the mode of dispersion of the optic axes for different colours indicated by the calculated values of  $2Va$  obtained from the formula last quoted. Several of the compounds which the writer has lately been engaged in studying exhibit very low dispersion of the optic axes, and the calculated values of



2Va for five wave-lengths, obtained from the measurements of the apparent acute and obtuse angles in monobromnaphthalene by the use of accurately orientated section-plates, are so close together that it was considered advisable to ascertain in some other manner whether the order of dispersion was truly represented: that is, whether the angle for one end of the spectrum was really very slightly greater than that for the other end, or whether the amount of dispersion thus indicated did not really fall within the limits of experimental error, thus leaving it possible that the dispersion might even be of the contrary order. By immersing a plate perpendicular to the first median line in a liquid of refractive power equal to the medium refractive index of the crystal, the interference figure in white light usually at once indicates, by the colours exhibited on the margins of the axial brushes, the order of dispersion, and measurements of the axial angle for the two extreme wave-lengths afford an immediate check upon the accuracy of the calculated angles. It is a considerable source of satisfaction to be able to confirm such calculated optic axial angles in so simple a manner.

Prof. Klein further describes how admirably the new apparatus is adapted for the determination of the extinction angles upon the various faces of a zone, in parallel polarised light. For this purpose the converging lenses are removed, and the eyepiece analysing nicol is employed, so that the polarising and analysing nicols may be arranged for simultaneous rotation. The measurements are carried out while the crystal is immersed in the liquid as in case of the determinations of optic axial angle. The only precaution necessary is that the crystal should be uniformly illuminated in order that the exact position of extinction may be ascertained by use of one of the usual half-shadow stauroscopic plates.

The memoir concludes with a description of the general mode of investigating a biaxial crystal immersed in a liquid of equal refractive power, indicating how the principal planes of optical elasticity may be found, the positions of the optic axes ascertained, and the true internal angle of the latter measured. One of the most important advantages of the method is the simplification which it introduces into the study of triclinic crystals, hitherto almost dreaded by the crystallographer for the trouble they involve. It would appear that their optical investigation by the immersion method offers but slightly more difficulty than that of crystals of higher symmetry, the positions of the optic axes being readily found, and the true angle at once afforded. This alone would entitle Prof. Klein to the thanks of crystallographers and mineralogists for perfecting so admirable an aid to investigation.

A. E. TUTTON.

#### MICROBES AND METALS.

THE effect of metals on the growth of bacteria has been examined by Miller, Behring, and others, and another contribution to this subject has lately been published by Dr. Meade Bolton, in the December number of the *International Medical Magazine*. According to Uffelmann, who smeared the surface of copper coins with liquefied jelly-cultures of cholera bacilli, the latter were destroyed in seventeen minutes; whilst on a brass coin they were alive after thirty hours, but dead after sixty hours. Bolton employed Miller's method of inoculating a tube of melted jelly with particular microbes, and pouring the contents out on a sterilised glass-plate, after which bits of the metal under examination were laid on the jelly whilst it was still soft. If the metal has an inhibitory action on the microbes, then a clear zone is left around the metal after the colonies have developed in the other parts of the jelly. The width of this zone, Dr. Bolton found, varied very considerably with different

organisms, as well as with different metals. Thus carefully purified bits of silver produced in the case of cholera bacilli a clear zone 5 millimetres broad, in the case of typhoid bacilli a zone of about 1 millimetre, whilst with the closely allied colon bacillus a zone of about 5 millimetres was produced. In the case of purified gold, no inhibition was observed with the staphylococcus pyogenes aureus, colon bacillus, typhoid bacillus, or cholera bacillus. Freshly "glowed gold" had invariably no inhibitory action; and in the few cases where inhibition was observed, the gold had not been glowed for several weeks. Pure nickel, platinum wire, and platinum black aluminium, silicon, and niobium, again, also failed to give any reaction with most of the microbes examined. Throughout the investigations it was found that those metals that are resistant towards chemical reagents in general, failed to produce any effect on microbes; whilst, on the other hand, those metals which are readily attacked by chemical reagents, all exhibited a marked inhibitory action upon the growth of bacteria. This result is probably due to a solution of the metal taking place in the medium. The length of time it is necessary to leave the metals in contact with the jelly, to produce an effect on the microbes present, was tried with brass, copper, cadmium, and zinc, on the staphylococcus pyogenes aureus. The metals were put on and removed at various intervals. When cadmium was left on for a minute, there was a clear space underneath where it had rested, which extended to 1 millimetre round; when it was left on for three or four minutes, the clear space usually extended over 3 millimetres. Very similar results were obtained with zinc. With brass no effect was produced when it was left on thirty-six minutes, but after this there was more and more marked inhibition up to fifty minutes; but to produce a clear space, it was necessary to leave it on for still longer. Copper produced no visible effect under thirty-six minutes, and fifty minutes was required to produce a clear space.

G. C. FRANKLAND.

#### PROFESSOR JAMES DWIGHT DANA.

BY the sudden death of Prof. J. D. Dana, from heart-failure, on April 15, America has lost a veteran man of science, who in his time has not only played many widely varied parts, but has reached the highest excellence in each. As a mineralogist he published, so long ago as 1837, the first edition of a "Descriptive Mineralogy," which by reason of its completeness and accuracy soon became a standard work of reference throughout the civilised world, and of which the sixth edition (1134 pages), issued in 1892 under the superintendence of his distinguished son, Prof. Edward Salisbury Dana, still maintains the high reputation attained by the original work. As a geologist and palaeontologist, he published in 1863 a similarly excellent and well-illustrated "Manual of Geology," having special regard to the geology of the North American continent, and of which the fourth edition (1087 pages) was issued only two or three months ago. Of his work as a zoologist, we may cite as example his elaborate report on the zoophytes, collected by an expedition in which he took a very active part. The report is illustrated by 61 plates, and in it are described no fewer than 230 new species. Attainments so diverse belong only to the few.

James Dwight Dana was born on February 12, 1813, at Utica, in the State of New York, U.S.A., and was therefore in his eighty-third year at the time of his death. He was educated at Yale College, New Haven, Connecticut, receiving there a sound training in mathematics, physics and chemistry, which was of the greatest service to him in his subsequent career; he proceeded to his

degree in the year 1833. His appointment as Instructor of Mathematics to the midshipmen of the United States Navy gave him splendid opportunities for the study of nature in various parts of the world, particularly in France, Italy, and Turkey, opportunities of which he was not slow to avail himself; more especially was his attention attracted to the study of volcanic phenomena by an ascent of Vesuvius, a sight of Stromboli, and an excursion in the Island of Milo in the year 1834. Settling down for a short time, he acted as chemical assistant at Yale College to his old teacher and friend, Prof. Silliman (1836-38); but an opportunity again presenting itself of making a long voyage of marine observation, he accepted the appointment of mineralogist and geologist to the United States exploring expedition, which was to proceed round the world. This expedition, under Charles Wilkes as Commander, was admirably equipped for the objects in view, and consisted of two sloops-of-war, a store-ship, and a brig; the cruise extended over four years (1838-42), and the scientific staff included, in addition to Dana, Pickering, Couthoy, and Peale as zoologists, Rich and Breckenridge as botanists, and Hale as philologist. The memory of the events, scenes and labours of this cruise was a constant joy to him during the remaining fifty-three years of life. On at least two occasions, however, he was in imminent peril: at one time his vessel narrowly escaped destruction on the rocks of Southern Fuegia, when the sea was dashing up the cliffs to a height of two or three hundred feet, and all the anchors had given way; at another time his party had to take to the boats empty-handed, and some hours afterwards they saw the last vestige of the vessel which had been their home for three years disappear beneath the waves.

The study of the material collected by the expedition and the preparation of his reports occupied all the available time during the next thirteen years. The first two or three years were spent at Washington, but after his marriage to the daughter of Prof. Silliman he removed back to New Haven, where he passed the rest of his life. In 1850 he was appointed Silliman Professor of Geology and Natural History at Yale College. In 1846 Mr. Dana had become associate-editor of the *American Journal of Science*, and after the death of Prof. Silliman, in 1864, he became the principal editor of that important scientific organ.

Dana gave special attention to corals and coral islands, and also to volcanoes. The Wilkes expedition of 1838-42 followed in part the course taken by the *Beagle* in 1831-39, and even where it diverged from that route visited coral and volcanic islands such as have been carefully described by Charles Darwin. When the Wilkes expedition reached Sydney in 1839, Dana read in the papers a brief statement of Darwin's theory of the origin of the atoll and barrier forms of reefs; this mere paragraph was a great help to him in his later work, and he afterwards regarded Darwin with feelings of the deepest gratitude. A visit to the Fiji Islands in 1840 brought before him facts such as had been already noticed by Darwin elsewhere; but there they were on a still grander scale and of a more diversified character, thus enabling him to speak even more positively of the theory than Darwin himself had thought it philosophic to do. On other points the conclusions arrived at by Darwin and Dana, independently of each other, were for the most part the same, and differed only in comparatively unimportant details. Dana's special labours relative to corals cease with the publication of his report on the zoophytes collected by the expedition, in an elaborate account (396 pages) of Corals and Coral Islands, which was prepared by him and issued in 1849; but an extension of his expedition-report on Coral Islands and Coral Islands, which had been separately published in 1857. In 1859 appeared another consider-

able work (399 pages) entitled "Characteristics of Volcanoes, with contributions of facts and principles from the Hawaiian Islands," which placed on record much useful information collected by him during his travels.

In addition to these larger works, he was the author of about two hundred separate papers. Some of them are of a physical character: his first paper, published as far back as 1833, dealing with the connection of electricity, heat and magnetism; subsequent papers treated of galvanic-magnetic apparatus and the laws of cohesive attraction as exemplified by crystals. Other papers, of a purely crystallographic character (1835-52), treated of the drawing and lettering of crystal figures, of crystallographic symbols, and of the formation of twin growths: a series of volcanic papers discussed both lunar and terrestrial volcanoes, the latter including those of Vesuvius, Cotopaxi, Arequipa, Mauna Loa, and Kilauea (1835-68); a set of coral papers treated of the temperature limiting the distribution of corals, on the area of subsidence in the Pacific as indicated by the distribution of coral islands, on the composition of corals and on fossil corals (1843-74).

About forty papers are on mineralogical topics: many of them are descriptive of particular mineral species; others treat of general subjects, such as nomenclature, pseudomorphism, homeomorphism, the connection between crystalline form and chemical constitution, and the origin of the constituent and adventitious minerals of trap and the allied rocks. As illustrations of the variety met with in his geological publications, we may cite his papers on the origin of the grand outline features of the earth, the origin of continents, mountains and prairies, the early condition of the earth's surface, the analogies between the modern igneous rocks and the so-called primary formations, on erosion, on denudation in the Pacific, on terraces, on southern New England during the melting of the great glacier, on the degradation of the rocks of New South Wales, and the formation of valleys. The remaining papers, about seventy in number, deal with biological subjects, both recent and fossil, and have a similarly varied character; some being descriptive of species, others treating of classification and similarly general problems.

The importance of this scientific work was widely recognised, and many marks of distinction were conferred upon him, both at home and abroad. He was an original member of the National Academy of Sciences of the United States, and in the year 1854 occupied the presidential chair of the American Association for the Advancement of Science. In 1851 he was elected a Foreign Member of the Geological Society of London, and in 1872 received from that Society the Wollaston Medal, the highest compliment the Geological Society can pay to the man of science; in the same year the University of Munich honoured him with the degree of Ph.D.; in 1877 he was the recipient of the Copley Medal of the Royal Society, and in 1884 was elected one of the foreign members; in 1886 Harvard conferred upon him the degree of LL.D.; he was also an honorary member of the Academies of Paris, Berlin, Vienna, St. Petersburg and Rome, and of the Mineralogical Societies of England and of France.

#### NOTES.

WITH the Ecole Normale at Paris, which has just celebrated its centenary, the names of a number of distinguished men of science are associated. At the present time, no less than twelve of its old students are members of the Academy of Sciences. Pasteur left Lille to become the director of scientific studies at the school, and carried on, while in connection with it, the researches which have made his name known throughout

the world. M. Bertrand, the Perpetual Secretary of the Academy, is an old student of the school, and among other eminent names included in the list of its alumni are MM. Darboux, Joubert, Serret, Hermite, Puiseux, Briot, Bouquet, Giard, Baillaud, Chaive, Floquet, Pellet, Tisserand, Appell, Picard, &c.; while the teaching staff now contains such men as Coursat, Tannery, Gernez, Dufet, Houssay, Constantin, Raffy, Violle, Joly, and Wallerant.

AN influential committee has been formed for the erection of a monument to the late Prof. Hermann von Helmholtz, the German Emperor having promised 10,000 marks and a free site for the purpose. The committee is international and thoroughly representative, as shown by the names of Berthelot, Blaserna, Boltzmann, Geikie, Holmgren, Kékulé, Kelvin, Lippmann, Lubbock, Pictet, Rayleigh, Roscoe, Sidgwick, Siemens, Tait, Thalén, Virchow, Weber, and others among the 180 distinguished men of science forming the committee. Funds will be collected in Germany and in other countries, and may be sent to any member of the committee, or to Messrs. Mendelssohn and Co., Berlin W., Jaegerstrasse 49 and 50. Letters may be sent to Prof. Dr. A. König, Berlin N.W., Flemmingstrasse 1. The appeal issued by the committee concludes as follows: "Friends and admirers of Hermann von Helmholtz far and near, unite with us! Bear witness to the homage paid by science, which knows no frontiers, to one of its heroes; show your gratitude for the benefits which life has received from his scientific labours, and give expression to the love which his harmonious spirit won wherever he appeared."

PROF. HUXLEY'S condition during the past week has caused his friends considerable anxiety, but we are glad to learn that a change for the better set in on Monday.

DR. JOHN H. REDFIELD, one of the founders of the American Association for the Advancement of Science, died recently at Philadelphia.

THE Prince of Wales has signified his intention to be present at the celebration of the jubilee of the Royal Agricultural College, Cirencester, on July 25.

THE sixty-seventh meeting of the Society of German Naturalists and Physicians will be held this year at Lubeck, September 16 to 21. The secretaries of the zoological section are already making preparations for this event, and will issue a preliminary programme of communications and demonstrations early in July.

THE London Geological Field Class will commence their series of Saturday afternoon excursions, under the direction of Prof. H. G. Seeley, F.R.S., next Saturday, when they will visit Otford and Eynsford. Further particulars can be obtained from the General Secretary, R. Herbert Bentley, 31, Adolphus Road, Brownswood Park, N.

MR. EDWARD CROSSLEY has signified his intention of presenting to the Lick Observatory the 3-foot reflecting telescope, with its dome, which now form part of his private observatory at Halifax. This information comes to us directly from the Lick Observatory, together with an expression of high appreciation of Mr. Crossley's most generous gift.

APPLICATIONS for appointment to the Medical Research Scholarships of the Grocers' Company must be sent in before the end of this month. The Scholarships are three in number, each of the value of £250, and are open only to British subjects; they were instituted by the Company as an encouragement to exact research into the nature and prevention of important diseases.

AT Stevens's sale room on Tuesday, a fine and well-preserved specimen of the Great Auk, from the collection of the late Sir William Milner, was put up to auction. About eighty skins of the bird are known to be in existence, of which twenty-four are in Great Britain, ten of these being in museums, and fourteen in private hands. The bidding for the specimen offered for sale by Mr. Stevens started at 100 guineas, and went up slowly to 350 guineas; but as this was lower than the reserve price, the bird did not change owners. A Great Auk's egg, offered at the same sale, reached the price of 180 guineas, while an egg of *Epyornis maximus* was sold for 36 guineas.

A PARTY, consisting of Dr. Geo. Becker, Prof. W. H. Dall, and Mr. Parington, of the U.S. Geological Survey, will leave Washington on May 16 for Alaska, and will be away until September. Congress recently directed an examination of the gold and coal deposits of the territory to be made, and this will be the work of the party; directed more especially towards an estimate of the economic value of the known deposits, rather than toward a search for new ones.

THE new system—the "Système français"—proposed by the French Société d'Encouragement to regulate the pitch of screws, and the metric wire gauge—the "Jauge décimale métrique"—in which the number of a wire is the same as the diameter expressed in tenths of millimetres, have been adopted in the French Navy by the Minister of Marine. The approval thus officially shown to the new scales will greatly assist the Society in its efforts to establish uniform gauges for wires and screw-threads.

THE news that the office of Superintendent of Agriculture, held by Mr. C. A. Barber in the Leeward Islands, has been abolished, and that the Department of Agriculture, as such, no longer exists, is altogether surprising. The Department was only opened towards the end of 1891, but, under Mr. Barber's direction, the four botanical stations in connection with it, at Antigua, Dominica, St. Kitts, and Montserrat, have done a large amount of work, which is daily becoming more and more known and appreciated. No agricultural community can afford to be without scientific advice in these days of competition and plant disease. Why the local Legislature should dispense with this advice just when the Superintendent of their Department of Agriculture had, by incessant study of the climatal and economic conditions of the islands, attained the position to give it authoritatively, is quite beyond our comprehension.

THE "Exposition annuelle" of the French Physical Society was held last week. Many new and ingenious pieces of apparatus, for use in all branches of physical investigation and instruction, were on view. Electrical instruments occupied a large share of the exhibits, but there were also to be seen new forms of barometers, thermometers, calorimeters, spectrosopes, dynamometers, balances, and other engines of research. M. Violle exhibited photographs of the electric arc, and MM. Loewy and Puiseux showed their lunar photographs obtained at the Paris Observatory. Useful accessories to micrometers for astronomical telescopes were shown by M. Maurice Hamy. There were also on view, among numerous other things, metals of new compounds prepared by M. Moissan in his electric furnace; a radiometer which turned in the opposite direction to that of the ordinary form of the instrument; M. Janssen's long-period meteorograph, designed for the Mont Blanc Observatory; M. Raoul Pictet's apparatus for the experimental study of the critical points of liquids; and the spectrum of argon. Visitors to the Exhibition must have derived considerable benefit from an inspection of the many physical instruments and devices which were to be seen.

MAJOR CARDEW'S report on the inquiry which he has made into the circumstances connected with a series of explosions which occurred on February 1, on Southwark Bridge, has just been printed as a Parliamentary Paper. It will be remembered that there were four explosions: the first, and by far the most intense, occurred in the culvert under the pavement and roadway on the west side of the bridge, and it was immediately followed by three explosions in the street boxes of the Electric Lighting Company, on the east side of the bridge. On opening the ground over the culvert, shortly after the explosions, a large crack was found in the 3-inch gas main, out of which the gas was coming in volumes. How the gas was fired could not be exactly ascertained, but Major Cardew confidently asserts that it was not by means of the electric lighting mains. The most striking features about the accident seem to be: (1) The distance to which it appears that a series of explosions may travel along the electric mains which form a gigantic network under the whole of the streets of the city; and (2) the proof it affords of the insufficiency of any ordinary system of ventilation of these pipes and street boxes, if gas can find an easy access to them, and the necessity of exercising great care to make and keep the street boxes impervious to gas. In a former report it was recommended that "accumulation of gas should be prevented by thorough ventilation, by making the sides and bottoms of street boxes impervious to gas, and by filling up the boxes as far as practicable with incombustible material"; to this Major Cardew now adds—"by thoroughly plugging pipes and conduits at each street box to prevent passage of gas along the system," and he puts the filling up the boxes first, as the most simple and certain method of preventing danger of explosion. It is admitted that the main cause of the explosions was the defect in the gas-pipe, and this again directs attention to the very serious danger to the public arising from the condition of the gas-pipes in many districts, and the way in which they are laid and supported; a danger which is continually increasing, owing to the spread of the use of wood paving and other impervious surfaces, and which is temporarily intensified by every severe frost. No want of care on the part of the gas companies can, however, relieve electric lighting companies of the duty of sufficiently protecting their conduits and street boxes against an accumulation of gas, by acting on the recommendations made.

It is very commonly believed that in Ireland, on account of the mild climate, the Arctic or Mountain Hare does not turn white in winter, but remains in its brown summer fur. Writing in the *Zoologist*, Dr. R. F. Scharff brings evidence that there is no change in the colour of the Irish hare in most winters. But, on the other hand, Major-General Warrant states that—"At Finnebrogue, near Downpatrick, a very large number of hares are taken or killed every year, and it is found that a considerable number of them turn very white in the winter, while nearly all assume a much lighter shade of fur when the cold weather sets in." The editor of the *Zoologist* says that this view is supported by a number of sportsmen and good observers, and that he himself has shot several Irish hares in all stages of change from brown to white.

There is an interesting paper in the *Electrician*, by Messrs. Campbell and Lovell, on the supposed magnetic tangle. Prof. Ewing has recently shown that in the case of good wrought iron, when subjected to very many reversals in weak magnetising fields, there is no perceptible change in the magnetic qualities. The authors have made use of strong magnetising helix, and have experimented on cast as well as wrought iron. The specimens to be tested were in the form of rings wound over with primary and secondary coils. A single B.H. curve was taken by the ordinary ballistic method, and

then an alternating current of about 1.4 amperes at 83 alternations per second was kept passing through the primary coil for nearly a month. Another series of tests were then made, and it was found that the B.H. curve obtained coincided exactly with that given before the repeated reversals, both in the case of wrought and cast iron.

THE current number of *Wiedemann's Annalen* contains a paper, by Herr A. Bock, on the ratio between the lateral contraction and the longitudinal dilatation (Poisson's ratio) in magnetised iron rods. In the method employed the rod under test is rigidly supported at its middle, so that it lies in a horizontal plane. At either end of the rod a cross-piece is attached, as well as a plane mirror. These cross-pieces serve as lever arms, from the ends of which weights can be hung. In this way the bar is both bent and twisted, the amount of bending and twisting being read off by means of a vertical telescope, two scales at right angles, and the mirrors attached to the ends of the rod. The difference of the readings on the scale parallel to the length of the rod (B) is proportional to the bending, while the difference in the readings on the scale at right angles to the length of the rod (T) is proportional to the twist. Then using Kirchhoff's formula, Poisson's ratio is given by  $\mu = \frac{T}{B} \frac{s}{2l} - 1$ , where  $s$  is the half length of the rod, and  $l$  is the length of the lever arm, at the end of which the deforming weight acts. Neither in the case of hard steel or soft iron (a magnetising coil being used in this latter case) was a difference in Young's modulus, or of the torsional rigidity greater than 0.5 per cent. observed. In the case of soft iron, the author considers that his experiments are sufficiently accurate to show that after magnetisation the torsional rigidity and Young's modulus both diminish. Since, however, B diminishes faster than T, the value of Poisson's ratio increases. The author finds that frequent magnetisation and deformation causes the differences in the elastic constants between the magnetised and unmagnetised states to diminish, and he therefore concludes that it is not possible to detect the effect on the elasticity of magnetisation in a rod by the change in the pitch of the note it emits when struck.

THE field experiments now in progress in various parts of the country partake rather of the character of demonstrations than of incursions into the domain of original research. The experiments made in Carnarvonshire last year, in connection with the agricultural department of University College, Bangor, included a series in which a mixture of rye grass and clover seeds was pitted against mixtures containing the seeds of other grasses than rye grass, in addition to or exclusive of the latter. The crops were cut in July, and weighed green, when the crop containing clovers and rye grass only was found to be the heaviest. All the plots are to be grazed for the next three years, and it is obvious that considerable time must be allowed before definite conclusions can be arrived at. Experiments made in Anglesey "to test the best quantity of seed to sow for oats," appear provisionally to demonstrate that four or six bushels of seed (black Tartarian) broad-cast per acre, give better crops than are obtained from eight bushels of seed, the quantity sown under the usual practice of the island. In both counties comparative manual experiments are in progress upon pasture land and field crops.

THE work of the Aberdeenshire Agricultural Research Association in 1894 was largely concerned with an inquiry into "degeneration of rye grass and possible recovery." It is argued that, in permanent pasture, "starvation of plants, and non-utilisation of the plants when grown, are the features to be remedied, in order to secure permanent pasture of the valued rye grass." The supreme value of *Lolium perenne* in pastures,

as demonstrated by Sir John Lawes and others a few years ago, appears to be steadily acquiring additional confirmation in different parts of the country, and the economic importance of the question is beyond all doubt. We are afraid that confusion is likely to arise from the adoption of a practice in vogue at some of the American experiment stations, where the word "legume" is used to denote "leguminous (papilionaceous) plant." In this report we read, "Legumes (*i.e.* tares, peas, clover, lucerne, &c.)." The word "legume" has already a definite meaning attached to it by English botanists, whilst in colloquial use in France it has another and a wider application. Exception should also be taken to the use of the term tubercles (or tubercles) to denote the structures on the roots of leguminous plants. Lawes and Gilbert have, with admirable consistency, adhered throughout to the word "nodules," and it is unfortunate that this example has not generally been followed. Students of agriculture are hearing more and more of tubercle in animals, and of the disease termed tuberculosis, and there is a tendency, at least on the part of beginners, to think that all tubercles must be alike. The general adoption of the word "nodules," as used by Lawes and Gilbert, would lessen the possibility of confusion.

MISS CHRISTINE LADD FRANKLIN publishes an interesting paper on "The Normal Defect of Vision in the Fovea" in the current number of the *Psychological Review*. Recent investigations of Königs on the relative absorption of different portions of the spectrum by the visual purple, the curve of which corresponds with the curve which expresses the distribution of brightness along the spectrum for (1) the totally colour-blind and (2) the normal eye in a faint light, suggest that vision both in (1) and (2) is conditioned by the presence of visual purple in the retina. But this visual purple is absent in the fovea. If this be so, the eye in (1) and (2) should be blind in that part of the retina. Careful observations and experiments were made to test the validity of this conclusion. "The blindness of the fovea for faint light did not at once reveal itself; the act of fixation means holding the eye so that an image falls on the part of the retina best adapted for seeing it, and hence it would involve keeping the image *out of* the fovea in a faint light, if the fovea were then really blind. But after the total disappearance of the small bright object looked at had several times occurred by accident, it became possible to execute the motion of the eye necessary to secure it at pleasure. It was then found that the simple device of presenting a group of small bright objects to the eye of the observer was sufficient to demonstrate the 'normal night-blindness of the fovea' without any difficulty—one or other of them is sure to fall into the dark hole of the fovea by accident." Observations on a totally colour-blind boy showed the blindness of his fovea. The function of the retinal purple is, it is suggested, for the reinforcement of waning light, and is especially adapted for the absorption of the faint green light of dense forests.

THE Calendar of Queen's College, Galway, for 1894-95, has just been published, and also that of the Royal University of Ireland, for the year 1895.

THE current number of the *Journal* of the Royal Agricultural Society of England contains a long report, by Sir J. B. Lawes, F.R.S., and Sir J. H. Gilbert, F.R.S., on "The Feeding of Animals for the Production of Meat, Milk, and Manure, and for the Exercise of Force."

A NEW edition has been published of "Stephens' Catechism of Practical Agriculture" (W. Blackwood and Sons), revised and largely rewritten by Mr. James Macdonald. The popularity of the book is vouched for by the fact that more than twenty-one thousand copies have been sold.

TWENTY-EIGHT short essays by Dr. Jean Rey, "On an inquiry into the cause wherefore tin and lead increase in weight on calcination," form the contents of No. 11 of the *Alembic Club Reprints*. The essays, which originally appeared in 1630, are interesting because they contain descriptions of experiments and results which anticipated, to some extent, the work done by Lavoisier a century and a half later.

PARTS of the first and second editions of Malthus' essay on the principle of population, have been published, in a handy volume, in Messrs. Macmillan's series of *Economic Classics*, edited by Mr. J. Ashley. Of the first edition, published in 1798, about one-third has been reprinted; but of the second edition, which contained about four times as much matter, the selected chapters are only one-twentieth of the whole work.

AN account of principles and practice of the methods adopted by Dr. T. Schott in the treatment of chronic diseases of the heart by means of mineral baths and exercises, has been written by Dr. Bezly Thorne, and published by Messrs. J. and A. Churchill, together with a description of the Nauheim baths, and of the therapeutic exercises. The volume is full of diagrams and other illustrations of interest to students of cardiac affections.

A GERMAN edition of Mr. Benjamin Kidd's "Social Evolution," with a preface by Dr. A. Weismann, has just been published by Gustav Fischer, Jena.

FIVE new volumes belonging to the "Encyclopédie scientifique des Aide-Mémoire" have come to us from the joint publishers, Gauthier-Villars and G. Masson, Paris. They are: "Le Fonctionnement des Machines à Vapeur," by G. Leloutre; "Des Marées," by P. Hatt; "Balistique des Nouvelles Poudres," by E. Vellier; "La Théorie des Procédés Photographiques," by A. de la Baume Pluvinel; and "La Distillation," by E. Sorel.

INDEXES to the literature of cerium and lanthanum, by Dr. W. G. Magee, have been published together as No. 971 of the "Smithsonian Miscellaneous Collections," in accordance with the recommendation of the Chemical Literature Committee of the American Association for the Advancement of Science. The difficulty and labour involved in the preparation of these indexes can only be fully understood by those who have attempted similar tasks. All chemists should be grateful to Dr. Magee for his very valuable bibliography.

A FULL notice of the life and numerous works of the late Mr. F. Buchanan White appears, with a portrait, in the April number of the *Annals of Scottish Natural History*. A report on the remarkable visitation of the Little Auk to Scotland, during the past winter, is contributed to the same number by Mr. W. E. Clarke. The whole of the records of occurrences of the bird from December 22, 1894, to February, are shown upon a map which accompanies the report, and are also precisely tabulated in chronological sequence.

DR. HENRY MAUDSLEY'S "Pathology of Mind" (Macmillan) has recently been published in such an altered and enlarged form, that it is virtually a new book, "for," to quote from the preface, "while old matter has been left out, and much fresh matter added, the whole has been recast, the form of the presentation changed, and the text entirely rewritten." The present contents of the work, as expressed by the new subtitle, constitute a study of the distempers, deformities, and disorders of the mind.

IN the third *Bulletin* of the Madras Government Museum appears a revised edition of Mr. Edgar Thurston's "Rameswaram Island and the Fauna of the Gulf of Manaar." The

situation of Rameevaram, on the reef which, under the name of Alam's Bridge, almost connects Ceylon with the mainland of India, renders an account of its flora and fauna particularly interesting; and the present brochure, which is illustrated with several charts and photographs of the coast, furnishes a useful supplement to Haeckel's graphic pages upon the island of Ceylon. The observations recorded are admitted to be far from exhaustive of the biological features of the Gulf of Manaar, but they are more than sufficient to indicate the existence of a fauna well worthy of further examination.

THE Malacological Society of London, instituted for the study of the Mollusca and Brachiopoda, only came into existence in February 1893, but its performances up to now give every promise of a successful future. It publishes *Proceedings*, in which appear anatomical papers, and papers devoted to descriptions of recent and fossil shells. A valuable address by Dr. H. Woodward, F.R.S., dealing largely with scientific investigations of the sea and its inhabitants, appears in the fourth number of the Society's *Proceedings*, with a number of other papers. In this connection we notice that the *Journal of Malacology* contains a contribution, by Dr. J. C. Thresh, on "Oysters as Disseminators of Disease," and, together with several other communications and a bibliography of recent literature, an interesting note, by Mr. W. M. Webb, on "The Dimyarian Stage of the Native Oyster."

THE Natural History Societies in our public schools probably do more to foster scientific research than all the systematic instruction in lecture-room and laboratory: therefore every encouragement should be given to the work of observation and collection which is carried on by them. Increased demands of both school work and games on half-holidays leave little time to cultivate interest in natural things, and this accounts partly for the statement in the report of the Rugby School Natural History Society for 1894, that the interest shown in the Society by members of the school has decreased. Possibly, now that the new museum is completed, and the collections in it are being systematically arranged by Mr. Collinge, the Society will commence a new era of prosperity.

THE Danish Meteorological Institute and the Deutsche Seewarte have conjointly published daily synoptic weather charts of the North Atlantic Ocean and adjacent continents for a year ending November 1889. These valuable charts were first issued for September 1873 by the late Captain Hoffmeyer, of Copenhagen, and they afford excellent materials for tracing the connection between the weather conditions of the Atlantic, this country, and Western Europe. For some years past the charts have been accompanied by explanatory text, which greatly enhances their value. The discussion of the charts for the year in question is divided into two parts: (1) general investigations of the conditions over the North Atlantic, and (2) application of this knowledge to navigation; while the position and movement of the areas of high and low barometer, in interesting cases, are shown in forty special charts accompanying the text.

SEVERAL aromatic esters of arsenious acid have been prepared for the first time by Dr. Fromm, of Rostock. The new substances are either viscous liquids or crystalline solids, and are prepared with considerable facility. The first member of the series, the triphenyl ester,  $As(OC_6H_5)_3$ , is obtained by allowing arsenic trichloride diluted with ether to fall drop by drop into sodium phenylate suspended in ether. The reaction proceeds vigorously at the ordinary temperature, but the mixture eventually requires warming over a water bath in order to obtain the theoretical yield. The ethereal liquid is then allowed to stand until the finely divided precipitate of common

salt subsides, when it is decanted from the latter. The ether is then removed by distillation over the water bath, and the thick residual liquid subsequently subjected to distillation under reduced pressure. Arsenious triphenyl ester is a colourless viscous liquid endowed with an odour somewhat resembling that of phenol; it boils under a pressure of 57 m.m. at 275°. The liquid is remarkably sensitive to moisture, for water instantly decomposes it into arsenious oxide and phenol. Halogens do not form additive compounds with it, but chlorine and bromine convert it into arsenic trichloride or tribromide and trichloro- or tribromophenol. The second member, the paracresyl ester,  $As(OC_6H_4CH_3)_3$ , is similarly obtained, and is likewise an oily liquid, boiling at 200° under 20 m.m. pressure, and endowed with similar properties. The benzyl ester,  $As(OC_6H_5CH_2)_3$ , has also been isolated in an analogous manner, but is not quite so stable as the two esters just described, being more or less decomposed upon distillation *in vacuo*: it may be obtained practically pure, however, by heating the product of the reaction in an oil bath to 200° under low pressure. It reacts with water similarly to the two other esters. In addition to these liquid aromatic arsenious esters, the  $\beta$ -naphthyl ester,  $As(OC_{10}H_7)_3$ , has been prepared by the action of arsenic trichloride upon the sodium derivative of  $\beta$ -naphthol. As the sodium compound is in this case completely soluble in ether, the arsenic chloride reacts with great energy. The arsenious naphthol ester crystallises from the ethereal solution after decantation from the precipitated common salt, in colourless aggregated crystals, which melt at 113°-114°, and are readily soluble in alcohol and benzene in addition to ether. Water immediately decomposes them, and in boiling water the products of the decomposition, arsenious oxide and  $\beta$ -naphthol, dissolve completely.

THE additions to the Zoological Society's Gardens during the past week include a Green Monkey (*Cercopithecus callitrichus*, ♀) from West Africa, presented by Miss Florence Greffia; a Bonnet Monkey (*Macacus sinicus*, ♀) from India, presented by Mr. R. J. Davidson; two Polar Hares (*Lepus glaucus*) from Norway, presented by Mr. O. Gale; a Common Bulger (*Miles taxus*) from Berkshire, presented by The Duke of Wellington; an Irish Soot (*Putorius hibernicus*) from Ireland, presented by Viscount Powerscourt; two Antipodes Island Parrakeets (*Cyanorhynchus unicolor*) from Antipodes Island, New Zealand, presented respectively by Sir Walter L. Buller, K.C.M.G., and Mr. William E. Collins; two Scarlet Tanagers (*Ramphocelus brasilius*) from Brazil, presented by Mr. Robert E. Graves; a Red and Blue Macaw (*Aratinga macaw*) from South America, deposited; two Griffon Vultures (*Cypselurus fulvus*) from Egypt, purchased; an Egyptian Gazelle (*Gazella dorcas*, ♂) from Egypt, received in exchange; a Great Kangaroo (*Macropus giganteus*, ♀), a Rufous Rat Kangaroo (*Hypsiprymnus rufescens*), born in the Gardens.

#### OUR ASTRONOMICAL COLUMN.

THE VARIABLE STAR Z HERCULIS.—This recently discovered variable star turns out to be one of exceptional interest. It was first suspected of variability by the Potsdam observers, and subsequent observations by Chandler and Hartwig seemed to show that it was a star of the Algol type. Early in the present year Dr. Duncanson announced that the new variable was probably of the V Cygni type with unequally bright components, since he found unequal minima alternating in periods of forty-seven and forty-nine hours. Returning to the subject (*Astrophysical Journal*, April), Dr. Duncanson gives the data on which his conclusion was based, and derives some interesting results as to the probable constitution of the system. The normal magnitude of the star is 6.89; at principal minimum it falls to 8.05, and at secondary minimum to 7.35. Hence,

the relative degrees of brightness at these times are 1,  $\frac{2}{3}$ , and  $\frac{1}{3}$ , and assuming that the eclipses are central, it is easily shown that the observed magnitudes may be explained by supposing that the two components are of equal size, while one is twice as bright as the other. The unequal duration of the minima further indicates that the orbit is an ellipse with an eccentricity of 0.2475, and it is calculated that the semi-axis major of the orbit is six times the diameter of the stars. The plane of the orbit passes through the sun, and the line of apsides is inclined at an angle of  $4^\circ$  to the line of sight. The stars revolve in this orbit in a period of 3 days 23 hours 48 minutes 30 seconds.

It seems probable that this variable may form a connecting link between Algol, which consists of a bright and a dark body, and Y Cygni, consisting of two stars of equal brightness.

**THE DIAMETER OF NEPTUNE.**—With the Lick telescope and an eyepiece magnifying 1000 diameters, Prof. Barnard finds the mean angular diameter of Neptune, when reduced to the mean distance from sun 30.0551, to be 2.433. This corresponds to an actual diameter of 32,900 miles, which is from two to four thousand miles less than that stated in most of our textbooks.—*Astronomical Journal*, No. 342.

### INDUCED MAGNETISM IN VOLCANIC ROCKS.

AN interesting note by G. Fulgheriter, on the magnetism induced in volcanic rocks by the earth's magnetic field, appears in the *Atti della Reale Accademia dei Lincei* (vol. iv, part 5, March 3, 1895). The author has performed a number of experiments on volcanic rocks, in order to determine the amount of induced magnetism left when, after heating to such a temperature that they entirely lose their permanent magnetism, they are either allowed to cool slowly or are suddenly cooled, in each case under the influence of the earth's field. From such observations he hopes to be able to deduce some conclusions as to the conditions under which the rocks experimented on, which were originally permanently magnetised, became magnetised. The rocks are cut into small parallelepipeds weighing about 50 grams, and such that the length is about two or three times the depth or breadth, care being always taken to cut the rock so that the axes of these pieces were vertical when the rock was in its place in the earth. The intensity of magnetisation was in every case measured by the method of deflection; a freely suspended magnetic needle being deflected by the sample, which was placed with its length east and west. After measuring the intensity of magnetisation of the sample, they were heated to redness, and then either allowed to cool slowly, or are rapidly quenched with their axes vertical. Their magnetic moment was determined, first immediately they were cool, and then after they had stood under the influence of the earth's field for three months. The specimens of basalt examined may be divided into two groups: in the first may be placed those specimens which were originally only slightly magnetised, and in this case, after heating to redness, the magnetisation is always increased, but to a very different degree in the different specimens. The second group includes those basalts which were originally strongly magnetised, and in this case after heating the magnetisation was considerably reduced. In both groups the magnetisation underwent no change during three months, and sudden cooling gave the same results as slow cooling. Experiments have also been made on tuff and peperino. The results obtained with the first of these rocks are similar to those obtained with the first group of basalts. Peperino, however, differs in that, before being heated, its coercive force seems almost nil, the bar becoming only temporarily magnetised. After heating, the character of the rock is altered, as it can now become permanently magnetised and behaves just like the tuff. From this the author concludes that peperino has been formed at a low temperature, probably by the action of water on cinders, &c.

### THE FREEZING-POINT OF DILUTE SOLUTIONS.

CORRECT determinations of the freezing-point of dilute solutions are of fundamental importance in connection with the general theory of the subject, and it is therefore anything but satisfactory to find that, in spite of the closeness with which the individual results of the same observer agree amongst themselves, the results of different observers are in many cases

widely separated. For example, the following values have been given as the molecular depression of the freezing-point in the case of a 1 per cent. aqueous solution of sugar: 2.02, Arrhenius; 2.07, Raoult; 2.01, Pickering; 2.18, H. C. Jones; 1.81, Loomis. The results of Jones and Loomis, both of whom claim increased accuracy for the methods they employ, differ by some 18 per cent. The theoretical value of the molecular depression, calculated from the melting point and heat of fusion of ice, is 1.86. The cause of these differences has given rise to much discussion. Pickering has attempted to show that Jones's results, wherein the temperature was read to the ten-thousandth of a degree, were affected by thermometer errors. Jones has replied that his thermometer was tested. Kohlrausch has drawn attention to probable sources of error in Jones's method, but is compelled to admit that the differences between the results of Jones and Loomis must, in the main, be due to some unknown source of error.

A definite step in the direction of clearing up this point is made in a recent number of the *Zeit. Schrift f. r. physikalische Chemie*. Here Nernst and Abegg emphasise the fact that the observed freezing-point must in general be different from the true freezing-point, or the temperature at which solid and liquid are in equilibrium. They point out that a partly-frozen liquid, uninfluenced by the temperature of its surroundings, will strive to reach the true freezing-point at a rate which, at any instant, may be taken as proportional to the difference between its actual temperature and the true freezing-point. Again, in practice, on account of the limited amount of substance employed, and the effect of the temperature of the surroundings, &c., unfrozen liquid strives to reach a definite temperature, which may be termed the "convergence temperature." On these assumptions it is easy to show that the observed freezing-point, or the temperature at which the thermometer becomes steady, will only be the true freezing-point if the "convergence temperature" is equal to the true freezing-point, or if  $R$ , the rate at which the temperature of the partly frozen liquid approaches the freezing-point, is infinitely great as compared with  $x$ , the rate at which the temperature of the unfrozen liquid approaches the "convergence temperature." If one of these conditions is not fulfilled, corrections determined experimentally have to be applied. For dilute solutions of alcohol and common salt the corrections were found to be inappreciable under the experimental conditions described in the paper. Here the value obtained for  $R$ , although, as is always the case, it was largely diminished by the lag of the thermometer, still was sufficiently large as compared with the value of  $x$ . In the case of sugar, however,  $R$  was so small that by varying the experimental conditions, a 1 per cent. solution gave molecular depressions varying between 1.6 and 2.1—limits which are even further apart than those given by the results of previous observers. On correcting the observed depressions in the manner described, they all gave practically the theoretical value.

Without these corrections, observed freezing-points are thus held to be functions of the size of the apparatus used, the temperature of the cooling-bath, the rate of stirring which largely affects the "temperature of convergence," &c.

Evidence is also given of the futility of expressing freezing-points to the ten-thousandth of a degree. It may readily happen that the above correction is as high as 0.01, and as the mode of deducing it is but approximate, in such a case 0.001 or 0.002 would be a favourable estimate of the error of the end result, even if satisfactory corrections could be applied for the alteration in the concentration of the solution produced by freezing, and the ordinary sources of error incidental to the method of experiment.

J. W. RONGER.

### THE EXAMINATION CURVE.

IF the results of the examination of a mixed body of candidates be plotted out on the graphic method, they will be found, in accordance with a well-known law of statistics, to approximate to a curve having a more or less rapid gradient at either end, and a mid-region of gentler ascent. Fig. 1, for example, shows the results of an examination of 27 students in physical geography, the scale of marks running vertically from 10 to 90, the examinees being arranged horizontally at equal distances apart from the lowest to the highest. The larger the number of candidates the more flattened does the mid region of the curve tend to become. Again, in any series of examinations, the mean results of which are plotted out, the more uniform

the standard of difficulty of the papers set, the flatter is the mid-region of mediocrity. Fig. 2 shows the mean results of ten separate examinations, of different students conducted by six examiners, in history, English literature, geography, physical geography, physics, botany, arithmetic, and Euclid. They are taken with a special selection from the returns of class examinations in University College, Bristol. The standards were somewhat markedly different; in some the head, in others the tail being excessive; hence the mid-region is not so flattened as it probably would have been had a larger series been taken. The results indicate, however, sufficiently well

of my own observations show that the tail does tend to flatten out and become raised as we ascend. But it is by no means got rid of. It flattens because we have eliminated the hopelessly idle and those who have altogether mistaken their vocation. It persists because at each stage there are those whose limits of capacity have been reached. A student whose capacity may bring him into upper mediocrity in matriculation, may drop hopelessly into the tail when he proceeds to work for the degree. I was informed, on good authority, at the Cape, that whereas the Kaffir lads were often ahead of white boys in the early stages of education, the limits of their capacity were soon reached, and they were left behind by those whom they had before easily beaten. At each stage there are pupils for whom the work is beyond their powers; and they inevitably fall into the tail.

In the traditional division of candidates into three classes, the most rational method is to place in the first class those at the head of the curve, the mediocrities in the second class, and the tail in the third class. For many years it has been my custom as an examiner to plot out on the graphic method the results of each examination. The advantage of doing so is that one thus sees at a glance the distribution of the examinees. One can also more readily see where the divisions should run between the several classes. It is irrational to fix beforehand some arbitrary number of marks to form the limiting line above which the candidates are to be called first class, those below this and above another arbitrarily chosen number being ranked in the second class. The limit must be determined—and even then it is often only determined with difficulty—by an inspection of the curve. The form of the curve, and the level of mediocrity in the scale of marks, enable one to decide whether the paper has been too hard or too easy. If too hard, the level of mediocrity will be low, and the tail inordinately large; if too easy, the level of mediocrity will be high, and the head not well differentiated from the body.

The examination curve may be commended to the special consideration of those who have to deal with large numbers of candidates in connection with the Education Department and that for Science and Art. And I would recommend to the consideration of those who have the control of Civil Service and Army Examinations the excellent suggestion made by Dr. J. Venn, in a paper on the "Correlation of Mental and Physical Powers," contributed to the *Monist* for October 1893. In these examinations large numbers of candidates compete for a limited number of vacancies. Let the results be expressed in an examination curve. It will have a well-marked head, a longish body of mediocrity, and a decided tail. We may cheerfully eliminate the tail; it consists of duffers intellectually. We may select the head for entrance; it consists of men of marked intellectual superiority, so far as the examinations are an adequate test thereof. If the head exhausts all the vacancies, well and good. But if the number of vacancies involves an extensive incursion into the body of mediocrity, then it will be found that the lower selected candidates will be very little superior intellectually to the higher rejected candidates. The last ten selected, and the ten seniors among the rejected, will probably be separated by a comparatively small number of marks. Moreover, it is a well-known fact, *experto crede*, that, if, after an extensive set of papers has been looked over and carefully marked, an interval of time be allowed to elapse, and then the papers are gone over again, the result of this re-examination is that the head and tail remain practically unchanged, but that there is not a little redistribution among the mediocrities. Furthermore, if a different examiner look over the papers, the head and tail of his curve will not differ markedly in arrangement or form from those of his predecessor; but among the mediocrities there will be not a little shifting of places. While, therefore, such an examination as that for entrance to Woolwich or Sandhurst serves to select the intellectual head, and to reject the intellectual tail, it is by no means so effectual in classifying the candidates who fall within the body of mediocrity.

Now if the same body of candidates be further examined by some physical test (and Dr. Venn regards lung-capacity and breathing power the best single physical test), it will be found that in this respect there will be a curve with well-marked head, a mediocre body, and a rapidly descending tail. But the intellectual head and tail will not include the same candidates as the physical head and tail. Let us therefore select from our intellectual mediocrities those who fall within the head of the

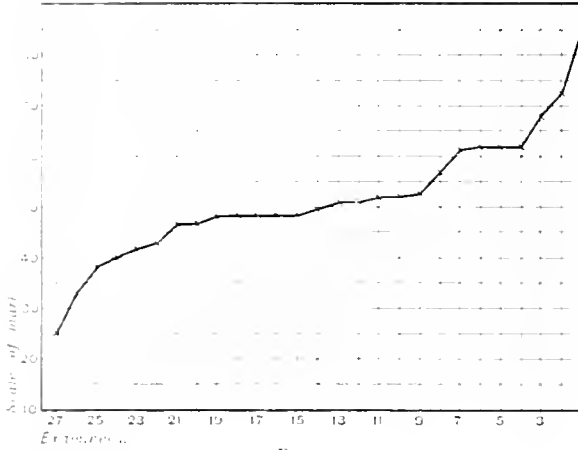

FIG. 1.

the general nature of the examination curve. The total range of marks being from 17.5 per cent. to 84 per cent., 15 out of the 30 students fall within the mid-region of from 40 per cent. to 60 per cent.

It is not my purpose to attempt to determine how far the form of the lower end, or tail, of the curve is due to incapacity on the one hand, or to sheer idleness on the other, and how far that of the upper end, or head, of the curve is due to exceptional ability on the one hand, or to industry and hard work on the other. Whichever cause preponderates, we may say that, at any rate with pupils who have got beyond the school-boy stage,

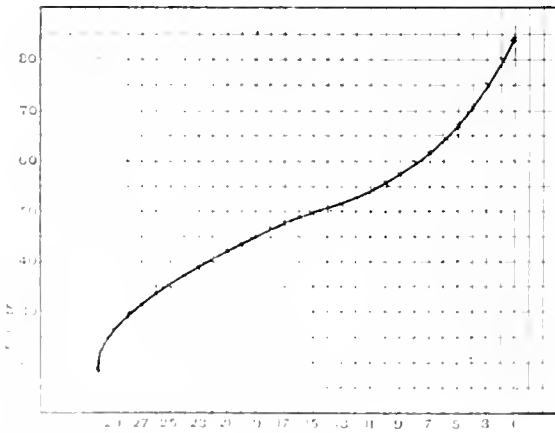

FIG. 2.

he may largely with them too, the teacher's chief field of action is in the preponderant mid-region of mediocrity. Even in the tail of the curve either cannot or will not profit by re-examinations; those at the head of the curve may be trusted to do so without his aid, or even in spite of his interference. It is in the body of the curve that he can do his best work.

It is, perhaps, somewhat remarkable that the general nature of the curve persists as we ascend through a series of examinations. It might well be supposed that the tail of the curve examined in the lower examinations, and the results



physical examination curve. If we must admit intellectual mediocrity, let us, at any rate, secure that we have, in compensation, physical excellence.

In practice this would necessitate the preliminary testing, when they are undergoing their medical inspection, of all candidates by means of the spirometer; neither a difficult nor a lengthy operation. No doubt, as Dr. Venn points out, breathing-power may to some extent be improved by practice, and candidates would all flock to a "spirometer-crammer." But probably all of them would be the better for some physical cramming in this way. C. LLOYD MORGAN.

### UNIVERSITY AND EDUCATIONAL INTELLIGENCE.

CAMBRIDGE.—Prof. W. Watson Cheyne, F.R.S., has been appointed an additional Examiner in Surgery for the present term.

An inter-collegiate Examination in Mechanical Science and Engineering, for candidates for the Mechanical Sciences Tripos, will be held, under the direction of Prof. Ewing, at the end of this term, commencing on June 4.

THE Somerset County Education Committee have adopted a resolution in favour of establishing in the county a fixed Dairy Farm School for adults of both sexes. Instruction in cheese and butter making, and in subjects allied thereto, would be given. Provision is made for granting thirty scholarships, giving free board and tuition in the school, for two months, to farmers' sons and daughters engaged in dairy work. The Committee have agreed that it is desirable to set up an agricultural side to one or more of the existing secondary schools in the county. It is hoped that in due course an agricultural college for the West of England will be provided by the combined efforts of the local counties.

WITH the view of acquainting teachers with a course of experiments in accordance with the British Association Committee's programme for the teaching of Chemistry in schools, the Evening Schools Code, and the syllabus for Major Scholarship examinations recently prepared by a committee of the Incorporated Association of Head Masters, Prof. Armstrong, F.R.S., will give a series of demonstrations at the City and Guilds Central Technical College, on Saturday mornings, in May. The special object of the course will be to explain the exact method to be followed in carrying out a carefully arranged series of very simple qualitative and quantitative experiments calculated to impress the chief and most generally useful facts of chemistry on children's minds whilst developing their powers of observing and reasoning.

It has often been urged against the educated natives of India, that they are admirable at adaptation, but are altogether at a discount where original research is concerned. The Hon. Mr. A. Cadell commented upon this failing in a recent address to Convocation of Allahabad University. His advice was that debating societies, which are so common a feature of student-life, should give place to natural history societies; the object would be to foster the true scientific spirit in the native mind. In this connection, some remarks (which we quote from the Allahabad *Morning Post*), made by Prof. Ingram, of the Madras Educational Service, indicates that the complaint as to the want of scientific research by natives of India is not without foundation. In a recent contribution he says:—"Now, if India is not helping in this work, if she is supplying no additional information, and is offering no aid towards the consummation of this unity, her claim to be regarded as in any sense a scientific country, is null and void. No matter how assiduously her students may devote themselves to studying the science course of their University curriculum: if it all end there, it is nothing. But need it end there? What country could offer greater facilities for scientific research than India? Here is a country teeming with animal and plant life; but the systematic biology of India is still in a nebulous condition. Why are no students devoting themselves to collecting and collating, and studying the plants of their districts, or the insects that abound within their walls? It would be hard, too, to find a country better suited than India, with her clear atmosphere and cloudless skies, for the study of the stars or of other atmospheric phenomena. In these ways, and in a thousand others, we might be advancing

the cause of knowledge. But we can scarcely be said to have begun yet." By way of remedy, Prof. Ingram suggests the formation of an Indian Royal Society, or some such association, which would serve the same purposes here as the British Association does at home. It is possible, however, without going to that length, to utilise the resources already at hand. India is not without its scientific societies. There are the Asiatic Society of Bengal, the Indian Science Association, and the Bombay Natural History Society, all of which are amply sufficient for the purposes of scientific research.

### SCIENTIFIC SERIALS.

*American Journal of Science*, April.—Niagara and the Great Lakes, by F. B. Taylor. By a correlation of the abandoned shore lines, moraines, and outlets, and the gorges, recently-submerged shores, and rivers of this region, the author is led to the view that the lakes were at first glacial and ice-dammed, falling by stages as the outlets changed on withdrawal of the glacier-dams. By the withdrawal of the glacier the Niagara river was opened, and the upper lakes became united. The land was gradually depressed at the north, and finally led to the opening of Nipissing outlet, which was then brought down to the sea-level, and marine waters filled the three upper lakes, the Ontario, St. Lawrence, and Winnipeg basins. The subsequent raising of the Nipissing outlet made the upper lakes fresh again. Then followed the stage of the second Lake Algonquin and that of the second present Niagara lakes. Lake Superior became independent. The Great Champlain uplift took place at the north-east, and the formation of the St. Clair delta began, and continues to the present day.—Disturbances in the direction of the plumb-line in the Hawaiian Islands, by E. D. Preston. There appears to be a disturbance of more than a minute in the direction of gravity at the south point of Hawaii. At Kohala the plumb-line is deflected half a minute towards the south, and at Kalaieha nearly as much towards the north, the disturbance being in both cases towards the mountain. The deflection at the south point is also northward, and is caused by the great masses of Mauna Loa and Mauna Kea.—Structure and appendages of *Trinichu*, by Charles F. Beecher. The three posterior thoracic endopodites are very similar, and in a general way closely resemble those of *Triantaria* from the same region of the thorax. They are, however, comparatively shorter and stouter, and could not be extended beyond the ends of the pleura. The two distal joints are cylindrical, with well-marked articular surfaces and ridges. The joints preceding these proximally become much wider, flattened, and produced into transverse extensions which carry large tufts of setae at the end. The exopodites seem to be composed of slender joints, the distal exites being long and slightly curved outwards. They carry very long, close set, overlapping lamellose fringes, which evidently had a branchial function. The characters of the appendages indicate an animal of burrowing habit, which probably lived in the soft mud of the sea-bottom, much after the fashion of the modern *Limulus*. In addition to its limuloid form, the absence of eyes seems to favour this assumption. So does the fact that many specimens have been found preserving the cast of the alimentary canal, showing that the animal gorged itself with mud, like many other sea-bottom animals.

*Wiedemann's Annalen der Physik und Chemie*, No. 3.—Electric conduction and convection in feebly conducting dilute solutions, by E. Warburg. The alteration of conductivity produced by a current in bodies like aniline, the phenomena of convection exhibited by them, and their apparent deviations from Ohm's law, can all be explained on the supposition that their conductivity depends upon an electrolyte of which the body is a very dilute solution. Bodies were investigated whose conductivities went down to  $5 \cdot 10^{-7}$ . The similar behaviour of still worse conductors, like xylol, benzol, oil of turpentine, is probably due to the same cause.—Ratio of sectional contraction to longitudinal dilatation of iron rods during magnetisation, by A. Böck. By magnetisation the constants of elasticity of soft iron are altered to an extent not exceeding 0.5 per cent. The observations indicate that flexure diminishes, torsion also decreases, and the ratio of sectional contraction to longitudinal expansion increases. Iron becomes more incompressible in the magnetic field (see p. 614).—Freezing points of some binary mixtures of heteromorphous substances, by Albert Dahms. Eutectic mixtures

...ve no uniform crystallisation product, but always a heterogeneous mechanical mixture, consisting of solid solutions of the components in each other, and in the limiting cases of the components themselves. The composition of eutectic mixtures—of those mixtures of two bodies which have the lowest fusing points—does not correspond to simple molecular proportions of the components. In eutectic mixtures the process of solidification is in general more complicated than in chemically homogeneous bodies, owing to complex supercooling. Equimolecular solutions often show approximate correspondence of fusing points, also for the higher concentrations. Menthol,  $C_{10}H_{18}O$ , exists in two modifications, which explains the divergences of the freezing points of even the most dilute solutions in menthol.—On glow discharge in air, by C. A. Mebius. Straight lines representing the relation between strength of current and difference of potential for different distances between the electrodes, are not parallel, the divergence increasing with the extent to which the air has been modified by the current. The fall of potential gradually decreases with a constant or an increasing current. These changes are probably due to the formation of nitric oxide, as was proved with the spectroscope.

*Bulletin de l'Académie Royale de Belgique*, No. 2.—On a new class of ethers: methylene lactate, by Louis Henry. Methylene monolactate,  $CH_2(CH_2C_2H_3O_2)_2$ , obtained by heating lactic acid with polymerised methanal, is a colourless mobile liquid, with a strong odour resembling methanal, and an extremely pungent taste. Its density is 1.1974 at 25° C., and it boils with remarkable regularity at 153 to 154°.—Comparison of the astronomical coordinates referred to the instantaneous (astronomical) pole and the (geographical) pole of inertia respectively, by Ch. Lagrange. The discovery of the sensible character of the variations of latitude and longitude is not of such a nature as to render necessary the substitution of geographical axes to instantaneous ones in astronomy. The mean values of the latitude and the longitude will be the geographical characteristics of the spot. But for the points of the heavens, the result of the substitution of geographical for instantaneous axes would have the eminent disadvantage of affecting all their coordinates with diurnal variations 300 times greater. This is a simple geometrical consequence of the fact that every day the geographical and the instantaneous axes describe a cone about the resultant, and that the geographical cone is 300 times more open than the instantaneous cone.—Critical temperatures of mixtures and of water, by F. V. Dwellshauvers-Dery. The critical temperature of water was obtained by finding the critical temperatures of aqueous mixtures of alcohol or acetone containing more and more water. The limiting value for water, as derived from the acetone results, was 638 C., from the results with alcohol, 641 C.—Action of heat upon carbon bisulphide, by Henryk Arctowsky. Carbon sesquisulphide,  $CS_2$ , which is obtained by exposing the bisulphide to the voltaic arc, may also be obtained by keeping it at 250° C. for some time. It is this body whose presence in small quantities in commercial  $CS_2$  gives this product its pungent odour.

THE number of the *Journal of Botany* for April is occupied almost entirely by papers on descriptive botany, viz. on African species of *Erica*, on South American species of *Polypogon*, on British *Rumex*, on hybrid *Epilobium*, and others on special species of genera.

The *Bulletin of the Minnesota Botanical Society* for March contains a paper on a period of growth in the fruit of *Cucurbit*, by Mr. A. P. Anderson, accompanied by an elaborate series of tables and plates of curves. The other articles in the same number refer exclusively to the Flora of Minnesota.

## SOCIETIES AND ACADEMIES.

### LONDON.

Royal Society, March 21.—Experiment upon the Influence of Voluntary Movement and Nutrition of the Limbs. (Preliminary communication.) By Dr. F. W. Mott and Dr. C. S. Sherrinford, F.R.S.

... could be demonstrated, by experiments upon frogs, the influence of movement in a limb deprived of sensation by cutting the posterior spinal roots. The authors have, by an extensive and varied series of experiments on the monkey,

demonstrated the important rôle played by sensation in the performance of voluntary movements.

The experiments deal separately with the upper limb and the lower limb. The phenomena do not essentially differ, but are more striking in the former.

*Summary of Experiments.*—The limbs were deprived of all sensation, superficial and deep, by cutting the "whole series" of posterior spinal roots. For the upper limb, 4th cervical to 4th thoracic inclusive. For the lower limb, 2nd to 10th post-thoracic inclusive.

Animals with a limb thus deprived of all forms of sensation from the time of operation onwards, even up to four months, have never been observed to use it in any finer and delicately adjusted movements. For example: the foot is not used in climbing or grasping, nor is the hand. The animal does not use the hand to defend itself, or even to satisfy hunger, when prevented from picking up food by any other way, than by using the desensitised hand. It must be concluded, therefore, that there is actual inability to perform the movements in question. Occasionally in struggling, coarse movements of the shoulder and elbow take place; but, as a rule, the arm hangs down helplessly. The movements abolished are those most literally represented in the cortex cerebri. Damage to the pyramidal tract is not the cause of the loss of movement, because degeneration is not found in the spinal cords; moreover, stimulation of the cortex cerebri evokes movements in the desensitised limb even more readily than the normal.

The effect of section of the "whole series," except the one root which supplies the apex of the limb, produces only a very slight impairment of movement. Any trophic changes that occur are due to pressure and microbial infection.

"Is Argon contained in Vegetable or Animal Substances?" By George W. Macdonald and Alex. M. Kellas.

At Prof. Ramsay's suggestion, experiments were undertaken by the authors to see whether argon could be obtained from nitrogenous vegetables or from animal tissues.

It is concluded that there is no appreciable quantity of argon in peas (or at least that the argon cannot be obtained with the nitrogen by Dumas' method).

An experiment with regard to the presence of argon in animal tissues was also negative in its results. Mice were selected for the experiment, because the nitrogen from the whole animal could be conveniently collected by Dumas' method.

Chemical Society, March 21.—Dr. Armstrong, President, in the chair. The following papers were read:—The volumetric determination of sugars by an ammoniacal cupric solution, by Z. Peske. The author has devised a modification of Pavy's method of estimating sugars, and gives tables showing the reducing power of ammoniacal cupric solution for solutions of various sugars.—The action of hydrogen sulphide on antimonious acid solutions, by O. Božek. The author demonstrates the existence of compounds of the composition  $SbX_4$ ; he has obtained the tetrasulphide  $Sb_2S_4$ , and a double compound of the composition  $3KCl, 2SbCl_4$ .—Action of hydrogen sulphide on antimonious, arsenic and telluric acids, by B. Brauner.—The atomic weight of tellurium, by B. Brauner. From its position in the periodic table, tellurium should have an atomic weight between 123 and 125, whilst the number actually obtained is 127.74; for this and other reasons the author concludes that tellurium is not a simple substance, although attempts to effect a separation of its constituents have failed. The author suggests that tellurium is a mixture or compound of two elements, one of which occupies the position of tellurium in the periodic table, and the other of which is the hypothetical "triargon."—The hydrolysis of maltose by yeast, by G. H. Morris.—Studies in isomeric change. Part iv. Ethylbenzenesulphonic acids, by G. T. Moody. The sulphonation product of ethylbenzene yields only one sulphonic acid, and not two, as stated by Chrutschow. The para-acid is obtained thus: the ortho-acid can be prepared by sulphonating and subsequently reducing ethylmombenzene. — *B* Ethoxynaphthalenesulphonic acids. The arrest of isomeric change at an intermediate stage, by A. Lapworth. During the sulphonation of ethoxynaphthalene at a low temperature the 2:1-sulphonic acid is the first product. On allowing the mixture to stand, however, this spontaneously changes into the 2:4-acid. Some oxy-pyridine derivatives, by Miss A. P. Sedgwick and N. Collier. Starting from 7-chloro-*ac*-dimethylpyridine and *ay* dichloro-*ac*-methylpyridine, the

authors have succeeded in preparing a number of new oxypridine derivatives.—On the colouring principle of *Toddalia aculeata* and *Evollia meliifolia*, by A. G. Perkin and J. J. Hummel.—Some ethereal derivatives of sarcosolactic acid, by P. Frankland and J. Henderson. The molecular rotations, molecular deviations and asymmetry products of a number of alkylic salts of sarcosolactic acid and its acidic derivatives have been investigated.—Electrolysis of potassium allo-ethylic camphorate, by J. Walker and J. Henderson. The chief products of the electrolysis of potassium allo-ethylic camphorate are salts of allo-campholylic acid,  $C_{11}H_{17}O_3$ , and allo-camphothetic acid,  $C_{11}H_{17}O_4$ .—Trimethylsuccinic acid, by W. A. Bone and W. H. Perkin, jun.—New isomeric sulphonic chlorides derived from camphor, by F. S. Kipping and W. J. Pope. The authors describe two isomeric chlorocamphenesulphonic chlorides and their derivatives.

**Royal Meteorological Society, April 17.**—Messrs. F. C. Bayard and W. Marriott communicated a paper on the frost of January and February 1895 over the British Isles. The cold period which commenced on December 30 and terminated on March 5 was broken by a week's mild weather from January 14 to 21, otherwise there would have been continuous frost for sixty-six days. Temperatures below  $10^\circ F.$ , and in some cases below zero, were recorded in parts of England and Scotland between January 8 and 13, while from the 26th to the 31st and from February 5 to 20, temperatures below  $10^\circ$  occurred on every day in some part of the British Isles. The coldest days were February 8 to 10. The lowest temperatures recorded were:  $-17^\circ$  at Braemar and 11 at Buxton and Drumlanrig. The mean temperature of the British Isles for January was about  $7^\circ$ , and for February from  $11^\circ$  to  $14^\circ$  below the average, while the mean temperature for the period from January 26 to February 19 was from  $14$  to  $20^\circ$  below the average. The distribution of atmospheric pressure was almost entirely the reverse of the normal, the barometer being highest in the north and lowest in the south, the result being a continuance of strong northerly and easterly winds. The effect of the cold on the public health was very great, especially on young children and old people. The number of deaths in London due to diseases of the respiratory organs rapidly increased from February 2 to March 2, when the weekly number was 1448, or 945 above the average. Rivers and lakes were frozen, the ice being more than 10 inches thick. The frost will long be remembered for its effect on the water-pipes all over the country, in many cases householders being without water for more than nine weeks. As the result of inquiries the authors find that mains have frozen which have been laid as low as 3 ft. 6 in. from the surface of the ground to the top of the pipe. It appears, however, that the nature of the soil had far more to do with the depth to which the frost penetrated than the intensity of the frost itself. From a comparison of previous records, the authors are of opinion that the recent frost was more severe than any since 1814. Mr. Birt Acres read a paper on some hints on photographing clouds.

**Mineralogical Society, April 2.**—A paper was read by Mr. Spencer upon *enargite*. Several new forms were discovered upon the specimens of this mineral examined. The parameters calculated from the measurements were

$$a : b : c = 0.8694 : 1 : 0.8308,$$

numbers which differ somewhat from those previously given by Dauber. The habits of the crystals and their mode of twinning were fully discussed, and the fact pointed out, bearing upon the possibility of the identity of clarite with enargite, that measurement of cleavage fragments of clarite gave angles identical with those existing between the prism cleavages of enargite when three crystals are twinned together.—Mr. A. E. Tutton exhibited his new instrument for cutting, grinding, and polishing accurately orientated section-plates and prisms of mineral or other crystals, and demonstrated the readiness with which the cutting disc or grinding or polishing lap may be driven by a small electric motor. Mr. H. A. Miers suggested the possibility of simplifying the instrument somewhat for the commoner purposes of the mineralogist, by employing only one driving gear and making the cutting disc and laps interchangeable; he also suggested the experiment of using carborundum for the cutting edge instead of diamond dust.—Mr. Miers exhibited a crystal of *lorandite*, the new arseno-sulphide of thallium discovered by Kreuner; also a fine crystal of *elivite*, the mineral which had, at his suggestion, been examined for argon by Prof. Ramsay.

The specimen exhibited was from the neighbourhood of Moss, and this variety, as well as that from Arenal, had been found to yield the spectrum of helium.

#### EDINBURGH.

**Royal Society, January 21.**—Prof. Sir W. Turner, Vice-President, in the chair.—Drs. Gulland and Noel Paton communicated a paper on the absorption of carbohydrates from the intestine.—Prof. Ewart read a paper, by Dr. I. D. F. Gilchrist, on the torsion of the molluscan body.—Prof. Tait communicated a note on a curious property of determinants.

February 4.—Prof. J. G. M'Kendrick, Vice-President, in the chair.—Prof. Crum Brown communicated a note on normal nystagmus.—Sir W. Turner read a note on M. Dubois' account of pithecanthropoid remains recently found in Java. The remains are a skull, a third molar tooth, and a left femur. They were found in a bank of a river in Java, at some distance from each other, and at different times. M. Dubois supposed that he had established the existence of a connecting link between the ape and man, and he named it the "erect ape man," in recognition of the differences from man and the ape. Sir W. Turner remarked that it was not at all certain that the three bones belonged to the same creature. A comparison of the skull with several specimens of the skulls of aboriginals, left him unconvinced that it might not have belonged to a human being. The features of the femur could all be made out in a large collection of human thigh bones, and the tooth had quite as much resemblance to the tooth of a human being as to the tooth of an ape. He considered that the remains were of a low human type.

February 18.—The Hon. Lord M'Laren, Vice-President, in the chair.—Prof. Chrystal discussed a theorem regarding the equivalence of systems of ordinary linear differential equations with constant coefficients, and its application to the theory of such systems.—Dr. C. G. Knott communicated a note on volume-changes in iron and nickel tubes when magnetised. He dealt specially with the effects which are caused when the tubes are closed by a non-magnetic cap instead of a cap of the same metal as the tubes themselves.—Dr. W. Peddie compared the case of yellow-blue blindness, described by him some weeks ago, with the case recently described by v. Vintschgan and Hering. In the present case, unlike the latter, the whole range of the spectrum is visible. So far as the tests have yet been carried out, the presence of red seems to be very easily recognised, but all other colours seem to be nearly, or entirely, grey. Only one neutral point (near D, in the yellow part of the spectrum) seems to exist.

March 4.—Sir Douglas Maclagan, President, in the chair.—At the request of the Council of the Society, Dr. Munro gave an address on lake dwelling research. Whatever was the object of these dwellings, or the causes of their development, it is certain that they were for centuries the characteristic dwellings of the early tribes of Central Europe. Research on the subject began with the discovery of remains in a bog in Ireland, more than half a century ago. Another discovery was afterwards made in Switzerland, and gave new significance to the Irish discovery. Dr. Munro sketched the results of the investigations made in Switzerland and in other parts of Europe, especially Italy. Perhaps no part of Europe is more prolific in remains than the valley of the Po. The first great discovery made in Scotland was in a loch in Wig'ownshire. When the loch was drained, several artificial islands were found, and evidences of early Scottish civilisation, previously unknown, were discovered. Among the articles found were canoes and Roman bronze dishes. Subsequent Scottish discoveries were described, and then the recent discoveries in Bosnia were dealt with. The coincidence of the style of art in the ornaments recently found at Glastonbury with that of the North German articles is peculiarly significant.

**Scottish Meteorological Society, March 27.**—Prof. Copeland, Astronomer Royal for Scotland, in the chair.—Mr. R. C. Mossman gave a paper on "The Frost of 1895," in which he pointed out that the severe frost began on December 28, and ended about February 20, covering a period of fifty-four days. During this time the average temperature of the British Isles as a whole was 8 below normal, the greatest deficiency being in the central highlands of Scotland and the midland districts of England. At the same time barometric pressure was highest in Scandinavia, Lapland, and West of Russia, and lowest about Spain; an almost exact reversal of the normal

winter distribution—thus cold, dry, and therefore heavy, air was drawn from the north east over the British Isles, not only lowering the air temperature directly, but clearing the sky of the usual winter cloud layer, and thus allowing free radiation at night, with consequent low night temperatures in valleys where the chilled air can accumulate and lie stagnant. Places thus spared recorded temperatures below zero Fahrenheit, the lowest being  $-17^{\circ}$  at Braemar, and  $-11^{\circ}$  at Drumlanrig. At western sea-coast places the frost seldom lasted for more than twenty-four hours without a break; while at inland stations, such as Kingussie and Braemar, the temperature never rose to the freezing point for fifteen consecutive days in February. No very low temperatures were recorded on Ben Nevis, the lowest being  $2^{\circ}$  above zero. On February 18, 19, and 20 the temperature on Ben Nevis averaged  $18^{\circ}$  higher than that at Fort William 4400 feet below it, showing that the summit was in the down draught of the anticyclone then lying over Scotland; while at sea level the warmth and dryness of this upper current was not felt. The cold extended all over Europe, including the South of Spain and the Riviera, but scarcely touched North Africa. Though snow fell in Tunis, Algeria was beyond the cold area, the winds there being mostly westerly. To the north Iceland was the only part of Europe outside the influence of the north-east winds, and the winter there has been mild and open.—Mr. A. G. Herbertson presented an interim report on hygrometric work at Ben Nevis. He also gave an account of the Meteorological Observatory at Montpellier, France, describing many of the instruments employed there, and also pointing out the excellent results got from regular phenological observations.—Mr. Mossman gave some notes on "Auroras in the North-east of Scotland 1773 to 1894," mainly taken from data at Gordon Castle, Berffshire, and Inverness. The average number of auroras in this district for the 122 years is seven per annum, but the numbers vary from fifty cases in 1870 to none at all in sixteen years of the record. An intimate connection was shown between sun-spots and auroras; maximum sun-spot periods being the time when auroras were frequent and brilliant, while with the absence of sun-spots there were few or none. No aurora was observed in any year between May 23 and July 22, that is, within four or five weeks of the summer solstice; and the rest of the year shows two maxima, a primary in October and a secondary in February.

## DUBLIN.

Royal Dublin Society, January 23.—Prof. J. Mallet Purser in the chair.—Mr. G. H. Carpenter read a paper on a collection of Lepidoptera from Lokoja, West Africa.—Prof. A. C. Haddon and Mr. J. E. Duerden described some species of Actinaria from Australia and other countries. Ten species, most of them new to science, were described anatomically, and their relation to other members of the group discussed.—Prof. Haddon then gave a paper on a branched worm-tube.—Mr. Duerden followed with some notes on the Hydroids and Polyzoa collected during the Royal Dublin Society's Fishery Survey on the West Coast of Ireland. In this paper the author describes two new species of *Perionima*, and records the occurrence of *Campanulina panicula*, G. O. Sars, for the first time for the British seas.—A voluminous monograph of the marine and freshwater Ostracoda of the North Atlantic and of North-Western Europe (Sections ii.-iv.: Mytiloidea, Cladocopa, and Platycopa) was presented through Prof. A. C. Haddon, by Dr. G. S. Brady and the Rev. A. M. Norman.—At the meeting held February 20, Prof. F. Grenville A. J. Cole in the chair, the following papers were read:—Dr. V. Bail, C.B., F.R.S., made a communication in which he gave an historical account of the gold nuggets found in the county Wicklow.—Prof. W. J. Sollas, F.R.S., read a paper on the comparative systems of Eskers in Ireland. Some beautiful photographs of nebulae and clusters of stars, taken at Duramonagh, Co. Westmeath, were afterwards exhibited by Mr. W. L. Wilson.—At the meeting of March 20, Prof. G. F. Fitzgerald, F.R.S., in the chair, Prof. Sollas read a paper upon the age of the earth.—Prof. James Lyon demonstrated some of the error that arise from the imperfect alignment of the slide table. If the line joining the centres of a slide table is not parallel to the line of motion of the saddle, the path of a cutter fixed in a bar which is rotated between the centres is a plane which is not perpendicular to the direction of motion. Any piece of material being bolted to saddle, and having a hole bored in it by the cutter, would be traversed by a hole the

shape of which would be the projection of the cutting circle on a plane perpendicular to the line of motion of saddle—i.e. an elliptic cylinder would be the result. In the second case, if the poppet-head centre be higher than the fixed centre, and a bar of material be turned between the centres by means of a tool placed in the saddle at a height above the bed about equal to the height of the centre point of the axis of bar above the bed, the result will be a hyperboloid of revolution, since this surface is generated by a straight line (the path of the tool), which is always at a fixed distance from a given axis, is not parallel to it, and does not intersect it.

## PARIS.

Academy of Sciences, April 16.—M. Marey in the chair.—Observations on argon, its fluorescence spectrum, by M. Berthelot. The fluorescence of argon, when charged with benzene vapour and submitted to the action of the silent discharge, is described at length. It is noted that, with the second sample of gas supplied by Prof. Ramsay, and under the conditions of the experiment, the condensation taking place amounted to only 6 to 10 per cent. The author cannot yet explain the different behaviour of the first sample as regards condensation. The following approximate measurements have been made in the spectrum of the fluorescent light: A yellow line at  $\lambda$  579 corresponding to the 575 argon line and 578 of the aurora borealis; a green line at  $\lambda$  547 corresponding with Crookes' group 549 to 555, and perhaps with 557 of the aurora; violet lines 438 and 436 corresponding with Crookes' 433 and 430, and with an important aurora line.—A contribution to the study of variability and capacity of transformation in microbiology, as illustrated by a new variety of anthrax bacillus (*Bacillus anthracis claviformis*), by M. A. Chauveau and M. C. Phisalix. The cultivation obtained from the lymphatic ganglion of a guinea-pig inoculated with attenuated anthrax bacilli consisted of a new type which retained only in a very slight degree the immunising power of the attenuated culture, and no longer had any toxic action beyond that evidenced by a certain rise in temperature of the inoculated subject. The authors believe the *Bacillus anthracis claviformis* to have been certainly derived from virulent *Bacillus anthracis*, but they have not as yet succeeded in bringing back the new variety to the original virulent form.—On the minimum temperatures observed this winter at the summit of Mont Blanc, by M. J. Janssen. A description is given of the mounting of the minimum thermometers. The following minima have been recorded: Mont Brévent  $-26^{\circ}$  C.; Mont Buet  $-33^{\circ}$  C.; Mont Blanc  $-43^{\circ}$  C.—Secular variation and ephemerides of terrestrial magnetism, by General Alexis de Tillot.—Researches on assimilable nitrogen and its transformations in arable land, by M. Pagnoul. The conclusions are drawn that: (1) Abundant rains may carry off from rich soils considerable amounts of nitric nitrogen. (2) Plants growing on the soil are able to prevent this loss. (3) Carbon disulphide arrests the action of the nitric ferment temporarily without killing it. (4) The ammoniacal form is a transition state for organic nitrogen passing into the nitric form; carbon disulphide causes the temporary suspension of the action at this stage. (5) The nitrous form is also an unstable transition state.—On the products of combustion in the electric arc, by M. N. Grehan. Carbon monoxide is produced and, in confined spaces, has produced illness among the workmen employed in electric light stations.—On a question concerning the singular points of algebraical left-handed curves, by M. G. B. Guccia.—Summation of series by means of definite integrals, by M. Petrovitch. On types of groups of substitutions of which the order equals the degree, by M. R. Levavasseur.—On the theory of the system of differential equations, by M. A. J. Stodolkievitz.—On Rondelet's rule for woods, and beams loaded on end, by M. C. Malozes. Rondelet's rule is reduced for wood to a parabolic formula. The curve of limit loads for wood, iron, and brass, between wide limits for the ratio of length of beam to smallest side of transverse section, may be replaced by an arc of a single parabola.—Electric discharge by illumination of substances which are mediocre conductors, by M. Edouard Branly.—On a new method for the measurement of temperatures, by M. Daniel Berthelot. The author proposes the determination of density of gases, by means of their refractive indices as investigated by interference fringes, as a basis for measurement of temperature by a property of gases independent of the envelope.—On the presence of helium in

cléveite, by M. P. F. Clève. A letter in which the author gives the wave-lengths of lines observed in the spectrum of gas obtained from cléveite by heating with potassium bisulphate. The argon lines were not observed.—On the definite combinations of metallic alloys, by M. H. Le Chatelier.—On the aliphatic aldehydes  $C_nH_{2n}O$ , by M. Louis Henry.—Action of halogens on pyrocatechol, by M. H. Cousin.—On the drying property of fatty matters in general and their transformation into elastic products analogous to linoline, by M. Ach. Liviche.—On the composition of some French and foreign oils of the 1874 crop, by M. Bolland.—On the existence of abnormal variations of pressure with the height, a vertical gradient, by M. L. Teisserenc de Bort.

## BERLIN.

**Physiological Society, March 1.**—Prof. du Bois Reymond, President, in the chair.—Dr. Weintraub spoke on the formation of uric acid in man. After the view that the excretion of uric acid is in direct relationship to the proteids of the food had found no support from the experimental side, the theory had been propounded that it is related to the breaking-down of leucocytes. This view was supported by experiments in which the administration of nuclein and xanthin to man had increased the output of uric acid; but, on the other hand, similar experiments on dogs had always yielded negative results. The speaker had experimented on several individuals by substituting thymus gland, rich in nuclein, for the ordinary flesh of the food. The increased excretion of phosphoric acid in the urine showed that the nuclein was largely resorbed, and a constantly large increase in the excretion of uric acid was at the same time observed; the latter disappeared again at once when ordinary flesh was substituted for the thymus gland. Apart from theoretical considerations, it appears that foods rich in nuclein or xanthin should be avoided by patients suffering from excessive formation of uric acid.—The President and Dr. Sklarek made some communications as to argon, recently discovered by Lord Rayleigh and Prof. Ramsay.

**March 15.**—Prof. H. Munk, President, in the chair.—Prof. Liebreich stated that he had found in propyl alcohol a means of separating the cholesterol fats of the skin into those with a high and those with a low melting point. The former exhibit all the characteristics of a wax, and are distinguished by their fixed melting point and by their containing cerotic acid. By extracting human nails and vernix caseosa he had obtained a quantity of cholesterol fats which resembled in all points the cholesterol esters of the skin. He further demonstrated a new chemical reaction which shows the existence of the inert region on the surface of fluids and in capillary tubes in which chemical changes are taking place. It consists in the interaction of chloral hydrate with sodium carbonate and gold chloride, and since all these reagents are solid it is evident that evaporation has no effect on the production of this inert space.—Dr. E. Flatau exhibited two series of nerve preparations, the first consisting of isolated ganglion cells and neurons prepared, by a modification of Golgi's method, partly from the cerebrum and partly from the cerebellum and medulla. The second series, prepared by Marchi's method, was intended to show that in the Wallerian experiment on degeneration, not only does the peripheral stump degenerate after the section, but that the central end also undergoes a secondary degeneration after the break-up of the now inactive ganglion.

**Meteorological Society, March 5.**—Prof. Hellmann, President, in the chair.—After the President had presented the fourth number of the *Reprints* containing the oldest charts of terrestrial magnetism, Dr. Suring gave an account of his observations on the temperature and humidity near a surface of snow. They were made last winter on the Brocken, and this winter in Potsdam, and in the following manner. One thermometer was placed on the snow, and another at the usual height above the surface, either exposed or protected, while at the same time an aspiration-thermometer placed 1 cm. above the snow recorded the temperature of the air. It was found that the size, shape and position of the thermometer lying on the snow, as well as the condition of the snow-surface, &c., had a considerable influence on the temperature recorded by this instrument; the observations had therefore been restricted to a determination of the difference between the temperature of the snow and that of the air above it, in its relations to clouds and to the motion and temperature of the atmosphere. It was found

that the difference was lessened as the sky became more clouded, and when the sky was completely clouded during a fall of snow the temperature of the snow's surface was higher than that of the air. As the temperature of the atmosphere fell, the difference became greater, but was lessened as the motion of the air increased in rapidity. On the whole, the difference was much less on the Brocken than in Potsdam. As to the influence of the snow-surface on the humidity of the air, the speaker had arrived at the result that evaporation from the snow is much more frequent than condensation from the air, but that they are about equal in amount. Prof. Hellmann spoke on the, as yet, uninvestigated velocity of the wind in Berlin, basing his remarks on the indications during ten years of a self-registering anemometer placed at a height of 33.5 metres above the ground in the tower of a house which was originally quite isolated. In later years this house was surrounded by others, but this fact did not in any way affect the working of the anemometer, whose constants were determined at the marine observatory at Hamburg and the central observatory at St. Petersburg. Taking a year as a whole, the maximum rate was observed in March, the minimum in September, and during these months the variations were least. The average for the year is 5.1 metres per second. The above-named periods of maximum and minimum have also been observed at a number of other stations, viz. Paris, Munich, Prague, Vienna, and Cracow. Winds with a velocity less than the average are more frequent than those with one above the average. The frequency of storms, as measured in hours, is greatest in January and March; it increases in October, and sinks rapidly in April. The daily period of greatest velocity lies between one and two o'clock p.m.

**Physical Society, March 8.**—Prof. du Bois Reymond, President, in the chair.—After Prof. Lumpe had referred to the death of their late member, Prof. Worpitzky, Dr. W. Wien spoke on the testing of pyrometers made, according to Le Chatelier, of platinum and platino-rhodium, and connected with an apparatus constructed by Keiser and Schmidt for measuring not only the voltage of the thermo-electric currents, but also the corresponding temperatures. The testing was carried out by determining the melting-points of copper, silver, platinum, palladium, and nickel, which, as fine wires, formed the solder-joints of the platinum and platino-rhodium thermo-elements. These were heated in porcelain tubes, and the current was broken when the respective wires melted. In these experiments platinum must be protected from carbon, copper from oxygen, and palladium from hydrogen. It is impossible here to enter into all the details referred to by the speaker.—Dr. W. von Ujanin gave an account of his experiments on polarisation by oblique radiation from silver, platinum, and black glass. Assuming that the radiation from the heated plates is determined by the refraction of their substance, it was found that the curves thus arrived at corresponded in the case of silver very closely with those obtained experimentally. In the case of platinum, whose surface is very easily altered by heating, the experimental values were always less than those required by theory; in the case of black glass the correspondence of the values was greater, but not so complete as in the case of silver.—Dr. Raps introduced an improvement in his automatic air-pump, designed to facilitate the filling and emptying of the mercury, and at the same time to protect the pump from the consequent risk of breakage. The result was arrived at by means of a chamber for the expansion of air.—Prof. Vogel demonstrated the experiment, already described in NATURE, whereby a half black and half white disc with black patches on it produces different colours, when rotated at a moderate speed, according to the direction of the rotation.

**March 22.**—Prof. Planck, President, in the chair.—Dr. Rubens exhibited several galvanometers, and explained in detail the arrangement and advantages of one he had constructed for the measurement of reversing currents, but which can also be readily adapted for currents in one direction.—Dr. Raps spoke on a new regulator for synchronous motion, especially as required in telegraphy, explaining its principle and construction on a model.

## AMSTERDAM.

**Royal Academy of Sciences, December 29, 1894.**—Prof. van de Sande Bakhuyzen in the chair.—Mr. MacGillivray communicated the results of an investigation made by Mr. D. MacGillivray in the Boerhaave Laboratory at Leyden, and which proved that the germs of tuberculosis are not destitute of the power of locomotion, but possess this power, if the conditions of life are favourable.

February 23, 1895.—Prof. Haeckel brought forward a new hypothesis to explain the origin of the amnion. Birds and reptiles have been looked upon as possessing the normal type of amniogenesis from which that of the Mammalia had to be further derived. The primitive Insectivores offer far better starting points. In the development of the hedgehog's amnion, another path is found along which it is easy to connect both the higher Mammalia and the Sauropsida. The hedgehog allows a comparison to be made between the trophoblast with the outer layer of the amphibian ectoderm. Thus it would be possible to trace the first origin of the amnion in the Anannia.—A paper containing full particulars, and accompanied by several plates, was presented for publication in the Academy's *Verhandlungen*, under the title: "Ueber die Phylogenese der Amnions und die Bedeutung des Trophoblastes."—Mr. Suringar read a paper on "family relations in the vegetable kingdom," as set forth in a sketch in the form of a genealogical tree, designed by the author to illustrate his University lectures.—Mr. Franchimont presented, on behalf of Dr. P. van Kœmburch, two papers. 1. On some nitro derivatives of dimethylaniline. By nitration of dimethylaniline in a great quantity of sulphuric acid, as well as by treating metanitrodimethylaniline with diluted nitric acid, two dinitro derivatives were obtained: a yellow one fusing at 170°, and a red one fusing at 112°. In the yellow one there is a nitro group that may easily be substituted. By further nitration it yields two trinitro derivatives—a yellow one melting at 154° and an orange-coloured one melting at 106°. The red dinitro derivative yields only the orange-coloured trinitro derivative. All of them are finally converted into the same tetranitrophenylmonomethylamine, viz.:



From their relations or properties the following structure is deduced:

*Trinitro-Dimethylaniline.*



*Dinitro-Dimethylaniline.*



On addition products of symmetrical trinitrobenzol. Hepp has found that with aromatic amines S. trinitro-benzol yielded coloured addition products. With brucine, Dr. van Kœmburch arrived at the same result: it formed brownish red needles fusing at 158°; strychnine did not do so under the same circumstances. With trinitro-benzol, indol yielded gold-coloured needles melting at 187°, skatol, orange-coloured ones melting at 183°, and pyrrol, gold-coloured ones melting at 95°; the last-mentioned gave off the pyrrol to the air in a few hours (at 25°). All these compounds consisted of one molecule to one molecule of trinitrobenzol. Pyridine and quinoline did not form such compounds; the former caused trinitrobenzol to crystallise in large crystals. Piperidine, nicotine and phenylazine gave rise to red tints, but crystallised compounds could not be obtained. With other nitro compounds, too, as:  $C_6H_4NMe_2 \cdot NH_2 \cdot NO_2$  (1, 3; 4), and  $C_6H_3NMe_2 \cdot NHMe \cdot NO_2$  (1, 3; 4), trinitrobenzol yielded crimson products, melting respectively at 130° and 144°, and being composed of a molecule of each of the constituents.

March 30.—Prof. Van der Sande Bakhuizen in the chair.—The Bakhuysen-Erbeboom has, in conjunction with Dr. Hepp, investigated the behaviour of hydrogen to palladium, from 0 to 100°, and from 0 to 6 atm. pressure. It is shown that the observations that, contrary to the opinion of Dr. Hepp and Haeckel, there exists no such compound as Hæmæm, can the phenomena observed be explained by the existence of two solid solutions. The gas is absorbed gradually, as if there exists but one solid solution. However, at low temperatures a period in the absorption curve rises much more rapidly with the external pressure than after a while. This behaviour is characteristic of gases near their critical

GÖTTINGEN.

Royal Society of Sciences.—In the *Nachrichten*, part 1, for 1895, appear the following contributions in the department of mathematics and physics:—

December 1894.—I. R. Schütz: Complete and general solution of a fundamental problem in the theory of the potential.

Robert Fricke: On the theory of ternary quadratic forms with integral complex coefficients.—J. Orth: On bacterial disorders of excretion in the renal medulla.

January 1895.—I. R. Schütz: Extension of Maxwell's law of the distribution of velocities, deduced from the principle of the minimum path.—E. Ehlers: On the viscera of *Lepidosiren*.

—Ludwig Kumbler: Sketch of a natural system of classification for the *Thalamophora*.—Heinmann Wagner: The area of the land surfaces of the earth according to zones. R. Dedekind: On the basis of the theory of ideals.—Heinrich Burkhardt: Contributions to researches on the foundations of geometry.—Franz Meyer: On the structure of the discriminants and resultants of binary forms.—Wilhelm Hallwachs: On an aperiodic amagnetic quadrant-electrometer, free from residual action.

BOOKS, PAMPHLETS, and SERIALS RECEIVED.

BOOKS.—Royal University of Ireland, Calendar 1895 (Dublin, Thom).—Société d'Encouragement pour l'Industrie Nationale, Annuaire 1895 (Paris).—Land-Birds and Game-Birds of New England; H. D. Minor (Boston, Houghton).—The Moon; T. G. Elger (Philip).—R. Bradshaw's Bathing Places and Climatic Health Resorts (K. Paul).—Soziale Evolution; B. Kidd, aus dem Englischen Übersetzt von E. Pfeleiderer (Jena, Fischer).—Motive Powers and their Practical Selection; R. Bolton (Loogmans).

PAMPHLETS.—Indexes to the Literatures of Cerium and Lanthanum; Dr. W. H. Mazee (Washington).—Reports of Observations and Experiments in the Practical Work of the Division of Entomology, U.S. Department of Agriculture (Washington).

SERIALS.—Journal of Anatomy and Physiology, April (Griffin).—Royal Natural History, Part 12 (Warne).—American Naturalist, April (Philadelphia).—Insect Life, Vol. vi, No. 5; Vol. vii, Nos. 1-4 (Washington).—Ergebnisse der Meteorologischen Beobachtungen, Jahrg. xvi. (Hamburg).

CONTENTS

PAGE

Controversial Geology. By Prof. John W. Judd, F.R.S. . . . . .	601
Popular Weather Forecasts . . . . .	602
The Mycetozoa . . . . .	603
A New Work on Dyeing. By Walter M. Gardner. . . . .	604
Our Book Shelf:—	
"The Fauna of British India, including Ceylon and Burma."—W. F. Kirby . . . . .	605
Letters to the Editor:—	
The Origin of the Cultivated Cineraria.—W. Bateson, F.R.S. . . . .	605
The Age of the Earth.—Dr. Alfred R. Wallace, F.R.S.; C. Davison . . . . .	607
The Burmese Chipped Flints, Pliocene not Miocene. Dr. W. T. Blanford, F.R.S. . . . .	608
The Mandrake.—Kumagusu Minakata . . . . .	608
A Claim for Priority.—Alex. E. Outerbridge . . . . .	608
An Improved Method for the Microscopic Investigation of Crystals. By A. E. Tutton . . . . .	608
Microbes and Metals. By Mrs. Percy Frankland . . . . .	611
Professor James Dwight Dana . . . . .	611
Notes . . . . .	612
Our Astronomical Column:—	
The Variable Star Z Herculis . . . . .	616
The Diameter of Neptune . . . . .	617
Induced Magnetism in Volcanic Rocks . . . . .	617
The Freezing-Point of Dilute Solutions. By J. W. Rodger . . . . .	617
The Examination Curve. (With Diagrams.) By Prof. C. Lloyd Morgan . . . . .	617
University and Educational Intelligence . . . . .	619
Scientific Serials . . . . .	619
Societies and Academies . . . . .	620
Books, Pamphlets, and Serials Received . . . . .	624



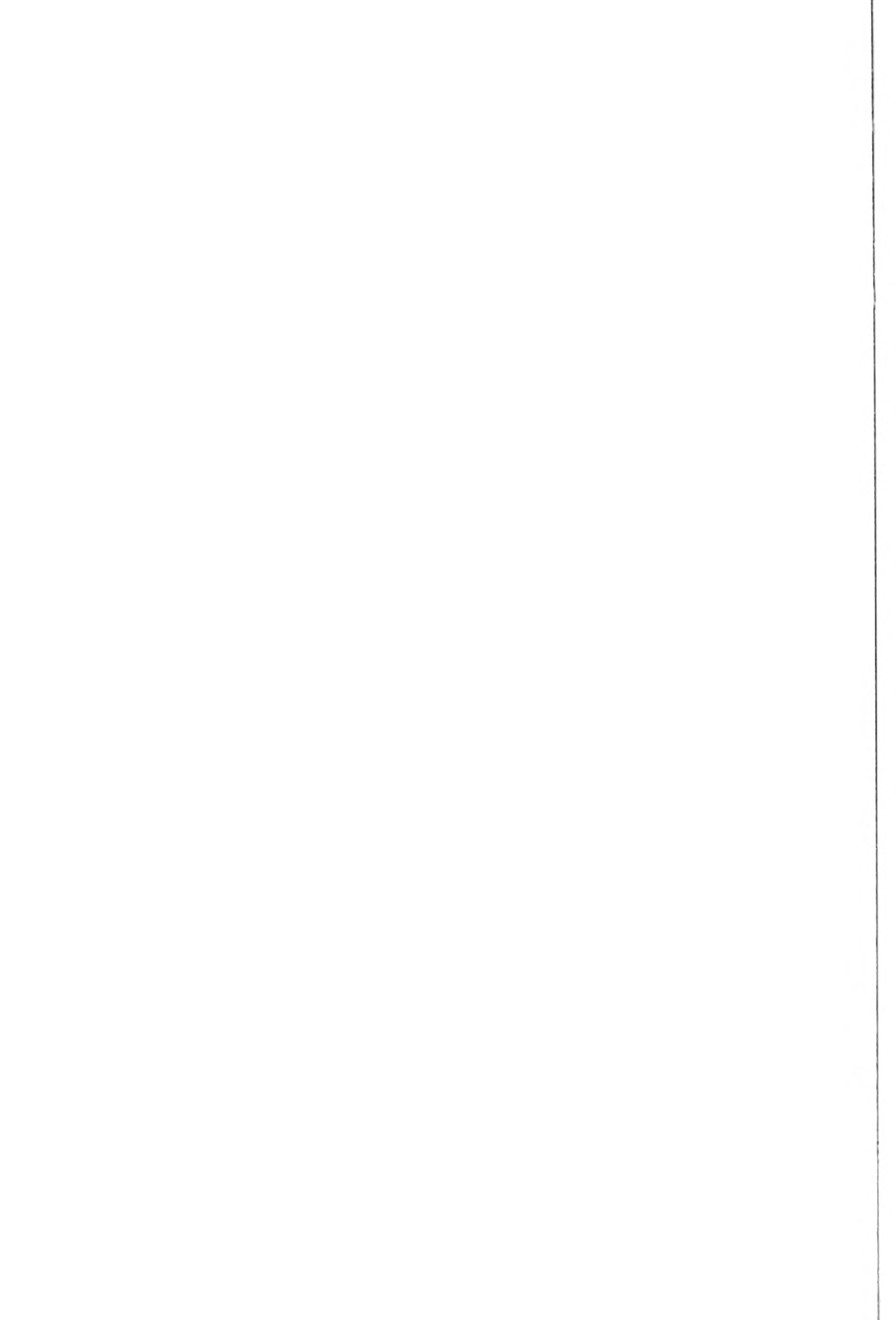





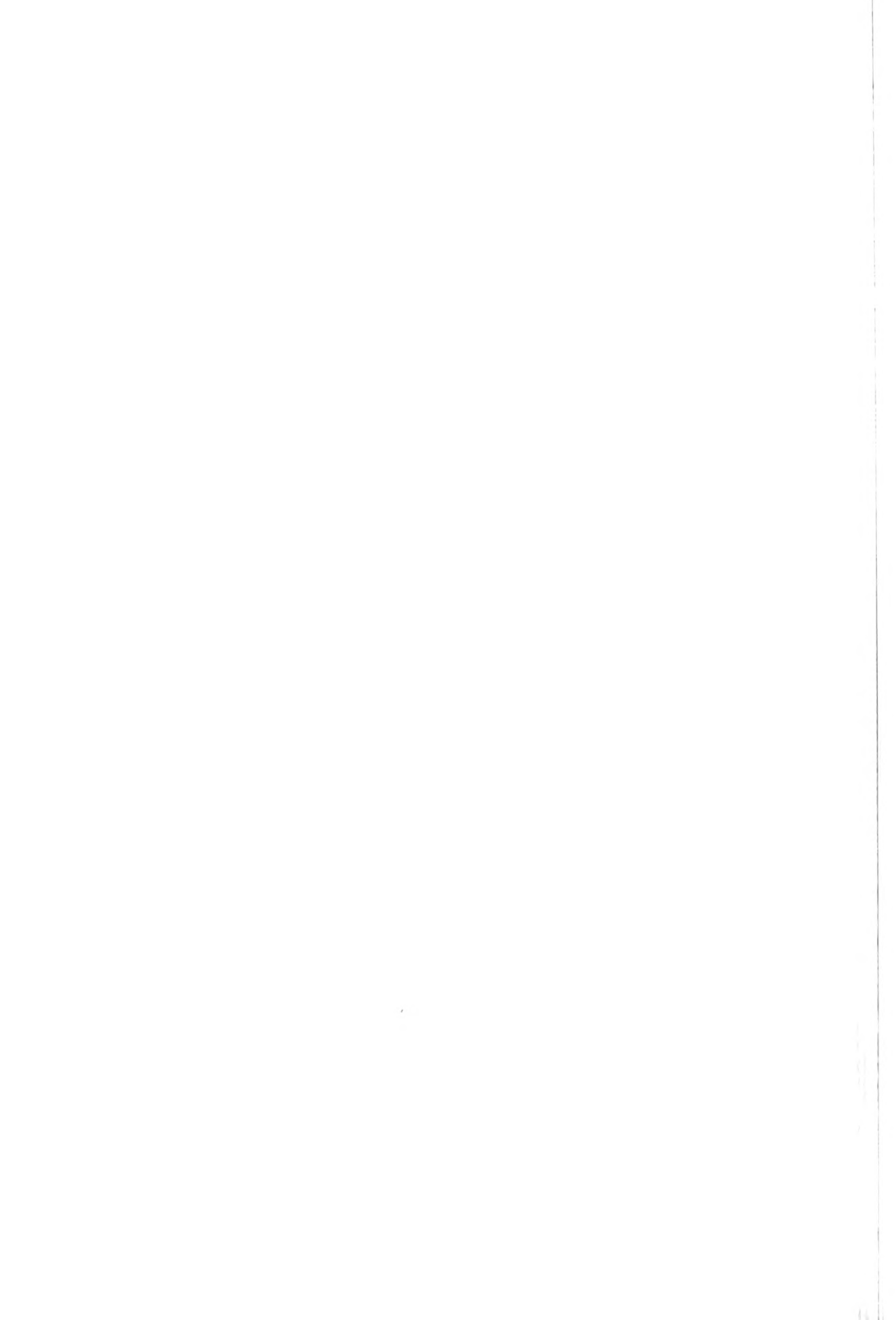

Q Nature  
1  
N2  
v.51  
cop.2

PLEASE DO NOT REMOVE  
CARDS OR SLIPS FROM THIS POCKET

---

UNIVERSITY OF TORONTO LIBRARY

---

1  
287/5 w

271/2  
44/52 10 7/6 17 3/4 .93, 200

