

**CONTENTS**

**A. Byron Leonard**

A New *Valvata* from the Pleistocene of Southern Illinois .....1

**William G. Lyons**

New Turridae (Gastropoda: Toxoglossa) from South Florida and the Eastern Gulf of Mexico .....3

**Frasier O. Bingham**

Several Aspects of the Reproductive Biology of *Littorina irrorata* (Gastropoda) .....8

**David Nicol**

Geologic History of Deposit-feeding Pelecypods .....11

**Leslie Hubricht**

Two New American Pulmonata: *Paravitrea seradens* and *Philomycus sellatus* .....16

**Dorothy E. Beetle**

A Note on Land Snails Associated with Kudzu Vine .....18

**William F. Gale**

Seasonal Variability in Calyculism in *Sphaerium transversum* (Say) .....20

**SHORT PAPERS**

**Patrick V. Kirch**

Subfossil Non-marine Gastropods from Molokai, Hawaiian Islands .....23

**Jon-Arne Sneli**

*Odostomia turrita* Found on *Homarus gammarus* .....23

**James X. Corgan**

Pyramidellid Genera of Pilsbry .....24

**Morris K. Jacobson**

Observations on the Siphonal Behavior of Young Surf Clams, *Spisula solidissima* .....25

**Book Reviews** .....10, 19

**Dates of Publication of the Nautilus, vol. 85** .....26

YHE/NAUTICS

677 10/11 THE GILBR  
BIND IN ALL FRONT AND  
BACK COVERS

TITLE

LIBRARY  
MARINE BIOLOGICAL  
LABORATORY  
Woods Hole, Mass.  
02543

SPECIAL INSTRUCTIONS

PAGE, COL.  
OR ENT #

86-87

VOL.

MOS.

1972-1973

YEAR

1972-1973

F. J. Barnard & Co., Inc. 101 Mystic Ave., Medford, Massachusetts 02155

F. J. Barnard & Co., Inc. 101 Mystic Ave. Medford, Massachusetts 02155



A NEW *VALVATA* FROM THE PLEISTOCENE OF SOUTHERN ILLINOIS

A. Byron Leonard

Division of Biological Sciences  
 The University of Kansas  
 Lawrence, Kansas 66044

## ABSTRACT

*Valvata salina* Leonard (*Prosobranchia: Valvatidae*), a new Pleistocene, Wisconsinan Stage species, is described from the Saline River banks near Equality, Gallatin Co., Illinois. It differs from *V. tricarinata* (Say) in being more planoid, having a low spire and a proportionately larger umbilicus.

The Saline River and its tributaries comprise a drainage system of limited extent in southeastern Illinois; the river arises no farther north than Hamilton County, and enters the Ohio River in northeastern Hardin County, an air-line distance of little more than 60 miles. Especially in Saline and Gallatin counties, the Saline River and its immediate

tributaries are entrenched in sediments of late Pleistocene Lake Saline (Willman and Frye, 1970, Fig. 9, p. 34); artificial deepening, straightening and cleaning of the channel by heavy earthmoving equipment has produced many clean exposures of the ancient lake sediments up to heights of 35 or more feet at low water stages of the river, although the

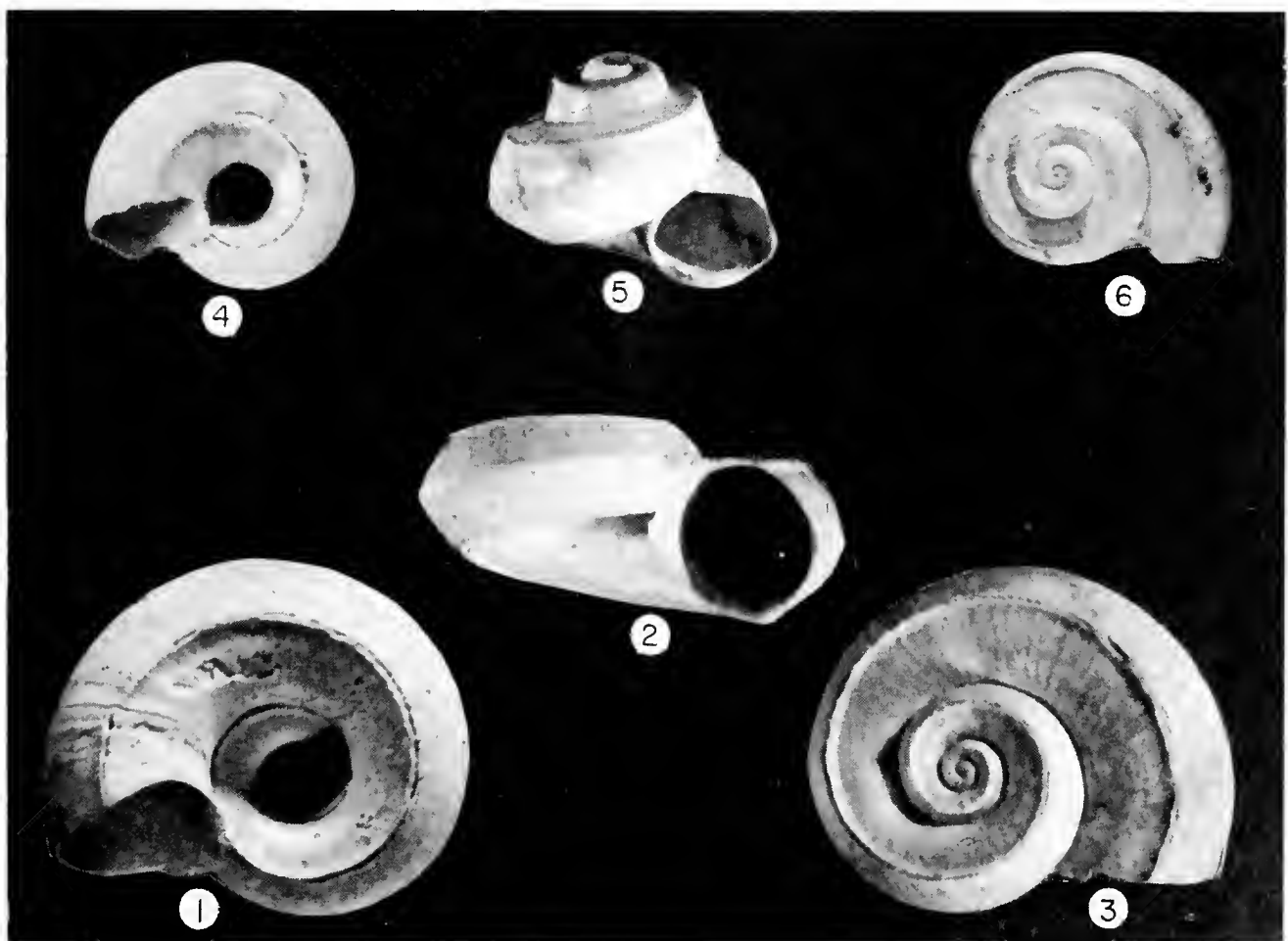

FIG. 1, 2, 3: umbilical, apertural and spiral views of holotype of *Valvata salina*, n. sp. Corresponding views of an associated example of *V. tricarinata* are shown in figures 4, 5, and 6. All figures approximately x 6.

total thickness of the lake beds ranges upward to approximately 150 feet. In the course of studying the molluscan faunas in the fossiliferous clays and silts thus made available, an hitherto unknown member of *Valvata*, a genus of branchiate gastropods, was discovered. Inasmuch as the shells do not intergrade in their distinguishing characters with those of *Valvata tricarinata* (Say) with which they occur, the shells are described as a new species.

*Valvata salina* n. sp.

Figs. 1, 2, 3

*Diagnosis:* Shells possessing the general characteristics of the genus *Valvata*, and resembling in many respects *Valvata tricarinata* (Say) from which it differs, however, in the following important features: consistently greater size; more planoid form; relatively larger umbilical opening; and lack of spiral sculpture.

*Description of holotypes:* Shell forming a helicoid spiral, whorls  $3\frac{3}{4}$  in number; spire depressed below general upper surface; nucleus of  $1\frac{1}{2}$  rounded whorls bearing granular sculpture; remaining whorls increasing rapidly and uniformly in diameter toward the aperture, where the last whorl descends slightly; whorls robust, tricarinate as in typical *V. tricarinata*, except that the peripheral carina is reduced to nothing more than a distinct angulation, and bearing obvious but not conspicuous diagonally transverse striations; spiral sculpture lacking on the whorls; aperture round, entire, and cemented to the penultimate whorls below the angle of the peripheral carina; operculum not known; umbilicus relatively broad, narrowing above, but exposing all the whorls to the nucleus. Measurements: greater diameter of shell, 6.9 mm; lesser diameter, 5.5 mm; height of shell, 2.8 mm; diameter of umbilicus, 2.1 mm; diameter of aperture, 1.6 mm.

*Type locality:* Equality Northeast Section, in the NW  $\frac{1}{4}$ , NE  $\frac{1}{4}$ , NW  $\frac{1}{4}$  sec. 16, T 9 S, R 8 E, Gallatin County, Illinois. The fossiliferous exposure is in the

right bank of the Saline River, about a mile northeast of the village of Equality.

*Geological horizon:* Equality Formation (Willman and Frye, 1970, p. 72), Woodfordian substage of the Wisconsinan Stage of the Pleistocene Series.

*Types:* The holotype, and paratypes from the type locality and from two other localities exposed in Lake Saline sediments, are on deposit in the paleontological collections of the Illinois State Geological Survey.

*Comparisons:* At each of the three localities from which *Valvata salina* was recovered, it occurred with *V. tricarinata*, as well as with about 20 other molluscan species, several kinds of ostracods, seeds of vascular plants and nucules of *Chara* and *Nitella*. The greater diameter of the shells of *V. salina* varies between 6.0 and 7.5 mm, while that of the associated shells of *V. tricarinata* ranges from 4.6 mm to 5.0 mm. The planoid form of *V. salina* is exemplified by the relation between greater diameter and the height of the shells; the height compares only 40 to 45 per cent of the greater diameter, while in *V. tricarinata* from the same deposits the corresponding range is between 75 and 82 per cent. In shells of *V. salina*, the diameter of the umbilicus comprises from 31 to 34 per cent of the greater diameter of the shells, while in *V. tricarinata* the diameter of the umbilicus represents only 17 to 19 per cent of the greater diameter. These data confirm the earlier statement that *Valvata salina* is not only consistently larger than examples of *V. tricarinata* which occur with it, but also that it also differs from the latter in being much more planoid, and in having a relatively broader umbilicus.

#### LITERATURE CITED

- Willman, H. B. and J. C. Frye 1970. Pleistocene stratigraphy of Illinois. Illinois State Geol. Surv. Bull. 94. 204 pp. 14 figs. 7 tables. 3 pls. (in pocket).

## NEW TURRIDAE (GASTROPODA: TOXOGLOSSA) FROM SOUTH FLORIDA AND THE EASTERN GULF OF MEXICO

William G. Lyons

Florida Department of Natural Resources  
Marine Research Laboratory<sup>1</sup>  
St. Petersburg, Florida 33731

### ABSTRACT

*Three new species, Cerodrillia girardi, Brachyocythara barbarae, and Granoturris presleyi are described primarily from collections taken in the eastern Gulf of Mexico, and are compared with other related species. Daphnella margaretae is described from south Florida. Daphnella retifera Dall, D. margaretae, and D. bartschi Dall, a closely related species from the tropical eastern Pacific, are assigned to the subgenus Paradaphne Laseron, previously known only from the Indo-Pacific.*

Several undescribed turrids were found during examination of mollusks collected in Project Hourglass, a systematic benthic sampling program conducted in the eastern Gulf of Mexico by the Florida Department of Natural Resources Marine Research Laboratory (Lyons, 1968; Joyce & Williams, 1969). New species of *Cerodrillia*, *Brachyocythara*, and *Granoturris* from these collections are described herein. A previously unknown species of *Daphnella* (*Paradaphne*) from south Florida is also described.

Collections of Recent Turridae of the Academy of Natural Sciences of Philadelphia, Pennsylvania (ANSP), the Museum of Comparative Zoology, Cambridge, Massachusetts (MCZ), and the National Museum of Natural History, Smithsonian Institution, Washington, D. C. (USNM) were examined during this investigation. Additional specimens for study were provided by Mrs. Margaret Kennedy, Delray Beach, Florida, Dr. James H. McLean, Los Angeles County Museum of Natural History (LACM), Los Angeles, California, Mrs. Virginia O. Maes, ANSP, and Mr. and Mrs. Daniel Steger, Tampa, Florida.

*Type depositories:* Holotypes of all species described are in the collection of the National Museum of Natural History. Paratypes, deposited in various other museums when sufficient material was available, are listed in material of each species examined. DMNH refers to the Delaware Museum of Natural History.

### GENUS *Cerodrillia* Bartsch & Rehder, 1939

#### *Cerodrillia girardi* new species

FIGS. 1, 2

*Description:* Shell with about 7½ whorls, small, to about 12.8 mm total length, solid, turreted, subglobose; color uniform waxy amber. Protoconch of 2 smooth, globose whorls passing without interruption into post-nuclear whorls. Post-nuclear whorls 5½, each with 7 or 8 strong, retractively curved, somewhat sigmoid ribs, broadest at rounded periphery. Intercostal spaces broad, smooth except for microscopic incremental lines and extremely faint spiral striation. Base short, marked with 7-9 spiral lines which increase in strength anteriorly. Aperture sub-oval, broadest near middle. Columella nearly straight; inner lip moderately wide, distinct. Outer lip thin, backed by a thickened varix, irregularly curved, with a shallow but distinct stromboid notch. Sinus deep, broad, bordered posteriorly by a thick callus. Canal very short, broad, shallow.

*Material examined:* *Holotype:* USNM 707001. Length 8.8 mm, width 3.8 mm. Off Egmont Key, Florida, Hourglass station D, 27°37'N, 83°58'W, 55 m; August 11, 1966. --Single adult paratypes, all from station D, deposited at ANSP, LACM, MCZ, USNM, American Museum of Natural History, New York (AMNH), Delaware Museum of Natural History, Greenville, Delaware (DMNH) and Florida Depart-

<sup>1</sup>Contribution no. 205

ment of Natural Resources Marine Research Laboratory, St. Petersburg, Florida (FSBC I).

*Remarks:* *Cerodrillia girardi* sp. nov. is more globose than *C. clappi* Bartsch and Rehder, *C. perryae* Bartsch and Rehder, or *C. thea* (Dall), though the nucleus resembles that of *C. thea*. In general outline it is nearest *C. bealiana* Schwengel & McGinty, with which it is often collected, but the latter is a smaller species with a much smaller and more pointed nucleus.

*Cerodrillia girardi* was never collected in large numbers during Project Hourglass, but low numbers were taken frequently at station D. It was collected only occasionally at stations E, L, and M (55 and 73 m stations). Most specimens other than type material were juveniles or dead shells in poor condition. There are specimens in the Steger collection from off the lower Florida Keys in 49-55 m.

The species is named for Capt. Earl Girard, master of the R/V *Herman Cortez* during the Hourglass cruises.

#### GENUS *Brachyocythara* Woodring, 1928

##### *Brachyocythara barbarae* new species

FIGS. 3, 4

*Description:* Shell with about 6 whorls, small, to about 3.5 mm total length, biconic, translucent, with little or no spiral sculpture and strong axial ribs. Protoconch with about 3 whorls, the tip distinctly defined, not immersed in the next whorl; first two nuclear whorls smooth, rapidly enlarging, somewhat compressed axially; third whorl initially with fine, curved, closely-spaced axial riblets which increase in strength as they progress downward. Post-nuclear whorls generally smooth, but faint spiral striae sometimes present; axial ribs strong, sinuose, sharply angled at the periphery, giving the whorls an angular appearance; 8-9 such ribs on the body whorl. A faint brown spiral band between suture and periphery of spiral whorls; as many as six such bands below periphery on body whorl, final band on the base most broad. Eight or nine unornamented spiral threads on base. Aperture narrow, about 40 per cent total length of shell; outer lip thickened, rounded at shoulder; sinus adjoining suture wide, rounded, very shallow; parietal callus smooth, fairly broad; columella short, truncate.

*Material examined:* *Holotype:* USNM 707003. Length 3.4 mm, width 1.6 mm. Off Egmont Key, Florida, Hourglass station D, 27°37'N, 83°58'W, 55 m; February 28, 1967. --Single adult paratypes, all

from station D, deposited at AMNH, ANSP, DMNH, FSBC, LACM, MCZ, USNM, and the Steger collection.

*Remarks:* *Brachyocythara biconica* (C. B. Adams), the only other Recent western Atlantic species near *B. barbarae* sp. nov., has distinctly beaded spiral cords on the post-nuclear whorls, giving the surface a frosted appearance which immediately separates it from *B. barbarae*. In addition, *B. biconica* possesses more numerous axial ribs (10-12 on body whorl) which are rounded, not angled, at the periphery, and a relatively longer aperture (about 50 per cent total length of shell). The columella of *B. biconica* is straight. The tip of the apex is immersed in the next whorl, giving the nucleus a blunter appearance than that of *B. barbarae*. The lectotype of *B. biconica alba* (C. B. Adams) (Clench and Turner, 1950; pl. 32, fig. 1) has the frosted sculpture of *B. biconica* and is apparently an unusual form of that species.

Bathymetric preferences for *B. biconica* and *B. barbarae* are evident. In Hourglass collections, *B. biconica* was common at 18 and 37 m stations but seldom occurred at greater depths; it occurs in depths as shallow as 1 m in the Florida Keys. *Brachyocythara barbarae* was common at 55 and 73 m Hourglass stations, but was taken only occasionally at the northern 37 m station (C), and was never taken at the comparable southern station (K). There is one large lot in the Steger collection taken southwest of Sombrero Light, Monroe County, Florida, in 55 m. I have not seen *B. barbarae* from shallower than 37 m.

The species is named for Mrs. Barbara Steger in appreciation of her gracious hospitality during my examination of the Steger collection.

#### GENUS *Granoturris* Fargo, 1953

##### *Granoturris presleyi* new species

FIGS. 5, 6

*Description:* Shell with about 7 whorls, small, to about 4.7 mm total length, slender, turreted. Protoconch flesh-colored, prominent, resembling *Miraclathurella*, of about 1½ smooth whorls, tip immersed in following whorl. First ½ post-nuclear whorl strongly keeled at periphery as in *Cryoturris*, with about 9 axial riblets. Subsequent whorls with 11-12 strong axial ribs, sharply angled at submedian periphery. A spiral cord connecting peripheral angles, another somewhat weaker cord midway between periphery and anterior suture. Pre- and post-peripheral sculpture of closely-spaced, frosted

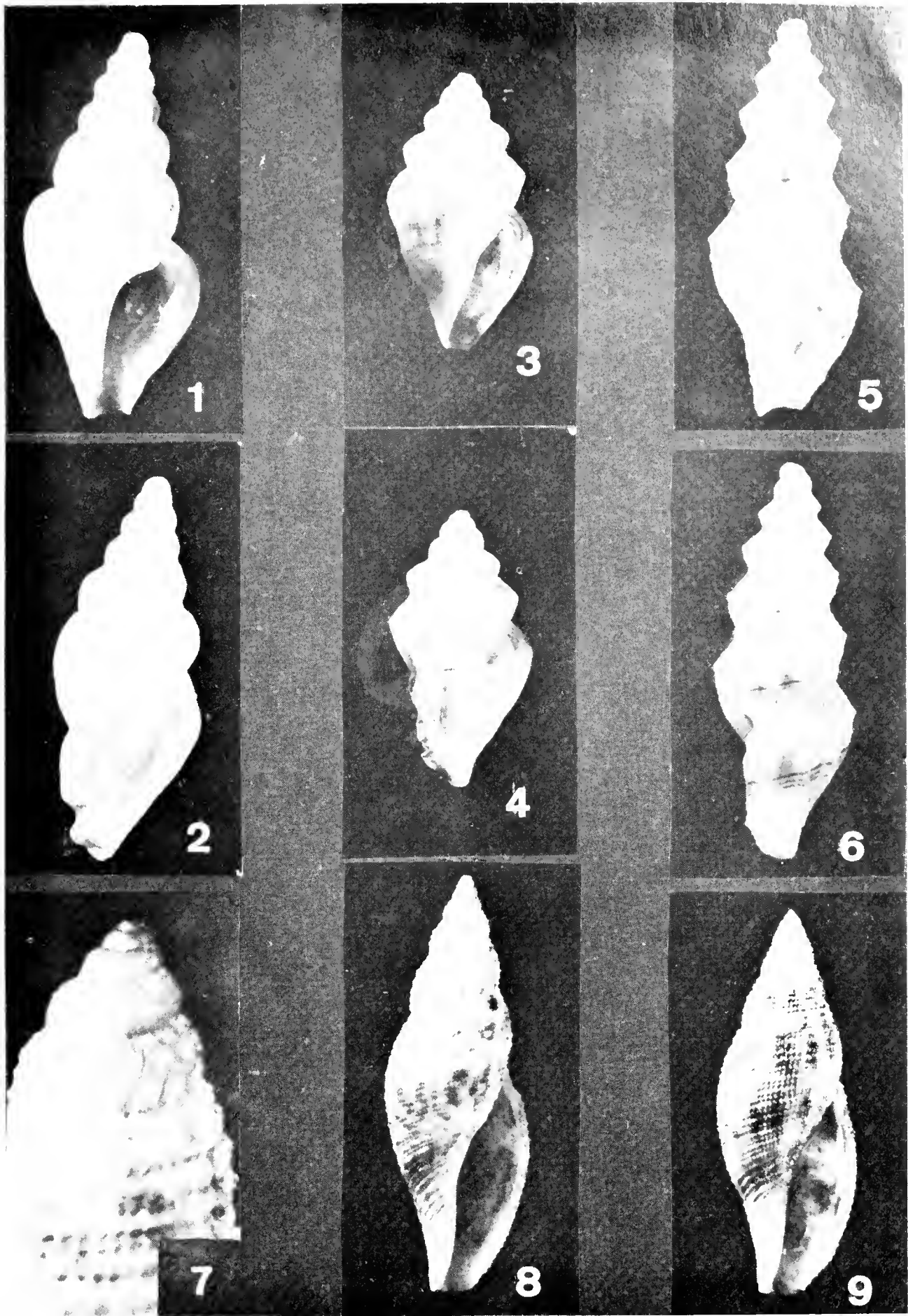

**FIGS. 1, 2** *Cerodrillia girardi* Lyons, *Holotype*, 8.8 mm, USNM 707001;  
**FIGS. 3, 4** *Brachycthyra barbarae* Lyons, *Holotype*, 3.4 mm, USNM 707003;  
**FIGS. 5, 6** *Granoturris presleyi* Lyons, *Holotype*, 4.7 mm, USNM 707005;  
**FIGS. 7, 9** *Daphnella* (*Paradaphne*) *bartschi* Dall, 10.4 mm, LACM collection;  
**FIG. 8** *Daphnella* (*Paradaphne*) *margaretae* Lyons, *Holotype*, 10.7 mm, USNM 707006.

spiral threads. Aperture elongate, subovate. Sinus subsutural, a broad, shallow depression near shoulder. Outer lip thin, unvariced, angled at shoulder. Anterior canal short, moderately broad and deep. Post-nuclear whorls white, with about 5 fine, brown spiral lines on post-peripheral portion, a more prominent, darker brown line immediately posterior to suture; 3 dark brown lines near middle of body whorl, 5 weaker brown lines toward anterior canal.

*Material examined: Holotype:* USNM 707005. Length 4.7 mm, width 1.8 mm. Off Egmont Key, Florida, Hourglass station B, 27°37'N, 83°07'W, 18 m; November 20, 1967. --Three paratypes, all from station B: 1 at ANSP, 2 at FSBC.

*Remarks:* *Granoturris presleyi* sp. nov. is the first known Recent species from the western Atlantic; *G. padolina* Fargo, from the North St. Petersburg Pliocene, differs from the Recent species by possession of fewer axial ribs on whorls, and by its larger size. The shoulders of *G. padolina* are normally convex, according to Fargo; on *G. presleyi*, the shoulders are always quite flat.

The species is named for Mr. Robert F. Presley, ship's biologist of the R/V *Hernan Cortez* during the Hourglass cruises.

GENUS *Daphnella* Hinds, 1844

SUBGENUS *Paradaphne* Laseron, 1954

*Description:* Shell small, to about 11.3 mm total length, moderately thin, fusiform. Nucleus of 4-6 rounded, diagonally cancellate whorls, protractive threads of cancellation somewhat stronger than retractives on last whorl. Intersection of nuclear and post-nuclear sculpture not sharply defined, protractive nuclear axials overlying for a small distance post-nuclear spirals. Spire and body whorl with many spiral lines crossed by axial threads, beaded at intersections, with or without fine spiral threads in interspaces. Aperture elongate-ovate, widest near middle. Sutural sinus moderately deep, reversed L-shaped, sloping anteriorly. Outer lip simple, curved, tapered anteriorly, slightly thickened within; a very weak notch at intersection with short, shallow, moderately wide anterior canal.

*Remarks:* Powell (1966) dismissed Laseron's *Paradaphne* for lack of characters of differentiation from *Daphnella*. It is evident, however, that there exists a circumtropical group of species, differing markedly from *Daphnella* in nuclear and post-nuclear sculpture. *Daphnella botanica* Hedley, 1918, the type species of *Paradaphne*, belongs to this group, though

it is one of the species nearest in form to *Daphnella* s. s.

*Daphnella tymneiformis*, the type species of *Daphnella*, and closely related species have a smaller, more slender protoconch of 2½-3 whorls, with little variation in the strength of diagonal cancellation of the last whorl. Intersection of nuclear and post-nuclear sculpture is abrupt, without the overlap zone of *Paradaphne*. Size, sculpture, and number of whorls of the protoconch of *Paradaphne* resemble those of *Metuonella* Sorgenfrei, 1958, *Cryptodaphne* Powell, 1942, and *Maoridaphne* Powell, 1942, but these three differ from *Paradaphne* by variously possessing strong axial ribs, markedly different apertures and sinuses, or both. In addition, the outer lip of adult *Daphnella* s. s. is flared anteriorly, not tapered and constricted as in *Paradaphne*. The aperture and outer lip of *Paradaphne* closely resemble those of immature *Daphnella*, but the inner thickening of some specimens indicates that they are mature.

*Eudaphne* Bartsch, 1931 (*non* Reuss, 1922) was proposed to contain *Daphnella allemani* (Bartsch, 1931). The name was later changed by Bartsch (1933) to *Eudaphnella*. Keen (1958) suggested that perhaps *Eudaphne* should be used in a subgeneric sense for *D. allemani* and *D. bartschi* Dall, 1919. However, *D. allemani* has the wide aperture, flared outer lip rounded at the sutural sinus, and extremely short canal of typical *Daphnella* and is so similar in all other respects that subgeneric separation seems unwarranted, as noted by Powell (1966). *Daphnella bartschi* is definitely assignable to *Paradaphne*, as are *D. retifera* Dall, 1889, and a new species herein described.

***Daphnella (Paradaphne) margaretae* new species**

FIG. 8

*Description:* Shell with about 8 whorls, small, to 10.7 mm total length. Nucleus of about 5 rounded, diagonally cancellate whorls, brown except fifth, which has two spiral rows of large, round, white spots best seen on wet specimens. Spire and body whorl sculptured of fairly strong spiral lines crossed by weaker axial threads, strongly beaded at intersections; spiral threads within interspaces nearly obsolete. Aperture slender, elongate; outer lip simple, thickened within; sinus moderately deep, reversed L-shaped. Siphonal canal broad, shallow, brief, but longer than that of most daphnellids. Color cream, with rich brown maculations. Three rows of large, spot-like brown maculations on body whorl at

periphery, middle and posterior portion of base.

*Material examined: Holotype:* USNM 707006. Length 10.7 mm, width 3.8 mm. South of Dry Tortugas, Florida, 24°24'N, 82°58'W, 76-85 m; April 27, 1967; R/V *Hernan Cortez*. --Paratypes: ANSP 324021. Length 5.4 mm, width 2.2 mm. On *Spondylus* collected in 37-55 m off Palm Beach County, Florida, 1970. --FSBC I 7896. Length 4.4 mm, width 2.0 mm. South of Sand Key, Monroe County, Florida, 35-36 m, August 2, 1971; R/V *Hernan Cortez*.

*Remarks:* Radwin (1969: p.233) proposed the term "cognates" to replace "analogues", as the meaning of the former more clearly denotes "related through the same origin" in the immediate biological sense. *Daphnella bartschi* from the eastern Pacific and *D. margaretae* sp. nov. are obvious cognates and have probably evolved since emergence of the Central American isthmus. *D. margaretae* differs from *D. bartschi* (Figs. 7, 9) by possessing stronger spiral lines crossed by weaker axial threads on the spire and body whorl. The overall appearance of *D. bartschi* is of even cancellation, whereas on *D. margaretae* spiral sculpture is the dominant feature. Many fine spiral threads in interspaces between post-nuclear spiral and axial sculpture are clearly defined in *D. bartschi*, but are nearly obsolete in *D. margaretae*. Overall, the shell of *D. margaretae* is more slender than that of *D. bartschi*. The double row of large white spots on the last nuclear whorl and maculations of spire and body whorl are identical on both.

*Daphnella retifera* Dall, 1889, has one more nuclear whorl and a more globose, thinner shell than either of the preceding species. Nuclear size, sculpture of nuclear and post-nuclear whorls, and shape of the aperture and outer lip indicate the relationship of this species to the previous two. Interspaces between axial and spiral sculpture are smooth. Color of the nucleus is brown; post-nuclear whorls are white, with scattered yellow maculations.

*Daphnella (Paradaphne) margaretae* is named for Mrs. Margaret Kennedy, Delray Beach, Florida, who provided one of the paratypes and whose articles on western Atlantic Turridae in *Seafari*, the bulletin of the Palm Beach County Shell Club, have stimulated much interest in this group.

## ACKNOWLEDGEMENTS

I thank Dr. James H. McLean and Mrs. Virginia Maes for critically reading the manuscript and providing additional information. They, Mrs. Margaret Kennedy and Mr. and Mrs. Daniel Steger kindly loaned specimens. The many persons who gave assistance during inspection of collections at the before-mentioned museums are gratefully acknowledged. Special thanks are extended to Mrs. Sally Kaicher who produced the photographs.

## REFERENCES CITED

- Bartsch, P. 1931. Descriptions of new marine mollusks from Panama, with a figure of the genotype of *Engina*. Proc. U. S. Nat. Mus., 79 (2881): 1-10, 1 pl.
- Bartsch, P. 1933. *Eudaphnella*, a new generic name. Nautilus, 47(2): 76-77.
- Clench, W. J. and R. D. Turner. 1950. The western Atlantic marine mollusks described by C. B. Adams. Occ. Papers on Mollusks, 1(15): 233-403.
- Dall, W. H. 1919. Descriptions of new species of mollusks of the family Turritidae from the west coast of America and adjacent regions. Proc. U. S. Nat. Mus., 56(2288): 1-86, 24 pls.
- Fargo, W. G. 1953. The Pliocene Turridae of Saint Petersburg, Florida. In: Olsson, A. A. and A. Harbison, 1953. Pliocene Mollusca of southern Florida. Acad. Nat. Sci. Phila., Monograph 8, Pt. 2: 363-409, pls. 16-24.
- Keen, A. M. 1958. Sea shells of tropical West America; marine mollusks from Lower California to Colombia. i-xi + 624 pp. Stanford Univ. Press, Stanford, Calif.
- Laseron, C. F. 1954. The New South Wales Turridae. Roy. Zool. Soc. N. S. W. Handb., pp. 1-56.
- Lyons, W. G. 1968. Mollusks of Project Hourglass. Am. Malacol. Union Ann. Rpts. for 1968: 34-35.
- Powell, A. W. B. 1966. The molluscan families Speightiidae and Turridae. Bull. Auckland Inst. and Mus., No. 5: 184 pp., 34 pls.
- Radwin, G. E. 1969. A recent molluscan fauna from the Caribbean coast of southeastern Panama. Trans. San Diego Soc. Nat. Hist., 15(14): 229-236.

SEVERAL ASPECTS OF THE REPRODUCTIVE BIOLOGY OF  
*LITTORINA IRRORATA* (GASTROPODA)

Frasier O. Bingham

University of Miami

Rosenstiel School of Marine and Atmospheric Science <sup>1</sup>

10 Rickenbacker Causeway

Miami, Florida 33149

ABSTRACT

*The salt marsh periwinkle, Littorina irrorata, of eastern United States is dioecious. The penis has a gray-brown, wrinkled basal region and a smooth, slender, white distal region with a sperm groove located along the dorsal edge. Copulation, lasting 15 minutes or longer, occurs in the warmer months and while the snails are out of water on marsh grass. Females shed between 43,000 and 85,000 clear, planktonic, disc-shaped capsules, each of which contains one gray egg. Spawning takes place at the air-water interface or just below the surface of the water at a rate of four or five capsules per second for two to four hours.*

INTRODUCTION

The salt marsh periwinkle, *Littorina irrorata* (Say) is common along the northern coast of the Gulf of Mexico and the eastern coast of the United States from central Florida to New York.

The observations reported here were made during a detailed study of the behavior of the species in a salt marsh near Panama City, Florida (30° 14'N, 85° 41'W), during the period January through October, 1969 (Bingham, in press).

THE PENIS

The male copulatory organ was noted to develop when male specimens reached a shell length of approximately six mm. After this size is reached, the separate sexes are easily distinguished by gently lifting the outer shell lip of specimens that are extended and firmly adhering to a substrate, and noting the presence or absence of a penis slightly below and posterior to the right tentacle (Fig. 1).

The penis has been seen to become larger and more pigmented during the breeding season in some species of *Littorina* (e.g. *L. littorea* by Tattersall, 1920; *L. augulifera* by Linderking, 1954) and to show no such seasonal variation in others (e.g. *L. picta* and *L. pintado* by Struhsaker, 1966). No change in size or color was noted in the penis of *L. irrorata* during the period of this study which included the breeding season.

The penis of *L. irrorata* can be divided externally into two regions. The basal region (Fig. 2) is gray-brown and has a wrinkled surface. The distal region is white and has a fairly smooth surface. During repose this region is slightly smaller in diameter and approximately the same length as the basal region. Located near the base of the basal region, so as to be hidden from view when the organ is in its reposed position (Fig. 1), is a light colored, slightly raised area. Similar structures in *L. littorea* were found to be glands and believed by Fretter and Graham (1962) to secrete mucus used for holding the penis in position during copulation. A sperm groove is located along the dorsal edge of the entire length of the organ.

During copulation, the basal region of the penis becomes highly engorged with blood (Fig. 3) while the distal region lengthens and decreases in diameter so as to become thread-like (Fig. 3).

COPULATION

Weekly observations of the snails in the salt marsh were begun on January 4, 1969. Copulation was first noted during the afternoon of May 5 when about 25% of the animals were copulating, either at the air-water interface or on grass shoots and leaves above the water. The female of a copulating pair is always firmly attached to the marsh grass with the foot extended and, in most instances, in a spire-down position. The male secures a firm hold on the female's

<sup>1</sup>Contribution no. 1515.



shell with its extended foot and comes to rest with the right side of its shell lip slightly overlapping the same portion of the female's shell. After the male is in this position, the penis is directed into the mantle cavity of the female and quickly inflates (Figure 4). The length of time spent in copulation in 17 pairs ranged from 24 to 36 minutes. During copulation and for 15 minutes or longer thereafter, no locomotory movements were seen in either sex.

High temperatures may be the stimulus for copulation as suggested by the fact that during the months of May, June and July, copulation was observed on each field trip made in hot, clear weather and no copulation was seen during two field trips taken in cool, overcast weather conditions. In studying this possibility, 150 specimens were collected in the marsh on July 12 and brought to the laboratory. Fifty specimens were placed in each of three shallow pans which contained small amounts of seawater and were covered with wire screens to prevent the snails' escape. One pan was put outside in the sunlight, one pan was left on a table in the laboratory at 21°C, and one was placed in an oven set at 40°C. No copulation occurred in the pan kept in the laboratory. Copulation began in the sunlit pan and in the oven heated pan when a temperature of 35°C was reached in each, and continued in both pans for about two hours even though the pan in the oven was taken out and allowed to cool to room temperature (21°C).

Tattersall (1920) noted that *L. littorea* kept in an aquarium began to copulate soon after a water change. He believed copulation to be induced either by higher levels of dissolved oxygen or a decrease in temperature. Alterations in temperature could also have been involved when Lenderking (1954) observed large numbers of *L. augulifera* copulating soon after heavy rains.

Copulation in *L. irrorata* was not seen in the marsh after September 28, and specimens collected thereafter could not be induced to mate regardless of the temperature at which they were maintained.

#### SPAWNING

Females which mated in the laboratory during the afternoon of May 6 began spawning the next afternoon at 1:10 PM, just 16 minutes after high tide occurred in the area from which they were collected. Specimens taken during the next several months began spawning without regard to daylight or darkness at approximately the same time as the next high tide after copulation.

A few females spawned while completely submerged, but most were positioned at the air-water interface (Fig. 5). Egg cases were continuously expelled at a rate of four or five per second for a period of two to four hours, and formed cloudy paths to the bottom of the animals' containers. Two females were isolated after copulation and their eggs counted using a tally counter, grid slide and a known volume of seawater in which the eggs had been

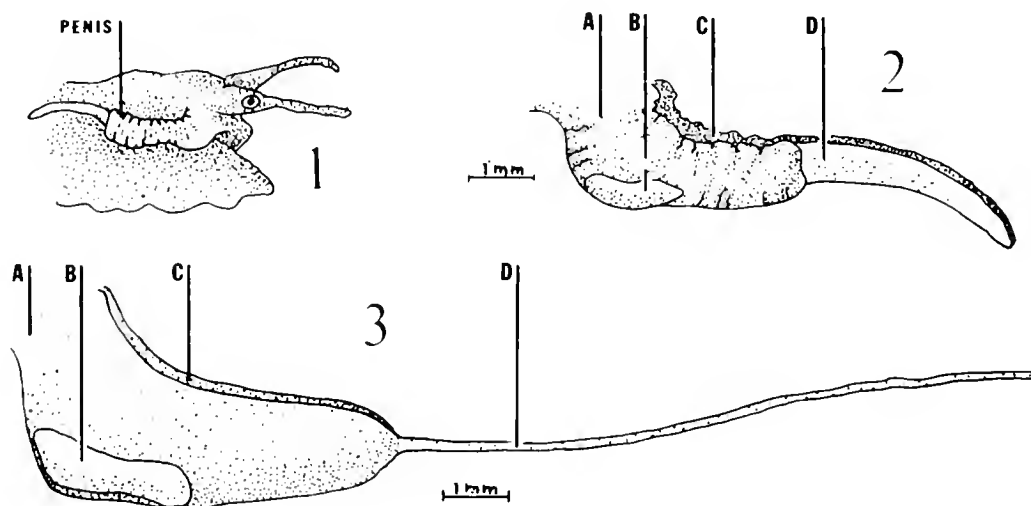

FIG. 1. Repose position of the penis in *L. irrorata*.

FIG. 2. View of side of penis lying next to body. Penis in repose state. A - basal region; B - attachment gland; C - sperm groove; D - distal region.

FIG. 3. Penis engorged and the distal region in an extended state. A - basal region; B - attachment gland; C - sperm groove; D - distal region.

suspended by agitation. One snail laid approximately 43 thousand, and the other 85 thousand eggs.

#### THE EGG AND EGG CAPSULE

• *L. irrorata* lays clear, planktonic, disc-shaped egg capsules which contain one gray egg each (Fig. 6). The capsules measure from 250 to 280  $\mu$  in diameter, and are somewhat negatively buoyant in still seawater of 26‰ salinity.

#### LITERATURE CITED

Bingham, F. O. *In Press*. The influence of environmental stimuli on the direction of movement

of the supralittoral gastropod *Littorina irrorata*. *Bull. Mar. Sci.*

Fretter, V. and A. Graham. 1962. *British Prosobranch Molluscs*. Ray Society, London. 755 p.

Lenderking, R. E. 1954. Some recent observations on the biology of *Littorina angulifera* Lam. of Biscayne and Virginia Keys, Florida. *Bull. Mar. Sci. Gulf and Caribbean* 3: 272-296.

Struhsaker, J. W. 1966. Breeding, spawning, spawning periodicity and early development in the Hawaiian *Littorina*: *L. pintado* (Wood), *L. picta* (Philippi) and *L. scabra* (Linne). *Proc. malac. Soc. Lond.* 37: 137-166.

Tattersall, W. M. 1920. Notes on the breeding habits and life history of the periwinkle. *Sci. Invest. Fish. Br. Ire.* 1: 1-11.

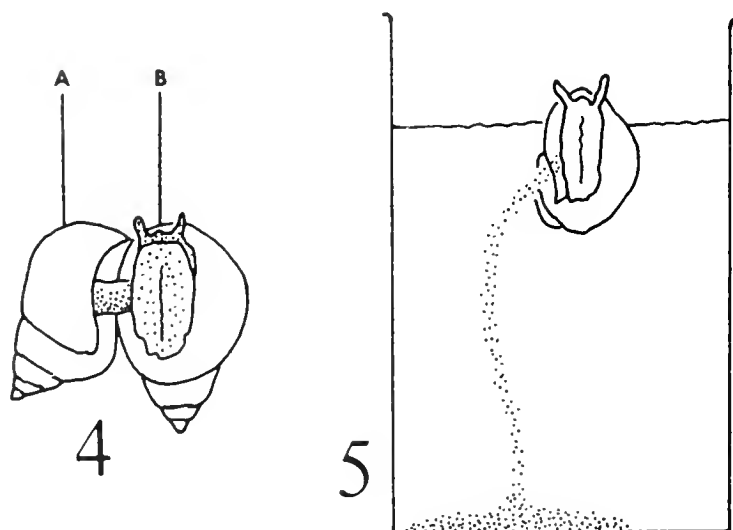

FIG. 4. Simplified drawing of copulating pair of *L. irrorata* as seen through a glass substrate. A - male; B - female.

FIG. 5. Simplified drawing of female *L. irrorata* spawning.

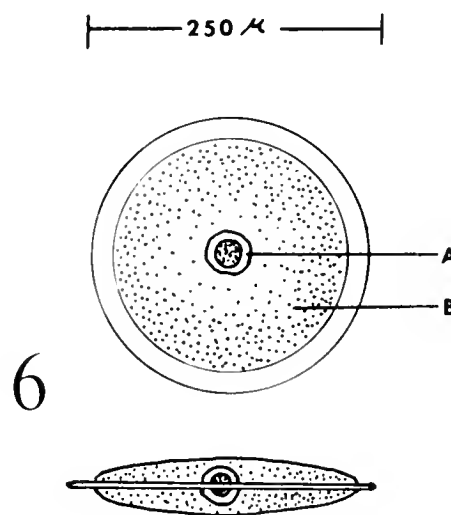

FIG. 6. Egg and egg capsule of *L. irrorata*. A - egg; B - egg capsule.

#### BOOK REVIEW

##### SEA SHELLS COMMON TO NORTH CAROLINA.

By Hugh J. Porter and Jim Tyler. 36 pp., 131 figs., colored cover on paperback. 1971. Free copy obtained by writing: Division of Commercial and Sports Fisheries, Dept. Natural Resources, Morehead City, N. C. 28557.

This is a well-illustrated and accurate guide to 129 marine mollusks of the coast of North Carolina. It is a

paperback booklet designed for seashore visitors to this part of the world. It contains both popular and scientific names, brief descriptions, relative occurrences, and habitats. The species are conveniently arranged in a series of simple keys and illustrated by either drawings or clear photographs. An index and glossary are included.

*R. Tucker Abbott*

*Delaware Museum of Natural History*

## GEOLOGIC HISTORY OF DEPOSIT-FEEDING PELECYPODS

David Nicol

Box 14376, University Station,  
Gainesville, Florida 32601

## ABSTRACT

*All Paleozoic faunas average 10 per cent deposit-feeding pelecypods, with a range from 0 to 15 per cent. The Mesozoic pelecypod faunas average only 8 per cent deposit feeders, with a range from 0 to 18 per cent. Of the Cenozoic faunas excluding the Recent, the average percentage of deposit feeders is 16 per cent, with a range from 11 to 38 per cent. There was a rapid increase in diversity of deposit-feeding pelecypods beginning in the Paleocene. In the shallow-water Recent faunas the average percentage of deposit-feeding pelecypods is 19 per cent, with a range of from 7 to 29 per cent, the Arctic having the highest percentage. Deposit-feeding pelecypods are now at least as diverse as they have ever been in the past. There is a higher percentage of deposit-feeding pelecypods (27 per cent) in silty formations, than in sandy areas (12 per cent) or marl (10 per cent). There appear to be at least 5 variables in the occurrence of deposit-feeding pelecypods – the type of bottom sediment; geographic distribution; water temperature; bathymetric depth and the evolutionary stage of development. The protobranches originated in the Ordovician, whereas the deposit-feeding tellinaceans are a relatively modern group, appearing in the Early Cretaceous.*

Protobranches, which are deposit feeders, are a minor element in most marine pelecypod faunas from Ordovician to Recent. In a sample of 13 Paleozoic faunas, protobranches average 10 per cent of all pelecypod species. This figure is quite consistent in most of the Paleozoic faunas, although in 7 Permian faunas the average is 11 per cent. The highest percentage of all Paleozoic faunas, 15 per cent, is also found in 2 Permian faunas.

The Triassic, Jurassic, and Early Cretaceous (Albian and older) have lower percentages of protobranches than is the average in the Paleozoic. The average percentage for the Triassic and also the Jurassic is 5 per cent and that for the Early Cretaceous is only 4 per cent. The Late Cretaceous faunas have an average of 7 per cent protobranches, but this average is high because of the Kemp Clay of Texas, in which protobranches comprise 16 per cent of the pelecypod species (Stephenson, 1941). It is interesting to note that the Kemp Clay is the youngest Cretaceous formation in Texas and is Late Maastrichtian in age. It is possible that the sudden increase in protobranch species in a Late Cretaceous

fauna is an indication of colder seas at the end of the Mesozoic.

The trend toward higher percentages of protobranches continues in the Paleocene (3 faunas that average 12 per cent protobranches) and through the Eocene (4 faunas average 13 per cent protobranches). Beginning with the Oligocene the percentage of protobranches declines considerably. Two Oligocene pelecypod faunas average only 7 per cent protobranches. Seven Miocene faunas average 9 per cent protobranch species, and this includes a remarkable fauna, the Miocene of Astoria, Oregon (Moore, 1963), in which 25 per cent of the pelecypod species are protobranches. The 2 Pliocene faunas average only 4 per cent protobranches, and the 2 Pleistocene faunas 7 per cent protobranches. The marked reduction of protobranch species in shallow-water marine faunas beginning in the Oligocene may be due to more deposit-feeding tellinaceans supplanting protobranches in this environment.

In the Recent marine faunas, protobranches range from 12 to 23 per cent only in the polar and most of the cold-temperate faunas where the average tem-

perature of the water is 10°C or less. The highest percentage, 23 per cent protobranchs, is found in the Arctic, but only 13 per cent of all Antarctic pelecypod species are protobranchs. In the tropical and warm-temperate marine faunas, the protobranchs range from 1 to 7 per cent of each pelecypod fauna.

There are 3 fossil pelecypod faunas that are devoid of protobranchs. The Permian Whitehorse fauna (Newell, 1940) has only 14 species of pelecypods, none of which are protobranchs. The Early Triassic fauna described by Ciriacks (1963) contains 23 species, but none are protobranchs. A Pleistocene fauna from southwestern Japan described by Hayasaka (1961) contains 87 species; none are protobranchs, but there are 10 species of deposit-feeding tellinaceans. The relatively coarse sediment comprising the Whitehorse Sandstone was not conducive to deposit feeding, and 14 pelecypod species are suspension feeders. No explanation can be given for the absence of protobranchs in the Early Triassic fauna described by Ciriacks. The lack of protobranchs in the Pleistocene fauna from southwestern Japan may be attributed to the fact that it was a shallow warm-water environment suitable for deposit-feeding tellinaceans but unsuitable for protobranchs.

No Jurassic or older pelecypod faunas analyzed had undoubted deposit-feeding tellinaceans, (See Pohlo, 1968, for deposit-feeding and non-deposit-feeding tellinaceans) although this superfamily has been reported in rocks as old as Late Triassic or Early Jurassic. Throughout the Cretaceous, deposit-feeding tellinaceans (the Tellinidae) comprise no more than 6 per cent of the total pelecypod species in any of the 11 faunas analyzed, but none of these faunas was devoid of the Tellinidae. Only the Wangaloan (Paleocene) beds of New Zealand lack deposit-feeding tellinaceans (Finlay and Marwick, 1937). The remainder of the Paleocene, the Eocene, the Oligocene, and a few of the early Miocene faunas have deposit-feeding tellinacean species comprising 5 to 9 per cent of the pelecypod species. Most Middle Miocene faunas and all Late Miocene faunas have 10 per cent or more deposit-feeding tellinaceans. This is true also of the 2 Pliocene and 2 Pleistocene faunas analyzed. The oldest Miocene fauna that has at least 10 per cent deposit-feeding tellinaceans is the Chipola Formation of Florida, and it is considered to be Late Early Miocene in age. By Middle Miocene time the

diversity of deposit-feeding tellinaceans had reached approximately its present level.

In Recent faunas there is a higher percentage of deposit-feeding tellinaceans in warm water than in cold water. In water temperature of 20°C or higher, deposit-feeding tellinaceans range from 9 to 19 per cent of the total pelecypod fauna. In colder waters the deposit-feeding tellinaceans range from 0 to 10 per cent. There is an interesting geographic trend superimposed on that of water temperature. In the southern hemisphere the number of species of deposit-feeding tellinaceans is considerably lower than in the northern hemisphere. The South Australian and New Zealand faunas have only 4 per cent deposit-feeding tellinacean species, the Tasmanian and Magellanic faunas have only 3 per cent, and the Antarctic pelecypod fauna has none. On the other hand, the fauna at Monterey Bay, California, has 10 per cent deposit-feeding tellinacean species, that of Canada 9 per cent, and that of the Arctic 6 per cent.

Beginning with the Cretaceous, one can compare the diversity of the protobranchs to the deposit-feeding tellinaceans in the various fossil pelecypod faunas. The Early Cretaceous pelecypod faunas have few species of deposit-feeding tellinids, but there is an increase in number of species in Cenomanian faunas, which are commonly considered the oldest Late Cretaceous. The oldest pelecypod fauna where tellinid species outnumber protobranch species is in the Aptian, Early Cretaceous of Lebanon (Vokes, 1940). However, there are only 5 deposit-feeding species in this fauna, comprising 9 per cent of the total pelecypod species. Of the 9 Late Cretaceous pelecypod faunas examined, 3 have more tellinid species than protobranch species. The 3 Paleocene and 4 Eocene faunas have a greater number of protobranch species than tellinacean deposit-feeding species, despite the fact that the semelids, which are also deposit-feeding tellinaceans, first appeared in the Eocene. Of the 2 Oligocene faunas, one has a greater number of deposit-feeding tellinacean species than protobranch species. However, beginning with the Miocene the tellinacean deposit-feeding species more commonly outnumber the protobranch species. Of 7 Miocene pelecypod faunas analyzed, only 2 have more species of protobranchs than of deposit-feeding tellinaceans. These 2 are the Shoal River Miocene of Florida (Gardner, 1926-1928) and the Miocene of Astoria, Oregon

(Moore, 1963). In all 4 Pliocene and Pleistocene faunas, the deposit-feeding tellinacean species outnumber the protobranch species. Thus, from Miocene onward, most of the fossil pelecypod faunas are similar to Recent warm-water faunas (average temperature 20°C or higher, Nicol, 1969) in that the deposit-feeding tellinaceans outnumber the protobranch species. It is obvious from these data that the ratio of percentages of tellinacean deposit-feeding species to protobranch species in pelecypod faunas older than Miocene is an unreliable indicator of water temperature, and in even some of the Early and Middle Miocene pelecypod faunas, water temperature may not be too accurately indicated by the protobranch-tellinacean species ratio.

In summation on the diversity of deposit-feeding pelecypods through time, all Paleozoic faunas average 10 per cent deposit feeders, with a range from 0 to 15 per cent. The Mesozoic pelecypod faunas average only 8 per cent deposit feeders, with a range from 0 to 18 per cent. Of the Cenozoic faunas excluding the Recent, the average percentage of deposit feeders is 16 per cent, with a range from 11 to 38 per cent. The fauna with 38 per cent deposit-feeding pelecypods is from the Middle Miocene of Astoria, Oregon. It is interesting to note the rapid increase in diversity of deposit-feeding pelecypods beginning in the Paleocene. In the shallow-water Recent faunas the average percentage of deposit-feeding pelecypods is 19 per cent, with a range of from 7 to 29 per cent, the Arctic having the highest percentage but closely followed by Canada. Deposit-feeding pelecypods are now at least as diverse as they have ever been in the past.

Purdy (1964) pointed out that there is a higher percentage of deposit-feeding marine animals in silt and clay substrates than in the coarse sediments such as sands, where deposit feeders are few or absent. In the fossil faunas analyzed, where there are reliable data on the lithology of the beds, the following results were obtained. In 6 sandy formations the average percentage of deposit-feeding pelecypods is 12 per cent. In 5 marl and limestone formations the average percentage of deposit-feeding pelecypods is only 10 per cent. This is surprising in that the percentage is lower than in the sandy formations. In 3 silty formations the average percentage of deposit-feeding pelecypods is 27 per cent.

There appear to be at least 5 variables in the distribution of, or diversity of, deposit-feeding

pelecypods. The type of bottom sediment is definitely a factor. There is a greater percentage of deposit-feeding pelecypods in clays and silts than in sands and limestones. Geographic distribution can be a factor in the diversity of deposit-feeding pelecypods at a given locality. At present there are considerably fewer deposit-feeding tellinaceans in the southern hemisphere than in the northern hemisphere, and this mainly explains why the southern hemisphere pelecypod faunas have a lower percentage of deposit feeders. The paucity of deposit-feeding tellinaceans in the Recent faunas of the southern hemisphere may explain why there are none of these pelecypods in the Wangaloan (Paleocene) of New Zealand. In other words, the deposit-feeding tellinaceans originated in the northern hemisphere and are still not so diverse in the southern hemisphere. Water temperature is a factor in deposit-feeding pelecypod distribution today, with protobranchs dominating the colder waters. Water temperature is also closely linked with water depth. In deeper water there is generally a higher percentage of deposit feeders, and at great depths (2000 meters or more) the protobranchs comprise at least 35 per cent of the total pelecypod species. The stage of diversity or evolution of the protobranchs and deposit-feeding tellinaceans is another important variable. The protobranchs are an ancient stock, going all the way back to the Ordovician, whereas the deposit-feeding tellinaceans are a relatively modern group, appearing in the Early Cretaceous but not attaining their present great diversity until about the Middle Miocene.

In order to conserve space, I have not cited in the main body of this paper each reference that I analyzed, but all references are included in the bibliography. Fourteen Recent and 50 fossil pelecypod faunas are analyzed. Of the fossil faunas, 19 are Cenozoic, 18 are Mesozoic, and 13 are Paleozoic in age. I have excluded the Recent deep-sea pelecypod fauna because all of the fossil faunas analyzed are from shallow water. Deep-water sediments of the past are rarely available for study, and modern deep-water faunas are quite different from fossil shallow-water faunas.

#### LITERATURE CITED

- Arkell, W. J. 1929-1937. A monograph of British Corallian Lamellibranchiata. *Palaeontographical Soc.* pts. 1-10: 1-392.
- Bird, S. O. 1968. A pelecypod fauna from the

- Gaptank Formation (Pennsylvanian) West Texas. *Bull. Am. Paleo.* **54** (240): 111-185.
- Carcelles, A. R., and S. I. Williamson 1951. Catalogo de los moluscos marinos de la Provincia Magallanica. *Argentino Mus. Ciencias Nat., Bol., Ciencias Zool.* **2** (5): 225-283.
- Chavan, A. 1952. Les pēlēcypodes des sables Astartiens de Cordebugle (Calvados). *Mém. Suisses de Paléo.* **69**: 1-132.
- Chronic, H. 1952. Molluscan fauna from the Permian Kaibab Formation, Walnut Canyon, Arizona. *Bull. Geol. Soc. Am.* **63** (2): 95-166.
- Ciriacks, K. W. 1963. Permian and Eotriassic bivalves of the middle Rockies. *Bull. Am. Mus. Nat. Hist.* **125** (1): 1-100.
- Clark, W. B. and G. C. Martin 1901. The Eocene deposits of Maryland. *Maryland Geol. Survey Eocene Vol. 1*, 331 p.
- Cotton, B. C. and F. K. Godfrey 1938. The molluscs of South Australia, part 1, The Pelecypoda. Government Printer, Adelaide, South Australia. 314 p.
- Dall, W. H., P. Bartsch and H. A. Rehder 1938. A manual of the Recent and fossil marine pelecypod mollusks of the Hawaiian Islands. *Bernice P. Bishop Mus. Bull.* **153**: 1-233.
- Dickens, J. M. 1963. Permian pelecypods and gastropods from Western Australia. *Bur. Mineral Res., Geol. and Geophysics, Australia. Bull.* **63**: 1-202.
- DuBar, J. R. 1958. Stratigraphy and Paleontology of the Late Neogene strata of the Caloosahatchee River area of southern Florida. *Florida Geol. Survey Bull.* **40**: 1-267.
- Finlay, H. J. and J. Marwick 1937. The Wangaloan and associated molluscan faunas of Kaitangata-Green Island Subdivision. *New Zealand Geol. Survey Paleo. Bull.* **15**: 1-140.
- Gardner, J. A. 1916. Upper Cretaceous, Vol. 1 text, Vol. 2 text and plates. *Maryland Geol. Survey.* 1-1022.
- Gardner, J. A. 1926-1928. The molluscan fauna of the Alum Bluff Group of Florida. *U. S. Geol. Survey Prof. Papers* 142A-E: 1-249.
- Gardner, J. A. 1935. The Midway Group of Texas. *Univ. Texas Bull.* **3301**: 1-403.
- Glibert, M. and J. de H. de Braucourt 1954. L'Éocène inférieur Belge. Vol. Jubilaire Victor de Selys-Longchamps, *Inst. Roy. Nat. Belgique.* **1**: 1-84.
- Görge, J. 1952. Die Lamellibranchiaten und Gastropoden des Oberoligozänen Meeressandes von Kassel. *Abh. hess. L.-Amt Bodenforsch., Wiesbaden*, **4**: 1-134.
- Harris, G. D. and K. V. W. Palmer 1946. The Mollusca of the Jackson Eocene of the Mississippi Embayment (Sabine River to the Alabama River). *Bull. Am. Paleo.* **30** (117): 1-563.
- Hayami, I. 1965-1966. Lower Cretaceous marine pelecypods of Japan. parts 1-3, *Mem. Faculty Sci., Kyushu Univ., Ser. D, Geol.*, **15** (2): 221-349, **17** (2): 73-150, **17** (3): 151-249.
- Hayasaka, S. 1961. The geology and paleontology of the Atsumi Peninsula, Aichi Prefecture, Japan. *Sci. Reports Tohoku Univ., Sendai, 2nd Ser. (Geol.)*. **33** (1): 1-103.
- Hind, W. 1896-1900. A monograph of the British Carboniferous Lamellibranchiata. parts 1-5, *Palaeontographical Soc. London.* 1-476.
- Isberg, O. 1934. Studien über Lamellibranchiaten des Leptaenakalkes in Dalarna. *Håkan Ohlssons Buchdruckerei, Lund, Sweden.* 1-492.
- Keen, A. M. 1958. Sea shells of tropical west America. *Stanford Univ. Press, California.* 1-626.
- La Rocque, A. 1950. Pre- Traverse Devonian pelecypods of Michigan. *Contrib. Mus. Paleo., Univ. Michigan.* **7** (10): 271-356.
- La Rocque, A. 1953. Catalogue of the Recent Mollusca of Canada. *Nat. Mus. Canada Bull.* **129**: 1-406.
- Logan, A. 1967. The Permian Bivalvia of northern England. *Palaeontographical Soc., London.* **121** (518): 1-72.
- Mansfield, W. C. 1932. Miocene pelecypods of the Choctawhatchee Formation of Florida. *Florida Geol. Survey Bull.* **8**: 1-240.
- Manfield, W. C. 1937. Mollusks of the Tampa and Suwannee Limestones of Florida. *Florida Geol. Survey Bull.* **15**: 1-344.
- Marwick, J. 1953. Divisions and faunas of the Hokonui System (Triassic and Jurassic). *New Zealand Geol. Survey Paleo. Bull.* **21**: 1-141.
- May, W. L. and J. H. Macpherson 1958. An illustrated index of Tasmanian shells. Government Printer, Tasmania. 1-72.
- McAlester, A. L. 1962. Upper Devonian pelecypods of the New York Chemung Stage. *Peabody Mus. Nat. Hist., Yale Univ., Bull.* **16**: 1-88.
- Mongin, D. 1967. Les mollusques du Bathonien

- Saumatre du moyen Atlas. Notes et Mém. Serv. géol. Maroc. **200**: 37-94.
- Moore, E. J. 1963. Miocene marine mollusks from the Astoria Formation in Oregon. U. S. Geol. Survey Prof. Paper **419**: 1-109.
- Nakazawa, K. and N. D. Newell 1968. Permian bivalves of Japan. Mem. Fac. Sci., Kyoto Univ., Ser. Geol. and Mineralogy. **35** (1): 1-108.
- Newell, N. D. 1940. Invertebrate fauna of the Late Permian Whitehorse Sandstone. Bull. Geol. Soc. Am. **51**: 261-336.
- Nicklès, M. 1950. Mollusques testacés marine de la côte occidentale d'Afrique. Manuels Ouest-Africains, Paris II. 1-269.
- Nicol, D. 1967. Some characteristics of cold-water marine pelecypods. Jour. Paleo. **41** (6): 1330-1340.
- Nicol, D. 1969. Deposit-feeding pelecypods in Recent marine faunas. Trans.-Gulf Coast Assoc. Geol. Soc. **19**: 423-424.
- Olsson, A. A. 1961. Mollusks of the tropical eastern Pacific particularly from the southern half of the Panamic-Pacific faunal province (Panama to Peru): Panamic-Pacific Pelecypoda. Paleo. Res. Inst., Ithaca, New York. 1-574.
- Perry, L. M. and J. S. Schwengel 1955. Marine shells of the western coast of Florida. Bull. Am. Paleol. **26** (95): 1-318.
- Pohlo, R. 1969. Confusion concerning deposit feeding in the Tellinacea. Proc. Malacological Soc. London. **38** (4): 361-364.
- Powell, A. W. B. 1946. The shellfish of New Zealand. Whitcombe and Tombs, Christchurch, New Zealand, 2nd. ed. 1-106.
- Purdy, E. G. 1964. Sediments as substrates. in J. Imbrie and N. D. Newell, Approaches to paleoecology. John Wiley and Sons, New York. 238-271.
- Schmidt, M. 1928. Die Lebewelt unsererer Trias. Ferdinand Rau, Öhringen, Germany. 1-461.
- Smith, A. G. and M. Gordon, Jr. 1948. The Marine mollusks and brachiopods of Monterey Bay, California, and vicinity. Proc. Calif. Acad. Sci. 4th. Ser. **26** (8): 147-245.
- Stenzel, H. B., E. K. Krause and J. T. Twining 1957. Pelecypoda from the type locality of the Stone City Beds (Middle Eocene) of Texas. Univ. Texas pub. **5704**: 1-237.
- Stephenson, L. W. 1923. The Cretaceous formations of North Carolina. Part 1. Invertebrate fossils of the Upper Cretaceous formations. North Carolina Geol. Survey. **5** : 1-604.
- Stephenson, L. W. 1941. The larger invertebrate fossils of the Navarro Group of Texas. Univ. Texas pub. **4101**: 1-641.
- Stephenson, L. W. 1953. Larger invertebrate fossils of the Woodbine Formation (Cenomanian) of Texas. U. S. Geol. Survey Prof. Paper **242**: 1-226.
- Vokes, H. E. 1939. Molluscan faunas of the Domengine and Arroyo Hondo Formations of the California Eocene. Ann. New York Acad. Sci. **38**: 1-246.
- Vokes, H. E. 1946. Contributions to the paleontology of the Lebanon Mountains, Republic of Lebanon, part 3. The pelecypod fauna of the "Olive Locality" (Aptian) at Abeih. Bull. Am. Mus. Nat. Hist. **87** (3): 143-215.
- Vokes, H. E. 1957. Miocene fossils of Maryland. Maryland Geol. Survey Bull. **20**: 1-85.
- Wade, B. 1926. The fauna of the Ripley Formation on Coon Creek, Tennessee. U. S. Geol. Survey Prof. Paper **137**: 1-272.
- Warmke, G. L. and R. T. Abbott 1961. Caribbean seashells, Livingston Publishing Co., Narberth, Pennsylvania. 1-348.
- Wilson, A. E. 1956. Pelecypoda of the Ottawa Formation of the Ottawa-St. Lawrence lowland. Geol. Survey Canada Bull. **28**: 1-102.
- Winters, S. S. 1963. Supai Formation (Permian) of eastern Arizona. Geol. Soc. Am. Mem. **89**: 1-99.
- Woodring, W. P. 1925. Miocene mollusks from Bowden, Jamaica. Pelecypods and scaphopods. Carnegie Inst. Washington pub. **366**: 1-222.

TWO NEW NORTH AMERICAN PULMONATA: *PARAVITREA SERADENS*  
AND *PHILOMYCUS SELLATUS*

Leslie Hubricht

4026 35th Street

Meridian, Mississippi 39301

ABSTRACT

*Paravitrea seradens* Hubricht (*Zonitidae*) from Gauley Bridge, Fayette Co., West Virginia, and the slug *Philomycus sellatus* Hubricht from Princeton, Jackson Co., Alabama, are described as new species. Additional geographical records are given for *Helicodiscus triodus* Hubricht. Anatomical notes are made on *Triodopsis occidentalis* (Pilsbry and Ferriss) and *Polygyriscus virginianus* (P. R. Burch).

***Triodopsis occidentalis* (Pilsbry & Ferriss)**

*Triodopsis obstricta occidentalis* (Pilsbry and Ferriss),

Pilsbry, H. A., 1940, Land Mollusca of North America (north of Mexico). Aca. Nat. Sci. Philadelphia, Mono. 3, 1: 829.

*Mesodon sargentianus* (Johnson & Pilsbry), Vagvolgyi, J., 1968, Bull. Mus. Comp. Zool. 136: 210.

I recently collected this species alive near Locust Grove, Independence Co., Arkansas. The genitalia was found to be similar to that of *T. denotata* (Férussac) (Pilsbry, fig. 473-6.). The shell appears to be a connecting link between *T. obstricta* (Say) and *T. fosteri* (F. C. Baker). The aperture is somewhat intermediate between these two species. The periphery varies from strongly angulate to carinate.

***Paravitrea seradens* new species**

FIGS. 1a-c.

*Description:* Shell small, pale amber, subhyaline, glossy; spire low, dome-shaped, sutures shallow, sculpture of numerous irregularly spaced radial grooves; periphery somewhat flattened giving the shell a quadrate appearance in immature shells, becoming more rounded at maturity; umbilicus deep and well-like exhibiting all the whorls, contained over 5 times in the diameter of the shell, base flattened and excavated around the umbilicus; whorls slowly expanding, last whorl expanding more rapidly and deflected downward to the aperture; aperture lunate, oblique; lip thin, simple; internal armature of one or more pairs of rather large teeth on the outer

and basal walls at all stages of growth, except in an occasional very old shell.

Height 2.8 mm., diameter 5.5 mm., aperture height 2.0 mm., diameter 2.5 mm., umbilicus diameter 1.0 mm., 6.9 whorls. Holotype.

*Distribution:* West Virginia: Kanawha Co.: wooded hillside, Hernshaw. Fayette Co.: below Cane Branch Falls, 1.5 miles east of Gauley Bridge, holotype 173020 and paratypes 173021 Field Museum of Natural History, other paratypes A8774 collection of the author. Wyoming Co.: mountainside, 2.8 miles northeast of Wolf Pen. Logan Co.: ravine, 4.8 miles southwest of Holden. Mingo Co.: Gyandot River bluff, opposite Justice; mountainside, 0.7 mile north of Cinderella. McDowell Co.: ravine, 4 miles northeast of Welch.

*Remarks* — *Paravitrea seradens* is most closely related to *P. capsella* (Gould) differing in having at least one pair of teeth at all stages of growth; in having a more expanded aperture; in having the base more impressed around the umbilicus; and in having a larger umbilicus in immature shells, the umbilicus being more well-like. The type locality for this species is also the type locality for *Helicodiscus triodus* Hubricht and *Carychium clappi* Hubricht.

***Polygyriscus virginianus* (P. R. Burch)**

*Polygyra virginianus* P. R. Burch, 1947, The Nautilus 61: 40.

*Polygyriscus virginianus* (P. R. Burch), Burch J. B., 1962, How to Know the Eastern Land Snails. Wm. C. Brown Co., Dubuque, Iowa. p. 148.



On a recent visit to the type locality I succeeded in collecting a series of living specimens of this species by "mining" at the right spot. Immature shells have epidermal fringes on the spiral ridges, and look very much like immature *Helicodiscus fimbriatus* Wetherby, but are without teeth. After maturity these fringes wear off and they are completely gone in old shells. In adults there is a transverse tooth on the base a short distance within the aperture. This was not mentioned in the original description. *P. virginianus* seems closely related to *Helicodiscus* but whether it should be placed in that genus is left open pending anatomical studies.

#### *Helicodiscus triodus* Hubricht

This species can be added to the growing list of cave snails, as it has been found living in the two caves listed below.

*West Virginia:* Monroe Co.: McClungs Cave, Zenith. Greenbrier Co.: McClungs Cave, 1.5 miles northeast of Maxwelton. These two caves are not connected, although they have the same name. They are about thirty miles apart.

#### *Philomycus sellatus* new species

FIGS. 1d-e

*Description:* The mantle pattern is black on a white or cream background in very young slugs; as they become older the pattern becomes lighter, dark gray in half-grown slugs and brownish gray in adults and the background becomes darker so that the pattern is somewhat obscured. The forward end of the mantle is irregularly mottled; behind this is an area in which the dark pigment is greatly reduced. About one-third of the way back is a transverse dark band with irregular margins. On the latter half of the mantle there is a broad dorsal band which is bordered by a series of elongated black spots. On each side there is a narrow longitudinal band with irregularly scattered mottling above and below. This mottling may become so thick as to obscure the lateral bands and merge them with the dorsal band. The tentacles are dark gray, and the foot is white. The maximum length of adults when extended in crawling is about 100 mm.

*Distribution:* *Alabama:* Jackson Co.: wooded hillside, 1.7 miles northeast of Princeton, holotype 157322 F. M. N. H., paratypes 30066 collection of the author; base of Putnam Mtn., 4 miles northwest of Princeton; Woodville (H. E. Sargent); Russell Cave

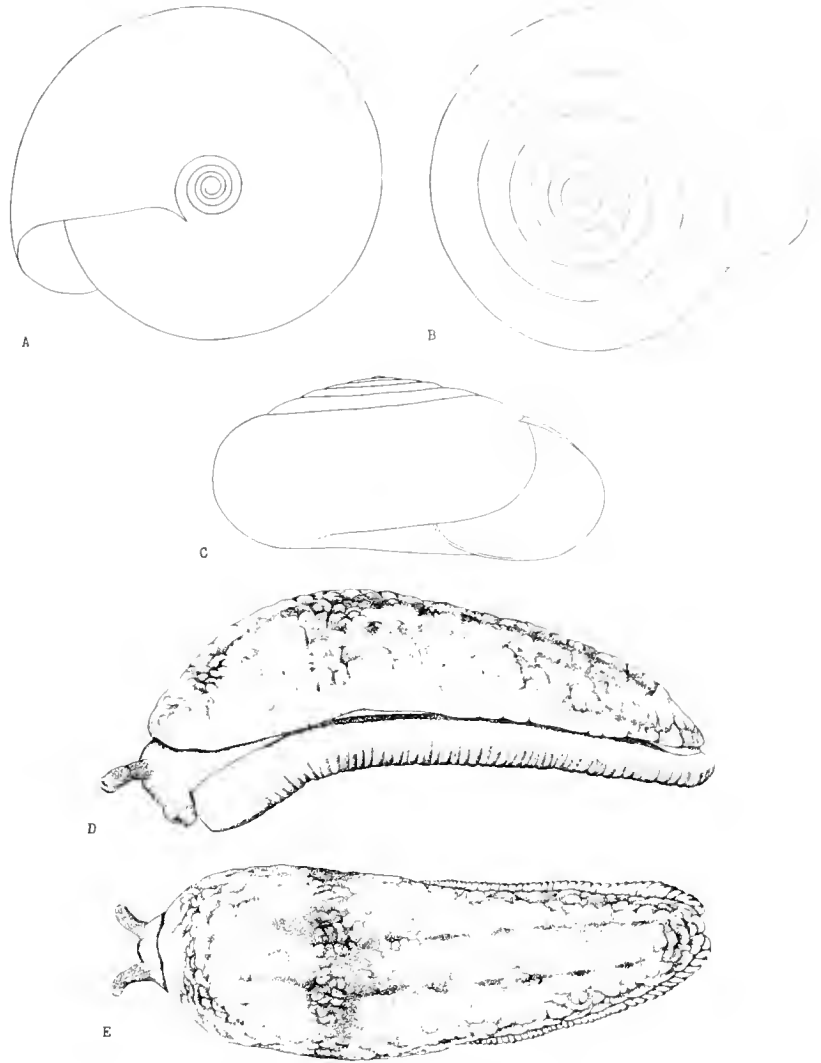

FIG. 1A-C. *Paravitrea seradens* Hubricht, holotype. FIG. 1D-E. *Philomycus sellatus* Hubricht, holotype.

National Monument. Madison Co.: wooded hillside, 1.3 miles northeast of New Hope: base of Sharp Mtn., near Sneeds Spring, Sharps Cove, northeast of Maysville. *Tennessee:* Franklin Co.: hilltop, 2.5 miles south-southeast of Huntland. Marion Co.: Raven Den Point Sink, 1.8 miles west of Martin Spring.

*Remarks:* *Philomycus sellatus* is most closely related to *P. carolinianus* (Bosc). The latter half of the mantle is not distinguishable, but the transverse light band followed by a dark band on the forward half will readily separate it. *Philomycus sellatus* is the common upland slug of northeastern Alabama and adjacent Tennessee. It sometimes occurs with *P. carolinianus*.

Illustrations by Miss Carole Wrigley provided through the courtesy of Field Museum of Natural History.

## A NOTE ON LAND SNAILS ASSOCIATED WITH KUDZU VINE

Dorothy E. Beetle

Peninsula Nature Museum  
524 Clyde Morris Boulevard  
Newport News, Virginia 23601

### ABSTRACT

*A heavy growth of Kudzu vine taking over a sandy slope and nearby woodland in Newport News, Virginia, now supports a large population of land snails, consisting of ten species. Among the genera represented are Triodopsis, Retinella, Hawaiiia, Ventridentis, Zonitoides, Helicodiscus, Strobilops, Gastrocopta, and Vertigo.*

On March 28, 1971 a fire raced along the north boundary of the grounds of the Peninsula Nature Museum in Newport News, Va. This area includes the steep slope of a railroad overpass and adjacent forest floor. This report lists the snails found exposed by the complete removal of leaf litter.

Originally the land where the museum and the road are situated was covered with a mixed pine and hardwood forest. White and black oaks and hickories are abundant and sweetgum, red maple, beech, tulip tree and the shrubby dogwood and sourwood occur in the area. The elevation is 45 feet above sea level. The soil is coarse sand, with crossbedded sands, gravels and clays extending downwards to considerable depths. Newport News lies on a peninsula which juts into the Chesapeake Bay. Its climate is mild with abundant rain.

When the road and overpass were constructed in 1958, the steep sandy slopes were planted with Kudzu vine to prevent erosion. This rapidly formed a dense mass which smothered volunteer plants. The Kudzu has since invaded the adjacent woods. It has smothered shrubs under festoons of vine and climbed into the crowns of the tallest trees, killing them. Under the trees scattered patches of moss, grass and a few early spring flowers are the only plants which survive.

In fall the Kudzu becomes dormant, leaving a brittle mat of dead leaves resting slightly above the

soil on the vines which thickly crisscross along the ground. These leaf mats can be lifted intact to view the bare sand beneath. Even in the woods the sand permits the rapid leaching of material and only a thin humus layer is formed. Under the Kudzu vine desiccated plant material consists almost entirely of the previous year's growth. On the steep slopes of the overpass the soil has almost no traces of plant debris.

In view of the exposed and limited habitat of the overpass, it was surprising to discover a large population of land snails consisting of 10 species, plus 3 additional ones on the floor of the woods invaded by Kudzu. The fire completely cleared the area of plant material and the snails were picked up from the surface of the sand.

### STATION 1

One square yard, 35° slope, almost under the overpass, 3 feet above ground level. The *Triodopsis* and *Gastrocopta* were most numerous at this station. One specimen of *V. oscariana* occurred here.

*Triodopsis juxtidentis*

*Retinella indentata paucilirata*

*Hawaiiia minuscula*

*Ventridentis cernoides*

*Zonitoides arboreus*

*Helicodiscus parallelus*

*Strobilops labyrinthica*

*Gastrocopta contracta*

*Vertigo oscariana*

## STATION 2

One square yard on low slope of embankment, one foot above ground level.

*Triodopsis juxtidentis*

*Retinella indentata paucilirata*

*Helicodiscus parallelus*

*Succinea* sp., juvenile

*Gastrocopta contracta*

## STATION 3

Under standing dead trees, under and around log 4 inches in diameter.

*Triodopsis juxtidentis*

*Triodopsis fallax obsoleta*

*Triodopsis albolabris*

*Helicodiscus parallelus*

*Retinella indentata paucilirata*

*Hawaiiia minuscula*

Random collection from the forest floor also turned up specimens of *Mesodon thyroidus* and

*Ventridens cernoides*. *Triodopsis juxtidentis* was most abundant all through the forest area; in some places as many as a dozen individuals lying in one square yard.

The woods in the vicinity of the nature museum are second growth and receive fairly heavy use for recreational purposes. While much of the understory has been trampled down, the Kudzu vine has not yet invaded this section. The same mollusks are present as in the area of the Kudzu vine except for *Succinea* sp., *Gastrocopta contracta* and *Vertigo oscariana*. *T. juxtidentis* and *H. parallelus* are most abundant.

Gratitude is expressed for the assistance of F. Wayne Grimm for identification of some of the material.

## LITERATURE CITED

Pilsbry, Henry A. 1940-1948 Land Mollusca of North America (North of Mexico). Vols. 1-3. Acad. Nat. Sci. Phila., Monogr. 3.

## BOOK REVIEW

## THE MARINE MOLLUSCS OF ARCTIC CANADA.

By Elizabeth Macpherson. Publications in Biological Oceanography, no. 3. 149 pp., 54 maps, 7 pls. Paperback. 1971. \$3.50. Available by mail from the Marketing Division, National Museums of Canada, Ottawa 4, Canada.

This is a welcome handbook account of the shelled marine mollusks of Arctic Canada exclusive of the bivalves and cephalopods. Included are 108 species of prosobranch gastropods, chitons and scaphopods. Each species has its main synonymy, adequate description, list of Canadian localities, literature records, overall range, distributional map, and an accompanying photograph. There is a brief but

interesting discussion of the ecology and zoogeography of the mollusks of the Canadian Arctic. An up-to-date bibliography and index are included.

The nomenclature is excellent, although a few discrepancies have crept in. *Lophyrochiton* Yakovleva, 1952, may be preceded by *Stenosemus* Middendorff, 1847, and *Lepidopleuroides* Thiele, 1893. *Buccinum tenue* Gray, 1839 (non Schröter, 1805) should be *scalariforme* Möller, 1842. The modern typography of the printed page, consisting of alternating double and single columns and not-too-clear photographs do not make this otherwise excellent work easy to use.

R. Tucker Abbott

Delaware Museum of Natural History

SEASONAL VARIABILITY IN CALYCVLISM IN *SPHAERIUM TRANSVERSUM* (SAY)<sup>1</sup>William F. Gale<sup>2</sup>Department of Zoology and Entomology  
Iowa State University, Ames, Iowa 50010

## ABSTRACT

*The nepionic shell of the freshwater bivalve, Sphaerium transversum, may be separated from the older part of the shell by a sulcus, thus forming a bulging "cap" or calyculus at the umbo. Populations sampled from a stream in Iowa showed varying percentages of specimens being calyculate or noncalyculate. Growth experiments in a field laboratory indicated that arrested growth caused the formation of a calyculus, thus suggesting that this character is of questionable taxonomic importance.*

The calyculus or "cap" is the bulging upper portion of the beak or umbo of some sphaeriid shells. It consists of the shell of the nepionic young (Thomas, 1965) and is separated from the rest of the shell by a sulcus. While investigating the bottom fauna of the Mississippi River near Fort Madison, Iowa (Gale, 1969), I observed that some *Sphaerium transversum* were distinctly calyculate and that others were distinctly noncalyculate. Frequently, intermediates were found in which the nepionic shell was distinct, but not elevated above the surface of the adjoining shell. Such shells were not considered calyculate.

That *S. transversum* occurs in two forms has long been recognized (Sterki, 1909). The significance of the calyculus and why it is sometimes absent have not been explained. Herrington (1968, personal communication) suggested that "capped beaks" might result from a rest period. The presence of calyculi was a characteristic used to justify the validity of *Musculium* as a genus. Herrington (1962) suggested that calyculi have little taxonomic value because they occasionally occur in groups other than *Musculium* and are variable within a species.

In bottom samples, the proportion of calyculate clams diminished progressively between June and September (Table 1). Similar trends occurred at several sampling stations. Clams 2-3 mm long, with the exception of those in May and December, usually were not calyculate. Probably most of the clams 2-3 mm long had not grown since birth. Since the calyculus represents the nepionic shell, it cannot be observed until visible post-embryonic growth has taken place. A few calyculate clams 2-3 mm long were observed in the June-November collections, but were missed in random selection of the subsamples.

In June, all clams examined were calyculate except those 2-3 mm long. Most clams over 3.0 mm long in June probably had over-wintered when 2-3 mm long. In May only clams of the first two sizes were present at station 14, the station where the June to December samples were collected. Unless immigration occurred at station 14 between May and June or unless the samples were not representative, the small clams of May grew into large calyculate clams by June. Thus, clams that overwinter when 2-3 mm long, presumably before growing, become calyculate as growth commences the following spring.

In July, all clams 3-4 mm long and 30% of those 4-5 mm long were noncalyculate. These were probably born in June or July 1967. By August, noncalyculate clams 6-7 mm long were beginning to appear. A major die-off of calyculate clams in large size classes occurred in August, and by September, only noncalyculate clams remained. The absence of calyculate clams at station 14 in September means that the entire population consisted of clams born in 1967, probably since May.

<sup>1</sup> Journal Paper No. J-7035 of the Iowa Agriculture and Home Economics Experiment Station, Ames, Iowa. Project 1374. A contribution from the Iowa Cooperative Fishery Unit sponsored by the Iowa State Conservation Commission, Iowa State University of Science and Technology, and the Bureau of Sport Fisheries and Wildlife (U. S. Department of Interior). (Contract 14-16-0003-12204).

<sup>2</sup> Present address: Ichthyological Associates, Berwick, Pennsylvania 18603.



In October, calyculate clams reappeared, with smaller clams becoming calyculate. During November and December, the population included both calyculate and noncalyculate clams. Of clams 2-3 mm long, 90% were calyculate in December. Thus, overwintering is not essential for calyculus formation; but all small clams that overwintered became calyculate, while only part of those born between September and December became calyculate.

The possibility that an initial period of no growth (resting state) influences subsequent shell development is plausible and is supported by growth experiments conducted in a field laboratory during 1967 (Gale, 1969). In the laboratory most clams which had an initial lag in growth became calyculate and those which grew immediately after birth became noncalyculate. Therefore, the presence or absence of calyculi in *S. transversum* is not hereditarily determined within the species. Thomas (1959) observed that newborn *S. partumeium* reared in the laboratory frequently exhibited a lag in growth lasting up to 6 weeks, but clams that grew immediately gave birth to young that also began to grow immediately. Presumably, clams that did not grow immediately produced young that had a growth lag.

The stimulus that elicited a resting state in laboratory-reared clams in my study, is not known, but certain clues may be discovered by examining the methods in which the clams were treated. Clams, in chambers where growth lags occurred, were born in a pan of river water, picked up with a camel-hair brush, measured with an ocular micrometer, and placed into a vial of river water until four were collected. The vial of clams and water was then poured into the proper chamber. Small clams in chambers where growth lags did not occur were born there and were not measured or otherwise handled until the chambers were cleaned after 33 days.

Physical and chemical changes may have occurred in the pan of river water holding the parental stock. None of the newborn was in the pan longer than an hour, but the process of gathering them from the pan and making measurements consumed almost an entire afternoon; ample time for changes in water temperature, dissolved oxygen, pH, etc.

Tactile stimulation might have elicited a resting state. Besides being handled with a brush, young were frequently pushed about by larger clams in the pan. That some young were born in the well-lighted pan and others in subdued light in the laboratory may have been important. That some chambers contained the decomposing remains of the parental stock may also have been a factor. Factors causing a resting state in the laboratory and in the field may not have been the same.

The presence of calyculi in part of the population was helpful in assessing growth rates of the clams in their natural environment. For example, if we assume that the largest noncalyculate clams (4-5 mm long) in July (Table 1) became the largest noncalyculate clams (6-7 mm) in August, the mean length increase was about 2 mm. Also, noncalyculate clams 3-4 mm long in July grew to 5-6 mm in August. Since clams were noncalyculate in September, growth of calyculate clams can be followed in fall.

The results of this study substantiate Herrington's (1962) contention that calyculism is of questionable taxonomic importance.

I wish to thank Dr. Kenneth D. Carlander and Dr. R. Jess Muncy, Department of Zoology and Entomology, Iowa State University, who directed the research and made helpful suggestions concerning the manuscript.

#### LITERATURE CITED

- Gale, W. F. 1969. Bottom fauna of Pool 19, Mississippi River with emphasis on the life history of the fingernail clam, *Sphaerium transversum*. Ph.D. thesis, Iowa State Univ., Ames, Univ. Microfilm No. 69-20642, Ann Arbor, Mich.
- Herrington, H. B. 1962. A revision of the sphaeriidae of North America (Mollusca: Pelecypoda). Univ. Mich. Mus. Zool. Misc. Publ. 118. 74 p.
- Sterki, V. 1909. Some observations and notes on *Musculium*. The Nautilus 23: 17-19.
- Thomas, G. J. 1959. Self fertilization and production of young in a Sphaeriid clam. The Nautilus 72: 131-140.
- Thomas, G. J. 1965. Growth in one species of sphaeriid clam. The Nautilus 79: 47-54.

Table 1. *Gastropods from A1-4  
Halawa Valley, Molokai Island*

## SHORT PAPERS

SUBFOSSIL NON-MARINE GASTROPODS FROM  
MOLOKAI, HAWAIIAN ISLANDS

Patrick Vinton Kirch

Bernice P. Bishop Museum

P. O. Box 6037, Honolulu, Hawaii 96818

Rapid extinction of endemic land snails in the Hawaiian Islands has occurred due to massive removal of native forests, particularly in lowland areas (Carlquist 1970). Hence it is extremely difficult to find associations of endemic gastropods in their original habitats. Perkins (1913, pp. xxvi-xxvii) long-ago recognized the importance of fossiliferous, pulmonate-bearing deposits in the reconstruction of lowland snail associations. In 1969 and 1970 I studied a Holocene, non-marine gastropod bearing, subfossil deposit at the base of Halawa Valley, Molokai Island. The deposit (50-Mo-A1-4) is an eroded taluvial fan (Wentworth 1943) comprising unconsolidated sand, alluvial outwash, and slumped material.

Charcoal from the base of the fan was submitted to Gakushuin University, Japan, for radiocarbon age determination. The result (GaK-2744) was  $750 \pm 90$  B. P. (1950). The geologic matrix indicates that the fossils were deposited with debris eroded from the adjacent subvalley following extensive forest clearing in prehistoric times.

Table 1 lists the gastropods (pulmonates and prosobranchs) from this deposit. Apparently originally they comprised a lowland snail association, and as such allow a partial reconstruction of the lowland flora as well. The probable habitat of these snails is likely to have been dominated by *Acacia koa*, *Chenopodium* sp., *Eugenia sandwicensis*, and small stands of *Metrosideros* sp. (an important pulmonate host). Today the region is dominated by *Leucaena glauca*, an introduced species.

*Acknowledgements.* I should like to thank Dr. Yoshiho Kondo for aid in the identification of specimens.

## ENDODONTIDAE

*Endodonta* sp.

## ACHATINELLIDAE

*Tornatellinops baldwini* (Ancey)*Lamellidea gracilis* (Pease)*Elasmias* sp.*Tornatellides procerula* (Ancey)*Tornatellaria cincta* (Ancey)

## AMASTRIDAE

*Leptachatina emerita* Sykes*Leptachatina varia* Cooke*Amastra (Amastrella) petricola* (Newcomb)*Amastra* (s.s.) *humilis* (Newcomb)*Amastra (Heteramastra) perversa* Hyatt and Pilsbry

## SUCCINEIDAE

*Succinea* sp.

## HELICINIDAE

*Pleuropoma laciniosa* var. *molokaiensis* Neal

## LITERATURE CITED

- Carlquist, S. 1970. Hawaii: A Natural History. The Natural History Press, New York.
- Perkins, R. C. 1913. Fauna Hawaiiensis 1(6). Cambridge University Press.
- Wentworth, C. K. 1943. Soil avalanches on Oahu, Hawaii. Geol. Soc. Amer. Bull. 54:53-64.

## ODOSTOMIA TURRITA FOUND ON

HOMARUS GAMMARUS<sup>1</sup>

Jon-Arne Sneli

Biological Station, N-7001 Trondheim, Norway

Several species of molluscs belonging to the family Pyramidellidae have been reported as ectoparasites of other marine invertebrates (Robertson & Orr 1961, Cheng 1967), but only one observation of a pyramidellid in association with a crustacean has been reported (Fretter & Graham 1949).

In October 1969 a lobster (*Homarus gammarus* (L.) = *H. vulgaris* H. Milne Edwards) of 5.1 kg weight was brought to the Zoological Museum in Oslo. The

<sup>1</sup> Contribution No. 156, Biological Station, Trondheim, Norway.

lobster was collected at Herad near Farsund on the Norwegian coast. On the pinching legs and carapace were observed a few *Pomatoceros triqueter* (L.) and by close examination of the gills one specimen of *Odostomia turrita* Hanley was found. The identification of the *Odostomia* species was kindly done by Mr. Tore Höisaeter. The *O. turrita* had to sit well-attached to the gills as the lobster was boiled, transported and handled by fishmongers before delivered to the museum.

*O. turrita* is distributed from the north of Norway south to the Mediterranean, but no information about its host-specificity has been reported. According to Robertson & Orr (1961) the discovery of a pyramidellid "on" or "with" another invertebrate does not mean necessarily that the invertebrate in question is host to the pyramidellid. The only reliable records of parasitic relationships are those in which a pyramidellid has been seen to feed.

Observation of feeding was in this case impossible, but the record is still interesting as no earlier observation of *Odostomia* species associated with decapod crustaceans has been reported. Fretter & Graham (1949) have seen *O. plicata* (Montagu) thrust its proboscis onto the antennae of amphipods at Plymouth but this behaviour may well have been accidental (Robertson & Orr 1961).

Although the case remains to be proved there is no reason to believe that the *O. turrita* found on the lobster gill could possibly be associated with the few *P. triqueter* located on the exoskeleton of the lobster.

#### LITERATURE CITED

- Cheng, T. C. 1967. Marine molluscs as hosts for symbioses with a review of known parasites of commercially important species. *Adv. Mar. Biol.* 5: 1-424.
- Fretter, V. & A. Graham. 1949. The structure and mode of life of the Pyramidellidae, parasitic Opisthobranchs. *J. Mar. Biol. Ass. U. K.* 28: 493-532.
- Robertson, R. & V. Orr. 1961. Review of pyramidellid hosts, with notes on an *Odostomia* parasitic on a *Chiton*. *Nautilus* 74: 85-91.

#### PYRAMIDELLID GENERA OF PILSBRY

James X. Corgan

Austin Peay State University  
Clarksville, Tennessee 37040

H. A. Pilsbry proposed four genus-group names for taxa he considered referable to the gastropod family Pyramidellidae Gray, 1840. Each name was proposed for a new subgenus and each subgenus was characterized in a few brief words or sentences appended to a specific description. There was little in Pilsbry's writings to indicate that the subgenera were new. As a result, standard nomenclators like the *Nomenclator Zoologicus* overlooked some of the names. Most were also omitted from an excellent catalogue of Pilsbry's taxa by Clench and Turner (1962).

Today, the genus-group names Pilsbry introduced in the Pyramidellidae are little used because the pyramidellid faunas he studied have received little subsequent attention. His taxa have been overlooked and have not been evaluated by modern workers. Pilsbry's names are available names. The groups he discriminated seem to be meaningful taxa. Several could be widely distributed in the world fauna. This report lists Pilsbry's pyramidellid genera and provides a brief appraisal of each.

*Evaletta* Pilsbry, 1918

*Type Species* — By original designation, *Turbonilla (Evaletta) elizabethae* Pilsbry, 1918, p. 315.

Though it was described as a subgenus of *Turbonilla* Risso, 1826, *Evaletta* and *Turbonilla* have little in common. As interpreted by Dall and Bartsch (1909) and by Laws (1937), *Turbonilla* has prominent axial sculpture and an emergent, heterostrophic protoconch. In *Evaletta* the heterostrophic protoconch is deeply immersed and there is no axial sculpture. Species of *Evaletta* have more whorls than most *Turbonilla*. The growth form is more acicular and there is generally a weakly developed tooth on the inner lip. *Evaletta* differs from *Turbonilla* in so many characters that it should be ranked as a distinct genus.

Only two species have been referred to *Evaletta*: *Turbonilla (Evaletta) elizabethae* Pilsbry (1918, p. 314, fig. 9) and *T. (E.) laysaensis* Pilsbry (1918, p. 315, fig. 10). Both are Recent species from the Hawaiian Islands.



**Goniodostomia** Pilsbry and Johnson, 1917

*Type Species* – By original designation, *Odostomia* (*Goniodostomia*) *superans* Pilsbry and Johnson, 1917, p. 181.

Corgan (1971) catalogued the content of this nominal genus and interprets *Goniodostomia* Pilsbry and Johnson, 1917, as a junior synonym of *Eulimastoma* Bartsch, 1916.

**Nesiodostomia** Pilsbry, 1918

*Type Species* – By original designation, *Odostomia* (*Nesiodostomia*) *prima* Pilsbry, 1918, p. 325; *non* *Odontostomia acutiuscula* var. *prima* Boettger, 1907 (= *Nesiodostomia montforti* Corgan, 1972).

The characters, content, and distribution of *Nesiodostomia* are discussed at length by Corgan (1972). *Nesiodostomia* has been recorded from the Tertiary of Japan but this reflects confusion with the morphologically similar genus *Puposyrnola* Cossmann, 1921. All species that are correctly referred to *Nesiodostomia* are part of Recent faunas of the Hawaiian Islands.

**Odostomidea** Pilsbry and Johnson, 1917

*Type Species* – By monotypy, *Odostomia* (*Odostomidea*) *bartschiana* Pilsbry and Johnson, 1917, p. 182.

*Odostomidea* Pilsbry and Johnson was proposed as a subgenus of *Odostomia* Fleming, 1813, but there are few similarities between the two taxa. Species of *Odostomia* lack sculpture while species of *Odostomidea* are highly sculptured. In *Odostomia*, the nuclear whorls are generally deeply immersed in the first teleoconch whorl while they are about half immersed in *Odostomidea*. The tabulate shoulder of *Odostomidea* contrasts markedly with the smoothly convex whorl profile of *Odostomia*. The two taxa seem generically distinct.

Two species have been referred to *Odostomidea* Pilsbry and Johnson: *Odostomia* (*Odostomidea*) *bartschiana* Pilsbry and Johnson (1917, p. 152, illustrated by Pilsbry, 1922, pl. 36, fig. 15) and *O.* (*O.*) *mogindo* Pilsbry (1922, p. 393, pl. 36, fig. 6). Both were described from the Oligocene of Hispanola and both bear a strong resemblance to Recent species that have been referred to *Salassia* Folin, 1872, *Eupyrargulina* Melvill, 1910, and *Odostomella* Bocquoy, Dautzenberg, and Dollfus, 1883. A survey of the literature suggests that all of these nominal genera need both taxonomic and nomenclatural review. Until a comprehensive study is completed, it

does not seem possible to evaluate *Odostomia* Pilsbry and Johnson, 1917.

## REFERENCES CITED

- Clench, W. J., and Turner, R. D. 1962, New names introduced by H. A. Pilsbry in the Mollusca and Crustacea: Acad. Nat. Sci. Philadelphia, Spec. Pap. 4. 218 pp.
- Corgan, J. X. 1971, Review of *Parodostomia*, *Telloda*, *Goniodostomia*, and *Eulimastoma* (Gastropoda: Pyramidellacea): The Nautilus 85, p. 51-60.
- Corgan, J. X. 1972, Pacific species of *Nesiodostomia* Pilsbry, 1918, and *Puposyrnola* Cossmann, 1921 (Gastropoda: Pyramidellacea): The Veliger 14 p., 355-360.
- Dall, W. H., and Bartsch, P., 1909, A monograph of the West American pyramidellid mollusks: U. S. Nat. Mus. Bull. 68. 358 pp. 30 pls.
- Laws, C. R., 1937, Review of the Tertiary and Recent Neozelanic pyramidellid molluscs. No. 1. The genus *Turbonilla*: Trans. Royal Soc. New Zealand 66, p. 402-422, pls. 32-33.
- Pilsbry, H. A., 1918, Marine Mollusca of Hawaii, IV-VII: Proc. Acad. Nat. Sci. Philadelphia 69 p. 309-333, pls. 20-22.
- Pilsbry, H. A., 1922, Revision of W.M. Gabb's Tertiary Mollusca of Santo Domingo: Proc. Acad. Nat. Sci. Philadelphia 73 p. 305-435, pls. 16-47.
- Pilsbry, H. A. and Johnson, C. W., 1917, New Mollusca from the Santo Domingo Oligocene: Proc. Acad. Nat. Sci. Philadelphia 69 p. 150-205.

●

OBSERVATIONS ON THE SIPHONAL  
BEHAVIOR OF YOUNG SURF CLAMS,  
*SPISULA SOLIDISSIMA*

Morris K. Jacobson

American Museum of Natural History  
Central Park West at 79th Street, New York 10024

Not many observations on the siphonal behavior of the surf clam, *Spisula solidissima* (Dillwyn), in nature appear in the literature. The following account of such an observation made in Rockaway Beach, New York may therefore prove to be of interest.

During the September 1971 ebb tides, the sandy area inhabited by large numbers of immature surf clams was uncovered for a few hours each day. The clams measured from about 40 to 80 mm (1½ to

about 3 inches) in length. Dense patches of clams were scattered throughout the sandy substrate. The small openings of the siphons at the surface of the sand were the only part of the clam that was visible. Morse (1919:188) described these siphon openings. He found 28 small papillae on the lip of the anal (dorsal or excurrent) siphon, but they were not readily visible under field conditions, and the opening appeared as a small, rather narrow oval with apparently smooth edges. The opening of the branchial (ventral or incurrent) siphon was twice the width of the anal siphon and was much distorted by "two excessively stout papillae springing from the wall in the conjunction with the anal syphon. They are curved outward half-way across the opening. One of these is bifurcated." (Morse, l.c.). The 33 irregularly alternating long and short papillae fringed the outer margin and were clearly seen. Frequently both siphons were visible, but when only one appeared, it was almost always the opening of the dorsal siphon.

During the short inter-wave periods, when the sand was not being roiled by the wave action, the siphon openings were exposed. As a wave flowed in carrying a thick suspension of sand grains, the siphon openings closed and the presence of the animal was not detectable for a moment. In the short interval when the upsweeping wave came to a brief halt, the sand in suspension sank rapidly to the bottom and simultaneously the siphon openings appeared. As the water receded, sand grains were again placed in

suspension and the openings again disappeared. As the sand swiftly settled, the siphons opened again and remained open until the next onrush of water. Apparently the film of water remaining on the sand surface before the next flow of water was sufficient to enable the mollusk to continue its feeding and elimination activities.

At more or less regular intervals a small jet of water, thickly laden with sand grains, was ejected from the ventral siphon. This behavior was typical of clams inhabiting the active wash zone. As the tide came in, observations had to come to an end, but it can be assumed that in areas covered by the tide and not within the wash zone, the surf clams kept both siphons open constantly during its feeding periods.

The type of siphonal activity described for *Spisula* is apparently a defensive adaptation to minimize the ingestion of sand particles. Any sand taken in is probably stored briefly in the branchial siphon and expelled at certain intervals. It was surprising to note that the anal siphon was open more often than the branchial or feeding siphon.

This manuscript was kindly reviewed by Dr. William K. Emerson of the American Museum and Dr. John Ropes of the National Fisheries Service, Oxford, Maryland.

#### LITERATURE CITED

- Morse, E. S. 1919. Observations on living lamellibranchs of New England. Proc. Boston Soc. Nat. Hist. 35 (5): 139-196.

#### Dates of Publication of *The Nautilus*

- Volume 85, number 1: July 20, 1971  
 Volume 85, number 2: October 4, 1971  
 Volume 85, number 3: January 27, 1972  
 Volume 85, number 4: April 28, 1972

## INFORMATION FOR SUBSCRIBERS

The *annual subscription* rate for *The Nautilus* is \$7.00 for individuals and \$12.00 for institutions (domestic or foreign). Subscriptions may begin either in January or, preferably, in July when a new volume begins. Send check or money order to "The Nautilus" to Mrs. Horace B. Baker, Business Manager, 11 Chelton Road, Havertown, Pa. 19083.

*Back issues* from volume 72 to date are obtainable from the Business Manager. Volumes 1 through 71 (if available) may be obtained in reprint or original form from Kraus Periodicals, Inc., 16 East 46th Street, New York, N.Y. 10017.

*Advertising rates* may be obtained from the Business Manager or Editor.

## CONTRIBUTORS

*Manuscripts:* Authors are requested to follow the recommendations of the *Style Manual for Biological Journals*, which may be purchased from the American Institute of Biological Sciences, 2000 "P" Street, N.W. Washington, D.C. 20036. Manuscripts should be typewritten and double-spaced; original and one copy are required, to facilitate reviews. Tables, numbered in arabic, should be on separate pages, with the title at the top. Legends to photographs should be typed on separate sheets. Explanatory terms and symbols within a drawing should be neatly printed, or they may be pencilled in on a translucent overlay, so that

the printer may set them in 8 pt. type. There is a charge of 50 cents per word for this extra service. All authors or their institutions will be charged 50 cents per line of tabular material and taxonomic keys. The publishers reserve the right, seldom exercised, to charge \$32 per printed page.

An *abstract* should accompany each paper.

*Reprints* and covers are available at cost to authors. When proof is returned to authors, information about ordering reprints will be given. They are obtained from the Economy Printing Co., Inc., R. D. 3, Box 169, Easton, Maryland 21601.

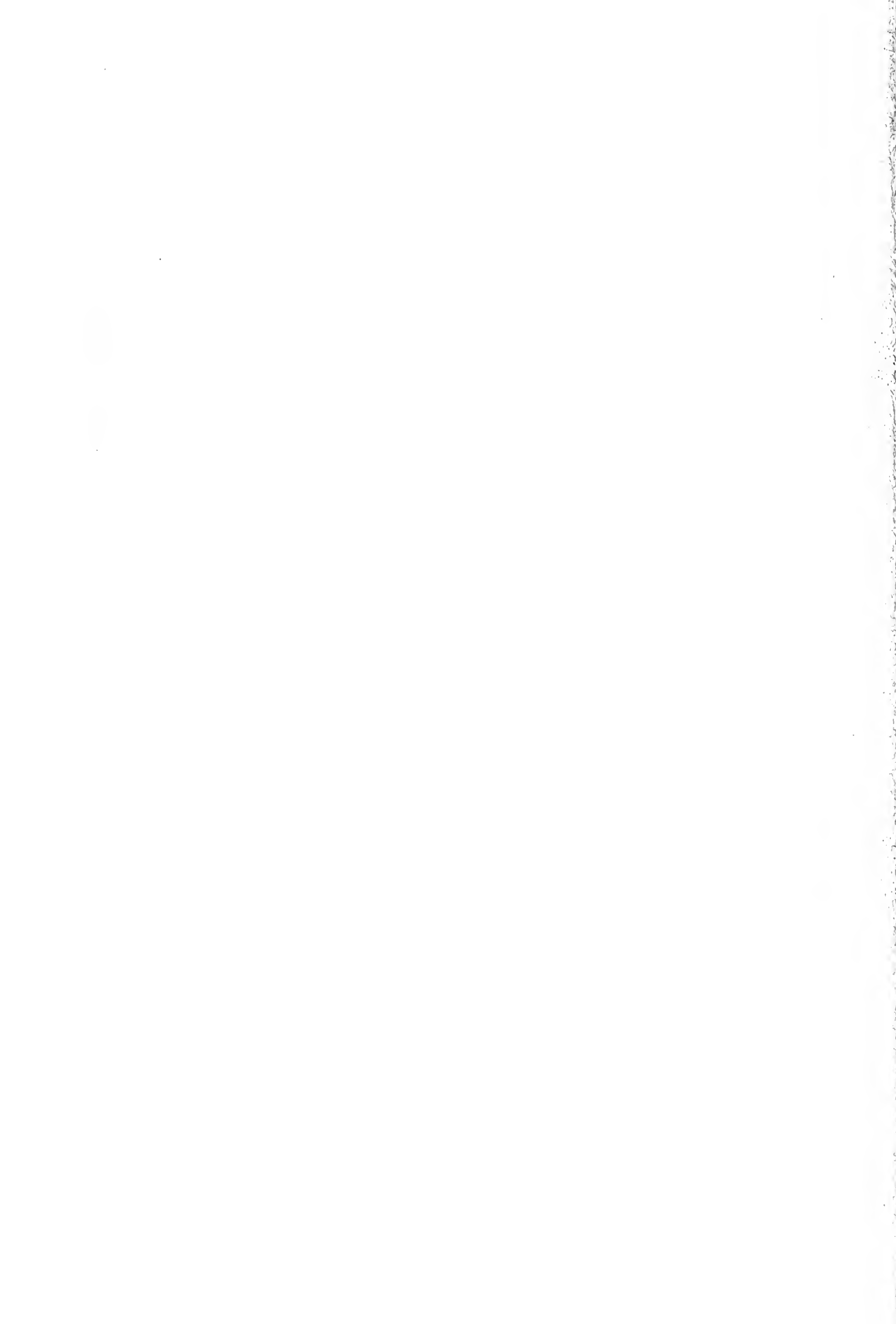

NOVEMBER, 1972

# THE NAUTILUS

Vol. 86

Nos. 2 - 4

A quarterly  
devoted to  
malacology and  
the interests of  
conchologists

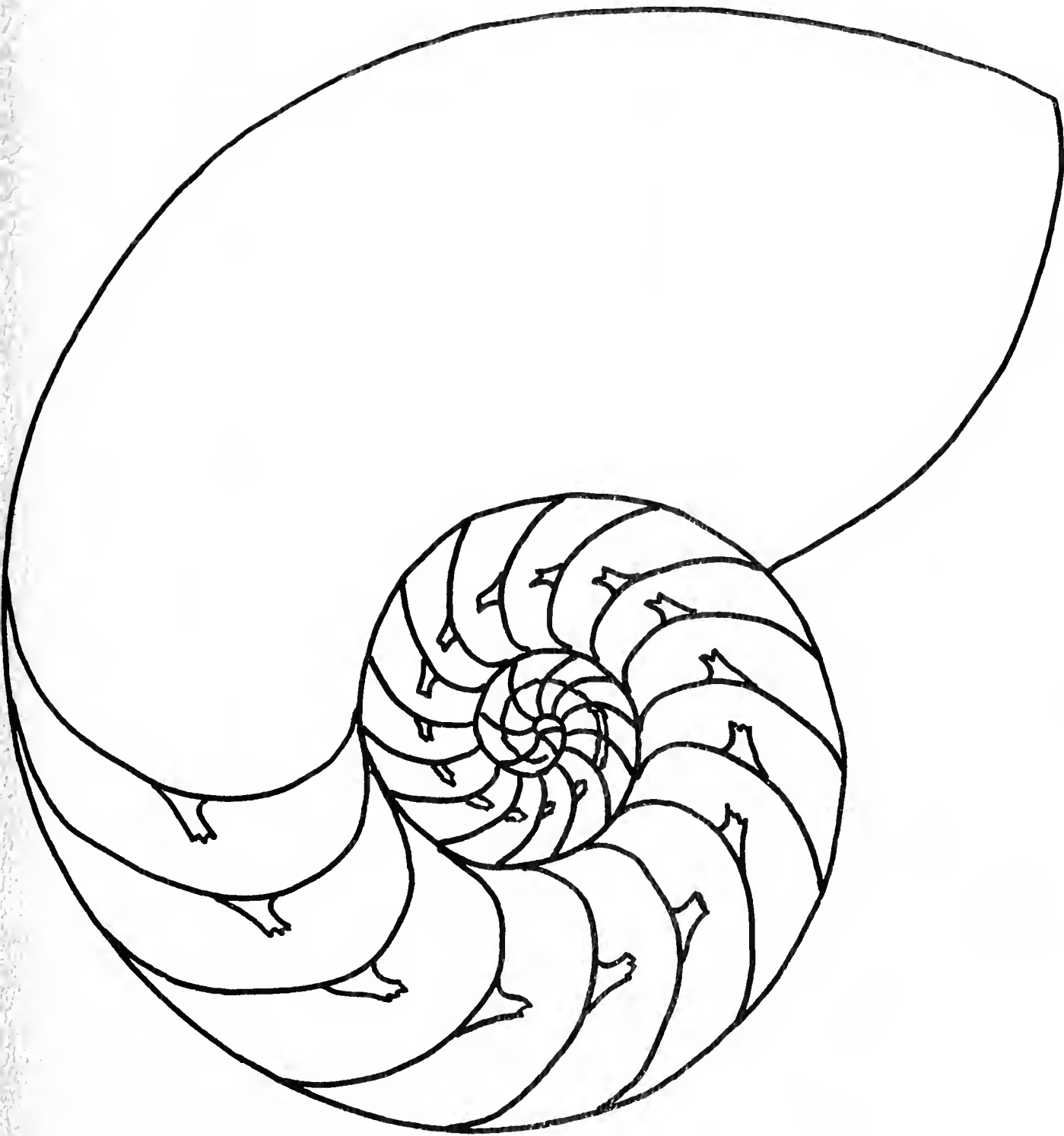

Founded 1889 by Henry A. Pilsbry. Continued by H. Burrington Baker.  
Editors: *R. Tucker Abbott and Charles B. Wurtz*

## EDITORIAL COMMITTEE

### CONSULTING EDITORS

Dr. Arthur H. Clarke, Jr.  
Department of Mollusks  
National Museum of Canada  
Ottawa, Ontario, Canada K1A-OM8

Dr. William J. Clench  
Curator Emeritus  
Museum of Comparative Zoology  
Cambridge, Mass. 02138

Dr. William K. Emerson  
Department of Living Invertebrates  
The American Museum of Natural History  
New York, New York 10024

Mr. Morris K. Jacobson  
Department of Living Invertebrates  
The American Museum of Natural History  
New York, New York 10024

Dr. Aurèle La Rocque  
Department of Geology  
The Ohio State University  
Columbus, Ohio 43210

Dr. James H. McLean  
Los Angeles County Museum of Natural History  
900 Exposition Boulevard  
Los Angeles, California 90007

Dr. Arthur S. Merrill  
Biological Laboratory  
National Marine Fisheries Service  
Oxford, Maryland 21654

Dr. Donald R. Moore  
Division of Marine Geology  
School of Marine and Atmospheric Science  
10 Rickenbacker Causeway  
Miami, Florida 33149

Dr. Joseph Rosewater  
Division of Mollusks  
U. S. National Museum  
Washington, D.C. 20560

Dr. G. Alan Solem  
Department of Invertebrates  
Field Museum of Natural History  
Chicago, Illinois 60605

Dr. David H. Stansbery  
Museum of Zoology  
The Ohio State University  
Columbus, Ohio 43210

Dr. Ruth D. Turner  
Department of Mollusks  
Museum of Comparative Zoology  
Cambridge, Mass. 02138

Dr. Gilbert L. Voss  
Division of Biology  
School of Marine and Atmospheric Science  
10 Rickenbacker Causeway  
Miami, Florida 33149

### EDITORS

Dr. R. Tucker Abbott  
Delaware Museum of Natural History  
Box 3937, Greenville, Delaware 19807

Dr. Charles B. Wurtz  
3220 Penn Street  
Philadelphia, Pennsylvania 19129

Mrs. Horace B. Baker  
Business and Subscription Manager  
11 Chelton Road  
Havertown, Pennsylvania 19083

### OFFICE OF PUBLICATION

Delaware Museum of Natural History  
Kennett Pike, Route 52  
Box 3937, Greenville, Delaware 19807

**CONTENTS**

**Hal Lewis**

Notes on the Genus *Distorsio* (Cymatiidae) with Descriptions of New Species .....27

**Tadashige Habe**

Notes on the Genus *Parancistrolepis* Azuma (Buccinidae) .....51

**Gale G. Sphon**

*Berthella kaniae*, a New Opisthobranch from the Eastern Pacific .....53

**E. P. Cheatum**

A New Species of *Humboldtiana* (Helminthoglyptidae) from the Sierra Vieja Mountains of Texas .....56

**Winston F. Ponder and Gilbert P. Whitley**

Tom Iredale (1880-1972) [an obituary] .....60

**Ronald F. Thomas and Frazier O. Bingham**

Shell Structure in *Spirula spirula* (Cephalopoda) .....63

**Joseph Rosewater and Geerat J. Vermeij**

The Amphi-Atlantic Distribution of *Littorina meleagris* .....67

**Joseph Rosewater**

Teratological *Littorina scabra angulifera* .....70

**Samuel L. H. Fuller**

Type Locality of *Unio pumilus* Lea, 1838 (Unionidae) .....72

**Samuel L. H. Fuller**

*Unio caroliniana* Bosc, 1801 (Unionidae) .....74

**Marc J. Imlay**

Greater Adaptability of Freshwater Mussels to Natural Rather than to Artificial Displacement .....76

(continued over)

|  |    |
|--|----|
| <b>Barry Roth and Richard E. Petit</b>   |    |
| A New Species of <i>Persicula</i> from the Arabian Sea (Marginellidae) . . . . .   | 80 |
| <b>Horace G. Richards</b>  |    |
| Quaternary Mollusks from Fiji . . . . .  | 81 |
| <b>Henk K. Mienis</b>  |    |
| On the Alleged Occurrence of <i>Lambis violacea</i> and <i>Clithon coronata</i> in Indonesia . . . . .                       | 82 |
| <b>Tadashige Habe and Kiyoshi Ito</b>  |    |
| <i>Ancistrolepis kawamurai</i> , a New Japanese Buccinidae . . . . .   | 83 |
| <b>Samuel L. H. Fuller</b>   |    |
| An Underscribed Structural Feature in the Marsupium of <i>Elliptio lanceolata</i> (Lea, 1828)(Unionidae) . . . .             | 85 |
| <b>Derek S. Davis</b>  |    |
| An Unusual Form of <i>Littorina littorea</i> (Linné) Found in Nova Scotia . . . . .  | 87 |
| <b>News</b>  |    |
| <b>Book Reviews</b>  |    |
| (of) R. T. Abbott, 50; B. R. Wilson and K. Gillett, 59; M. Furlong and V. Pill, 66; L. G. Hertlein and U. S. Grant, 4th, 71. |    |

## NOTICE TO SUBSCRIBERS

In order to have a new volume of *The Nautilus* begin in January, rather than July, we have issued the remainder of volume 86 in a combined issue of nos. 2, 3, and 4. For further information on billing, see p. 82.



NOTES ON THE GENUS *DISTORSIO* (CYMATHIDAE) WITH  
DESCRIPTIONS OF NEW SPECIES

Hal Lewis

Research Associate, Dept. Malacology  
Academy of Natural Sciences of Philadelphia  
Philadelphia, Pa. 19103

ABSTRACT

*Distorsio perdistorta* Fulton, 1938, whose known distribution has previously been limited to Japanese waters, has been discovered in the Gulf of Mexico, the Lesser Antilles, and the Indian Ocean. *Distorsio horrida* Kuroda and Habe, 1964, also originally limited to Japanese waters, is a synonym. A different species from Japan, misidentified by previous workers as "perdistorta," is described as a new subspecies, *Distorsio constricta* habei Lewis. The American tertiary progenitors of this species are believed to be *D. crassidens* (Conrad, 1848) of the Oligocene and *D. simillimus* (Sowerby, 1850) of the Miocene. The living species *D. constricta* is recognized as having three geographical subspecies - *constricta* (Broderip, 1833) from the tropical Eastern Pacific; *macgintyi* Emerson and Puffer, 1953, from the Western Atlantic; and *habei*, new subspecies from Japan. Similar subspecific distributions are known among the Cymatiidae, Cassidae and Volutidae.

An unusual periostracal structure is described and illustrated along with various anatomical features of *Distorsio*.

*Distorsio burgessi* is described as a new species from Hawaii which is sympatric with *Distorsio anus* (Linné).

The lectotype of *Distorsio ridens* Reeve is figured and *D. ridens* is clearly separated from *D. reticulata* Röding, *D. perdistorta* Fulton, and *D. decussatus* Valenciennes.

INTRODUCTION

While examining shells in the collection of Mr. and Mrs. Riley Black of Fort Myers, Florida, three specimens of a *Distorsio* were brought to my attention. These matched a specimen first sent to me by Mrs. Elsie Malone of Sanibel, Florida, which had been misidentified as *Distorsio macgintyi* Emerson and Puffer, 1953. Surprisingly, these specimens proved to be indistinguishable from *Distorsio perdistorta* Fulton, 1938, a species living in Japanese waters which had been renamed *Distorsio horrida* by Kuroda and Habe in 1964. Unfortunately they also misidentified another taxon known as "*Distorsio perdistorta*" Kuroda and Habe, 1964, (not Fulton, 1938), which now requires a new name.

This paper will confirm *Distorsio perdistorta* Fulton as a valid species; substantiate its occurrence in the Western Atlantic and the Indian Ocean; clarify its history in the literature; differentiate it from *Dis-*

*torsio clathrata* (Lamarck, 1816) and *Distorsio macgintyi* Emerson and Puffer, 1953, in the Western Atlantic; and describe the taxon previously known as "*Distorsio perdistorta*" Kuroda and Habe, 1964.

HISTORICAL DISCUSSION OF  
*DISTORSIO PERDISTORTA*

Emerson and Puffer, 1953, in their catalogue of the *Distorsio* suggested the possibility that *perdistorta* is a geographical subspecies of *Distorsio reticulata* Röding, 1798, and said, "Fulton states that this species possesses affinities with *D. ridens* (Reeve, 1844)" which they considered to be a "variant of *D. reticulata* 'Bolten' Röding, 1798."

An examination of *reticulata* and *perdistorta* has shown that there are consistent taxonomic differences. Table 3 was prepared to facilitate a comparison using characters which are helpful in separating *Distorsio*. The list of differences cited in Table 3 and the

specific description of *perdistorta* contained in this paper demonstrates that these are separate species.

Actually, Fulton (1938, p. 56) listed various characters which "separates this from *ridens* Reeve." They are "the shorter anterior canal and the much closer granular or reticulate spiral sculpture . . .; the line of numerous small plaits on the anterior part of the columella is perpendicular not oblique as in *ridens*." Examination of the lectotype, syntypes and

Reeve's figure shows that *ridens* is clearly separable from *perdistorta*. *D. ridens* is regularly fusiform, while *perdistorta* is grossly distorted. There are 25 to 30 axial ribs on the body whorl of *perdistorta* and only 12 on *ridens*, giving it a much more open sculpture.

The spiral cords of *perdistorta* are separated by a fine interstitial cord which is lacking in *ridens*. The parietal shield of *ridens* is medium-oval in shape with

TABLE 1. Specimens of *Distortio perdistorta* examined from the Gulf of Mexico.

| Length<br>(mm) | Width<br>(mm) | Locality                         | Depth<br>(meters) |
|----------------|---------------|----------------------------------|-------------------|
| 82             | 44            | Tampa, Florida                   |                   |
| 81             | 45            | West of Fort Myers, Florida      | 183               |
| 79             | 43            | West of Tampa, Florida           | 201               |
| 77             | 42            |                                  |                   |
| 78             | 40            | E.S.E. of Key West, Florida      | 274.50            |
| 67             | 36            |                                  |                   |
| 66             | 35            |                                  |                   |
| 64             | 36.5          |                                  |                   |
| 59             | 32            |                                  |                   |
| 36.5           | 21.5          |                                  |                   |
| 75             | 42            | 110 miles S. W. Egmont Key, Fla. | 155-183           |
| 69             | 38            | W.S.W. Tampa, Florida            | 192               |
| 66             | 36            | West of Fort Myers, Florida      | 183               |
| 57             | 32            | West of Sarasota, Florida        | 174               |

The "Blake" Caribbean Exploration 1878-79, USNM

|      |      |                              |       |
|------|------|------------------------------|-------|
| 20   | 12.5 | Sta. 157                     | 219   |
| 19   | 12.5 | 120 fms. off Montserrat      |       |
| 26.5 | 19   | Sta. 282                     | 282   |
| 19   | 11.5 | 154 fms. sand, near Barbados |       |
| 13   | 7    | Barbados                     | 183   |
| 25.5 | 15.5 | Barbados                     | 133.5 |
| 30   | 18   |                              |       |
| 40   | 28   | St. Vincent                  | 208.6 |
| 37   | 25   | Barbados                     | 172   |

broken  
canal

| Length<br>(mm) | Width<br>(mm) | Locality                      | Depth<br>(meters) |
|----------------|---------------|-------------------------------|-------------------|
| <i>Japan:</i>  |               |                               |                   |
| 72             | 40            | Tosa, Shikoku, Japan          | 183               |
| 64             | 35            |                               |                   |
| 63             | 35            |                               |                   |
| 61             | 35            |                               |                   |
| 46.5           | 26            |                               |                   |
| 40             | 22            |                               |                   |
| 63             | 33            | Tosa, Shikoku, Japan          | 110               |
| 56             | 32            |                               |                   |
| 71             | 36            | Tosa, Shikoku, Japan          | 110               |
| 71             | 38            | Tosa, Shikoku, Japan          | 125               |
| 60             | 37            | Sagami Bay, off Honshu, Japan |                   |
| 52.5           | 29            |                               |                   |
| 67             | 35            | Kii, Honshu, Japan            |                   |
| 62             | 37            |                               |                   |
| 54.5           | 30            | Wakayama, Honshu, Japan       |                   |
| 56             | 32            |                               |                   |

*Madagascar:*

|      |      |                                     |         |
|------|------|-------------------------------------|---------|
| 60   | 34   | P2. Chalutage 10<br>12°43'S-48°15'E | 300-340 |
| 43.5 | 20.5 |                                     |         |

very coarse plicae along the columellar edge which curve posteriorly away from the aperture past the axis of the shell. The shield of *perdistorta* is more oblong with finer teeth on the columellar edge which are more or less in a straight line which ends at the axis of the shell. (See Table 3 for a comparison between *perdistorta*, *ridens*, and *reticulata*).

Until now, Western Atlantic specimens of *perdistorta* have been so rarely collected that they have failed to come to the attention of those who have worked with this genus. In 1951, Axel Olsson and Thomas L. McGinty described *Distorsio constricta floridana* as a subspecies of the Panamic *Distorsio constricta* Broderip 1833. Unfortunately, the name had previously been used by Gardner (1947, p. 535, pl. 53, fig. 8) for *Personella floridana* and it was necessary for Emerson and Puffer (1953, p. 101) to rename it *Distorsio mcgintyi*. The spelling is here emended to *mcgintyi* to conform with the recommendations on the formation of names in Appendix D of the 1961 Code. Among the material with which

Olsson and McGinty dealt were the *Distorsio* collected by the Blake expedition in the Gulf of Mexico, 1877-78 and in the Caribbean, 1879-80. While discussing the *Distorsio* in his well-known "Blake Report", Dall (1889, p. 221) referred to Link's (1807, p. 123) list which limited the genus to two living species. Dall stated that these were "the two species and only two species of which it is composed, even at the present day." While not mentioned by Dall, one of these species was *Distorsio anus* (Linné, 1758), the type for the genus, and the other was listed and discussed by him as *Distortrix reticulata* Link, 1807, which is *Distortio reticulata* Röding, 1798. Dall divided *reticulata* into "variety *reticulata*" and "variety *clathrata*" and considered it to be the only species in the Western Atlantic. Curiously, the taxon that Dall considered to be "variety *clathrata*" is the subspecies now known as *D. constricta mcgintyi*, while what he regarded as "variety *reticulata*" is actually *Distorsio clathrata* (Lamarck, 1816).

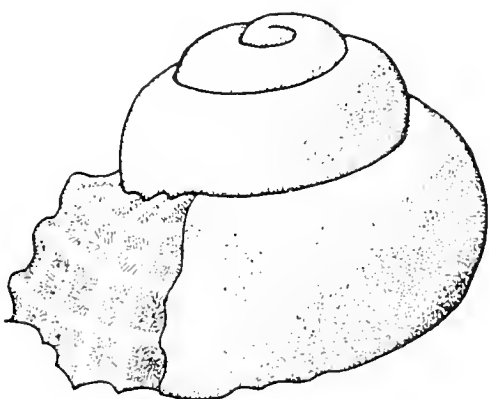

Fig. 1, Protoconch of *Distorsio perdistorta*, Academy of Natural Sciences of Philadelphia, 241660, 100 fms. Tosa, Japan, height 2 mm.

The history and synonymy of *D. reticulata* Roding was discussed and clarified by Puffer (1953, p. 113). The distribution of *reticulata* and *amus* is limited to the Indo-Pacific.

Emerson and Puffer, 1953, and Clench and Turner, 1957, limited the living species in the Western Atlantic to *Distorsio clathrata* and *Distorsio macgintyi*. Neither Dall nor later authors realized that the "Blake" expedition had actually collected a third and different species. I found seven specimens of this species (four from the dry collection and three from the alcohol collection) in the USNM. Some of these proved to be the actual specimens listed by Dall as

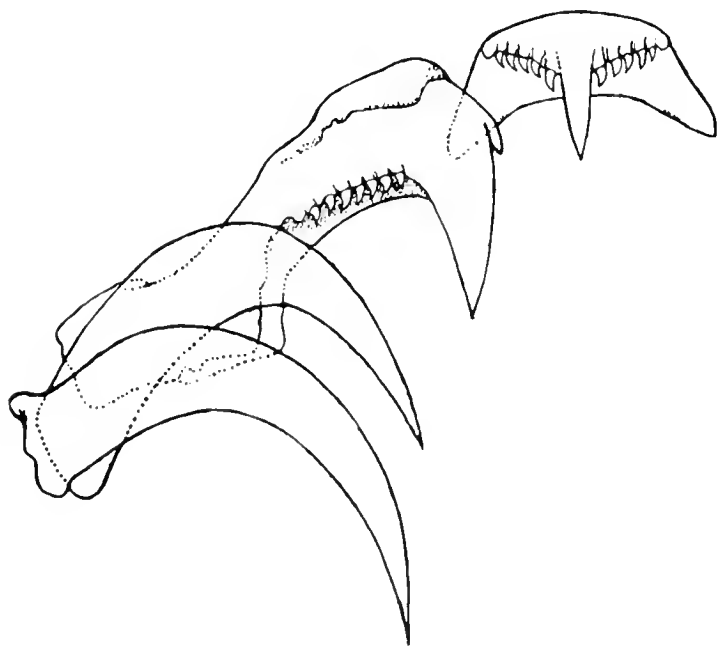

Fig. 2, Radula of *Distorsio perdistorta* Fulton, 105 fms, WSW Tampa, Fla., width of rachidian: 120 $\mu$ .

"*Distortrix reticulata*" Link and were still labeled as such. They match the holotype, and other specimens of *Distorsio perdistorta* recently collected in the Western Atlantic in every detail, including penis, periostracum and operculum, although the shells are smaller in size.

Examination of the literature of fossil mollusca has failed to reveal any record of an ancestor of *Distorsio perdistorta* in the Western Atlantic although there is ample evidence of the ancestors of *Distorsio clathrata* and *Distorsio macgintyi*. A special effort was made to investigate the possibility that a Panamic species, such as *Distorsio decussata* (Valenciennes, 1832), could prove to be a Panamic analog of *Distorsio perdistorta* in either Recent or fossil form. Woodring, (1928, p. 495, pl. 18, figs. 7, 8, 9) illustrates a mixture of species which he misidentifies as "*Distorsio decussatus simillimus* (Sowerby, 1850)". Figures 7 and 8 are actually *Distorsio gatunensis* Toulou, 1909, the fossil subspecies of *Distorsio decussata*. Figure 9 is *Distorsio simillima*, the fossil subspecies of *constricta*. The differences between *perdistorta* and the living and fossil forms of *decussata* suggest that a close relationship between the two species is unlikely, in spite of their relatively close distribution. This seems especially borne out when one observes the great similarity of Western Atlantic, Japanese, and Indian Ocean specimens, in spite of their extreme geographical separation.

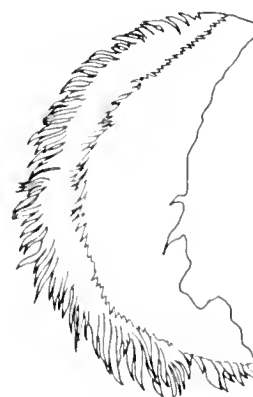

Fig. 3, Left jaw of *Distorsio perdistorta* Fulton, Gulf of Mexico, length: .75 mm.

TABLE 2. *Specimens of Distorsio constricta habei Lewis, new subspecies, examined.*

| Length<br>(mm) | Width<br>(mm) | Locality                 | Depth<br>(meters) |
|----------------|---------------|--------------------------|-------------------|
| 53             | 28            | Tosa Bay, Shikoku, Japan |                   |
| 54             | 29            | Tosa Bay, Shikoku, Japan |                   |
| 51             | 30            |                          |                   |
| 51             | 27            |                          |                   |
| 45             | 26            |                          |                   |
| 41             | 22            |                          |                   |
| 53             | 28            | Kii, Honshu, Japan       |                   |
| 45             | 25            | Tosa, Shikoku, Japan     | 128               |
| 42             | 22            |                          |                   |
| 54             | 31.5          | Tosa, Shikoku, Japan     | 128               |

TABLE 3. *Comparison of Distorsio perdistorta, Distorsio reticulata, and Distorsio ridens.*

|                                  | <i>perdistorta</i>  | <i>reticulata</i>  | <i>ridens</i>   |
|----------------------------------|---|--|---|
| color of shell                   | white; cords can be orange-brown                                      | diffused tan; cords can be lighter                                   | white; some color on axial ribs                                       |
| shape of whorls                  | rounded, very swollen and distorted                                   | tabled whorls above angled periphery                                 | rounded; shell is fusiform  |
| axial ribs on body whorls        | 25 - 30   | 16 - 20  | 13  |
| plicae at columellar edge        | fine, usually formed in straight line                                 | fine, usually formed in straight line                                | gross, recurve posteriorly away from aperture                         |
| shape of parietal shield         | oblong  | triangular to rounded oval   | medium oval   |
| color of shield                  | white or stained orange-brown on parietal area                        | solid dark tan to pink with white plicae                             | orange-brown with white apertural edge; to white                      |
| sculpture of shield              | smooth to low coarse beading  | fine beading formed by ribs and cords under shield                   | strong coarse beads, axially aligned                                  |
| plicae at posterior canal        | absent or very small  | 2 large strongly formed plicae                                       | 2 large strongly formed plicae  |
| shape of aperture                | constricted; third tooth on inner edge of outer lip is very prominent | more open; third tooth on inner edge of outer lip is slightly larger | constricted; third tooth on inner edge of outer lip is very prominent |
| teeth at inner edge of outer lip | 9 to 10 large; first tooth below posterior canal is usually double    | 8 to 9 large   | 6 to 7 large; 3 very small  |

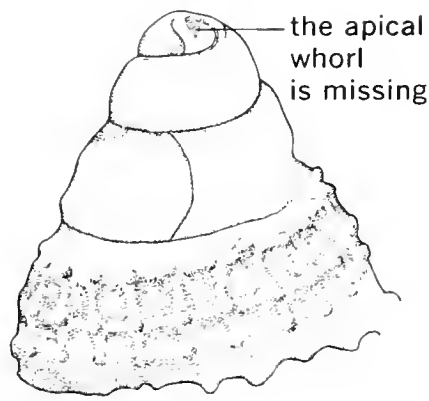

Fig. 4, Protoconch of *Distorsio constricta habei* Lewis, height of protoconch: 1.8 mm.

### Genus *Distorsio* Röding, 1798

*Distorsio* Röding, 1798, Museum Boltenianum, pt. 2, p. 133. Type species, *Murex anus* Linné, 1758, subsequent designation J. E. Gray, 1847. (The Latin noun *distortio* is feminine).

*Description* - Shells range in length from 25 to 90 mm. They are strongly sculptured with spiral cords and axial ribs which can make them knobby or cancellated. The whorls are swollen and distorted because they bulge in order to accommodate the growing animal as it covers earlier whorls. There is a large parietal shield which joins with an expanded peristome to encircle the aperture. When partially covered by new growth, the old parietal shields serve as varices. The distorted whorls, parietal plicae and grossly-formed denticles on the inner edge of the outer lip, create a very irregular aperture. The shield has a groove and numerous irregular plicae on the lower left. A short anterior siphonal canal usually turns upwards.

Fig. 5, Operculum of *Distorsio perdistorta* Fulton, dredged WSW Tampa, Fla., 105 fms., height 9 mm.

Fig. 6, Operculum of *Distorsio perdistorta* Fulton, Academy of Natural Sciences of Philadelphia, 241652, Tosa, Japan, height 7 mm.

Fig. 7, Operculum of *Distorsio perdistorta* Fulton, Academy of Natural Sciences of Philadelphia, 241652, Japan, height 6.9 mm.

The radula is taenioglossate. It is situated in the tip of an extremely long proboscis which lies folded in the proboscis sheath (figs. 14 to 22). The proboscis is capable of tremendous extension. This is typical of the genus and quite different from the typical cymatiid pleurembolic proboscis. In species which have been examined, the jaws are small, transparent, and not as strongly formed as in most genera of Cymatiidae.

### OPERCULA

Previous workers have suggested that the pattern of the opercula of *Distorsio* varies intraspecifically between terminal (without a nucleus) and submarginal (with a nucleus). Personal observation of numerous broken and repaired opercula has indicated that there is a high incidence of breakage and repair. This is probably due to the difficulty of passing the operculum through the extreme constriction of the aperture. It is interesting to note that all of the opercula of *Distorsio* which show clear evidence of repair have a nucleus. Missing opercula are replaced by newly formed ones, which also always have a nucleus. I have observed this characteristic change in pattern from terminal (a-nuclear) to nuclear in the repaired opercula of other genera of Cymatiidae such as *Cymatium* s.s., *Gyrineum* and *Monoplex*. Often the growth rings depart from the semicircular arc which is typical of the original terminal pattern. Furthermore, the specimens which have remained terminal are usually consistent in size and shape, while the nucleated opercula vary considerably. When dealing with perfect specimens of the opercula of *Distorsio*, the primary muscle scar pattern and the shape delineated by the varnish can prove to be a valuable taxonomic character.

*Distribution* - Species of *Distorsio* are found in most tropical portions of the world to a depth of 300

Fig. 8, Operculum of *Distorsio clathrata* Lamarck, 140 ft. S.W. Cape San Blas, Florida, 1969, height 5 mm.

Fig. 9, Operculum of *Distorsio constricta* macgintyi Emerson & Puffer, South of Loggerhead Lt., Tortugas, Fla., 25 fms., height 7.8 mm.

Fig. 10, Operculum of *Distorsio habei* Lewis, Academy of Natural Sciences of Philadelphia, 189639, Tosa Bay, Japan, 70 fms., height 6 mm.

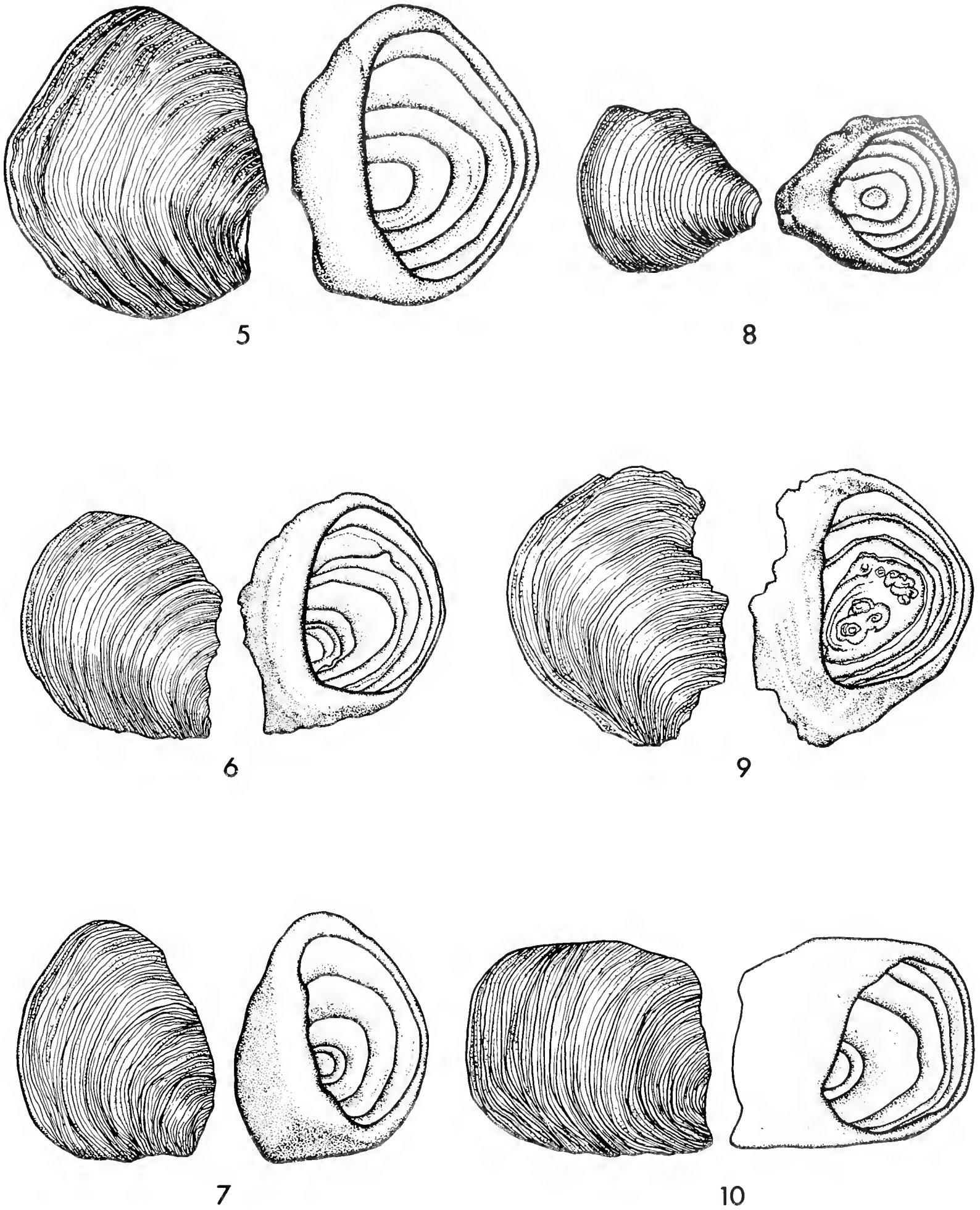

Fig. 5-10, Explanation on opposite page.

fathoms. The earliest American fossils of the subgenus *Personella* appear to be from the Middle Eocene, while the earliest *Distorsio* s.s. appears to be *Distorsio crassidens* (Conrad, 1848), from the Oligocene of Vicksburg, Mississippi

#### REMARKS ON THE SUBGENERA

Subgenus *Rhysema* Clench. Wm. J. and Turner, Ruth D. 1957, *Johnsonia*, vol. 3, no. 36, p. 236. Type species *clathratus* Lamarck, 1816, by original designation.

When Clench and Turner, 1957, described the subgenus *Rhysema*, they differentiated it from *Distorsio* s.s. on the basis of two characters. They pointed out that *Distorsio anus*, the type for *Distorsio* s.s., had a parietal shield which "extends well above the upper limits of the outer lip and covers the preceding two whorls" and a siphonal canal which is "nearly vertical." This limited *Distorsio* s.s. to one species and all other living species were then considered to be in the subgenus *Rhysema*. Up to the present day, there has been no additional evidence to justify two subgenera. It is true that the various species which comprise *Rhysema*, do not have a parietal shield which covers two preceding whorls, but the shield often covers one preceding whorl and quite often exceeds the upper limits of the outer lip. Furthermore, there are many specimens of various species whose siphonal canals are very recurved, although not vertical. These characters appear to be based upon differences of relative degree. While they might be considered valid when separating species, they do not appear to define separate subgenera. A new species is described later in this paper which is very similar to *Distorsio anus*. Because of this similarity most workers would agree that it is properly placed in *Distorsio* s.s. The definition of *Rhysema* would require placing it in *Rhysema* since its parietal shield does not exceed the two preceding whorls and its siphonal canal is not vertical. This example alone demonstrates the difficulty one would have in attempting to place the various species of *Distorsio* into separate subgenera based on these characters.

As an added example, *Distorsio clathrata* differs as much from *Distorsio macgintyi* as does *Distorsio anus* from either one. *Distorsio anus* is often considered a shallow water species but living specimens have been found in 45 meters. While the various species of

*Rhysema* are considered to be from deep water, some species have been found living intertidally. Until more evidence becomes available, it seems unnecessary to retain two subgenera which are so weakly differentiated. Consequently, I consider *Rhysema* to be a synonym of *Distorsio*.

#### *Distorsio perdistorta* Fulton, 1938

Figs. 1, 3, 5-7, 11-34

#### Synonymy -

1938 *Distorsio perdistorta* Fulton, Proceedings of the Malacological Society of London, (March 16), vol. 23, pt. 1, pp. 55-56, pl. 13, figs. 3 and 3a. Type locality; Kii, Japan. Type in the British Museum of Natural History.

1964 *Distorsio (Rhysema) horrida* Kuroda and Habe, Shells of the Western Pacific in Color, vol. 2, p. 74, pl. 23, figs. 3 and 3 (both figures numbered 3). Type locality; Tosa Bay, Shikoku, Japan. Type in the National Science Museum, Tokyo, Japan.

*Description* - The largest shell examined reached 82 mm. in length. The color of the shell is white, but pale orange-brown color may be present on the spiral cords. There are 8 to 10 convex whorls producing a spire of approximately 50°. The outer lip is thickened with the outer margin curving forward. There are 8 or 9 denticles on the inner edge of the outer lip. The third denticle below the posterior anal canal is much larger than the others and is opposite a deep indentation in the parietal wall, creating a constricted apertural shape. The parietal shield is thin, rather oblong, being wider posteriorly and narrowing anteriorly. The shield can be smooth or sculptured with very low spiral cords and axial ribs which form beads when they cross. There are numerous irregularly formed plicae on the left of the groove in the lower parietal shield. These are variable in sculpture and number, sometimes reaching the edge of the shield. The groove itself is more open and straighter than in most species of *Distorsio*. The siphonal canal is relatively straight for the genus, short and turned slightly upwards. It is bordered by 9 to 15 well-defined plicae, the greater number usually occurring on the larger specimens. The upper three plicae are the largest and the remainder diminish in size. The sculpture consists of 8 major spiral cords on the body whorl, the upper 5 or 6 being separated from one another by a single fine interstitial cord. There are 8 or 9 varices with 20 to



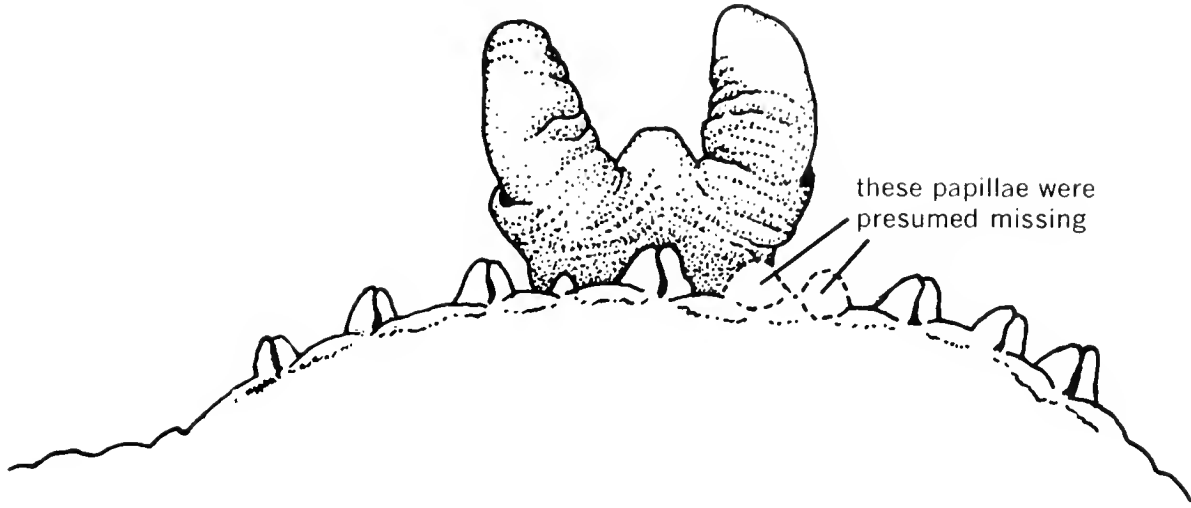

↑  
*Fig. 11, Dorsal aspect of the mantle edge of Distorsio perdistorta Fulton (female) flattened to show papillae.*

*Fig. 12, Dorsal aspect of Distorsio perdistorta Fulton (male). The mantle edge of this specimen lacks papillae.*

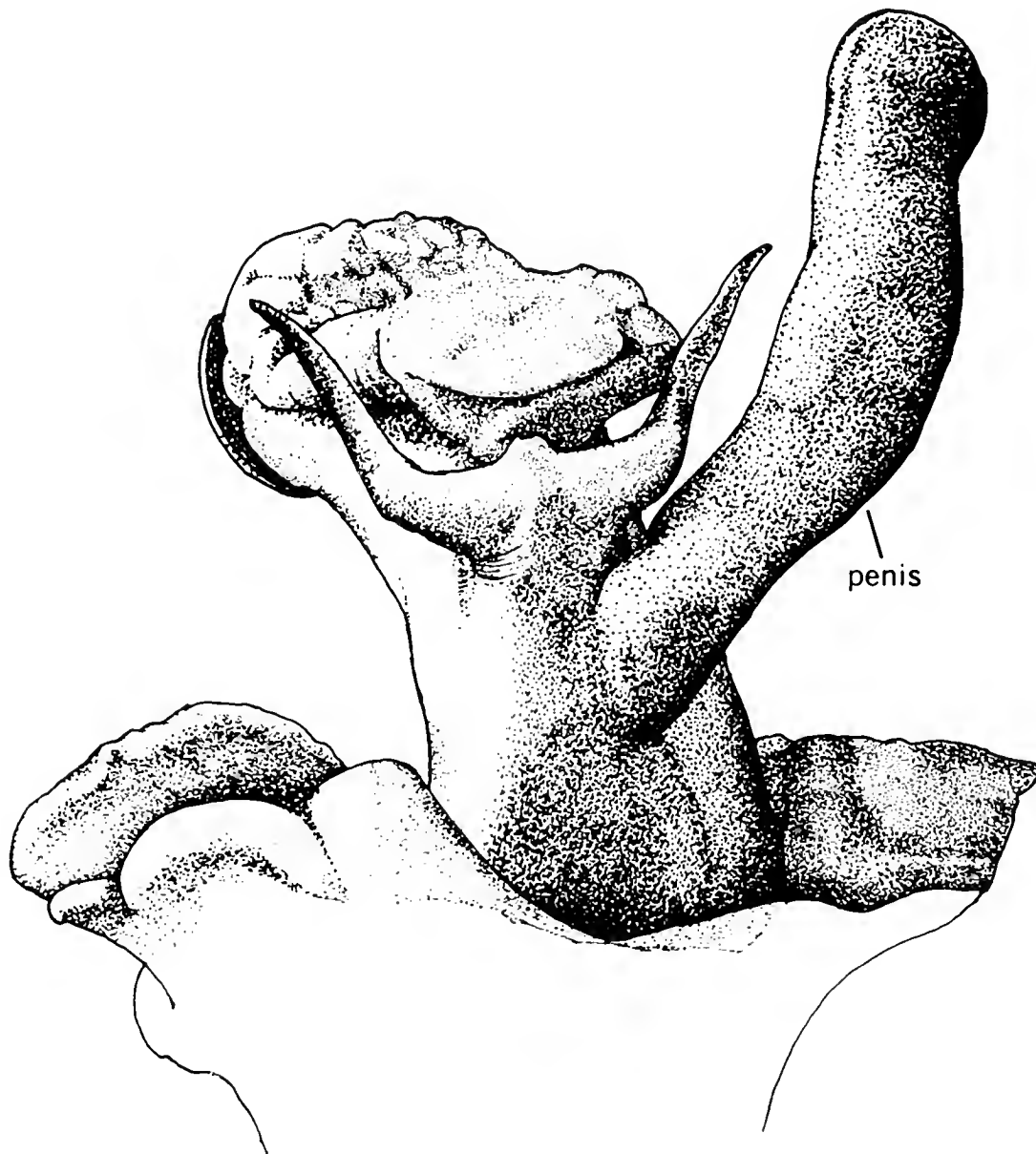

25 axial ribs between them which form beads when they cross and give the shell a reticulated appearance.

The operculum is small and distinct from that of *Distorsio clathrata* although it is similar to *Distorsio macgintyi* (figs. 5 to 10).

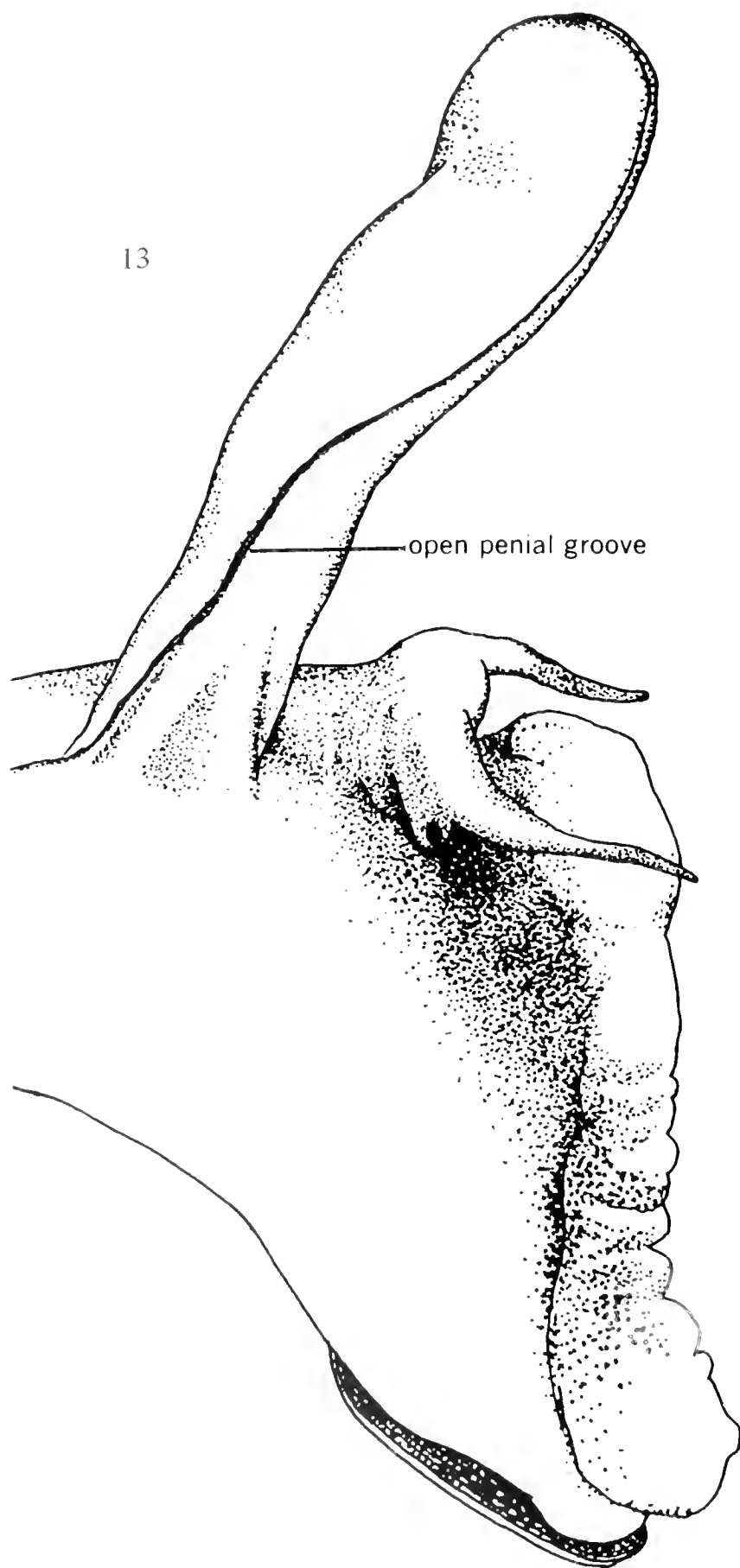

Fig. 13, Right lateral view of *Distorsio perdistorta* Fulton.

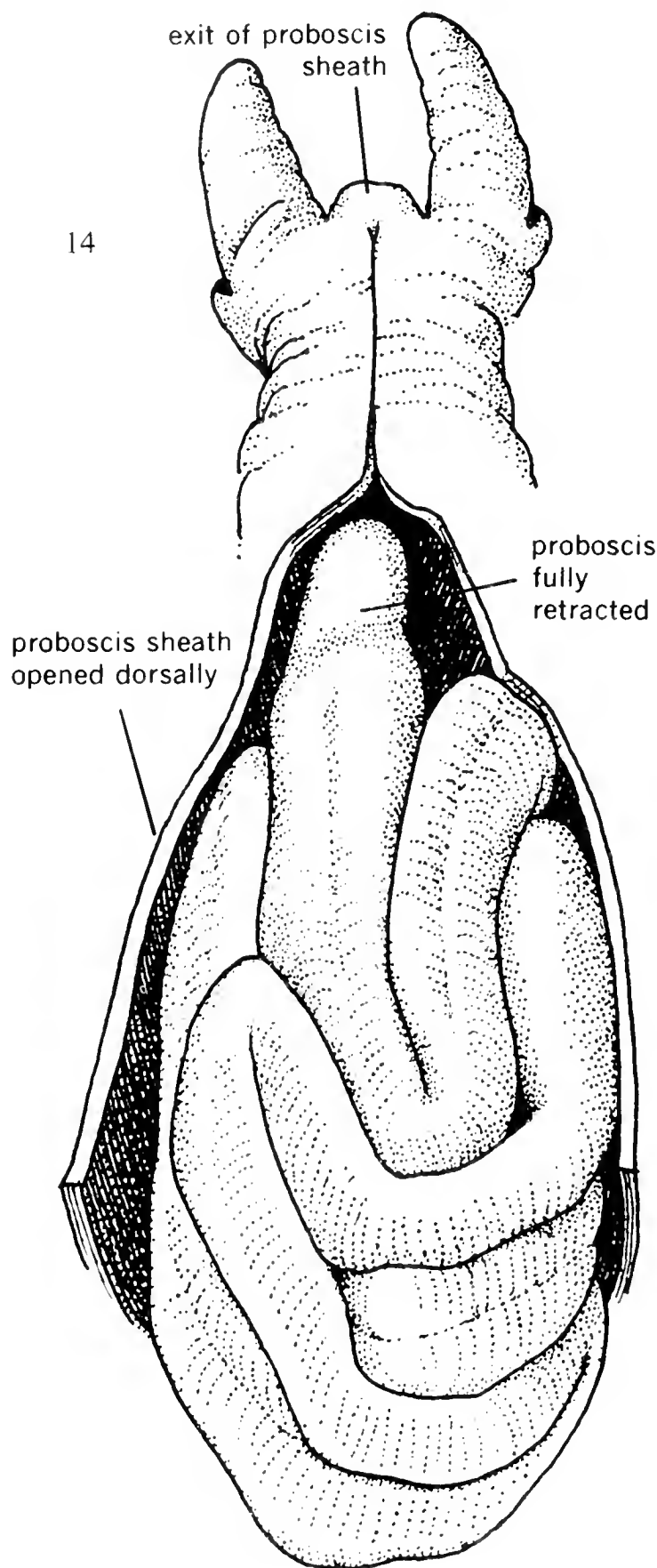

Fig. 14, Dorsal view of *Distorsio perdistorta* Fulton.

The soft body of the animal is tan, lacking the spots typical of many Cymatiidae. The mantle edge of the male animal examined was lacking in papillae (fig. 12); however the female specimen has large obvious papillae which are bisected by an open groove (fig. 11). Since only two specimens were examined, the differences in the mantle edge should not be construed as evidence of sexual dimorphism. The penis is very large with an open penial groove (figs. 12-13).

The rachidian and laterals of the radula are very powerfully formed (fig. 2). There is a long central cusp on the rachidian with 4 to 6 sharply-pointed shorter cusps on either side of it. The lateral has 6 to 9 small, sharply pointed cusps on the anterior lateral edge. There are no cusps on the marginals. Because of the extraordinary proboscis structure and the extremely small opening through which the proboscis is extended, the radula, jaws and buccal mass are very small in relationship to the body mass.

#### PERIOSTRACUM

The periostracum is yellowish and formed in numerous very low axial blades which are fringed with fine projections along their edges. There are long hair-like processes at the beads of the shell sculpture which gives fresh specimens a bristly appearance. Although the Japanese specimens of this species are more sparsely bladed than the Western Atlantic specimens, both exhibit an extraordinary periostracal structure. Below the visible upper surface, there is a second layer of tunnel-like chambers which run spirally around the shell (figs. 23 to 25). There is a periostracal floor which is attached to the shell and a roof which is parallel to the floor and shell surface. The roof is formed by flat connections between the small periostracal processes. The axial walls of the tunnels are formed by the axial blades and the spiral walls by flat, vertical connections between the processes. I have observed similar structures in *Distorsio reticulata*, *D. clathrata*, *D. decussata*, *D. constricta constricta*, and *D. constricta macgintyi*. Two species which do not have this type of periostracum are *D. anus* and *D. constricta habei*.

#### DISTRIBUTION

The distribution of *Distorsio perdistorta* has previously been known from Tosa Bay, Shikoku, Japan to Kii, Honshu, Japan. Based on the limited amount

of material which has been collected in the Western Atlantic, it is difficult to judge the relative rarity of this species, but it certainly can be said that it has not proved to be as common as *Distorsio clathrata* or *Distorsio macgintyi*. Thus far the northern record in the Western Atlantic is west of Tampa, Florida, Gulf of Mexico, while the southern record is off Barbados, in the Lesser Antilles. Recently, two specimens were recorded from north-west Madagascar in the Mozambique Channel, Indian Ocean.

#### COMPARATIVE FEATURES

Fulton described *Distorsio perdistorta* as white, but examination of numerous specimens indicates an occasional pale-brown coloration limited to the spiral cords. This characteristic position of color pigment is present in both Western Atlantic and Japanese specimens, and appears to be a useful character in *Distorsio*.

Some workers might be tempted to designate the Western Atlantic representatives as a subspecies of the Japanese *perdistorta* because of geographical separation, heavier periostracum and an apparent tendency to reach a larger size. However, careful examination of all the material failed to show that these were significant differences. On the contrary, these characters varied within each geographical range. My work with the Cymatiidae has clearly demonstrated to me their great ability for intraspecific variation. Laxton, (1971), has shown that two distinct populations of *Cymatium spengleri* (Perry 1811), can vary in spire angle, number of varices, and other characters, when each lives in different ecological situations and feeds upon different species of ascidians which are available in different quantities. Bayer, (1971, pp. 114-115) discusses the close resemblance of various Japanese and Caribbean genera and species. It is widely known that other species of Cymatiidae are worldwide in distribution with various unexplained geographical relationships. The morphological consistency of the Japanese and Western Atlantic specimens of *Distorsio perdistorta* makes it unnecessary to establish a new subspecies in spite of their great geographical separation.

In order to clearly differentiate the three living species of *Distorsio* in the Western Atlantic, I have attempted to establish a diagnostic chart of their more obvious differences.

TABLE 4. Comparison of the three Caribbean species of *Distorsio*.

|                      | <i>Distorsio perdistorta</i>                | <i>Distorsio clathrata</i>                      | <i>Distorsio constricta macgintyi</i>                     |
|----------------------|---|---|---|
| color                | white;<br>cords<br>orange-brown             | brown;<br>cords and ribs<br>white               | diffused<br>light<br>orange-tan                           |
| shield<br>shape      | oblong;<br>shallow or<br>no sculpture       | oval-round;<br>strongly<br>sculptured           | oval-round;<br>strong white<br>beads, color<br>in between |
| outer<br>lip<br>size | relatively<br>smooth<br>large;<br>to 82 mm. | strongly<br>denticulated<br>large;<br>to 90 mm. | raised<br>spiral cords<br>small;<br>to 55 mm.             |
| spire<br>angle       | 50°   | 55°   | 42°   |

***Distorsio constricta habei***  
*new subspecies*, Lewis  
 Figs. 4, 10, 38, 39

*Synonymy* -

1964 *Distorsio (Rhysema) perdistorta* Fulton, Kuroda and Habe, Shells of the Western Pacific in Color, vol. 2, p. 74, pl. 23, fig. 1 (non Fulton, 1938).

*Description* - The largest shell examined reached 54 mm. in length. There are 9 convex whorls which have a flattened plane above the periphery formed between the first and second spiral cords. The spire is produced at approximately 42°. The outer lip is slightly thickened with the outer margin curving forward. There are 8 denticles on the right edge of the aperture which extend to the edge of the outer lip and form low cords. The third denticle below the posterior anal canal is much larger than the others and is opposite a deep indentation in the parietal wall. The

parietal shield is thin, oval and variably sculptured by spiral cords and axial ribs which form low beads when they cross. Color is a diffused pale orange-brown, with more intense color limited to the spiral cords. There is a clearly formed groove in the lower parietal shield, bordered on the right by 8 to 12 denticles on the columellar edge of the siphonal canal. The first denticle is the largest and the remainder diminish in size. There usually is denticulation on the left side of the groove, but in occasional specimens, the groove blends into the parietal shield without delineating denticulation. The siphonal canal is straight, short and curves slightly upwards. The sculpture consists of 8 major spiral cords on the body whorl and 3 cords on the dorsal surface of the anterior canal. Between the first and second cords below the suture, there are 2 or 3 fine interstitial cords. The second and third cords are close together with one fine interstitial cord separating them. The third and fourth cord are separated by 2 fine interstitial cords, while the remaining

Fig. 15-19, Dissection of the tip of the proboscis of *Distorsio perdistorta* Fulton (dorsal aspect):

*bm* buccal mass;  
*e* esophagus;  
*ev* esophageal valve;  
*ie* incision in esophagus;  
*j* jaws positioned considerably posterior to lip of oral tube;  
*lo* crenulated lip of oral tube (probably used for ingestion of food);  
*lp* lip of proboscis;  
*mc* muscles of the esophageal valve;

*n* buccal and labial nerves;  
*o* odontophore;  
*ot* oral tube;  
*otl* oral tube opened by longitudinal incision;  
*p* proboscis;  
*r* radula;  
*rm* retractor muscles;  
*sp* surface of proboscis, opened by dorsal longitudinal incision;  
*tm* tensor muscles;  
*tp* tip of proboscis;

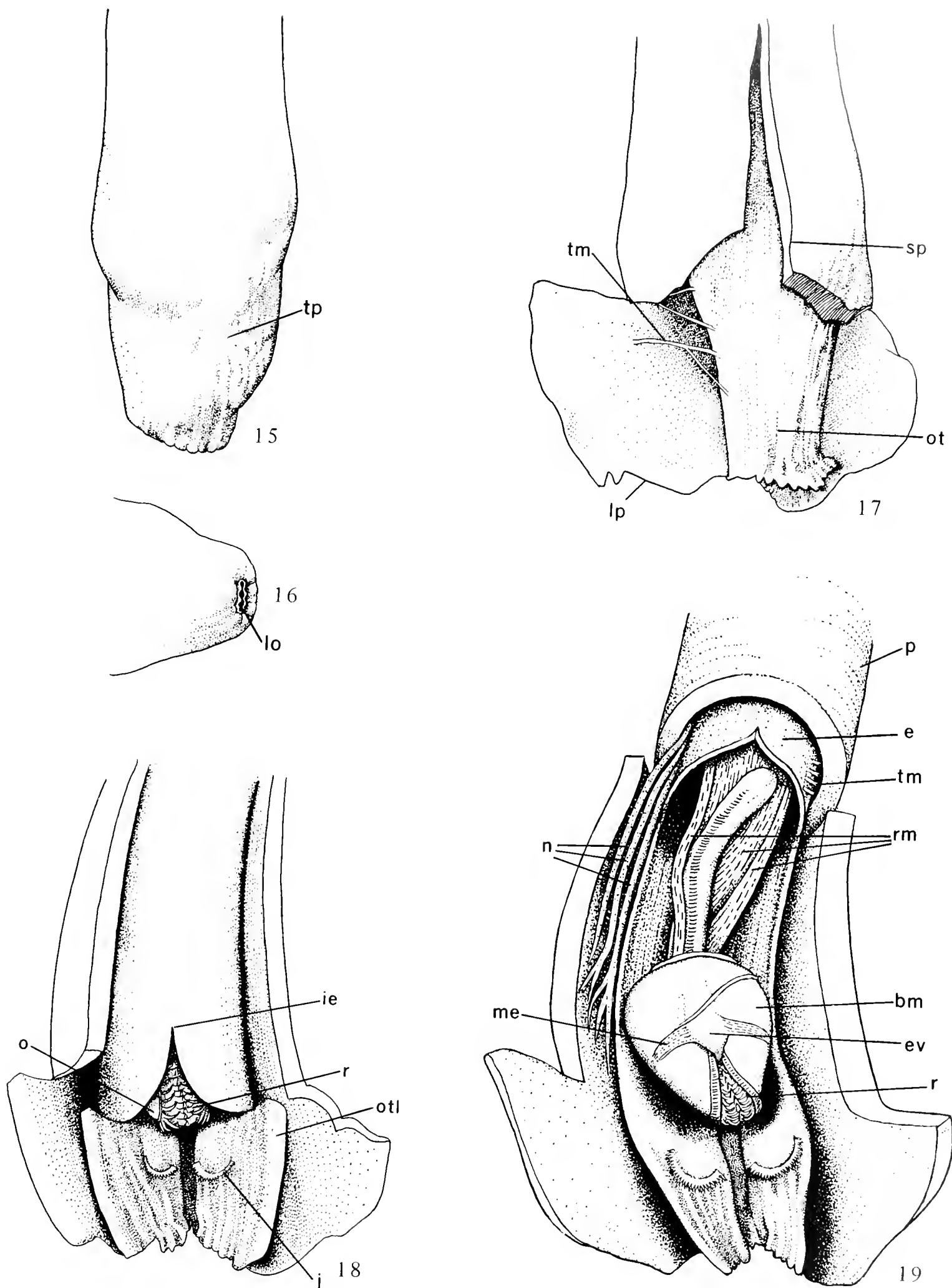

Fig. 15-19, Explanation on opposite page.

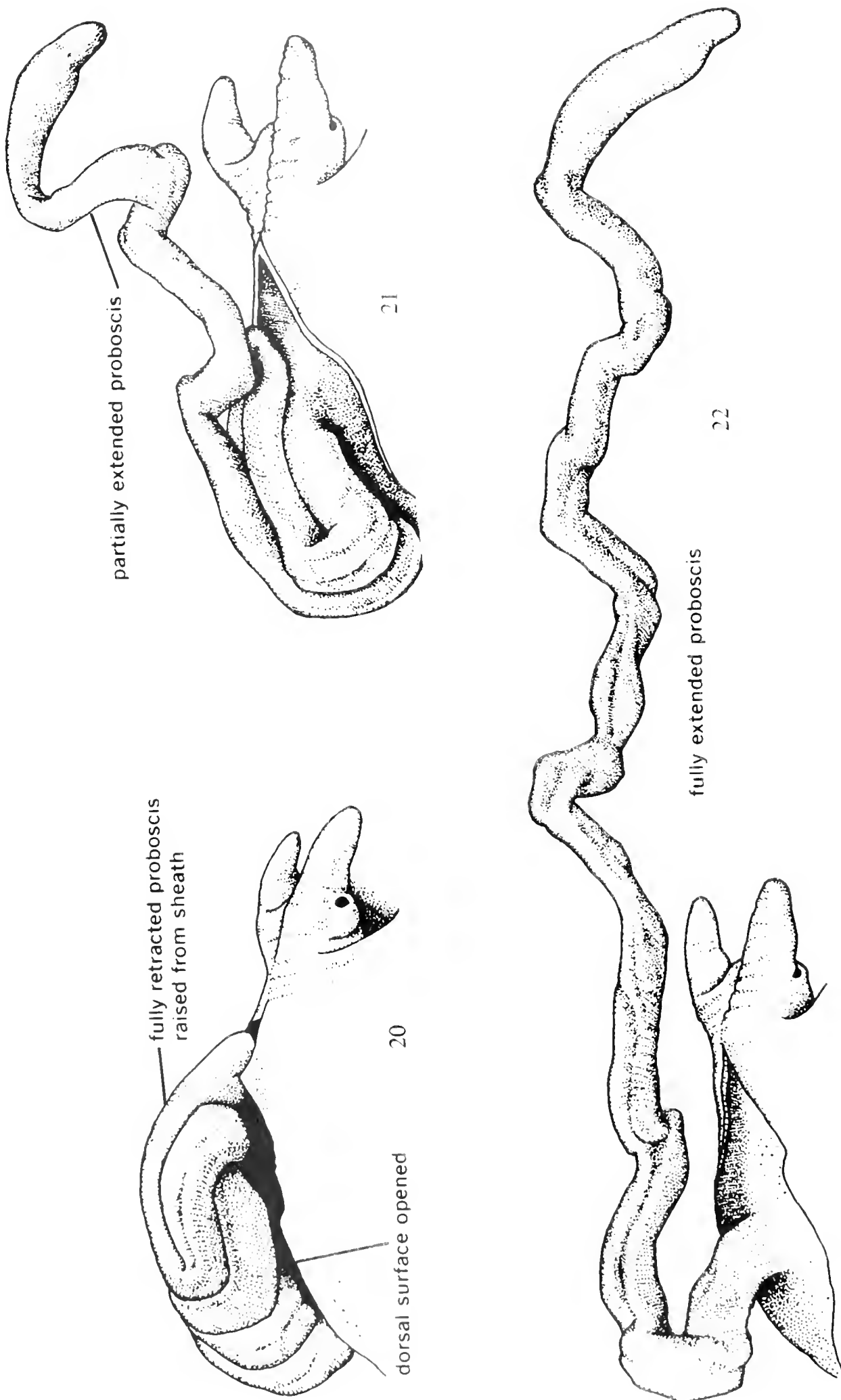

Fig. 20-22, Right lateral view of *Distorsio perdistorta* Fulton. The thickened musculature in the extended proboscis probably aids in rapid extension and retraction and may aid in enabling food to pass through the entire length of the esophagus by separate contractions as it passes posteriorly.

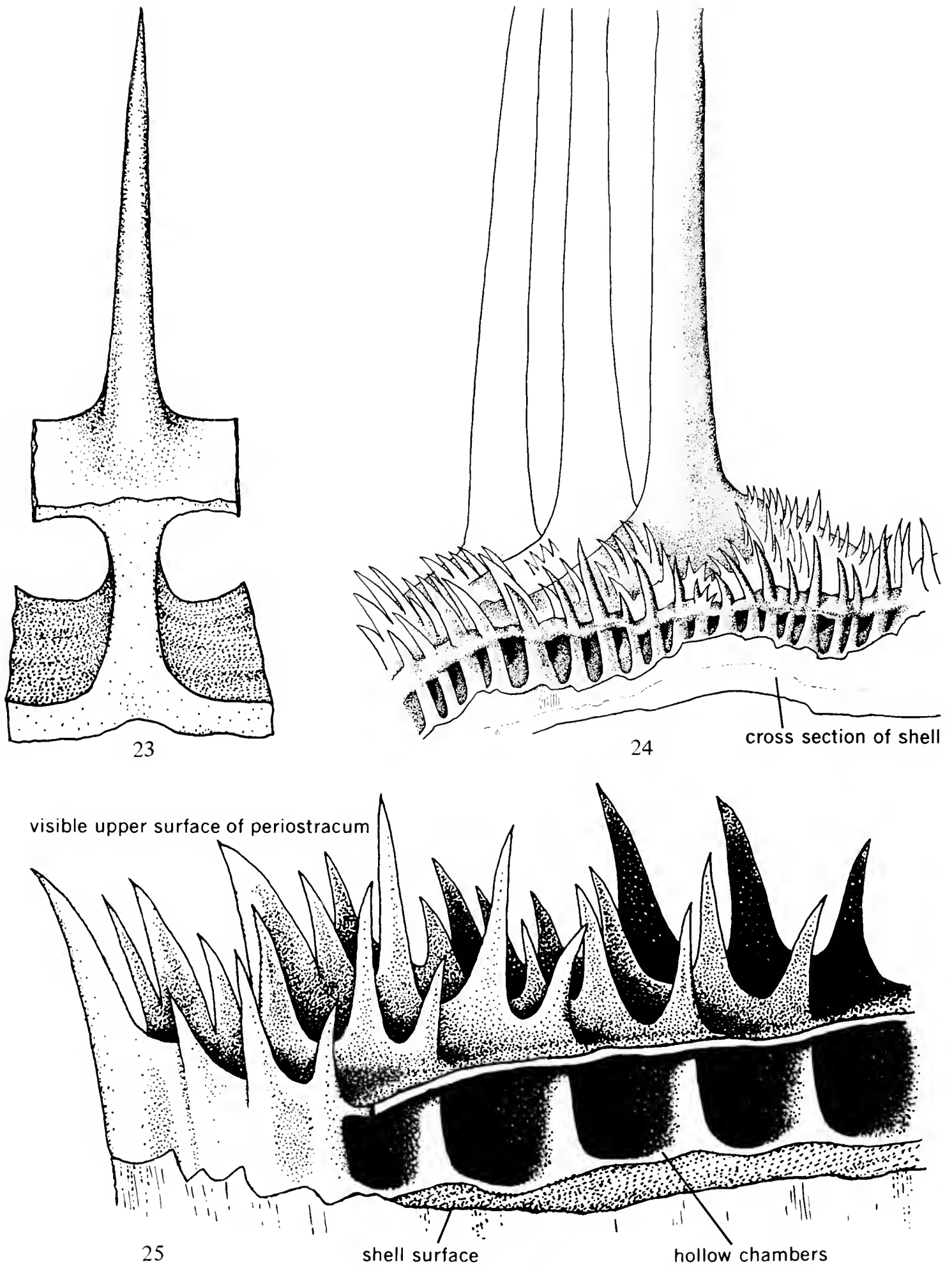

Fig. 23, Single periostracal process of *Distorsio perdistorta* Fulton.

Fig. 24-25, Details of periostracal structure of *Distorsio perdistorta* Fulton, 125 fms. W. of Ft. Myers, Fla.

major cords are usually separated by a single fine cord. There are 8 to 10 varices with 12 to 17 axial ribs between the varices. Where the cords cross the axial ribs, they form beads.

The periostracum is thin, yellowish, formed in spiral rows which follow the cords of the shell in contrast to the numerous, fringed, axial blades of the other species. There are thin, low hairlike processes at regular intervals on the spiral rows and they align axially. Longer processes develop on the ribs of the shell. The periostracum is attached directly to the shell and lacks the second layer such as that found in *perdistorta* and the other two subspecies, *constricta* and *macgintyi*. The operculum is terminal (fig. 10). I have not examined an animal of this species.

*Description of the holotype* - The shell measures 53 mm. in length and 28 mm. in width. There are 8 denticles on the right edge of the aperture which extend across the expanded peristome to the edge of the outer lip, forming low cords. The lower left edge of the parietal shield is lacking in denticulation. There are 9 denticles on the columellar edge of the shield. There are 15 axial ribs on the body whorl.

*Distribution and type locality* - Most of the specimens which I have examined were taken in Tosa Bay, Shikoku, Japan, which is designated the type locality. There is one specimen from Kii, Honshu, Japan. Kuroda and Habe list the distribution as Boso Peninsula, Honshu, to Tosa Bay, Shikoku, Japan at depths of 100 to 200 m. They state that the species is uncommon. The holotype is in the ANSP no. 325380; four paratypes in ANSP 325381; one paratype in Del. Mus. Nat. Hist. no. 50943.

*Differentiating features* - *Distorsio habeii* is very similar in general appearance to *Distorsio constricta*

and *Distorsio macgintyi*. The differences are not significant enough to justify specific separation. However, unlike the Western Atlantic specimens of *Distorsio perdistorta*, they can be separated when the three subspecies are compared. The taxonomic characters which are consistent enough to use are: pigmentation, the pattern of cords and interstitials, denticulation on the expanded peristome and the structure of the anterior siphonal canal.

The shells of all three subspecies are irregularly stained with orange-brown, but the cords on the shell of *habeii* are always colored with a darker pigmentation. On the parietal shield of *macgintyi* and *constricta* there are strongly formed white beads outlined by a rich brown color in between the beads which gives the shields a markedly reticulated appearance. This character is very consistent in *macgintyi* but varies in some specimens of *constricta*. I have examined large specimens of *constricta* from the Galapagos Islands which have no beading on the shield at all. All of the specimens of *habeii* examined had beaded sculpture on the shield, but the strength of the beading and color are variable, lower, and finer than the beading and color on *macgintyi*. The shield of *habeii* is either white or very light orange-brown. In some specimens of *habeii*, the parietal shield was well below the suture, but all of the specimens of *constricta* and *macgintyi* which I have examined had parietal shields which were at the suture or above it.

The regular pattern of interstitial cords which is always present in *habeii* is absent from *constricta* and irregularly variable when present in *macgintyi*. In *habeii*, the right posterior edge of the anterior canal slants toward the posterior columellar edge, almost closing the canal externally at the point where they

---

Fig. 26-27, *Distorsio perdistorta* Fulton, Holotype, British Museum (Natural History), Kii, Japan, 60 mm. x 35 mm.

Fig. 28-29, *Distorsio perdistorta* Fulton, Gulf of Mexico, 57 mm. x 32 mm.

Fig. 30-31, *Distorsio perdistorta*, Fulton, West of Tampa, Fla. 110 fms. The heavy periostracum on this specimen is variable within the species. 66 mm. x 36 mm.

Fig. 32-33, *Distorsio perdistorta* Fulton, Tosa Bay, Japan, 63 mm. x 33 mm.

Fig. 34, *Distorsio perdistorta*, Fulton, Dredged West of Tampa, Fla. This specimen has a periostracum that closely corresponds to the average Japanese specimen. 82 mm. x 44 mm.

Fig. 35, *Distorsio clathrata* Lamarck, Dredged 65 fms. off Tortugas, Florida, 67 mm. x 36 mm.

Fig. 36-37, *Distorsio decussata*, Valenciennes, Trawled near Topolobamp, Sinaola, Mexico, 40 fms. 64.5 mm. x 33 mm.



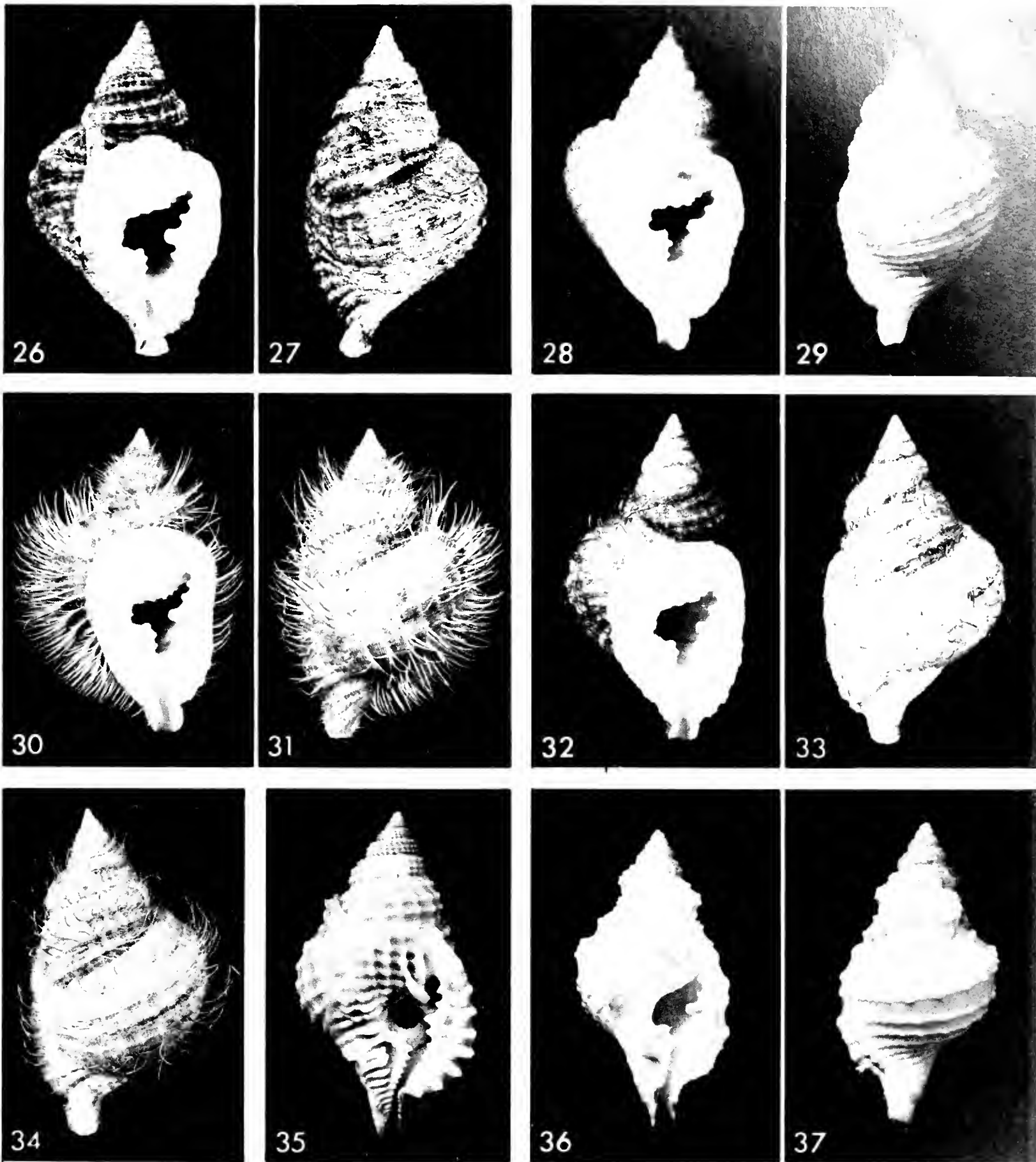

*Fig. 26-37, Explanation on opposite page.*

come together. The edges of the anterior canals of *constricta* and *macgintyi* remain parallel and leave the canal open.

While discussing the holotype of *habei*, I described how the denticles on the right edge of the aperture continue across the expanded peristome to the outer edge of the shield, forming low cords. If the cords do not continue from the apertural edge, there are no denticles formed at the outer edge of the shield, although there is a shallow groove which runs parallel to the aperture down the length of the expanded peristome. In both *constricta* and *macgintyi*, this groove is stained with a darker orange-brown color. Clearly defined denticles are formed on the right outside edge of the shield. Although separate, these denticles align with those at the apertural edge.

In the specimens examined there were 8 to 13 axial ribs between the varices of *constricta*, (an average of 10.6); 11 to 20 on *macgintyi* (an average of 14.7); and 12 to 17 in *habei* (an average of 15.6).

*Distorsio habei* differs from *Distorsio perdistorta* by being smaller, more distorted, having a more angled whorl which is tabled above the periphery, fewer axials (15.6) than *perdistorta* (20 to 25), a different pattern of interstitial cords, a different periostracal structure and richer pigmentation than the Japanese specimens of *perdistorta*. The spire angle of *habei* is  $42^\circ$  while the spire angle of *perdistorta* is  $50^\circ$ .

#### HISTORICAL DISCUSSION OF *HABEI*

Kuroda and Habe in "Shells of the Western Pacific in Color", (1964, vol. 2, p. 23, figs. 1 and 3) des-

cribed *Distorsio horrida* (their fig. 3) as a new species and differentiated it from what they identified as "*Distorsio perdistorta* Fulton" (their fig. 1). Examination of a photo of the type specimen of *Distorsio perdistorta* kindly supplied by the British Museum of Natural History and correspondence with Dr. Tadashige Habe of the National Science Museum of Tokyo proved that *Distorsio horrida* Kuroda and Habe, 1964, is a synonym of *Distorsio perdistorta* Fulton, 1938, and that "*Distorsio perdistorta*" Kuroda and Habe (not Fulton) is an unnamed species. This taxon is described as *Distorsio constricta habei* in honor of Dr. Tadashige Habe whose many contributions to malacology are known throughout the world. Careful comparison of this species with specimens of worldwide species of *Distorsio* has led me to realize that *Distorsio constricta habei* from Japanese waters along with *Distorsio constricta constricta* from the Eastern Pacific and *Distorsio constricta macgintyi* from the Western Atlantic are geographical subspecies. These three subspecies give evidence once again of the amazing distribution of some of the Cymatiidae.

#### FOSSIL RELATIVES

There is some confusion in the literature that deals with the ancestors of the recent Caribbean and Panamic species of *Distorsio*. Various authors have considered the Antillean Miocene fossil *Distorsio simillima* (Sowerby, 1850), to be a paleosubspecies of three different recent *Distorsio* i.e.: *decussata*, *clathrata* and *constricta*. The matter was further complicated because they confused specimens of *Dis-*

---

Fig. 38-39, *Distorsio constricta habei* Lewis, Holotype, Tosa Bay, Shikoku, Japan, 53 mm. x 28 mm.

Fig. 40, *Distorsio constricta macgintyi* Emerson and Puffer, dredged 280 ft. S. W. of Key West, Fla., 43 mm. x 25 mm.

Fig. 41, *Distorsio constricta constricta* Broderip, dredged 200 m. off Southern Coast of Santa Cruz Is., Galapagos, 49 mm. x 27.5 mm.

Fig. 42, *Distorsio anus* (Linné). Hawaii.

Fig. 43-44, *Distorsio burgessi* Lewis, Hawaii, Holotype, The Academy of Natural Sciences of Philadelphia, No. 326470, 39 mm. x 25 mm.

Fig. 45-46, *Distorsio ridens* Reeve, Philippines, Syntype, The British Museum of Natural History, No. 1967630, 77.5 mm. x 38 mm.

Fig. 47, Reeve's figure of *Distorsio ridens*.

Fig. 48, *Distorsio ridens* Reeve, Lectotype, American Museum of Natural History, 64.5 mm. x 35 mm.

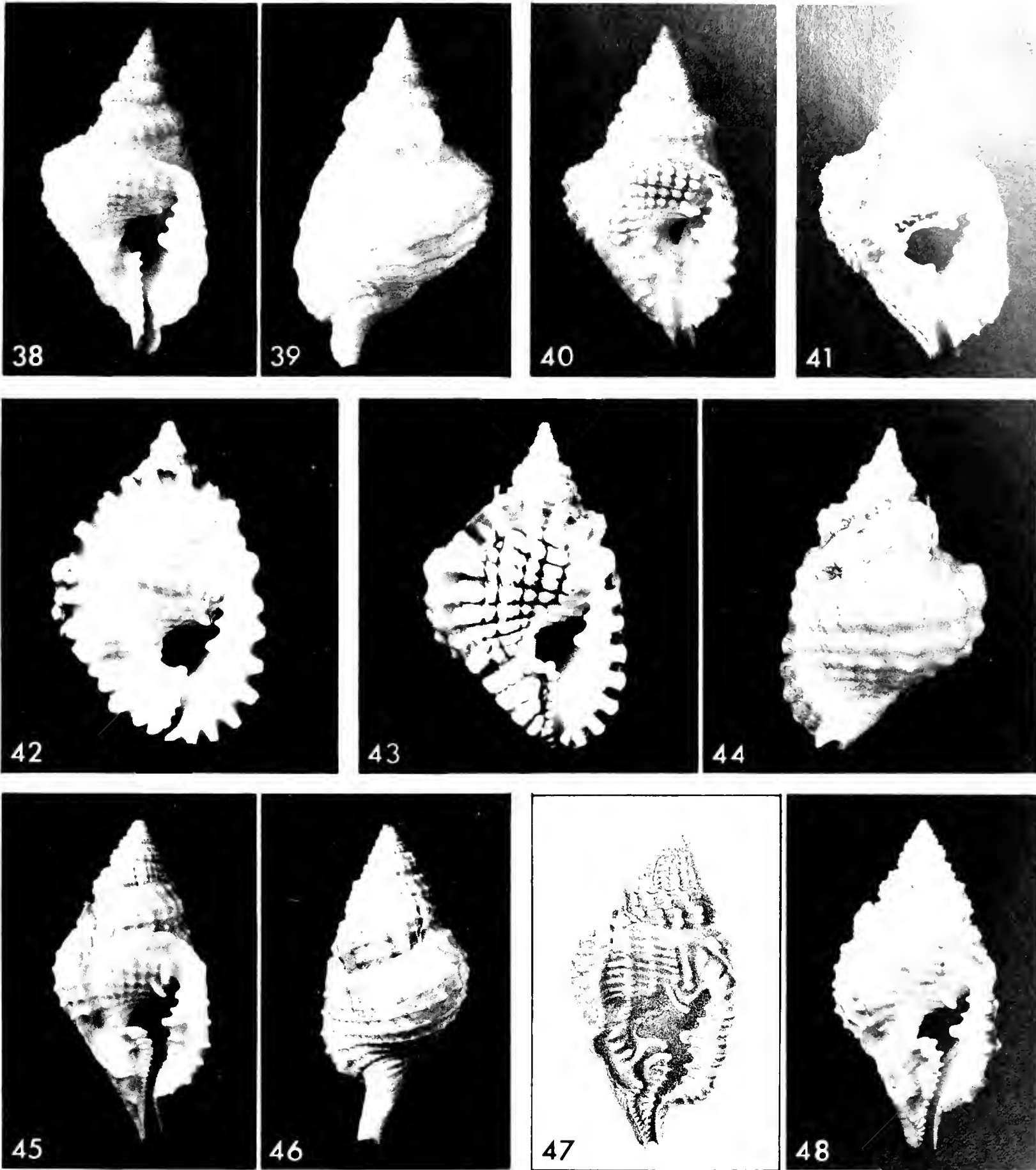

*Fig. 38-48. Explanation on opposite page.*

*torsio simillima* with *Distorsio gatunensis* Toula, 1909 (Miocene, Panama). Rutsch, 1930, (pp. 610-611, 614, pl. 17, fig. 6) examined and figured the holotype of *gatunensis* and concluded that this species is actually the fossil form of the recent *decussata*. This was confirmed by Emerson and Puffer, 1953, (p. 100) and Weisbord, 1962, (p. 271). Woodring, 1928, (p. 300, pl. 18, figs. 7 to 9) illustrates two species under the name "*Distorsio decussatus simillimus*". Actually, fig. 9 and fig. 1, pl. 19, are a specimen of *Distorsio simillima*, the ancestor of *constricta*. Figures 7 and 8 are *Distorsio gatunensis* Toula, the ancestor of *decussata*. A possible sequence of evolutionary events indicates that the first true *Distorsio* s.s. was *crassidens* (Conrad, 1848), Vicksburg, Mississippi, Middle Oligocene, which spread throughout the Caribbean developing into *simillima* during the Miocene and eventually into the recent *macgintyi*. Pilsbry, (1922, p. 360,) considered *crassidens* to be a fossil subspecies of *Distorsio constricta*. However, he was unaware of the existence of *macgintyi*, since that species was not reported until 1951, and he was under the impression that *simillima* had died out in the Caribbean without a recent form. Fossil evidence shows that *simillima* existed in the Tertiary Caribbean faunal province from the Lower Miocene to the Pliocene and in the Eastern Pacific from the Middle Miocene to the Pliocene. It must be remembered that the Tertiary Caribbean Province extended into the Eastern Pacific from southern Nicaragua to northern Peru. Woodring, (1966, p. 427) suggests the possibility of transportation of planktonic larvae by the Miocene North Equatorial current along the south border of the Caribbean Sea, through the Atrato Strait (and others) into the Eastern Pacific. It has been reasonably established that this faunal migration was at its height during the Middle Miocene, a time which corresponds with the fossil presence of *simillima* in the Eastern Pacific. Since *simillima* was unknown in the Eastern Pacific during the Lower Miocene, we can assume that it existed in the Caribbean province for approximately 5 million years before migration into the Eastern Pacific. It is likely that *Distorsio macgintyi* was the first recent species to develop from the *crassidens-simillima* stock. *Distorsio simillima*, having migrated to the Eastern Pacific during the Middle Miocene, became isolated at the end of the Tertiary and early Pleistocene after closure of the Central American land bridge, and there was modified into the present-day *constricta*. Eastern migration of an-

cient *simillima* accounts today for the Japanese subspecies *Distorsio constricta habei*.

### *Distorsio burgessi* new species, Lewis

Figs. 43, 44

In August, 1963, an unidentified species of *Distorsio* was illustrated by Dr. C. M. (Pat) Burgess on the first page of vol. 11, no. 10, of the Hawaiian Shell News. The specimen appeared to be closely related to *Distorsio anus* Linné and until recently I have considered it to be a polymorphic form of *D. anus*. Recently sufficient material has come into my possession to show that consistent differences do exist between the two species which suggests that they are sympatric.

*Distorsio anus* is widespread in its distribution and shows morphological variation within a given population as well as between widely separated populations. However, there is such a great intergrading of form that it would be impossible to tell where a given specimen was taken. In the case of *Distorsio burgessi*, its distribution is limited to Hawaii and though found with *D. anus*, it can readily be separated from it. Though *D. anus* is very common and *D. burgessi* relatively rare, large selections of *anus* examined which were taken in the same general area as *burgessi* fail to show specimens which intergrade with *burgessi*. The first specimen illustrated in Hawaiian Shell News was taken, along with two others, in 14 fathoms, but the holotype and paratypes were found by diving in shallower depths, dispelling the idea that *burgessi* might be a deep water form of *anus*. The differences between the two species are consistent but do require careful observation. If the species were not sympatric it would seem more reasonable to consider *burgessi* as a subspecies of *anus*.

*Distorsio burgessi* is named in honor of Dr. C. M. Burgess who first published it as an unidentified species.

*Description* - The largest shell examined reached 60 mm. in length. There are 9 convex whorls which have a flattened plane above the periphery formed between the first and second spiral cords. The periphery is defined by the second and third spiral cords joining to form a double cord. The spire is produced at an angle of approximately 53°. The outer lip is formed by the right edge of the parietal shield which projects slightly past the body whorl. Behind the shield at the point where it meets the body whorl there is a strong axial cord which is separated from the preceding axial

cord by a deep groove. This groove is crossed by the spiral cords and gives the impression of a deep perforated line. The outer edge of the parietal shield is shallowly ruffled by 9 low cords which are separated by 8 dark brown shallow grooves. Larger specimens have a row of sharply formed teeth at the beginning of each dark groove arranged in a line parallel to the outer lip. These teeth are separated from the apertural denticles by a secondary groove which is also parallel to the outer lip and is lightly stained in a dotted line between the teeth. The parietal shield is the most striking character of this species. It is ear-shaped, and the lower left edge of the shield is flattened and conforms to the body whorl behind it. The main mass of the shield is sculptured by 9 strong, regular, spiral cords and 5 or 6 axial ribs which create a checkerboard pattern. This effect is greatly enhanced by the rich dark-brown pigmentation in the grooves between the squares of the pattern. An unusual appearance is created along the left and upper edges of the parietal shield because the ribs stop before the left edge and the spiral cords continue, while the cords stop before the upper edge and the axial ribs continue. The aperture is typically irregular and with 9 denticles. The third, which is the largest, is opposite a deep indentation in the parietal wall. The shell is white, lightly stained with a very pale orange. The columellar plicae and siphonal canal are straight and aligned on the axis of the shell. The siphonal canal is very short and recurves dorsally at an angle of approximately  $115^\circ$ . The sculpture consists of 8 spiral cords on the body whorl and one cord on the dorsal surface of the siphonal canal. There are usually 10 to 12 major axial ribs which cross the cords and form low nodules. The periostracum is yellowish, very flat and thin, formed in a regular pattern of low hairlike processes, with slightly larger processes forming on the axial ribs. It is attached directly to the shell surface, lacking the second layer found in *perdistorta*. I have not examined an animal nor the operculum of this species.

*Description of the holotype* - The shell measures 39 mm. in length and 25 mm. in width. There are 12 denticles along the columellar edge to the end of the siphonal canal. There are 12 major axial ribs on the body whorl. The specimen has its periostracum intact. Holotype ANSP no. 326470. 2 paratypes in the Hal Lewis collection. 1 paratype Del. Mus. Nat. Hist. 1 paratype in the Clifton S. Weaver collection.

*Distribution* - All of the specimens examined were taken in Hawaii at approximately 21.18N Long. 158.07 W. Lat. off Oahu Island, Type locality: Barber's Point, S. W. Oahu Island, Hawaii. Collected by E.

*Differentiating features* - This species differs from *Distorsio anus* primarily on characters relating to the parietal shield and anterior siphonal canal. The parietal shield of *Distorsio anus* is oval to almost round with deep ruffles usually present around the perimeter of the shield. It rises above the body whorl to completely cover the preceding two whorls. In *Distorsio burgessi* the ruffled edge is restricted to the outer lip and the shield covers approximately  $1\frac{1}{2}$  preceding whorls. The shield of *anus* is white to diffused orange-tan, lacking the rich dark-brown pigmentation typical of *burgessi*. The sculpture on the shield of both species consists of 9 spiral cords but on *anus* there are usually more numerous axial cords, giving the shield surface a finer beaded and wrinkled look. Even when the sculpture is coarser, it lacks the regular checkerboard pattern of *burgessi*. The anterior canal of *anus* is always angled to the left, often curving slightly, in contrast to the straight axially aligned canal of *burgessi*. The siphonal canal of *anus* is longer and recurves dorsally at an angle of approximately  $90^\circ$ . The groove to the left of the siphonal canal on the lower left parietal shield of *anus* opens into the aperture via a secondary groove which is framed by two large plicae. All of the specimens of *burgessi* which were examined did not have this secondary groove, and the primary groove in the lower left shield was reduced, thinner and shallower than in *anus*, forming a narrow dark-brown passage which follows the edge of the columellar-siphonal denticles. In specimens examined, there were 10 to 12 axial ribs on *burgessi* and 14 to 16 axial ribs on *anus*.

In spite of the rich pigmentation present on the parietal shield of *burgessi*, it is lacking in the rich body whorl pigmentation typical of *Distorsio anus*. This appears once again to be an indication of the specific importance of the position of pigmentation on the shells of *Distorsio*.

*Distorsio ridens* Reeve, 1844

Figs. 45-48

In the course of my work with the Cymatiidae, I have observed that the species known as *ridens* Reeve is often misidentified in collections. This very uncom-

mon species has had equal mistreatment in the literature. It has been listed as *reticulata* Röding (Maxwell Smith, 1948, p. 23); properly figured but misidentified as *reticulata* (Wagner and Abbott, 1967, p. 85, fig. 13-115); been confused with *Distorsio smithi* von Maltzan, 1884 (Nicklés 1950, p. 86, fig. 133), *perdistorta* Fulton, 1938 (Oyama, 1957, pl. 1, figs. 7-8), and, in many other instances too numerous to mention, improperly synonymized, misidentified and misfigured. The actual species described and figured by Reeve (1844, Triton, pl. 12, sp. 46) has been subsequently figured properly by Tryon (1881, pl. 17, fig. 177) and Webb (1935, pl. 51, fig. 10). Both of these figures are copies of Reeve's original figure, and it is probable that neither author had actually seen specimens of the species. Oddly enough, I have been unable to find a published photograph of *ridens*.

A recent visit to the British Museum of Natural History to study types revealed that none of the syntypes labeled *ridens* matched the actual specimen figured by Reeve. It is important to realize that Reeve's cymatiid drawings are accurate depictions of the specimens which they represent, matching them very well in size, color pattern, details of breakage, etc. All of the syntypes were less colorful, and none matched the figure in size, although they were clearly the same species (fig. 45). However, there is a specimen in the collection of the American Museum of Natural History New York (cat. no. 6369) (fig. 48) which so very closely matches Reeve's figure (our fig. 47) that I feel it is reasonable to designate it as the lectotype. The specimen measures within a millimeter of the figure, matches it exactly in the outline of the shell, shape of the parietal shield, position of color (absent from the syntypes), spire angle, broken siphonal canal, number of denticles on the columellar edge and minor details of breakage. The only differences appear to be artistic exaggerations of a second row of plicae on the lower left parietal shield and the gross manner in which the groove on the lower parietal shield enters into the aperture. Both of these characters are unique to the figure, being absent from the syntypes and all other specimens examined. I have never seen characters such as these on any specimen of any species of *Distorsio*. This specimen is from the Wm. A. Haines collection, the bulk of which was given to the AMNH in 1879. Haines, an American conchologist of the 19th Century, exchanged with many famous conchologists of the day, and could have obtained the specimen through his friend John

C. Jay, or even directly from Reeve. While at the British Museum of Natural History, I carefully examined every cymatiid in the collection, including material not separated and distributed. There were no other specimens of *ridens* Reeve that could be considered to match the figured specimen.

The *ridens* situation is further complicated by the similarity of *ridens* to *Distorsio decussata* Valenciennes, 1832. There is a claimed "paratype" of *ridens* in the collection of the Museum of Comparative Zoology at Harvard University (MCZ 186600 C. B. Adams coll.) with Philippine data but which actually is a specimen of *decussata*. This misidentification is common. *Distorsio decussata* can quickly be separated from *ridens* by the fact that *decussata* always has a double spiral cord at the periphery, a character which is consistent in fossil as well as Recent specimens. Myra Keen (1971, p. 508, sp. 962) lists the range of *decussata* from Cape Tepoca and Guaymas, Sonora, Mexico, south to Manta, Ecuador, offshore to depths of 82 m., and she properly considers *Distorsio ridens* of authors, not Reeve, to be a synonym of *decussata*.

It is hoped that the discussion of this matter, publication of photographs of the lectotype, syntype and Reeve's figure will serve to clarify this species and establish it as a valid taxon, separable from *reticulata*, *perdistorta* and *decussata*.

#### ACKNOWLEDGEMENTS

I wish to thank Dr. George Davis, Associate Curator, Department of Malacology of the Academy of Natural Sciences of Philadelphia for his valuable critical comments on the manuscript; Dr. R. Tucker Abbott, du Pont Chair of Malacology, Delaware Museum of Natural History, who initially suggested that this paper be written and greatly assisted in its organization and nomenclature; Dr. Robert Robertson, Pilsbry Chair of Malacology, Academy of Natural Sciences of Philadelphia, for his suggestions and discussion of the manuscript; The British Museum of Natural History, Mollusca Section, for their kind cooperation during my visit, and Mrs. Way for the photo of the holotype of *Distorsio perdistorta*; Dr. William Emerson, Chairman of the Department of Living Invertebrates, American Museum of Natural History of New York, for drawing my attention to

certain references in the literature of fossils; Dr. Joseph Rosewater, Division of Mollusks, National Museum of Natural History, Washington, D. C., for his kind cooperation and the loan of valuable material; Dr. Robert Bullock, Museum of Comparative Zoology at Harvard College, for the loan of valuable material; and to Dr. Tadashige Habe, Curator of Invertebrate Zoology, National Science Museum, Tokyo, for his kind cooperation and correspondence.

## LITERATURE CITED

- Bayer, Frederick M. 1971. Biological Results of the University of Miami Deep-Sea Expeditions. 79. New and Unusual Mollusks Collected by R/V John Elliott Pillsbury and R/V Gerda in the Tropical Western Atlantic. *Bulletin of Marine Science*. 21 (1): 11-236, figs. 1-72. Coral Gables, Fla. (University of Miami Press) (March).
- Broderip, W. J. 1833. *Proceedings of the Zoological Society of London*, pt. 1, p. 5.
- Clench, William and Turner, Ruth. 1957. *Johnsonia*, Monograph of the Western Atlantic Mollusks, The Family Cymatiidae in the Western Atlantic 3 (36): 189-244, 26 pls. (December 20).
- Conrad, T. A. 1848. Observations on the Eocene Formation, and Descriptions of One Hundred and Five New Fossils of that Period, from the Vicinity of Vicksburg, Mississippi; with an Appendix. *Journal of the Academy of Natural Sciences of Philadelphia* 1, ser. 2, p. 188, pl. 11, fig. 40.
- Dall, William Healey 1889. Reports of the Results of dredging . . . by the U. S. Coast Survey Steamer "Blake". pt. 2, Gastropoda and Scaphopoda. *Bulletin of the Museum of Comparative Zoology*, 18: 492 pp., pls. 10-40 (June).
- Emerson, William K. and Puffer, Elton L. 1953. Catalogue of the Molluscan genus *Distorsio* (Gastropoda, Cymatiidae). *Proceedings of the Biological Society of Washington* 66: 93-108 (August 10).
- Fulton, H. C. 1938. Descriptions and figures of new Japanese Marine Shells. *Proceedings of the Malacological Society of London* 23 (1): 55-56, pl. 3, figs. 3 and 3a (March).
- Gardner, Julia 1947. The Molluscan Fauna of the Alum Bluff Group of Florida. U. S. Geological Survey Professional Paper, 142-H, pt. 8: 493-656, pls. 52-62.
- Habe, Tadashige Dr. 1964. Shells of the Western Pacific in Color. 2, 233 pp., 65 pls.
- Keen, A. Myra 1971. Sea Shells of Tropical West America, p. 508, figs. 962 & 963.
- Laxton, J. L. 1970. Shell growth in some recent New Zealand Cymatiidae. *Journal Exp. Marine Biology*. vol. 4, pp. 250-260.
- Lamarck 1816 - *Tableau Encyclopédique et Méthodique*, Liste, p. 4, Atlas 3, pl. 413, figs. 4a and 4b.
- Link, H. F. 1807. *Beschreibung der Naturalien-Sammlung der Universität zu Rostock*.
- Nicklés, Maurice 1950. Mollusques testacés marins de la Côte occidentale d'Afrique. *Manuels Ouest-Africains*, 2: 86 & 87, fig. 133.
- Olsson, A. and McGinty, T. L. 1951. A *Distorsio* new to the Florida Fauna. *The Nautilus*, Philadelphia 65 (1): 26-28, pl. 1, figs. 5, 6, 10, 11, 12 (July).
- Oyama, Katura 1957. The Molluscan Shells, Science and Photography Club, *Distorsio* 1, figs. 1-12.
- Pilsbry, Henry A. 1922. A Revision of W. M. Gabb's Tertiary Mollusca of Santo Domingo. *Proceedings of the Academy of Natural Sciences of Philadelphia* 73, pls. 16-47.
- Puffer, Elton L. 1953. *Distorsio reticulata* vs. *Distorsio clathrata* in the West Indies. *Proceedings of the Biological Society of Washington* 66: 109-124, pls. 6 and 7 (August).
- Reeve, Lovell A. 1844. *Conchologia Iconica* 2, Triton, pls. 1-20.
- Rutsch, R. von 1930. Einige interessante Pagstropoden aus dem Tertiär der Staaten Falcón und Lara (Venezuela). *Eclog. Geol. Helvetiae*, 23 (2): 604-614, pl. 17.
- Smith, Maxwell 1948. Triton Helmet and Harp Shells. p. 23, pl. 8, fig. 10.
- Sowerby, G. B. II 1850. Descriptions of new species of Fossil Shells found by J. S. Heniker Esq. *The Quarterly Journal of the Geological Society of London*. pt. 1, *Proceedings of the Geological Society* 6: 44-53, pls. 9-10.
- Toula, Franz 1909. Eine jungtertiäre Fauna von Gatun am Panama-Kanal. *Jahrbuch der Kaiserlich-Königlichen Geol. Reichsanstalt*, pp. 673-760, 4 pls.
- Valenciennes, A. 1832 (in) Humbolt and Bonpland. *Recueil d'Observations de Zoologie et d'Anatomie Comparée* 2: 306-307.
- von Maltzan, Hermann Freiherrn 1884. Diagnosen neuer Senegambischer Gastropoden. *Nachrichtsblatt der deutschen Malakozoologischen Gesellschaft*, no. 5, pp. 65 & 66.

- Wagner, Robert J. L. and Abbott, R. Tucker 1967. Von Nostrand's Standard Catalog of Shells. Second Ed., p. 85, fig. 13-115.
- Webb, Walter Freeman 1935. Handbook for Shell Collectors, Sixteenth Ed., p. 105, pl. 51, fig. 10.
- Weisbord, Norman E. 1962. Late Cenozoic Gastropods from N. Venezuela. Bulletin of American Paleontology, vol. 42, no. 193 (March 5).
- Woodring, Wendell P. 1928. Miocene Mollusks from Bowden, Jamaica, Part 2. Gastropods and discussion of results, no. 385, 564 pp., 40 pls. (Carnegie Institute of Washington Pub.).
- Woodring, Wendell P. 1966. The Panama Land Bridge as a Sea Barrier. Proceedings of the American Philosophical Society, vol. 110, no. 6, pp. 425-433, 4 tables.

## BOOK REVIEW

THE KINGDOM OF THE SEASHELL by R. Tucker Abbott. Crown Publishers, Inc., 419 Park Avenue South, New York, New York. 256 pp., 92 black and white plates, 178 colored plates and 13 drawings. 1972, \$14.95.

This delightful book presents a whole spectrum of topics on marine mollusks from their division into six classes to how and where to find them; their breeding habits, structure, coloration and the ways in which they have been used in the arts, religion and history. Certain families, such as the volutes, cowries, murices, cones and scallops, are selected to portray their importance to man.

Many of the colored plates are among the finest illustrations that have ever been published in this field. These, as well as the black and white photographs, were gleaned from several sources; all are acknowledged at the end of the book. This volume is

not a textbook on mollusks, even though it contains much general and basic information, but rather a portrayal of the many facets of this remarkable group of animals. Dr. Abbott has an unusual ability to grasp those facts which are important and interesting about seashells and to combine them all in a lively book which reads like a novel. It is essentially a book for the uninitiated, but mollusk enthusiasts, whose efforts have been devoted largely to collecting shells, will find much to broaden their views. Anyone who appreciates a well-written, artistically arranged book will want to own one.

The book is fully indexed and contains a useful, selected bibliography, the titles being grouped under appropriate subject headings.

William J. Clench  
Curator Eminentus  
Museum Comp. Zoology



NOTES ON THE GENUS *PARANCISTROLEPIS* AZUMA (BUCCINIDAE)

Tadashige Habe

National Science Museum, Tokyo, 160, Japan

The genus *Parancistrolepis* was established by Azuma in 1965 for *Japelion(?) kinoshitai* Kuroda, 1931, because of the remarkable radular features, which superficially resemble the radula of the family Fasciolariidae rather than that of the family Buccinidae in having a three-cuspidate central tooth and a eight-to-nine-cuspidate marginal tooth.

This genus was also assigned *Ancistrolepis fujitai* Kuroda, 1931, by him, only because of the shell characters and the extremely small operculum which closely resembled those of the type species. This species differs from the type species by its thick velvety periostracum on the surface and in being surrounded by prominent spiral cords. *Ancistrolepis hiranoi* Shikama, 1962, is an absolute synonym of *A. fujitai* Kuroda.

The writer has observed and figures here the radulae of *Parancistrolepis kinoshitai* (Kuroda) and *Ancistrolepis fujitai* Kuroda tentatively assigned to the genus *Parancistrolepis* by Azuma. These two species have the same radular formula, suggesting they belong to the same genus as follows:

In *Parancistrolepis kinoshitai*, the central tooth is subquadrate in shape and has three small cusps at its hind margin and the marginal tooth is large and transversely broad and has eight to ten cusps.

In *Ancistrolepis fujitai*, the central tooth has four small cusps and the marginal tooth 14 cusps just as does the type species.

The radula of *fujitai* does not agree well with that of the genus *Ancistrolepis* Dall, 1895, in spite of the close resemblance of its shell features. Therefore, we assign it to *Parancistrolepis* Azuma, 1965.

An examination of the anatomy of *Ancistrolepis grammata* (Dall, 1907) shows the radula of the genus *Ancistrolepis* has a four-to-six-cuspidate central tooth and a four-cuspidate marginal tooth. Unfortunately, the radula of *Ancistrolepis eucosmia* (Dall, 1891), the

type species of the genus *Ancistrolepis*, has never been examined.

The genus *Parancistrolepis* is a peculiar group in having the thin shell ornamented by prominent spiral cords and covered by a thick periostracum, in having an extremely small operculum, and by its marginal tooth having many cusps. These features are far apart from the related subfamilies Neptuneinae and Ancistrolepisinae. I therefore establish a new subfamily *Parancistrolepisinae*.



Fig. 1. *Parancistrolepis fujitai* (Kuroda) from off Kushiro, Hokkaido Island, Japan.

## LITERATURE CITED

- Azuma, M. 1965. On the Radulae of *Ancistrolepis kinoshitai* (Kuroda) and *A. trochoideus ovoideus* Habe & Ito. Jap. Jour. Malac., Venus 24(2): 127-129, text figs. 1-2.
- Habe, T. & Ito, K. 1965. Shells of the World in color, vol. 1 (The North Pacific) 176 pp., 56 pls. Hoikusha, Osaka.
- Kuroda, T. 1931. On the Japanese Species of the Chrysodomid Whelk, *Ancistrolepis* and *Japelon*. Venus 2(5): 221-234, text figs. 1-18.
- Shikama, T. 1962. On some Noteworthy Shells from off Choshi, Chiba Prefecture. Sci. Rep. Yokohama Natl. Univ., (2)8: 29-86, pls. 1-3.

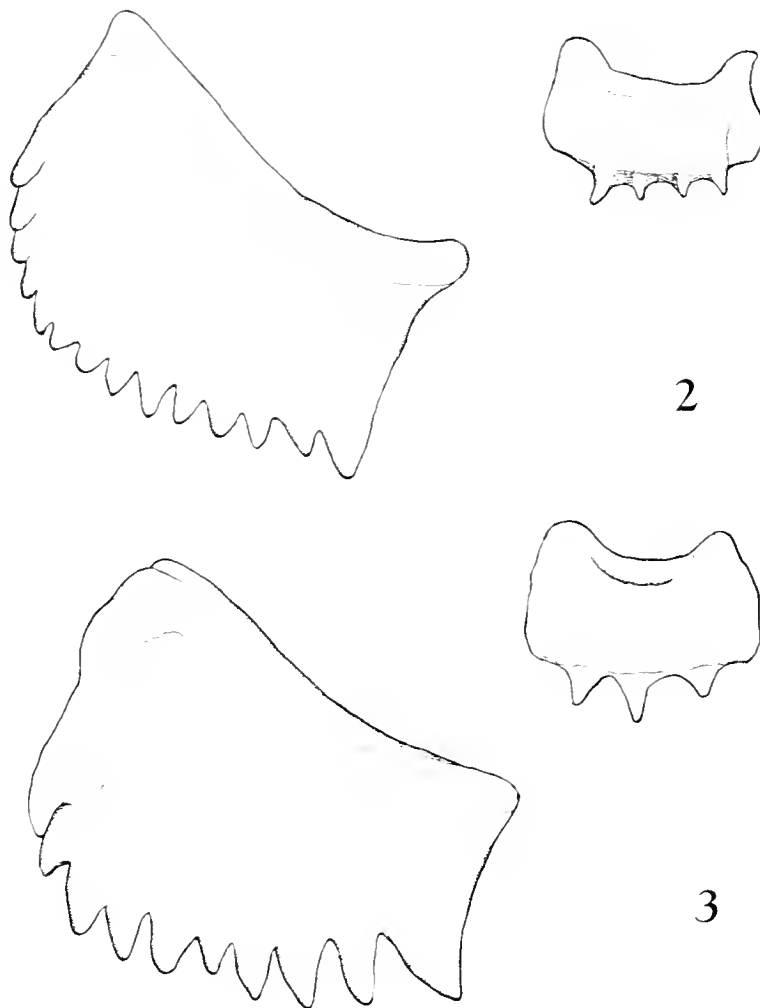

Fig. 2. Half row of radula of *Parancistrolepis fujitai* (Kuroda) from off Kushiro, Hokkaido Island, Japan.

Fig. 3. Radula of *P. kinoshitai* (Kuroda) from Enshunada, Honshu Island, Japan.

**BERTHELLA KANIAE, A NEW OPISTHOBRANCH FROM  
THE EASTERN PACIFIC**

**Gale G. Sphon**

Los Angeles County Museum of Natural History  
Los Angeles, Calif. 90007

**ABSTRACT**

*Berthella kaniae* Sphon, a member of the opisthobranch family Pleurobranchidae, is described as a new species from Isla Siboga, Perlas Islands, Panama (type locality) and Punta Mita, Nayarit, Mexico. It is close to *B. sideralis* (Lovén) and *B. californica* (Dall).

A new species of *Berthella* was collected by the author from Punta Mita, Nayarit, Mexico, in 1960, and through the kindness of Mrs. K. B. Meyer of the Smithsonian Tropical Research Institute in Panama, a second specimen was obtained from the Perlas Islands, Panama. I take great pleasure in naming this species for her.

***Berthella kaniae* new species**

Figs. 1-8

*Description* - Ground color translucent, ranging from deep yellow to almost white. Color more intense on dorsum; fading along edges of mantle. Tips of frontal veil, rolled rhinophores, and area around genital aperture colored reddish brown. Notum, gill, sides and frontal veil spotted with same reddish brown color. Notum (of holotype) covered with white powdering seen only under 10 magnification. Shell located mid-dorsal area, wholly internal, thin, delicate, translucent, white; haliotiform in shape. Ventral side of shell iridescent. Umbo small, spire of two small whorls. Sculpture of very fine irregular growth lines radiating from umbo region and showing through shell. Gill rachis smooth; 18 leaves on the dorsal half. Genital opening simple without lobule; located in front of gill. Radula 80 rows with 100-105 teeth per half row. No rachidian tooth. Dental formula, 80(100-105.0.105-100). Teeth equal in size for entire half-row except for the outermost 3 or 4 which get progressively smaller. Curve of hook of individual lateral teeth remains constant. Mandibular plates with approximately 58 rows and about 37 platelets per

row. Scales of platelets approximately equal-size except for the outermost 4 or 5 which become progressively smaller. No denticles or barbs on the platelets.

*Type material* - Holotype: California Academy of Sciences Invertebrate Zoology Type collection no. 560 consists of the entire animal and an egg mass that was laid after the specimen had been collected from 15-30 feet, Isla Siboga (type locality), Perlas Islands, Panama, by Joyce Young on February 15, 1972. It measured 13 X 6.5 mm. when alive and fully relaxed. The preserved animal measures 9 X 5.5 mm. Color transparencies of the holotype (CASIZ slide collection 2741) and of the paratype (CASIZ slide collection 2742) have also been deposited with the California Academy of Sciences. Both photos were taken of the animals in life. Paratype: Los Angeles County Museum of Natural History, Invertebrate Zoology type collection no. 1453 consists of the shell, a radula slide and a slide of the jaw plates. The paratype was collected by the author in 2 feet of water on the underside of a dead coral head at Punta Mita, Nayarit, Mexico, on January 21, 1970. Color transparencies of both the holotype and paratype have also been deposited at the Los Angeles County Museum of Natural History.

*Discussion* - There are two other species of *Berthella* known to occur in the eastern Pacific: *Berthella sideralis* (Lovén, 1846) and *Berthella californica* (Dall, 1900). The simplest, and most artificial, way to separate *B. kaniae* from these two species is on the basis of distribution and color. *Berthella*

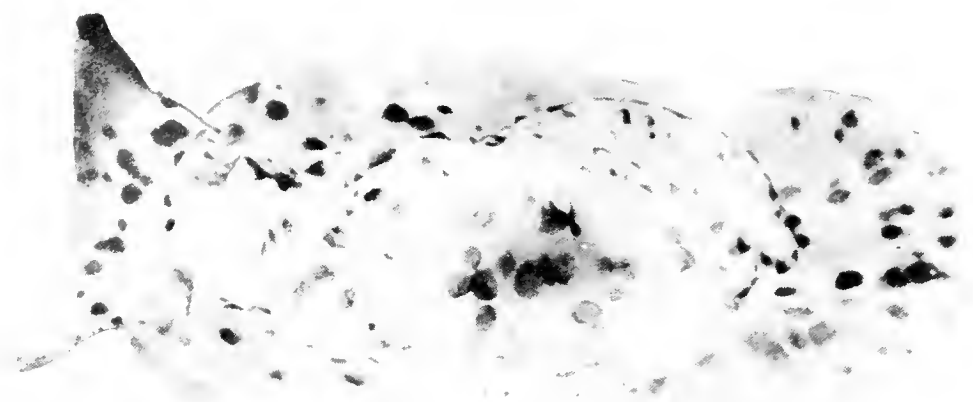

1

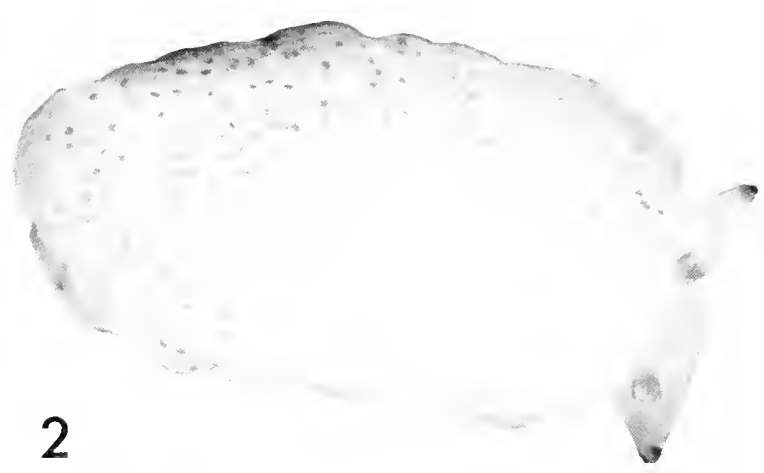

2

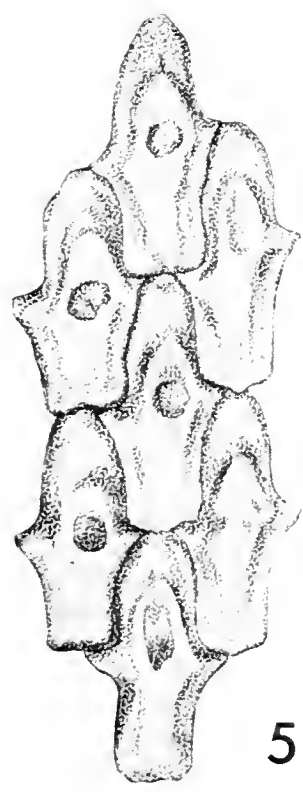

5



3

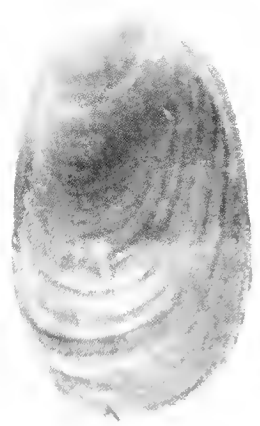

4

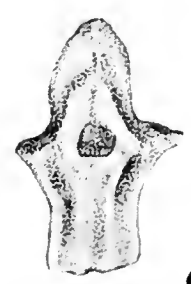

6

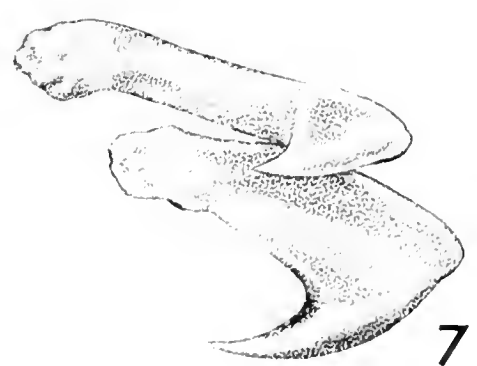

7

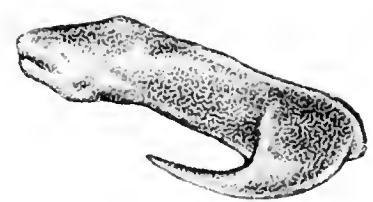

8

*sideralis* was originally described from the Norwegian coast and later collected by Dall (this was questioned by MacFarland, 1966) from 25 fathoms off Unalaska, Alaska. *Berthella californica* ranges from Crescent City, Del Norte County, to La Jolla, San Diego County, California. *Berthella kaniae* is a tropical-subtropical species found in Nayarit, Mexico, and the Perlas Islands, Panama. Both *B. sideralis* and *B. californica* are white in color. *Berthella kaniae* has a yellowish ground color and is tipped and spotted with reddish-brown.

Illustrations by MacFarland (1966, pl. 13) show the median lateral radular tooth of *Berthella sideralis* to be thin, narrow and have a slight bend at the tip. This varies along the half row to rather short, stubby, hooked innermost teeth. The outermost teeth have only a slight bend and no hook at the end of a long narrow tooth. MacFarland's illustrations (from Bergh, 1904) for the radular teeth of *Berthella californica* illustrate almost sickle shaped teeth. *Berthella kaniae* has little variation along the entire half row of teeth, but the teeth are sharply hooked. None of the three species appear to have serrations on the teeth margins.

The mandibular platelets of all three species are of comparable shape, but those of *Berthella sideralis* are serrated while both *B. californica* and *B. kaniae* are smooth. The shells of all three species are comparable in form.

*Acknowledgments* - I am extremely grateful to Mrs. Kaniaulono B. Meyer for supplying the holotype specimen, photo and data which made it possible to complete the description. I also wish to thank Mr. David K. Mulliner for permission to use his photograph of the paratype.

On May 19, 1972 (after the original submitting of this paper) a third specimen of *Berthella kaniae* Sphon was found in 15 feet of water at Isla Siboga, Islas de las Perlas, Bay of Panama. The animal was nestled in a crevice on the underside of a small clump of the coral *Pocillopora* sp. and as it was being pried out with a knife, it autotomized a large piece of the notal border. By the time the animal was removed, a second piece had been cast off so that the whole notal border (about half the entire notum) was missing from the animal. Figure 1 of the holotype clearly shows that that specimen had also autotomized its notal border. Although the phenomena of autotomy appears frequently in the nudibranchs and sacoglossans as a defensive mechanism, to my knowledge this is the first report of it occurring in the pleurobranchs.

#### LITERATURE CITED

- Bergh, L. S. R. 1904. Malacol. Unters. Semper Sct. 9, 6 (3): 119-181.
- Dall, W. H. 1900. A new species of *Pleurobranchus* from California. The Nautilus 14 (8): 92-93.
- Lovén, S. L. 1846. Index Moll. Litora Scand. Occidentalis habitantium. Öfvers. Kgl. Vet. - Akad. Förhandl. 3: 136-140.
- MacFarland, F. M. 1966. Studies of opisthobranchiate mollusks of the Pacific coast of North America. Mem. Calif. Acad. Sci. 4: 1-546.

---

Figs. 1-8. *Berthella kaniae* Sphon, new species. Fig. 1, Holotype (CASIZ 560, X7). Fig. 2, Paratype (LACM 1453). Fig. 3, Shell of paratype, dorsal view (X7.5). Fig. 4, Shell of paratype, ventral view (X7.5). Fig. 5, Group of mandibular platelets (from paratype). Fig. 6, Single mandibular platelet (from paratype). Fig. 7, Pair of lateral teeth (from paratype). Fig. 8, Single lateral tooth (from paratype).

A NEW SPECIES OF *HUMBOLDTIANA* (HELMINTHOGLYPTIDAE)  
FROM THE SIERRA VIEJA MOUNTAINS OF TEXAS

E. P. Cheatum

Department of Biology, Southern Methodist University,  
Dallas, Texas 75222

ABSTRACT

*Humboldtiana fullingtoni* Cheatum, a new pulmonate species, and the tenth species of this genus recorded from the Texas Trans-Pecos mountainous area, is described from 5,000 ft., southern end of the Sierra Vieja Mountains, Presidio Co., about 40 miles SSW of Valentine, Texas. It is closest in shell morphology to *H. hoegeana praesidii* Pilsbry. Its soft parts are grayish brown, while those of other Texas species in the genus are yellow, orange or golden. Significant distinguishing characters in the genus are discussed.

*Humboldtiana fullingtoni* new species

Figs. 1, 2, 3

*Description of holotype* - Shell rather thin, subglobose and slightly depressed; ornamented by three, wide dark-brown bands on the basal whorl; two bands at the beginning of the penult whorl, the lower of these two fading out, thus leaving only the upper band which gradually fades out about one-half turn from the embryonic whorls. Width of the bands on basal whorl (measured just back of the lip): upper 4.0 mm.; middle 4.3; and lower 4.6. With the exception of rather close-set growth lines, some of which are marked with whitish streaks and splotches, shell smooth and devoid of distinct granulations, although under high power very minute granulations are visible. Inner basal portion of peristome strongly reflected over the umbilicus in the form of a slightly rolled-over triangular plate. Narrow umbilical chink not visible from a direct apertural view. Embryonic whorl convex and the initial one-half embryonic whorl smooth; following whorl marked with minute irregularly-arranged radial and slightly curved striae. Inner lip slightly thickened; ground color of inner apertural wall the same wood-brown of outer shell and broken by dark bands on the basal whorl. Shell height: 31.2 mm.; diameter: 38.6 mm.; apertural height: 23.6 mm.; apertural width: 21.2 mm.; spiral angle:  $122^\circ$  (using Parodiz measuring methods, 1951); sutural angle:  $2^\circ$ ; columellar angle:  $15^\circ$ ; 4 whorls.

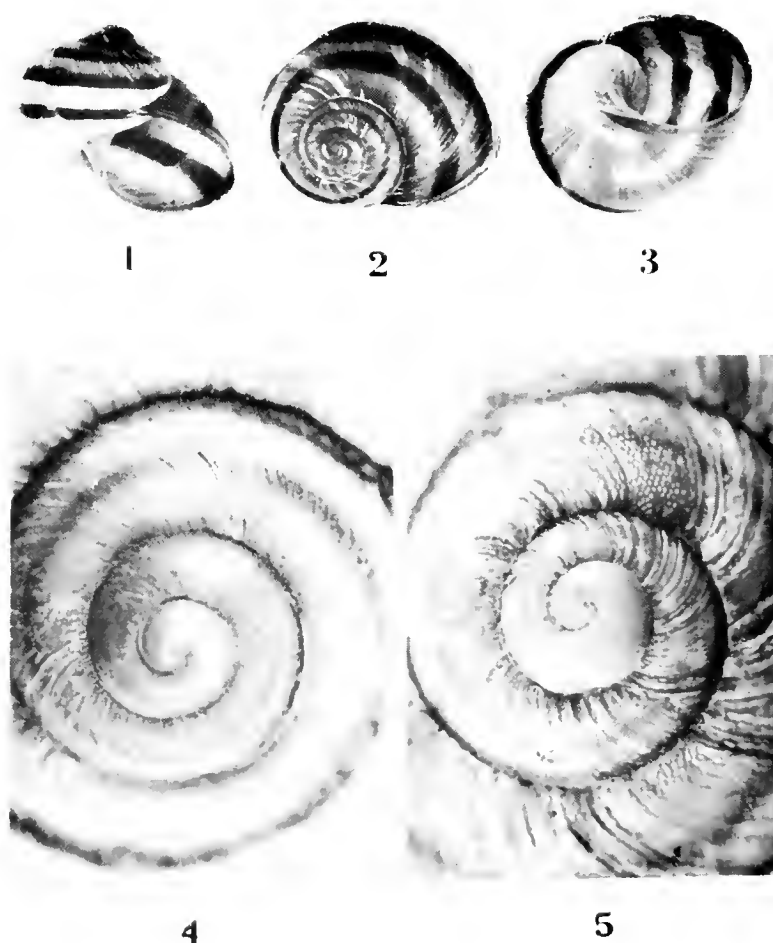

FIGS. 1, 2 and 3, *Humboldtiana fullingtoni* Cheatum, new species. Holotype, 31.2 mm. in height, 38.6 mm. in width. Apical views of *H. ferrissiana* (fig. 4) and *H. chisosensis* (fig. 5).

Living animal uniform fuscous. When withdrawing into the shell the animal discharges a considerable quantity of a clear, frothy viscous substance. The animal when fully extended measured approximately 65 mm. in length.

Holotype: No. 2186 - 5A Dallas Museum of Natural History; paratypes M.C.Z.; USNM 706882; University of Michigan Museum of Zoology; Carnegie Museum; and the Academy of Natural Sciences of Philadelphia.

#### COMMENTS

The new species, *Humboldtiana fullingtoni*, was collected April 20, 1971, at an altitude of approximately 5,000 ft. along the rimrocks overlooking the Rio Grande River near the southern end of Sierra Vieja Mountains in Presidio County, Texas. The type locality is situated about 40 miles south-southwest of Valentine, Texas.

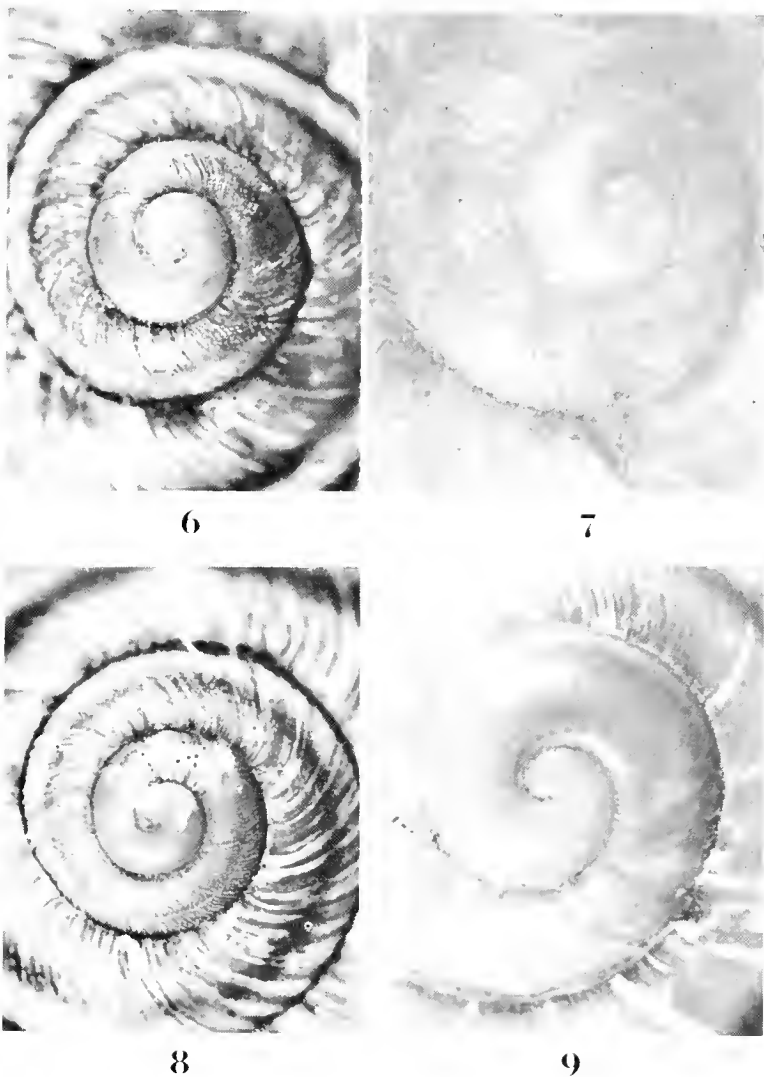

FIGS. 6-9, Apical views of *Humboldtiana cheatumi* (fig. 6), *edithae* (fig. 7), *H. agavophila* (fig. 8), and *H. fullingtoni* (fig. 9).

The snail-collecting expedition was conducted under auspices of the Dallas Museum of Natural History, Mr. Hal Kirby, Director. The first *Humboldtiana* were discovered by Mr. Richard Fullington, Curator of Invertebrates at the Museum and I am naming this species in his honor. Most of the ten living snails and twenty-four "bones" collected were found at depths of one and one-half to over three feet between and beneath rocks. The living snails were attached to rocks and the dead shells were dug out of dirt and humus at the above depths. The soil and humus even at these depths were powder-dry since the last rainfall received in that area had occurred the preceding September. Some of the living snails had secreted as many as four apertural epiphragms in order to prevent water loss.

In size this new species conforms with four other species - *H. edithae* Parodiz which was collected on Mt. Emory in the Chisos Mountains, *H. agavophila* Pratt, collected at Laguna Meadow just west of Mt. Emory, *H. cheatumi* Pilsbry collected in the Davis Mountains; and, (in the collections at the Dallas Museum of Natural History two shells) *H. chisosensis* Pilsbry which measure 39 mm. in diameter. The latter were collected by Mr. E. H. Miner in 1951, but the precise locality in the Chisos range was not given. As more shells of *Humboldtiana* are collected, undoubtedly the size range of the various species will be extended.

Although the color bands of *H. fullingtoni* show considerable variation in width, all are dark-brown in color. In one large, partly broken, fresh shell the interspace between the middle and lower bands is whitish and this wide whitish area extends around the basal whorl. This shell, compared with other specimens collected at the same place, exhibits extreme variation in the width of color bands. Measurements of the bands (just back of the lip): upper, 3.7 mm.; middle, 1.7; and lower 6.3. Such variation precludes the use of color band width as a distinct taxonomic feature. In all the other shells the ground color is of a uniform light-brown with the exception of the whitish streaks and splotches which are irregular in distribution.

According to Pilsbry's (1939) description of *H. höegeana praesidii*, *H. fullingtoni* conformed closer to this subspecies than any other species described for the genus. Since I had not had the opportunity of examining the type of *H. höegeana praesidii* (U. S. N.

TABLE 1. Measurements of Paratypes in mm.

| Diameter | Height | Aperture Height | Apertural Width | Whorls |
|----------|--------|-----------------|-----------------|--------|
| 36.0     | 30.15  | 18.8            | 22.2            | 4      |
| 35.8     | 31.3   | 18.25           | 22.4            | 3½     |
| 37.5     | 32.6   | 22.8            | 19.0            | 3¾     |
| 37.1     | 31.8   | 20.7            | 22.6            | 3¾     |
| 38.0     | 31.2   | 19.9            | 23.2            | 3½     |
| 36.5     | 31.1   | 18.3            | 21.4            | 3½     |
| 35.2     | 31.7   | 18.8            | 21.4            | 3½     |
| 35.8     | 29.8   | 19.1            | 20.6            | 3¾     |
| 38.1     | 33.6   | 24.5            | 23.5            | 4      |

M. 134160), I asked Dr. Harald Rehder, Senior Zoologist, Division of Mollusks at the U. S. N. M. to compare a paratype of *H. fullingtoni* with the type shell of *H. hoegeana praesidii*. After a careful examination of the two shells, Dr. Rehder made the following comments (Correspondence, June 29, 1971): "Your species is indeed closer to this subspecies than to any other Texas form . . . The apical whorls of *H. fullingtoni* do show under high power fine riblets that are faintly granulated in places. On the third whorl these granules increase in strength and then on the penultimate whorl they disappear. In *H. hoegeana praesidii* this granulation appears to be much more obscure, though our specimens, including the type, are rather worn and this granulation may have been rubbed off. Your new species is furthermore larger and darker in color, with the bands wider than in *H. hoegeana praesidii*".

Apical views of *H. ferrissiana*, *H. chisosensis*, *H. cheatumi*, *H. edithae* and *H. agavophila* (figs. 4, 5, 6, 7 and 8 respectively) show the distinct shell granulations in contrast to Fig. 9 of *H. fullingtoni* in which granulations are absent.

In living snails of the Texas *Humboldtiana* which we have had the opportunity to examine, all have had various parts of the body either a yellow, orange or golden color. The color of the living animal of *H. fullingtoni* is a uniform fuscous or grayish brown.

When considering shell characteristics of the various species of Texas *Humboldtiana* it seems that the most reliable distinguishing characters to be used are the presence or absence of visible granulations, shape of the granulations, smoothness or ornamentation of the embryonic whorls, their shape (flat or rounded), ground and band color of the shell and shell angles.

Shell color and markings must be based upon fresh shells. In old shells the periostracum is so frequently eroded so as to completely obliterate granulations and other distinctive shell markings.

Ten species of *Humboldtiana* have now been described from the mountainous areas of the Texas Trans-Pecos, and these are the following Pilsbry (1939):

- Humboldtiana chisosensis* Pilsbry
- Humboldtiana ferrissiana* Pilsbry
- Humboldtiana hoegeana praesidii* Pilsbry
- Humboldtiana cheatumi* Pilsbry
- Humboldtiana palmeri* Clench and Rehder
- Humboldtiana texana* Pilsbry
- Humboldtiana ultima* Pilsbry

Pratt (1971), described *Humboldtiana agavophila* from the Chisos Mts.; Parodiz (1954) described *Humboldtiana edithae* from Mt. Emory in the Chisos Mts.; and this species, *Humboldtiana fullingtoni* is the tenth species to be described from the Texas Trans-Pecos. Pilsbry (1927), had listed *H. chisosensis*, *H. texana* and *H. ultima* from Texas. In his key, based upon shell characters, the major breaks involved granulations and whether or not the shell was smoothish or with wrinkles along the growth lines. *H. hoegeana praesidii* and *H. fullingtoni* appear to be the only Texas *Humboldtiana* without any traces of visible granulation.

It is my opinion that the taxonomic status of the species under the genus *Humboldtiana* is debatable. It is hoped that in the not too distant future careful morphological studies of the soft parts will help to clarify the taxonomic "picture".



## LITERATURE CITED

- Pilsbry, H. A. 1927, "The Structure and Affinities of *Humboldtiana* and related Helicid Genera of Mexico and Texas", Proc. Acad. Nat. Sci. Phila. **79**: 165-192.
- Pilsbry, H. A. 1939, "Land Mollusca of North America (North of Mexico)", **1**, Part 1: 395-410.
- Pratt, Lloyd 1971, "*Humboldtiana agavophila*, A New Helminthoglyptid Land Snail from the Chisos Mountains, Big Bend National Park", Southwest Naturalist **15** (4): 429-435.
- Parodiz, Juan J. 1951, "Methods de conchiliometria", Physis, Buenos Aires, No. 58, **20**: 241-248.
- Parodiz, Juan J. 1954, "A New Species of *Humboldtiana* from Texas", The Nautilus **67**: 107-108.

## BOOK REVIEW

AUSTRALIAN SHELLS, *illustrating and describing 600 species of marine gastropods found in Australian waters. By Barry R. Wilson and Keith Gillett, with a preface by R. Tucker Abbott. 168 pp., 106 polychrome plates, 34 monochrome figures; page size 9 by 11½ inches. Charles E. Tuttle Co., Rutland, Vermont 05701, 1971. \$21.50.*

Biologist Barry Wilson and photographer Keith Gillett have combined their talents to produce a profusely illustrated and informative handbook on the shelled gastropods one would most likely encounter by shore collecting and diving in Australian waters. The introductory text includes brief discussions of the classification, nomenclature and biology of mollusks in general.

A plea is made for the conservation of Australian mollusks, before irresponsible collecting reduces readily accessible shores near populated areas "... to barren biological deserts..." In this regard, they cite California as an example where "... some seaboard schools and universities have to import specimens from other areas or take their students to places hundreds of miles away before they are able to look at living animals instead of only seeing pictures of them in books," a condition, unfortunately, not limited to our west coast.

For each family, a brief introduction including distributional, biological, and ecological data, is given, together with a description of each species figured on the full-page, color plates, which are conveniently placed facing the text. Limitations of space have per-

mitted the inclusion of only 600 species; for example of the 23 species of abalones living in Australian waters, 12 are illustrated in the book. The descriptions include data on size, range, and abundance, together with synonymous names that have been used for Australian forms.

This book is outstanding for the numerous color photographs and line drawings of living mollusks. Hopefully, the inclusion of biological and ecological data in this book will stimulate collectors to observe and record such information, and to be more restrictive in the selection of specimens for their cabinets. The authors suggest that only a few well-preserved specimens of a species should be taken, and they recommend that females associated with eggs should be left undisturbed.

There are few errors of commission for an undertaking of this magnitude. Parts of the text are somewhat out of date. Some of the nomenclature is not current. However, in most cases, the familial groups requiring nomenclatural changes are undergoing intense study by malacologists, and specialists have proposed differing classifications, as in the case of the family Muricidae.

This beautifully illustrated book is highly recommended to anyone seeking information on the marine life inhabiting Australian coastal waters.

*William K. Emerson*  
Chairman and Curator  
Department of Living Invertebrates  
The American Museum of Natural History



*Fig. 1. Photograph of Tom Iredale taken in September, 1938.*

## TOM IREDALE (1880-1972)

Winston F. Ponder and Gilbert P. Whitley  
The Australian Museum  
6-8 College St., Sydney, Australia

The name Tom Iredale will be familiar to most zoologists and certainly to all malacologists and ornithologists. Iredale was a remarkable man, for in his long career he published over 360 papers and articles and erected more than 2,600 new taxa. He worked not only on molluscs and birds but also published papers on mammals and fishes. Iredale has been called the "Australian Linnaeus" - an apt title for a man of his talents.

Iredale was born in Cumberland, England, on 24 March, 1880, and, when 21 years of age, sailed for health reasons to Christchurch, New Zealand. He became friends with W.R.B. Oliver, with whom he visited the Kermadec Islands in 1908. While on the Kermadec Islands he made a life-long friend of Roy Bell who collected large quantities of material for him on Lord Howe and Norfolk Islands, in Victoria and southern New South Wales. While in New Zealand he published his first three papers in the *Transactions of the New Zealand Institute* (1907, 1908).

Iredale left New Zealand in 1908 to return to England, but on the way Charles Hedley persuaded him to stay for the Australian Association for the Advancement of Science Congress in Brisbane. Thus in February, 1909, Iredale had a first-hand experience with Queensland molluscs by collecting at Caloundra and also Port Curtis.

From 1909 Iredale spent much time in the British Museum (Nat. Hist.) as a freelance worker, identifying birds and molluscs. He worked with Mathews on *Birds of Australia* and wrote several papers dealing mainly with molluscan nomenclatural and bibliographic problems. One of his finest efforts was his critical commentary on Suter's *Manual of the New Zealand Mollusca*, published in 1915. He also helped Sherborn with his great *Index Animalium* and collaborated with C. D. O'Donoghue to produce a *List*

of *British Nudibranchiate Mollusca*, which was published in 1923. He considered his most spectacular molluscan discovery to be *Sherbornia mirabilis*.

In April, 1920, H. E. Gregory, the Director of the Bernice Pauahi Bishop Museum at Honolulu, offered Iredale a position on the Museum Staff, but this was not accepted.

In 1923 Iredale came to Sydney for the Pan Pacific Science Congress and went on a collecting trip to Victoria with Pilsbry, who was also in Australia for the Congress. Pilsbry, some years later, wrote to Iredale (19th July, 1928):-

"Do you still ride on those market trains, such as that we took from Port Phillip? I have never really liked pigs since that ride in the society of so many dead ones."

"I think it wonderful of you and Basset Hull to dedicate your Chiton (excuse me! Loricata) book to me. Of course I think you make the genera too small, but this is a mere matter of opinion . . ."

Iredale was to cause a lot of controversy with his philosophy on genera and species. After his arrival in Australia in 1923, he published a paper based on Roy Bell's collections from Twofold Bay, southern New South Wales, in which he erected 111 new names.

After working with Hedley at the Australian Museum, he was appointed to the position of Assistant to Joyce Allan in the Conchology Department in 1924. In the same year he was appointed to the position of Conchologist and was assisted by Joyce Allan, with Phyllis Clarke engaged as artist. Hedley left the Australian Museum in 1924 to become the Director of the Great Barrier Reef Committee, a position which he occupied for two years before his death. In Iredale's early days at the museum two other well-known conchologists, John Brazier and Thomas Whitelegge, who had been retrenched during the de-

pression of 1893, also visited the museum from time to time.

Iredale's molluscan work at the Australian Museum was prolific and ranged from chitons to cuttlebones, marine borers to deepwater molluscs and land shells.

Although Iredale was basically a museum worker, he loved field work and considered this very important to gain a proper understanding of the animals on which he was working. He made several collecting trips to Queensland, including participating in the Great Barrier Reef Expedition in 1928 and 1929, and did much local collecting in New South Wales. He visited Lord Howe Island in December and January, 1931-2.

A bibliography and an index to his new names was provided in 1956 by McMichael and Whitley (*Australian Zoologist*, 12(3): 211-250) and one of us (G.P.W.) is currently revising this and preparing a more detailed account of Iredale's life and work.

Many find Iredale's work difficult because of his brief descriptions and seemingly casual introduction of new names. These people have probably not seen him at work using his unsurpassed knowledge of the literature, tracing back to their beginnings any species names under consideration. He never relied on published synonymies, everything was checked and rechecked with a book in one hand and a specimen in the other. Hours of observation and research were condensed, perhaps unfortunately, into a line or two. He never used a typewriter, all of his work being handwritten, including the finished manuscript. A number of unfinished manuscripts and notes are preserved in the Australian Museum.

Iredale's philosophy on generic groupings changed somewhat over the years. His classifications in earlier papers, strongly abused by some conservative contemporaries, are now often adopted as "modern classifications." In 1912 he wrote "I am convinced that all future workers, to produce any lasting results, must undertake monographic studies, and moreover, must

study series, note variation, also determine the subspecies from such series, and discriminate between species, subspecies and varieties. I foresee the time when there will be more genera, fewer species and more subspecies, with entire elimination of varieties." What could be closer to the approach of the modern taxonomist?

Unfortunately for Iredale, Australia has a vast fauna with many perplexing and exciting unknowns. Because of this, he was rarely able to live up to his desired standards, although, with the help of Hull, he produced excellent monographs of the Australian and New Zealand "loricates" which were completed in 1927 and 1932, respectively. Several important molluscan reference works were produced by Iredale, including lists of the Australian, Lord Howe and Norfolk Islands and Papuan land molluscs, the freshwater molluscs of Australia and the marine molluscs of New South Wales (with D. F. McMichael). His nomenclatural and bibliographic contributions result mostly from his period spent in the British Museum and after his retirement in 1944, he produced a number of bibliographic and historical accounts of Australian conchologists.

Up until the time of his death, on 12 April, 1972, at Curl Curl, a seaside suburb of Sydney, just after his 92nd birthday, Iredale was an Honorary Associate of the Australian Museum and except for his last four years, frequently worked in the museum. Many genera and species of molluscs, birds, fishes, etc., have been named after him, the last known to him was *Favartia (Murexiella) iredalei* Ponder, 1972.

Not only was Iredale's work extraordinary, but his sharp wit, coupled with unusual dress and a broad grin made him a personality few could forget. Perhaps most of all he will be remembered by those who knew him in Australia and elsewhere for his cheerful help and assistance which was given generously and willingly. Certainly many people will feel a deep personal loss at Tom Iredale's passing.

SHELL STRUCTURE IN *SPIRULA SPIRULA* (CEPHALOPODA)<sup>1</sup>

Ronald F. Thomas &amp; Frasier O. Bingham

University of Miami

Rosenstiel School of Marine and Atmospheric Science

Miami, Florida 33149

## ABSTRACT

*The external surface of the shell of Spirula exhibits laminar mesa-like projections suggesting deposition over an extended period. No pores, through which transfer of materials could take place, were seen in the siphuncle at a magnification of 10,000X.*

The small cephalopod *Spirula spirula* (Linnaeus, 1758) is rarely seen alive although its internal shell is commonly washed onto beaches in many parts of the world. The animal inhabits depths of 200-1500 meters (Voss, 1956) and is widely distributed (Bruun, 1943). The biology, function of the shell, vertical distribution and world-wide distribution, as known, have been covered in detail by Bruun (1943). The shell of *S. spirula* appears to be thin and fragile; however it has been found to withstand pressures between 2000 and 3500 p.s.i. without being crushed (Denton & Gilpin-Brown, 1971).

The ability of the animal to actively change the contents of completed chambers has been dealt with by several authors. Chun (1914) concluded that after a chamber was completely formed, there was no transfer of gases or liquids into or out of that chamber. Bruun (1943) thought that gases could pass through the siphuncle or shell. Denton & Gilpin-Brown (1971) note that some chambers of the shell contain liquids. It is their opinion that the animal is able to regulate the gas or liquid contents of the chamber and thus employ the shell in buoyancy control.

The surface structure of the shell and of the siphuncle have not previously been described. A lack of contrast and large sculpture on the shell surface makes it difficult to see the surface detail with a light microscope. The high resolution and depth of field of

the scanning electron microscope made it possible to observe the surface detail shown in this study. Presented here are scanning electron microscope photographs of the external sculpture of the shell of *S. spirula* as well as the internal structure of the siphuncle.

In large specimens of *S. spirula* the shell contains about 35 chambers. The first chamber formed by the animal (figures 1 & 2) is small, spherical and comparatively smooth. This chamber probably corresponds to the unsculptured protoconch of other molluscs in which shell growth after settling displays adult sculpture characteristics. The first chamber is somewhat separated from the remainder of the shell by a prominent constriction (figure 2). The second chamber (figure 2) exhibits traces of surface sculpture in the form of minute ridges scattered over the exterior surface. The sculpture on the second chamber is not so well developed as that seen on following chambers. Figures 3 & 4 show the ridges of the seventh chamber. These ridges are unconnected, mesa-like projections of the shell surface and are laminar in structure (figure 4). The ridges are tall and distinctly layered, indicating that their formation may involve periodic deposition through the lifetime of the animal. Appelloff (1893) found that the thickness of the external surface of a newly formed chamber increases during the addition of further chambers. The increased thickness seen by Appelloff (1893) is indicated by this study to be a consequence of periodic deposition of thin layers of  $\text{CaCO}_3$  on the tops of the mesa-like projections of the shell surface. In more recently formed chambers such as the 32nd chamber (figures 5 & 6), the ridges are not so well-formed as

<sup>1</sup>Contribution No. 1564 from the University of Miami, Rosenstiel School of Marine and Atmospheric Science, Florida 33149

those on the seventh chamber. They are set farther apart and arranged in a linear pattern parallel and perpendicular to the axis of shell growth. The laminar structure is still present although the ridges are not as highly elevated as in the earlier chambers. It appears to us that ridges are formed near the region of new shell growth and later additions of  $\text{CaCO}_3$  increase their size and obscure their original linear arrangement.

The external surface of the siphuncle was scanned at magnifications up to 10,000 X. The surface appeared smooth and no pores which would permit exchange between materials in the chambers and in the siphuncle were noted, but this does not exclude the possibility that such pores exist and are too small to show up at this magnification. The inner surface of the siphuncle is quite rough (figures 7 & 8) and the crystalline structure of the  $\text{CaCO}_3$  matrix is evident.



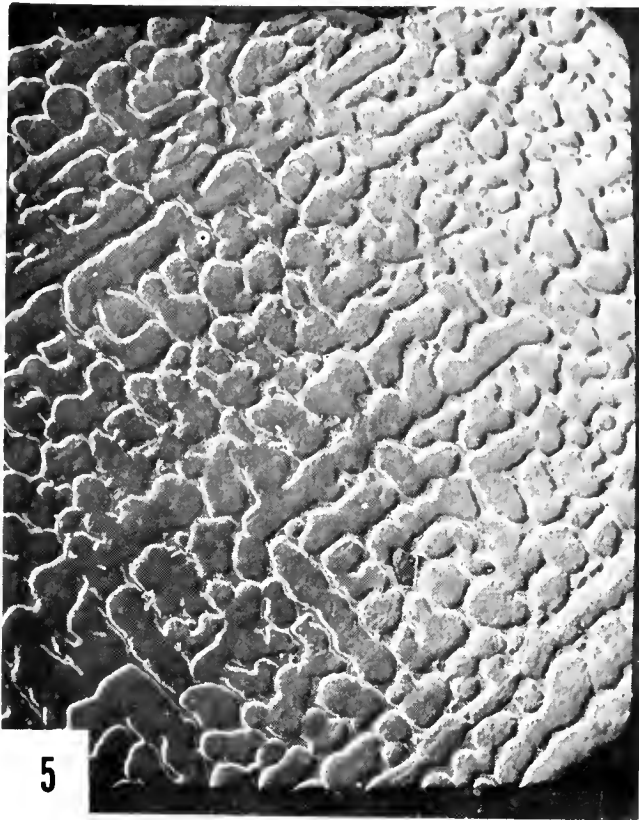

Fig. 1. The first 14 chambers of the shell of *S. spirula*. 20X. Fig. 2. The first and second chambers of the shell. 100X. Fig. 3. The seventh chamber. Note the numerous ridges that cover the entire surface. 100X. Fig. 4. A portion of figure 3, at higher magnification. Note the laminar structure of the ridge. 1,000X. Fig.

5. The smaller and linearly arranged ridges of the 32nd chamber. 50X. Fig. 6. Sculpture of the 32nd chamber. 200X. Fig. 7. Calcium carbonate crystals in the inner surface of the siphuncle. 2,000X. Fig. 8. Laminated calcium carbonate crystals. 5,000X.

## ACKNOWLEDGMENTS

We wish to thank Dr. Donald Marszalek and Mr. Wally Charm for their assistance and operation of the scanning electron microscope. This work was supported in part by National Science Foundation grant GB-24994X.

## LITERATURE CITED

Appelloff, A. 1893. Die Schalen von *Sepia*, *Spirula* und *Nautilus*. Kongl. Svenska Vetenskaps-Akademiens Handl. **25**: 1-106.

Bruun, A. 1943. The biology of *Spirula spirula* (L.). Dana Report No. 24: 1-46.  
 Chun, C. 1914. Die Cephalopoden. II. Teil. Myopsida, Octopoda. Wissensch. Ergebn. Deutsch. Tiefsee-Exp. "Valdivia" 1898-1899, **18**: 405-552.  
 Denton, E. J. & J. B. Gilpin-Brown. 1971. Further observations on the buoyancy of *Spirula*. Jour. Marine Bio. Assoc. U. K. **51**: 363-373.  
 Voss, G. L. 1956. A review of the cephalopods of the Gulf of Mexico. Bull Marine Science **6**: 85-178.

## BOOK REVIEW

EDIBLE? INCREDIBLE! *By Marjorie Furlong and Virginia Pill. Paperback, 62 pp. (24 with full color). Ellis Robinson Publ. Co. April 1972. \$2.00. Obtainable from Mr. Tom Rice, Box 33, Port Gamble, Wa. 98364.*

This is a charming and colorful guide to the common edible invertebrates and seaweeds of the Pacific Northwest coast of North America. Clear colored photographs, succinct descriptions, habitats, and cooking hints are given not only for the plausible edi-

bles, such as clams, abalones and crabs, but also for the incredible gourmet delights, such as sea urchins, barnacles, sea cucumbers and chitons. Missing is a warning that over 200 venturesome people in North America have suddenly died of paralytic shellfish poisoning resulting from eating cooked mussels, clams and periwinkles at certain seasons in certain areas, especially in northern California and both sides of Canada.

*R. Tucker Abbott  
 Delaware Museum of Natural History*



THE AMPHI-ATLANTIC DISTRIBUTION OF *LITTORINA MELEAGRIS*Joseph Rosewater<sup>1</sup> and Geerat J. Vermeij<sup>2</sup><sup>1</sup> Division of Mollusks, Smithsonian Inst., Wash., D. C. 20560<sup>2</sup> Dept. Zoology, Univ. of Maryland, College Park, Md. 20742

## ABSTRACT

*The gastropod Littorina meleagris (Potiez and Michaud, 1838), is now known to be the second tropical species of Littorinidae found on both sides of the Atlantic. It has recently appeared in Bermuda, and the new West African records may be the result of a modern ship-borne introduction.*

*Littorina meleagris* (Potiez and Michaud, 1838) is a common western Atlantic littorinid gastropod living in close association with algal mats at mid to high intertidal levels (Lewis, 1960; Vermeij, in press a,b) (see figs. 3, 4). Bequaert (1943) gave the geographic range of the species as including southern Florida, the Bahamas, the Greater and Lesser Antilles, and the Caribbean coasts of Honduras and Colombia. Additional locality records in the collections of the National Museum of Natural History include Port Aransas, Texas; Quintana Roo, Mexico; Portete, Costa Rica (for locality see Houbriek, 1968); Devil's Beach, Panama Canal Zone; Curacao; La Orchila Id. (Rehder, 1962) and Catia la Mar, Venezuela; and Barbados. It was recorded from Bermuda by Abbott and Jensen (1967), who believed it to have been recently introduced there (see map).

While examining collections in 1968 at the Zoological Museum in Copenhagen, Rosewater noted the presence of *L. meleagris* among tropical West African material collected by the *Atlantide* Expedition in 1946 (Takoradi, Ghana) and by the *Galathea* Expedition in 1950 (Teshi, Ghana). The specimens were later borrowed for study through the courtesy of Dr. Jørgen Knudsen. The shells were all collected in dead condition, many containing hermit crabs, and were mixed with specimens of the morphologically similar *L. punctata* (Gmelin, 1791) (figs. 1, 2, 5, 6.).

In July, 1971, Vermeij collected living specimens of *L. meleagris* at Takoradi, in the western part of Ghana. Most specimens were found in algal turf in the low intertidal echinoid (*Echinometra lucunter*) zone in association with *Tricolia* sp., *Siphonaria pectinata* (Linnaeus, 1758), *Fissurella nubecula* (Linnaeus, 1758), and *Patella safiana* (Lamarck, 1819). Several additional specimens were collected in permanent, shallow, high intertidal pools, in which *L. punctata*, *L. cingulifera* (Dunker, 1845), and *Nerita atrata* Gmelin, 1791, were the dominant mollusks.

No other records are presently available for *L. meleagris* from West Africa, neither Nicklés (1950) nor Buchanan (1954) mentioning it in their surveys of the mollusks of Senegal and Ghana respectively. The species could not be found in collections from the 8 other localities visited by Vermeij in Ghana during June and July, 1971, nor were specimens collected by him in Senegal or Sierre Leone. The possibility therefore arises that *L. meleagris* is a recently introduced species in West Africa, especially since one of the two localities from which it is known (Takoradi) is a shipping port. The second locality

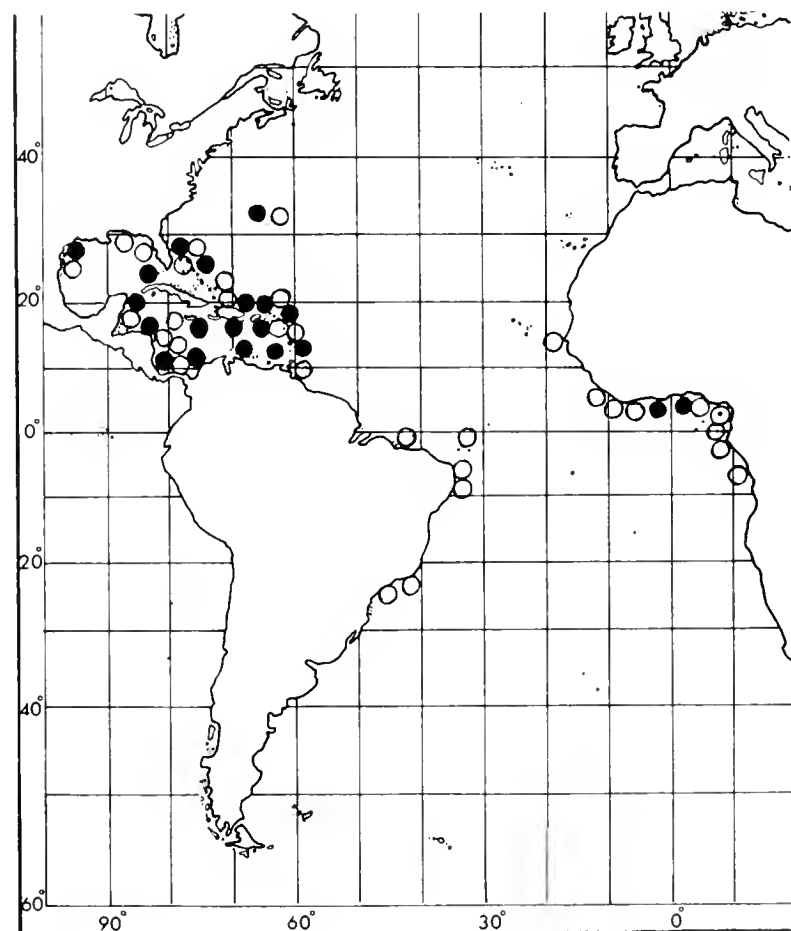

Map 1. Distribution of *Littorina meleagris* (solid dots) and *L. scabra angulifera* (open circles) in the eastern and western Atlantic.

(Teshi) lies between Accra and the new shipping port of Tema.

It is well-known that several boreal littorinids (*Littorina littorea*, *L. saxatilis* and *L. obtusata*) occur in both the eastern and western Atlantic. Up to now, only one tropical species, the mangrove-associated *L. scabra angulifera* (Lamarck, 1822), (see figs. 7, 8) was known to be amphi-Atlantic in distribution (Rosewater, 1970, pp. 455-458). The very restricted known range of *L. meleagris* in West Africa and the strictly tropical distribution of the species on both sides of the Atlantic contrasts strongly with the significantly greater latitudinal range of *L. s. angulifera* in both the eastern and western Atlantic (see map, also Bequaert, 1943; Nicklès, 1950). Briggs (1967) and Scheltema (1971) have noted that many amphi-Atlantic fishes and mollusks, like the two amphi-Atlantic tropical littorines, have a more restricted and often more patchy distribution in the eastern Atlantic as compared to the western Atlantic. This tendency may be related partly to the much narrower latitudinal extent of tropical water (Ekman, 1953) and more variable sea temperature regime in West Africa; as well as to the pattern of east-flowing surface ocean currents (Scheltema, 1971). In this connection, Lewis (1960) has pointed out that *L. meleagris* produces floating egg capsules which hatch into swimming veligers.

While *L. meleagris* was not included in a geographic distribution analysis of the rocky intertidal mollusks at Takoradi (Vermeij, 1972), the habitat characteristics of the species agree well with those of other amphi-Atlantic species at that locality. In general, species not restricted to the eastern Atlantic were found either to live cryptically beneath stones or in other locally sheltered habitats, or to be eurytopic with respect to shore level (Vermeij, 1972, in press, a).

Differences between populations of *L. meleagris* in the eastern and western Atlantic appear to be very little greater than between adjacent western Atlantic populations. Large numbers of specimens were not available for analysis, especially from West Africa; however, the following measurements are given (see Table 1).

#### LITERATURE CITED

- Abbott, R. T. and R. Jensen. 1967. Molluscan Faunal Changes Around Bermuda. *Science* **155** (3763): 687-688.
- Bequaert, J. C. 1943. The Genus *Littorina* in the Western Atlantic. *Johnsonia* **1** (7): 1-27.
- Briggs, J. C. 1967. Dispersal of Tropical Marine Shore Animals: Coriolis Parameters or Competition? *Nature* **216** (5113): 350.
- Buchanan, J. B. 1954. Marine Molluscs of the Gola Coast, West Africa. *Journal of the West African Science Association* **1** (1): 30-45.
- Ekman, S. 1953. *Zoogeography of the Sea*. Sidgwick and Jackson, Ltd., London, xiv + 417 pp.
- Houbrick, J. R. 1968. A Survey of the Littoral Marine Mollusks of the Caribbean Coast of Costa Rica. *The Veliger* **11** (1): 4-23.
- Lewis, J. B. 1960. The Fauna of Rocky Shores of Barbados, West Indies. *Canadian Journal of Zoology* **38**: 391-435.
- Nicklès, M. 1950. *Mollusques Testacés Marins de la Côte Occidentale d'Afrique*. *Manuels Ouest-Africains 2* Paul Lechevalier, Editor, Paris, X + 269 pp.
- Rehder, H. A. 1962. Contribucion al Conocimiento de los Moluscos Marinos del Archipelago de los Roques y La Orchila. *Memoria de la Sociedad de Ciencias Naturales La Salle* **22** (62): 116-138.

TABLE 1. Comparative measurements of Caribbean and Takoradi, Ghana, colonies of *Littorina meleagris*.

| Locality                                     | Jupiter, Florida | Curacao   | Santo Domingo | Takoradi  |
|--|------------------|-----------|---------------|-----------|
| No. of Specimens                             | 6                | 12        | 8             | 6         |
| Range of Lengths                             | 3.8 - 5.8        | 5.0 - 6.2 | 4.8 - 6.9     | 3.2 - 7.6 |
| Range of Widths                              | 2.6 - 3.5        | 3.0 - 3.9 | 3.0 - 4.3     | 2.2 - 4.3 |
| Range Aperture Lengths                       | 2.3 - 3.2        | 3.1 - 3.9 | 3.3 - 4.3     | 2.1 - 4.5 |
| No. Whorls (often eroded)                    | 3+               | 3+        | 5+            | 3+        |
| Average: Width/Length                        | .61              | .63       | .61           | .66       |
| Average: <u>Length</u><br>Length of Aperture | .57              | .61       | .65           | .64       |

- Rosewater, J. 1970. The Family Littorinidae in the Indo Pacific. Part I. The Subfamily Littorininae. *Indo-Pacific Mollusca* 2 (11): 417-506.
- Scheltema, R. S. 1971. Larval Dispersal as a Means of Genetic Exchange Between Geographically Separated Populations of Shallow-water Benthic Marine Gastropods. *Biological Bulletin* 140: 284-322.
- Vermeij, G. J. 1972. Endemism and Environment: Some Shore Molluscs of the Tropical Atlantic. *The American Naturalist* 106 (947): 89-101.

- Vermeij, G. J. In Press, a. West Indian Molluscan Communities in the Rocky Intertidal Zone: A Morphological Approach. *In* Smith, R. A. (Ed.), Thomas F. Goreau Memorial Volume. University of Miami Press.
- Vermeij, G. J. In Press, b. Morphological Patterns in High Intertidal Gastropods: An Essay on Adaptive Strategies and Their Limitations. *Marine Biology*.

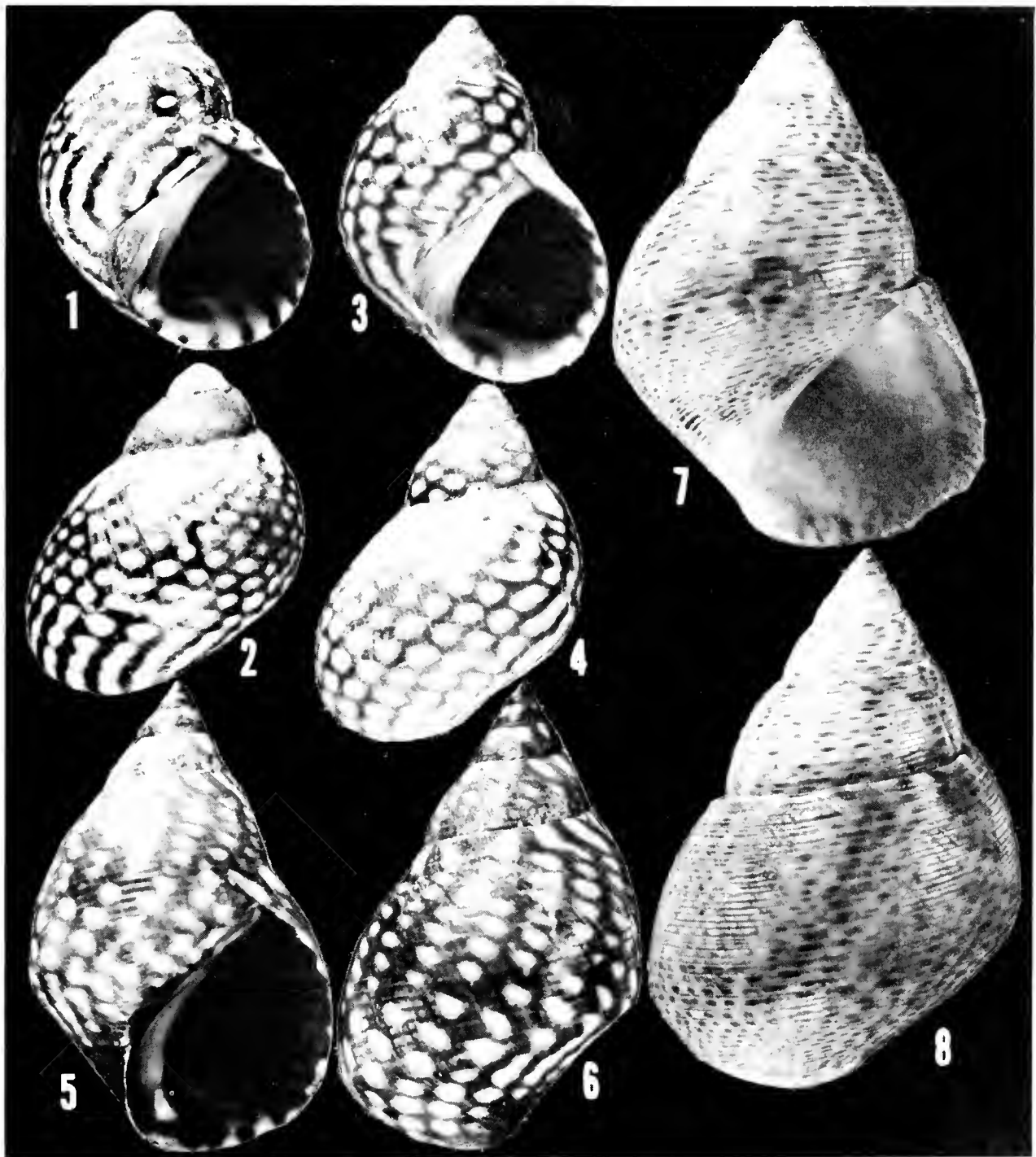

Fig. 1-4, *Littorina meleagris*. 1, 2 from Takoradi, Ghana, USNM 707154, 6.4 mm. length. 3, 4 from English Harbor, Antigua, USNM 423627b, 6.8 mm.

Fig. 5, 6, *Littorina punctata*, from Cotonou, Dahomey, USNM 707160, 10.5 mm. Fig. 7, 8, *Littorina scabra angulifera*, from Monrovia, Liberia, USNM 673999, 22.6 mm.

TERATOLOGICAL *LITTORINA SCABRA ANGULIFERA*

Joseph Rosewater

Division of Mollusks

Smithsonian Institution

Washington, D. C. 20560

The occurrence of monstrosities in Littorinidae is well-known, especially in the boreal species, *Littorina littorea* (Linné), *L. obtusata* (Linné), and *L. saxatilis* (Olivi) (Jeffreys, 1865, pp. 354-376; 1869, pl. 65; S. V. Wood, 1848, pp. 118, 119, pl. 10, fig. 14, a-k; Reeve, 1857, pl. 4, fig. 18a; Dautzenberg and Fischer, 1914, pl. 3; Bequaert, 1943, pl. 3, fig. 7.) Anomalies of the shell apparently result either from injuries or genetic aberrations and show up as sculptural defects, changes in direction of coiling, or other obvious malformations. Readily visible anomalies of the animal consist of branching or other abnormalities of the tentacles and penis, and many others have been noted (Pelseneer, 1920). It seems probable that the considerable frequency with which teratological *Littorina littorea* was reported in Great Britain reflects the fact that hundreds of tons of this species were collected for food and that "pennywinkle" mongers were responsive to conchologists who paid well for unusual specimens. A number of such specimens from Billingsgate Market, England, are present in the Jeffreys Collection in the National Museum of Natural History.

Variation in shell morphology often is extremely prevalent in some species of tropical Littorinidae (see Rosewater, 1970, pl. 352). Anomalous individuals seldom have been reported, however, and it is not known whether this is because they occur with less frequency in the tropics or simply have not been discovered. An extremely turreted individual of *Littorina scabra angulifera* (Lamarck, 1822) (figs. 1, 2) was collected from Island SQ 1, near Squirrel Key, Monroe County, Florida, by D. Simberloff, on June 19, 1969. A large population of the species was present on Red Mangrove. Although the malformation is extreme, when the specimen was first seen it was easily recognized as *L. scabra angulifera*. An inquiry was made of the collector, through Dr. W. Heard, Florida State University, Tallahassee, Florida, to determine whether or not any other specimens exhibiting this phenotype had been observed. The figured specimen was the only one seen. A subsequent examination of the collection of this species in the National Museum of Natural History yielded one additional, smaller,

similarly malformed specimen, also from Florida, but with no definite locality (figs. 3, 4). A perusal of the reported and figured teratological specimens of Littorinidae shows the turreted anomaly to be rather common. The Squirrel Key specimen may be the result of a genetic defect since the turreted condition is present in the earliest post-nuclear whorls of the shell, the protoconch being missing. The "Florida" specimen may have resulted from an injury because the first 3-4 whorls appear normal and the turreted condition develops following an apparent disruption of growth during the fourth revolution.

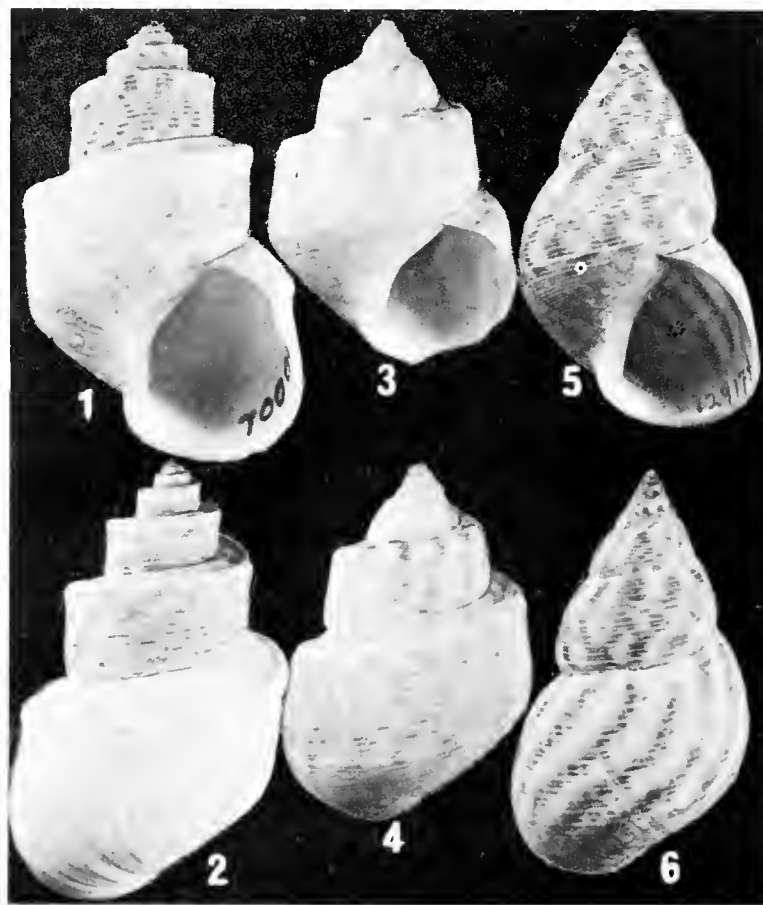

Figs. 1-6. Turreted and Normal *Littorina scabra angulifera* (Lamarck, 1822).

Figs. 1, 2. Squirrel Key, Monroe Co., Florida (USNM 700046; 34.6 x 20.4 mm.).

Figs. 3, 4. "Florida" (USNM 594251; 17.4 x 11.7 mm.).

Figs. 5, 6. Normal specimen from mouth of Shark River, Ponce de Leon Bay, southwest Florida (USNM 129174; 36.9 x 20.1 mm.).

## LITERATURE CITED

- Bequaert, J. C. 1943. The Genus *Littorina* in the Western Atlantic Ocean. *Johnsonia* 1(7): 1-27, 7 pls.
- Dautzenberg, Ph. and H. Fischer. 1914. Étude sur le *Littorina obtusata* et ses variations. *Journal de Conchyliologie* 62: 87-128, 3 pls.
- Jeffreys, J. G. 1865. *British Conchology* 3: 1-393; 1869. *Ibid.* 5, pl. 65.
- Pelseneer, Paul. 1920. Les variations et l'hérédité chez les Mollusques. Brussels, pp. 1-826.
- Reeve, L. A. 1857-1858. *Conchologia Iconica* 16 *Littorina*, pls. 1-18.
- Rosewater, J. 1970. The Family Littorinidae in the Indo-Pacific, Part I. The subfamily Littorininae. *Indo-Pacific Mollusca*, 2(11): 417-509, pls. 325-386.
- Wood, Searles V. 1848. A Monograph of the Crag Mollusca, Part I, Univalves, pp. xii + 1-208, 21 pls.

## BOOK REVIEW

THE GEOLOGY AND PALEONTOLOGY OF THE MARINE PLIOCENE OF SAN DIEGO, CALIFORNIA (PALEONTOLOGY: PELECYPODA). By Leo George Hertlein and U. S. Grant, IV. *San Diego Society of Natural History Memoir 2 (Part 2B)*, pp. 135-411, text figs. 7-13, pls. 27-57, paperback. July 21, 1972. \$15.00 postpaid. Available by mail from the San Diego Society of Natural History, P. O. Box 1390, Balboa Park, San Diego, California 92112.

This quarto volume is literally a mine of information on many families of marine pelecypods. The taxonomic discussion includes 4 subclasses, 8 orders, 22 superfamilies, 39 families, 82 genera, and 144 species and subspecies. Ten species are not positively identified but are compared to known species, and two additional ones are cited only to genus. Eleven species, not seen by Hertlein and Grant but reported by other authors, are included. The species with small-sized shells are not neglected. One genus, one subgenus, nine species, and four subspecies are described as new. The new genus is *Irusella* (Veneridae), and the new subgenus is *Axinola* (Glycymerididae). The new species and subspecies are: *Nucula* (*Ennucula*) *balboana*, *Mytilus* (*Crenomytilus*) *coalingensis sternbergi*, *Chlamys* (*Chlamys*) *hastata ellisi*, *Chlamys* (*Argopecten*) *abietis abbotti*, *Lima* (*Limaria*) *orcutti*, *Aligena diegoana*, *Bornia frankiana*, *Dosinia ponderosa diegoana*, *Chione allisoni*, *Chione kanakoffi*, *Psephidia stephensae*, *Semele ashleyi*, *Thracia kanakoffi*.

The authors have made many taxonomic keys to genera, subgenera, species, and subspecies. Four of the seven text figures are drawings of pectinid genera that show the exterior ornamentation of the valves. Most of the photographs of the species are of good quality, and there are 348 of them.

Most of the categories above the genus are like those found in the *Treatise on Invertebrate Paleontology*, and Hertlein and Grant cite the references and refer to the first usages and spellings of these higher categories. The type species of each genus and subgenus is given with mode of designation. There is additional information given on the genera and subgenera, such as geologic range, a brief description, and sometimes geographic range and other species that have been allocated to the genus besides the ones found in the San Diego Formation. The descriptions of the species are detailed and include the synonymy, repository of type specimens, type locality, geologic range, the original description, morphologic variability, and a discussion of related species. The taxonomic descriptions comprise 200 pages.

References and supplementary data, which are numbered consecutively within the text in parentheses, are listed after the descriptive taxonomic part of the monograph. This portion of the volume comprises 37 pages, and there are 1,384 entries. It is in this section that one finds information on the names of the categories above the genus, and the type species of many genera and subgenera that are related to those described in the taxonomic discussion. Some additional information is given on ecology, geologic ranges, and biology and geographic distribution of genera, subgenera, and species.

Four pages are devoted to a list of collecting localities. The 23-page index is quite complete.

The most impressive thing about this monograph is the incredible amount of scientific literature that Hertlein and Grant examined and cited. This work will be useful to anyone doing research on marine Pelecypoda, and it contains much good raw data for the paleoecologist to analyze.

David Nicol  
Box 14376, University Station  
Gainesville, Florida 32601

TYPE LOCALITY OF *UNIO PUMILUS* LEA, 1838 (UNIONIDAE)

Samuel L. H. Fuller

Department of Limnology

Academy of Natural Sciences of Philadelphia

Philadelphia, Pa. 19103

## ABSTRACT

*A method for verifying the synonymies of Fusconaia masoni (Conrad 1834) and Lexingtonia subplana (Conrad 1837) is discussed. The type locality of Unio pumilus Lea 1838 is corrected from the Neuse River system to the Cape Fear River system (both in North Carolina). U. pumilus is a synonym of F. masoni, newly recorded from the Cape Fear River.*

The occurrence of a member of the primitive unionid genus *Fusconaia* Simpson 1900 in the Savannah River system was recorded by Fuller (1971), who identified the species as *masoni* Conrad 1834, originally described as a *Unio* from the same river system. Insofar as *U. masoni* appears to be the earliest available name for this species, there is no problem in accepting the combination *F. masoni* (Conrad, 1834). This species should not be confused

with the conchologically very similar *U. subplanus* Conrad 1837, the type species of the genus *Lexingtonia* Ortmann 1914. The distinctiveness of *subplana* has been verified on anatomical ground. Furthermore, it is apparently limited to the upper James River (Ortmann, 1914).

It will be impossible to construct the correct synonymies of *Fusconaia masoni* and *Lexingtonia subplana* until their ranges are fully understood: the

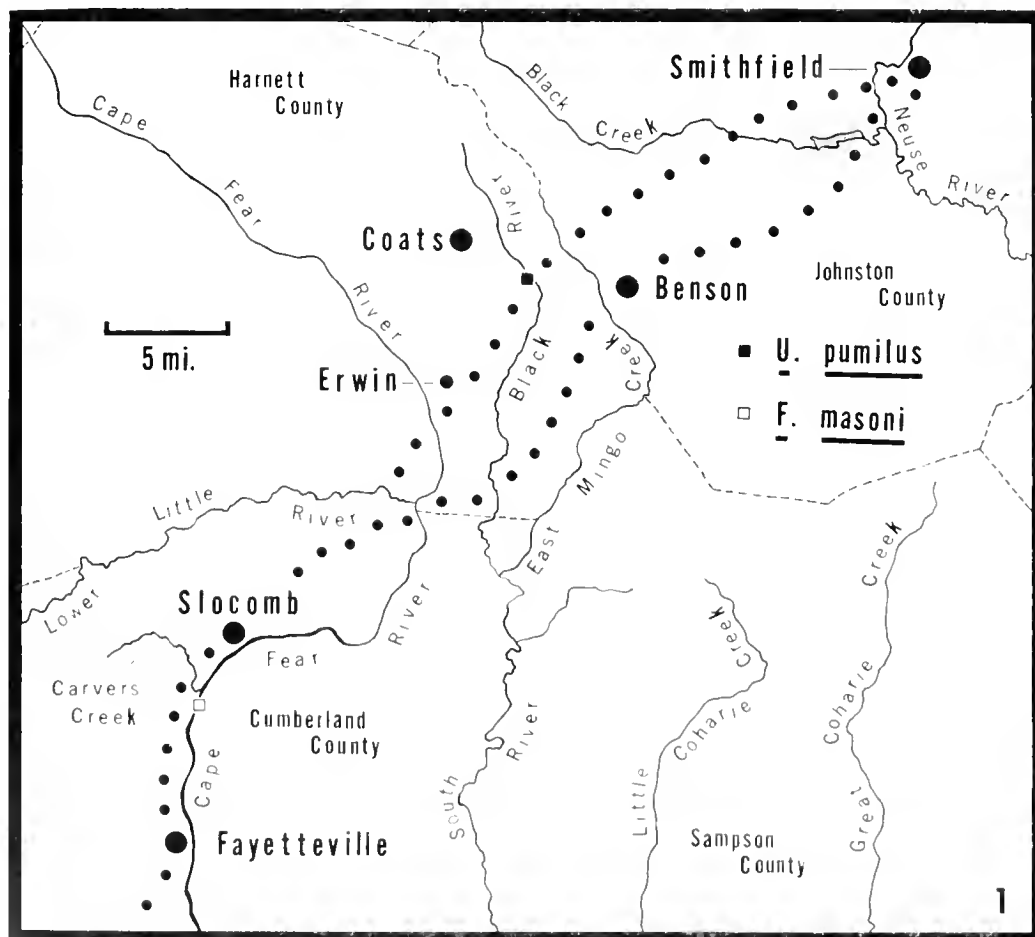

Fig. 1. Known distribution of *Fusconaia masoni* (Conrad 1834) in the Cape Fear River system of North Carolina, with the type locality of *Unio pumilus* Lea 1838. Dotted lines represent routes between Smithfield and Fayetteville available to Isaac Lea in 1827.

type specimens of the several relevant taxa are devoid of beak sculpture and soft parts, which are the only discriminants between these two genera (Ortmann, 1914). Those taxa which were described from areas where only one of these species proves to occur can justifiably be assigned to synonymy; some of those from areas where the two species prove sympatric may have to be considered *nomina dubia*. In order to apply such criteria, one must know the type localities in question.

One of these taxa is *Unio pumilus* Lea, 1838, whose type locality was cited by Johnson (1970: 301) as in the Neuse River system of North Carolina, whereas the adjacent Cape Fear River system is correct. The point is of some importance because I have *Fusconaia masoni* from the Cape Fear River: thus *Unio pumilus* falls within that species' range.

In describing *Unio pumilus*, Isaac Lea (1838: 23) wrote: "A single individual of this species was found by me in 1827, in crossing the Black River, on the road to Fayetteville from Smithfield." Contemporary maps of North Carolina show that in 1808 there was a single road connecting these towns and that a second had been constructed by 1833 (Cumming, 1966: pls. 9-10). The earlier road crossed the Black River at a point in the modern Harnett County about five miles northeast of Erwin and about four miles east-southeast of Coats (Fig. 1). The crossing of the later route was about three miles southeast of Erwin, some 10 river miles downstream of the original crossing.

These points cannot be fixed with precision because modern roads do not necessarily follow their original courses and because of the difficulty in reconciling early and modern cartography. Nonetheless, the type locality of *Unio pumilus* definitely is somewhere between these two points as approximately defined. It is doubtless at or near the upstream point because the later, more circuitous route (Fig. 1) was less likely to be used in public transportation; because Cumming's (1966) post-1833 maps do not show this road (which suggests its relative unimportance), and because Lea mentioned only "the" road from Smithfield to Fayetteville.

On both early and modern maps is shown a Black Creek in the Neuse River system, which flows subparallel to Black River immediately to the southwest of Smithfield. Lea had to cross both streams on his 1827 journey (Fig. 1). Their nominal similarity misled Johnson (1970: 301), who thus amended the type

locality of *Unio pumilus*: "Black River [Cape Fear River system: South River drainage] on the road to Fayetteville from Smithfield [=about 10 mi. W of Benson, Johnson Co.], North Carolina." The type locality is (about five miles) west of Benson, but this point is now in Harnett County, and Black River is in the Cape Fear River system.

This somewhat confusing situation is complicated by the existence in this general area of another Black River, also a tributary of the Cape Fear. This stream is created by the confluence of Six Run and Great Coharie Creeks, whose headwaters rise a few miles south of Smithfield, but can be traversed on only the most devious route to Fayetteville (Fig. 1). Moreover, even Cumming's (1966) earlier maps clearly distinguish between this Black River and the streams "Six Runs" and "Great Cohera" or "Big Cohary." Thus no stream in this drainage could have been nominally or geographically confused by Lea with the Black River he crossed in 1827.

In view of all these considerations, it seems best to restrict the type locality of *Unio pumilus* to: Black River [Cape Fear River system: South River drainage], on the road to Fayetteville from Smithfield [=about 5 mi. NE Erwin and about 4 mi. ESE Coats, Harnett Co.], North Carolina.

Thanks are due J. B. Post (Free Library, Philadelphia) and W. F. Caddell, Jr. (North Carolina State Highway Commission) for aid in locating early and modern maps of portions of North Carolina and to R. T. Abbott for a critical reading of the manuscript.

#### LITERATURE CITED

- Cumming, W. P. 1966. North Carolina in Maps. State Department of Archives and History, Raleigh. Pp. viii + 1-36, pls. 1-15.
- Fuller, S. L. H. 1971. A Brief Field Guide to the Fresh-Water Mussels (Mollusca: Bivalvia: Unionacea) of the Savannah River System. ASB Bulletin 18(4): 137-146, text figs. 1-14, 1 pl.
- Johnson, R. I. 1970. The Systematics and Zoogeography of the Unionidae (Mollusca: Bivalvia) of the Southern Atlantic Slope Region. Bulletin of the Museum of Comparative Zoology 140(6): 263-450, tables 1-4, text figs. 1-5, pls. 1-22.
- Lea, I. 1838. Descriptions of New Freshwater and Land Shells. Transactions of the American Philosophical Society (N. S.), 6(1): 1-154, pls. 1-24.
- Ortmann, A. E. 1914. Studies in Naiades [Part 3.]. The Nautilus 28 (3): 28-34.

*UNIO CAROLINIANA* BOSCH, 1801 (UNIONIDAE)

Samuel L. H. Fuller

Department of Limnology

Academy of Natural Sciences of Philadelphia

Philadelphia, Pennsylvania 19103

## ABSTRACT

*The date of authority for Unio caroliniana Bosc is established as 1801. Conflicting interpretations of this taxon's identity are reviewed. U. caroliniana should be considered a nomen dubium.*

Bosc (1801: 142, pl. 23, fig. 2) described and figured *Unio caroliniana* in Volume 3 of the first edition of his *Histoire Naturelle des Coquilles*. This volume is dated "An X," an abbreviation for the tenth year of the French revolutionary (or republican) calendar - i.e., the period from 23 September 1801 to 23 September 1802. The unsatisfactory designation "1801/02" would have to be used as the date of authority for *Unio caroliniana* had Dodge (1952: 33) not shown that Volume 3 of the "*Histoire*" appeared no later than 23 October 1801.

Bosc (*ibid.*) compared his description and figure of *Unio caroliniana* to figure 5 on plate 239 in the so-called *Encyclopédie Méthodique* of Lamarck and collaborators. The figures in question resemble the shell of a North American fresh-water mussel, *Unio-merus tetralasmus* (Say 1831) (concept of Johnson, 1970: 339). Noticing the unclearness of Bosc's figure (whose posterior hinge is particularly obscure), Lea (1852: 44) felt that it might as easily have been intended to represent the holarctic *Margaritifera margaritifera* (Linnaeus 1758) (Margaritiferidae). This is certainly possible because the nature of the lateral teeth in this figure might be considered to represent those which may occur in younger *M. margaritifera* from Europe (Woodward, 1854) and North America (Ortmann, 1919).

On the other hand, the type locality of *Unio caroliniana* is "les eaux dormantes [stagnant] en Caroline" (Bosc, *ibid.*), whereas the range of *Margaritifera margaritifera* in the Atlantic drainage of the United States extends no farther south than the upper Little Schuylkill River drainage in northeastern Pennsyl-

vania (Ortmann, 1919: 3-5), and this species' dependence upon pristine and flowing waters is well-known. Moreover, the figures of Bosc and in the *Encyclopédie Méthodique* might be thought to demonstrate the rough periostracum, conspicuous growth rests, postdorsal angulation, and somewhat arcuate ventral margin of *Unio-merus* from larger Carolinian rivers. Finally, Bosc (*ibid.*) redescribed *M. margaritifera* (as *Unio margaritifera*) on the same page where *Unio caroliniana* was described; one assumes that he distinguished clearly between them.

For these reasons, one is tempted to grant *Unio caroliniana* Bosc 1801 priority over *Unio tetralasmus* Say 1831. Thus a perplexed Simpson (1900: 741, 1914: 711) did with a query include *Unio caroliniana* in his synonymy of *Unio (Unio-merus) obesus* Lea 1831. However, the figure of *Unio caroliniana* might also illustrate *Elliptio complanata* (Lightfoot 1786), a widespread species in the Atlantic drainage (see Johnson, 1970: 321), whose ready confusion with *Unio-merus* is notorious.

Unfortunately, there seems to be no extant voucher material which might help settle the matter. For instance, E. Fischer (in correspondence) stated that a type specimen of *Unio caroliniana* has not been located in the National Museum of Natural History at Paris, where the specimens figured by Bosc or in the *Encyclopédie Méthodique* are as likely to have been deposited as at another institution, if any.

An ambiguous figure, an inadequate description ("Ovale, alongee; les sommets ronges."), and the probable loss of the figured type - these factors combine to disguise the correct identity of *Unio carolin-*



*iana*, which had best be considered a *nomen dubium*. In recent discussions of *Uniomereus* from the Atlantic and Gulf drainages of the United States, Clench and Turner (1956: 177-179) and Johnson (1970: 339-343) understandably ignored the name.

Confusion over the status of *Unio caroliniana* is reflected in the curious evolution of its spelling and citation in the literature:

*Unio caroliniana* [error for *carolinianus*]. Bosc, 1801: 142, pl. 23, fig. 2; 1824: 139, pl. 23, fig. 2; 1830: 139, pl. 34, fig. 2.

*Margaron (Margaritana) Carolinianus* Bosc [1801], Lea, 1852: 44.

*Unio carolinensis* Bosc 1824, Simpson, 1900: 741; 1914: 711.

Fortunately, no one appears to have confused this taxon with *Unio caroliensis* Pacôme 1889, a synonym of the European *Unio crassus batavus* Maton and Rackett 1807 (Haas, 1969: 51)

Thanks are due R. T. Abbott for criticism of the manuscript and for guidance among unfamiliar elements of the late 18th and early 19th century molluscan literature.

#### LITERATURE CITED

Bosc, L. A. G. 1801. Histoire Naturelle des Coquilles [First Edition], Volume 3: 1-292, plates. Deterville (Paris).

Bosc, L. A. G. 1824. Histoire Naturelle des Coquilles [Second Edition], Volume 3: 1-287, plates. Verdière (Paris).

Bosc, L. A. G. 1830. Histoire Naturelle des Coquilles

[Third Edition], Volume 3: 1-287, plates. Raynal (Paris).

Clench, W. J., and R. D. Turner. 1956. Freshwater Mollusks of Alabama, Georgia, and Florida from the Escambia to the Suwanee River. Bulletin of the Florida State Museum 1(3): 97-239, pls. 1-9.

Dodge, H. 1952. A Historical Review of the Mollusks of Linnaeus. Part 1. The Classes Loricata and Pelecypoda. Bulletin of the American Museum of Natural History 100(1): 1-264.

Haas, F. 1969. Superfamilia Unionacea. Das Tierreich, Lief. 88: x + 1-663.

Johnson, R. I. 1970. The Systematics and Zoogeography of the Unionidae (Mollusca: Bivalvia) of the Southern Atlantic Slope Region. Bulletin of the Museum of Comparative Zoology 140(6): 263-450, tables 1-4, text figs. 105, pls. 1-22.

Lea, I. 1852. A Synopsis of the Family of Naiades [Third Edition]. Blanchard and Lea (Philadelphia). Pp. xx + 17-88.

Ortmann, A. E. 1919. A Monograph of the Naiades of Pennsylvania. Part 3. Systematic Account of the Genera and Species. Memoirs of the Carnegie Museum 8(1): 1-384, text figs. 1-34, pls. 1-21.

Simpson, C. T. 1900. Synopsis of the Naiades, or Pearly Fresh-Water Mussels. Proceedings of the United States National Museum 22(1205): viii + 501-1044, pl. 18.

Simpson, C. T. 1914. A Descriptive Catalogue of the Naiades, or Pearly Fresh-Water Mussels. Bryant Walker (Detroit). Pp. xii + 1-1540.

Woodward, S. P. 1854. A Manual of the Mollusca, Part 2: 159-330, text figs. 90-223, pls. 14-24. John Weale (London).

## GREATER ADAPTABILITY OF FRESHWATER MUSSELS TO NATURAL RATHER THAN TO ARTIFICIAL DISPLACEMENT

Marc J. Imlay

Office of Endangered Species  
Bureau of Sport Fisheries and Wildlife  
Fish and Wildlife Service  
Washington, D. C. 20240

### ABSTRACT

*Artificial displacement of freshwater mussels in the stream bottom (substrate smothering, commercial harvesting, or removal and replacement) was detrimental to mussels more often than was natural displacement (natural sand formation, storm disturbance, etc.). A biological explanation is presented that contributes to understanding why water projects (dredging, channelization, impoundments, quarry washing) are so devastating to freshwater mussels.*

Freshwater mussels are artificially displaced in their natural stream bottom environment in many ways, including simple removal from the substrate, being smothered by a substrate, and being disturbed in their substrate during harvesting of a mussel bed. The mussel may have the physical capacity to recover from these events by digging back in or out, as the case may be, re-orienting to the direction of current flow, and regaining a desirable water depth and type of substrate by migratory movement. But there is some evidence that the mussel is more prone to accomplish these feats when the displacement is of natural, rather than artificial, origin. Animal behaviorists are learning that organisms utilize their abilities to surmount difficulties when certain response-triggering mechanisms, much more probably associated with naturally occurring problems, are present. To cite one example (Cloudsley-Thompson, 1961: 118), in resetting daily activity patterns to a changing photo-period, the animal responds in accordance with its own daily rhythm of resetting sensitivity. Even bright light or total darkness has no effect at other times of the day.

### SMOTHERING

Freshwater mussels presumably can extricate themselves from a thin covering of sand or silt by employing the foot and valves (Barnes, 1955, 1962). It is conceivable, however, that an unnatural covering occurring at an atypical season would not trigger a natural response mechanism for digging out, even though the mussel has the physical means to do so.

The results of the following laboratory experiment on mussel response to smothering as a form of artificial displacement indicate that the latter possibility occurs more often in practice. Mussels were placed on their sides in large battery jars, covered with sand, silt, or other substrates and provided with about one foot of continuously aerated Lake Superior water at 16 C.

*Detritus.* - On July 6, 1967, nine *Anodonta grandis* collected from a very slow-moving creek in one foot of water were covered with three inches of detritus consisting of leaf, twig, and other loose material from the creek. A few mussels emerged each day until by July 11 all the mussels had completely emerged.

However, sixteen *Fusconaia flava* were covered on July 18 and in seven days two *Fusconaia flava* were almost emerged, one half way up, but thirteen were on the bottom (ten dead).

On July 14, eight *Ligumia recta* were covered with the loose detritus and in four days three were at least partly emerged but at least three were on the bottom.

*Sand.* - On July 14, seventeen *Fusconaia flava* were covered with 7.5 inches of sand from the St. Croix River. On July 18, nine *Anodonta grandis* were also covered with the river sand. None of the *Fusconaia flava* had emerged in four days. By seven days all the *Anodonta grandis* were still at the bottom with six dead.

However, muddy sand was collected from Upper St. Croix Lake and the leaves and twigs sieved out. This lake sand was much muckier than the river sand. On July 14, nine *Anodonta grandis* were covered with

the sand. By four days, eight *Anodonta grandis* were emerged. On July 18, nine *Ligumia recta* were covered by the lake sand. By seven days one was emerged, three were two-thirds the way up (two dead), and five were on the bottom (four dead).

Very fine, mucky sand, mixed with thick clay, was obtained from St. Louis Bay in Duluth and 4.5 inches of it placed July 19 on top of ten *Lasmigona costata* and ten *Lampsilis siliquoidea*. By six days one *Lampsilis* emerged in normal feeding position. With four others the siphons broke surface and were active. Another *Lampsilis* was almost emerged. One *Lampsilis* was on the bottom but alive. Two others were dead. Of the *Lasmigona*, nine were on the bottom, seven alive and two dead. On July 25, ten *Lampsilis siliquoidea* from Grand Lake, Minnesota and eight *Anodonta grandis* were covered, along with five *Lasmigona costata* and four *Lampsilis* of river origin. By six days two *Anodonta grandis* and two lake *Lampsilis siliquoidea* were emerged, along with two river *Lampsilis*, but five *Anodonta grandis* were on the bottom alive and eight lake *Lampsilis siliquoidea* were on the bottom (seven dead). The remaining two river *Lampsilis* were both dead on the bottom along with the five *Lasmigona costata* (one dead).

*Silt.* - On August 3, sand was obtained 50-100 feet from the dam at Fish Lake outlet, Minnesota, and silt 300-400 feet from the dam. On August 5, under 7 inches of the silt, were placed twelve *Anodonta grandis* and twelve under a duplicate silt test, fourteen under 7 inches of the sand and thirteen under a duplicate sand test. On August 14, in sand, one was emerged and another was dead one inch down. On August 24, no more had emerged in all four tests. But in one sand test all eleven clams were dead on the bottom and in the other sand test fourteen were on the bottom dead. In one silt test, all twelve were on the bottom dead and in the other silt test ten were found on the bottom dead.

*Grit.* - Grit (material too coarse to be considered sand) was obtained from the Split Rock area of Lake Superior and, on July 19, placed on top of thirteen *Fusconaia flava*, four *Amblema costata* and twenty-one *Lampsilis siliquoidea*.

On July 25, one *Fusconaia flava* and *Lampsilis siliquoidea* were fully emerged, two *Fusconaia flava* and one *Lampsilis siliquoidea* half emerged, four *Lampsilis* with siphons emerged, one *Amblema costata* with siphons emerged. Two *Lampsilis* and one *Fusconaia flava* had climbed four-fifths up the grit.

But, on the bottom there were nine *Fusconaia flava*, three *Amblema costata* and ten *Lampsilis siliquoidea* of which three were dead.

On July 25, sixteen *Fusconaia flava* and ten *Lampsilis siliquoidea* from Grand Lake, Minnesota, were covered with grit. By August 7, four *Fusconaia flava* had emerged. By August 24, no more clams had emerged, but about one inch from the bottom were two dead Grand Lake *Lampsilis*. Two *Fusconaia flava* were alive, but on the bottom. The other ten *Fusconaia flava* and eight Grand Lake *Lampsilis* were dead on the bottom.

*Application.* - The demonstrated failure of mussels more often than not to climb out of smothering conditions explains in part the devastating effect of dredging (Van der Schalie, 1941: 308), channelization, silt behind dams, and quarry washing (Stansbery, 1970), or for that matter, of dust storms and surface run-off (Ellis, 1936).

Even *Anodonta grandis* was not immune to smothering, yet Dennis (1971) notes "As the common name 'floaters' implies, this species is light weight with a thin shell, enabling it to survive in loose sand, mud, and silt."

As an example of the difference to mussels between artificial and natural sand formation, Grier (1922) may be quoted: "An old bed of 'niggerheads' existing at Wild's Landing was found to be absolutely covered with sand deflected by the dams . . . the best collecting in this area was from the sand bars." Scuggs (1960: 28) observed in impounded areas of the Tennessee River recently plagued by 0.5-1.25 inches of silt cover that "a relatively large number of dead shells, of different species and sizes, were found under layers of silt one inch or deeper at several stations. These shells were embedded in a normal position with the valves closed; the shells showed little sign of erosion indicating that mortality had occurred within recent months."

#### METHODS OF HARVEST

Grier (1926) considered the practice of harvesting mussels with the shoulder rake a principal reason for the decline of the clamming industry. Van der Schalie (1941) has commented that there has been "an excessive amount of mussel-shell gathering with the use of apparatus injurious to the mussel beds." He urges (1948) enforcement against the illegal practices of commercial hand-picking and forking because only the acceptable method (with the crow-foot bar skim-

ming above the surface and removing just the larger, higher mussels) does not remove the young ones so necessary in turn for replacement of the older stock. Furthermore, "some of the larger specimens" important for reproduction are "down at least five or six inches." ". . . completely beneath the surface of the river bottom. It is seriously doubted if the crow-foot dredges used in commercial operations would bring up specimens from such depth in the mud and gravel" (Van Cleave, 1940).

Dennis (1971) explains the damage to mussel beds by hand-picking or raking as a matter of removing too many shells for restoring to be possible. I suggest that an additional explanation may be that brailing either removes a mussel entirely from the water or does not disturb it at all, leaving the substrate below relatively undisturbed. Forking and hand-picking, on the other hand, with the kicking of the substrate, overturning of rocks, raking the substrate, and throwing back mussels too young for harvest may amount to artificial displacement of the mussels not collected.

#### REMOVAL FROM SUBSTRATE

Isely (1914) examined 164 "Quadrulae" in Oklahoma for migration a year after artificial displacement into Shoofly Creek from the Chikaskia River. He recovered 84.8 percent of the original tagged mussels and showed little, if any, migration. Yet these very test mussels had been actively moving naturally before collection as shown by track marks. Similarly, 46 percent of *Anodonta grandis* were found in their original location. Isely did not report on whether the mussels had burrowed in or not, let alone their orientation relative to the direction of stream flow. Isely placed some Quadrulae in one foot of water and they migrated to deeper water.

On May 27, 1971 I placed twenty large male *Lampsilis ventricosa* on their sides at one location in three feet of water near the bank in the Eau Claire River, Wisconsin. On July 11, nineteen of these mussels were found in the same four by four foot placement area (thus no migration). All were burrowed in except one mussel almost on its side. All were oriented posteriorly upstream and fourteen essentially parallel to the current flow.

However, earlier, in the late autumn, I left about fifty mussels (including *Lampsilis ventricosa*) on their sides in a four by four foot sandy area near the bank of the Eau Claire River and three months later the mussels were still on their sides except for two or

three which had burrowed in. There was no migration from the placement area. Thus, artificial displacement at an atypical season was too extreme for the animals to adapt to it.

Stansbery (personal communication) also observed that mussels collected in summer and left on their sides in a pile for many weeks remained that way.

It may be speculated that certain species of mussels establish a partial domicile by growing into a shape which conforms to the particular microhabitat pressures and requirements at the location of the particular mussel. This follows the familiar experience of finding arcuate and even odd-shaped specimens in areas with boulders, stones, and small patches of suitable sandy substrate. Such an older mussel would be less adaptable to displacement than a younger mussel. It would appear that regulations for commercial clambers to toss back undersized mussels or mussels that are protected as endangered species may accomplish little because the mussels in question have been artificially displaced and are not expected to necessarily regain a viable posture in the substrate. Bates (1971: 32) reported that hand-picked specimens fared better in regards to simple mortality after three weeks of replacement in the streams, then did brail-collected specimens but even they had eleven percent mortality (450 specimens in test) in just three weeks.

An experiment showing exceptions to the rule may also be described. On August 21, ten *Lampsilis siliquoidea* from Grand Lake, Minnesota, were placed on top of a substrate in a bucket in the laboratory. This was their natural substrate collected from where the clams were collected, just inside the perimeter of the emergent vegetation zone in the lake. Running water (at about 16 C) was made to flow in copious quantity past the animals and by the next day eight of the clams were in a normal feeding position. The substrate felt hard, yet the clams had pushed their way in.

Similarly, Trueman (1968) placed *Margaritifera margaritifera* in an aquarium containing sand from the river they were collected from. The mussels generally burrowed in normal position after a day or so of migrating around the aquarium.

On the other hand, Roscoe and Redelings (1964) transplanted twenty-five specimens of *Margaritifera margaritifera* and some lay almost parallel to the bottom, covered to much extent by stones. "Most of the clams in the bed had the siphons directed upstream, but among the transplants the clams assumed every

angle from siphons directed toward the current to siphons directed away from the current." Yet, in the same river, these investigators observed whole beds had been washed downstream by natural storms into two new areas.

That mussels are displaced naturally and adapt well is attested to by the following field experiences: A fruitful collection over a one-hundred yard stretch on the Eau Claire River, Wisconsin, yielded several species in large numbers but these species had been collected out from that location two years earlier. It is not known whether the repopulation came from downstream or upstream, but it evidently represents a natural displacement from somewhere else in the stream. These displaced mussels were not laying on their sides or misoriented to the current, but appeared to be in normal position in the substrate. Furthermore, a similar experience (collecting out, repopulation, adaption to displacement) was encountered at another location on the Eau Claire River.

The type of distinction shown here between artificial and natural imposition on the mussels may be involved in the unhappy circumstance that artificial river-lakes such as the large impoundments on the Tennessee River and elsewhere are so inimical to mussels but natural river-lakes such as Lake Pepin, Minnesota, or Mussel Shoals, Alabama, supported even more species and numbers of mussels than have large rivers.

#### LITERATURE CITED

- Barnes, G. E. 1955. The behavior of *Anodonta cygnea* L. and its neurophysiological basis. Jour. Exp. Biol. **32**:158-174.
- Barnes, G. E. 1962. The behavior of unrestrained *Anodonta*. Animal Behavior **10**:174-176.
- Bates, J. M. 1971. Ohio Mussel Fisheries Investigation, Final Report, Part 1, Center for Aquatic Biology, Department of Biology, Eastern Michigan University, Ypsilanti, Michigan 48197.
- Cloudsley-Thompson, J. L. 1961. Rhythmic activity in animal physiology and behaviour. Academic Press, New York. 236 p.
- Dennis, S. D. 1971. Pennsylvania Mussel Studies. Final Report, Center for Aquatic Biology, Eastern Michigan University, Department of Biology, Ypsilanti, Michigan 48197. 138 p.
- Ellis, M. M. 1936. Erosion silt as a factor in aquatic environments. Ecology **17**:29-42.
- Grier, N. M. 1922. Final report on the study and appraisal of mussel resources in selected areas of the Upper Mississippi River. Amer. Midland Naturalist **8**:1-33.
- Grier, N. M. 1926. Report on the study and appraisal of mussel resources in selected areas of the Upper Mississippi River, 1920-25. Amer. Midland Naturalist **10**:89-110.
- Isely, F. B. 1914. Experimental study of the growth and migration of freshwater mussels. Bureau of Fisheries, Document **792**. 27 p.
- Roscoe, E. J., and S. Redelings. 1964. The ecology of the freshwater pearl mussel *Margaritifera margaritifera* (L.). Sterkiana **16**:19-32.
- Scruggs, G. D. 1960. Status of freshwater mussel stocks in the Tennessee River special scientific report - Fisheries No. **370**. U. S. Fish and Wildlife Service, Washington, D.C. 41 p.
- Stansbery, D. H. 1970. Rare and endangered freshwater mollusks of the Mississippi and St. Lawrence River systems of North America. Malacologia **10**:9-22.
- Stansbery, D. H. 1971. Personal communication. Museum of Zoology, Ohio State University, Columbus, Ohio.
- Trueman, E. R. 1968. The locomotion of the freshwater clam *Margaritifera margaritifera* (Unionacea: margaritanidae). Malacologia **6**:401-410.
- Van Cleave, H. J. 1940. Ten years of observation on a freshwater mussel population. Ecology **21**:363-370.
- Van der Schalie, H. 1941. Zoogeography of naiades in the Grand and Muskegon Rivers of Michigan as related to glacial history. Papers of the Michigan Academy of Science, Arts & Letters **26**:297-310.
- Van der Schalie, H. 1948. The commercially valuable mussels of the Grand River in Michigan. Misc. publ. 4 of Institute for Fisheries Research. Michigan Department of Conservation. 42 p.

## A NEW SPECIES OF *PERSICULA* FROM THE ARABIAN SEA (MARGINELLIDAE)

Barry Roth

1217 Waller Street, San Francisco, California 94117

and Richard E. Petit

P. O. Box 133, N. Myrtle Beach, South Carolina 29582

### *Persicula masirana* Roth and Petit, new species

*Description of holotype:* Shell of medium size for the genus, solid, ovate, narrower anteriorly; surface polished, unsculptured except for faint growth lines. Color mottled yellowish tan with a broad, reddish brown peripheral band and eleven narrow, spiral rows of alternating white and brown spots. The first row of spots placed immediately below the suture, the rows on either margin of the peripheral band larger than the rest, and the four rows on the band itself being very small and fine. A narrow spiral row of white spots occurs just anterior to the brown band, and another just posterior to it. Spire not visible, immersed in a pad of brown callus. Outer lip white, arching above spire, terminating posteriorly in a wash of white enamel which partly covers apical callus pad; lip margin rounded, slightly thickened externally, its anterior half having about 12 faint, oblong denticles a short distance inside aperture. Aperture narrow, widening anteriorly, white inside, with a curved sulcus at posterior end and a deep, oblique anterior canal. Parietal wall convex, covered with translucent, white callus which thickens to a node in front of the posterior sulcus. Columella with eight folds, including one at base of columella; the two most anterior folds strong, extending onto body whorl; remaining folds much smaller, confined to aperture, becoming increasingly faint posteriorly. Length 10.0 mm.; greatest diameter 7.2 mm.

Holotype, no. 51327, Delaware Museum of Natural History; type locality: Ras Jidufah (local name: Monument Beach) at northeast tip of Masirah Island (21°N, 59°E), in the Arabian Sea, off the coast of the Sultanate of Muscat and Oman; collected by Sgt. Eric Thompson, Royal Air Force, early February, 1971. The holotype was found in beach drift. Although we have been able to examine only the holotype, notes from the collector indicate that it was not the only specimen collected.

*Discussion:* With its pattern of spiral rows of spots and single peripheral band, *Persicula masirana* differs from all other species of the genus. It is most nearly

like *Persicula catenata* (Montagu, 1803) from Florida and the Caribbean. The latter species averages 6 mm. long; it has a tan shell, spiral rows of white sagittate spots which are margined with brown lines on the side nearest the outer lip, and three brown spiral bands, each crossed by a single row of V-shaped dashes. Less similar are the Caribbean *P. sagittata* (Hinds, 1844) and eastern Pacific *P. phrygia* (Sowerby, 1846), which lack brown banding entirely.

Among Indian Ocean species, *Persicula pulchella* (Kiener, 1834), reported from Australia to the Persian Gulf, has wavy axial brown lines on a white ground.

The genus *Persicula* is an old one, with forms much like some Recent species first appearing in the Eocene. *Persicula masirana* and the similarly-patterned Caribbean species may be isolated survivors of a Tethyan stock which has undergone little modification since the early Tertiary.

### LITERATURE CITED

- Hinds, R. B. 1844. Description of Marginellae collected during the voyage of H.M.S. Sulphur, and from the collection of Mr. Cuming. Proc. Zool. Soc. London **14**: 72-77.
- Kiener, L. C. 1834. Spécies général et iconographie des coquilles vivantes . . . : genre marginelle. Paris (J.-B. Baillière et fils). 30 p.
- Montagu, G. 1803. Testacea Britanica or natural history of British shells, marine, land and fresh-water, including the most minute: systematically arranged and embellished with figures. Romsey (J. S. Hollis). xxxvii + 606 p.
- Sowerby, G. B. 1846. Monograph of the genus *Margarella*. In: Thesaurus conchyliorum, or figures and descriptions of shells. **1**: 373-406.

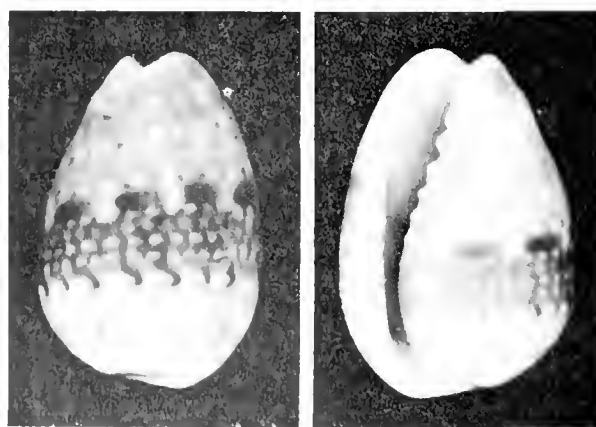

Figs. 1, 2. *Persicula masirana* Roth & Petit, new species. Dorsal and ventral views of holotype, length 10 mm.

QUATERNARY MOLLUSKS FROM FIJI<sup>1</sup>

Horace G. Richards

Academy of Natural Sciences of Philadelphia  
Philadelphia, Pa. 19103

In August, 1969, while visiting Viti Levu in the Fiji Islands, I had the opportunity of making a small collection of fossil mollusks in the Lautoka area. The exact locality is:

Along a road which branches off the Wairambetia Road, which branches off to the SSW from the Natambua Road in northwest Viti Levu. This locality is close to, or identical with, localities C 1133 and RB 32 of the Fiji Geological Survey Department and is about 0.5 mile NW of Pila Trig. The elevation is slightly over 200 feet above sea level.

The mollusks studied include specimens collected by myself and my student-assistant, Richard Nelson in 1969, augmented by material collected by Mr. Nelson in 1970, material supplied by Peter Rodda and other members of the Fiji Geological Survey Department, and specimens borrowed from the British Museum through the kindness of Dr. Patrick Nuttall.

Apparently two geological ages are represented by the material studied. Specimens from slightly higher elevations than the road are apparently Late Tertiary, and are assigned to the Mba Group (Rodda, 1967), following mapping by W. R. Dickinson. These specimens have been transferred to Dr. Harry Ladd, of the U. S. National Museum in Washington, D. C., who is studying the Tertiary mollusks of Fiji. (Most of the specimens loaned by the British Museum are apparently of Tertiary age and will be studied by Dr. Ladd.)

The material obtained from close to the road is apparently of Quaternary age, since all species are known to be living in the Fiji waters today. The fauna is of special interest because it apparently marks the highest elevation for Quaternary fossils on the island. However this is not surprising in view of the tectonic history of the Fiji Islands. Schofield (1971) records high sea levels (Pleistocene ?) on the Lau Islands, up

to elevation 770 feet on Tuvutha, and to 500 and 600 feet on other islands of the group. For data on the geology of Fiji, see Ladd (1934), Bartholomew, (1959), Rodda (1967) and Schofield (1970). The fauna here recorded is apparently considerably older than the material mentioned by Schofield.

In addition to thanking Mr. Rodda, Mr. Nelson and Dr. Nuttall for help in gathering this fauna, I want to express gratitude to Dr. Harry Ladd, of the U. S. National Museum and Dr. R. Tucker Abbott, of the Delaware Natural History Museum, and to another student-assistant, Earl Shapiro, who assisted in the study of the fossils at the Academy. Dr. John Wells, of Cornell University, identified corals listed below.

The following fossils have been identified from the Quaternary portion of the locality:

*Gastropoda*: *Trochus* (*Trochus*) *maculatus* Linné, *Tectus* (*Rochia*) *niloticus* (Linné), *Turbo* sp. (*operculum*), *Nerita* sp., *Rhinoclavis* (*Rhinoclavis*) *aspera* (Linné), *Clypeomorus* sp., *Epitonium* sp., *Cypraea erronea* Gmelin, *Cypraea* sp., *Naticarius marochiensis* (Gmelin), *Polinices mammilla* (Linné), *Mitrella ligula* (Duclos) and *Conus* (*Asprella*) *sulcatus* Hwass.

*Pelecypoda*: *Anadara scapha* (Gmelin), *Lithophaga* sp., *Villorita* sp., *Chama* sp., *Gafarium dispar* (Dillwyn), *Tridacna maxima* (Röding), *Hippopus hippopus* (Linné) and *Spondylus ducalis* Röding.

Corals (identified by Dr. Wells): *Acropora* sp., *Stylophora pisstillata* (Esper), *Platygyra lamellina* (Ehrenberg) forma *rustica* (Dana), and *Acanthocyathus grayi* Milne Edwards and Haime. The first four are reefs corals, while the last mentioned suggests a water depth of at least 50 meters. In this connection, it should be mentioned that H. Dighton Thomas identified the coral *Desmophyllum* cf. *crista-galli* Milne Edwards and Haime from this locality (32) which "would suggest a Pleistocene rather than an earlier age for the deposit yielding it." (Bartholomew, 1959 p. 19).

## LITERATURE CITED

- Bartholomew, R. W. 1959. Geology of the Lautoka Area, North-West Viti Levu. Geological Survey Dept., Suva, Fiji, Bulletin 2, 25 pp.
- Ladd, Harry S. and others. 1934. Geology of Vitilevu, Fiji. Bull. Bishop Museum, Honolulu, no. 119: 1-263.
- Rodda, Peter. 1967. Outline of the Geology of Viti

<sup>1</sup>Part of this study was made possible by a grant from the Penrose Fund of the American Philosophical Society.

Levu. New Zealand Jour. Geology and Geophysics **10**(5): 1259-1273.

Schofield, J. C. 1970. Notes on Late Quaternary Sea Levels, Fiji and Rarotonga. New Zealand Jour. Geology and Geophysics **13**(1): 199-206.

Schofield, J. C. 1971. Note on High Sea-Level Evidence from Lau Islands, South-West Pacific. New Zealand Jour. Geology and Geophysics **14**(1): 240-241.

## ON THE ALLEGED OCCURRENCE OF LAMBIS VIOLACEA AND *CLITHON* *CORONATA* IN INDONESIA

Henk K. Mienis

Dept. Zool., Hebrew Univ., Jerusalem

In his preliminary account of the genus *Lambis* in Indonesia, Butot (1955: 79, pl. 2, fig. 6) mentions *Lambis (Millepes) violacea* (Swainson, 1821) for the first and only time from an Indonesian locality: Ambat, on the east coast of Madura. Quite understandably Abbott (1961: 167) was rather puzzled by this record, as authentic material of this species is only known from the islands in the western part of the Indian Ocean. Yet he mentions Butot's locality in his list of records, but omits it, however, from the map, which shows the distribution of *Lambis violacea* (loc. cit: p. 168 and pl. 130).

The freshwater gastropod *Clithon (Clithon) coronata* Leach, 1815, better known by its junior synonym *Clithon longispina* (Récluz, 1841), is a fairly common species of Mauritius, Réunion, Rodriguez and Madagascar, all islands in the same part of the Indian Ocean. Van Benthem Jutting (1956: 283, fig. 12) mentions, however, *Clithon coronata* in her critical revision of the Javanese freshwater gastropods from a locality in Indonesia: West Java, Muara Tjibuni, Sukabumi. This record is reason for Starmühlner (1969: 56) to consider *C. coronata* an Indomalaysian stray into the freshwater fauna of Madagascar.

During our current revision of the family Neritidae in which we examined more than 120,000 specimens,

of which about a quarter had Indomalaysian localities, we never found a second specimen of *C. coronata* from a locality in Indonesia.

The similarity in both cases is therefore striking. The link between both cases is however still much closer. Butot's record of *Lambis violacea* from Madura and van Benthem Jutting's record of *Clithon coronata* from Java are both based on material in the collection Ouwens, stored in the Zoological Museum of Bogor, Indonesia. According to van Benthem Jutting (1956: 283) it is a well-known fact that the late Major P.A. Ouwens (1850-1922) was somewhat careless as to localities and labels. The possibility that both records are based on wrongly labelled material is thus very great. We propose, therefore, to leave both records out of any further account until they have been confirmed by more recently collected material.

On this basis *Lambis violacea* and *Clithon coronata* have to be considered as species with a rather restricted range in the western part of the Indian Ocean, with the possible center of their distribution being Mauritius and the Cargados Carojos Shoals.

### LITERATURE CITED

- Abbott, R. Tucker, 1961. The genus *Lambis* in the Indo-Pacific. Indo-Pac. Moll., **1**(3): 147-174.
- Benthem Jutting, W.S.S. van, 1956. Systematic studies on the non-marine Mollusca of the Indo-Australian Archipelago, V. Critical revision of the Javanese Freshwater Gastropods. *Treubia* **23**(2): 259-477.
- Butot, L. J. M., 1955. Duivelsklauwen, boksbeugels, schorpioenen of enterhaken. *Penggemar Alam* **35**: 71-84, 3 pls.
- Starmühlner, F., 1969. Die Gastropoden der Madagassischen Binnengewässer. *Malacologia* **8**(1-2): 1-434.



*ANCISTROLEPIS KAWAMURAI* A NEW JAPANESE BUCCINIDAE

Tadashige Habe &amp; Kiyoshi Ito

National Science Museum, Tokyo 160, Japan

We have had a good opportunity to obtain specimens of a new *Ancistrolepis* collected by the whelk fishing boats of Mr. Shosan Mizutani at the Abashiri-Yamatotai, off Abashiri (about 500 meters deep) on the northeast coast of Hokkaido, through the courtesy of Mr. Ryosuke Kawamura, a leading shell collector in Japan.

These specimens closely resemble *A. grammata* (Dall, 1907) and its varietal forms, *A. g. hikitai* Kuroda, 1944, and *A. g. yamazakii* Kuroda, 1944, in general features, but they have elongated shells with rather weak spiral cords, except on the shoulder and the base. Also, *Ancistrolepis (Clinopegma) damon* Dall, which seems to be a subspecies of *Ancistrolepis (Clinopegma) unica* (Pilsbry, 1905), is a related species in having an elongated shell, but has only one prominent shoulder cord down from the suture with an obliquely-placed convex interval between them, instead of the horizontally-placed, flat interval.

Therefore, they are new to science, and we are pleased to name this interesting species in the honor of Mr. Ryosuke Kawamura.

*Ancistrolepis kawamurai* new species

Figs. 1-3

Shell large, elongated and tabulated; rather thick but fragile; 7-whorled white; covered with a dark-brown periostracum, marked with finely, axially lamellose growth lines and sculptured with the spiral cords. Whorl with prominent T-rail-shaped, spiral cords, two at the shoulder and 5 or 6 at the base of the body whorl. Broad peripheral area between the shoulder and the base smooth to spirally sculptured in various degrees of strength. Space between the suture and the shoulder spiral cord is canaliculated horizontally and has a weak spiral cord on its bottom in some specimens. Aperture roundly ovate, white within. Outer margin gently curved but shouldered and crenulated by the endings of spiral cords on the surface. Canal rather wide, sinuated backward. Columellar margin white, weakly curved and twisted at the lower end.

Operculum rather thick, corneous, dark-brown, ovate in shape. Nucleus situated at the narrowed lower end. Radula stenoglossate. Central tooth transversely broad and has three cusps at the hind margin, the middle one smaller than the other two. Marginal tooth also has three cusps, the outer one the largest and the middle one smaller than the inner one.

Height 89.5 mm., Breadth 42.4 mm. (Type specimen preserved in the National Science Museum, NSMT-Mo 41826) (fig. 1); height 87.4 mm., breadth 40.0 mm. (paratype specimen preserved in the National Science Museum, NSMT-Mo 41827) (fig. 2); height 97.5 mm., breadth 48.2 mm. (paratype specimen preserved in the Kawamura's collection); height 77.8 mm., breadth 41.6 mm., (paratype specimen preserved in the Kawamura's collection); height 90.0 mm., breadth 40.0 mm. (the specimen examined for its radula).

*Type locality:* Abashiri-Yamato-Tai (about 500 m. deep), off Abashiri, Hokkaido in the Sea of Okhotsk.

*Distribution:* Besides the type locality, off the east coast of Saghalien (46° 40'N., 143° 58'E, 690 meters deep) Collected by Mr. Kinji Takagawa.

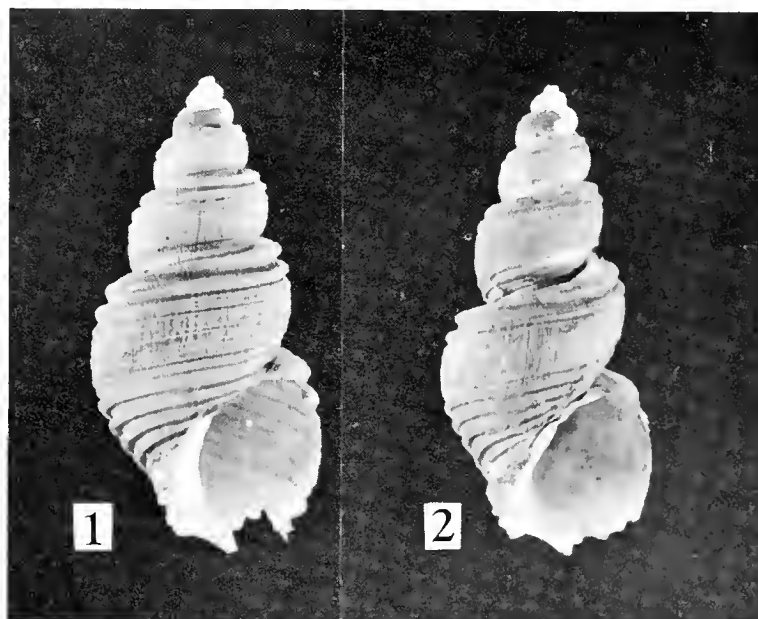

Figs. 1, 2. *Ancistrolepis kawamurai* Habe & Ito, new species. Fig. 1. Holotype, height 89.5 mm.; Fig. 2. Paratype, height 87.4 mm.

## LITERATURE CITED

- Dall, W. H. 1925. Illustrations of unfigured types of shells in the collection of the United States National Museum. Proc. U. S. Natl. Mus. **66**(17): 1-41, pls. 1-36.
- Habe, T. & K. Ito 1965. Shells of the World in color, vol. 1 (The Northern Pacific) 176 pp., 56 pls.
- Habe, T. & K. Ito 1968. Buccinid species from Rausu, Hokkaido. Venus, Jap. Jour. Malac. **27**(1): 1-8, pl. 1.
- Kuroda, T. 1931. On the Japanese species of the chrysodonid whelks, *Ancistrolepis* and *Japelion*, Venus **2**(5): 221-234, text figs. 1-18.
- Kuroda, T. 1944. New Shells from Japan (5), Venus **13**(5-8): 237-239, text figs. 1-2.

Shikama, T. 1957. On some gastropoda from Nemuro Strait, Eastern Hokkaido. Sci. Rep. Yokohama Natl. Univ., (2)**6**: 31-36, pls. 10.

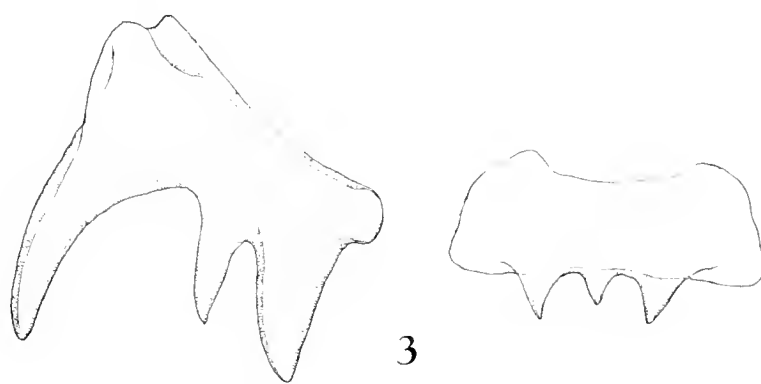

Fig. 3. Half a transverse row of the radula of *Ancistrolepis kawamurai* Habe & Ito, new species.

AN UNDESCRIBED STRUCTURAL FEATURE IN THE MARSUPIUM  
OF *ELLIPTIO LANCEOLATA* (LEA 1828) (UNIONIDAE)

Samuel L. H. Fuller

Department of Limnology  
Academy of Natural Sciences of Philadelphia  
Philadelphia, Pa. 19103

ABSTRACT

*Some populations of Elliptio lanceolata (Lea 1828) from the Atlantic drainage of the United States bear a longitudinal rib on the posterior surface of each of a number of interlamellar septa near the middle of the marsupial (outer female) demibranch. A discussion of the taxonomic implications of this discovery concludes with the rejection of E. arctata (Conrad 1834) as a possible name for such populations. The septal ribs of E. lanceolata are contrasted to the structurally and evolutionarily very different ones found in Unio merus. Possibly the ribs in E. lanceolata developed as a source of additional support for the marsupium.*

Samples of *Elliptio lanceolata* (Lea 1828) from the Cape Fear River, North Carolina, exhibit a curious structural feature of the marsupial water tubes: a more or less conspicuous rib runs medially along the interlamellar septum for most of the height of the (outer) demibranch. Although plainly visible from the anterior side, the rib intrudes into the lumen of the water tube from only the posterior surface of the septum (why the reverse should not be the case is obscure). The rib is more common and strongly developed on septa which lie at or near the longitudinal midpoint of the demibranch - i.e., in the region of its greatest height. The rib interferes with formation of the egg mass, which exhibits a corresponding, more or less straight, shallow groove on its anterior surface.

These *Elliptio* are referable to *Unio perlatus* Lea 1863, whose type locality is "Cape Fear River, Black Rock Landing [=2 mi. S Kings Bluff, Bladen Co.], North Carolina" (Johnson, 1970: 332). Most of my material is from points upstream in Bladen and Cumberland Counties. Johnson (*ibid.*) referred this taxon to *Elliptio arctata* (Conrad 1834), originally described from the Alabama River system in the Gulf drainage and, in the Atlantic drainage, "known only from the several type lots [of its synonyms], and from a rather large unlocalized series from the Cape Fear River, North Carolina." An unusually thin and laterally compressed shell with a somewhat arcuate ventral margin is common to all this material - and does resemble the shell of Gulf drainage *E. arctata* - but these characters frequently occur in *E. lanceolata*,

particularly in the southern one half or so of its range.

That Johnson's (*ibid.*) concept of Atlantic drainage *Elliptio arctata* depends upon scattered specimens without unique conchological characters suggests that there is little to be gained by separating this material from *E. lanceolata*. The septal ribs of Cape Fear River *lanceolata* might be grounds for distinguishing them taxonomically from other *Elliptio* had I not observed (a less developed version of) this phenomenon in conchologically ordinary *lanceolata* from the Patuxent River system on the Western Shore of Maryland near the northern limit of this species' range. (It must be emphasized that this point of view does not preclude the possibility that true *arctata* occurs somewhere in the Atlantic drainage.)

Otherwise than septal ribs, Cape Fear River *Elliptio lanceolata* do not differ anatomically from the descriptive notes of Ortmann (1912), Reardon (1929), or Fuller (1971). Therefore, I am inclined to view these ribs as nothing more than another (and occasional) difference between this species and the more common and widespread *E. complanata* (Lightfoot 1786), from whose ancestors the *lanceolata*-type was probably an offshoot.

The single, longitudinal groove on the anterior surface of the egg mass in some *Elliptio lanceolata* is reminiscent of the numerous, transverse grooves on both surfaces of the egg mass in *Unio merus*. In the latter genus, egg mass sculpture reflects imperfect septal fusion (Fuller, 1971), whereas the septum is a per-

fectly fused, superficially smooth structure in *Elliptio*. The septal ribs of *lanceolata*, then, appear to be an adaptation which has little or nothing to do with the degree of development of the septum. Perhaps their role is to provide the marsupium with additional support against its collapse and the destruction of its contents. Perhaps these ribs developed during a prolonged arid period, when desiccation was a threat to life and reproduction.

Thanks are due G. M. Davis for a critical reading of the manuscript.

#### LITERATURE CITED

- Fuller, S. L. H. 1971. A Brief Field Guide to the Fresh-Water Mussels (Mollusca: Bivalvia: Unionacea) of the Savannah River System. ASB Bulletin 18(4): 137-146, text figures 1-14, 1 plate.
- Johnson, R. I. 1970. The Systematics and Zoogeography of the Unionidae (Mollusca: Bivalvia) of the Southern Atlantic Slope Region. Bulletin of the Museum of Comparative Zoology 140(6): 263-450, tables 1-4, text figures 1-5, plates 1-22.
- Ortmann, A. E. 1912. Notes upon the Families and Genera of the Naiades. Annals of the Carnegie Museum 8(2): 222-365, text figures 1-28, plates 18-20.
- Reardon, L. 1929. A Contribution to Our Knowledge of the Anatomy of the Fresh-Water Mussels of the District of Columbia. Proceedings of the United States National Museum 75 (2782): 1-12, plates 1-5.

AN UNUSUAL FORM OF *LITTORINA LITTOREA* LINNÉ  
FOUND IN NOVA SCOTIA

Derek S. Davis

Nova Scotia Museum

1747 Summer Street

Halifax, Nova Scotia, Canada

During a survey of the intertidal fauna of Petpeswick Inlet, Halifax County, Nova Scotia, samples of *Littorina littorea* (Linné) were taken. On June 28, 1971, a rather unusual form was collected along with normal *L. littorea* in a *Spartina* marsh at Petpeswick Harbour. This specimen and an example of the normal form are shown in Figures 1 and 2. The population density of *L. littorea* in this habitat was 120 per square metre, but only one specimen of the unusual form was found. It has a high spire, deeply incised sutures and six whorls. Its shell length is 16.1 mm, and shell breadth 12.4 mm. The soft parts were identical to those of normal forms. This specimen was a female and did not contain trematode parasites.

The normal form (Fig. 2) was selected at random from the specimens collected. Its shell length is 18.4 mm, and shell breadth 14.2 mm. There are six whorls. This specimen was a male, parasitised by the digenetic trematode, *Cryptocotyle lingua* (Creplin).

Since marked variations in the form of *L. littorea* are rather uncommon, the occurrence of this unusual specimen is of interest. Jeffreys (1865) briefly describes four varieties and some other abnormalities in *L. littorea*. Among these, var. *turrita* is described as "spire turreted, the whorls being divided by a deep and channelled suture". Jeffreys also mentions a monstrosity with the spire much elongated. Without a full description for reference it is difficult to know whether the unusual form from Petpeswick is the named variety or a mutant.

Read (1965 and 1966) has described shell-less specimens of *L. littorea* from Maine, and suggested that these may be mutants or victims of disease. The unusual form from Petpeswick was examined for larval trematode parasites, which sometimes cause shell deformations in prosobranchs (Fretter and Graham, 1962), but none were found.

Bequaert (1943) in his description of *L. littorea* from the western Atlantic, states that the species shows little variation on the coast of North America. It may be that the varieties do occur more frequently among the offspring, but that their survival would de-

pend upon the habitat in which they settled. The high spire and small aperture would be a disadvantage on a shore exposed to wave action, but not so in a salt marsh. The survival of the shell-less forms in the eel-grass pond habitat has been attributed by Read (loc. cit) to the low possibility of predation. *L. littorea* are more commonly observed and sampled on rocky shores and not in salt marshes, and so it is possible that unusual varieties have remained largely undetected.

The Petpeswick specimens described are now in the collection of the Nova Scotia Museum under accession number 1971-Z-180.

LITERATURE CITED

- Bequaert, J. C. 1943. The genus *Littorina* in the western Atlantic. *Johnsonia* 1(7): 1-27.  
Fretter, V. and A. Graham 1962. British prosobranch molluscs. London, Ray Society, 755 pp.  
Jeffreys, J. G. 1865. British conchology, 3: 1-393. London, van Voorst.  
Read, K. R. H. 1965. *Littorina littorea* L., without shell. *Proc. Malac. Soc. Lond.* 36: 307.  
Read, K. R. H. 1966. *Littorina littorea* L., without shells; a further note. *Proc. Malac. Soc. London* 37: 127.



Figs. 1 and 2. *Littorina littorea* from a salt marsh, Petpeswick Harbour, Nova Scotia. 1. An unusual, turreted form, length 16.1 mm. 2. A normal form, length 18.4 mm. (Photos by R. E. Merrick).



## NEWS

## NOTICE TO SUBSCRIBERS

In order to have a new volume of *The Nautilus* begin in January, rather than July, we have issued the remainder of volume 86 in a combined issue of nos. 2, 3 and 4. Those who have been subscribing in advance on a calendar-year basis will continue to receive their bills with the October issue. Those formerly subscribing by volume will receive a bill in April 1973 for *only half a year*. In effect, all subscribers will be receiving an extra half-year free-of-charge. By January 1974 all subscribers will be receiving the journal with a beginning volume and a new year coinciding.

## WESTERN SOCIETY OF MALACOLOGISTS

The Sixth Annual Meeting of the Western Society of Malacologists will be held at the Asilomar Conference Grounds in Pacific Grove, California, July 11-14, 1973, and will feature contributed papers, symposia, displays and study workshops on molluscan subjects.

Inquiries may be sent to the Secretary, Mrs. Edith Abbott, 1264 W. Cienega Ave., San Dimas, CA 91773. Applications for membership in the Society should be sent to the Treasurer, Mr. Glenn Burghardt, 14453 Nassau Road, San Leandro, CA 94577. Dues are \$2.50 for regular members and \$1.00 for students.

Executive Board Members for the year are: President Mrs. Twila Bratcher; First Vice-President Dr. James H. McLean; Second Vice-President Dr. James Nybakken; Secretary Mrs. Edith Abbott; Treasurer Mr. Glenn Burghardt; Members-at-Large Dr. George Radwin and Dr. George Davis; the three most recent Past Presidents are Dr. A. Myra Keen, Dr. Eugene V. Coan and Mrs. Beatrice L. Burch.

## AQUACULTURE JOURNAL

*Aquaculture* is a new international journal devoted to research on aquatic food resources related to human consumption. A specimen copy of vol. 1, no. 1 and subscription information (\$26.30 per year) about this quarterly may be obtained from the Elsevier Publishing Co., Journal Division, P. O. Box 211, Amsterdam - W. Netherlands.

## WILMINGTON SHELL CLUB

The Wilmington Shell Club was founded on October 2, 1972. It meets the first Monday of the month, October through May, at 8:00 p.m. in the auditorium of the Delaware Museum of Natural History. Officers elected: President, R. Tucker Abbott; Vice-President, C. John Finlay; Secretary-Treasurer, Sophie (Mrs. Eldon) Homsey; Archivist, Russell H. Jensen; Councillors: Mrs. Edmond du Pont and Paul Leach. Annual dues, \$5.00 (\$1.00 for each additional member of a family); corresponding membership, \$2.00.

## R. E. PETIT SHELL BUSINESS

In order to devote more of his time to research and other matters, Richard E. Petit of South Carolina has sold his shell and book business to *The Shell Cabinet*, Box 29, Falls Church, Va. 22044, owned and operated by the Misses Mary E. Young and Isabelle E. Welch. The International Directory of Conchologists will now be published by *The Shell Cabinet*.

---

IN SATISFACTION OF POSTAL REGULATION 132-622:  
OWNERS: Mrs. Horace B. Baker, Dr. R. Tucker Abbott, Dr. Charles B. Wurtz. Printing: 1000 copies. Paid subscribers: 596, shipped by mail.

## INFORMATION FOR SUBSCRIBERS

The *annual subscription* rate for *The Nautilus* is \$7.00 for individuals and \$12.00 for institutions (domestic or foreign). Subscriptions may begin either in January or, preferably, in July when a new volume begins. Send check or money order to "The Nautilus" to Mrs. Horace B. Baker, Business Manager, 11 Chelton Road, Havertown, Pa. 19083.

*Back issues* from volume 72 to date are obtainable from the Business Manager. Volumes 1 through 71 (if available) may be obtained in reprint or original form from Kraus Periodicals, Inc., 16 East 46th Street, New York, N.Y. 10017.

*Advertising rates* may be obtained from the Business Manager or Editor.

## CONTRIBUTORS

*Manuscripts:* Authors are requested to follow the recommendations of the *Style Manual for Biological Journals*, which may be purchased from the American Institute of Biological Sciences, 2000 "P" Street, N.W. Washington, D.C. 20036. Manuscripts should be typewritten and doublespaced; original and one copy are required, to facilitate reviews. Tables, numbered in arabic, should be on separate pages, with the title at the top. Legends to photographs should be typed on separate sheets. Explanatory terms and symbols within a drawing should be neatly printed, or they may be pencilled in on a translucent overlay, so that

the printer may set them in 8 pt. type. There is a charge of 50 cents per word for this extra service. All authors or their institutions will be charged 50 cents per line of tabular material and taxonomic keys. The publishers reserve the right, seldom exercised, to charge \$32 per printed page.

An *abstract* should accompany each paper.

*Reprints* and covers are available at cost to authors. When proof is returned to authors, information about ordering reprints will be given. They are obtained from the Economy Printing Co., Inc., R. D. 3, Box 169, Easton, Maryland 21601.

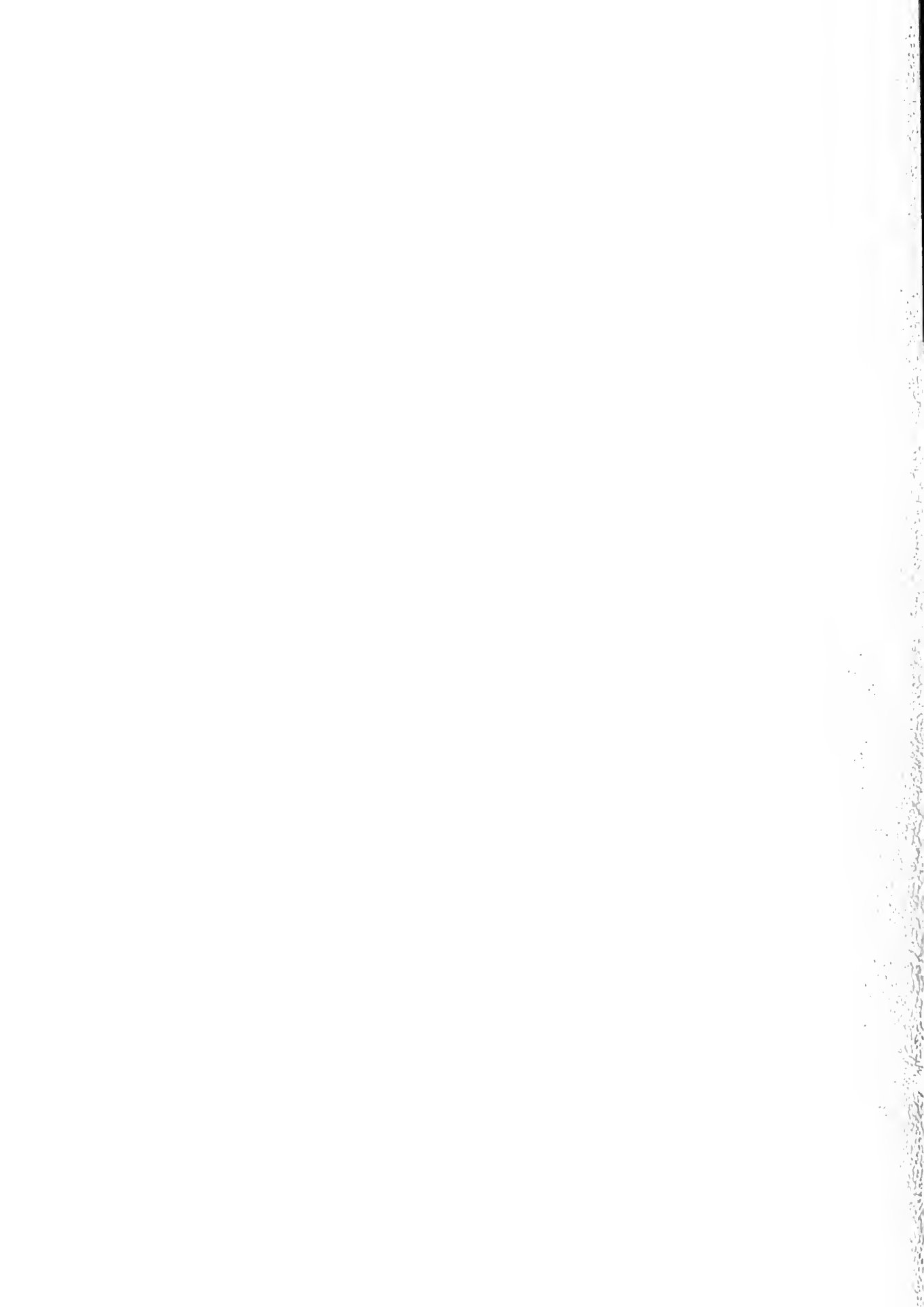



JULY, 1972

# THE NAUTILUS

Vol. 86

No. 1

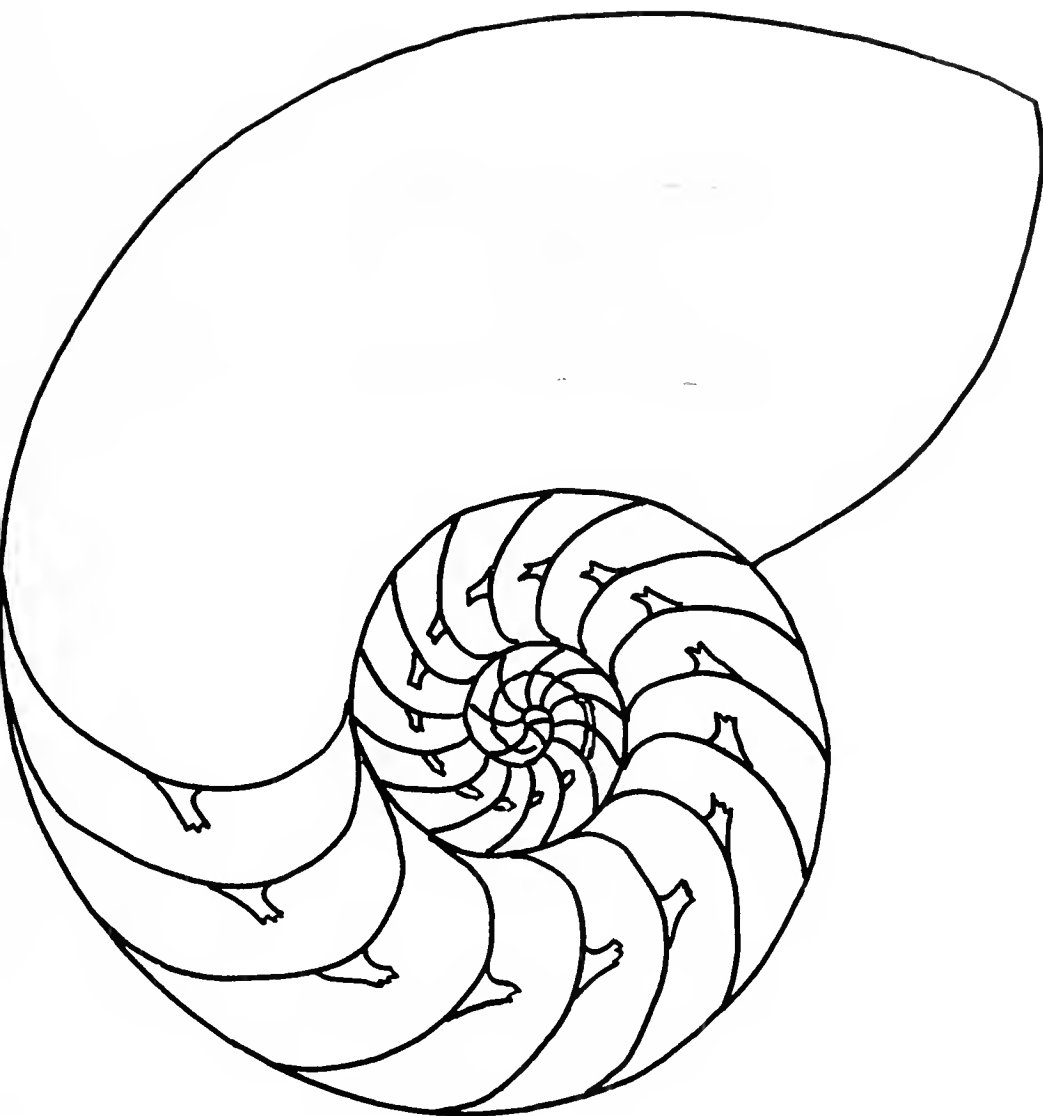

A quarterly  
devoted to  
malacology and  
the interests of  
conchologists

Founded 1889 by Henry A. Pilsbry. Continued by H. Burrington Baker.  
Editors: *R. Tucker Abbott and Charles B. Wurtz*

# EDITORIAL COMMITTEE

## CONSULTING EDITORS

Dr. Arthur H. Clarke, Jr.  
Department of Mollusks  
National Museum of Canada  
Ottawa, Ontario, Canada K1A-OM8

Dr. William J. Clench  
Curator Emeritus  
Museum of Comparative Zoology  
Cambridge, Mass. 02138

Dr. William K. Emerson  
Department of Living Invertebrates  
The American Museum of Natural History  
New York, New York 10024

Mr. Morris K. Jacobson  
Department of Living Invertebrates  
The American Museum of Natural History  
New York, New York 10024

Dr. Aurèle La Rocque  
Department of Geology  
The Ohio State University  
Columbus, Ohio 43210

Dr. James H. McLean  
Los Angeles County Museum of Natural History  
900 Exposition Boulevard  
Los Angeles, California 90007

Dr. Arthur S. Merrill  
Biological Laboratory  
National Marine Fisheries Service  
Oxford, Maryland 21654

Dr. Donald R. Moore  
Division of Marine Geology  
School of Marine and Atmospheric Science  
10 Rickenbacker Causeway  
Miami, Florida 33149

Dr. Joseph Rosewater  
Division of Mollusks  
U. S. National Museum  
Washington, D.C. 20560

Dr. G. Alan Solem  
Department of Invertebrates  
Field Museum of Natural History  
Chicago, Illinois 60605

Dr. David H. Stansbery  
Museum of Zoology  
The Ohio State University  
Columbus, Ohio 43210

Dr. Ruth D. Turner  
Department of Mollusks  
Museum of Comparative Zoology  
Cambridge, Mass. 02138

Dr. Gilbert L. Voss  
Division of Biology  
School of Marine and Atmospheric Science  
10 Rickenbacker Causeway  
Miami, Florida 33149

## EDITORS

Dr. R. Tucker Abbott  
Delaware Museum of Natural History  
Box 3937, Greenville, Delaware 19807

Dr. Charles B. Wurtz  
3220 Penn Street  
Philadelphia, Pennsylvania 19129

Mrs. Horace B. Baker  
Business and Subscription Manager  
11 Chelton Road  
Havertown, Pennsylvania 19083









MBL WHOI LIBRARY



WH 17XV Z

