



3 1761 05228760 4

UNIV OF
TORONTO
LIBRARY





Digitized by the Internet Archive
in 2007 with funding from
Microsoft Corporation



THE NORWEGIAN
NORTH POLAR EXPEDITION 1893—1896
SCIENTIFIC RESULTS

VOLUME I

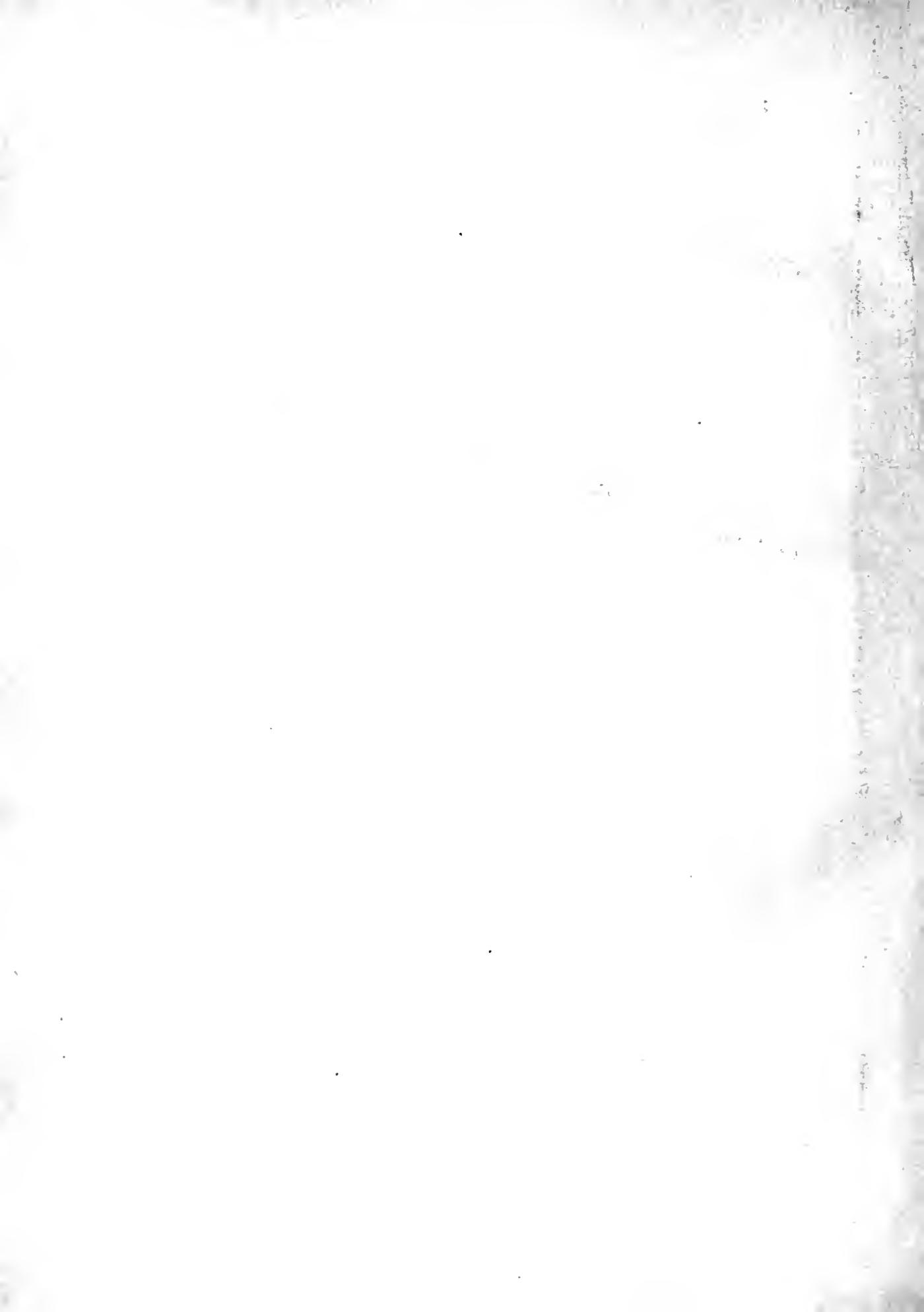

THE NORWEGIAN
NORTH
POLAR EXPEDITION
1893—1896

SCIENTIFIC RESULTS

EDITED BY

FRIDTJOF NANSEN

VOLUME I

PUBLISHED BY THE FRIDTJOF NANSEN FUND,
FOR THE ADVANCEMENT OF SCIENCE

CHRISTIANIA
JACOB DYBWAD

LONDON,
NEW YORK, BOMBAY
LONGMANS, GREEN, AND CO.

1900

LEIPZIG
F. A. BROCKHAUS

328564
2.7.36

Q
115
F7
v.1

21

CONTENTS OF VOL. I.

- I. COLIN ARCHER. The Fram. Pp. 1—16, with 3 Plates.
(Received November, 1898.)
- II. J. F. POMPECKJ. The Jurassic Fauna of Cape Flora, Franz Josef Land.
With a Geological Sketch of Cape Flora and its Neighbourhood by
Fridtjof Nansen. Pp. 1—147, with 3 Plates.
(Received October, 1898.)
- III. A. G. NATHORST. Fossil Plants from Franz Josef Land. Pp. 1—26,
with 2 Plates.
(Received April, 1899.)
- IV. ROBERT COLLETT and FRIDTJOF NANSEN. An Account of the Birds.
Pp. 1—53, with 2 Plates.
(Received November, 1899.)
- V. G. O. SARS. Crustacea. Pp. 1—137, with 36 Plates.
(Received November—December, 1899.)
-

1/2

PREFACE.

The aim of this Report, the first volume of which now appears, is to give, in a series of separate Memoirs, a complete account of the Scientific Results of the Norwegian North Polar Expedition of 1893—1896.

The expedition was rendered possible by the united support of

HIS MAJESTY KING OSCAR, THE NORWEGIAN STORTING,

and a series of contributors, amongst whom may be mentioned the three men, Messrs. THOMAS FEARNLEY, AXEL HEIBERG and ELLEF RINGNES, who formed the Committee of the Expedition, bore the burden of arranging its pecuniary affairs, and assisted with so much valuable work; and further, Mr. C. J. A. DICK, Baron OSCAR DICKSON, Consul WESTYE EGEBERG, Mr. ANTON CHR. HOUEN, Mr. A. S. KJOSTERUD, Consul NICOLAY H. KNUDTZON, Minister of State C. LØVENSKIOLD, Mr. AMUND RINGNES, the firm HALVOR SCHOU, Mr. C. SUNDT, Baron HARALD WEDEL-JARLSBERG, the ROYAL GEOGRAPHICAL SOCIETY OF LONDON, and others.

I do not know how to express in words the gratitude which my companions and I feel for the interest and confidence placed in our undertaking and ourselves before we started, and for the many signs of sympathy shown us after our return. I trust that the results published in these volumes will

give the Norwegian Nation and the noble contributors the best reward that we can bring them.

The expedition in the *Fram* must, to some extent, be regarded as a pioneer undertaking. It was trying a new mode of travelling for penetrating into the unknown region of the sea surrounding the North Pole. It was not easy beforehand to calculate what difficulties might there be met with, or what struggles for life the members of the expedition might have to go through.

Certainly, with the best of my knowledge, I could come to no other conclusion than that a ship like the *Fram* should, according to all probability, be carried by the ice, unharmed and safe, along its untrodden track across an unknown sea; but nevertheless I could not hide from myself the fact that this was contrary to the expectations of most authorities on the subject. It may, therefore, be considered a pardonable weakness, if I not only admitted the possibility of losing the ship, but also constantly kept this possibility in view, while preparing and equipping the expedition,

Nor could I say with certainty how long the voyage would last. According to my calculations, the probability was that it would not last longer than three years, but no one could be certain that this period might not be doubled or more, and I thought it my duty to equip accordingly.

The whole preparation of the expedition was therefore based on the possibility that it might last a long series of years, and that the ship might be lost, the members having to return a long distance across the drifting polar ice, or in boats, without being able to carry much in the way of scientific collections and instruments, or even scientific journals. For the planning of the scientific work, these considerations were, therefore, decisive.

The ship was made as small and as strong as possible; and in order to save space, as well as fuel for heating and light, it was thought imperative to reduce the accommodation for the members and the scientific work as much as possible. As the ship was nearly filled by the necessary provisions, coal, equipment, etc., nothing could be taken which was not considered quite essential. There was thus no room for special laboratories, which would have

III

considerably facilitated the many different kinds of scientific work. With our present experience from the *Fram*, this could be materially improved on a future expedition of the same kind. The worst thing was, however, that in order to save space and provisions, the number of the members of the expedition had also to be reduced to a minimum, and the scientific staff could not be numerous. It was therefore unavoidable that a number of scientific observations of various kinds should fall to each man's lot, and this seldom happens without the risk of having no series of observations quite complete and satisfactory.

Considering all this, and the numerous difficulties with which any kind of scientific work has to contend during such an expedition and in such surroundings, constantly adrift in the ice, it might be expected that our scientific results would not be very abundant. However, in spite of everything, it may be justly said that the expedition has brought home both abundant and valuable scientific material, which will in many respects essentially increase our knowledge of the North Polar Region. This result is solely due to the never-failing ardour with which my companions on board the *Fram* undertook the many and multifarious observations entrusted to them, and it has been a pleasure to hear the specialists who have kindly undertaken the elaboration of the material, express their unreserved and unanimous recognition of the amount of work done.

In issuing this first volume of the Scientific Results of the Expedition, therefore, I feel it my first and pleasant duty here to acknowledge, with deep gratitude, the devoted work of all my companions.

I desire especially to mention late Lieutenant, now Captain in our Navy, SIGURD SCOTT-HANSEN, who with admirable skill and energy took charge of the *astronomical, meteorological* (partly also *auroral*), *magnetic, pendulum* and other observations, as well as the navigation. These numerous observations had all of them often to be carried on under difficulties which, especially during the long, cold polar night, were unusually great. But nevertheless he has brought back material so copious and exact in every respect,

that it has drawn admiration from the specialists who are now working it up. I fear that very few who look through the volumes in which these observations are printed, will be able fully to realize what an amount of mental energy and endurance every page really represents.

I also desire to mention specially Dr. H. G. BLESSING, who carried on the *physiological* investigations on board, made the *botanical* collections, and during the last two winters undertook the observations of the *Aurora Borealis*. After my departure from the ship, he took charge of the *oceanic* researches, the *zoological* collections, the observations of the *ice*, of the *atmospheric electricity*, etc.

It is unnecessary to say that I remember with deep gratitude the work of Captain OTTO SVERDRUP, who was master of the *Fram*, and the leader of the expedition after March, 1895, and thus assisted in all branches of scientific work; — and last but not least my faithful companion on the sledge-journey, Lieutenant HJALMAR JOHANSEN, who in every respect rendered me ardent and valuable assistance in my endeavours to make such scientific observations as the often difficult circumstances of our long and lonely journey would permit.

There are many of the others, indeed, who also deserve to be mentioned specially; but as this will be done later in the various Memoirs. I here beg all my companions to accept my warmest thanks for their work, and the way in which they all of them contributed to the Scientific Results of the Expedition. I feel certain that it is with deep sorrow that we all miss two excellent comrades amongst the number of the living, LARS PETTERSEN, who died in 1898, in Hamburg, and BERNT BENTSEN, who died last winter, on a new expedition in Franz Josef Land.

It is only natural that at this moment I should also gratefully remember those men of high distinction who so largely assisted me in the scientific equipment of the expedition. I may especially mention Prof. W. C. BRØGGER, Prof. H. GEELMUYDEN, Dr. JOHAN HJORT, Prof. W. C. MAC INTOSH (St. Andrews), Prof. H. MOHN, Sir JOHN MURRAY (Edinburgh),

Dr. G. NEUMAYER (Hamburg), Prof. OTTO PETTERSSON (Stockholm), Prof. O. E. SCHIÖTZ, Dr. L. SCHMELCK, Mr. ROBERT H. SCOTT (London), Prof. ALEXANDER SUPAN (Gotha), General A. VON TILLO (St. Petersburg), Baron E. VON TOLL (Dorpat), Dr. HERCULES TORNØE, Prof. SOPHUS TORUP, Prof. N. WILLE, and Mr. EDWARD WHYMPER.

For the preparation of this Report, I have been fortunate enough to secure the co-operation of some of the first authorities in the various branches of science, all of whom, with friendly readiness, undertook the elaboration of the material. Thanks to the liberal assistance of the council of the *Fridtjof Nansen Fund for the Advancement of Science*, the necessary means for publishing this Report has been placed at my disposal. I thus hope that I shall be successful in my endeavour to make the volumes, both as to contents and appearance, worthy of the Norwegian Nation and the zealous and devoted work of my brave companions in the expedition.

During the preparation of the work, I have constantly kept in view the fact that we have traversed unknown regions of the Earth, regions which will not probably be visited again for some time to come. All observations made by us having thus an additional value, I have thought it right that everything should be worked up with the greatest possible care, and nothing be left out which might prove of the slightest interest. Being aware that this will probably, for a series of years hence, form a standard work as regards our knowledge of the North Polar Basin, I am trying to make all the information as trustworthy as possible by giving, in most cases, the original observations and material in full, so that the reader may be able to judge for himself how far the results or conclusions drawn are reliable, or may be able to draw his own conclusions. This may in several cases, *e. g.* the astronomical, meteorological, magnetic, oceanographic and auroral observations, add considerably to the size of the work; but it will, I hope, also materially increase its scientific value.

In order to place the various Memoirs before the scientific world at the earliest possible date, they are printed as they are finished, without

regard to the systematic sequence, and they will be published as soon as there is sufficient material to form a volume. Each Memoir will be paged separately, and will be given a number, running continuously from 1 through the whole series, by which it may easily be referred to.

It might be thought suitable that these volumes should have been introduced by a general narrative of the expedition, but as this has already been given fully in the popular account, 'Fram over Polhavet', which has appeared in several languages ('Farthest North', 'In Nacht und Eis', 'Vers le Pôle', 'Fra Ghiacci e Tenebre', etc.), it was considered unnecessary to give any such account here. I feel confident that a more valuable aid to future Polar expeditions will be afforded in the circumstance that the shipbuilder, Mr. COLIN ARCHER, has been kind enough to open the work by a description of the *Fram*, to which the expedition owes so much of its success.

It would have been desirable that a detailed chart of the route of the *Fram* and the sledge journey should have accompanied this first volume. As, however, such a chart must be based upon all the astronomical observations, and as this large material, which is now being worked up by Prof. GEELMUYDEN, is not yet quite ready for publication, the charts will appear in the second volume, which I hope will follow not very long after the first.

The second volume will probably contain the following Memoirs:

- 6) The Astronomical Observations and their Results, by Prof. H. GEELMUYDEN (with charts).
- 7) Terrestrial Magnetism, by Mr. AXEL STEEN, (with diagrams, etc.).
- 8) On the Pendulum Observations and their Results, by Prof. O. E. SCHIÖTZ.

In the third volume will probably appear:

- 9) The Oceanography of the North Polar Basin, (with charts and diagrams of the distribution of temperature, specific gravity, etc.), by myself.
- 10) On Hydrometers and their Errors, especially those caused by Variations of the Surface Tension of Liquids (with illustrations), by myself.

VII

- 11) The Depths, and Submarine Features of the North Polar Basin, by myself, with Chemical Analyses of its Deep-Sea Deposits, by O. N. HEIDENREICH.

This Memoir will also contain a description of the Microscopical Composition of the Deep-Sea Deposits by O. B. BØGGILD.

- 12) Diatomaceæ and Algæ living on the Drifting Ice and in the Sea of the North Polar Basin, (with 4 plates), by Dr. H. H. GRAN.

Amongst other Memoirs now being prepared for the subsequent volumes, I may specially mention the following:

Meteorology, (with diagrams and charts), by Prof. H. MOHN, in one volume.

Physiological Investigations made on board the Fram, by Dr. H. G. BLESSING.

On Arctic Scurvy, especially with regard to its Etiology, by Prof. SOPHUS TORUP.

Geological and Geographical Observations on the North Coast of Siberia and Franz Josef Land, by myself, with contributions from Prof. BRØGGER and Prof. GEELMUYDEN, (with maps and illustrations).

Observations on the Aurora Borealis, by myself, (with plates, diagrams and illustrations).

Mammalian Life in the North Polar Region traversed by the Expedition by myself, (with plates and illustrations).

Marine Animals collected during the Expedition, by Prof. G. O. SARS, (with plates).

Formation and Movements of the North Polar Ice, by myself, (with maps of the ice, etc.).

On 'Dead Water,' by Prof. V. BJERKNES and Mr. C. WALFRID EKMAN, (with illustrations)

Observations on Atmospheric Electricity, etc. etc.

VIII

The whole work is estimated to form five or six quarto volumes, which it is hoped will be finished in the course of about two years. It will be issued in the English language only.

If nothing prevents me, it is my intention to give at the end of the work, a complete summary of the Scientific Results of the Expedition.

GODTHÅB, LYSAKER. *December, 1899.*

FRIDTJOF NANSEN.

I.

T H E F R A M

BY

COLIN ARCHER.

3

The success of an expedition, such as that planned and carried out by Dr. Nansen during the years 1893—96, must in a great measure depend upon every possible contingency being foreseen and provided for, and every detail of the outfit chosen with a special view to the purpose to be served. To no part of the equipment could this apply with greater force than to the ship that was to carry Nansen and his companions on their adventurous voyage. It was clearly of the greatest importance that she should be the best that could possibly be devised for the purpose. The fate of the undertaking, and the safety of those who entered upon it, would evidently largely depend upon their always having, whatever might happen, a comparatively safe place of refuge to fall back upon; while the loss of the ship would necessarily entail hardship and suffering to the crew, and possibly the miscarriage of the whole enterprise. It was, therefore, in the highest degree important in the design and construction of the vessel to form as precise an estimate as possible of the nature of the strains and destructive forces to which she might become exposed, and of the various critical situations into which she might be thrown on her way, and to take such measures as experience might suggest for securing her safety.

The leading idea, which formed so to speak the key-stone of the expedition, was that the vessel, after having reached the vicinity of the New Siberian Islands, and having been frozen fast in the ice there, would be carried by an ocean current, slowly but surely, towards the coast of Greenland, passing at a greater or less distance from the North Pole. As the ice surrounding the vessel would drift with the current, it follows that it would necessarily be split up at certain seasons into floes, of which the dimensions were unknown, but which, judging from experience in

other parts of the polar seas, would be constantly grinding against each other, and crushing intervening objects with apparently irresistible force. To attempt to force a way through such ice was no part of the scheme. The part the ship would have to play was mainly a passive one. She would have to lie still and be squeezed. Assuming this reasoning to be correct the question arose: — Is it possible to build a ship sufficiently strong to resist the enormous pressure likely to be brought to bear upon her, without sustaining serious damage? This was the problem which had to be solved, and the prospect of solving it satisfactorily did not at first sight seem promising. Almost without exception the best authorities on the subject both in Norway and abroad, men who had the best opportunities of forming an opinion from personal experience, expressed the belief that the question must be answered in the negative; the ordeal, it was maintained, would be too severe for the strongest structure. Nor were the accounts of previous voyages in high latitudes encouraging. Many a fine ship had been tried and found wanting, thus adding strength to the general belief that the pressure of the ice is irresistible. When, therefore, the *Fram* was fitted out and ready for sea, it was undoubtedly still the prevailing opinion among those who had seen her while being built, that we might see Nansen and his men again; but the ship — never.

But, although the greatest weight was attached to these opinions and facts as far as they went, they could not be looked upon as affording conclusive evidence that the problem does not admit of a favorable solution. It is sufficient to say that, as far as was known, no ship had as yet been built with the avowed object of putting the problem to a practical test. As a rule arctic explorers had, heretofore, made use of ships, strongly built no doubt, and frequently specially strengthened for the occasion; but it is doubtful if any one of these ships could be said to have been thoroughly suited for the work, or to have been so strengthened as to make every part equally invulnerable. To effect this in a vessel originally built perhaps for a totally different purpose, may be a task of some difficulty. It becomes comparatively easy when the result aimed at is kept steadily in view from the keel upwards. It was to put the question of the possibility of surviving a protracted encounter with the ice to a practical test, that the *Fram* was planned and built. To make her proof against its assaults was the consideration to which all others had to yield precedence.

But apart from considerations of mere strength of structure, there were questions of design or model which, it was believed, would play an important part in the attainment of the desired end. It is sometimes expedient in an encounter to evade the full force of a blow rather than oppose it, even if it could be met with impunity; and there was reason to believe that by a judicious choice of model, something could be done to break the force of a „nip“, and thus deprive it of half its terrors. It frequently happens that small vessels, of which a considerable number every year visit Spitsbergen and Novaya Zemlya waters from the North of Norway, when caught in the ice, are raised bodily out of the water without sustaining serious injury. These vessels are by no means remarkably strong; but, like most small sailing craft, they generally have a considerable rise of floor, and sloping sides. When, therefore, they are nipped the ice, instead of being opposed by a vertical wall like an ordinary ship's side, meets a sloping surface, and is pressed down under the bilge, causing the vessel to rise until the ice from opposite sides meets under her keel, and forms a bed for her to rest on. Hence their immunity from destruction.

In order to utilize this principle it was decided to depart entirely from the usual deep-bilged form of section, and to adopt a shape which would afford the ice no point of attack normal to the ship's side, but would, as the horizontal pressure increased, force the attacking floes to dive under the ships bottom, lifting her as described above. How this desirable end was sought to be realized in the Fram, will best be understood by a reference to the plans (Pl. I and II), showing her lines and two of her cross sections. It will be seen that plane or concave surfaces were avoided as much as possible by giving her round and full lines. This, while increasing the power to resist pressure from outside, also had the advantage of making it easy for the ice to glide along the bottom in any direction.

The Fram is an auxiliary screw steamer rigged as a threemasted fore and aft schooner. Her engines, built at „Akers mekaniske Værksted“, are of 200 indicated h. p. and were expected to drive her, when moderately loaded, at a speed of 6 knots, with a coal consumption of 2.8 tons a day.

The first thing to be considered in making out the design was the size or carrying capacity to be chosen. As a general rule it may be said that, for any given strength of material, the strength of the ship will vary in-

versely as the size. For this reason the Fram was made only sufficiently large to enable her to carry the necessary supply of coals, provisions, and other stores for a period of 5 years, and to afford accomodation for her crew. The peculiar shape adopted for her cross section, coupled with the desire to cut down the length as much as possible — great length being an element of weakness — necessitated a greater beam than would be desirable in a seagoing ship. Considered merely as a safe home for her crew while drifting with the ice, even a greater approximation to the circular or bowl form, than that adopted, would have been preferable; but as the vessel would have to sail or steam a long distance before she could be frozen in, and again after emerging from the ice, it was not thought judicious to depart too far from the proportions between the extreme dimensions usually found in sea-going ships.

The principal dimensions are:

Length of keel	103.3 feet = 31.50 metres.
do. „ waterline	119 „ 36.25 „
do. extreme	128 „ 39.00 „
Breadth at waterline	34 „ 10.40 „
do. extreme	36 „ 11.00 „
Depth, moulded	17.2 „ 5.25 „

Displacement at 15.6 ft. (4.75 m.) draft, 800 tons. The measurements are taken to outside of planking but do not include the ice sheathing. By customhouse measurement she was found to be 402 tons reg. gross, and 307 tons nett.

It was estimated that the ship with engines would weigh about 420 tons. At the draft of water given above, 15.6 ft. which leaves a freeboard amidships of 3 feet, there would thus be a margin for cargo etc. of 380 tons. Actually this weight was exceeded by more than 100 tons, leaving only about 18 inches freeboard when the vessel started on her voyage. This extra immersion could not but act prejudicially when among the ice, as it would tend to retard the lifting process on which, it was believed, the safety of the ship would largely depend. Not only was there a greater weight to lift, but the manifest danger of the walls of ice, that would accumulate against the ship's side, tumbling over the bulwarks and filling her decks before the ice under water could take effect, would be greatly increased. She would, however, be

somewhat lightened by the time she was frozen fast. As the event showed, she actually rose readily when pressed, and the danger of being overwhelmed by superincumbent masses of ice does not appear to have been so great as might have been anticipated.

The model of the Fram having after much deliberation been fixed upon, it next became necessary to decide upon the most suitable system of construction, and, as the use to which this vessel was to be put was so totally different to that of any ordinary ship, it would be vain to seek a guide in any of the established rules and regulations for ship-building. The builder was thrown on his own resources, and had to be guided by his own judgement and experience. The strength of a structure depends, of course, not only upon the strength of the material used, but also quite as much upon the combination of the various parts, so as to form a compact whole. In this case it was important to economise weight, so as not to reduce too much the cargo carrying capacity, and it became, therefore, necessary to modify the scantlings accordingly, select the timber with care, and above all to make a judicious arrangement of the materials, paying due attention to the connection of the parts, and the sufficiency of the fastenings.

The Fram's keel is American elm in two lengths 14ⁱⁿ (35.5 cm.) square. The room and space is 2 feet (60 cm.). The frames are nearly all oak procured from the Naval dockyards at Horten, where it had been stored for a number of years and was, therefore, thoroughly seasoned. It is all grown to shape so that there is scarcely any cross grain. The frames are as usual double throughout, each course sided 10 to 11 inches, the two courses forming a frame being fayed and rivetted together, so as to make a firm and compact structure. The butts of the frames are connected by iron straps to prevent stretching. The inner lining consists of pitch pine in good lengths, and varying in thickness from 4ⁱⁿ to 6ⁱⁿ (10—15.2 cm.), the stringers and shelves being 8ⁱⁿ (20.2 cm.). The keelson is also pitch pine in two tiers, one over the other, each 15ⁱⁿ (38 cm.) square, from the stem to the engine room. Under the boiler and engines there was only sufficient height for one keelson. There are two decks. The main deck beams are American or German oak, the lower deck and poop beams are pitch pine or Norwegian yellow pine. All the deck planking is Norwegian pine, the upper decks being 4ⁱⁿ, the between-decks 3ⁱⁿ thick. The beams are fastened to the ship's side by Norwegian white

pine knees (root and stem) of which about 450 have been used in the ship. Wooden knees were as a rule preferred to iron as being more elastic. A considerable number of iron knees were, however, also used, where wood was less suitable. In the boiler- and engine-room the lower deck beams had to be raised about 3 feet to give sufficient height for the engines. The upper deck was similarly raised from the stern to the mainmast forming the poop, under which the cabins are situated over the engine room. On the poop, immediately in front of the funnel, a deckhouse was built in which was fitted a chartroom, and from which the companion steps lead down to the cabin, one on each side.

Independent of the ice sheathing, the outside planking is double and all oak. The two first (garboard) strakes are, however, single, 7ⁱⁿ (17.7 cm.) thick, and bolted transversely through the keel as well as to the frames. The first or inner layer of planking is 3ⁱⁿ (7.5 cm.) thick, and fastened with spikes only; outside this comes a course of 4ⁱⁿ (10.1 cm.) plank, fastened with oak treenails and through bolts in the usual manner. The two top strakes are again single, 6ⁱⁿ in thickness. The ice sheathing is greenheart, and covers the whole side from keel to within 18ⁱⁿ of the shear strake. It is 3ⁱⁿ thick at the keel gradually increasing to 6ⁱⁿ at and above the waterline. It is fastened with spikes and bay bolts only. Each course of planking was caulked and paid before the next was put on. The keel is thus inclosed by the planking, all but 3—4ⁱⁿ which project below it, and this part of the keel is rounded off so as not to obstruct the ice in passing under the ships bottom. The interstices between the frames were filled with a composition, consisting of coaltar, pitch, and sawdust, boiled to a consistency and poured in hot, the ship's side thus forming one compact mass varying in thickness from 28—32 inches (71—81 cm). In consequence of all open spaces in the framing being filled, there was no room left for bilge water under the ceiling. A loose floor was, therefore, laid a few inches above the ceiling on each side of the keelson, to give room for any water that might collect in the ship. In order still further to strengthen the side and more especially to prevent stretching, iron riders were fitted on the ceiling extending from the shelf of the upper deck downwards, well over the floor timbers.

The stem consists of three massive oak timbers, one inside the other, making over 4 feet (1.22 m.) of solid wood in a fore and aft direction, by

15ⁱⁿ (38 cm.) broad. The three outside courses of planking, as well as the ceiling, had each a separate rabbet cut in the stem. The propeller sternpost is in two pieces placed side by side, and measuring 26ⁱⁿ (66cm.) laterally by 14ⁱⁿ (35 cm.) fore and aft. As will be seen by the lines (Pl. I), the overhanging counter runs to a sharp edge, and there is no transom. On each side of the sternpost is fitted a strong counter timber parallel to the middle vertical plane, making as it were a double sternpost, and the space between them forms a well, running up right through the upper deck. The rudderpost is placed in the middle of this well, and divides it into two parts, one for the screw and the other for the rudder. By this means the rudder as well as screw — which is made to unship — can be raised clear of the water, and again shipped into their places at pleasure. The rudder is hung so that the rudder shaft, which is cylindrical, revolves about its own axis, in order to prevent jamming if the well should be choked with ice. Aft the rudder well the space between the counter timbers is filled with solid wood, the whole being securely bolted together laterally. The frames at this part of the hull butt up against the counter timbers, and are secured to them by means of knees. The stem and sternpost are of course strengthened, and the two sides of the ship bound together, with massive aprons and breasthooks of wood or iron.

Although not built specially for „ramming“, it was probable that the Fram would occasionally be placed in situations, in which it would be necessary to attempt to force a passage. Her bow and stern were, therefore, shod in the usual manner with an iron casing. On the forward face of the stem was bolted a segment-shaped bar of iron, from the hobstay plate downwards, some distance under the keel. Outside this were bent, at right angles to the stem, bars of iron about 3ⁱⁿ × 3/4ⁱⁿ (7.6 × 1.9 cm.), extending about 6 feet along the planking on either side. These bars were placed close together thus forming a continuous armour plating down to within a couple of feet of the keel. The sharp edge of the counter abaft the wells was similarly shod with transverse bars of iron, while the lower edges of the wells were sheathed with stout iron plating. The rudder post, which from its exposed position may be said to be the Achilles' heel of the ship, was strengthened with three heavy U shaped iron frames of which one was fitted inside

the screw aperture, the others, one on each side of the two posts and the keel, and bolted together laterally.

In whaling and sealing ships, intended to work among ice, it is the usual practice to amass quantities of timber in the bows, so as to make them disproportionately strong as compared with other portions of the hull. These ships generally have more powerful engines than the Fram, and they have frequently to force their way through the ice, going at it full speed. The bows have then to bear the brunt of the battle. In our case on the contrary where „nipping“ was the chief danger to be apprehended, it was impossible to say where the blow might hit the hardest, but it was probable that the broadside, as presenting the largest target, would be exposed to the most violent attacks. But the broadside is evidently, both structurally and from its shape which approaches nearest to a plane, the weakest part of the hull. It was, therefore, necessary to adopt extraordinary measures for strengthening this part of the vessel. The plan adopted will be best understood by referring to the plans of sections shown on pl. II. Under every beam in both decks were fitted diagonal stays of yellow pine 6ⁱⁿ × 10ⁱⁿ (15.2 × 25.4 cm.), placed nearly at right angles to the ship's side, and securely fastened to the side and to the beam with wooden knees. Of these diagonals there are 68 distributed over the ship. There are, besides, under each beam three rows of upright stanchions in the between decks, and one row in the lower hold from the keelson. These are tied by iron straps to the keelson, to the beams, or to each other. The whole interior of the ship is thus filled up with a network of braces and struts, so arranged as to transmit the pressure from outside, and give rigidity to the whole structure. As will be seen from the drawings, the arrangement of the stays had to be somewhat modified in the engine room, so as to allow the boiler and engines to be placed in the middle line of the ship.

All bolts, spikes, and other fastenings, as well as all wrought iron work for hull, spars and rigging, with the exception of the heaviest forgings, such as riders, breasthooks, rudder pintals and gudgeons etc., are galvanised.

For lifting the anchors — which are Trotman's patent — there is a Clarke and Chapman's windlass worked by hand or by a steam winch, placed on the main deck just abaft the foremast. The hold is divided into water-tight compartments by two bulkheads, one immediately abaft the foremast, the other in front of the engine room. Besides two ordinary hand pumps

there is a powerful centrifugal pump worked by steam, and communicating with each compartment.

The cabin, which had to give accomodation to the whole crew, is situated under the poop deck over the engine room. The centre saloon is about 13 ft. \times 14 ft. On both sides and abaft the saloon are 6 berths of which 4 are single berths. Special precautions were taken to make the cabins as impervious as possible to the arctic frost. Previous experience shows that it is highly objectionable, however thick the wall, to leave the ends of through bolts, and other fastenings passing through the ships side, exposed in an inhabited part of the ship. The metal, being a good conductor, draws the heat from the adjacent air which is moist from the exhalations of the occupants, and, on being cooled, deposits its moisture about the metal in the shape of hoar frost or ice, always accumulating, and after a time becoming very troublesome and destructive to health and comfort. To obviate this, and also add to the thickness of the wall, all bolts and other metal showing on the ships lining were first covered with patches of felt. Three light panelings were next put up parallel to the side one inside the other, with intervals between them and the wall, and between each other, and these intervals were filled with alternate layers of cork shavings, reindeer wool, and thick felt, one interval being left empty as an air jacket. The floor, the ceiling, and the thwatships bulkheads enclosing the cabin were similarly treated but with fewer successive layers, and partly without the air space. The doors leading to the companions were made of double thickness with a space between filled with reindeer wool, and the door sills were raised 15ⁱⁿ from the floor to prevent the influx of cold air. In the saloon a stove was fitted with means of ventilation. Light is obtained through a skylight with treble plate glass, placed over the middle of the saloon.

Contrary to the advice of experienced whalers, who strongly advocated the square rig for maneuvering among ice, the Fram was rigged as a fore and -aft three masted schooner, only carrying on the foremast a flying square topsail and foresail which could be lowered, and in the opinion of Capt. Sverdrup this style of rig proved, under the circumstances in which she was placed, the most suitable for the purpose. Two hands on the watch were sufficient to work the ship under sail, a matter of importance with a small crew. Her masts, three fine Oregon spars, have a diametre at the

partners of respectively 20ⁱⁿ (51 cm.), 22ⁱⁿ (56 cm.) and 18ⁱⁿ (46 cm.) for the fore- main- and mizzenmast, the latter being stepped in a beam of extra size over the engines. The mainmast has a housing topmast on which the „crows nest“ is fixed, 100 feet (31 m.) above the sea level. The fore- and mizzen masts are on the contrary pole masts, the upper part above the peak halyards being scarphed on to the lower mast, and secured with iron rings.

The sail plan (Pl. III) shows the arrangement of the sails. Their total area is about 720 square yards (602 m.²). All the standing rigging is steel wire, and the running rigging fine spun hemp rope. The three boom-sail sheets were fitted with sheet buffers, the blocks were all specially made, and the more important ones fitted with patent bushes. The bridge for the commanding officer is built across the ship round the mizzen mast, 6 ft 6ⁱⁿ above the poop deck. There are no chain plates visible outside the vessel to break the smoothness of the side. The lower deadeyes are held by eyebolts passing through the waterways and fastened to the frames inboard. There is, upon the whole, but little of interest to note with regard to the rig, into which no novelties of consequence were introduced. The object aimed at throughout was to make it simple, strong, and easy to work.

The Fram was furnished with 8 boats. Two of them were of a considerable size, measuring 28 ft × 9 ft × 4 ft. They were carvel built of oak, strong but comparatively light, and were provided with a deck, mast and sails. Each of them is large enough to carry the whole ship's crew with provisions for several months. They were intended as a refuge from wind and cold, and to carry the explorers home in case the ship was lost or had to be abandoned. Their services were never required. There were besides 4 sealing boats of the ordinary type 20 ft × 6 ft, lightly built of American elm; an oil launch 20 ft × 5 ft also built of elm, and a small Norwegian „pram“. With the exception of the launch which was purposely broken up during the voyage, and the pram which had sustained some damage, all the boats were brought home in the best condition. The large boats were carried on a pair of gallows over the main hatch, the sealing boats and launch in davits, and the pram on deck.

Having now given a brief description of the Fram, her design and her construction, and pointed out some of the details in which she differs from the general run of ships, it will be of interest to inquire in how far she can

be said to have justified the expectations of her designers, and the confidence placed in her by her adventurous crew. She had, it is true, carried them home safely and in good health after a 3 year's cruise. But if, on examination, there should be found evident signs of weakness or straining, showing that she had not, nevertheless, escaped altogether uninjured from the clutches of the ice, there would still be good reason to doubt what the result might have been, had the voyage been protracted over a much longer period. On this point a good opportunity has been afforded of forming an opinion. After a year's rest it was decided to add a superstructure in the shape of a spar deck in order to make her fit for her second expedition, and while undergoing this alteration, she was carefully surveyed both outside and in the hold; but — with the single exception mentioned below — not the smallest sign of straining could be discovered in any part of the vessel. Her butts and scarphs were as close and firm as the day she was launched, and the pitch or putty in the seams showed no indication of a movement or disturbance of the parts having taken place. The exception alluded to refers to one of the bolts in the U shaped mounting described above which had started, showing that her „Achilles' heel“ had been exposed to a severe blow. This was the only fastening that had to be renewed. It may, therefore, confidently be asserted that the Fram has withstood the ordeal she has passed through, even better than the most sanguine could have ventured to hope, and there seems little reason to doubt that she would have come triumphantly out of even more severe trials than those to which she had been exposed. Professor Nansen has expressed the opinion that the vessel has never — even when most severely pinched — been tried approximately to the limit of her power of resistance, and, assuming this view to be correct, it would seem that her scantlings might have been considerably reduced without incurring the risk of a collapse, while it may at the same time be taken as a proof that the design and system of construction adopted is a good and efficient one.

The Fram had a slight leak when she left the stocks arising, possibly, from some augerhole which had been overlooked, or, more probably, from some part of the caulking having been carelessly done. No perceptible change took place in the leakage before she was frozen fast. When, at the end of three years, she was finally released from her icy imprisonment, it was found that she made more water than before, and she continued to do so till she

was discharged. This may partly be accounted for on the supposition that the ice had drawn some of the oakum out of her seams, a thing not to be wondered at considering the scouring she had gone through, which had left numerous traces in the shape of erosions on the ice sheathing. But this is not in itself sufficient to fully explain the increase of leakage. Capt. Scott-Hansen states that when sudden and violent changes of temperature set in, a crackling noise was heard all over the ship, arising in all probability from the expansion and contractions of timbers and planking; and this, in conjunction with the expansion of the water when being converted into ice in seams and cracks, would necessarily have the effect of compressing the oakum and to some extent the wooden planking, widening the seams and giving access to the water when milder weather set in, and the ice melted. As the increase of leakage could not be traced to structural weakness or to any part of the planking having given way to outside pressure, this explanation seems the most plausible, and shows the importance of using the hardest and most unyielding kind of timber in the planking, and of having the caulking well and carefully done. The vessel was hove down and the ice sheathing recaulked before she started on her present voyage, reducing the leakage to a trifle. At no time can it be said to have been considerable. Half an hour's spell at the handpump every watch was sufficient to keep the ship dry on her voyage home from the far north. Perhaps no better proof can be adduced of the unimpaired condition of the structure than the fact, that Capt. Sverdrup has started on his second voyage — perhaps no less hazardous than the first — without having found reason to suggest any repairs whatever (beyond the caulking mentioned above) to any part of the original hull.

Professor Nansen's expedition in the *Fram* has taught us many useful lessons scientific and practical. And not the least important of these is the practical proof it affords of the possibility of building ships capable, in all human probability, of resisting with impunity the assaults of such ice, as is to be met with in the arctic seas.

LARVIK, *November*, 1898.

COLIN ARCHER.

EXPLANATION OF THE PLATES.

Pl. I.

Fig. 1. The lines of the „Fram“ in vertical projection. The lines of the frames (2—60) projected on a vertical longitudinal section as well as on a transverse section.

Fig. 2. The lines of the „Fram“ in horizontal projection.

The numbers indicate the same in both figures.

W. L. 1—5. The water lines in vertical projection (fig. 1) and in horizontal projection (fig. 2).

2—60. The frames.

Pl. II.

Fig. 1. Vertical longitudinal section of the „Fram“.

Fig. 2. Plan showing the deck and the arrangement of the Cabins etc.

Fig. 3. Transverse section amidships, at *a b*, fig. 1.

Fig. 4. Transverse section at the engine room, at *c d*, fig. 1.

The letters and numbers indicate the same in all figures.

S. Saloon.

B. Berths.

G. Galley.

St. Study (on the poop deck).

C. Chartroom (on the poop deck).

CB. Coal Bunkers.

1. Raised forecastle.

2. Windlass.

3. Frame timbers.

4. Aprons.

5. Supports under deck beams.
6. Diagonal stays.
7. Wooden knees securing the stanchions and diagonals.
8. Iron straps.
9. Steps leading to poop.
10. do. „ from deck house to 'tween decks.
11. do. „ to cabin.
12. Funnel, jointed so as to lower when under canvas.
13. Deck house with chart room and study.
14. Skylight.
15. Ladder leading to engine room.
16. Boiler.
17. Engines.
18. Well for raising screw propeller.
19. do. „ „ rudder.
20. Counter timbers.

Pl. III.

Design of the rig of the „Fram“.

THE NORWEGIAN POLAR EXPEDITION 1893-1896 N°1.

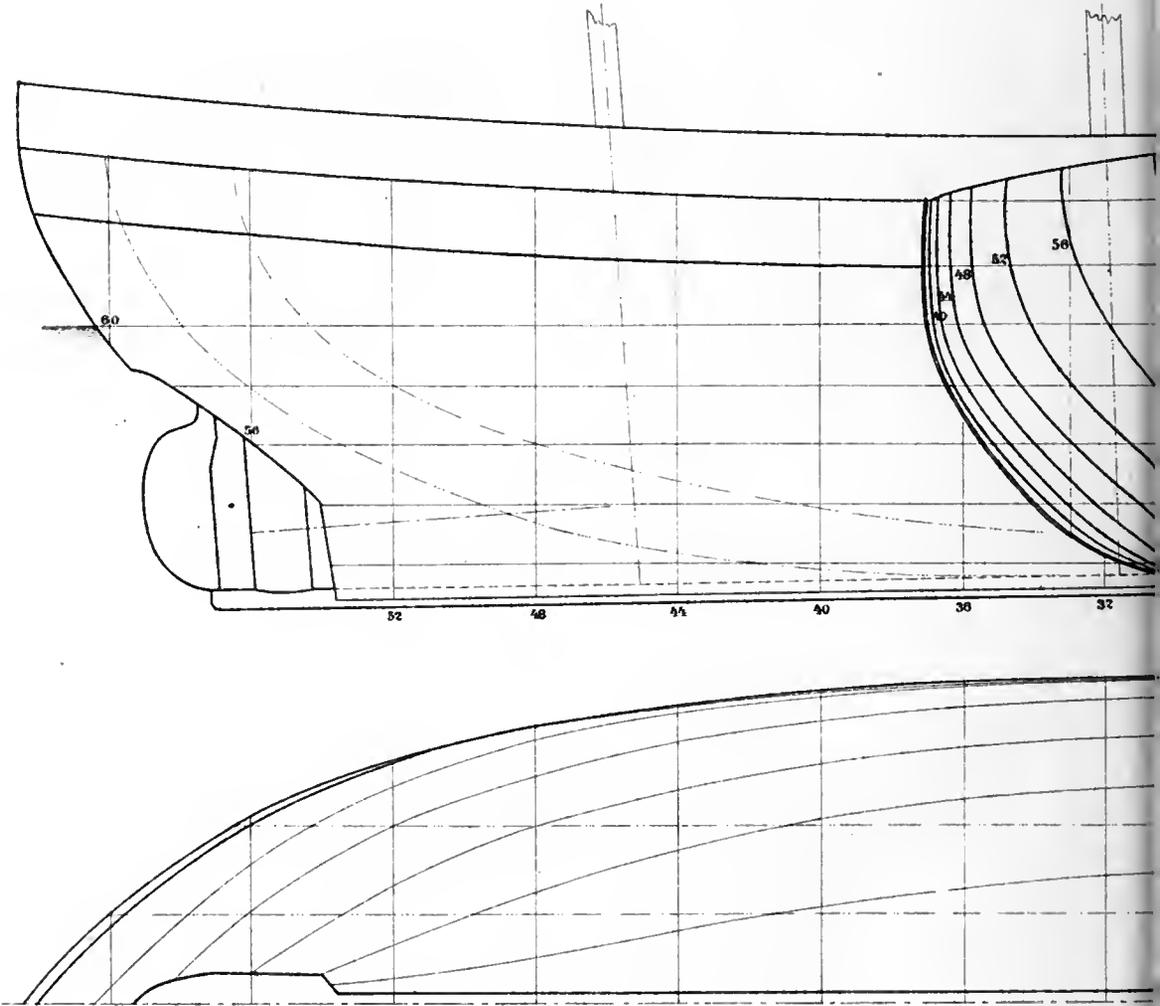

1.

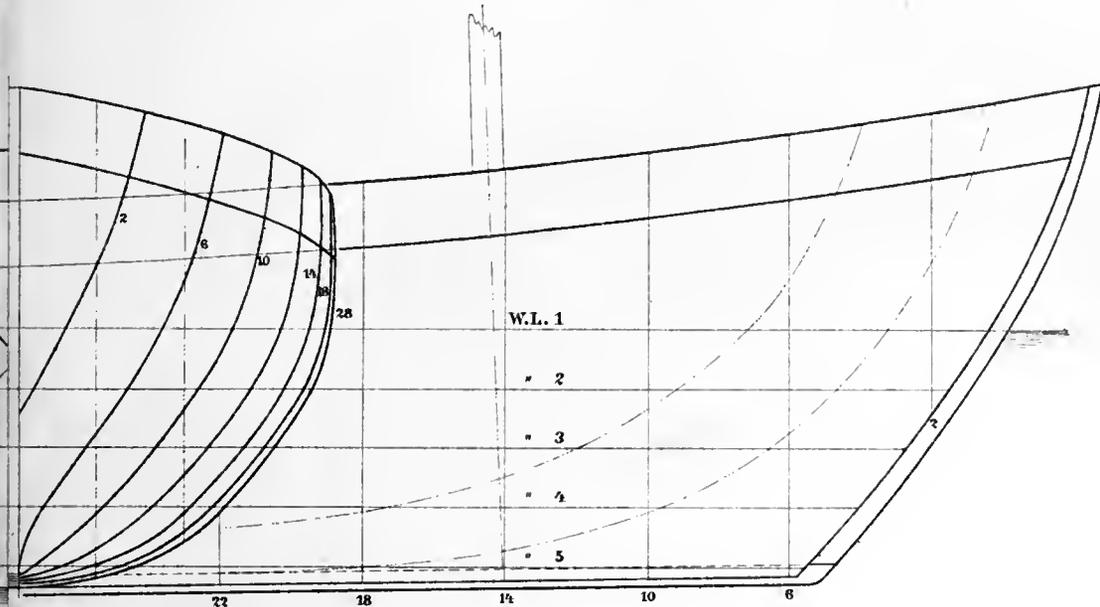

2.

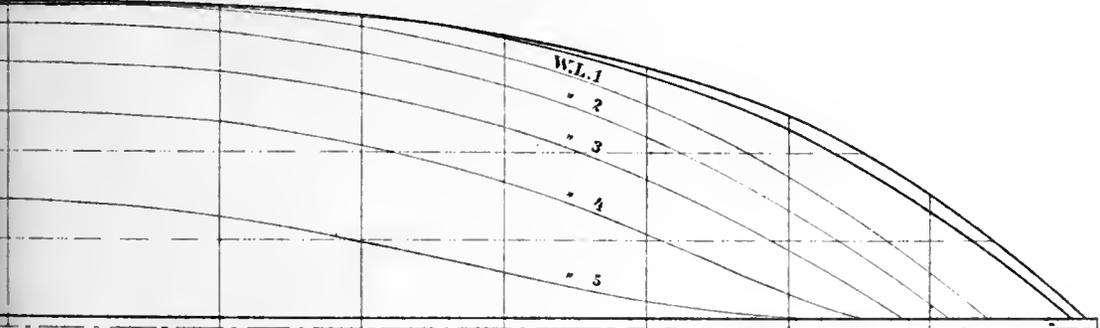

am.
1892

Lerick, Nov 1898
Golin Archer

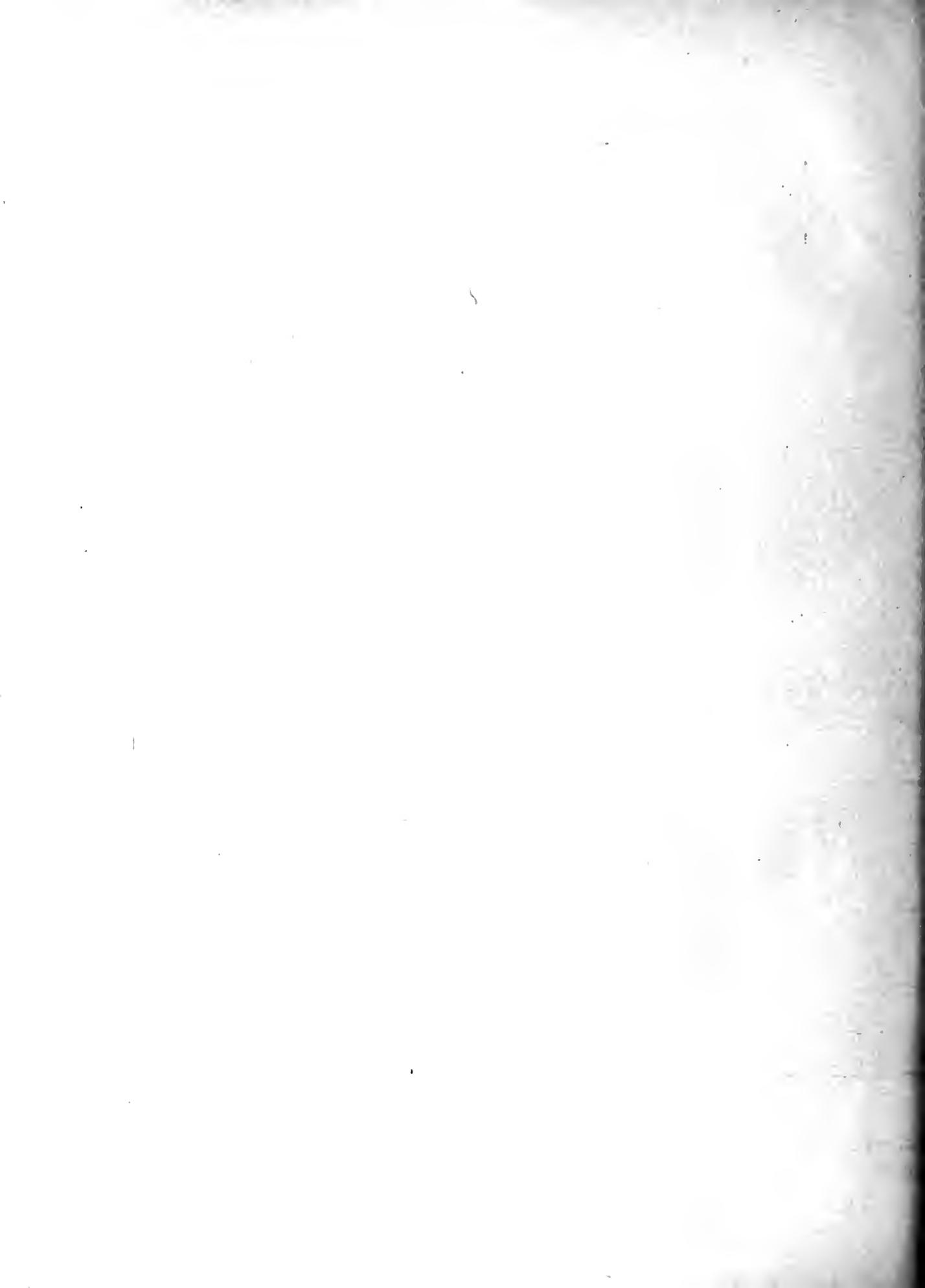

16

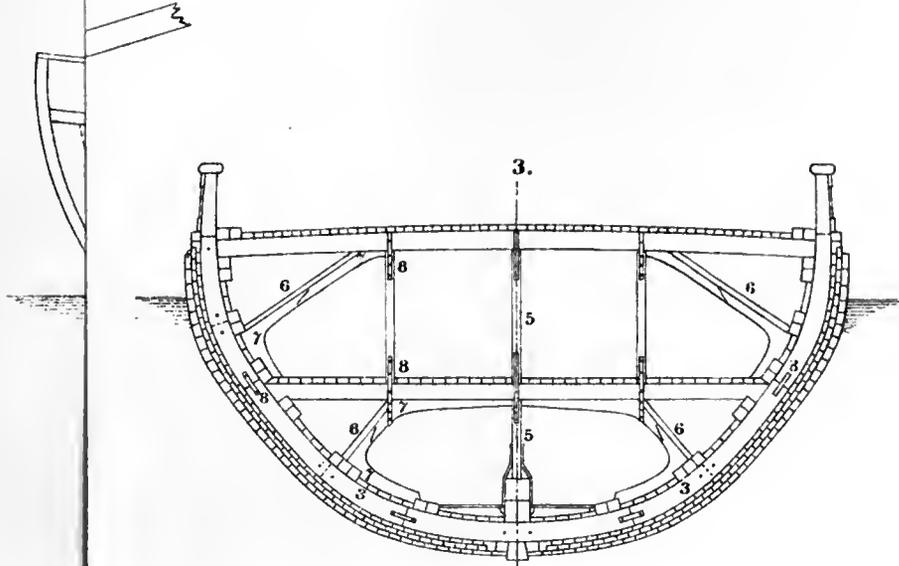

Section at a b

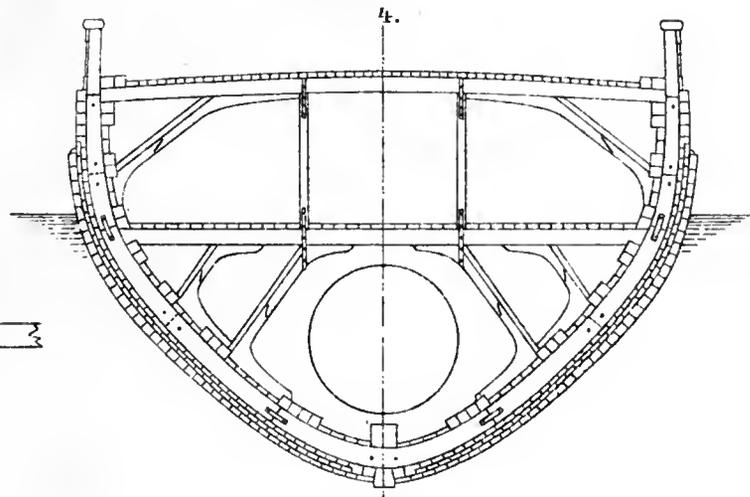

Section at c d

Fram
1892

Larsen, Nov. 1895
Gösta Archen

Den pris



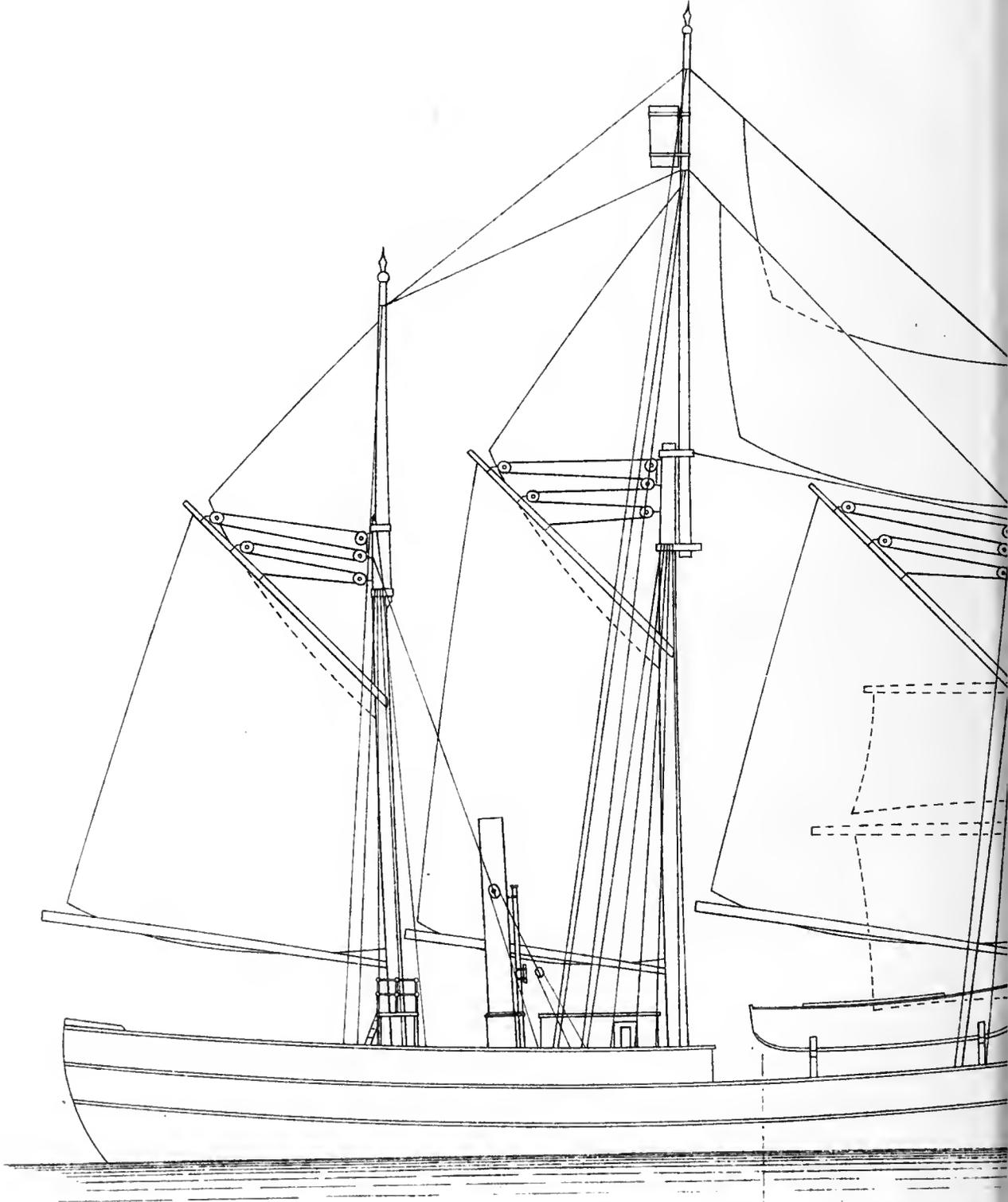

Fram

1892

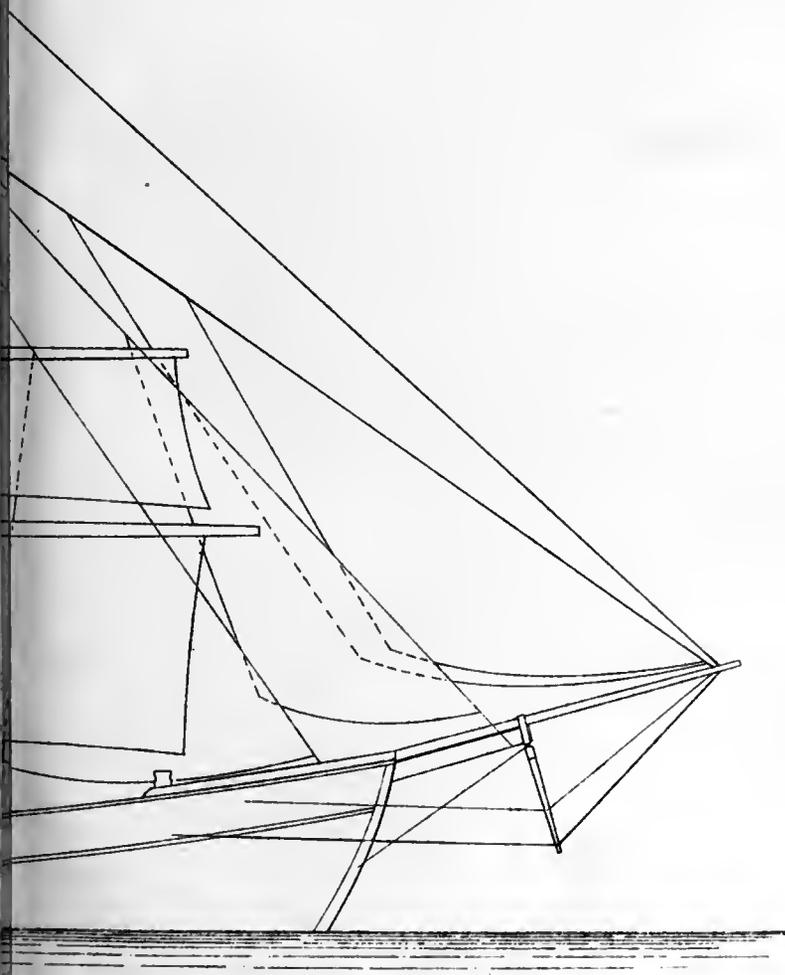

Larvik Nov. 1898
Colin Archer

II.

THE JURASSIC FAUNA OF CAPE FLORA,

FRANZ JOSEF LAND

BY

J. F. POMPECKJ.

**WITH A GEOLOGICAL SKETCH OF CAPE FLORA AND ITS
NEIGHBOURHOOD**

BY

FRIDTJOF NANSEN.



A GEOLOGICAL SKETCH OF CAPE FLORA AND ITS NEIGHBOURHOOD.

BY

FRIDTJOF NANSEN.

The geology of Cape Flora and its neighbourhood has been subjected to special researches by Dr. REGINALD KÆTTLITZ, the geologist of the Jackson-Harmsworth Expedition, who stayed there for three years (1894—1897). The results of his important investigations have been most ably described by Dr. KÆTTLITZ himself¹, and his collections have been examined and described by Messrs. E. T. NEWTON and J. J. H. TEALL². Much valuable information about the geology of this little-known country has thus been obtained. There are, however, still many open or doubtful questions left, which will have to wait for future researches made on the spot, if they are to be fully settled. In the mean time, I trust that every contribution, imperfect though it may be, to our knowledge in this respect, will be welcome.

During my stay at Mr. Jackson's house, Elmwood, on Cape Flora, from June 17th to August 7th, 1896, I used what little time there was left me from other important work, to study, in company with Dr. Kættlitz, the geology of this interesting neighbourhood. Through Jackson's kindness and with Kættlitz's valuable assistance, I thus was enabled, amongst other things, to make a collection of fossils and rocks from the Jurassic deposits of this locality.

¹ Dr. Reginald Kættlitz. „Observations on the Geology of Franz Josef Land.“ Quarterly Journal of the Geological Society, vol. LIV (1898), pp. 620—645. See also his „Brief Sketch of the Geology“. Geographical Journal, vol. IX (1898), pp. 132—135.

² E. T. Newton and J. J. H. Teall. „Notes on a Collection of Rocks and Fossils from Franz Josef Land, made by the Jackson-Harmsworth Expedition during 1894—1896.“ Quart. Journ. Geol. Soc. vol. LIII (1897), pp. 477—519; and also *ibid.* vol. LIV (1898), pp. 646—651.

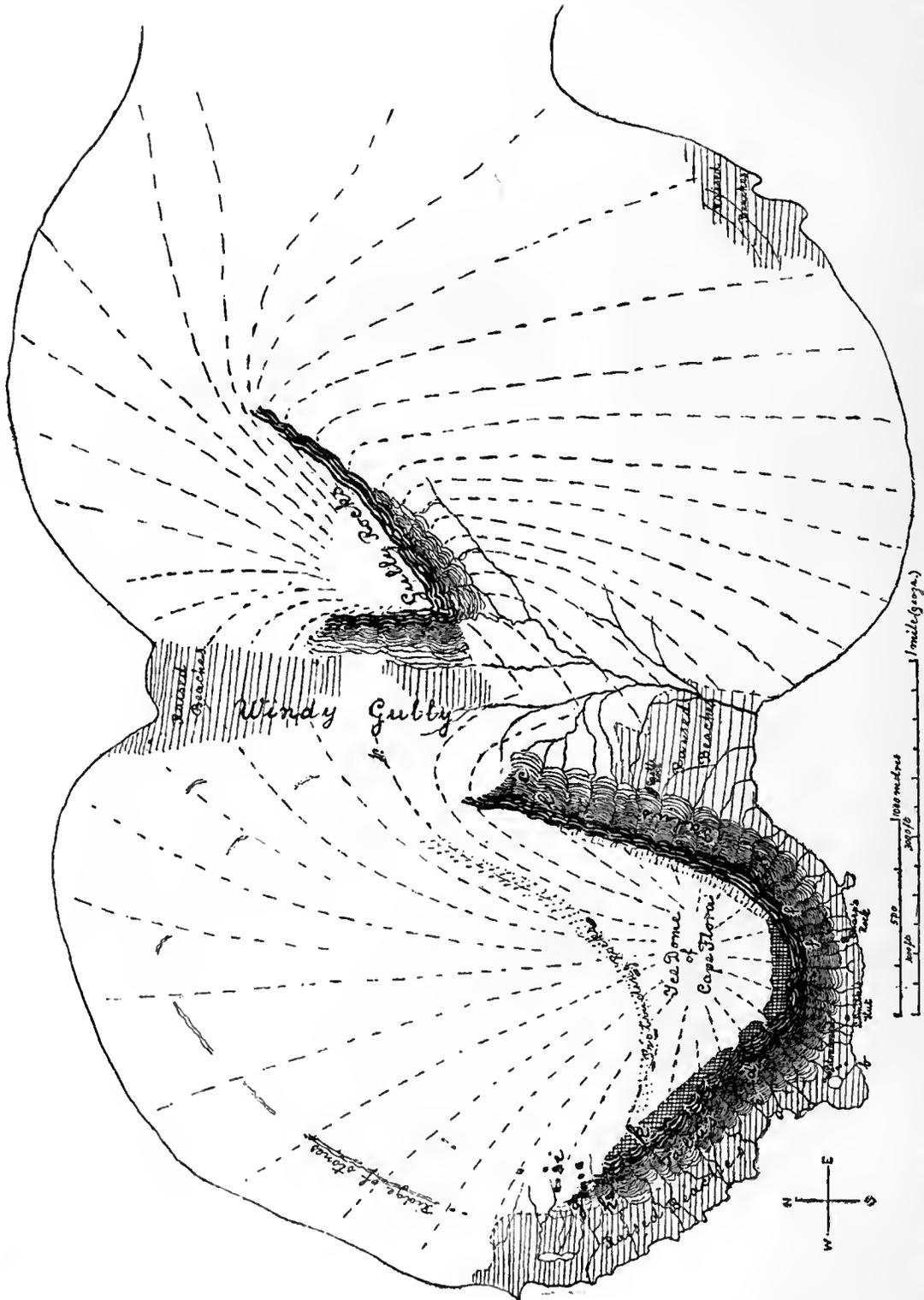
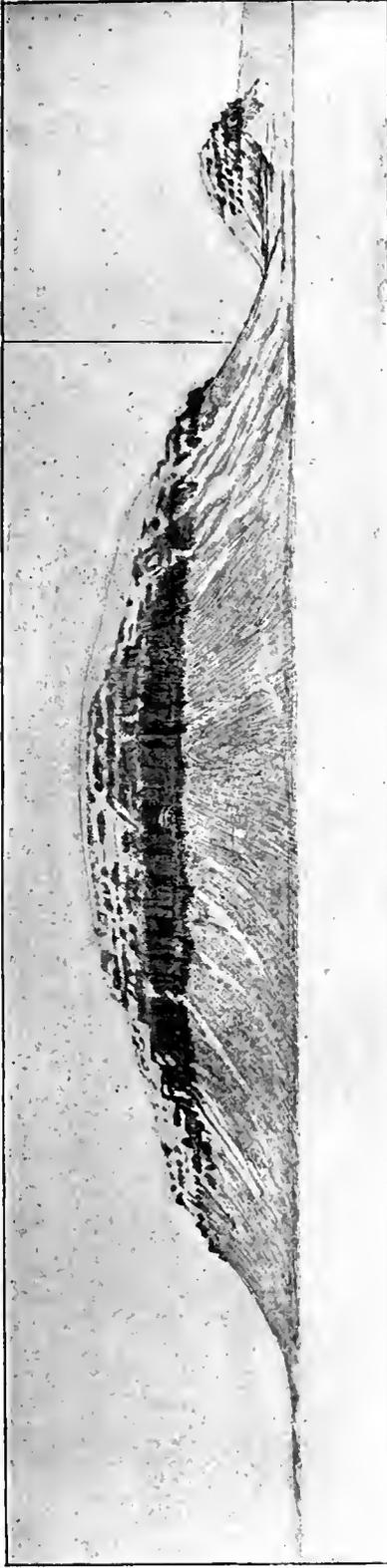

Fig. 1. Diagrammatic sketch of Cape Flora and Gully Rocks with glaciers, based principally on maps by Mr. Jackson, Lieut. Armitage, and Dr. Koeltitz. The dotted lines indicate the trend of the glaciers; the horizontal strokes indicate bare, low land, mostly raised beaches. The hachure indicates the talus, and the dark, thick lines and dots the basalt. The cross lines indicate a ledge plateau on top of the basalt, which is bare in the summer. Rocks and ridges protruding through the glacier-covering are marked by black dots or lines. The letters *a-l* indicate the localities where the Jurassic strata are exposed or where fossils have been found.



Elmwood

f

Windy Gully
Gully
Rocks

Fig. 2. Cape Flora and Gully Rocks seen from the south. Drawing from photographs by F. N. c. Locality at south end of Windy Gully, visited on July 14th, 1896. f. Place at the base of the basalt visited July 24th, 1896.



h

k

a

d

Elmwood Base of
basalt

Gully
Rocks

Fig. 3. Cape Flora, seen from the south-west. From a photograph by F. N. a. Place near the shore where fossils were found August 2nd, 1896. d. Locality visited July 16th 1896. h. Behind this ridge is the locality visited July 12th, 1896. k. On the ledge plateau here (about 900 ft. above sea-level) Kœttlitz found plant fossils, 1897.

Dr. J. F. POMPECKJ undertook the examination of this collection, which, however, does not contain much that has not been found by Kœttlitz. But as Pompeckj does not agree with Mr. E. T. Newton, who has described Kœttlitz's collection of fossils, on several rather important points as regards the determination of the fossils, and the exact horizon of the various strata, etc., I hope his paper will throw some additional light on the subject, and may be read with much interest.

Dr. Pompeckj has asked me to accompany his paper with a sketch of the general features in the geological structure of Cape Flora, and the description of the localities where the fossils were found. In doing this, I feel it to be my pleasant duty, first of all to express my sincere thanks to Mr. FREDERICK JACKSON for the kind way in which he helped me in my geological researches while I was his guest at Elmwood. I also use this welcome opportunity of thanking Dr. REGINALD KœTTLITZ for his most valuable assistance and companionship. He took me to the places where, before my arrival, he had already found fossils, or had observed anything of importance; and had it not been for him, I should certainly not have been able to do what little I did, during the few days which were at my disposal.

I agree with Kœttlitz on all essential points, and have nothing new of importance to add to what he has already said. In some respects this sketch may, however, supplement his descriptions, and thus help to explain more fully the conditions and circumstances under which the most northern Jurassic fossils ever known have been found.

Cape Flora, situated in circ. 79° 56' N. Lat. and circ. 49° 40' E. Long. is the western extremity of the long and narrow peninsula which forms the south-western part of Northbrook Island.

A deep valley, *Windy Gully*, the bottom of which is only 16·8 metres (55 feet)¹ above the sea, passes from north to south straight across this narrow peninsula, about three kilometres east of its western extremity, thus separating the mass of Cape Flora from the eastern part of the island, and making it an isolated hill of no great extent.

¹ Dr. Kœttlitz says that Windy Gully „is about 1 mile long and 500 yards wide, with a general surface about 100 feet above the sea. Some parts, however, rise to greater elevations. The floor is covered over with rounded, water-worn, subangular and angular stones and boulders, together with a dark, tenacious mud“ (l. c. p. 623). I suppose these 100 feet are not meant for the actual bottom of the valley, for this, according to my measurements, was 55 feet at its highest level.

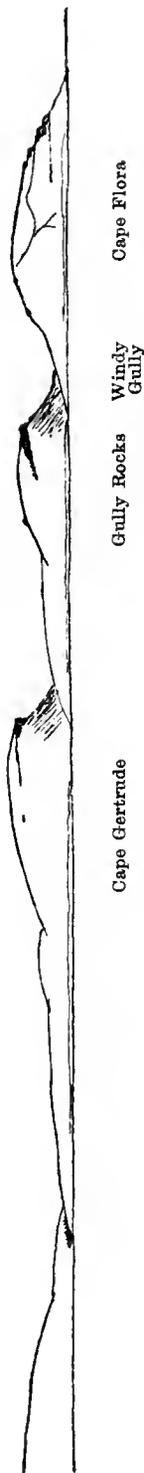

Fig. 4. Cape Flora, Gully Rocks, and Cape Gertrude, as seen from near Windward Island, 6 miles to the north. From a sketch by Dr. Kœttlitz, March 28th, 1897.

Fig. 1 is a rough diagrammatic sketch of Cape Flora, based principally on Mr. JACKSON'S map of Franz Josef Land, Dr. KœTTLITZ'S sketch of Gully Rocks (l. c. p. 624), and on an excellent and elaborate geological map of the south coast of the cape by Lieut. ARMITAGE and Dr. KœTTLITZ of the Jackson-Harmsworth Expedition, which the latter has had the great kindness to send me with permission to use it. My photographs have also helped to make the sketch correct. The north coast is principally done from memory. This part of the sketch cannot therefore claim to approach correctness, but may perhaps, in spite of this, be an aid to the verbal description¹.

Figs. 2 and 3 are two views of the cape seen from the south and the south-west. Fig. 4 is a sketch of the cape and the hills to the east seen from the north. It is made from a sketch by Dr. KœTTLITZ.

By the aid of these figures and the map, it will probably be easy to form a fairly correct idea of the topographical conditions of the place.

Like most parts of Franz Josef Land, Cape Flora has the character of a plateau. It is a flat-topped hill, capped with a considerable sheet of basalt which in most places is nearly horizontal.

There is a striking difference between the southern and northern sides of this hill. While it is highest in its southern part, and the face here is steep, with exposed, partly vertical cliffs above, and a steep talus below (see figs. 2 and 3), the hill slopes more or less gently down to the sea towards the north and north-west,

¹ I sent a copy of this diagrammatic sketch to Dr. Kœttlitz just as these pages went to press. I have received the copy back with his corrections and remarks, which he has kindly made as exactly as he could from memory, being away from home on an expedition in Abyssinia. His suggestions have been introduced in fig. 1, and I wish here to express to him my gratitude for his pains-taking interest, shown even when he was engaged in a new expedition.

and is here almost entirely covered with ice and snow (see fig. 4). This glacial covering extends over the whole of its central and northern part (see fig. 1), leaving the rocks uncovered only along the south-eastern, southern, and south-western margins of the cape, and also more or less isolated rocks (nunataks) protruding through the ice-sheet.

On these southern sides, the glacier ends at or near the upper edge of the basaltic cliffs, at an altitude of from 300 to 340 metres (1000 to 1100 feet). From this edge, the surface of the glacier rises inwards towards the summit of the hill, arching in a regularly shaped dome over the highest plateau of the basaltic cliffs. From the summit of this dome, the glacier slopes more or less gently in a north-westerly and northerly direction to the shore, the gradients being, according to Kœttlitz, from 5° to 16°.

The fact that the northern side of Cape Flora, like that of the nearest hills farther east, is lower than the southern, may perhaps to some extent be explained by a possible dip of the basaltic beds in a northerly direction, which may have been caused by dislocations (see later).

On the south-western, southern, and south-eastern faces of the hill, the basalt cap ends abruptly in steep walls, and is 150 to 165 metres (500—540 feet) thick. On the southern face near Elmwood it is composed of 6 or 7 successive tiers, placed nearly horizontally, perhaps with a very slight northerly dip for some distance, which may be seen in fig. 3¹. The number of tiers is less to the north-west, as the uppermost ones gradually disappear in this direction, in several shallow terraces, sloping gently one below another. The height of the basalt, therefore, is lower here. One kilometre ($\frac{1}{2}$ mile) northwest of Elmwood (at fig. 1, *k*; and fig. 3, *k*.) there are, according to Kœttlitz, not more than 3 or 4 tiers, and the upper edge of the basalt is about 900 feet (275 m.) above the sea. If this is right, it indicates a slight dip of the basalt tiers in this direction, for above Elmwood, the height of the third tier from below is 950 feet (290 m.) above sea-level, according to my photographs, and that of the fourth tier is 1000 feet (300 m.).

The tiers can be seen even at a distance, having well marked lines between them, their faces rising one above another, in nearly vertical

¹ A little farther east, at Cape Gertrude, and also at Gully Rocks, the northerly dip of the basalt layers is more conspicuous (see later).

cliffs in the form of steps or terraces, which each have a short steep talus descending on to the one below. These terraces are intersected by small watercourses coming from the ice-covering above (cf. figs.)¹. The same tier may vary in thickness at different places. The second tier from below is the thickest, being, according to my photographs, from 45 to 60 metres (150—200 feet) on the southern face of the hill, probably becoming somewhat thinner for some distance towards the northwest (cf. fig. 3). The others are from 10 to 30 metres (35—100 feet). The upper tiers are, on the whole, of smaller proportions as compared with the lower. Whether the tiers, especially the thicker ones, are composed of several flows of basalt, I cannot say decisively, but I regard it as highly probable.

The highest point reached by the basalt on Cape Flora is 338 metres (1111 feet) above the sea, according to the measurements of the Jackson-Harmsworth Expedition, and the lower edge of the basalt cap, on the south-western side of the promontory, above Elmwood, is about 175 metres (575 feet) above sea-level.

Below these basaltic terraces is the *talus*, which slopes downward from the base of the basalt (about 175 metres above sea-level), at first at a very steep angle, 35°—40°, then gradually more easily, and at last descending gently on to the nearly horizontal raised beaches near the shore (see figs. 2 and 3). The surface of the talus is „composed almost entirely of basaltic débris, and is traversed by the watercourses streaming down from the rocks above.“ (see fig. 3). The basaltic débris almost completely hides the strata forming the floor of the basalt, making it extremely difficult to examine them, as they are only exposed in some few places, more especially along the watercourses. Fortunately, however, such places were found at various heights, and they proved that the whole formation underlying the basalt, from a height of about 175 metres (575 feet) down to the sea, is composed of *Jurassic strata*, chiefly soft clay or sandy clay, in which numerous large and small hard nodules of clay-sandstone, argillaceous limestone, marl, etc. are embedded, especially in certain horizons.

Below the talus, between it and the sea, there was, as a rule, a succession of comparatively recent, well-marked terraces or raised beaches; the

¹ Cf. Kœttlitz's description, l. c. p. 621.

heights of the most prominent ones were: 2·7, 9—10·6, 12·5—14·9, and 23·5—24·4 metres (9, 30—35, 41—49, and 77—80 feet) above sea-level.

Elmwood is situated on a well-marked beach of this description, from 12·5 to 15·1 m. (41—49½ feet) high. The bottom of Windy Gully has a similar succession of terraces at heights of 2·7, 9·1—10, and 14 metres (9, 30—33, 46 feet). The bottom of the valley at the highest place was 16·8 m. (55 feet) above sea-level. As we thus find these most prominent beaches at the same level on both sides of Cape Flora, it is probable that the upheaval of this hill in recent times has been the same on all sides.

These raised beaches are in most places covered with a layer, generally one or two feet thick or even more, composed to a great extent of rounded and water-worn boulders and pebbles of basalt, of all sizes. Under this layer the stratified clay on sandy clay deposits, with nodules of sandstone, etc. embedded in it, were found. These beaches, or old shore-lines, must therefore to a great extent have been washed, and cut out by the sea in the soft Jurassic clay or sand, and have been covered by stones falling from the basalt cliffs above. These stones have been washed and worn by the swell near the shore, and they now protect the soft clay and sand underneath.

The order of succession of the geological formations on the southern face of Cape Flora, commencing from the summit, will be as follows:

370 m. (1200 feet)	
to	<i>snow</i> and <i>ice</i> ;
340 " (1100 ")	
340 " (1100 ")	<i>basalt</i> , composed of 6 or 7 tiers, between which thin strata,
to	some with plant-remains, are intercalated;
175 " (575 ")	
175 " (575 ")	soft <i>Jurassic strata</i> , chiefly soft clay or sandy clay, in
to	which hard stone nodules (clay, clay-sandstone, argillaceous
0 (0)) limestone, marl etc.) are embedded.

The Jurassic Strata of Cape Flora.

Wherever I had an opportunity of examining the Jurassic strata underlying the basalt, they were composed principally of a *bluish grey or brownish grey, soft and tenacious clay*, or sandy clay (and in one place of clayey sand). The clay was of about the same softness as the clay deposits on the

bottom of our fjords, or the clay used in our brick manufactories, but less pure, being more sandy. Whether this soft consistency is the real one prevailing all through the strata, or only exists near the surface, where it is caused by moisture, frost, thaw and weathering, I cannot say decisively. But down to whatever depth we were able to dig, I found the same softness, only that everywhere the strata were frozen from a short distance below the surface, which made digging more difficult. In one place, in the bank near shore, just south of Elmwood, Kœttlitz tried for a long time to dig very deep by suspending his work at intervals, during which he allowed the sun to thaw the freshly exposed frozen strata. Here, however, he found nothing but soft clayey sand, containing some few pebbles, and interstratified with thin, black, bituminous or carboniferous, sandy strata.

Where I had an opportunity of examining the clay deposits more closely, I found, as a rule, numerous concretionary nodules of hard stone embedded in them. These nodules had generally a rounded lentoid or spheroidal shape, and varied in size from some two feet in diameter to very small ones. They were, as a rule, ferruginous, and having been exposed a little to weathering, they had a yellow-brown or rust-brown crust. Pompeckj has divided these hard stone-nodules into 7 types, according to the material of which they are composed. (See his description, chap. II).

Upon looking at a view of Cape Flora, it may seem strange that the heavy weight of the 150 m. thick basalt cap does not squeeze the soft clay beds underneath out to all sides, and that the basalt does not thus sink down to sea-level. This would probably also happen to some extent, if the temperature in the interior of the clay-beds were to rise above freezing-point. They would then no longer be able to form such steep talus slopes (of 35° — 40°) as they do at present, and would slowly ooze out under the weight of the masses above. By being frozen all through they have acquired the consistency of hard rock. This condition, however, would be very essentially altered if the climate of Franz Josef Land were to become a more genial one than it is at present; and the shape and height of Cape Flora hill might then, with comparative suddenness, be entirely altered.

The Jurassic strata underlying the basalt at Cape Flora are very rich in fossils. These are sometimes lying free, embedded in the soft clay, but are more generally enclosed in the hard argillaceous stone nodules.

Comparatively few fossils were actually found *in situ*. Many more were found lying loose on the surface of the clay exposures, evidently weathered, or washed out of the clay near the place where they were lying. They could not, at any rate, have been carried very far.

A good many fossils, however, mostly enclosed in fragments of the stone nodules, were found lying loose on the talus at all heights, from the base upwards, and scattered among the basaltic débris. These fossils had evidently fallen from above, or had been carried down by water, or avalanches from some place higher up, where they had originally been washed out of the clay. They were found especially at, or near the water-courses.

Beginning from below, I will mention the principal localities where exposures of the Jurassic strata were examined, or where fossils were found.

1. *Lowest horizon* 7—10 metres (23—33 feet) above sea level. Fig. 1, *a, b*.

- (a) Along the bank of the raised beach upon which Elmwood is situated the stratified deposits are exposed from sea-level to 12 or 15 metres (40 or 50 feet) above it, and from a place a few hundred metres south-east of Elmwood, to more than that distance north-west of it. Some 300 metres north-west of Elmwood, there was a narrow ravine or gully, cut by a watercourse into these strata (fig. 1, *a*; fig. 3, *a*). The sides of this ravine had just been thawed out when I examined the place on August 2nd, 1896. In the bank on its northern side, and just above the shore, between 7 and 10 metres (23 and 33 feet) above sea-level, I found various fossils, all of which were *in situ*.

In my diary, there is the following entry on the subject of this find:

„Sunday, August 2nd, 1896. Collected some shells and belemnites in the clay deposits about 30—40 feet (?) above the shore. Knocked off several pieces of stone with impressions of shells from two nodules of „clay-stone“¹ (with rounded edges), which were embedded in the clay.“

I may add to this description that some of the fossils, shells and belemnites, were lying on the surface, half embedded in the clay, or protruding from it, the surface having been comparatively recently exposed; for it was evident that small landslips would be constantly falling into

¹ According to Pompeckj's description, it is „hard, gray or dark gray, finely grained, sandy marl“ (see below chap II).

the water-course, thus causing fresh exposures. Some too, were dug out of the clay, and they were consequently all of them found *in situ*. These fossils were embedded free in the clay, and were very fragile, especially a large lamellibranch which I at first thought was a *Pecten*, but which appears to be an *Avicula (Pseudomonotis)* (see Pompeckj later). Some valves of this genus were found fairly entire in the clay, but no sooner were they dug out than they fell to pieces, and were extremely difficult to preserve¹. The two nodules of marl, containing fossils, were also found *in situ*, and were dug out of the clay. They were a foot or more in diameter, and were not so lentoid or rounded as the nodules found at higher horizons in the strata, but had rounded edges. I did not find any other nodules embedded in the clay in this place. This locality was also visited by Dr. Kœttlitz, and some fossils from it are described by Newton².

(b) In the same bank above the shore, from 0 to 13.7 metres (45 feet, above sea-level, and only some 400 metres to the south-east (just south of Elmwood, fig. 1, *b*; fig. 2, *b*), it might naturally be expected that the deposits exposed would be exactly similar. These beds, however, show a striking difference; they have a much more distinctly stratified appearance, and are considerably more sandy in their composition. They are composed of sand, or clayey sand, and partly pebbles, interstratified with thin, black, carboniferous, to some extent sandy bands, generally less than half an inch thick, and sometimes containing small carbonized remains of wood. No fossils were found in these strata, although Dr. Kœttlitz dug into them for some distance (see above p. 10).

These strata (b) are evidently estuarine (or fresh water) deposits, or are at any rate deposited in quite shallow sea, and probably belong to a lower horizon than the clay beds with fossils, just described, only some 400 or 500 metres farther to the north-west. There may have been a slight dislocation, bringing these strata to a somewhat lower level to the north.

¹ They had a white coating, which, according to Pompeckj, is composed of crystals of gypsum.

² L. c. 1897, pp. 501–502; and 1898, p. 650. Kœttlitz's description, l. c. (1898), p. 637, may give the impression that these lowest strata with marine fossils „were traced for some distance both eastward and westward from Elmwood;“ but this has certainly not been his opinion, as they have only been found north-west of Elmwood, and are distinctly different from the strata (b) found south or south-east of this place.

Information which Dr. Kœttlitz gives me in a letter, seems to confirm this view. He says:

„In one place, close to Leigh Smith's hut at Cape Flora¹, I found a small exposure running NW in the raised beach bank, and there I found that the strata had a decidedly greater dip towards the NNW than toward the NNE. I found it to be from 5° to 6° in the first direction — but this is the only place where I found an opportunity to take the dip on that side.“ If we assume a universal dip of these strata, of as much as 5° to the NNW, this would carry a layer about 8 metres lower for every 100 metres towards the NNW; and a layer which, in the bank south of Elmwood, is 15 m. above the sea, would thus, only 400 metres farther to the NNW, be about 17 m. below sea level.

2. *Medium horizon*, 113 to 137 metres (370—450 feet) above the sea (and probably about 37 metres (120 feet) below the base of the basalt(?)).

Fig. 1, c; fig. 2, c.

One day in the beginning of July 1896, Dr. Kœttlitz took some of his comrades and myself to what he calls „a shoulder of rock“, which projects from the cliff at Windy Gully, and whose height I estimated to be 400 feet (122 m.) above the sea. According to later measurements by Kœttlitz, it is from 370 to 450 feet (113—137 m.)². This locality is situated at the southern end of Windy Gully, on its western side, some two and a half kilometres north-east of Elmwood. The fossils collected on that occasion have been described by Newton and Teall³.

On an excursion through Windy Gully July 14th 1896, I also came to the same place, and found a few fossils which have been submitted to Pompeckj (see his description). I find the following remark about the locality in my diary for that day: „It is a ridge or shoulder of clay (or sandy clay), cut through by a watercourse, and showing horizontal stratification. The height is about 400 feet above sea-level. The surface of the ridge is strewn with fragments of reddish brown „clay-sandstone“⁴. Found a good ammonite and some other doubtful fossils“.

¹ This was some few hundred paces south-east of Elmwood.

² L. c. 1898, p. 638.

³ L. c. 1897, p. 500. See also l. c. 1898, pp. 649—650.

⁴ These stones, according to Pompeckj, are „hard phosphoritic clay nodules, and yellow, or gray and greenish, hard, calcareous, sandy stone marl“ (see chap II).

Koettlitz says that the strata dip from 1° to 3° towards the NNE.

Some fossils collected on the first occasion and described by Teall and Newton were actually found *in situ*, and were dug out of the clay in the freshly exposed surface of the bank above the water-course. Some of these fossils (some of them guards of belemnites?) were, however, so fragile and brittle, that they almost fell to pieces when they were touched, and they could therefore hardly stand transportation.

A good many more fossils were found on the surface of the ridge only a few feet above the place or bank, where the first-mentioned were dug out. Some were lying loose on the surface, others enclosed in the numerous fragments of stone-nodules found there. The fossils brought back by me from this locality, were all found thus. These fossils and stone-nodules had evidently been weathered or washed out of the clay-beds, on the surface of which they were now lying, or at some place just above, and could not have been carried very far; they had perhaps for the most part originally been embedded at a somewhat higher level than the spot where they were now found. No stone-nodules were, as far as I remember, actually found *in situ* on digging in to the clay. The reason of this may be that they come from strata situated a little higher than the fresh exposure where I had an opportunity of digging. Judging from their quantity, however, they must be fairly numerous in the clay.

3. *Upper horizon*, about 150 to 165 metres (500—550 feet) above sea level, and near the base of the basalt. Fig. 1, *d*; fig. 3, *d*.

On July 16th, 1896, Dr. Koettlitz and I visited a place at the top of the talus behind Elmwood, and just below the base of the basalt¹. At this place, — I say in my diary — „I was for the first time fully convinced that the beds of clay (and sand), with fossils and nodules of clay-sandstone, etc. („mudstone-nodules“), found at Cape Flora, are really in place, and form a deposit at least 500—600 feet thick (not reckoning what is below sea level), underlying the basalt“.

Under the base of the basalt, the lower part of which was quite rotten

¹ See Newton and Teall, l. c. 1897, p. 496.

and crumbling, there was a horizontal bed of clay 3 feet thick. In this bed I found no fossils and no hard stone-nodules¹.

Under it there was an apparently almost horizontal layer of amygdaloidal basalt (of lava-structure), 6 feet thick. This basalt bed could only be traced for a short distance — I should say some twenty metres — across the exposure, as it was completely hidden by the débris of the talus on both sides. It did not give the impression of being intrusive, and this especially on account of its amygdaloidal, lava-like structure; moreover there was absolutely no indication of any alteration by heat, nor was any ordinary contact-metamorphosis to be detected in the clay strata, either underneath or above this basalt bed. It is also improbable that an intrusive mass would be able to extend itself in such a thin and regular horizontal layer in soft clay. Intrusive masses extending themselves in soft rocks generally take very irregular shapes even in much harder strata than this clay (e. g. in the alum-schists of Christiania). Judging from its structure under the microscope, Prof. Brøgger concludes that this basalt is probably not intrusive.

Below this basalt, the clay-beds again occurred, and I believe they occupy without interruption the entire height between this horizon and the sea-level. In these clay beds, and only some short distance below the lowest basalt bed, we found, *in situ* and embedded in the clay, both fossils and rounded stone-nodules², in which also fossils occurred. A good many more loose fossils, as well as stone-nodules, with fossils in them, were found just below, lying loose in a water-course that intersected these strata. They had evidently been washed by the water out of the strata above, where fossils and stone-nodules were found *in situ*. They were also of the same kind, but many of course belong to somewhat different horizons.

It is this place which Kœttlitz describes as follows: „Directly behind the settlement of Elmwood, and within about 50 feet of the basalt, clay-beds with

¹ Attention may here be called to the fact that only $\frac{1}{4}$ mile (English) north-west of this point, Kœttlitz found a piece of *Ammonites Lamberti* embedded in the lower part of the decomposed basalt (l. c. 1893, p. 638; see also Newton and Teall l. c. 1893, p. 649) immediately overlying the clay bed which is probably of exactly the same horizon.

² According to Pompeckj, these nodules consist partly of *clay-sandstone* partly of *grey-blue, grey or yellow calcareous clay*, in hard (partly concretionary) pieces, etc. (see below chap. II). It should be understood that these pieces are all of them only fragments of originally rounded nodules.

mudstone-bands are exposed, and at this spot I found in place the small ammonite which Mr. Newton thinks is in all probability *Ammonites Tchefkini*¹. Kœttlitz probably also refers to the same place when he says: „Layers of hard, grey, ferruginous mudstone-nodules occur in the shales, and sometimes form bands as much as 2 feet thick“¹. It ought to be remembered that the word „shales“ here means quite soft clay or sandy clay. I am not quite certain that Kœttlitz is right when he says 50 feet below the basalt. The fossils and nodules lying loose along the water-course were certainly found as low as that, or even lower, but it seems to me doubtful whether this was the case with the fossils found *in situ*.

4. *Fossils lying loose on the talus.* Fig. 1, e.

As being originally derived from a doubtful height possibly from this same locality or somewhat lower, I may here mention some fossils (ammonites) found on July 10th, 1896 below this place, at a height of about 30 metres (100 feet) above the sea. They were found in fragments of stone-nodules², which lay scattered loose amongst the basaltic débris on the talus, and had evidently come from some higher level. Pieces of marly limestone, with cone-in-cone structure, were also found in the same place.

5. *Strata immediately below the basalt.* Fig. 1, f, f; fig. 2, f.

On July 24th, 1896, Dr. Kœttlitz and I visited the top of the talus (575 feet above the sea), a little east of Elmwood, above Sharp's Rock (a loose basaltic rock lying on the raised beach).

We here found the clay deposits exposed *in situ* just below the base of the basalt, and could examine their contact with the latter. No fossils were found at this spot. The clay deposits showed distinct stratification, and specimens of the various strata were taken, but no appreciable alteration by contact with the basalt could be detected. Newton and Teall have given the following description of these strata in descending order:

„(1) Black shale 4 inches thick, from just below the basalt. There is no appearance of this shale having been heated to any extent by contact with the basalt.

¹ L. c. 1898, p. 637. See also Newton and Teall, l. c. 1897, p. 496; and 1898, p. 649.

² They were composed of *calcareous clay* or *calcareous*, partly sandy, *stone-marl*. See Pompeckj, chap. II.

- „(2) Black material like the preceding, but broken into fine particles and powder, 1 1/2 inch thick.
- „(3) Greenish-grey shale, 3 inches thick.
- „(4) A lighter-coloured brownish clay-shale, the thickness of which is not recorded“.

I may add to this description that the „black shale 4 inches thick“ (1), immediately below and in contact with the basalt, was more solid and harder than the ordinary soft, tenacious clay underlying it. It had evidently been somewhat hardened by the basalt. I brought home some pieces of this shale with adhering pieces of the basalt, showing the contact between them. These pieces have been examined by Prof. Brøgger, and he has not been able to find any indication of a regular contact-metamorphosis in the shale. This appears to be a decisive proof that the basalt cannot be intrusive.

The two thin layers (1 1/2 inch and 3 inches) below this shale were not much harder than the ordinary clay, but were not so tenacious, and differed somewhat in colour, being darker.

The thickness of the fourth layer, the „lighter-coloured brownish-shale“, cannot be stated, as we found no difference in appearance between this layer and the underlying soft, tenacious clay which forms the chief component of the Jurassic deposits of Cape Flora.

6. *Doubtful horizon. Fig. 1, g, and h; fig. 3, h.*

In my diary for Sunday, July 12th 1896, I find the following entry: „Made, together with Dr. Kœttlitz, Johansen and Armitage, a good collection of belemnites, ammonites, etc. in a moraine(?) at the margin of the glacier west“ (should be north-west) „of Elmwood (about 1 1/2 kilometres distant), 30 to 60 metres (100 to 200 feet) above sea-level. The belemnites and some ammonites were found chiefly in one small area by a water-course, just at the margin of the glacier. They were lying loose on the surface of clayey mud, probably pushed out from under the glacier(?). The slope of the latter was not steep, so that the fossils could not have fallen down from above, and could hardly, in my opinion, have been *in situ* much higher than they were found, which was about 200 feet above the sea. In the same place, I also found a short piece of a *Pentacrinus*-stem. Some fragments of belemnites and ammonites were lying loose on a bare rock, protruding through the glacier

some 30 paces within its margin. On one spot, somewhat lower in the same moraine(?) or talus, the ground for some distance was completely overstrewn with large and small pieces of marly limestone with cone-in-cone structure, such as occur in great quantities in several places on Cape Flora. I have, as a rule, found this cone-in-cone limestone less than 100 feet above the sea, and hardly ever higher than 150 feet. Where it occurs, there are generally great quantities of loose fragments of it, strewn about on the surface of the talus or raised beaches; and only very rarely are fossils found amongst these loose-lying fragments, or in their immediate neighbourhood. Kœttlitz tells me, however, that he has found single ammonites on a spot where numerous pieces of this limestone occurred. On the spot mentioned above (in the „moraine“) we could easily have taken away sledge-loads of this stone with cone-in-cone structure“.

„Below a basalt-rock some short distance south-east of this glacier, there was a gently-sloping clay plain, which was covered with scattered pieces of „clay-sandstone“¹ amongst which ammonites and belemnites were found. This plain was hardly more than 80—120 feet above sea-level“.

Thus far my diary. The words „glacier“ and „moraine“, in this description, are perhaps somewhat misleading, as the latter was probably only the ordinary talus, partly covered with heaps of the basaltic débris, and the „glacier“ was simply the extensive sheet of snow and ice covering the ground, often to a considerable depth, and which had not melted beyond this spot that summer. But in a recent letter, Dr. Kœttlitz says that in the summer of 1897, there was „such an exceptional thaw, that much more of the ice and snow was cleared off the surface than usual everywhere, so that here those places which you describe in your diary as „a moraine at the margin of the glacier“, were quite 100 yards away from its margin that summer. This place, I should say, is at least 150 feet above the sea.“

It will be understood that this „glacier“ or covering of ice and snow is stationary, and thus cannot at present carry any moraine material of importance, either on its surface or underneath it, and the expression „pushed out

¹ This is only an expression used for shortness in my diary. The stones were for the most part composed of calcareous concretionary clay, or phosphoric and calcareous clay. There was only very little clay-sandstone. See Pompeckj, chap. II.

from under the glacier“ may be misleading. As the slope of the ground, or the snow („glacier“), was so gentle above the place where the fossils were found, it is hardly probable that the latter could have fallen or rolled from above at any recent date. And as they could hardly have been lying on the surface, as they were, for very long, there is a probability that the fossils found „at the margin of the glacier“, and on „the clay plain“, had not been removed very far from the place where they had originally been *in situ*, and where they had been washed or weathered out of the clay¹.

I wrote to Kœttlitz, and asked his opinion, and in the letter referred to above, he says; „I am strongly of opinion that the fossils we found there were weathered out of the strata immediately underneath. Since you were with us at Cape Flora, I have spent some time, and taken some trouble to investigate as thoroughly as possible this spot, and the rocks above it, and I have come to the conclusion that the cone-in-cone argillaceous limestone and the fossils we found there *do not come from above*, but are practically *in situ*, for the deeper one digs under the surface, the more of the same specimens are brought to light, and the supply is there practically inexhaustible. The only difficulty there is in getting at them is the icy condition of the rock surface“.

Presuming, therefore, that the fossils found here had been *in situ* somewhere about 60 metres (200 feet) above the present sea-level, I was rather astonished to learn from Pompeckj that some of them belonged to exactly the same horizon as those from the locality 3 (see p. 14), above Elmwood, and just below the basalt at a height of about 165 metres (550 feet) above sea-level.

If Koettlitz and I are right, there must consequently have been a dislocation of some kind here. In my diary, I mention at this place a basalt rock (see above p. 18), the base of which must be at a height of some 150

¹ However, if they really did come from an originally much higher level, the following explanation is also possible, namely, that a soft, viscous material, such as the clay of these beds, might possibly flow slowly downwards, even where the slope is comparatively gentle, especially when the clay during the summer is covered with a sheet of melting snow and ice which keeps it constantly wet instead of frozen. But whether the ground underneath the snow, or the „glacier“, above this place was composed of clay and not of basalt, I had no opportunity of investigating. I believe, however, that there are, as we shall see, reasons for assuming that the rock here is basalt.

feet (45 m.) above the sea. I did not get an opportunity of examining more closely whether this rock was actually in place, or whether it was a loose rock fallen from above, for which, however, it seemed to be too large and massive. Above this place, and at the margin of the glacier, I remember, also, to have seen basalt cliffs in place a good deal lower than they were above Elmwood, and this was my reason for suspecting that a dislocation had taken place. I asked Kœttlitz what he had to say about this point, and in the letter, already twice referred to, he says: „If you remember, the basalt here descends much lower than anywhere else in the immediate neighbourhood as far as can be seen. — — — There are several bosses of rock situated at this lower level, and these I have investigated a good deal. These basaltic masses“ (i. e. the low rock mentioned above, some 150 feet above the sea, and the other rocks somewhat higher) „are continuous with the basaltic rocks above, that is, there is no break by other strata between them; they are therefore *in situ*, and though I did not actually see the fault — for the rocks are here very lava-like, crumbling, and shattered — I am of opinion that there has been a dislocation of strata here, that the whole mass (basalt and stratified rock) has sunk considerably, and this accounts for these fossils having been found at such different horizons. And I quite agree with you that this spot so gradually sloping, almost flat, with no steep talus behind, could not have received these fossils upon it through their having fallen from above“. If this be the right explanation, I should say that either several dislocations have taken place, or the rocks have not sunk regularly, because the fossils found at the margin of the „glacier“, were lying on clay at a higher level (about 60 m. (?) above the sea) than the basaltic rock south-east of it (about 45 m. or 150 feet (?) above the sea). But there is still the difficulty left, that at this locality are found fossils both from the medium horizon 2 (p. 13), and from the upper horizon 3 (p. 14) and even from a still higher horizon (see Pompeckj later); and between these horizons there should be a difference of height of some 40 m. (120 feet) at least. We shall perhaps after all be forced to admit the possibility of some transportation by glacial action, or by some other means, even though there may be some irregularity in the height of the strata. There is also a possibility that these low basaltic rocks may be intrusive, and may have been formed simultaneously with the dislocations.

In any case I feel convinced that the strata here must be considerably lower than near Elmwood, for if the fossils found here really have been carried down in some way or other some 120 m. (400 feet), this would be a case without a parallel, as far as we know on the whole of Cape Flora, even where there is a very steep talus behind. Even though single fossils from higher horizons may be found very low on the steep talus, especially along the watercourses, they are never found in such quantities, and spread over such an area as they were here.

7. *Inter-basaltic, fossiliferous horizon* (with plant-remains). Fig. 1, *i, k, l*.

In my diary for Friday, July 17th, 1896, I find the following entry referring to my visit to the locality (fig. 1, *i*) for this horizon: „In company with Dr. Koettlitz, I visited today a basaltic rock, or nunatak, protruding through the glacier on the north-west side of Cape Flora, about 600 or 700 feet (180—210 m.) above sea-level, and where he and Mr. Jackson had found numerous fossil plants a few days ago.

„A quantity of fragments of shale were here lying spread over the surface within two small, distinctly defined areas. Nearly every fragment showed impressions of pine-needles (chiefly) and less frequently ginkgo, fern and other leaves.

„These fragments formed a layer one or two feet thick, only a few feet broad, and perhaps 12 or 15 feet long, passing across the basalt ridge, which was bounded on both sides by the glacier; but the layer ended, as far as we could make out, before it reached the glacier on either side (the surface of the glacier was lower than that of the basalt ridge).

„It was my opinion that the existence of this shale here could only be explained by its being a fragment of an originally lower bed, and having been broken off by the formation of a dyke, and thus enclosed in the basalt. I could not, however, detect any unquestionable alteration by heat, though possibly some small amount in fragments from the deepest part of the layer¹. Here the fragments were larger and fitted together, evidently *in situ*

¹ This was evidently a mistake, arising from the difference of colour, which, however, was not caused by heat. The shale from the deeper parts was darker blue-grey or brownish grey, simply because it had not been exposed to weathering like the fragments on the surface, which had turned a pale yellow.

and exactly in the same position in which they were left by the shattering of the shale by the frost. Immediately beside this layer of shale-fragments, the upper ends of well-developed, vertical basaltic columns, hexagonal or quadrangular, were seen. The basalt under the shale seemed to be less solid, more resembling tufa. In a protruding rock, a little farther down the glacier, the basalt was of the same rotten structure. Well-developed vesicles and amygdaloids, partly filled with minerals, were plentiful. Oblong vesicles, filled with a white mineral (calcite?), were especially conspicuous; their long axis lay in a south-south-westerly direction, as far as could be made out in the fog, and without a compass. Nodules of shale were also found enclosed in the basalt; they had evidently been altered by heat.

„The other place where fragments with plant-impressions were found, was close by the first-mentioned spot, on the same rock (a foot or two higher); but it was of smaller extent and less significance, the fragments being few and scattered“.

The whole gave us the impression that what we had found in these two places were the last remains of a bed, which Koettlitz had come just in time to secure. These parts of the shale had been lying in two depressions in the basalt bed, and had thus escaped denudation a little longer than the rest; but in the highest, and consequently most exposed place, the shale was now nearly gone.

I say in my diary that the altitude of the place was about 600 or 700 feet (180—210 m.) above sea-level. Unfortunately we never got an opportunity of making an exact measurement. I see that Koettlitz states the height to be „some 750 feet“ (l. c. p. 638). I do not know whether the exact height was ever measured after I left Cape Flora, but if not, I still feel inclined to believe that it was not so much, and that my estimation is nearer the truth; and I should even say that it comes nearer 600 feet than 700. But at the same time, I believe the basalt goes much lower in this place, than near Elmwood (cf. above p. 20).

These plant-remains have been investigated by Prof. A. G. NATHORST, who will describe them in the next paper in this series¹. It will there be

¹ See also Nathorst's description in Nansen, „Fram over Polhavet“, Kristiania, 1897, vol. II, pp. 519—521; and „Farthest North“, vol. II, pp. 484—487.

seen that he holds the opinion that they are *Upper Jurassic* or *Lower Cretaceous* or belonging to the transition beds between the *Jurassic* and *Cretaceous* Systems and it will be seen from Pompeckj's paper that there is probably no great interval in time between the Jurassic horizon to which they belong, and that of the upper clay beds just below the basalt.

If this shale with plant-remains in it was actually *in situ*, that is, as it was originally deposited, and not broken up and lifted by intrusive basalt, it would give us a clue to the age of the basalt; the latter would then to some extent also be Upper Jurassic or Lower Cretaceous. I therefore expressed my opinion on this head, upon my return from the expedition¹, having arrived at the conclusion that the shale must actually have been *in situ*. My principal reason for this was that the basalt on which the shale was lying, could hardly be intrusive, judging from its structure, which more resembled that of a lava. Moreover, if this shale with plant remains had been raised by intrusive masses, it must have rested almost immediately on the top of the highest Jurassic clay beds we found near Elmwood, as it was only 30 m. (100 feet) higher at most (if there had not been dislocation at this place, cf. p. 20). But if so, it seems strange that we nowhere found any trace of similar deposits on the top of the clay.

There were also other reasons, which made me believe that the basalt was partly Jurassic, especially the basalt bed found in the clay at the top of the talus behind Elmwood (see above p. 15.), which was not of intrusive character. Then I also doubted that intrusive masses would be able to extend themselves in almost regular horizontal layers, some only a few feet thick, as mentioned above p. 15, in soft clay, such as we have to deal with here².

None of these evidences, however, were absolutely convincing, and Newton and Teall, who are so familiar with the Scottish basalts, therefore maintained, as being more reasonable, that the basalts of Franz Josef Land, like other extensive basalt-flows of the northern hemisphere, are of Tertiary origin³.

¹ Nansen. „Farthest North“ (1897), vol. II, p. 479. See also „Some Results of the Norwegian Arctic Expedition 1893–96“. Geogr. Journal, vol. IX (1897), p. 489.

Having discussed the point with Teall, I expressed myself somewhat more cautiously in the Norwegian edition of my book, which was finished more than half a year later than the English edition. See „Fram over Polhavet“, Kristiania, 1897, vol. II, pp. 515–517. See also the German edition, „In Nacht und Eis“. Neue revidirte Ausgabe. Leipzig, 1898, vol. II, pp. 486–488.

² „Fram over Polhavet“, vol. II, p. 516. „In Nacht und Eis“. Neue revid. Ausgabe. Leipzig, 1898, vol. II, p. 487.

³ L. c. 1897, pp. 490, 519.

But if this be so, it follows that the plant-bed must have been lifted by intrusive masses, and if not all, at any rate the lower horizontal tiers of the basalt at Cape Flora must be intrusive. I have already above, pp. 15 and 17, pointed out that there are almost decisive proofs that these basalt beds cannot be intrusive.

Kœttlitz and I looked in vain for similar plant-bearing deposits below or between the tiers of basalt in other places on Cape Flora. But since my departure, Kœttlitz has been fortunate enough to find what he supposes to be the same plant-bearing bed in the cliffs above Windy Gully, on the opposite side of the Cape Flora hill, (about two kilometres distant from the locality mentioned above) and about 700 feet (210 m.) above sea-level (see fig. 1, 1). Although this bed was only from 18 inches (45 cm.) to 2 feet (60 cm.) in thickness, it could be traced almost horizontally „for 500 to 600 yards between the second and third tiers of the basalt“ (counting from below)¹. If Kœttlitz's estimation of the height is correct, the second and third tiers must be lower near Windy Gully than above Elmwood, where the top of the second tier is about 880 feet above the sea. Kœttlitz tells me „that a thick layer of tufa(?) underlies this stratum, and it has all the appearance of being undisturbed“. Even though this plant-bed is probably of nearly the same age as the one visited by Kœttlitz and myself¹, I do not consider it likely that they are actually parts of the same bed, the rocks composing them seem to be too dissimilar. According to communications from Kœttlitz, the plant-bed above Windy Gully is composed of a silicious rock, which Mr. Teall describes as „brown, laminated, silicious rock“² (Si O₂ 91·4%, Al₂ O₃ and Fe₂ O₃ 3·9%; loss on ignition 2·4%). Another specimen he found to be Si O₂ 73·8, Al₂ O₃ and Fe₂ O₃ 10·7; loss on ignition 12·3%). Portions of this stratum or bed were „soft grey argillaceous rock“ which „sticks to the tongue like bauxite“. The plant-remains seem to have been found in the first-named kind of rock³, and this is evidently quite different from that of the bed from which Kœttlitz and I collected plant-fossils, this last being an argillaceous shale.

A third place where Dr. Kœttlitz tells me that he „found similar plant fossils was upon the summit of the rocks of Cape Flora cliff, upon almost

¹ See Newton and Teall, l. c. 1898, p. 649.

² L. c. 1898, p. 649.

³ Cf. Newton and Teall's description l. c. 1898, p. 649.

the highest part, about 900 feet (275 m.) or 950 feet above sea-level (see fig. 1, *k* and fig. 3, *k*). These were in fragments of brown sandy rock which Mr. Teall found to be composed of „grains of quartz, fragments showing plant structure, and a few flakes of white and brown mica“. These pieces were loose, in a slight hollow, as though caused by a runlet of water. They appeared to have been washed loose out of a bed of similar, but frozen rock underlying them“¹.

These fossils may perhaps belong to a stratum which is situated higher in the basalt than the bed before mentioned, perhaps between the third and fourth or between the fourth and fifth tiers of basalt (counting from below). Judging from Newton and Teall's description, this brown sandy rock seems to be more like that of the plant-bed on the nunatak to the north, visited by Kœttlitz and myself, though it „is somewhat coarser“, and then our shale to the north contains very little sand. That they are found at different heights may be accounted for by the possibility that there has been a dislocation just north of the place where these fossils were found; and as we know nothing as to the height above the base of the basalt, of the plant-bearing bed overlying the nunatak to the north, it may very well be that it has been situated between the same, or nearly the same tiers. The fossils from these two localities can hardly, however, belong to exactly the same horizon, as I think the distance between them (see fig. 1) is too small to account for the difference in the deposit in which they are preserved.

I quite agree with Kœttlitz when he does not consider it probable that these plant-bearing strata have been lifted by intrusive sheets in such extensive and horizontal thin beds; nor can I understand how the flows of basalt could have become so regular and horizontal, if they had been intrusive masses extending themselves in soft clay, like that of Cape Flora. A glance at the regular, horizontal basalt-beds in figs. 2 and 3 will hardly, I think, make one feel inclined *a priori* to assume such a possibility.

It would also be extremely difficult, as Kœttlitz points out, to explain how the tree-trunks and branches now carbonized or „charred into charcoal“ (also partly silicified) could have been enclosed in the basalt sheets which underlie the plant-bearing beds, if the basalt is intrusive. I think with Kœttlitz that there cannot be much doubt that these tree-trunks have chiefly belonged

¹ See also Newton and Teall, l. c. 1898, p. 648 (a).

to conifers growing on the soil over which these basalt flows were discharged during the Upper Jurassic or Lower Cretaceous Age; and they have „been charred by being overwhelmed in a surface-flowing mass of lava“. Some of this wood must, according to Kœttlitz, have been growing on the first or lowest tier of basalt¹.

A conclusive proof that at any rate the lowest tier of the basalt cannot be intrusive and consequently must be Jurassic, seems to me to be given by Teall himself, when he says that „evidence that pauses occurred during the formation of the plateau-basalt . . . is furnished by a specimen of a conglomeratic rock, mainly composed of basaltic debris, and containing rounded pebbles, found some 50 feet above lowest rock near Cape Flora“². This is on the top of the lowest tier of basalt, and this basalt, as well as the basaltic conglomerate, is consequently lower than the plant-bearing beds mentioned, and must also be older, as the basaltic conglomerate cannot be intrusive.

Moreover, it may also be remembered that neither the clay, or shale, immediately below the basalt, nor the plantbearing strata between the tiers of basalt, show any appreciable alteration by heat, or any contact-metamorphosis (see pp. 15, 17, 21).

Taken together, these facts appear to me to be conclusive, and we must assume with Dr. Kœttlitz, that these plant-bearing beds have actually been deposited, probably as lake-deposits, between the different discharges of the flows of basalt. If then, these beds are Upper Jurassic or transition beds to the Lower Cretaceous, *the greater part of the basalt is also of Upper Jurassic or Lower Cretaceous age.*

It is extremely interesting to learn that Prof. Nathorst has apparently found the same basaltic and Jurassic formations on *Kong Karl's Land* (Wiche Land) during his expedition last summer.

Nathorst tells me that he believes the basaltic beds of Kong Karls Land to be Upper Jurassic or Lower Cretaceous and that they are not intrusive. He says:

„¹⁰, the basalt forms real flows or beds, being remains of old lava streams“.

¹ Kœttlitz, Geogr. Journal, 1898, p. 134.

² Newton and Teall, l. c. 1897, p. 490.

„2^o, the basalt in some places is so intimately connected with the fossiliferous strata, that it is impossible to assume that the lava flows could have extended over these strata in the manner they have done, if they had been discharged as late as during Tertiary times“.

I have said before that the tiers of basalt at Cape Flora are possibly not quite horizontal, but dip perhaps a little towards the north. This seems to be still more the case a little farther east, in the *Gully Rocks* and on *Cape Gertrude*, which is only 3 or 4 miles (6—7 kilometres) east of Cape Flora.

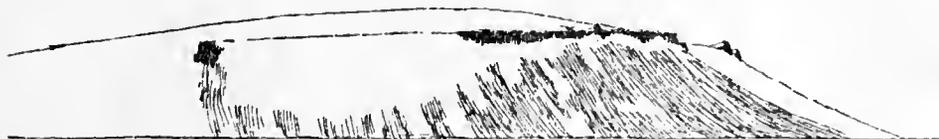

Fig. 5. *Cape Gertrude*. Drawn from a photograph by F. N.

That such is the case is indicated in a rough sketch, by Dr. Kœttlitz, of Cape Flora, Gully Rocks, and Cape Gertrude, taken from near Windward Island, 6 miles to the north (fig. 4, p. 6), which sketch he has kindly placed at my disposal together with a good many others.

Fig. 5, which is a drawing I have made from one of my photographs of Cape Gertrude, shows distinctly this dip of the basalt, and its exact dimensions.

This dip of the basalt flows may perhaps be sufficient to account for the fact that, according to Kœttlitz, the basalt reaches down to the sea, on the North side of the peninsula, at the bay (fig. 6, 6) — „the head of Günther Bay“ — north-east of Cape Gertrude¹, at the north end of the valley separating the hill of Cape Gertrude from the east part of Northbrook Island. If we assume the distance between these two places to be as much as 5 or 6 kilometres (3 miles) and the base of the basalt at Cape Gertrude to be 180 metres (600 feet) above the sea the dip found in the photograph represented in fig. 5, which is about 33 metres for every kilometre in a northerly direction, would alone be sufficient to account for this fact.

¹ See Kœttlitz, Quart. Journ. Geol. Soc., 1898, p. 635.

Farther south in this valley east of Cape Gertrude, however, (on the east side of the valley) there is „a line and ridge of detached nunataks, composed of basalt, and averaging 320 feet above sea-level“. „This line of nunataks continues through the whole of this valley, about 2 or 3 miles“¹. Possibly the low position of the basalt here, may be owing to a dislocation of some kind.

Upon the whole there is apparently not much regularity in the position of the basalt, and the height of its base above sea-level on Northbrook Island. At Cape Gertrude, according to Kœttlitz, its base is masked by the talus heaps but may be some 180 to 210 m. (600—700 feet) above sea-level. At an exposed rock (fig. 6, 3) some seven kilometres farther east along the south

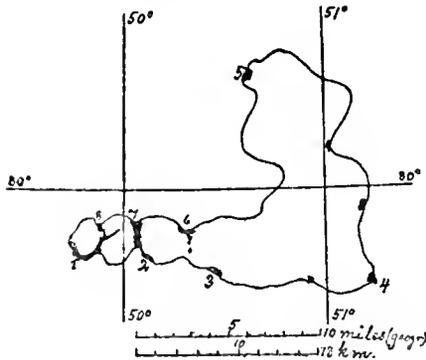

Fig. 6. *Northbrook Island, based on Mr. F. Jackson's map of Franz Josef Land.* The places where the underlying rock projects through the ice-covering are indicated in dark colour. 1 Cape Flora. 2 Cape Gertrude. 3 Cliffs east of C. Gertrude. 4 Cape Barentz. 5 Camp Point. 6 Valley east of C. Gertrude. 7 Valley east of Gully Rocks. 8 Windy Gully.

coast, (east of the valley mentioned above) there are „several bosses of basaltic rock protruding from the general talus-slope, and apparently *in situ*“¹. They are perhaps some 90 or 120 m. (300 or 400 feet) above the sea. At *Cape Barentz*, at the south-east corner of the island, and at *Camp Point*, at its northern extremity, the basalt cliffs reach the sea. In both these places, the upper edge of the basalt is only some 45 m. (150 feet) above sea-level².

The probability is that various dislocations have occurred in the neighbourhood of Northbrook Island, as elsewhere in Franz Josef Land, and that this, to some extent, is the cause of this land being broken up, as it is, into islands, with numerous sounds and fjords. But then it ought also to be remembered, that it is not *à priori* probable, that the basalt flows were poured out over

¹ Communicated by Dr. Kœttlitz.

² Kœttlitz, l. c. 1898, p. 625.

absolutely horizontal ground, and that thus the basalt flows were originally absolutely horizontal.

The Jurassic deposits of Northbrook Island beyond Cape Flora, are very little known. They have been examined almost exclusively at Cape Gertrude¹. The sedimentary beds here were investigated by Dr. Kœttlitz at various heights where they are exposed, from sea-level to 24 m. (80 feet) above, and again from 75 to 150 m. (250 to 500 feet) above. These strata differ remarkably from the strata (clay-beds) underlying the basalt at Cape Flora. „They yield *no fossils* except fossil wood and lignite, and are for the most part composed of sand in thin layers, extraordinarily variable in colour. Among the sand layers are many strata containing pebbles of quartzite, radiolarian chert, jaspis, „ironstone-nodules“, etc. „Thin strata of soft clay-shales also occur frequently. Bands of lignite, or of brown, decomposed fossil wood, an inch or two thick, are frequent. Here and there the sand-strata seem to harden locally into a very hard, calcareous, grey sandstone, in which ripple-marks were found. These sandstone masses protrude from the inclined section in great bosses²“.

The only part of the Jurassic beds at Cape Flora to which in my opinion these sediments of Cape Gertrude may correspond, is the strata of sand with black carboniferous seams (fig. 7,b) in the bank above the shore south of Elmwood (see p. 12 (b)), which are probably underlying the 150 to 175 m. (500 to 570 feet) thick clay beds containing Jurassic marine fossils. As far as we know, the horizon of these clay beds does not seem to be represented at Cape Gertrude, the sediments of which, in my opinion, may be of an earlier age, and the horizon of the highest of them the same or similar to that of the sand strata with carboniferous seams south of Elmwood³. This would imply either a fault or a dip in the lower Jurassic strata (which has also actually been observed going NNW. see p. 13.) which has been anterior to the discharges of the basalt above. The dip or fault in these deposits, which have evidently been formed in very shallow water, or to some extent perhaps in freshwater, may also very well be anterior to the deposition of the Jurassic clay beds containing numerous marine fossils, found at Cape Flora.

¹ Newton and Teall, l. c. 1897, p. 503.

² Communicated by Dr. Kœttlitz.

³ Seams of lignite, or similar strata of sand (possibly of freshwater origin) have not been found at any higher level (45 feet above the sea) or in any other locality at Cape Flora, as far as I know.

The composition of these two formations also seems to point to quite different conditions of deposition, which in my opinion makes it impossible that they should belong to the same horizon. The clay beds at Cape Flora, as far as I have seen, are, compared with these sand strata, considerably more uniform in their composition all through, from sea-level up to the base of the basalt; and the conditions of deposition, though varying, seem to have been considerably less so during their formation. They seem to have been deposited in comparatively shallow sea, and there is little indication of great oscillations of level. Not so with the sand strata south of Elmwood, and the sediments at Cape Gertrude. The extraordinary number of thin beds of diverse character in these formations points, as Newton and Teall say¹, „to rapidly varying condition of depositions, and possibly to oscillations of level, while the beds of lignite indicate, to some extent at least, a fresh-water origin“. I do not consider it possible, if the conditions of deposition varied so rapidly at Cape Gertrude, that there should be no indication of this rapid variation in the corresponding deposits at Cape Flora hardly 4 miles (7 kilometres) off; and if there have been oscillations of level, they must have occurred in both places.

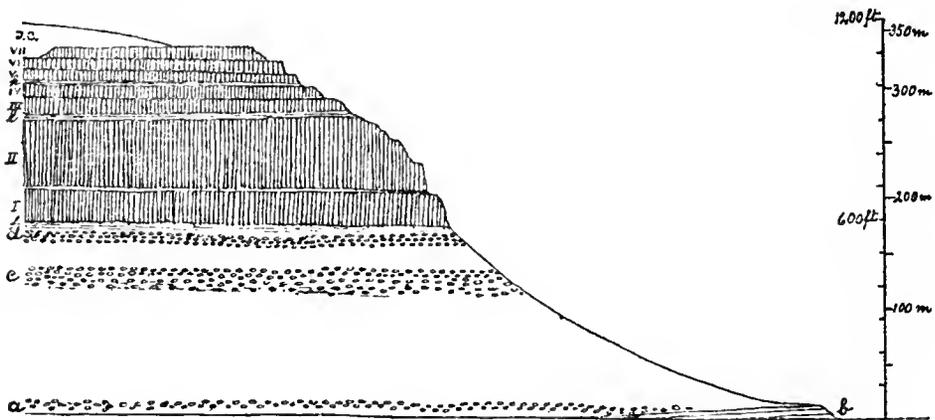

Fig 7. Diagrammatic section through the southern face of Cape Flora, illustrating the succession of geological formations. *a* Lowest fossiliferous horizon (see p. 11). *b* Thin alternating strata of sand with black carboniferous seams, probably underlying the former horizon *a* (see p. 12). *c* Medium fossiliferous horizon (see p. 13). *d* Upper fossiliferous horizon (see p. 14). *f* Strata immediately underlying the basalt (see pp. 15, 16–17). I–VII Successive tiers of basalt. *l* Plant-bearing bed between second and third tiers (see p. 24). *k* Plant-bearing bed probably between third and fourth, or between fourth and fifth tiers (see p. 25). I. C. Ice-Cap.

¹ L. c. 1897, p. 503.

According to what has been said before in this sketch, there should probably be the following succession of Jurassic sedimentary strata at Cape Flora, in descending order (cf. fig. 7):

- | | | | |
|----------------------|---|--|---|
| 280 m.
(900 feet) | A plant-bearing bed of sandstone, probably between fourth and third, or between fifth and fourth tiers of basalt (fig. 7, <i>k</i>). | | On top of Cape Flora cliffs, north of Elmwood (fig. 1, <i>k</i>), (The plant-fossils found on a nunatake farther north (fig. 1, <i>i</i>) belong perhaps to nearly the same horizon). |
| 210 m.
(700 feet) | A plant-bearing bed, principally of silicious rock, between third and second tiers of basalt (fig. 7, <i>l</i>). | | In the cliffs above Windy Gully (fig. 1, <i>l</i>). |
| 200 m.
(660 feet) | In the soil on top of the first or lowest tier of basalt, a Jurassic forest has been growing, branches and trunks of which have been found, in a carbonized or charred condition, enclosed in the second tier of basalt (fig. 7, between I and II). | | On the south face of Cape Flora cliffs. |
| 175 m.
(575 feet) | Base of the basalt. | A specimen of <i>Ammonites Lamberti</i> (Newton) was found (by Kœttilitz) enclosed in the basalt. | Above Elmwood (near fig. 1 <i>d</i>). |
| 175 m.
(575 feet) | Black shale 4 inches (in contact with the basalt and somewhat hardened).
Black shale 1½ inch (not so much hardened).
Greenish grey shale 3 inches (not so much hardened).
A lighter coloured brownish soft clay, the depth of which was masked by the talus heaps (fig. 7, <i>f</i>). | No fossils found. | East of Elmwood (fig. 1, <i>f, f</i>). |
| 175 m.
(575 feet) | Soft clay 3 feet thick, immediately below the basalt (fig. 7, <i>f</i>); and under this clay a bed of basalt with lava-like structure, 6 feet thick. | No fossils found, but <i>Quenstedtoceras</i> (see Pompeckj) and <i>Amm. Lamberti</i> possibly originate somewhere near this horizon. | Above Elmwood (fig. 1, <i>d</i>). |
| 168 m.
(550 feet) | Soft clay beds of great thickness, with bands of nodules of clay-sandstone (fig. 7, <i>d</i>). | Fossils found <i>in situ</i> , described by Newton as <i>Amm. (Cadoc.) Tshefkini</i> etc., see Pompeckj's descriptions later. | Above Elmwood (fig. 1, <i>d</i>). |

- | | | | |
|-------------------------|---|---|--|
| 137 m.
(450 feet) | Soft stratified clay with bands of concretionary nodules of hard, very calcareous, (to some extent sandy) stone- | Fossils found <i>in situ</i> , described by Newton as <i>Amm. Ismae</i> var. <i>arcticus</i> , see Pompeckj later. | South end of Windy Gully (fig. 1, c). |
| 113 m.
(370 feet) | marl and hard phosphatic and calcareous clay (fig. 7, c). | | |
| ? m.
(? feet) | Marly limestone with cone-in-cone structure. Not found <i>in situ</i> , but may probably come in somewhere here (if not above the last horizon). | | Found loose on the talus in various places round Cape Flora. |
| 10 m.
(33 feet) | Soft clay with nodules of sandy marl (fig. 7, a). | Fossils found <i>in situ</i> . <i>Pseudomonotis</i> , <i>Lingula</i> , <i>Discinea</i> , <i>Ostrea</i> , <i>Belemnites</i> , see Pompeckj's descriptions later. | Some 300 m. north of Elmwood (fig. 1, a). |
| to
7 m.
(23 feet) | | | |
| 14 m.
(45 feet) | Thin alternating strata of sand of varying colours (with pebbles), interstratified with thin black carboniferous seams. Probably underlying the horizon above, and possibly corresponding to the upper sedimentary strata at Cape Gertrude (?) (fig. 7, b). | No fossils found except carbonized wood. | About 100 m. south of Elmwood (fig. 1, b). |
| to
0 m.
(0 feet) | | | |

Lysaker, *December*, 1898.

FRIDTJOF NANSEN.

THE JURASSIC FAUNA OF CAPE FLORA.



PREFACE.

During his stay on Northbrook Island in the Franz Josef Land Archipelago — from June 17th until August 7th 1896 — Professor Fridtjof Nansen collected a large number of rocks and fossils. Part of this collection comprising Jurassic marine fossils, was submitted to me for examination. The results of the investigation of this valuable material are described in the following pages.

MUNICH, *September* 1898.

J. F. POMPECKJ.



I.

PREVIOUS LITERATURE REFERRING TO THE JURA OF FRANZ JOSEF LAND.

From what we know at present about the geology of the arctic archipelago, known by the name of Franz Josef Land, strata of Jurassic age have only been observed in the southern parts of these islands.

On Northbrook Island, at least on its narrow southwestern peninsula, Jurassic deposits have a considerable share in the geological structure of the country. Owing to the researches and collections of the Jackson-Harmsworth Expedition and Prof. Nansen, this part of Northbrook Island may be considered the best known district of the Franz Josef Land Archipelago with regard to its geological structure. Except on Northbrook Island, Jurassic strata have probably only been found in the neighbourhood of *Eira Harbour*, situated between Mabel and Bell Islands. In other more westerly and easterly parts of the archipelago, the occurrence of Jurassic strata is not yet proved with certainty.

The following examination of the publications referring to the Jura of Franz Josef Land shows that the successful expeditions of recent years have contributed very considerably to the extension of our knowledge of the geology of this archipelago.

1876 (1873). It cannot be positively ascertained whether *Julius Payer*, the discoverer of Franz Josef Land, found Jurassic sediments in the south-eastern and eastern parts of the archipelago, which were visited by him. Payer uses the following expressions¹ concerning the sedimentary rocks which he found on Franz Josef Land:

¹ J. Payer, 'Die Oesterreichisch-ungarische Nordpol Expedition in den Jahren 1872—1874'. Wien 1876, p. 268.
English edition, 'New Lands within the Arctic Circle'. London 1876, vol. II, p. 82.

Whitish sandstone with small grains of quartz, and a white clayey cement, — pale gray, very finely grained sandstone — yellowish gray, finely laminated clay slate, with numerous small scales of white mica and small lignitic particles with plant-structure, — sandstone containing lignite.

Payer mentions no fossils except silicified wood. The sandstones with clayey cement might possibly be of Jurassic age. Blocks of clay-ironstone with Jurassic fossils have been found in abundance in the district of Cape Flora (Northbrook Island) both by the Jackson-Harmsworth Expedition and by Nansen. But, as no fossils in any way characteristic were found among the specimens of rocks collected by Payer, it is of course almost useless to try and find the age of these rocks from their petrographic resemblance.

1881 (1880). The *first certain* information of the occurrence of Jurassic strata on Franz Josef Land we find in the account of the Eira polar expedition under Leigh Smith¹. In the neighbourhood of *Eira Harbour*, about 10 miles west of Northbrook Island, Mr. W. G. A. GRANT found silicified wood and some other fossils on the hill overhanging the harbour. (August 22, 1880). Among these fossils Etheridge identified two *belemnites* as belonging to the *Oxford Clay*. Unfortunately, the exact locality of these, the first recorded Jurassic fossils from Franz Josef Land, cannot be ascertained. Judging from the description of the surroundings of Eira Harbour (l. c. p. 133) the locality might be Mabel Island, situated to the north of the harbour; while according to the statement of the height of the hill where the fossils were found, (1040 feet) Bell Island, situated to the south of the harbour, might also be the place (the mountain forming the apex of Bell Island is reported to be 1400 feet).

1895. Fifteen years after the discovery of the first Jurassic fossils on Franz Josef Land, the 'Windward' brought to London some geological material from the Jackson-Harmsworth Expedition. The specimens had been collected at Cape Flora on Northbrook Island. Among these specimens were some

¹ C. A. Markham, 'The voyage of the Eira, and Mr. Leigh Smith's Arctic Discoveries in 1880'. *Proceed. of The Roy. Geogr. Soc.* London 1881, vol. III. p. 134, 135, 147.
M. Neumayr, 'Die Geographische Verbreitung der Jura-formation'. *Denkschr. d. Wiener Akad.* 1885, vol. L. p. 90.
A. Montefiore. 'A note on the Geography of Franz Josef Land'. *Geograph. Journ.* London 1894, vol. III. p. 495.

pieces of a coarse calcareous grit in which Mr. E. T. Newton¹ identified petrified wood and other plant-remains, "probably coniferous, but for the most part too much altered to speak of with certainty". Newton also mentions a fragment of a belemnite which cannot be determined, and the impression of an ammonite which is said to resemble *Amm. macrocephalus*². No exact statements of the age of these first fossils sent home by the Jackson-Harmsworth Expedition could be made.

1897. After his safe return from his great North Polar Expedition, Prof. Fridtjof Nansen gave an account of his expedition and its results before The Geographical Society in London on February 8th 1897³. In the report printed in the Geographical Journal he also mentions the occurrence of Jurassic deposits in the Franz Josef Land Archipelago. At Cape Flora, on Northbrook-Island, he says the Jackson-Harmsworth Expedition had discovered, under a heavy cap of basalt, "an immense formation of clay" unquestionably of mesozoic age. The fossils found in it point to the Lamberti-zone, with a development resembling that of the Russian Jura.

At the same time, Nansen called attention to a discovery made by Dr. Reginald Kœttlitz, the physician and geologist of the Jackson-Harmsworth Expedition. Mr. Jackson and Dr. Kœttlitz found, on a basalt rock protruding from a glacier on the north side of Cape Flora, pieces of sandstone containing numerous fossil plant-remains. Nansen and his bold companion, Lieut. Johansen, collected a large number of these plant-fossils, which, after their return, were submitted to Prof. Nathorst in Stockholm for examination. Prof. Nathorst identified these plant-remains as "belonging to the upper, White Jura, rather than to the more medium Brown Jura".

In the same year (1897) Nansen gave some further particulars about the occurrence of Jura at Cape Flora, in his book on the expedition, the German Edition of which: 'Durch Nacht und Eis', is before me. From this report, and from the Norwegian edition⁴ of the same book, we learn that

¹ Arthur Montefiore, 'The Jackson-Harmsworth Expedition: An Account of its first winter and of some discoveries in Franz Josef Land'. Geograph. Journ. London 1895, vol. VI. p. 519 (Note by Mr. E. T. Newton).

² Newton has since (1897) identified this piece with *Macrocephalites macrocephalus* Schloth sp.

³ Fridtjof Nansen, 'Some Results of the Norwegian Arctic Expedition 1893-96'. Geograph. Journ. London 1897, vol. IX. pp. 489-490.

⁴ The details taken from the Norwegian edition I owe to a communication which Dr. Joh. Kiær of Christiania kindly made to me.

under the basalt at *Cape Flora*, there is a soft gray-blue clay of 500—600 feet in thickness, in which numerous large and small nodules of reddish-brown clay sandstone are imbedded. Nansen noticed solitary thin strata of basalt in the clay. The occurrence of thin strata of lignite is also mentioned as having been observed by Kœttlitz in several places¹. Judging from the fossils, mostly included in the sandstone-nodules, but also lying free in the clay, Prof. Nansen characterises *the age* of the *clay*, underlying the basalt of Cape Flora, as approximately identical with that of the *Oxford Clay*².

In December 1897 Messrs. E. T. Newton and I. I. H. Teall³ published their investigations of the new material sent to England by the Jackson-Harmsworth Expedition; and this paper is of great importance to our knowledge of the geology of Franz Josef Land. By help of this collection, and statements by Dr. Kœttlitz, Newton ascertained that in the neighbourhood of Cape Flora on Northbrook Island, Jurassic deposits "chiefly clay interstratified with shales and bands of ironstone, lignite etc." of a considerable thickness (about 600 feet) underlie a cap of basalt extending over the whole district. Enormous heaps of talus débris and gravel almost entirely cover the strata underlying the basalt, and very seldom allow of an examination of the outcrop of these strata *in situ*.

Newton describes Jurassic fossils from different localities in the neighbourhood of Cape Flora.

1. *Elmwood*, on the south side of Cape Flora (station of the Jackson-Harmsworth Expedition):

Amm. (Cadoceras) Tchefkini? d'Orb⁴.

Amm. (Cadoceras) modiolaris Luid.

— — — var.

¹ This statement may refer specially to the district round Cape Gertrude, east of Cape Flora. At Cape Flora lignite is found only in the lowest horizon — 1 (b) — south of Elmwood; cf. the geological sketch by Prof. Nansen, p. 12 and 28.

² See the Norwegian edition and also the second edition of the German translation. vol. II p. 482 et seq.

³ E. T. Newton and I. I. H. Teall, 'Notes on a collection of Rocks and Fossils from Franz Josef Land made by the Jackson-Harmsworth Expedition during 1894-1896,' Quart. Journ. of The Geolog. Soc. London 1897. vol. LIV p. 477—518.

⁴ I quote here the names used by Newton. From the remarks in the descriptive part of this paper, it may be seen how far the determination of the fossils, published by Newton, is to be changed or accepted.

Amm. (Macrocephalites) macrocephalus, Schloth.

Belemnites Panderi, d'Orb.

Pecten cf. *demissus*.

Gorgonia(?)

2. *Windy Gully*, north-east of Elmwood.

Amm. (Macrocephalites) Ishmæ (Keys.) var. *arcticus*.

Amm. (Macrocephalites) Ishmæ, Keys. inflated variety.

Amm. (Macrocephalites) Ishmæ, Keys. smooth variety.

Belemnites 3 sp. indet.

3. *500 yards west of Elmwood*.

Ammonites sp. (fragment of an ammonite allied to *Amm. Gowerianus*, but too imperfect to be determined).

Belemnites div. sp. indet.

Avicula sp. cf. *inæquivalvis*.

4. *On the north side of Cape Flora*: Fossil plants (cf. l. c. pp. 493—495). This is the same locality as that in which Nansen made the collection of fossil plants, which was examined by Prof. Nathorst. It is worthy of notice that Newton also mentions cycads from this place (*Podozamites* sp. probably allied to *P. lanceolatus*) while Prof. Nathorst, in the material examined by him, only found conifers and ferns¹.

In addition to these, silicified wood is also mentioned as having been found in several places, but it is not yet proved with certainty that these pieces, generally found loose on the talus, are of Jurassic age.

The greater number of the fossil forms described by Newton were included in loose blocks picked up from the talus. Only some few specimens are reported as having been found *in situ*.

Amm. (Cadoceras) Tchekkini?, d'Orb. (l. c. Pl. XXXIX Fig. 5) from Elmwood, 50 feet below the basalt.

Avicula sp. cf. *inæquivalvis*

Amm. sp. (?? *Amm. Gowerianus*)

Belemnites sp. sp. indet.

} 500 yards west of Elmwood, 30—
40 feet above the sea.

¹ A new publication by Prof. Nathorst proves, that the material collected by Prof. Nansen also contains cycad-remains; cf. A. G. Nathorst, 'Zur mesozoischen Flora Spitsbergens'. K. Svenska Vet.—Akad. Handl., vol. 30, No. 1. 1897, p. 74.

Amm. (Macrocephalites) Ishmæ, Keys. var. *arcticus* of Newton, from the locality of Windy Gully (300 feet, or according to Kœttlitz, more than 400 feet above the sea) is perhaps also found *in situ*.

Judging from the occurrence of *Amm. (Cadoceras) Tchekini?*, d'Orb. and *Amm. (Macrocephalites) macrocephalus*, Schloth. Newton concluded that the "Lower Oxfordian and probably the equivalent of the British Kellaways Rocks" is represented in the Jurassic strata underlying the basalt at Cape Flora. He is of opinion that *Amm. (Macrocephalites) Ishmæ* Keys. var. *arcticus* of Newton may possibly correspond with the *Cornbrash*.

As to the age of the fragments of *Avicula* and *Belemnites* found west of Elmwood, Newton could draw no certain conclusions.

Nor does he express any very certain opinion with regard to the age of the plant-remains found on the north side of Cape Flora, and which Prof. Nathorst declared to be probably Upper Jurassic (White Jura).

The age of other strata containing plant-remains in the Franz Josef Land Archipelago, Newton¹ also leaves undecided. West of Cape Flora, at Cape Stephen, and between this place and Cape Grant (in the South of Alexandra Land), hard calcareous sandstone with carbonized plants, bituminous paper-shales and lignite occur. The flora of this horizon, perhaps the lowest of the Franz Josef Land Archipelago, according to Newton, most resembles that of the lower Tunguska district described by Schmalhausen "as of Oolitic age". According to later researches² the plants of the lower Tunguska are perhaps however of Permian age. Thus the plant-bearing strata of Cape Stephen are possibly also of Permian and not of Jurassic age, provided that they correspond with those of the lower Tunguska.

1898. Dr. Reginald Kœttlitz gave in 'a brief sketch of the Geology'³ a report of the results of the geological researches which he had made as a member of the Jackson-Harmsworth Expedition. According to his observations, sandstones and shales containing plant remains, "beds of lignite, and other evidences of littoral and estuarine conditions" are among the lowest of the

¹ E. T. Newton and I. I. H. Teall, l. c. pp. 503—506, 513.

² R. Zeiller, 'Remarques sur les flores fossiles de l'Altai etc'. Bull. de la Soc. géol. de France S. 3. vol. XXIV, 1896, pp 471—482, 484.

³ F. G. Jackson, 'Three years exploration in Franz Josef Land. Appendix: Dr. Reginald Kœttlitz: Brief sketch of the Geology'. Geograph. Journ. London 1898, vol. XI, pp. 132—135.

beds of stratified rocks in the southern part of Franz Josef Land. These beds are "succeeded by strata of purely marine origin the age of which can be plainly stated" (according to Newton's determinations) by the occurrence of *Amm. macrocephalus* and *modiolaris*. As evidence of frequent oscillations of sea-level during Jurassic times, Dr. Kœttlitz points out "the extraordinary number of different-coloured thin strata of clay, shale and sand, the last-named being often false-bedded, and frequently having many rounded, water-worn pebbles of all kinds embedded among it".

Unfortunately too few references to exact localities are given in this sketch. The occurrence of plants in the lower strata of the sedimentary formation in the southern part of Franz Josef Land is probably to be referred to the neighbourhood of Cape Stephen (southern side of Alexandra Land) the Jurassic age of which is not definitely determined (*vide* above). The very frequent changes in the petrographic structure of the various layers seem, according to Newton's statements, which were based upon previous communications from Dr. Kœttlitz, to point more especially to the neighbourhood of Cape Gertrude, east of Cape Flora, and to the bank 10—40 feet above the shore, just south of Elmwood; cf. p. 12, "lowest horizon 1 b". The strata with ammonites (belemnites, pectens and avicula-remains) must occur at Cape Flora itself.

The basalt covering the Jurassic sediments in a thickness of 500—600 feet, does not, at Cape Flora, according to Dr. Kœttlitz, appear as a homogeneous mass; it is rather composed of a series of separate layers (tiers) "to the number of seven or eight or more". Between these separate tiers "one can frequently find thin layers or strata of clay and sandstone, generally from 1, 2 to 4 feet in thickness, similar in every respect to those one finds underneath". "In one of these strata, between the second and third tier, and a hundred feet or more above the lower edge of the basalt formation", Dr. Kœttlitz found fossil plants similar to those which he and Dr. Nansen collected on the north side of Cape Flora, on the isolated basalt-rock ("Nunatak") protruding from the glacier. Dr. Kœttlitz supposes that he has here found *in situ* the horizon of the plants identified by Prof. Nathorst as Upper Jurassic (White Jura)¹.

¹ Cf. 'Geological Sketch of Cape Flora and its neighbourhood' by Fridtjof Nansen, pp. 21—24. This sketch, which Prof. Nansen has kindly added to the present paper, contains the newest statements of the geological structure of Cape Flora, and thus it supplements in every way the previous work done in the geology of Cape Flora.

The researches of Dr. Kœttlitz and Messrs. E. T. Newton and I. I. H. Teall are of great value in the investigation of the fossils collected by Prof. Nansen.

The *paleontological and stratigraphical results*, however, at which Newton arrived by the investigation of the material of the Jackson-Harmsworth Expedition will be subject to many alterations, made necessary by the examination of the material described in the following pages.

II.

THE JURASSIC SEDIMENTARY ROCKS AT CAPE FLORA.

According to Prof. Nansen as well as to Dr. Kœttlitz, Messrs. E. T. Newton and I. I. H. Teall, *clay* — a soft gray-blue clay — 500—600 feet thick forms the principal part of the strata underlying the basalt at Cape Flora. Other rocks, such as shales, ironstone (?), clay-sandstone and lignite, are only mentioned as elements of secondary importance in the composition of the Jurassic strata in this region.

Among the specimens of sedimentary rocks of Jurassic age collected by Nansen and submitted to me for examination, pieces of clay are but rare; the majority cannot even be called pure clay.

No. 1. *Grey-blue, grey and yellow calcareous clay* in compact (to some extent hard, concretionary) pieces with from reddish-brown to black weather crust. This crust is rich in hydroxide of iron, so that externally the pieces have the appearance of argillaceous ironstone¹. Veins of calcite occur, and irregular, to some extent swollen accumulations of brown-ironstone, arising from pyrite. The stones contain partly calcified, partly pyritic ammonites (with nacreous shells), fragments of belemnites, and indeterminable isolated remains of small lamellibranchs. The greater number of pieces were found on July 12th 1896, at a height of 100—200 feet (30—60 m.), 1½ kilometer NW. from Elmwood; cf. p. 17, "Doubtful horizon". One piece, of July 16th was found at a height of about 550 feet (150 m.) directly behind Elmwood; cf. p. 15, "Upper horizon". Other pieces collected on July 10th, were

¹ Newton and Teall often mentioned "ironstone" (l. c. pp. 493—495). I have not found in the material before me, pieces which ought to be described directly as "ironstone".

found lying loose on the talus at a height of 100 feet (30 m.) behind Elmwood; cf. p. 16, No. 4.

Judging from their state of preservation, none of these pieces have been found *in situ*.

No. 2. A similar grey-brown, hard, phosphoritic clay found loose at a height of ca. 370—450 feet (113—127 m.) on July 14th 1896, south-western end of Windy Gully; cf. p. 13, "Medium horizon". This piece furnished the calcareous ammonite figured on pl. II. fig. 12.

No. 3. Phosphoritic (and calcareous) clay nodules are numerous in the material before me. They vary from the size of a nut to that of a clenched fist. They are composed of a dark brown or black nucleus of phosphorite, and a lighter gray or brown soft crust of clay which, evidently owing to weathering only, is free from phosphorite.

a). Phosphoritic nodules with light-gray argillaceous weathered crust. Organic remains can only be proved in a few (2) pieces. (Ammonite- and Serpula-remains). A quantity of pieces were found loose on July 12th 1896, 100—200 feet (30—60 m.) above the sea, 1½ klm. NW. from Elmwood, "doubtful horizon", cf. p. 17. Others were found loose on July 14th 1896, at a height of ca. 370—450 feet (113—137 m.) at the south-western end of Windy Gully, "Medium horizon", cf. p. 13.

b). Phosphoritic nodules with darker argillaceous weathered crust, from July 14th 1896, found loose at a height of 400 feet, south-western end of Windy Gully. The nodules contain pieces of the phragmocones of a large species of belemnites. I have nothing to add to the description of the microscopic examination of the phosphoritic nodules, given by Messrs. Newton and Teall¹.

Mr. A. Schwager, chemist at the "königlich bayrisches Ober-Berg-Amt", Munich, had the kindness to examine specimens of phosphoritic nodules. The examination proved that besides phosphate of lime, 8% Ca Co₃ and 7.32% Si O₂ the nodules contain a ferruginous, argillaceous substance to an amount corresponding to Si O₂, and little organic substance².

¹ E. T. Newton and I. I. H. Teall, I. c. Quart. Journ. Geol. Soc. London, vol. 53. p. 499. Pl. XXXVII. fig. 6.

² I here take the opportunity of tendering to Mr. Schwager my warmest thanks for his kind assistance.

No. 4. *Hard dark-gray, finely-grained, sandy marl*, with small, irregular accumulations of pyrite. The stone is much broken and traversed by veins of calcite. Some pieces contain small portions of *pale-gray, very soft marl* (no. 4 a), which was also found unconnected with the hard marl. The sandy hard marl is very rich in shells of lamellibranchs, which, however, are partly very much broken and crushed, partly preserved only in indeterminable sections. In addition to these, there are inarticulate brachiopods and belemnites. These brachiopods and belemnites, and some fragments of indeterminable lamellibranchs, are also included in the pale-gray, soft marl, (no. 4 a) occurring together with the sandy, hard, dark-gray marl, and found loose in isolated pieces.

Both the pieces of sandy, dark-gray, hard marl, and those of soft marl found loose, were collected on August 2nd 1896. They were found at a height of about 23—33 feet (7—10 m.) above sea-level, 300 m. NW. from Elmwood; cf. p. 11, No. 1 a, "lowest horizon". Judging from the state of preservation of the generally rather large blocks of sandy, dark-gray, hard marl, they have most probably been found *in situ*.

No. 5. *Yellow or gray and greenish hard calcareous*, to some extent *sandy marl* ("Steinmergel").

Most of the pieces, which were found loose, show a soft, brown or rusty red weathered crust. Some pieces of the rock are quite compact, uncommonly hard, with a conchoidal fracture; the fractured surface is glossy black and of a greasy appearance. Other pieces are of coarser grain; but upon the whole, they are always quite finely grained, with an earthy fracture. By containing more sand and being less calcareous, this rock gradually passes over into clay sandstone (No. 6).

The rocks contain numerous impressions and fragments of ammonites (with nacreous shells) and indeterminable remains of belemnites; and, very rarely, remains of lamellibranchs are found. Besides indications of plant-remains, one of the pieces contains traces of a coal-like substance.

These pieces were found loose on the talus, on July 10th 1896, at a height of 100 feet (30 m.) above sea-level, behind Elmwood, cf. pag. 16, and on July 14th 1896, at a height of about 370—450 feet (113—137 m.), at the south-western end of Windy Gully, cf. p. 13.

No. 6. There are also numerous pieces of *cone-in-cone structure* ("Tutenmerget, Nagelkalk") corresponding, petrographically, in every respect with the above-mentioned rock-type. They were found loose on the talus, on July 10th 1896, at a height of 100 feet (30 m.) above the sea, behind Elmwood, and on July 12th about 100—180 feet above sea-level, 1½ klm. NW. from Elmwood.

No. 7. *Clay-sandstone*. From finely-grained to extremely finely-grained, compact, to some extent calcareous, clay-sandstone, with tiny lamellæ of white mica, is represented by a large number of specimens. In an unweathered state, the stone is hard, gray or dark-gray. Most of the pieces are surrounded with a brown, or rusty red weathered crust of varying thickness. A few pieces, owing to the great amount of weathering they have undergone, are soft, and dyed through and through, from a rusty brown to red. Pyrites and its derivative limonite, occur in small irregular accumulations partly as fossilising material, especially of ammonites.

The finely grained varieties very much resemble the more sandy varieties of the rock of type, No. 4.

Most of the pieces contain fossil remains, ammonites especially (partly pyritic) being of frequent occurrence, their shells glittering like mother-of-pearl (partly only impressions of small specimens and broken impressions of very large ones); next, less frequent fragments of belemnites, and then a number of species of lamellibranchs, each represented usually by but one or two specimens. Most of the lamellibranchs described in the following chapter are embedded in clay sandstone. Indistinct traces of plants(?) also occur.

The greater number of pieces of clay sandstone were collected on July 16th 1895, at a height of 500—550 feet (150—165 m.) above sea-level, behind Elmwood, cf. p. 14, "Upper horizon"; and of this majority again, most were found loose, for they were surrounded with a weathered crust, and must therefore have been subjected to weathering for a considerable time on the talus.

Some few pieces without, or with only a thin and imperfect weathered crust, have been found *in situ* about 550 feet above sea-level, or have fallen down from their bed a comparatively short time before. There is no doubt that at Cape Flora, there are nodules of clay sandstone in places at an average height of 500—550 feet above sea-level, and near the lower edge of the

basalt at Elmwood on the southwest side of Cape Flora, Newton and Teall¹ also mention clay sandstone *in situ*, about 50 feet below the basalt, that is to say, at a height of about 550 feet above sea-level. The most important of the clay sandstone fossils which Newton describes from this height, can be identified with the clay sandstone fossils examined by myself.

A very much weathered piece of clay sandstone was also found loose on the talus on July 12th, 1896, 100—200 feet above the sea, 1½ klm. NW. from Elmwood, cf. p. 17, "doubtful horizon".

A small portion of the material before me consists of fossil fragments without adhering rock. These pieces, at any rate to some extent, can be recognized as having been weathered out of several of the types of stone here mentioned. I shall return to these pieces in the last section of this treatise.

¹ E. T. Newton and J. J. H. Teall, l. c. p. 496.

III.

THE FAUNA OF THE JURASSIC SEDIMENTS AT CAPE FLORA.

1. STATE OF PRESERVATION OF THE FOSSILS.

Judging from the material submitted to me by Prof. Nansen, some portions of the Jurassic sediments at Cape Flora must be called rich in fossils. Particularly, rock of type 4, mentioned in the last chapter, is in some places thickly interspersed with fossil remains, especially of lamellibranchs.

Unfortunately the fossils are generally very imperfect. They consist of broken and crushed specimens, or of imperfectly preserved internal casts and impressions.

The greater number of the *lamellibranchs*, which are very numerous, judging from the preserved remains, could not be determined at all. In some of them, the genus could hardly be determined, and *the species could be identified only in a few specimens*. The results obtained by the examination of the lamellibranchiata are in consequence not very satisfactory.

The few *brachiopods* (2 species) are also mostly in broken fragments, though sufficiently well preserved for identification. The most perfect remains, in comparison, are those of cephalopods. Although they are chiefly only fragments and impressions of some quite young specimens of *ammonites* that occur, they could be identified with a very fair amount of certainty. The nacreous shells of the ammonites, generally inclosing a cast of pyrite or brown ironstone, strongly recall the manner of preservation of the ammonites in the Russian Jura. Fragments of *belemnite* guards found loose, occur in numerous pieces, and are, to a certain extent, easily identified

The state of preservation of some remains of belemnites and *Pseudomonotis* found on August 2nd, 30 feet above the sea level, is peculiar. They were lying free in the clay (*in situ*) together with stone-nodules of type 4. The greatly broken pieces are covered with a crust of crystals of gypsum.

Considering the state of preservation of the fossils in conjunction with the petrographic character of the rocks, the Jurassic strata of Cape Flora give the impression of deposits having been formed near the shore. In the rough water near the shore, the hard parts of the animals were easily broken. The pressure of the heavy masses above, and fractures in the rock, then accomplished what was still wanting to make the state of preservation of the animal-remains embedded in clayey, marly and sandy masses, as bad as it could possibly be.

2. DESCRIPTION OF THE FOSSILS.

ECHINODERMATA.

CRINOIDEA.

The Echinoderms are only represented by a single fragment of a crinoid stem, in the material collected by Prof. Nansen. This belongs to the genus

PENTACRINUS, Miller s. str.

and was determined as:

Pentacrinus sp. ex. aff. *bajociensis* (d'Orb.) P. de Loriol.

Pl. I. fig. 1.

(Cf. 1886 *Pentacrinus bajociensis* d'Orb., P. de Loriol: Crinoides. Paléontologie française. Terr. jur. vol. IX. p. 144, pl. 150, 151, figs. 1—4).

The fragment of stem before me consists of 6 joints. The alternating joints are somewhat different in shape and size. The larger and longer joints are pentagonal in outline with rounded corners; they are not incurved in the interpetalous regions, or only very slightly. The joints alternating with them are a little smaller and shorter. Their contour is also rounded pentagonal, but in the interpetalous regions they are slightly incurved at obtuse concave angles. The outer side of all the joints is inflated and arched, almost carinated. The outer surface is thickly tuberculated. Near the sutures, the tubercles are closer and finer than along the middle of the inflated side. The tuberculating has to some extent become indistinct from weathering.

The sutures between the different joints, situated in depressed grooves, are finely crisped. In the interpetalous regions rounded depressions occur ("interarticular pores" H. Carpenter). Owing to these depressions, the smaller and shorter joints are somewhat narrowed in the interpetalous regions from above and below, whereas the larger joints are not subjected to any such narrowing.

The cirri-bearing joints ("nodal joints" Wyville Thomson) are not to be found on the piece here figured. The upper articulating surface of the uppermost (smaller) joint (Pl. I. fig. 1, c, d.) which is developed to form a syzygial surface, shows that the succeeding joint must have been a nodal joint.

On the syzygial surface the petalous parts are separated by shallow, but comparatively broad grooves. At the opposite end of the stem-fragment, the remains of an ordinary articulating surface is to be seen. Here the interpetalous grooves are in the form of very narrow, scarcely depressed lines. The coarse crenation of the broad low ridges surrounding the shallow petalous furrows is scarcely interrupted by the grooves between any two petala. The interarticular pores, mentioned above, communicate with these interpetalous grooves.

Judging from the appearance of the interarticular pores, the piece figured must have belonged to the upper part of a stem, as a comparison with the living pentacrinites will show. It cannot, however, have come from the immediate vicinity of the calyx, for the piece is destitute of the deep inward curvatures in the interpetalous regions that are characteristic of this part of the stem.

Pentacrinus sp. ex. aff. *bajociensis* (d'Orb.) P. de Loriol was found loose, without adhering rock, on July 12th 1896, at the margin of the glacier northwest of Elmwood, and about 150—200 feet above the sea.

The piece is composed of dark, almost black calcite.

Remarks. The relationship of the form described with *Pentacrinus bajociensis* (d'Orb.) P. de Loriol is most probably, in so far as this species is known, a very close one. The piece figured by P. de Loriol (l. c. Pl. 150, fig. 9) in particular, bears a great resemblance to our form, if we leave out of consideration the missing nodal joints of our specimen. The differences between this and the species described by Loriol, several pieces of which from

the Bajocien of Feuguerolles (Calvados) are now before me, are confined to the following points:

1. In our form, the joints are considerably longer and less incurved in the interpetalous regions;
2. The interarticular pores in *Pentacrinus bajociensis* are broader than in our stem-fragment.

I am not able to determine with certainty whether these differences are specific, and not merely individual, or whether they are only to be attributed to the fact that the stem-fragment here figured corresponds to another region, more distant from the calyx than those described from *Pentacrinus bajociensis* and fragments of which are before me. Doubtless in *Pentacrinus bajociensis*, as in all *Pentacrinus* species, the joints farther from the calyx are longer, less incurved, and thus more similar to the fragment described from Cape Flora.

Our piece differs from *Pentacrinus Nicoleti*, Desor¹, a species from the Bathonian, closely allied to *Pentacrinus bajociensis*, in the considerably larger dimensions of the corresponding parts of the stem, situated far away from the calyx, and accordingly analogously formed, in the more prominent inflation and carination of the joints, and in the less slender petalous furrows. The formation of the interarticular pores of some of the pieces of *Pentacrinus Nicoleti*² figured by P. de Loriol, is the same as that of the above-described fragment of *Pentacrinus sp. ex. aff. bajociensis* (d'Orb.) P. de Loriol; in other pieces it is different.

VERMES.

SERPULA, Linné.

Serpula flaccida, Goldf.

- 1826—34. *Serpula flaccida*. A. Goldfuss, 'Petrefacta Germaniæ', l. p. 25 4. pl. LXIX. fig. 7.
1856. " " F. A. Quenstedt, 'Der Jura.' p. 393, (S. gordialis s. p.) pl. 53, fig. 16.
- 1865—68. " " E. d'Eichwald, 'Lethæa Rossica. Per. moy.' vol. II. p. 269, pl. XVIII. fig. 13.

¹ P. de Loriol, l. c. p. 165, pls. 154—161.

² P. de Loriol, l. c. pl. 157, fig. 3b, pl. 158, fig. 1b.

On the casts from the umbilicus of an indeterminable *Cadoceras* there are some irregularly curved, thin casts of a *Serpula* which cannot be distinguished from *Serpula flaccida* Goldf.

The pieces were found loose near the margin of the glacier west of Elmwood on July 12th 1896, 100—200 feet above the sea. They are embedded in nodules of pale-gray phosphoritic clay.

MOLLUSCOIDA.

BRACHIOPODA.

Among the fossils collected at Cape Flora the brachiopods are only represented by the species:

Lingula Beani Phill. and *Discinareflexa* Sow. sp. of the genera *Lingula* and *Discina*, belonging to the *Inarticulata*.

The remains of these two species occur together, and are confined to the two following rock-types:

- (1). Gray, finely-grained, sandy hard marl, type No. 4 of the rocks; and
- (2). Pale gray, argillaceous marl, of which small portions are embedded in rock of type No. 4 and are found in conjunction with it.

Several loose pieces of both species could be recognized as being derived from this marl, by the fragments of rock adhering to them.

In other stones collected at Cape Flora, the presence of brachiopods could not be proved.

Some of the shells of the brachiopods are black and shiny; others have the appearance of coal, while in some the whitish layers of the shells are destroyed. The greater number of pieces are unfortunately much damaged, crushed and broken.

LINGULA, Brugulère.

Lingula Beani Phill.

Pl. I. figs. 2—5. Letterpress fig. 8.

1829. *Lingula Beani*. J. Phillips, 'Illustrations of the Geology of Yorkshire,' part I. p. 157, pl. XI. fig. 24.
1850. " " Th. Davidson, 'Monograph of the British fossil Brachiopoda,' vol. I. part III. 'A Monograph of the British Oolitic and Liassic Brachiopoda,' p. 8. e. p. (not pl. I. fig. 1.).

1844. *Lingula Beani*. J. Morris, 'Catalogue of the British Fossils.' 2nd edit. p. 138.
1856. " " A. Oppel, 'Die Juraformation,' § 53, No. 248.
1856. " " F. A. Quenstedt, 'Der Jura,' p. 352, pl. 47, fig. 17.
- [1861. " " ? H. Trautschold, 'Recherches géologiques aus environs de Moscou.' Bull de la Soc. impér. des Natural. de Moscow, p. 68, pl. V. fig. 1].
- [1861. " " ? H. Trautschold, 'Der Moskauer Jura verglichen mit dem westeuropaeischen.' Zeitschr. der Deutsch. geol. Ges. p. 389].
1869. " " O. Terquem et E. Joudry, 'Monographie de l'Étage Bathonien dans le département de la Moselle.' Mém. de la Soc. géol. de France (2), vol. IX. p. 135.
1869. " " D. Brawns, 'Der mittlere Jura im Nordwestlichen Deutschland,' p. 292.
1871. " " F. A. Quenstedt, 'Petrefactenkunde Deutschlands.' II. Die Brachiopoden, pl. 60, figs. 80—82 (not 83).
1875. " " R. Lepsius, 'Beiträge zur Kenntniss der Jura-Formation im Unter-Elsass,' p. 45, pl. II. fig. 2.
1876. " " Th. Davidson, 'Monograph of the British fossil Brachiopoda.' Vol. IV. Suppl. to the British Jurassic and Triassic Brachiopoda, p. 78, pl. IX. figs. 10—12, (14 ?).
1882. " " H. Haas und C. Petri, 'Die Brachiopoden der Juraformation von Elsass-Lothringen.' Abhandl. z. geol. Spezialkarte v. Elsass-Lothringen, vol. II. p. 311, pl. XVII. figs. 5—10.

Remains of *Lingula Beani* Phill. occur in abundance, but generally only in fragments. The most perfect, and, for purposes of specific identification, most important pieces are figured on Pl. I. figs. 2—5.

The external surfaces of these pieces, which vary considerably in size (up to 25 mm in length), show the close-set narrow but distinct lines of growth. On the large valve of full-grown individuals, the mesial longitudinal ridge, issuing from the beak along the middle, can be clearly distinguished. From this ridge the valve slopes gently towards the lateral edges. In the middle

of the length of the valve, this ridge turns into a flat area, gradually widening towards the frontal margin (Pl. I. fig. 2).

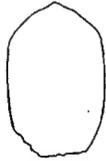

Fig. 8. *Lingula Beani*, Phill.
Outline of Pl. I, fig. 2,
for correction of fig. 2 a
Nat. size.

For the identification of our pieces with the frequently mentioned species from the Lower Dogger, it was important to examine the formation of the interior of the valves (Pl. I. figs. 3—4).

The inside of each valve shows a broad, slightly raised, rather flat rounded mesial ridge, extending from the beak to the middle of the length of the valve. (On the cast, Pl. I. fig. 3, this appears as a shallow groove). In the large valve, this ridge is accompanied on the right and left by a thread-like fillet or ridge, which, under the lens appears to be double, on account of an extremely fine longitudinal furrow. Pl. I. fig. 4a and b further shows some of the very superficial muscular impressions of the large valve. The posterior edge of the blended impressions of the anterior adductor and of the external protractor muscles is produced into three unequal lobes. The left and right muscular impressions, divided only by the mesial longitudinal ridge of the valve, are connected in front by the horse-shoe-like impression of the central protractors which surround the anterior extremity of the mesial ridge of the valve. The shape of the muscular impressions of the smaller valve could not be distinctly seen.

Remarks. The above-mentioned pieces of *Lingula Beani* Phill. correspond perfectly in form and sculpturing with the specimens from the lowest Dogger of Yorkshire and from the Sauzei-zone (Br. Jura γ) from the neighbourhood of Mietesheim, Gundershofen, Griesbach in Lower Alsace. The more prominent longitudinal convexity of the larger valve (Pl. I. fig. 2) may especially often be observed in the specimens from Alsace.

The form of the muscular impressions in the larger valve — unfortunately only visible in a single specimen — differs somewhat from that we have hitherto been acquainted with in *Lingulidæ*. It differs especially from the drawing which Quenstedt¹ gives as that of the inside of *Lingula Beani*, but Quenstedt's figure does not represent the inside of a true *Lingula Beani* Phill.

¹ F. A. Quenstedt, 1871, l. c. pl. 60, figs. 83, 84.

The figure in question is the copy of a drawing to which Davidson¹ formerly gave the name of *Lingula Beani* Phill., but which was subsequently² identified by the same author as belonging to the Liassic species *Lingula sacculus* Dew.

In one of the specimens of *Lingula Beani* Phill. from Yorkshire, a successful preparation brought out the muscular impressions of the larger valve quite distinctly. The impressions of the anterior adductors and of the external protractors are *considerably deeper here* than in our specimen from the neighbourhood of Cape Flora. The posterior margin of these impressions, in the British specimen also, is not entire. It exhibits three incipient lobes directed backwards, but all less distinct than in the Arctic specimen. In the British specimen, the middle lobe is broader and shorter, those on each side of it smaller, and the curves shorter and shallower than on Pl. I. fig. 4. In specimens of the *Lingula Beani* Phill. from Alsace, the muscular impressions, which are *considerably more superficial here* than in British specimens, did not allow of being so well prepared. As far as I could see in the Alsace specimens the posterior edges of the muscular impressions (anterior adductors and exterior protractors) are more lobed here than in British specimens, and correspond better with the figure given on Pl. I. fig. 4.

It appears from the material examined that the difference in the shape of the muscular impressions probably depends upon the depth which these impressions have had in the valves. After observing this, I have no hesitation in identifying the lingulid form from Franz Josef Land, now before me (with shallow, posteriorly deeply lobed muscular impressions) with *Lingula Beani* Phill. from the lowest Inferior Oolite of England (with deep, only slightly lobed muscular impressions) and from the Sauzei zone of Alsace (with shallow, more deeply lobed muscular impressions), as the size, form and sculpturing of the individuals of the most different localities agree.

Lingula brevirostris, Meek and Hayden³, from the Jura of the Black Hills of Dakota is closely allied to our species by the straight lateral edges. The American species differs from *Lingula Beani* Phill. in having longer posterior margins and a more pointed umbo.

¹ Th. Davidson, 1850, l. c. pl. I, fig. 1.

² Th. Davidson, 1876, l. c. p. 79.

³ H. Newton and W. P. Jenny, 'Report on the Geology and Resources of the Black Hills of Dakota, U. States' g. a. g. Surv. of Rocky Mts. Region. 1880. p. 346, pl. III. figs. 4, 5.

DISCINA, Lamarek.

Discina reflexa Sow. sp.

Pl. I. fig. 6, 7, 8, 9, (10?).

1829. *Orbicula reflexa* J. D. C. Sowerby, 'Mineral Conchology of Great Britain,' vol. VI. p. 4, pl. DVI. fig. 1.
1850. " " Davidson, 'Monograph of the British fossil Brachiopoda,' vol. I. part III. 'A monograph of the British Oolitic and Liassic Brachiopoda,' p. 10, pl. X. fig. 8.
1856. *Discina* " A. Oppel, 'Die Juraformation,' § 53, No. 247.
1856. *Orbicula* " F. A. Quenstedt, 'Der Jura,' p. 325, pl. 45, fig. 2.
- [1861. " " ? H. Trautschold, 'Der Moskauer Jura verglichen mit dem westeuropäischen,' Zeitschr. d. Deutsch. geol. Ges. p. 390].
1871. " " F. A. Quenstedt, 'Petrefactenkunde Deutschlands,' II. Die Brachiopoden. p. 660, pl. 60, fig. 97—101.
1875. *Discina* " R. Lepsius, 'Beiträge zur Kenntniss der Juraformation im Unter-Elsass,' p. 46.
1876. " " Th. Davidson, 'Monograph of the British fossil Brachiopoda,' vol. IV. Suppl. to the British Jurassic and Triassic Brachiopoda, p. 82, pl. X. figs. 1—6.
1876. " " R. Tate and J. F. Blake, 'The Yorkshire Lias,' p. 414, pl. XV. figs. 5, 6.
1898. " " E. W. Benecke, 'Beitrag zur Kenntnis des Jura in Deutsch-Lothringen.' Abh. z. geol. Spez.-Karte v. Elsass-Lothringen, N. F., part I. 1898, p. 22, pl. I. fig. 1.

Convex valves of *Discina reflexa* Sow. sp. were found together with *Lingula Beani* Phill. but less frequently than that species.

The specimens before me correspond for the most part closely with English specimens from Yorkshire. The form of the valves both in the English specimens and in those found in the neighbourhood of Cape Flora, is very variable; side by side with high, more conical specimens with a steeper inclination from the apex to the posterior margin, (Pl. I. figs. 7, 8) occur lower, cup-shaped forms (Pl. I. fig. 6). The shell is ornamented with close-set, fine, distinct lines of growth. The upward curve of the shell and of the lines of

growth at the posterior margin (Pl. I. figs. 7, 8) completes its similarity to the English specimens.

The places of the attachment of the muscles, which permitted of being prepared in one of the specimens (Pl. I. fig. 6) correspond as nearly as possible with those of specimens from Yorkshire. In fig. 6 (6a) a rather long reniform impression may be seen on the cast on both sides beneath the apex. The impressions become slighter towards the frontal side of the valve, so that their anterior extremity is not very distinctly marked. The impressions on the casts correspond with thickenings on the inside of the valves which in *Discina* serve as attachments for the muscles. Upon the plain, extending from the apex to the frontal margin, two broad, quite smooth radial, elevations may be observed.

On the casts, both here and in specimens from Yorkshire, may be observed extremely fine ribs radiating from the apex to the frontal margin.

The form represented in fig. 9 is particularly flat, and hence recalls *Discina Etheridgei* Dav.¹ from the Inferior-Oolite-Sands of Nailsworth. It differs from that species in the distinctly marked apex (broken off in this specimen). Judging from the form of the attachments of the muscles, *Discina Etheridgei* Dav. is only a flatter variety of *Discina reflexa* Sow. sp. without distinctly marked apex.

The fragment (cast) represented in fig. 10 differs somewhat in the position and form of the apex from the other pieces, and also from other specimens of *Discina reflexa* Sow. sp. which have been examined. The apex is perfectly central, curving somewhat towards the posterior margin (the piece is reversed in the drawing). Owing to the imperfect condition of this piece it is impossible to determine with certainty whether it should be identified with *Discina reflexa* Sow. sp. or not.

MOLLUSCA.

LAMELLIBRANCHIATA.

It is only in the hard, grey, sandy marl (No. 4), that lamellibranchs occur in any great quantities. Unfortunately, however, none of the numerous forms contained in this rock, with the exception of the new *Pseudomonotis*

¹ Th. Davidson, 1876, l. c. p. 86, pl. X, fig. 20.

described below, can be determined, as the specimens only consist either of crushed and broken fragments, or imperfect impressions and sections.

Casts and impressions of species of various genera (*Pseudomonotis*, *Pecten*, *Limea*, *Lima*, *Leda*, *Macradon*) occur, moreover, in pieces of clay sandstone, especially in somewhat coarse-grained pieces; but they are only to be observed occasionally in these rocks, their remains not having accumulated here in nearly such abundance as in the rock of type No. 4.

Now and again, traces of indeterminable lamellibranchs occur in pieces of argillaceous rock, and of stone marl.

PSEUDOMONOTIS, Beyrich.

Pseudomonotis Jacksoni, n. sp.

Pl. I. figs. 13—16. Letterpress fig. 9.

1897. *Avicula* sp. cf. *inæquivalvis*, E. T. Newton and J. J. H. Teall: l. c. Quart. Journ. Geol. Soc. London, vol. 53, p. 502, pl. XL, fig. 4.

In gray, hard, sandy marl (Aug. 2nd, 1896, 30 ft. above sea-level, ca. 300 m. north-west of Elmwood), are embedded numerous broken and crushed shells, flattened by compression, of a remarkably large Aviculid form. Fragments of the same species were also found loose, weathered out of the rock (also Aug. 2nd, 1896).

The approximate outline of the shell, as far as it can be reconstructed from the broken pieces, has been drawn by Newton, l. c.

The valves are comparatively not very oblique. The long hinge is straight. The apex lies near the anterior margin and projects only slightly, if at all, over the hinge. The posterior wings are large, and their posterior edge seems to me to be very slightly concave. The anterior wings are also rather large, although considerably smaller than the posterior ones. The valves are thick.

The left valve is moderately convex, with the exception of the flat wings. It exhibits a system of straight radial ribs. The wide spaces between the 15—20(?) coarse main ribs, show 2, 3, 4, or more finer ribs, of which the one in the middle is generally the most distinct. Near the inferior edge, nearly all the ribs are equally coarse. The posterior wing is covered thickly with

¹ Named in honour of the leader of the Jackson-Harmsworth Expedition.

fine radial ribs. On some fragments, slight indications of very fine, close, concentric grooves are to be seen.



Fig. 9. *Pseudomonotis Jacksoni*. n. sp. Interior of the specimen Pl. I, fig. 15, showing the oblique ligament groove on the area; nat. size.

The right valve is flatter. It shows concentric, leaf-shaped lamellae (fig. 14a), or very faint radial ribs. In pieces that have been weathered out of the rock, the interesting construction of the inside (Pl. I, fig. 14b, c, and letter-press fig. 9) may be observed. On the broad area, a shallow, triangular ligament-groove extends obliquely from the umbo towards the back (Letterpress fig. 9).

Below the area lies a rounded or triangular, deep, cup-shaped groove, growing shallower towards the back. The long incision for the byssus, extending obliquely along the valve, becomes obliquely covered up, to some extent altogether closed by an interior thickening of the valve of the anterior wing. Fig. 14c shows the remarkably thick, swollen margins of the byssus fissure in profile.

Remarks. Newton compares the form in question with *Avicula inaequalvis*, Sow. from the Callovian, but points out, as a difference, that the ribs are coarser than in Sowerby's species. Apart from the fact that *Avicula inaequalvis* Sow. of so large a size as the species before us, is unknown, there is also the fact that the left valve of *Avicula inaequalvis* Sow. is always considerably more oblique, and more elongated. *Avicula inaequalvis* has, moreover, fewer ribs, and the spaces between the 14 ribs are almost, if not quite smooth.

The sculpturing of the valves recalls more strongly that of the so-called *Avicula Münsteri* Goldf. Apart from the difference in size between the two forms, identification with this species is impossible, on account of the construction of the inside of the valve.

The inside of the right valve, especially in the deep, cupshaped impression (of the anterior muscle), shows some affinity to the subgenus "Meleagrina Lam". A similar deep impression was observed by Fr. Teller, on the *Avicula (Meleagrina) Tundrae* Tell¹, described from the East Siberian Trias.

¹ Fr. Teller, 'Die Pelecypoden-Fauna von Werchojansk in Ostsibirien' (in E. Mojsisovics von Mojsvar: Arktische Triasfaunen) Mém. de l'Acad. impér. des sciences de St. Pétersbourg. Sér. VII. vol. XXXIII, no. 6, 1886, p. 133. pl. XIX, fig. 9.

The differences between it and the few known Mesozoic, and more recent Melcagrines, are the size of the anterior wing, the consequent length of the byssus-fissure, and the marked radial sculpturing of the left valve, which, as far as I know, has not before been observed to such a degree of clearness in Melcagrines. On account of the slight obliquity in the outline of the valves, of the ornamentation of the valves by radial ribs, of the shape of the anterior wing and of the direction of the byssus-fissure, the species before us must be separated from *Meleagrina* and reckoned as *Pseudomonotis*. Though the oblique ligament-groove does not agree with the known species of *Pseudomonotis*, all the other characteristics of our species agree completely with this genus; especially the cupshaped, deep groove below the ligament-area is also to be seen in the right valve of *Pseudomonotis*, e. g. *Pseudomon. echinata* Sow. sp. On account of the large size and of the degree of ornamentation the species before us must be regarded as a new one.

Pseudomonotis sp. (cf. *ornati* Quenst. sp.)

Letterpress fig. 10.

In grey-brown, weathered clay sandstone July 16th, 1896, 500—550 ft above sea level, north of Elmwood, several fragments and impressions of a *Pseudomonotis* were found, of which the most perfect are figured here.

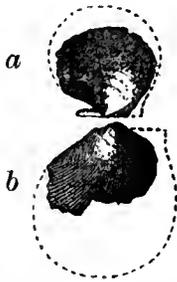

Fig. 10 *Pseudomonotis* sp.
(cf. *ornati* Quenst. sp.)
a right, *b* left valve; figured
from a waxcast, 2× enlarged,

The smaller right valve is moderately convex, and exhibits an indistinct, concentric striation. The larger, highly convex left valve is thickly ornamented with fine unequal radial ribs. Here, too, the concentric sculpturing is but faintly developed.

A similar, perhaps corresponding form, I found with *Cadoceras Nanseni* (Pl. II. fig. 6.) in greyish yellow, argillaceous stone marl (July 14th, Windy Gully 400 ft).

Remarks. Judging from the greater convexity of the right valve, and the fine radial sculpturing of the left valve, the present *Pseudomonotis* sp. is related to *Pseudomonotis ornati* Quenst. sp.¹. On account of the imperfect material, it cannot be

¹ F. A. Quenstedt, 'Der Jura', p. 553, pl. 72, fig. 33. A similar form, but from the Oxfordian from Viel-St.-Remis (Ardennes), is before me.

ascertained whether it agrees with this species of the Suabian "Ornaten"-clay or not. Up to the present, no similar *Pseudomonotis* is known from the Russian Jura, or from the Arctic regions¹. The North American species, *Pseudomonotis (Eumicrotis) curta* Hall sp.² and *orbiculata* Whitfield³, appear to be allied to the present form in their delicate sculpturing.

PECTEN, Klein.

(*Camptonectes*, Agassiz)

Pecten Lindströmi Tullberg.

Pl. I. fig. 12.

1881 (1880) *Pecten Lindströmi*. S. A. Tullberg, 'Ueber Versteinerungen aus den Aucellen-Schichten Nowaja Semljas'. Bihang till K. Svenska Vet. Akad. Handl. vol VI. No. 3, p. 24, pl. I, figs. 1—5.

The present specimen is the impression of a moderately convex left valve. Contour oblique oviform, sides somewhat unequal. Height scarcely one sixth greater than the length of the valve. The partly broken and displaced anterior wing is large: the posterior, smaller wing is very imperfect. The surface is densely ornamented with fine, concentric lines, which appear very distinctly on the wing, while on the valve itself they are only visible under the lens. The concentric sculpturing is crossed by a system of extremely fine, close, radial lines. These correspond (on the *positive* of the shell) with fine, rather long, very narrow depressions, arranged in radial rows, and occurring in the interspaces between the concentric lines. Near the lateral margins, and especially on the wing, the radial lines appear more distinctly than elsewhere on the valve, where they are only visible in a good light. (In fig. 12b, the radial lines of the valve have not been clearly brought out.) Towards the edge of the valve, the radial lines are curved.

The specimen of *Pecten Lindströmi* Tullb. was found in a loose block of rusty-coloured, weathered, clay sandstone, on July 16th, 1896, north of Elnwood, 500—550 ft above the sea.

¹ The *Pseudomonotis subechinata* Lah. described by Lahusen (Die Fauna der Jurasischen Bildungen des Rjasanschen Gouvernements, p. 85, pl. II, figs. 6, 7), judging from its coarse sculpturing, is closely allied to *Pseudomonotis echinata* Sow. sp.

² F. B. Meek and F. V. Hayden, 'Paleontology of Upper Missouri', part I. 1864, pl. III. fig. 10.

³ H. Newton and W. P. Jenny, 'Report on the Geology and Resources of the Black Hills of Dakota', U. S. G. a. G. Survey of Rocky Mts. Region, 1880, p. 356, pl. III. figs. 17—19.

A fragment of an almost smooth pecten, possibly also belonging to *Pecten Lindströmi*, lies embedded in hard, greyish yellow stone marl, found loose, July 14th, Windy Gully.

Remarks. The present piece entirely agrees with the description given by Tullberg, of *Pecten Lindströmi* from the Aucellen strata of Skodde Bay, on the south island of Novaja Semlja (south-west end of Matotschkin Scharr).

According to the form of the wings, and to its fine sculpturing, *Pecten Lindströmi* Tullbg. is a *Camptonectes*, and is allied to *Pecten lens* Sow. and *Pecten rigidus* Sow. *Pecten Lindströmi* differs from the ordinary forms of *Pecten lens* in the considerably less distinct radial sculpturing, and in the relatively more distinct and regular concentric striation. Among the forms described as *Pecten lens*, there is one — figured by Lahusen from the strata of *Perisphinctes mosquensis* Fisch. (Upper Callovien) from Tschulkowo¹ — which is rather closely allied to our species, by reason of the more distinct concentric, and fainter radial sculpturing. The radial sculpturing, however, is more distinct in this species of the Russian Jura, than in *Pecten Lindströmi* Tullb.

Among the numerous specimens of *Pecten rigidus* Sow. from the Dogger of Balin (referred to by G. C. Laube as *Pecten lens*)², a few forms approximate very closely to *Pecten Lindströmi* Tullb. in the faint radial sculpturing.

Pecten subannulatus Schlippe³ from the "Hauptoolith" of Alsace, possesses, according to the given figure (l. c.) of a *right* valve, radial sculpturing similar to that of *Pecten Lindströmi*, viz. elongated grooves arranged in rows. In his description of the species, however, Schlippe speaks of radial ribs, and radially arranged ridges. *Pecten subannulatus* Schlippe is more equilateral, and on the anterior wing exhibits a less distinct concentric sculpturing than *Pecten Lindströmi* Tullb.

Pecten (Camptonectes) stygius White⁴, from the Upper Jura of Utah exhibits a sculpturing similar to that of *Pecten Lindströmi*. In addition to fine,

¹ J. Lahusen, 'Die Fauna der jurassischen Bildungen des Rjasansehen Gouvernements'. Mém. du Com. géol. St. Pétersbourg, vol. I. No. I. pl. II. fig. 2 (not fig 1).

² G. C. Laube, 'Die Bivalven des Braunen Jura von Balin'. Denksch. d. Wiener Akad. vol. XXVII. 1867, p. 12 (20).

³ A. O. Schlippe, 'Die Fauna des Bathonien in oberrheinischen Tieflande'. Abbandl. zur geol. Spezialkarte von Elsass-Lothringen, vol. V. part IV. 1888, p. 128, pl. II. fig. 3a, b.

⁴ C. A. White, 'Report upon the invertebrate Fossils' in Report upon the G. a. G. Explorat. and Surv. West of the 100th Meridian', 1875, p. 164, pl. XIII, fig. 2.

concentric lines of growth, White mentions very fine radial lines, visible only in a very favourable light. The American species differs from our own in the greater length of the valve.

LIMEA, Goldfuss.

? *Limea* cf. *duplicata* Goldf.

Pl. I. fig. 11.

Cf. 1834—40 *Limea duplicata* Goldfuss, 'Petrefacta Germaniæ', vol. II. p. 103, pl. CVIII. fig. 9.

The coarse, straight ribs mark the figured cast as being that of a right valve of a species of *Limidæ*. The same relation that is found here between the ribs and the broad, smooth intercostal spaces, is observed in the genus *Limea*, especially in the both horizontally and vertically widespread species, *Limea duplicata* Goldf.¹ The present piece is probably closely allied to this species. Small, oblique impressions in the upper part of the vertical, scarcely hollowed-out Lunula, which correspond in position to the small, lateral denticles of the *Limea*, confirm me in my opinion that the present fragment is a *Limea*.

Our piece cannot be identified with *Limea duplicata*. *Limea duplicata* is generally smaller, more equilateral, and as a rule has more ribs — from 2 to 17, generally 16 on the valve, and 13 or 14 on the cast (our form has only 11 ribs on the cast).

Lima consobrina d'Orb.², which resembles our form in outline, is too flat, and too closely ribbed to be compared with the piece before us. Moreover, d'Orbigny's species is a true *Lima*, and no *Limea*. Neither can the *Lima* cf. *duplicata* Sow. sp.³ from Spitzbergen, figured by Lundgreen, be connected with our form, as it exhibits on the cast sharp-edged ribs.

¹ Upper Bajocian to Oxfordian; Western Europe, Balin and Koscielec near Krakow (G. C. Laube, 'Die Bivalven des braunen Jura von Balin.' Denkschr. d. Akad. d. Wiss. Wien, vol. XXVII. p. 13 [21], gives only *Lima duplicata* Sow. sp. From Laube's list of synonyms, it is evident that he also classes *Limea duplicata* Goldfuss with this species. At Balin and Koscielec occur both *Lima duplicata* and *Limea duplicata*), Popielany in Lithuania, the island of Andö, Central Russia, Novaya Zemlya, Cape Stewart in East Greenland.

² Murchison, Verneuil et Keyserling, 'Géologie de la Russie,' vol. II. Paléontologie, p. 477, pl. XLII. fig. 5, 6, 7.

³ B. Lundgreen, 'Bemerkungen über die von der Schwedischen Expedition nach Spitzbergen 1832 gesammelten Jura- und Trias-Fossilien.' Bihang till K. Svenska Vet.-Akad. Handl. vol. 8, No. 12, p. 18, pl. 2, fig. 10.

Limea cf. *duplicata* Goldf. was found in grey, clayey sandstone, on July 16th, 1896, 500—550 ft. above the sea, north of Elmwood.

LEDA, Schumacher.

Leda cf. *Nuda* Keys. sp.

Letterpress fig. 11.

1846. *Nucula nuda* Keyserling, in A. Graf Keyserling und P. von Krusenstern, 'Wissenschaftliche Beobachtungen auf einer Reise in das Petschora-Land im Jahre 1843,' Petersburg, 1846, p. 307, pl. 17, figs. 7—9.

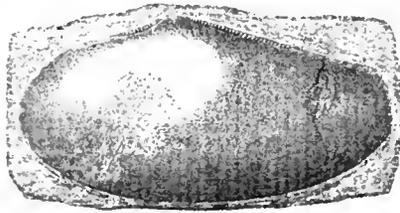

Fig. 11. *Leda* cf. *nuda* Keys. sp. Cast of the left valve showing the impressions of cardinal denticulation.
2 × enlarged.

The cast here figured of a flat, elongated left valve, agrees very well in outline and in dimensions (length circ. 25 mm., height circ. 12 mm.) with the *Leda* (not *Nucula*) *nuda* found by Count Keyserling at the mouth of the Ischma, and at Poluschino in Petschora Land. Count Keyserling states that the cardo denticles in his species are very long and numerous — more

than 16 along the posterior margin. In the present form, the impressions of more than 30 hinge denticles may be counted behind the umbo. This difference prevents me from directly identifying our specimen with the species described from Petschora Land.

Leda nuda Keys. sp. is also recorded by Lindström¹ and Lundgreen² from Spitzbergen. From Lindström's figure, however, it appears to be doubtful whether this species really also occurs in Spitzbergen. Lindström's *Leda nuda* shows a very much more sharply projecting umbo.

Leda (Nucula) Phillipsi Morris³ from the Oxford Clay of Wiltshire, and

¹ G. Lindström, 'Om Trias- och Juraforsteningar från Spitzbergen'. K. Svensk. Vetensk. Akad. Handl. vol. 6, 1865, p. 12, pl. II. fig. 16 (compare reference to *Nucula nuda* Phillips, 'Geology of Yorkshire.' I. pl. V. fig. 5).

² B. Lundgreen, 'Bemerkungen über die von der schwedischen Expedition nach Spitzbergen 1882 gesammelten Jura- und Trias-Fossilien'. Bihang till K. Svenska Vetensk.-Akad. Handl. vol. 8, No. 12, p. 12.

³ J. Morris, 'List of Organic Remains etc.' in R. N. Mantell, 'An Account of the Strata and Organic Remains exposed in the Cuttings of the Branch Railway, . . . etc. . . Wiltshire'. Quart. Journ. Geol. Soc. London, 1850, p. 318, pl. XXX. fig. 1.

Leda de Geeri Lundgreen¹ from Spitzbergen, are very similar to our form in outward appearance, differing, however, in their shorter length.

Leda cf. nuda Keys. sp. is embedded, together with *Cadoceras* sp. ex. aff. *Cad. Nanseni* (n. sp.), in a piece of rusty brown, weathered clay sandstone. The piece was found loose on July 12th, 1896, near the margin of the glacier north west of Elmwood.

CUCULLÆA, Lamarck.

SUB-GEN. MACRODON, LYCETT.

Macrodon Schourovski F. Rouillier sp.

Pl. I. fig. 17.

1847. *Cucullæa Schourovskii* F. Rouillier, 'Études progressives sur la Paléontologie des environs de Moscou'. II Et. Bull. de la Soc. Impér. des Natural. de Moscou, 1847, I. 2, p. 428, pl. H, fig. 39.

The figured cast (with fragments of shell) of a right valve, agrees perfectly in its outline, in the position of the apex, and in the sculpturing (fine concentric lines), with the species figured by Rouillier from his "seconde étage" of the Jura of Moscow, as *Cucullæa Schourovski*. The edge running, in the drawing, from the umbo to the lower posterior angle, and the depression extending from the apex to the inferior margin, has only been produced by oblique pressure of the valve. In uncompressed specimens, this edge and depression do not exist, as I was able to convince myself by a second, unfortunately in other respects more imperfect piece. In this second specimen, remains of the cardo may be recognised — in front of the apex are oblique, not very short, behind the apex long, almost perfectly horizontal lateral denticles, with distinct, close serrations.

Unfortunately, Rouillier has not drawn the hinge in his figures. Judging from the hinge-line visible in fig. 39b (l. c.), Rouillier's species is either a *Cucullæa*, or a *Macrodon*. Trautschold² places Rouillier's *Cucullæa Schourovskii* with *Cucullæa elongata* Sow.³, that is to say, in the sub-genus *Macrodon*. As the cardo of the pieces from Cape Flora now before me has thus proved to be a *Macrodon cardo*, and as the pieces agree perfectly in form

¹ B. Lundgreen, l. c. p. 13, pl. 2, figs. 3 & 4.

² H. Trautschold, 'Der Moskauer Jura verglichen mit der Westeuropäischen'. Zeitsch. d. Deutsch. geol. Ges. 1861, p. 408.

³ Sowerby, 'Mineral Conchology', pl. 447, fig. 1.

and sculpturing with the Russian species *Cucullæa (Macrodon) Schourovskii* F. Rouillier, I do not hesitate to identify the pieces before me with the species figured by Rouillier.

In classing our species and *Cucullæa elongata* Sow. among the Macrodon's, it must be observed that on account of the longer and less vertical anterior lateral teeth¹, this species differs somewhat from the type of the genus Macrodon (*M. Hirsonense* Lyc. *Keyserlingi* Lah. *Rouillieri* Trautsch.), and approaches nearer to Cucullæa.

Macrodon Schourovski F. Rouillier sp. is embedded in grey, rusty brown clay sandstone. Both pieces were found loose, the piece figured on Pl. I. fig. 17, at a height of circ. 500—550 feet north of Elmwood, the other on July 12th, 1896, near the margin of the glacier, north west of Elmwood.

In addition to the fragments of Lamellibranchiata here described, a piece of clay sandstone with *Cadoceras* sp. indet (July 16th, 1896, 500—550 feet above the sea, north of Elmwood) contains a fragment of a

Lima sp. indet. (Pl. II. fig. 8a), whose shell-sculpturing consists of very fine, close radial ribs.

Among the numerous bivalve fragments occurring together with *Pseudomonotis Jacksoni* in hard, grey, sandy marl (Aug. 2nd, 1896, 30 ft above the sea, north west of Elmwood), certain pieces point towards the genus *Pleuromya*. This, however, cannot be settled with any certainty.

GASTROPODA.

AMBERLEYA, Morr. and Lyc.

Amberleya sp.

Letterpress fig. 12.

In the material collected at Cape Flora Gastropoda are represented by a single specimen only, belonging to the genus *Amberleya*, Morr. and Lyc.

The last whorl is broken off and the outer layers of the shell are lacking, therefore specific determination of the specimen is impossible. The side of the (last preserved) whorl bears three rounded, obtuse, spiral keels, which — as far as can be seen on the imperfect remains of the outer layers of the shell — had been crossed by (squamous?) radial striæ (fig. 12 b). A fourth

¹ And also because the height of the shell is the same in front of, and behind the umbo.

keel becomes visible in the suture of the following whorl. Base of the whorls ornamented with smaller keels. Aperture of the (last preserved) whorl rounded, somewhat greater in height than width (fig. 12 a).

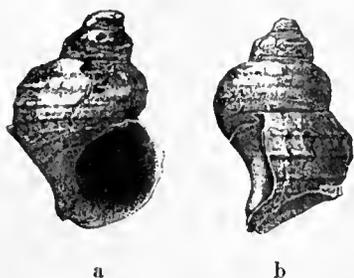

Fig. 12. *Amberleya* sp. nat. size.

Amberleya sp. belongs to the group of *Amberleya capitanea* Münster. sp. The occurrence of this group in jurassic deposits of arctic regions is already noted by Tullberg (*Turbo capitaneus* from the Oxfordian of Besimennaja Bay, Novaja Semlja).

The specimen described was found at the margin of the glacier, 80—100 ft. above the sea, north-west of Elmwood, on July 12th, 1896. As no remains of the rock, where the shell originally was embedded, are preserved, *Amberleya* sp. might have been washed out from the soft clay, which constitutes the greater part of the strata underlying the basalt at Cape Flora.

CEPHALOPODA.

AMMONOIDEA.

Judging from the number of species and individuals, Ammonites are the group of animals most largely represented among the fossils collected at Cape Flora.

The material before me shows that the different rock-types from the neighbourhood of Cape Flora are, in varied degrees, rich in ammonites. While ammonite fragments occur very often in the pieces of clay sandstone, clay, and stone marl, I found no trace of ammonites in the hard, finely-grained, very sandy marl No. 4 containing numerous lamellibranchiate, brachiopod, and belemnite fragments. From this fact, however, it cannot without hesitation be asserted that this rock is entirely destitute of ammonites. Newton¹ mentions a fragment of an undetermined ammonite ("allied to *A. Gowerianus*"), which was found among the loose fossils weathered out of the strata "west of Elmwood", where this rock occurs in place at an inconsiderable height above sea-level. Possibly this ammonite fragment originated in the sandy, hard marl.

¹ E. T. Newton and J. J. H. Teall, l. c. p. 502.

Among the material collected by Prof. Nansen, three genera of ammonites may be pointed out — *Macrocephalites* v. Sutner, *Cadoceras* Fischer, and *Quenstedtoceras* (Hyatt) Nikitin. If Newton's designation of the above-mentioned fragment is correct, a fourth genus, *Cosmoceras* Waagen (sub-gen. *Kepplerites* Neum.), is further represented in the Jura of the neighbourhood of Cape Flora.

MACROCEPHALITES, v. Sutner.

GROUP OF MACROCEPHALITES ISHMAE Keys. sp.

*Macrocephalites Kœttlitz*¹ n. sp.

Pl. II. fig. 12 a—e.

Letterpress fig. 12.

There is only one, to some extent weathered cast preserving small fragments of the shell. It belongs to a form with a very narrow umbilicus, and almost completely encircling whorls, and exhibiting the following dimensions:

Diameter	60 mm.	=	1.
Width of the umbilicus	7	„	=	0.12.
Height	} of the last	30 mm.	=	0.50.
Thickness	} whorl	34	„	= 0.57.

On the flanks, and on the external surface, the whorls are broadly convex, while they incline steep and suddenly towards the umbilicus. At the last two whorls the thickness is somewhat greater than their height. The greatest thickness is at a point a little below half the height of the whorls. The section of the whorls is approximately horse-shoe shaped. The inner whorls encroach so largely upon the succeeding ones that the height of the outer whorls, measured in the median plane, is less than half the height of the entire whorl.

The umbilicus is very narrow (12% of the diameter) and deep, with almost vertical walls. In the umbilicus nothing is to be seen of the inner whorls but the steep umbilical surface.

¹ Named in honour of Dr. Reginald Kœttlitz, member of the Jackson-Harmsworth Expedition, merited by his most valuable researches of the geology of Franz Josef Land, and especially of Cape Flora.

Only a little of the sculpturing has been preserved. Up to a size of about 50 mm. in diameter the whorls are ornamented with strong ribs extending over the flanks in broad curves, open towards the front. The outside is crossed by the ribs in broad curves, convex towards the front. The ribs that have been preserved fork at about half the height of the whorls. Upon the umbilical surface the ribs are scarcely indicated; upon the lower half of the whorl they are rather distinct, and comparatively narrow. After bifurcating, the ribs become lower, broader, and have a more rounded cross-section.

The ribs, as before mentioned, are only found to a size of 50 mm. in diameter. Subsequently their place is taken by perfectly flat, scarcely perceptible lines. The whorls become quite smooth, or nearly so, as we see on the anterior of the specimen before us, which is partly covered with the shell.

Only a very small fragment of the body-chamber was preserved.



Fig. 12. *Macrocephalites Kaettlitzii* n. sp.

Lobe-line as far as to the 2nd lateral lobe; the first lateral saddle is somewhat weathered. Nat. size.

The lobe-line was only to some extent distinctly visible. Lobes and saddles are much and deeply cleft. The siphonal lobe is deep; its slender branches run parallel. The tripartite first lateral lobe is only slightly deeper than the siphonal lobe, and the second lateral lobe a little shorter. The deeply cleft external saddle is divided by a very deep secondary lobe into two unequal parts, one broader outer part, and one narrower inner part. The first lateral saddle is lower

than the external saddle, and the succeeding, badly preserved saddles are low, broad, and bipartite. The auxiliary lobes (3) are narrow and short.

To judge from the substance filling the body chamber and the umbilicus, the piece evidently originated in the hard, gray-brown, phosphoric clay, found on July 14th, 400 feet above the sea-level; Windy Gully north-east of Elmwood.

Remarks. The very narrow umbilicus, the form and curvature of the ribs and the lobe-line mark *Macrocephalites Kaettlitzii* n. sp. as being allied to *Macrocephalites Ishmae* Keys. sp.¹

¹ A. Graf Keyserling (and P. von Krusenstern), 'Wissenschaftliche Beobachtungen auf einer Reise in das Petschora Land im Jahre 1843', St. Petersburg, 1846, p. 331, pl. XX, figs. 8-10, pl. XXII, fig. 15.

The chief lobes and saddles in particular agree very well with those of the species described from the Ishma in Northern Russia. The drawing, however, which Count Keyserling gives of the lobes of his *Amm. Ishmae* (l. c. Pl. 22 fig. 15) shows a very different character. I was nevertheless able to convince myself that the drawing in question is inaccurate. A splendidly preserved specimen of *Macrocephalites Ishmae* from Petschora Land, that I examined, shows a lobe-line, which, up to the second lateral lobe, agrees perfectly with the above drawing of the lobe-line of *Macrocephalites Kættlitzii* n. sp. (On this piece also, the auxiliary lobes are distinct.) The species in question differs from *Macrocephalites Ishmae*:

1. In the form of the whorls. In *Macrocephalites Ishmae*, the height of the whorls is greater than their width, the whorls are more slender, and that to at a size corresponding to that of the specimen of *Macrocephalites Kættlitzii* before us.

2. In the sculpturing. Even in large specimens *Macrocephalites Ishmae* is coarsely ribbed. The specimen examined by me still showed quite distinct ribs up to a diameter of 105 mm., while *Macrocephalites Kættlitzii* loses the ribs as early as at 50 mm.

From Windy Gully, north-east of Elmwood, Cape Flora, Newton described¹ several ammonites as varieties of *Amm. (Macrocephalites) Ishmae* Keys. Of these ammonites the "smooth variety" might agree with the species before us; (l. c.) the outer whorl of a small specimen is stated to be "nearly smooth". The drawing of this form (l. c. Pl. XL. fig. 3) shows another section than our fig. 12b on Pl. II, but we must not forget, that the drawing given by Newton contains no accurate profile of the whorls. The inner whorls in this specimen are not bisected in the plane of the greatest diameter.

Newton's fig. 1 shows a coarse sculpturing at a diameter of about 70 mm.; and not until then does the whorl begin to become smooth; but whether the smoothness of the whorl beginning there is due to weathering of the piece in question, or whether it corresponds with an actual disappearance of the sculpturing, Newton does not say. At any rate, fig. 1 of Newton's *Amm. (Macrocephalites) Ishmae* Keys. *var. arcticus* is more closely allied to the

¹ E. T. Newton and J. J. H. Teall, l. c. p. 500, pl. XL.

type of the species described by Count Keyserling, than to our *Macrocephalites Koettlitzii* n. sp.

When Newton points out that in his *Amm. Ishmae* Keys. var. *arcticus*, the inner whorl "encroaches more upon the outer one" than in *Macrocephalites Ishmae* Keys., this is a mistake, for in Newton's var. *arcticus* the encroachment is the same as in the one figured by Count Keyserling and in the specimen of *Macrocephalites Ishmae* Keys. examined by me. In all these pieces the encroachment is somewhat smaller than in the above described species of *Macrocephalites Koettlitzii* n. sp.

The proportion of the diameter (a) to the entire height of the whorl (b) and to the height of the whorl in the median-plane (c) is in

	a	b	c
<i>Macrocephalites Ishmae</i> Keys sp.	100:	53:	24.
" "	100:	52:	22.
" " var. <i>arcticus</i> Newt.	100:	49:	24.
" <i>Koettlitzii</i> n. sp.	100:	50:	21.

The slight differences in the above-mentioned proportions of the various forms would be of little value, if these differences were not at the same time combined with differences in sculpturing. The fact that the whorls so soon become smooth, distinctly characterises *Macrocephalites Koettlitzii*.

From the character of the sculpturing, the "inflated variety" of *Amm. (Macrocephalites) Ishmae* Keys. (var. *arcticus*) Newton (l. c. p. 501, Pl. XL. fig. 2.) is not allied to *Macrocephalites Ishmae* Keys. at all. The above-mentioned form belongs to *Macrocephalites pila* Nik.¹

Macrocephalites sp.

Pl. II. fig. 11. Letterpress fig. 13.

The fragment here delineated of a chambered whorl, belongs to the young form of a *Macrocephalites* that still has a wide umbilicus.

The whorl is more broad than high. The low convex flanks pass into the broadly convex external side without a break. The flanks incline towards the umbilicus in a steep curve.

From the umbilicus issue strong primary ribs (upon the fragment preserved there are eight), generally maintaining a radial direction. Near the

¹ S. Nikitin, 'Der Jura der Umgegend von Elatma', part 1. Nouv. Mém. de la Soc. imp. des Nat. de Moscou, vol. XIV. 1881, p. 11, pl. VIII. (X) figs 45. 46.

umbilicus, the ribs describe a short umbonal curve; up to half the height of the whorls, they lean a little. Hence the ribs describe a flat curve, concave towards the front. Across the outside they run straight, or are almost imperceptibly bent forward. Long and short secondary ribs are interpolated from the outside. At about half the height of the whorls they meet the primary ribs, or they stop short near the primary ribs. Through the interposition of the secondary ribs, most of the primary appear to be bifurcate. Where the secondary ribs commence, the primary are particularly strong, and on well-preserved shells almost sharp-edged.

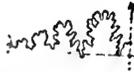

Fig. 13. *Macrocephalites* sp. Lobe-line of Pl. II, fig. 11. 2 × enlarged.

The adjacent lobe-line is a perfect representation of a greatly simplified lobe-line of *Macrocephalites Koettlitzii* n. sp. (cf. p. 71 letterpress fig. 12.) The first lateral saddle, and both the succeeding small saddles, are bipartite, and the lobes tripartite.

Remarks. Judging from the lobe-line, the piece figured very probably belongs to a young form of *Macrocephalites Koettlitzii* n. sp., or to the varieties of *Macrocephalites Ishmae* Keys. sp. described by Newton from Windy Gully. As the early stages both of this form, and of *Macrocephalites Ishmae* Keys. sp. are not known, the piece before us cannot be specifically determined.

Apart from the resemblance of its lobe-line to that of *Macrocephalites Koettlitzii*, it is clear that the figured piece is a *Macrocephalites*, from the character of the sculpturing on the doubly curved primary ribs.

The same general character is to be observed in the sculpturing in young forms of *Macrocephalites macrocephalus* Schloth. sp., *Herveyi* Sow. sp., *tumidum* Rein sp. etc. from the Callovien of Suabia and Franconia, and moreover, in the young specimen of a *Macrocephalites pila*. Nik. from Czenstochau in Poland¹, of which Bukowski gives an illustration. The same character is also to be seen in the sculpturing of the numerous young specimens of *Macrocephalites*, which Waagen describes from the Jura of Kutch in India. It is worthy of remark in all these young forms, that the young specimens of Waagen's group of "*Macrocephali Rectecostati*" also *always* have *curved* ribs.

¹ Gejza Bukowski, 'Über die Jurabildungen von Czenstochau in Polen. Beiträge zur Palaeontologie Oesterreich-Ungarns etc. 1887', vol. V. pl. XXVI. (II) fig. 17.

In spite of the resemblance in the formation of the sculpturing, and in the double curve of the ribs in our form and in young forms of the *Macrocephalites macrocephalus* Schloth. sp., the piece before us cannot be referred to this species itself, nor to the species nearly allied to it (*Herveyi* Sow. sp. *tumidum* Rein. sp. *Pila* Nik.). In the young form of all these species, the ribs are considerably finer and closer, and furthermore the whorls of a corresponding size in these species are broader and lower. The lobe-line, moreover, in the above-named species, has a more slender external saddle, which does not exceed the first lateral saddle in size as much as in the present form from Cape Flora.

The figured fragment of *Macrocephalites* sp. was found loose without any adhering rock — on July 12th, 1896, near the margin of the glacier, north-west of Elmwood. It is a cast of pyrite turned into brown ironstone, with an almost perfect nacreous shell.

CADOCERAS, Fischer.

In the ammonites before us, the genus *Cadoceras* is the one most abundantly represented, both as regards the number of species, and the number of specimens. There are, with few exceptions, only specimens of inconsiderable size, and these are generally greatly deformed by compression, especially of the body chambers. Frequently nothing but impressions of the different species remain.

Juvenile forms of *Cadoceras* have hitherto been somewhat neglected in ammonite literature. For the determination of young forms such as these we are limited almost entirely to the works by Nikitin on Russian Cephalopoda. This author, however, gives comparatively little attention to the *development* of the juvenile forms, of the sculpturing and the lobe-lines. From Nikitin's descriptions, and from the diagrams given in the description of the Cephalopoda of Elatma, it would appear that the young stages of nearly all Russian *Cadocerates* are almost identical.

The descriptions of young forms from the Jura of Central and Western Europe are still more imperfect than the descriptions of those of Russian *Cadoceras*. As far as I know, no young stages of *Cadoceras* species from strata of Central and Western Europe have hitherto been described, with the exception of the very imperfect accounts in Sowerby's *Amm. sublævis*. In one of

the small forms, which he designates *Amm. Königii* Sow., Quenstedt¹ states that it may perhaps be a young form of his *Amm. sublævis* (under which name several *Cadoceras* species are comprised, but none of them identical with *Amm. sublævis* Sow.) These small ammonites, however, are neither young forms of the species comprised in *Amm. sublævis* Quenst. nor do they belong to the genus *Cadoceras* at all. They belong to the specimens designated by Quenstedt as *Amm. Königii* Sow.², and are probably identical with the species described by Morris and Lycett³ as a young form of *Amm. subcontractus* Morr. a. Lycett. These are forms with peculiar, irregularly divided ribs, and much undulated on the outside, which have to some extent very distinct parabolic lines and nodes. From their form, sculpturing and lobe-line, these ammonites — together with an undescribed species now before me from Lower Bavaria — cannot be designated as *Cadoceras*; they ought rather to be regarded as a new, hitherto not particularly characterised group of the *Stephanoceratidæ*.

The very sensible deficiency in the ammonite literature, in the present case was fortunately, to some extent, made up by the rich treasures of the Munich Museum. I succeeded in obtaining the innermost whorls of, in some cases very early stages of a large number of species:

Cadoceras sublæve Quenst. sp. (now Sow. sp.) — from the Suabian Jura.

„	<i>Tchefkini</i> d'Orb sp.	} from the Russian Jura,
„	<i>Milaschewici</i> Nik.	
„	<i>Elatmae</i> Nik.	
„	<i>Frearsi</i> (d'Orb) Nik.	
„	<i>sublæve</i> Sow. sp.	} from the English Jura.
„	<i>modiolare</i> d'Orb sp.	

Only by the help of this material was it possible to determine the *Cadoceras* from Franz Josef Land that I have before me. At the same time,

¹ F. A. Quenstedt, 'Ammoniten des Schwäbischen Jura.' p. 674, pl. 72, figs 9—15, especially fig. 10.

² F. A. Quenstedt, l. c. pl. 87, figs. 31, 32—7. I Siemiradzki (O mieczakach glowonogich brunatnego jura W. Popielanach, etc. Cracow, 1889, p. 6.) designates both these pieces as *Quenstedtoceras carinatum* Eichw. sp. Form, sculpturing and lobe-line absolutely preclude the possibility of regarding these specimens as juvenile forms of Eichwald's *Amm. carinatus*.

³ Morris and Lycett, 'Monograph of the Mollusca from the Great Oolite,' p. 11, pl. II. fig. 2.

the examination of the young whorls of the above-named species, proved that in the early stages of even closely-allied species, distinguishing features in the formation of the sculpturing and of the lobe-line, furthermore in the proportions of growth, may be more accurately observed and determined than appears from the works of Nikitin.

According to the statements of the contributors to the English Geological Survey¹ only one species of *Cadoceras* occurs in the "Kellaways Rock" (and Oxford Clay) of England. In the official reports this species is designated *Cadoceras modiolare* Luid. sp.² and to it is added *Amm. sublævis* Sow. sp.³ as a synonym. The collection of Cadocerates from Wiltshire, now before me, shows that various species occur, differently developed from their early stages. It is also probable that Luidius's "*Nautilites modiolaris*" from "Kellaway Bridge in Wiltonia" may be found among these forms, but owing to the imperfect description which Luidius gave of his ammonite, it cannot be decided, which of the forms in question should be called by the name he created. The specific name "*modiolaris*" being moreover, employed by d'Orbigny and Nikitin for two different and easily recognisable species, I consider it better to drop the specific designation "*modiolaris* Luid." and to go back principally to Sowerby's descriptions for the designation of the English species from the Kellaways Rock and Oxford Clay.

In the English materials of Cadocerates the following forms may be distinguished:

1. A species, slender at an early stage, with a narrow umbilicus, closely-encircling whorls, narrow external surface and falciform ribs⁴. The advanced stage of this form, which, even when full-grown, has a very narrow umbilicus, is shown in the large specimen figured by Sowerby (l. c. Pl. 54). To *this* form I confine the name *Amm. (Cadoceras) sublævis* Sow.
2. Young forms with thicker and somewhat convex whorls, and a broader

¹ 'The Jurassic Rocks of Britain', vol. I. pp. 277, 279, vol. II. p. 242, vol. V. p. 11, 361.

² E. Luidius 'Lithophylæii Britannici Ichnographia'. p. 18, pl. IV. fig. 292.

³ J. Sowerby, 'Mineral Conchology of Great Britain', vol. I. p. 117, pl. 54.

⁴ According to Newton's report (E. T. Newton and J. J. H. Teall, l. c. p. 497) young forms like these are classed in English museums as a variety of *Amm. (Quenstedtoceras) Marieæ* d'Orb.

external side with coarser, less curved ribs. The advanced stage of this form has been illustrated by d'Orbigny¹ as *Amm. modiolaris*. In the above-mentioned publications of the English Geological Survey, this form has been delineated as *Amm. modiolaris* Luid. The full-grown specimens of this species differ from those of *Cadoceras sublæve* Sow. sp. in having a wider umbilicus, and the whorls being in transverse direction less closely encircling, and hence lower (with a coarser sculpturing in the medium stages of growth). This second species of the English Jura I designate *Amm. (Cadoceras) modiolaris* d'Orb.

3. Nikitin² reports that he has observed *Cadoceras Tchekini* d'Orb. sp. from the English Kellaways Rock in English museums.
4. Yet another form of Cadocerates from the Wiltshire Kellaways Rock — n. sp. indet. — is before me. Up to a diameter of 60 mm. it is characterised by remarkably flat whorls, with a narrow umbilicus and close-set fine ribs with a decided flexure forwards. From its outward shape, it should be placed between *Cad. sublæve* Sow. sp. and *Cad. stenolobum* (Keys.) Nik.

The two first-named species are the Western European representatives of two large groups of Cadocerates, which, especially in the Russian Callovien attain a particularly high degree of development,

Upon *Cadoceras sublæve* Sow. sp. follow all those forms which are characterised in their earlier stages by a narrow umbilicus and high-mouthed whorls with fine falciform ribs. Even in advanced stages these forms generally have a narrow umbilicus, e. g.:

Cadoceras n. sp. indet. (No. 4 on p. 72).

- „ n. sp. indet., a similar form from the "Ornatenthon" of Suabia.
- „ *Seebachi* Behr. (*Amm. sublaevis* v. Seeb.)³
- „ *placenta* (Bean, m-s.) Leck. sp.
- „ *Tchekini* d'Orb. sp.
- „ *Wosnessenski* Grew.
- „ *stenolobum* (Keys.) Nik.
- „ *Nanseni* n. sp. (see below)

¹ A. d'Orbigny, 'Paléontologie française'. Terr. jur. I. p. 468, pl. 170.

² Bulletin de la Soc. Belg. de Géologie etc. vol. III. p. 34.

³ Different allied forms, yet undescribed, occur in the "Ornatenthon" of north western Germany, as I have seen in the Göttingen Museum.

Cadoceras Milashevici Nik. (= *compressum* Nik.)

„ *patruum* Eichw. sp.

„ *galdrinum* d'Orb. sp.(?)

From the two most important species I designate this *group* as that of “*Cadoceras sublæve* Sow. sp. and *Tchefkini* d'Orb. sp”.

A series of other species is closely allied to *Cadoceras modiolare* d'Orb. sp. being characterised in their earlier stages by thicker whorls with a wider umbilicus, and generally coarser and less distinctly falciform ribs. At more advanced stages of growth also, coarser ribs and a wider umbilicus remain characteristic of these species:

Amm. sublævis macrocephali Quenstedt (Cephalopoden p. 177, Pl. 14, fig. 6.)

„ „ Quenstedt (Amm. d. Schwäb Jura Pl. 79, figs. 2, 3, 4.)

Amm. sublævis Quenstedt (l. c. Pl. 79, fig. 5) according to Nikitin an intermediate form between *Cadoceras Frearsi* d'Orb. sp. and *Surense* Nik.

Amm. sublævis Quenstedt (l. c. Pl. 79, fig. 6.) = *Cadoceras modiolare* Nik.

this species is entirely different from *Cad. modiolare* d'Orb. sp., as the ribs become very broad even at an early stage.

Amm. sublævis Quenstedt. (l. c. Pl. 79, fig. 7.) = *Cadoceras* cf. *modiolare* Nik.

Furthermore they are joined by the kindred species of *Cadoceras Elatmae* Nik. from the Russian Jura:

Cadoceras Elatmae Nik.

„ *Frearsi* (d'Orb.) Nik.

„ *modiolare* Nik. non d'Orb. sp.

„ *Surense* Nik.

To these belongs perhaps also *Cadoceras sublæve* E. Desl.¹ non Sow. sp. from the Lamberti strata of Villers-sur-mer, with a rather narrow umbilicus. From the most important species, this *group* may be designated as the *Cadoceras modiolare* d'Orb. sp. and *Elatmae* Nik.² Group. Both these briefly sketched groups are also represented in the collection of Cadocerates from Cape Flora, now before me.

¹ E. E. Deslongchamps, 'Rapport sur les Fossiles oxfordiens de la collection farry' Bull d. l. Soc. Linnéenne de Normandie, 1889, (Extr.) p. 26, pl. I. figs. 1-4

² Owing to the scarcity of material, I was not able to determine to which group *Cad. subpatruum* Nik. *Schumarowi* Nik. ought to be referred.

GROUP OF CADOCERAS SUBLAEVE SOW. SP. AND TCHEFKINI D'ORB. SP.

Cadoceras Tchekini d'Orb sp.

Pl. II. fig. 7. Letterpress fig. 14, 15.

1845. (44) *Ammonites Tchekini* A. d'Orbigny; Murchison, Verneuil et Keyserling, 'Géologie de la Russie. Vol. II. Paléontologie', p. 439, pl. XXXV. figs. 10—15.
1846. *Ammonites Tchekini* A. Keyserling; Krusenstern und Keyserling, 'Wissenschaftliche Beobachtungen auf einer Reise in das Petschora Land', p. 329, pl. XX. fig. 6; pl. XXII. figs. 11—12.
1878. *Amaltheus Tchekini* S. Nikitin, 'Ammonitengruppe des Amaltheus funiferus'. Bull. de la Soc. impér. des Natural. de Moscou, vol. L III. 2, p. 132, fig. 11.
1881. *Stephanoceras Tchekini* S. Nikitin, 'Die Juraablagerungen zwischen Rybinsk, Mologa und Myschkin an der oberen Wolga'. Mém. de l'acad. impér. des Sc. de St. Pétersbourg, sér. VII. vol. XXVIII. No. 1, p. 64, pl. III. figs. 21—24.
1881. *Stephanoceras Tscheckini* S. Nikitin, 'Der Jura der Umgegend von Elatma Lfg. 1.' Nouv. Mém. de la Soc. impér. des Natural. de Moscou, vol. XIV. p. 38.
1883. *Stephanoceras Tchekini* J. Lahusen, 'Die Fauna der jurassischen Bildungen des Rjasanschen Gouvernements'. Mém. du com. géol. St. Pétersbourg. Vol. I. No. 1. p. 52.
1884. *Cadoceras Tchekini* S. Nikitin, 'Allgemeine geologische Karte von Russland. Blatt 56 (Jaroslawl, etc.)' Mém. du Com. géol. St. Pétersbourg, vol. I. No. 2, pp. 68, 142, 145, pl. III. fig. 15.
1884. *Cadoceras Tchekini* S. Nikitin, 'Die Cephalopodenfauna der Jura-bildungen des Gouvernements Kostroma'. Verhandl. d. K. Mineralog. Ges. St. Petersburg, vol. XX. 1885, p. 22.
1885. *Cadoceras Tchekini* S. Nikitin, 'Der Jura der Umgegend von Elatma. Lfg. 2.' Nouv. mém. de la Soc. impér. des Natural. de Moscou, vol. XV. p. 22.

1897. *Ammonites (Cadoceras) Tchekkini* d'Orb.? E. T. Newton and J. J. H. Teall, l. c. Quart. Journ. Geol. Soc. London, vol. 53, p. 496, e. p. pl. XXXIX. fig. 5. (not fig. 4 and 6).
1897. *Ammonites (Cadoceras) modiolaris* Luid. E. T. Newton and J. J. H. Teall, l. c. Quart. Journ. Geol. Soc. London, vol. 53, p. 497, e. p. pl. XXXIX. figs. 7, 8 (not figs. 9 and 10).

The species so widely spread in the middle Callovian of Russia is represented in the material collected by Prof. Nansen at Cape Flora, besides the figured specimen by a number of impressions of young and by two fragments of body chambers, most probably to be classed here.

The well preserved specimen — Pl. II. fig. 7 — broke so favourably, in being prepared, that it permits of a considerably more accurate description of the young whorls of this important species than has hitherto been given by d'Orbigny and Nikitin.

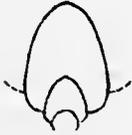

Fig. 14.
Cadoceras
Tchekkini d'Orb.
sp. Diagram of
Pl. II. fig. 7;
nat. size.

The young whorls — up to a diameter of 40 mm — are moderately convex, and very involute. Four fifths of the height of each whorl is covered by the next whorl. On account of the great involution, the umbilicus is very narrow and comparatively deep. (conf. the accompanying diagram).

The specimen figured on Pl. II. fig. 7 shows at a diameter of 30 mm. the following dimensions:

Diameter:	30 mm.	=	1.
Width of the umbilicus	5·4 "		=	0·18.
Height	} of the last 15 "		=	0·50.
Thickness	} whorl	13 "	=	0·43.

These measurements correspond to the young specimen of *Cadoceras Tchekkini* which Nikitin in 1881 figured¹ from the Jura of the Upper Volga (Rybinsk, etc.).

The section of the innermost whorls — up to a diameter of about 10 mm. — is thick, shortly oval. At a diameter of about 20—25 mm., the section becomes higher. The greatest thickness of the whorl is then at about half its height. Towards the exterior the transverse section of the whorl becomes smaller. The outside is narrow but rounded².

¹ l. c. pl. III. fig. 23.

² As in the illustration given by d'Orbigny: l. c. pl. XXXV. fig. 11.

The whorls gradually grow broader. At a diameter of about 30–35 mm. the previously low wall of the umbilicus becomes higher. The greatest thickness of the whorls is then situated near the umbilicus, and the outside becomes broader. The further development of the form is not to be observed in any of the pieces from Cape Flora before me. In the specimen figured on Pl. II. fig. 7, the fragments of a body chamber pressed quite flat are to be seen.

The innermost whorls, and those up to a diameter of about 6 mm. are smooth and without any sculpturing whatever. Then slight wrinkles with a decided flexure forwards, become visible on the flanks. At a diameter of about 10 mm., the wrinkles on the flanks become more distinct, and at about half the height of the whorls generally bifurcate into two lower, less distinct wrinkles, which, bending slightly forwards, run over the outside. At a size of 15–25 mm. in diameter, the whorl is covered with narrow, rather sharp ribs, distinctly falcate — Pl. II. fig. 7 b —¹; near the outside, the ribs show an especially distinct forward flexure. On the outside, the ribs from both flanks run towards one another at an angle of about 90°; they do not, however, meet at an angle, but in a short curve — Pl. II. fig. 7 c. On the lower half of the whorls, the ribs are somewhat sharper and higher than in the upper half.

Some of the ribs run over the whole whorl without any bifurcation; to some extent, however, secondary ribs from the outside are interposed before or behind a primary rib. At half the height of the whorls, or a little nearer the umbilicus, the secondary ribs meet with the primary ribs, or only approach the latter, and terminate indefinitely. In this way more or less distinctly bifurcated ribs are produced. There is no fixed rule in the distribution of the divided and undivided ribs. If *a* indicates an undivided rib, *b*₁ a divided rib where the secondary rib joins the primary rib from behind, *b*₂ a divided rib where the secondary rib joins the primary rib in front, we have the following formula for the sculpturing on the first half of the last whorl (from 14–20 mm. in diameter) of the specimen figured on

¹ In this point our form agrees better with the figures given by d'Orbigny than with the imperfect illustration by Nikitin, mentioned above.

Pl. II. fig. 7 b: *a*, *b*₁, *b*₂, *a*, *b*₁, *a*, *b*₁, *b*₁, *b*₂, *a*, *a*, *b*₁, *b*_{2a}, *b*₂, *a*, *b*₂. (17 ribs on the umbilicus — 7 entire ribs, 10 bifurcated ribs —, 27 ribs on the outside). At about 30 mm. in diameter, the sickle form disappears. The ribs, almost straight, run across the flanks in a flat curve; near the external side, however, they continue to be much bent forward. At this size the ribs on the wall of the umbilicus begin to become less distinct, no longer radiating from the umbilicus-seam, but beginning somewhat higher.

At 9 mm. of the height of the whorl (about 18 mm. in diameter), the somewhat asymmetrical lobe-line exhibits the development represented in the



Fig. 15. *Cadoceras Tchekfinski* d'Orb. sp.
a) Lobe-line of Pl. II. fig. 7 b, at a height of the whorl of 9 mm. 2 × enlarged.



b) Lobe-line of Pl. II. fig. 7 a, from the 2nd lateral lobe, at a height of the whorl of 16 mm. 2 × enlarged.

letterpress fig. 15 a. The narrowing at the base of the second lateral saddle and of the first auxiliary saddle is worthy of notice. The narrowing becomes still greater, as the growth proceeds, as letterpress fig. 15 b shows, corresponding to the lobe-line of the size with a diameter of 35 mm. The lobe-line — letterpress fig. 15 a b differs from the drawing, which Count Keyserling gives of a young specimen in the greater narrowness of the saddles¹. On the other hand, the letterpress figure 15 b agrees very well with the lobe-line of a specimen of similar size from the Russian Jura (from Rybinsk). The fact that the auxiliary saddles are narrowed to a considerable degree in the present specimens from Cape Flora, is owing to the asymmetry of the lobe-line. The drawing — letterpress fig. 15 a — is taken from the side of the suture, somewhat shortened on account of the asymmetry of the lobe-line; the other side could not be observed².

Of larger specimens of *Cadoceras Tchekfinski*, there are only two fragments of smooth body-chambers among the material collected by Prof. Nansen at Cape Flora. The larger of the two agrees well in its transversely great

¹ Krusenstern and Keyserling: l. c. pl. XXII. fig. 11.

² The second lateral saddle only widens with the commencement of the increased widening of the whorls, and then it shows the form so well figured by Count Keyserling — l. c. pl. XXII. fig. 12. In larger specimens the edge of the umbilicus passes through the second lateral saddle. Even in large specimens the auxiliary saddles remain narrow.

convexity, broad exterior side, and flat flanks with a marked downward flexure with Nikitin's¹ drawing of a *Cadoceras Tchekkini*. It is a fragment corresponding to half the width of the whorl. On both the interior and the exterior sides very faint, flat, broad lines, curving sharply forwards, are visible as the remains of the sculpture, which becomes very indistinct in large specimens². On the outside of the fragment, at its anterior extremity, part of a broad, moderately deep contraction, with a distinct forward flexure has been preserved. *Cadoceras Tchekkini*, like *Cadoceras Elatmae* Nikitin and also like *Cad. sublæve* Sow. sp.³, bears a contraction behind the edge of the mouth.

Among the specimens from Elmwood described and figured by Newton as *Ammonites (Cadoceras) Tchekkini?* d'Orb., the exceedingly involute form with very narrow umbilicus⁴ figured l. c. Pl. XXXIX. fig. 5, is no doubt identical with our specimen⁵.

¹ S. Nikitin, 1881, Rybinsk, etc. pl. III. fig. 21.

² Judging from a large specimen from Rybinsk determined by Nikitin in the Munich Museum, *Cadoceras Tchekkini* does not become quite smooth, as one might think from the drawings of d'Orbigny and Nikitin; but at a more advanced age the ribs lose their distinctness and turn into very faint, flat lines. The decrease in distinctness seems to commence at very different periods in different specimens.

³ According to a large specimen from Wiltshire (Munich Museum).

⁴ In the anterior part of the last whorl, the umbilicus of the above-mentioned specimen suddenly widens, probably through crushing of the piece. — Newton's measurement of the width of the umbilicus — l. c. p. 496 — only agrees as far as the last fifth of the last whorl is concerned. Where the umbilicus is entire, its width agrees with that generally met with in *Cadoceras Tchekkini*.

⁵ Newton's *Amm. (Cad.) Tchekkini?* d'Orb. l. c. pl. XXXIX. fig. 4, agrees in proportions and sculpturing (entire ribs appear to be absent) with *Cadoceras stenolobum* (Keyserl.) Nikitin. *Amm. (Cad.) modiolaris* Newton, Pl. XXXIX. fig. 9, represents a full-grown specimen of this species. The proportions agree in every respect with *C. stenolobum* Nikitin (Der Jura der Umgegend von Elatmae. 1. Pl. V. fig. 29), and the sculpturing too agrees with this species. Newton refers in his fig. 9 to *C. modiolare* Nikitin from the Lower Callovian of Elatma (Nikitin, l. c. 2, pl. XI. fig. 48). In this species as well as in *C. modiolare* Luid. of the English authors (= *C. sublæve* Sow. sp. and *modiolare* d'Orb. sp.), the radial ridges on the umbilical margin, and farther in the primary ribs on the umbilical wall, are distinctly visible. Newton's specimen cannot be made to agree with any of these "modiolaris" species, as the umbilical margins and walls appear smooth until far back. The great width of the umbilicus prevents the reconciling of the piece in question with *C. Tchekkini*; it can therefore only be regarded as *C. stenolobum*.

The differences reported by Newton between his *Ammonites Cadoceras Tchekini* ? d'Orb. and *Cadoceras Tchekini* of d'Orbigny and Nikitin are not differences in distinguishing features of different species but differences in age in different sized specimens of the same species. In full-grown specimens of *Cadoceras Tchekini*, the number of ribs on the exterior side is a considerably larger one than in smaller specimens, a larger number of secondary ribs from the exterior surface being interspersed in the larger specimens than on the whorls of younger stages. Newton is wrong in calling the ribs around the umbilicus in *Cadoceras Tchekini* "distinctly larger than those on the back". In youth and on the shell they are not "larger" around the umbilicus, but *higher* and *sharper*, and towards the external side they become lower and broader. Only in larger specimens — of a diameter of 40 mm. and upwards — and on internal casts, when tripartite ribs appear, do the ribs on the margin of the umbilicus become flatter and somewhat broader.

Among the specimens from Elmwood at Cape Flora, which Newton figures as *Amm. (Cadoceras) modiolaris* Luid., figs. 7 & 8 on Pl. XXXIX. are undoubtedly to be referred to *Cadoceras Tchekini* d'Orb. sp.

If we complete the fragment in figs. 7, 8, which, according to the lobe-line, corresponds almost exactly to half the width of a whorl, we get a cross-section agreeing entirely with the transverse section of a whorl of a large specimen of *Cadoceras Tchekini* as drawn by Nikitin¹.

Moreover the lobe-line of fig. 7 (especially as regards the development of the second lateral saddle), agrees entirely with that of a specimen of *Cadoceras Tchekini* from Rybinsk before me. The lobe-line differs from those, which are to be observed in *Cad. modiolare* Luid. of the English authors (*Cad. subloève* Sow. sp. and *modiolare* d'Orb. sp.), as the latter species of a corresponding size shows a considerably more developed second lateral saddle.

While Newton maintains that the cast of the umbilicus of one of his specimens just fits the umbilicus of "A. modiolaris" from the Kellaways Rock, we maintain in the first place, that among the English Cadocerates Nikitin has also

¹ S. Nikitin: Rybinsk, etc. 1881, pl. III. fig. 21.

demonstrated¹ *Cad. Tchekkini* d'Orb. sp., secondly, that *Cad. sublæve* Sow. has a narrow umbilicus similar to that of *Cad. Tchekkini*, and, that in consequence, this observation of Newton is but of slight importance.

The specimens of *Cadoceras Tchekkini* d'Orb. sp. collected by Prof. Nansen are partly embedded in yellowish-gray clay, of a rusty colour through weathering (Pl. II. fig. 7, several impressions, and the above-mentioned fragments of body-chambers). Most of the specimens were found loose on July 12th 1896, near the margin of the glacier, north west of Elmwood. One fragment of a body-chamber was found at a height of ca. 550 feet, north of Elmwood, and an impression of a small specimen on the talus 100 feet above the sea.

Newton's *Amm. (Cadoceras) Tchekkini* d'Orb. l. c. Pl. XXXIX. fig. 5, was found *in situ* in "clay-sandstone" — at Elmwood, 50 feet below the basalt, consequently at a height of about 550 feet above sea-level.

Cadoceras Nanseni n. sp.

Pl. II. figs. 1—3, 5, 6. Letterpress figs. 16, 17.

1895. "Ammonite nearly resembles some of the varieties of *A. macrocephalus*". E. T. Newton; in A. Montefiore, 'The Jackson-Harmsworth North Polar Expedition. etc.' The Geographical Journal, London, 1895, vol. VI. p. 519.
1897. *Ammonites (Macrocephalites) macrocephalus* Schloth. E. T. Newton; E. T. Newton and J. J. H. Teall, l. c. Quart. Journ. Geol. Soc. London, vol. 53, p. 497, pl. XXXIX. figs. 1, 2.
1897. *Ammonites (Cadoceras) Tchekkini* ? d'Orb. E. T. Newton; E. T. Newton and J. J. H. Teall, l. c. Quart. Journ. Geol. Soc. London, vol. 53, p. 496, c. p. pl. XXXIX. fig. 6.

¹ S. Nikitin, 'Rapports entre les céphalopodes jurassiques russes et les originaux correspondants dans les collections de l'Europe occidentale'. Bull. de la Soc. Belg. de Géologie, etc. 1889, vol. III. p. 34.

1897. *Ammonites (Cadoceras) modiolaris* Luid., "flattened variety".
 E. T. Newton; E. T. Newton and J. J. H. Teall, l.
 c. Quart. Journ. Geol. Soc. London, vol. 53, p. 497,
 pl. XXXIX. fig. 10.

Several young individuals with flattened body-chambers, numerous impressions of young pieces and fragments of a larger specimen cannot be identified with any of the *Cadoceras* species hitherto described. I call the new species after the bold explorer of Franz Josef Land, and beg Prof. Nansen to see in this a token of my gratitude.

Up to a diameter of 30 mm. the Ammonite shows a flat, disc-like growth. The whorls are moderately thick. In cross section they are nearly elliptical, with the greatest width a little below half the height of the whorls. The involution is considerable; more than the half though not quite $\frac{2}{3}$ of the inner whorls are covered by the outer.

In young specimens the umbilicus is rather narrow and not very deep.

The sculpturing consists of closely placed rather sharp ribs, with a forward inclination. They are either in shallow curves, or slightly falciform.



Fig. 16. *Cadoceras Nanseni* n. sp.

a. figured from a wax-cast of an impression, body chamber compressed and broken; nat. size.
 b. constructed diagram.

Near the external side the ribs are somewhat more bent forward. They cross the external side in a broad curve without forming any angle. With regard to the first appearance of sculpturing, the mode of bifurcation of the ribs (interpolation of the secondary ribs from the outside), and the irregular alternation of single and divided ribs, *Cadoceras Nanseni* is similar to *Ca-*

doceras Tchekfkini d'Orb. sp. Pl. II. fig. 3b shows (much enlarged) the sculpture of the innermost whorls; single ribs do not appear until later — see the second half of the last whorl on Pl. II. fig. 3a, fig. 2, 1 and letterpress fig. 16 a.

Occasionally it is to be observed, that a primary rib, issuing from the umbilicus, is replaced at about half the height of the whorls by two secondary ribs rising from the outside, and passing behind and before the primary rib — letterpress fig. 16 a, at the place marked by the arrow.

In larger sizes than those with a 30 mm. diameter, the ribs gradually become coarser, and the intervals wider; the ribs run almost straight across the flanks, with a considerable forward inclination.

Besides the impression of a small specimen, there is a fragment of a large individual, embedded in a fragment of gray, very finely-grained, and sandy hard marl (partly impression) which on account of this simultaneous occurrence must be regarded as an old specimen belonging to the young forms just described. In its sculpturing, this specimen agrees perfectly with that described by Newton — l. c. Pl. XXXIX. fig. 10 — as *Amm. (Cadoceras) modiolaris* Luid., “flattened variety”. Both specimens show that *Cadoceras Nanseni* n. sp. is subject in old age, to the same broadening of the whorls as most of the *Cadoceras* (Exception: *Cad. galdrinum, patrum*). The umbilical margin in this size is broad and obtusely rounded. On the wall of the umbilicus, the primary ribs still go rather close to the umbilical seam; on the flanks the ribs are mostly bifurcated; single ribs or trifurcate ribs are of less frequent occurrence. On the umbilical margin, the ribs are rather sharp but not swollen or coarsely tubercular.

The lobe-line could only be observed in young specimens. It is characterised by narrow lateral and auxiliary saddles. The siphonal lobe is nearly



Fig. 17.

Cadoceras Nanseni n. sp.
Lobe-line of Pl. II, fig. 1,
at a height of the whorl
of 7 mm. 2 × enlarged.

as deep as the tripartite, first lateral lobe. The second lateral lobe is small and short, scarcely extending so far down as the inner branch of the first lateral lobe. There are two narrow, short, auxiliary lobes and also a little denticle near the umbilical seam. The ends of the two lateral lobes and of the auxiliary lobes lie in a line inclining slightly towards the umbilicus. The external saddle is high, broad and obliquely tripartite. The first lateral saddle is unsymme-

trically bipartite, and its larger inner portion is again bipartite. The narrow, second lateral saddle is symmetrically bipartite, as well as the small, first auxiliary saddle.

The lobe line is slightly asymmetrical.

Among the ammonites, which *Newton* described from Franz Josef Land, *Amm. (Macrocephalites) marocephalus* Schloth. (l. c. Pl. XXXIX. fig. 1) may first of all be identified with *Cadoceras Nanseni*. *Newton* calls this specimen (the first ammonite known from Franz Josef Land) "The true *Ammonites macrocephalus*". *Newton* says further in his description: "In these specimens the ribs pass outward from the small umbilicus and after bifurcating run over the back without any forward flexure". *Newton's* figures contradict these words. In *Newton's* fig. 1 the ribs in the first half of the last preserved whorl are distinctly curved, as in the figures of our *Cadoceras Nanseni*. When the ribs in the second half of the last whorl of *Newton's* fig. 1. appear to be straight and arranged radially, this — as is clearly visible in the above-mentioned figure — is due to the fact that the anterior half of the whorl is not intact, but is obliquely compressed. I examined numerous specimens of all sizes of the typical *Macrocephalites macrocephalus* Schloth. sp. (principally from Franconia); and none of them agrees with *Newton's Amm. macrocephalus*. The umbilicus in *Macrocephalites macrocephalus* Schloth. sp. is always narrower, the involution greater than in *Amm. macrocephalus Newton—Cadoceras Nanseni* n. sp. Furthermore, the ribs in *Macrocephalites macrocephalus* Schloth. sp. are always finer and closer together in young forms, always with a forward flexure in the middle, and externally always less distinctly inclined forward than in *Amm. macrocephalus Newton—Cadoceras Nanseni*. It never happens in *Macrocephalites macrocephalus* Schloth. sp. that besides the bifurcate and trifurcate ribs, which always fork after the type mentioned under *Macrocephalites* sp. (cf. p. 68), such a number of single ribs are interpolated as in *Amm. macrocephalus Newton* (in *Newton's* fig. 1, five single ribs in the first half of the last whorl). Single ribs, extending down to the umbilicus, are of the rarest occurrence in the true *Macrocephalites macrocephalus* Schloth. sp. I could only prove their existence in very few young specimens. *Newton's* reference to *Stephanoceras*

macrocephalum Nikitin¹ is incorrect; the umbilicus there is much narrower, the ribs have a more radial direction, and single ribs seem to be altogether absent (l. c. fig. 44 b).

If Newton's figures do not agree with *Macrocephalites macrocephalus* Schloth. sp., they agree perfectly in form and sculpture with *Cadoceras Nanseni* n. sp. here described. This is especially the case with regard to Newton's fig. 1; but Pl. XXXIX. fig. 2 in Newton, might also be identified, from the sculpturing, with our species. The umbilicus in fig. 2 is most probably incorrectly drawn, as also the centre of the umbilicus in fig. 1 (l. c. Pl. XXXIX. fig. 3 with more inflated whorls, Newton only refers, with reservations, to *Amm. macrocephalus*. From the sculpture and the width of the umbilicus, neither can this specimen be referred to *Macrocephalites macrocephalus* Schloth. sp. It is a *Cadoceras* bearing a strong resemblance in its sculpturing to *Cadoceras Nanseni* n. sp., but which, on account of the thicker whorls should rather be regarded as separate [*Cadoceras* sp. indet. Pl. II. fig. 8].)

Amm. (Cadoceras) Tchekkini (d'Orb.) E. T. Newton e. p. — l. c. Pl. XXXIX. fig. 6 — cannot be referred to *Cadoceras Tchekkini* d'Orb. sp., on account of the wider umbilicus, the lower whorls, and the less pronounced involution, but must be associated with *Cadoceras Nanseni* n. sp.

The fact that the full-grown stage of *Cadoceras Nanseni*, which Newton determined as *Amm. (Cadoceras) modiolaris* Luid. — l. c. Pl. XXXIX. fig. 10, differs from those species of *Cadoceras modiolaris* Luid. of English Authors, was expressed by Newton in the words "flattened variety", "more compressed", etc.

Remarks. Judging from its form and sculpturing, and the lobe-line of the young whorls, *Cadoceras Nanseni* n. sp. is very closely allied to *Cadoceras Tchekkini* d'Orb. sp. As regards the young whorls, the new species differs from *Cadoceras Tchekkini*: (1st) in the greater width of the umbilicus — compare letter-press fig. 16 a and Pl. II. fig. 7 —; (2nd) in the somewhat

¹ S. Nikitin, 'Der Jura der Umgegend von Elatma'. Lfg. 2. Pl. VIII. fig. 44.

broader external side of the whorls, — compare the diagrams of letter-press figs. 14 and 16 b —; (3rd) in the less distinct sickle shape of the ribs, or its total absence; (4th) in the less marked forward flexure of the ribs near the external side; (5th) in the lobe-line. The second lateral saddle and the auxiliary saddles are scarcely narrowed at all in *Cadoceras Nanseni*. The full-grown specimens of *Cadoceras Nanseni* differ from those of *Cadoceras Tchekkini* principally, in that in the former species the sculpturing continues distinct for a considerably longer time than in *C. Tchekkini*, and also in the usually flatter form of *Cadoceras Nanseni* n. sp.

The young whorls of *Cadoceras Nanseni* differ from *C. sublaeve* Sow. sp. in being less involute, with lower, externally broader whorls, with finer and closer, less distinctly falciform ribs.

As compared with the young whorls of *Cadoceras modiolare* d'Orb. sp., those of *Cadoceras Nanseni* are lower and considerably more slender, with considerably closer and finer ribs, and a wider umbilicus.

The sculpture of the young whorls of *Cadoceras Nanseni* n. sp. resembles somewhat that of *Cadoceras Elatmæ* Nikitin¹. The young whorls of both species, however, differ widely in this particular, the young whorls of *Cadoceras Elatmæ* Nik. increase considerably in breadth at a very early stage, when their diameter measures no more than about 25 mm.² Moreover, the lobe-line in *Cadoceras Elatmæ* is quite different from that in *Cadoceras Nanseni*. The saddles are all considerably lower, the second lateral lobe in *Cadoceras Elatmæ* Nik. is remarkably small, and the next saddle very broad and low. Full-grown specimens of both species cannot be mistaken for one another.

The specimens of *Cadoceras Nanseni* n. sp. now before me are for the most part embedded in clay-sandstone, partly in less sandy, marly rock. The

¹ S. Nikitin, 'Der Jura der Umgegend von Elatma'. I. fg. 2, p. 14. From a large specimen of *Cadoceras Elatmæ* Nikitin, from Elatma, I prepared the inner whorls, so that I was enabled to examine the Russian species at stages of growth corresponding to the figs. 2 and 3 on Pl. II.

² S. Nikitin, l. c. fig. 2, Pl. VIII (X), fig. 47.

pieces were found in loose blocks, most of them on July 16th, north of Elmwood, at a height of 500—550 feet, and also on July 14th, at Windy Gully at 400 feet, and on July 10th, on the talus at 100 feet above the sea. The pieces of *Cadoceras Nanseni* described under various names by Newton, come from Elmwood, on Cape Flora, and might be from a height of 500—550 ft. One of the individuals, Newton's *Amm. macrocephalus* — l. c. Pl. XXXIX. fig. 1. —, was stated in 1896 to be from "calcareous shale".

—————

Cadoceras sp. ex. aff. *Cad. Nanseni* (n. sp.).

Pl. II. fig. 4 a, b, c, Letter-press fig. 18.

The specimen represented in fig. 4 of Pl. II — chambered cast, with half a whorl of body-chamber — agrees in the character of the sculpture with *Cadoceras Nanseni* n. sp. It differs from the preceding species in the some-



Fig. 18.

Cadoceras sp. ex aff.
Cad. Nanseni (n. sp.)
Lobe-line of Pl. II fig.
4, at a height of the
whorl of 7 mm, 2×
enlarged.

what greater width of umbilicus, in the less pronounced involution (little more than half of each whorl is concealed by the succeeding one), and moreover, in the somewhat asymmetrical lobe-line. The saddles are a little less slender than in *Cadoceras Nanseni* n. sp., and here the second auxiliary lobe lies closer to the umbilical seam, while in *Cadoceras Nanseni* n. sp. there still follows a slight in-curving of the lobe-line after the second auxiliary lobe, before the seam. (Conf. letter-press fig. 18 with p. 88. letter-press fig. 17.) The lobes of the inner side can be seen very distinctly. The antisiphonal lobe is long and narrow, ending in a single point.

I have not before me sufficiently large and well-preserved materials of *Cadoceras Nanseni* to enable me to determine the limits up to which the young forms of this species may vary. For this reason — and because the full-grown stage of the form in question is not known — I must leave it undecided whether this form represents a new species, or whether it is only an individual variation of *Cadoceras Nanseni*. As, however, some differences, though only slight ones, may be detected, I consider this specimen separately.

Cadoceras sp. ex. aff. *Cad. Nanseni* (n. sp.) was found together with *Leda* cf. *nuda* Keys. sp. in a loose block of reddish-brown, somewhat coarse-grained clay sandstone, July 12th, near the margin of the glacier northwest of Elmwood.

2. GROUP OF *CADOCERAS MODIOLARE* D'ORB. SP. AND *ELATMÆ* NIK.

Cadoceras Frearsi (d'Orb. sp.) Nik.

Pl. II. fig. 10.

Letter-press fig. 19.

- 1845 (1844). *Ammonites Frearsi* d'Orbigny; Murchison, Verneuil et Keyserling, 'Géologie de la Russie', Vol. II. Paléontologie p. 444. Pl. XXXVII. figs. 1, 2.
1881. *Stephanoceras Elatmæ* S. Nikitin, 'Der Jura der Umgegend von Elatma'. Lfg. 1. Nouv. Mém. de la Soc. des Natural. de Moscou. Vol. XIV. p. 34 e. p. Pl. XI. fig. 22 a, b (not 20, 21, 23).
1885. *Cadoceras Frearsi* S. Nikitin, 'Der Jura der Umgegend von Elatma'. Lfg. 2. Nouv. Mém. de la Soc. des Natural. de Moscou. Vol. XV. p. 15. Letter-press fig. 3.

We have before us the fragments of two whorls, of a young specimen.

The figured fragment of a whorl is as broad as high. The cross section of the whorl is a short, broad oval, diminishing rapidly towards the upper end of the line of symmetry. The greatest thickness lies closer to the umbilicus than to the outside. The arched flanks converge rather rapidly towards the outside, which is obtusely rounded.

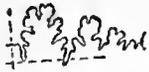

Fig. 19.

Cadoceras Frearsi
(d'Orb. sp.) Nik.

Lobe-line of Pl. II
fig. 10 a. 2 ×
enlarged.

The whorl is ornamented with coarse ribs, which exhibit a forward flexure, and are only slightly curved. Bifurcating ribs and single ribs alternate almost regularly.

The lobe-line is somewhat asymmetrical, so that the form of the auxiliary lobes on both sides of the whorl is not quite identical. The course of the lobe-line agrees perfectly with that of a young specimen, now before me, of *Cadoceras Frearsi* (d'Orb. sp.) Nik. from Elatma. In a size like that

of the figured piece, the saddles are still low. Close to the seam of the umbilicus, two small auxiliary lobes occur¹.

The corresponding fragment of the enclosed whorl is broad, low, and also already somewhat coarsely ribbed. The fragment of *Cadoceras Frearsi* (d'Orb. sp.) Nik. — cast of pyrites altered to brown iron-stone — was found loose, without any adhering rock, on July 12th, 1896, near the margin of the glacier, northwest of Elmwood.

Remarks. With regard to the juvenile forms of *Cadoceras Frearsi* (and in contradistinction to *Cadoceras Elatmæ*) Nikitin (1885, l. c. p. 16), states that "the ribs are more curved, and in the small volutions even somewhat falci-form". In the specimen before me, the sickle form is as little perceptible as in the young specimen (first determined as *Cadoceras Elatmæ*), which Nikitin figured 1881, l. c. Pl. XI. fig. 22; or in a specimen of *Cadoceras Frearsi* before me, from the Russian Jura of Elatma (Munich Museum).

Cadoceras sp. indet.

Pl. II. fig. 8.

1897. *Ammonites (Macrocephalites) macrocephalus* Schloth. var. E. T. Newton; E. T. Newton and J. J. H. Teall, l. c. Quart. Journ. Geol. Soc. London. Vol. 53, p. 498. Pl. XXXIX. fig. 3.

The impression given in fig. 8 of Pl. II belongs to the widely umbilicated juvenile form of a *Cadoceras* with thick whorls. The rapid increase in thickness of the whorls points towards an affinity to the group of *Cadoceras modiolare* d'Orb. and *Cadoceras Elatmæ* Nik., but even this cannot be positively asserted.

From the thickness of the whorls, the width of the umbilicus, and the form of the sculpturing, Newton's *Amm. (Macrocephalites) macrocephalus*

¹ It is a characteristic of *Cadoceras Frearsi* (d'Orb. sp.) Nik. that the second lateral lobe is pushed rather near the umbilical seam, and that for this reason the saddles and the auxiliary lobes after the second lateral lobe become comparatively very small. In succeeding whorls, the second lateral lobe is pushed towards the blunt upper margin of the umbilicus. On this point, *Cadoceras Frearsi* even in its early stages, differs not only from the more remote species, *Cad. sublave* Sow. sp., *Tchefkini* d'Orb. sp., *Nanseni* n. sp., *stenolobum* (Keys.) Nik., but also from the more closely allied *Cadoceras Elatmæ* Nik., *modiolare* Nik., and the other *Cadoceras* allied to these species.

Schloth. *var.* is almost certainly identical with the form in question. Unfortunately, Newton states nothing with regard to the lobe-line of his specimen, so that his data do not permit of a determination of the form. There is no doubt whatever, that the piece figured by Newton belongs as little to *Macrocephalites* (or is as little allied to *Macrocephalites macrocephalus* Schloth. sp.) as do the specimens figured by him, l. c. Pl. XXXIX. figs. 1 & 2. The width of the umbilicus, the involution and sculpture, speak against *Macrocephalites* and for *Cadoceras*.

The form before me — in grey clay sandstone, weathered a brown red, — was found at Cape Flora, at a height of 500—550 feet, north of Elmwood, Newton's specimen is also stated to be from Elmwood.

Among the impressions and smaller fragments of *Cadoceras*, other forms than those recorded here may possibly be represented. Their condition, however, is too imperfect for certain identification.

In a smaller fragment from light phosphoritic clay, found near the margin of the glacier, northwest of Elmwood, on July 12th, 1896, I was struck by the small elevation of the principal saddles, which call to mind *Cadoceras Elatmæ* Nik. I am not, however, able to determine whether *Cadoceras Elatmæ* is really represented in the collection before me.

Two casts of umbilici (with *Serpula flaccida* Goldf. in light, phosphoritic clay, July 12th, 1896) belong to a species of *Cadoceras* which, with an umbilicus still 18 mm. in width, shows closely disposed ribs on the umbilical wall, extending to the umbilical seam. The width of the umbilicus is equal to an angle of from 45° to 50° . It cannot be determined with certainty to which species these pieces belong; it is possible they belong to *Cadoceras Nanseni* n. sp., perhaps also to a species allied to *Cadoceras Elatmæ* Nik.

QUENSTEDTOCERAS, (Hyatt) Nikitin.¹

GROUP OF QUENSTEDTOCERAS MOLOGÆ-RYBINSKIANUM NIK.

The genus *Quenstedtoceras* in the material before me is represented by a single specimen only. To judge from its sculpture, it belongs to the group *Quenstedtoceras Mologæ-Rybinskianum* so widely spread in the Upper Cretaceous of Russia, and it may be identified with a species likewise described from the Russian Jura, viz.:

Quenstedtoceras vertunnum Sintz.

(*Non vertunnum* Leck. Lah., etc.)

Pl. II. fig. 9. Letter-press figs. 20, 21.

1888. *Quenstedtoceras vertunnum*. I. Sintzow, Carte géol. génér. de la Russie. F. 92. Saratow — Pensa. Mém. du Com. géol. St. Petersburg. Vol. VII. No. 1, p. 109. Pl. I. fig. 5.

The young form figured is flat, discoid, involute, and with a rather narrow umbilicus. The section of the whorls is oval, higher than it is broad, diminishing towards the outside. The greatest thickness is at about half the height of the whorls.



Fig. 20.

Quenstedtoceras vertunnum Sintz,

Section of the whorl of Pl. II. Fig. 9. Nat. Size.

The ventral area is not sharp, but bluntly rounded. At a diameter of 19 mm. the specimen shows the following proportions of dimensions:

Diameter	19 mm.	1
Width of the umbilicus	6 "	0.32
Height	}	of the last whorl .	{
Width			
		7 "	0.34

The moderately convex whorls are thickly covered with rather coarse ribs. In the lower half of the whorls, the ribs are sharper, towards the outside, they become more rounded. They have a slightly falciform curve. In the last third of the present whorl, dichotomous ribs alternate with single ribs; on the preceding part of the whorl, there are more dichotomous ribs. They run across the ventral area in curves, with the convexity towards the front. The intervals between the ribs are *not* filled up on the external surface, so that *no* keel-formation takes place.

¹ Hyatt first wrote *Quenstedioceras* (Proceed. Boston Soc. Nat. Hist. XVIII. p. 391); this is evidently a printer's mistake. The correct spelling of the name is *Quenstedtoceras* and not *Quenstedticeras*, as used by most authors.

A small fragment of the next succeeding whorl (Pl. II. fig. 9 a) shows of widely-separated, coarse ribs, running over the obtusely rounded ventral remains area in a broad curve.



Fig. 21.
Quenstedtoceras ver-
tumnum Sintz.
Lobe-line of Pl. II. fig.
9, at a height of the
whorl of 7.5 mm.
2 × enlarged.

The lobe-line shows the slender, high saddles, and principal lobes characteristic of young *Quenstedtoceras*, and in its slender second lateral saddle, it more closely approximates the *Mariæ* than the *Lamberti* form. The exceedingly deep external lobe is worthy of attention. The two small auxiliary lobes, together with the small second lateral lobe, form almost a kind of suspensive lobe.

The present specimen is embedded in rusty brown weathered clay. It was found near the margin of the glacier, NW. of Elmwood, 100—200 ft. above the sea, on July 12th, 1896.

Remarks: The form here described agrees well in the shape of the whorls, in the sculpturing, and in the outward form, with *Quenstedtoceras vertumnum*, described by Sintzow. It is somewhat more involute than the above-mentioned form, but it cannot on this account be separated as a new species. *Quenstedtoceras vertumnum* Sintzow is not identical with *Quenstedtoceras vertumnum* (Bean ms.) Leckenby sp.¹ Sintzow mentions indeed that Leckenby's species differs in its considerably coarser ribs, and a further difference exists in the more angular section in *Quenstedtoceras vertumnum* Leck. sp. Leckenby's *vertumnum* is probably only a modification of a *Quenstedtoceras Mariæ* d'Orb. sp. with a wider umbilicus, leading on to the still wider-ribbed *Quenstedtoceras vertumnum* Lah.² and Damon³. Nikitin⁴ classes the latter forms and *Quenstedtoceras carinatum* Sintzow⁵ (not *Amm. carinatus* Eichwald⁶) together as *Quenstedtoceras Damoni* Nik.

¹ J. Leckenby, 'On the Kellaway Rock of the Yorkshire Coast'. Quart. Journ. Geol. Soc. London, 1859, p. 21. Pl. I. fig. 3.

² J. Lahusen, 'Die Fauna der Jurassischen Bildungen des Rjasanschen Gouvernements'. Mém. du Com. géol. St. Petersbourg, vol. I. No. 1. p. 46, Pl. IV. fig. 9 (not 8 = *Mariæ* d'Orb. sp.).

³ R. Damon, 'A Supplement to the Geology of Weymouth', etc., London, 1880. Pl. 1. figs. 3, 3 a.

⁴ S. Nikitin, 'Rapports entre les Céphalopodes jurassiques russes et les originaux correspondants dans les collections d'Europe occidentale'. Bull. de la Soc. Belg. de Géol. etc., vol. III. 1889, p. 35.

⁵ I. Sintzow, l. c. p. 109. Pl. I. fig. 4.

⁶ E. d'Eichwald, 'Lethæa Rossica'. p. 1073. Pl. 34, fig. 8.

As *Ammonites vertumnus* Leckenby is synonymous with *Quenstedtoceras Marie* d'Orb. sp., the form described by Sintzow. and the one here described from Franz Josef Land may both be designated as *Quenstedtoceras vertumnum* Sintzow.

Sintzow states in his work (written in Russian) that his *Quenstedtoceras vertumnum* resembles the early stages of *Quenstedtoceras Mologæ* Nikitin¹. I can only judge of the early stage of the latter species from a figure given by Nikitin². According to this figure, the whorls in *Quenstedtoceras Mologæ* Nik. are thicker and more evolute, and the ribs more curved than in *Quenstedtoceras vertumnum* Sintzow. A further difference may be noticed from Nikitin's description³. According to it, *Quenstedtoceras Mologæ* has a dichotomous second lateral lobe (in Nikitin's drawing of the lobes of a larger specimen, the second lateral lobe is trichotomous⁴, the second lateral lobe in *Quenstedtoceras vertumnum* Sintzow being also trichotomous). *Quenstedtoceras vertumnum* Sintzow and *Mologæ* Nik. agree in having no keel-formation, even in the very earliest stages known.

Judging from its greater involution, *Quenstedtoceras vertumnum* Sintzow is also allied to *Quenstedtoceras Rybinskianum* Nik. In this respect, special prominence should be given to the form⁵ described by Lahusen as *Cardioceras Rybinskianum*. To judge from Lahusen's figures, however, *Quenstedtoceras Rybinskianum* Nik. differs in its greater thickness, in the absence of single ribs, and in the keel-formation in a size corresponding to that of our specimen, i. e. the filling up of the interspaces between the ribs in the median line of the ventral area⁶.

¹ S. Nikitin (Notes sur les dépôts jurassiques des environs de Sysran et de Saratov. Extract from Bull. du Com. géol. St. Petersbourg, vol. VII. p. 29) confirms this remark of Sintzow's but seems to regard *Quenstedtoceras vertumnum* Sintzow and Leckenby as identical, on which point I cannot agree with him.

² S. Nikitin, Allgemeine Geologische Karte von Russland. Blatt 56 (Jaroslavl, etc.) Mem. du Com. géol. St. Petersbourg, vol. I. No. 2, 1884, p. 59. Pl. 1. fig. 3. The young form here figured does not agree in its ribbing with the inner whorl of the piece figured by Nikitin, 1881 (Rybinsk. etc.), Pl. 1. figs. 11, 12.

³ S. Nikitin, 1881. Rybinsk. etc. p. 51.

⁴ S. Nikitin, 1881. Rybinsk. etc. Pl. 1. fig. 10.

⁵ J. Lahusen, l. c. Pl. N. figs. 13—16, especially 13, 14.

⁶ W. Weissermel (Beitrag zur Kenntniss der Gattung Quenstedtoceras. Zeitschr. d. Deutsch. Geol. Ges. 1895, p. 327) here uses the very apt term "Kielstreifen".

I wish to point out that the form from the Russian Jura, which d'Orbigny at first¹ determined as *Amm. Leachi* subsequently² as *Amm. Mariæ* is allied to our *Quenstedtoceras vertumnum*, but differs from it in its finer sculpturing, — without single ribs, — and in its lower saddles (provided d'Orbigny's drawing is correct). Nikitin³ refers the form in question to the synonyms of *Quenstedtoceras Lamberti* Sow. sp. It is probable that both d'Orbigny's and Nikitin's determinations are wrong, and that this *Amm. Leachi* d'Orb. non Sow. = *Amm. Mariæ* d'Orb. e. p. = *Quenstedtoceras Lamberti* (Sow.) Nik. e. p., belongs to the group of *Quenstedtoceras Mologœ-Ryb-inskianum*.

Quenstedtoceras vertumnum Sintzow and *Mologœ* Nik. are the *Quenstedtoceras* in which one of the generic characters — the formation of the keel-line — is quite suppressed, or perhaps only nearly so, i. e. with the exception of the whorls of still younger stages than those hitherto studied. These forms have consequently still more resemblance to the *Cadocerates* than all other species of *Quenstedtoceras*, which in adult stages also become broad and depressed.

In the material collected by Professor Nansen in the neighbourhood of Cape Flora, the following forms of Ammonites may be recognized after the above investigations:

- Macrocephalites Kœllitzi* n. sp.
 „ sp.
Cadoceras Tchefkini d'Orb. sp.
 „ *Nanseni* n. sp.
 „ sp. ex. aff. *Nanseni* (n. sp.)
 „ *Frearsi* (d'Orb. sp.) Nik.
 „ sp. (? *Elatmæ* Nik.)
 „ sp. indet.
Quenstedtoceras vertumnum Sintz.

¹ Murchison, Verneuil et Keyserling, 'Géologie de la Russie' Vol. II. Paléontologie, p. 438. Pl. XXXV. fig. 7—9.

² 'Paléontologie française' Terr. jur. I, Pl. 179. fig. 7—9.

³ S. Nikitin, 1881. Rybinsk etc. p. 46.

BELEMNOIDEA.

BELEMNITES LISTER.

Only some of the numerous Belemnite fragments from various rocks can be approximately determined.

The best preserved fragments belong to a species of the group "Explanati" (A. Pawlow).¹ Judging from its form, this species combines to a certain extent the characteristics of two species of the Russian (and Central European) Jura, viz. *Belemnites subextensus* Nik. and *Belemnites Panderi* d'Orb. These characters will be taken account of in the following description.

Belemnites m. f. *subextensus* Nik. — *Panderi* d'Orb.

Pl. I. figs. 18—21 b.

1897. *Belemnites Panderi* E. T. Newton; E. T. Newton and J. J. H. Teall, l. c. Quart. Journ. Geol. Soc. London, vol, 53, p. 498. Pl. XXXIX. figs. 11—14.

[Cf. 1884. *Belemnites subextensus* S. Nikitin, 'Die Cephalopoden der Jura-bildungen des Gouvernements Kostroma'. Verhandl. d. k. Mineralog. Ges. zu St. Petersburg, vol. XX. p. 61. Pl. VI. fig. 28.

1845 (44). *Belemnites Panderianus* A. d'Orbigny; Murchison, Verneuil et Keyserling, 'Géologie de la Russie'. Vol. II. Paléontologie, p. 423. Pl. 30.]

The guard is rather short, and comparatively slender (figs. 18 a and 19 are so put together from other pieces, that the apex of the guard and the beginning of the alveole are at a correct distance from one another). The alveole occupies scarcely half the length of the rostrum. The rostrum ends in a short, somewhat obtuse, eccentrically situated point (figs. 20 b, 21 b). On the somewhat flattened ventral side, a short, rather narrow groove, becoming rapidly broader and flatter anteriorly, issues from the apex. The flanks of the rostrum — behind the alveolar part — are flattened by very shallow, broad, imperfectly preserved grooves (figs. 20 b, d). The section of the guard varies. Behind the alveolar part, the dorso-ventral axis is

¹ A. Pawlow et G. W. Lamplugh, 'Argiles de Specton et leurs équivalents'. Bull. de la Soc. Impér. des Natural de Moscou. 1891. Sep. copy, p. 91.

considerably greater than the width of the guard. The section here varies from a rounded quadrilateral to a rounded trapezoid (in figs. 20c, d, 21b, special attention is to be paid to the inner rings of growth in fig. 20c). In the alveolar part the section becomes more and more circular (fig. 18b); the dorso-ventral axis here is at first only very small, afterwards scarcely greater than the thickness of the guard, the flanks, moreover, here being no longer flattened.

The beginning of the alveole, and the apical line are very eccentric in position, and very near the ventral side. The distance of the apical line from the ventral side of the rostrum varies in the different specimens (figs. 18 a, 19, 20 c) from one fourth up to one third of the dorso-ventral axis.

A fragment of a small rostrum (with eccentric radiation), from brownish clay, probably also belongs to the above-mentioned species. It shows the phragmacone in a good state of preservation, and even remains of the crushed pro-ostracum (?) are visible.

The figured pieces correspond in size with the greater number of the specimens; larger ones are rare.

Belemnites m. f. subextensus Nik. — *Panderi* d'Orb. was found loose on July 12th, 1896, near the margin of the glacier NW. of Elmwood in numerous pieces weathered out of the rock. One fragment lies embedded in grey, brownish-weathered clay (like *Cadoceras Tchekini* d'Orb. sp. and *Quensledtoceras vertumnium* Sintz.).

Some specimens are in clay-sandstone (No. 7) found July 16th, 1896, above Elmwood 550 ft.

Newton records our species from Elmwood and from the "western end of Cape Flora".

Remarks. There is no doubt that the species here described agrees with the *Belemnites Panderi* which Newton described from Cape Flora. Newton bases his determination on a comparison with belemnites from the Russian Jura, which Professor Pawlow had determined as *Bel. Panderi*. Professor Pawlow, to whom I had the opportunity of showing my materials, told me that they might well be determined as *B. Panderi* d'Orb., the more so as Russian geologists include under this name several species which are to be separated. On comparing the present species, however, with the original description and the figures which d'Orbigny has given of his *Belemnites*

Panderianus, we find, besides much that corresponds, some important differences. The section of the rostrum agrees with *Belemnites Panderi* d'Orb. in the post-alveolar part, the shortness of the ventral groove, the somewhat drawn-out apex, and the great eccentricity of the apical line in some of the pieces (fig. 19). The inconsiderable width of the ventral groove, and still more the transverse section in the alveolar region of the rostrum are points against the alliance with *Belemnites Panderi*. In *Belemnites Panderi* this transverse section always remains distinctly laterally compressed, while in our piece, it is almost an exact circle.

The characteristics which separate our species from *Belemnites Panderi* d'Orb. consequently bring it nearer to *Belemnites subextensus* Nik.

In common with this species — not very thoroughly described by Nikitin — our own has the circular section in the alveolar region, the slender form and the narrow ventral groove (Nikitin, l. c. Pl. VI. fig. 28 a).

According to the single specimen which Nikitin has figured of *Belemnites subextensus*, the transverse section of the guard in the post-alveolar part is more rounded in this species than in most of the pieces of the form in question. Moreover, the apex of the guard in this species is not at all drawn out, and besides, the ventral groove Nikitin's fig. 28 b shows numerous longitudinal furrows near the apex, which do not occur in our species, or possibly are only not preserved.

It is sufficiently clear from the reasons stated above, that our Belemnite species from Cape Flora cannot be identified — as has been done by Newton — with *Belemnites Panderi* d'Orb. From a morphological point of view our form rather stands between *Belemnites Panderi* d'Orb. and *B. subextensus* Nik. as far as we can judge about the latter species. Sufficiently rich and well preserved material of both our species and *B. subextensus* Nik. might possibly prove the necessity of an identification of the two species.

Belemnites sp. indet. 1.

In phosphoric clay boulders (found on July 14th, 1896, Windy Gully ca. 400 ft.), some fragments of phragmacones of a Belemnite species which must have attained considerable dimensions are embedded. One of these fragments corresponds to a phragmocone diameter of about 65 mm.: the siphuncle

has a thickness of more than 6 mm., and the distance between the septa thus becomes 10 mm. or more. These are dimensions which are scarcely surpassed by the largest individuals known of *Belemnites giganteus* Schloth.

E. T. Newton mentions phragmacones of large species in phosphatic nodules from Windy Gully (l. c. p. 501), without being able to contribute anything towards their determination.

Belemnites sp. (cf. *Beyrichi* Opp.)

Pl. I. figs. 22, 23.

cf. 1856. *Belemnites canaliculatus gracilis* F. A. Quenstedt. 'Der Jura', p. 484. Pl. 65, figs. 23.

1857. *Belemnites Beyrichi* A. Oppel, 'Die Juraformation' § 61, No. 1.

1870. *Belemnites Beyrichi* F. Römer, 'Geologie von Oberschlesien.' p. 228
Pl. 17, figs. 31, 32.

1870. *Belemnites Beyrichi* M. Neumayr, 'Die Cephalopodenfauna der Oolithie von Balin'. Abhandl. d. K. K. Geolog. Reichsanst. Wien
Bd. V, H. 2, p. 25.)

There are numerous fragments of guards (without alveoles), for the most part badly preserved. They belong to a species of Belemnite with a long slender, slightly club-shaped guard. It appears from several specimens (e. g. fig. 23) that the guard diminishes somewhat towards the alveolar region. Posteriorly the guard is gradually produced to a long apex. Unfortunately the apex is never preserved intact; in fig. 23, to judge from the course of the lines of growth, it is drawn too obtuse.

The transverse section of the rostrum is circular, or nearly so. The apical line is central or very slightly eccentric.

Grooves are not observable in pieces corresponding to fig. 23.

A very much weathered fragment was found together with the figured specimens, showing the beginning of a groove, also a central axis and concentric radiation. Judging from the direction of the lines of growth, this groove deepens towards the alveolar region.

If the above-mentioned fragments belong to one species — which is very probable — this species might best be compared with *Belemnites Beyrichi* Opp. of the group of the "Hastati" (Zittel). The pieces generally agree well,

with the originals of Oppel¹ from the Bathonian of Württemberg, and with several specimens of *B. Beyrichi* Opp. from Gnaszyn, near Czenstochau in Poland, which are now before me. The state of preservation, however, does not suffice for the identification of the pieces from Cape Flora with *B. Beyrichi*, nor to class them as decidedly different from that species.

Among the "Belemnites sp." which Newton (l. c. p. 502) records from "west of Elmwood", "the third form" ("cylindrical, concentrically radiated, and with comparatively acute apex") most probably belongs to our species.

Most of the pieces of *Belemnites* sp. (cf. *Beyrichi* Oppel) were found along with *Pseudomonotis Jacksoni*, loose, weathered out of the rock, on August 2nd, 1896, at a height of about 23—33 ft. above sea-level. The species, moreover, lie, together with *Pseudomonotis Jacksoni*, embedded in gray, finely-grained sandy marl (Aug. 2nd, 1896, 23—33 ft.). Fragments and sections, corresponding to our species, may also be seen, as also *Lingula Beani* Phill. and *Discina reflexa* Sow. sp., in light gray, soft marl occurring together with the hard sandy marl NNW. of Elmwood.

A few loose fragments of Belemnites were also found together with *Belemnites* sp. (of *Beyrichi* Opp.), showing traces of grooves and somewhat eccentric radiation, and perhaps allied to *Belemnites canaliculatus* Schloth. They are pieces which probably belong to the other fragments noted by Newton (l. c. p. 502), from "west of Elmwood".

Yet another small fragment is worthy of attention, as being that of a

Belemnites sp. indet. 2.

Pl. I. fig. 24.

Found loose; statement of locality, date and height wanting. The piece shows an elliptical section. The dorso-ventral axis is shorter than the width of the rostrum. The beginning of the alveole is somewhat eccentric, near the ventral side (fig. 24c). Any determination of the piece appears to be impossible.

¹ The figure which agrees best with Oppel's originals of *B. Beyrichi* is the one which Quenstedt gives in "Jura" of his *B. canaliculatus gracilis*.

3. SUMMARY.

From the above descriptions, a fauna of at least 26 forms may be demonstrated in the Jurassic Sedimentary Rocks collected by Professor Nansen in the Cape Flora district.

The abundance of forms contained in the rocks is not, however, exhausted by these 26 different species, as there are also numerous fragments of other species — as has been already frequently mentioned — differing from the forms described, for whose approximate determination, even, there is no sufficient clue.

It appears from an inspection of the collection of the Jackson-Harmsworth Expedition, described by Newton, that the abundance of Jurassic animal fossils at Cape Flora is greater than would appear from the material collected by Professor Nansen. According to Newton's account, the entire number of the species (of the fauna) of the Jura of Cape Flora, amounts to at least 31.

In the following list, the fossils collected by Professor Nansen are placed opposite to those described by Newton. In so far as any criticism of Newton's determinations of the fossils is possible from his descriptions and illustrations, it will be found in the descriptive part of the present work; its results are apparent from the following table.

COMPARATIVE TABLE
OF THE
JURASSIC FOSSILS AT CAPE FLORA.
(FRANZ JOSEF LAND.)

Collected by Prof. *Fridtjof Nansen*
and described in the present
work.

Collected by the *Jackson-Harmsworth*
Expedition and described by
E. T. Newton in Quart. Journ. Geol.
Soc. London 1897. Vol. 53.¹

- | | |
|--|--|
| <p>1. <i>Pentacrinus</i> sp. ex. aff. <i>bajociensis</i> (<i>d'Orb.</i>) <i>P. de Lor.</i> pag. 51. Pl. I. Fig. 1.
 2. <i>Serpula flaccida</i> Goldf. pag. 53.
 3. <i>Lingula Beani</i> Phill. pag. 54. Pl. I. Fig. 2-5.
 4. <i>Discina reflexa</i> Sow. sp. pag. 58. Pl. I. Fig. 6-9.
 5. <i>Discina</i> sp. pag. 59. Pl. I. Fig. 10.
 6. <i>Pseudomonotis Jacksoni</i> n. sp. pag. 60. Pl. I. Fig. 13-16.
 7. <i>Pseudomonotis</i> sp. (cf. <i>ornati</i> Quenst.) pag. 62.
 8. <i>Pecten Lindströmi</i> Tullbg. pag. 63. Pl. I. Fig. 12.
 9. ? <i>Limea</i> cf. <i>duplicata</i> Goldf. pag. 65. Pl. I. Fig. 11.
 10. <i>Lima</i> sp. indet. pag. 68. Pl. II. Fig. 8a.
 11. <i>Leda</i> cf. <i>nuda</i> Keys. sp. pag. 66.
 12. <i>Macrodon Schourovski</i> F. Rouill. sp. pag. 67. Pl. I. Fig. 17.
 13. <i>Amberleya</i> sp. pag. 68.
 14. <i>Macrocephalites Koellitzi</i> n. sp. pag. 70. Pl. II. Fig. 12.
 15. <i>Macrocephalites</i> sp. pag. 73. Pl. II. Fig. 11
 16. <i>Cadoceras Tchekkini</i> <i>d'Orb.</i> sp. pag. 80. Pl. II. Fig. 7.</p> | <p>27. <i>Gorgonia</i> (?) pag. 498. Pl. XXXIX Fig. 15²
 <i>Avicula</i> sp. cf. <i>inaequivalvis</i> pag. 502. Pl. XL Fig. 4.
 28. <i>Pecten</i> cf. <i>demissus</i> pag. 498³.
 29. <i>Macrocephalites pila</i> Nik. (= <i>Amm.</i> (<i>Macrocephalites</i>) <i>Ishmae</i>, inflated variety, pag. 501, Pl. XL, Fig. 2) [73]
 30. <i>Macrocephalites Ishmae</i> Keys. var. <i>arctica</i>, <i>E. T. Newt.</i> pag. 500, Pl. XL, Fig. 1.
 <i>Amm.</i> (<i>Macrocephalites</i>) <i>Ishmae</i>, smooth variety, pag. 501, Pl. XL, Fig. 3. [72]
 { <i>Amm.</i> (<i>Cadoceras</i>) <i>Tchekkini</i> (?) <i>d'Orb.</i> e. p. pag. 496, Pl. XXXIX, Fig. 5. [84]
 { <i>Amm.</i> (<i>Cadoceras</i>) <i>modiolaris</i> <i>Luid.</i> e. p. pag. 497, Pl. XXXIX, Fig. 7, 8. [85]
 31. <i>Cadoceras stenolobum</i> (<i>Keys</i>) <i>Nik.</i> (<i>Amm.</i> (<i>Cadoceras</i>) <i>Tchekkini</i> (?) <i>d'Orb.</i> e. p. pag. 496, Pl. XXXIX, Fig. 4. [84]
 <i>Amm.</i> (<i>Cadoceras</i>) <i>modiolaris</i> <i>Luid.</i> e. p. pag. 497, Pl. XXXIX, Fig. 9. [84]</p> |
|--|--|

¹ The figures enclosed in [] refer to those passages of the present work which contain critical remarks on the descriptions of Newton.

² Very doubtful; questionable whether of organic origin at all.

³ Newton's description offers no clue as to whether the form in question is different from our *Pecten Lindströmi* or agrees with it.

- | | | |
|--|---|--|
| <p>17. <i>Cadoceras Nanseni</i> n. sp. pag. 86. Pl. II. Fig. 1-3, 5, 6.</p> | { | <p>Amm. (<i>Macrocephalites</i>) <i>macrocephalus</i> Schl. pag. 497, Pl. XXXIX, Fig. 1, 2. [89]</p> <p>Amm. (<i>Cadoceras</i>) <i>Tchefkini</i> (?) d'Orb. e p. pag. 496, Pl. XXXIX, Fig. 6. [90]</p> <p>Amm. (<i>Cadoceras</i>) <i>modiolaris</i> Luid., flattened variety, pag. 497, Pl. XXXIX, Fig. 10. [90]</p> |
| <p>18. <i>Cadoceras</i> sp. ex. aff. <i>Nanseni</i> (n. sp.) pag. 92. Pl. II. Fig. 4.</p> | | |
| <p>19. <i>Cadoceras Frearsi</i> (d'Orb.) Nik. pag. 93. Pl. II. Fig. 10.</p> | | |
| <p>20. <i>Cadoceras</i> sp. indet. pag. 94. Pl. II. Fig. 8.</p> | = | <p>Amm. (<i>Macrocephalites</i>) <i>macrocephalus</i>, Schl. e. p. pag. 498, Pl. XXXIX, Fig. 3. [94]</p> |
| <p>21. <i>Cadoceras</i> sp. (? <i>Elatmae</i> Nik.) pag. 95.</p> | | |
| <p>22. <i>Quenstedtoceras vertumnum</i> Sintz. pag. 96. Pl. II. Fig. 9.</p> | | |
| <p>23. <i>Belemnites m. f. subextensus</i> Nik. — <i>Panderi</i> d'Orb. pag. 100. Pl. I. Fig. 13-21.</p> | = | <p>(32) ? ? <i>Cosmoceras</i> (<i>Kepplerites</i>) sp. "allied to <i>Amm. gowerianus</i>"; ? ? pag. 502.¹ <i>Belemnites Panderi</i> d'Orb. pag. 498, Pl. XXXIX, Fig. 11-14. [101]</p> |
| <p>24. <i>Belemnites</i> sp. indet. 1. pag. 102.</p> | = | <p><i>Belemnites</i> sp. e. p. pag. 501.</p> |
| <p>25. <i>Belemnites</i> sp. (cf. <i>Beyrichi</i> Opp.) pag. 103. Pl. I. Fig. 22, 23. (<i>Belemnites</i> sp. perhaps group of <i>Cana-liculati</i>) pag. 104.)</p> | = | <p><i>Belemnites</i> sp. (the third form) pag. 502.</p> |
| <p>26. <i>Belemnites</i> sp. indet. 2. pag. 104. Pl. I. Fig. 24.</p> | | <p>? <i>Belemnites</i> sp. pag. 502, (the other forms there mentioned).</p> |

In the first place, this comparison shows that, judging from Professor Nansen's collection, the Jurassic fauna of the neighbourhood of Cape Flora proves to be considerably more abundant (26 species) than might be supposed from the results of the Jackson-Harmsworth Expedition (14 species). Among the 26 species collected by Professor Nansen, there are 17 which, as against the results of the Jackson-Harmsworth Expedition, are new, while in the collection described by Newton, there are 5 species which are wanting in Nansen's collection. Ten of the species recorded in the table could be directly identified with species already known from other localities; 7 could be recognised as being allied to known species, or similar to them. Of the remaining forms, 5 are new; the rest may perhaps also be new, but they are in so imperfect a state of preservation, that their exact determination seems in the meantime to be impossible.

In the Jurassic fauna of Cape Flora, the Cephalopods and the Lamelli-branches occupy an exceedingly predominant position.

It is especially worthy of note, that as far as can be judged, the Gastropods are extremely rare, a fact to which we must give our attention later on.

¹ Not described.

IV.
STRATIGRAPHIC RESULTS.

The Jurassic fauna of Cape Flora is distinguished by the prominent part which the Ammonite genus *Cadoceras* plays in its composition. One species, *Cadoceras Nanseni* n. sp. allied to *Cadoceras Tchekini* d'Orb. sp., is represented by a particularly large number of specimens. In addition to *Cadoceras*, the two genera *Quenstedtoceras* and *Macrocephalites* must be mentioned as being stratigraphically most important representatives of the Ammonites in our fauna.

The occurrence of these three genera of Ammonites proves that the marine fauna of the Jura of Cape Flora contains representatives of the *Callovian*.¹

Are other horizons of marine Jura than the Callovian possibly represented at Cape Flora?

More recent marine horizons have certainly not been formed at Cape Flora, as far as I can judge from the collection of fossils before me. The absence of the Lamellibranch genus *Aucella*, which is peculiarly characteristic of the Upper Jurassic strata of northern regions, would be sufficient to prove that the Oxfordian² and all more recent Jurassic horizons do not occur as marine deposits at Cape Flora. Not only *Aucella*, but all other forms characteristic of the higher Jura, are absent.

The question whether marine Jura deposits *older* than the Callovian are developed at Cape Flora, demands a careful discussion, which will follow below.

¹ The term *Callovian* is here always used in the sense in which the German, French and Russian authors use it. I write Callovian and not "Kellaway", in order to avoid the confusion of our Callovian with the non-identical "Kellaways Rock" of English authors.

² "Oxfordian" again in the sense in which the German, French and Russian geologists use the term, not equivalent with the "Oxford Clay" of English authors.

In the above table there is specified the occurrence in the various localities given by Professor Nansen, of the marine fossils collected by him, and described in the present work.

The successive order of the localities according to their height above the sea, is as follows:

1. *Elmwood, some 300 metres NW. of the hut*; — 23—33 ft. (2nd Aug. 1896).
2. *Talus NNW. of Elmwood*; — 100 ft. (10th July, 1896).
3. *At the margin of the glacier, NW. of Elmwood*; 100 ft., 200 ft. (12th July 1896).
4. *South-western end of Windy Gully (NE. of Elmwood)*; — 370—450 ft. (14th July, 1896).
5. *Watercourse below the basalt just above (N. of) Elmwood*; — about 500—550 ft. (16th July, 1896).

This must *not* be apprehended as though the different localities correspond to different successive (according to given altitude) horizons in the profile of the Jura of Cape Flora.

Fossils were found *in situ* in the following localities:

1. Elmwood, ca. 300 metres NW. of the hut; — 23—33 ft. (12th Aug. 1896).
4. South-western end of Windy Gully; — 370—450 ft. (14th July 1896).
5. Watercourse below the basalt N. of Elmwood; — about 550 ft. (16th July, 1896).

The fossils and rocks collected in the localities 2 and 3 were found loose, some on the talus, and others at the margin of the glacier. With regard, therefore, to the stratigraphy of the Jura at Cape Flora, the rocks and fossils collected at the localities 1, 4 and 5 must be considered first.

In the first place, it appears from the above table that the fauna of locality 1, "Elmwood, some 300 m. NW. of the hut", with its Brachiopoda, Lamellibranchiata and Belemnites, shows an essential difference from the fauna of the other localities. Judging from the material before me, the Ammonites are here entirely absent, while in the other localities, they were found in considerable numbers. For the present we will leave out of consideration the fauna of locality 1, where the fossiliferous layer, occurring at the lowest altitude in the neighbourhood of Cape Flora, was observed *in situ*

and occupy ourselves with the rocks and fossils of those localities containing Ammonites, these being fossils of the greatest value for determining the stratigraphy of the Jura.

In locality 4,

South-western end of Windy Gully,

(cf. p. 13 "Medium horizon" and Letter-press fig. 1, c; fig. 2, c)

"about an hour's walk north-eastwards from Elmwood", Professor Nansen, observed, on July 14th, 1896, at a height of about 400 feet (370—450 ft.) above sea-level, "a clayey ridge with horizontal layers". Some of the fossils collected here were, according to both Prof. Nansen and Dr. Koettlitz¹, found *in situ*.

I have before me from this locality,

Macrocephalites Koettlitzii n. sp. in gray-brown phosphoritic clay;

Belemnites sp. indet. 1. — Fragments of large phragmacones in dark, hard, phosphoritic nodules with a gray, clayey weather-crust and numerous phosphoritic nodules without fossils.

Among the material which E. T. Newton describes from this locality, the following species, in addition to *Macrocephalites Koettlitzii* n. sp. (*Amm.* [*Macroceph.*] *Ishmæ* "smooth variety"), and the Belemnite fragments, ought to be specially noticed:

Macrocephalites Ishmæ var. *arctica* E. T. Newton, and

" *pila* Nik. (= *Amm.* [*Macroceph.*] *Ishmæ*

"inflated variety" E. T. Newton cf. p. 73).

Being a new species, the present *Macrocephalites Koettlitzii* n. sp. *a priori* as little permits of any certain determination of the horizon as does *Macrocephalites Ishmæ* var. *arctica* Newton. Both species are allied to *Macrocephalites Ishmæ* Keys. sp., whose exact vertical position in the Petchora basin is not yet known, although there is no doubt that the latter

¹ E. T. Newton and J. J. H. Teall, l. c. Quart. Journ. Geol. Soc. London, 1897. vol. LIII. p. 500.

species belongs to the Callovian¹. But *Macrocephalites pila* Nik. occurs at Windy Gully together with *Macrocephalites Kættlitzii* n. sp. and *Ishmæ* var. *arctica*: This species belongs to the *Lower Callovian* in the Russian² government Tambow (Elatma) in the Crimea, in the south-western part of Ustj-Urt. It further occurs in the corresponding horizon of the Jura of Württemberg³. Bukowski⁴ indeed, records *Macrocephalites pila* from Poland, from the *Upper Callovian* of Czenstochau, but with the remark that the form described does not quite agree with Nikitin's species.

By the discovery of Macrocephalites pila Nik. at the south-western end of Windy Gully, the occurrence of the Lower Callovian = zone of Macrocephalites macrocephalus Schloth. sp. = zone of Cadoceras Elatmæ Nik.

was proved in this locality, at a height of about 400 ft. above the sea. At the same time, the age of *Macrocephalites Kættlitzii* n. sp., and *Ishmæ* var. *arctica* E. T. Newton, as well as of the remains of large belemnites, found at Windy Gully in *phosphoritic nodules*, is thereby determined as Lower Callovian⁵.

[Besides phosphoritic clay with *Macrocephalites Kættlitzii*, and the phosphoritic nodules, Prof. Nansen also collected at Windy Gully several pieces of hard, yellowish-gray marl ("Steinmergel") containing

¹ E. von Eichwald (Geognostisch Paleontologisch Bemerkungen über die Halbinsel Mangischlak und die Alentischen Inseln, p. 146. Pl. VIII, figs. 4–5; Pl. XI, fig. 5; Pl. X, figs. 3–7) records an *Ammonites Ishmæ* from the Neocomian from Alaska, and from the Chinese bay north of Cape Unalischaglak. The forms in question certainly do not belong to *Macrocephalites Ishmæ* Keys sp., but are allied to *Cadoceras Tchekini* d'Orb. sp. Moreover, they do not belong to the Neocomian, but, together with *Cadoceras* (not *Olcostephanus*, as Neumayr believed) *Doroschini* Eichw. sp. to the Callovian.

² The best information upon the distribution of the Ammonites in the various zones of the Russian Callovian is to be had from the following works:

S. Nikitin, 'Ueber die Beziehungen zwischen der russischen und westeuropäischen Juraformation', Neues Jahrb. f. Min. etc. 1886. vol. II, pp. 212–230.

B. Szemenoff, 'Versuch einer Anwendung der statistischen Methode zum Studium der Verteilung der Ammoniten im russischen Jura'. Annuaire géol. et min. vol. II. Book VI.

³ F. A. Quenstedt, 'Die Ammoniten des Schwäbischen Jura'. Pl. 76, figs. 12, 13. S. Nikitin, 'Quelques excursions dans les musées et dans les terrains mésozoïques de l'Europe centrale'. Bull. de la soc. Belge de Géol. etc. vol. III. 1889. p. 36.

⁴ G. von Bukowski, 'Ueber die Jurabildungen von Czenstochau in Polen'. Beitr. z. Palaeontologie Oesterreich-Ungarns, etc. 1887. ol. V. p. 126. Pl. XXVI, fig. 17.

⁵ It is thus very probable that *Macrocephalites Ishmæ* Keys. sp. from the Petchora basin also belongs to the Lower Callovian.

Cadoceras Nanseni n. sp., and
Pseudomonotis sp. (cf. *ornati* Quenst. sp.)

There are no fragments of *Macrocephalites* in this rock.

The pieces of this marl have rolled down from above, and are surrounded with a red weather-crust (Hydroxide of iron). They certainly do not come from the same height as *Macrocephalites Kœttiltzi*; they have rather fallen from a greater height. Very similar, only more sandy rocks have been found *in situ* in locality 5, near the lower limit of the basalt, at a height of 500—550 ft. above the sea. *Cadoceras Nanseni* n. sp., — as will be seen below — also points to a more recent faunistic horizon than that of the Lower Callovian.]

The next locality where rocks and fossils were observed *in situ* is 5.

Watercourse below the basalt, just above (N. of) Elmwood — 500—550 ft.

[cf. p. 14. "Upper horizon" Letter-press Fig. 1, d, fig. 3, d.]

This is the locality which, in the report of the Jackson-Harmsworth Expedition, is mentioned as "a watercourse at the back of Elmwood"¹.

According to Prof. Nansen, rocks *in situ*, clay-sandstone and hard, finely-grained stone marl were found in this locality at a height of circ. 550 ft. above the sea — according to the report of the Jackson-Harmsworth Expedition, 50 ft. below the basalt.

From the various, partly coarse-grained, partly more compact, less sandy pieces of clay-sandstone, more like the stone-marl (p. 47), of which only some were found *in situ*, some loose, weathered out of the rock, the following fossils are before me:

Pseudomonotis sp. (cf. *ornati* Quenst. sp.)

Pecten Lindströmi Tullbg.

? *Limea* cf. *duplicata* Goldf.

Lima sp. indet.

Macrodon Schourovski F. Rouill. sp.

Cadoceras Nanseni n. sp.

" sp. indet.

¹ E. T. Newton and J. J. H. Teall, l. c. p. 496. Under "3 Elmwood" two localities are comprehended. Only the one under the above mentioned designation is identical with our locality 5. The locality of *Cadoceras Tchekini* (? d'Orb.), mentioned l. c. as "the side of the glacier at the western end of Cape Flora," according to Professor Nansen, is our locality 3, 1½ kilometre north-west of Elmwood.

Belemnites m. f. *subextensus* Nik. — *Panderi* d'Orb.

Among the fossils described by Newton from Elmwood, the following species come from our locality, and out of clay-sandstone:

Cadoceras Tchekini d'Orb. sp.¹

” *Nanseni* n. sp.²

” sp. indet.³

Pecten cf. *demissus* E. T. Newton. l. c. p. 498.

From the considerable difference in height between the appearance of clay-sandstone with numerous Lamellibranchs and the very numerous specimens of *Cadoceras Nanseni* n. sp. above Elmwood at 550 ft., and the clay at Windy Gully at height of about 400 ft. above the sea, containing *Macrocephalites Kættlitzii*, *pila*, etc. — the representatives of the Lower Callovian — it may *a priori* be assumed that the two different rocks belong to different zones. This assumption is supported and ultimately proved by the fauna of the clay-sandstone, which is wholly different from that of the clay at the south-west end of Windy Gully. Instead of *Macrocephalites*, we here find *Cadoceras* as the Ammonite of most common occurrence. This difference in the fauna is here not the consequence of different facies, but the result of temporal changes upon the fauna.

The occurrence of *Cadoceras Tchekini* d'Orb. sp., which, according to Newton's description, is affirmed to be in this locality and in the clay-sandstones, is of great importance in determining the age of the clay-sandstones. *Cadoceras Tchekini* d'Orb. sp. in northern and central Russia⁴, together with *Cadoceras Milaschewici* Nik., belongs to the very characteristic fossils of the Middle Callovian, of the Zone of *Cadoceras Milaschewici* of Nikitin = Zone of *Reineckia anceps* of Opperl.

By means of *Cadoceras Tchekini* d'Orb. sp., the Ammonites occurring together with it:

Cadoceras Nanseni n. sp.

¹ = *Amm. (Cadoceras) Tchekini* E. T. Newton, l. c. Pl. XXXIX, fig. 5.

² = *Amm. (Macrocephalites) macrocephalus* E. T. Newton l. c. Pl. XXXIX, figs. 1, 2.
+ *Amm. (Cadoceras) Tchekini?* d'Orb. E. T. Newton, l. c. Pl. XXXIX, f. fig. 6.

³ = *Amm. (Macrocephalites) macrocephalus* (var.) E. T. Newton l. c. Pl. XXXIX fig. 3

⁴ Petchora basin, Gov. Rjasan, Tambow, Twer, Jaroslaw, Kostroma, Samara and Orenburg. S. Nikitin (Quelques excursions dans les Musées et dans les terrains mésozoïques de l'Europe occidentale etc. Bull. de la Soc. Belge de Géol. etc. vol. III, p. 34) also mentions *Cadoceras Tchekini* d'Orb. sp. from the Callovian of England, and further as a rarity, from the Upper Callovian of the Upper Volga (Mém. de l'acad. imp. d. Se. St. Pétersbourg, S. VII, T. XXVIII, N. 5, pp. 20, 21, 26).

Cadoceras sp. indet. —

are also proved to be of the age of the Middle Callovian.

Owing to the fact, that the *Belemnites m. f. subextensus* Nik. — *Panderi* d'Orb., now before me (also from clay sandstone) is closer related to *Belemnites subextensus* Nik. than to *Belemnites Panderi* d'Orb. (which species only becomes more frequent in the Oxfordian, and continues up to the Volga-Stufe), the determination of the clay-sandstone as Middle Callovian also appears justifiable.

Without the accompanying Ammonites, the Lamellibranchiata in the clay-sandstone would afford no certain clue to the age of the rocks — the Lamellibranchiata in the Jura being, as a rule, less qualified for an exact determination of age than are the Ammonites. *Pecten Lindströmi* Tullberg¹, and *Macrodon Schourovski* F. Rouill. sp.² would point towards the Upper Jura-Malm. *Pseudomonotis* sp. (cf. *ornati* Quenst. sp.)³ admits of an alliance with the Middle and Upper Callovian and, through its relationship to *Limea duplicata* Goldf., ?*Limea* cf. *duplicata* permits of determinations from the Bathonian to the Oxfordian. Generally, however, the Lamellibranchiata from the clay-sandstone of locality 5 — watercourse below the basalt, just above (N. of) Elmwood — agree very well with the determination of age: Middle Callovian.

Besides clay-sandstones with the above-mentioned fossils I have before me, from the same locality, and from a height of about 550 ft, a fragment, embedded in gray-brown clay, of a body-chamber of *Cadoceras Tchefkini* d'Orb. sp., a species characteristic of the Middle Callovian. This piece affords evidence — which can also be obtained in other ways — that the Middle Callovian in the district of Cape Flora is not only in the form of beds of clay-sandstone, but that clayey strata also share in its composition.

As *Cadoceras Nanseni* n. sp. is considered to be a species belonging to the Middle Callovian, the

hard, gray or yellow stone-marl ("Steinmergel")

(p. 47) in which the presence of *Cadoceras Nanseni* n. sp.⁴ and (once) *Pseudo-*

¹ Only known, so far, from the Aucella strata of Novaja Semlja.

² From the Virgati strata of the Moscow Jura.

³ *Pseudomonotis ornati* was described by Quenstedt from the Ornatens-Clay of Württemberg.

⁴ Also a fragment of an indeterminate *Pecten*.

monotis sp. (cf. *ornati* Quenst. sp.) was proved, must also be designated Middle Callovian. These stone marls do not appear to have been observed *in situ*. The pieces before me are surrounded by a rusty-brown weather-crust; they were found *loose* on the talus in the localities

2. NNW. of Elmwood, 100 ft. above the sea;

4. South-western end of Windy Gully, ca. 400 ft. above the sea.

Doubtless the pieces have fallen out of layers which are at a greater height than 400 ft. Probably the stone marls with *Cadoceras Nanseni* are also *in situ* at a height of 550 ft. I have some pieces of rock before me from this level, which, petrographically, come between the stone-marls and the clay-sandstones.

In proving the presence of the

Lower Callovian at the south-western end of Windy Gully, at ca. 400 ft. and the

Middle Callovian above Elmwood at 550 ft.

the occurrences of Callovian in the region of Cape Flora are not exhausted.

On July 12th, 1896, Prof. Nansen collected a large number of fossils at locality 3

"At the margin of the glacier NNW. of Elmwood, 100—200 ft. above the sea", at a distance of 1½ kilometres from Elmwood [cf. p. 17. "Doubtful horizon".

Letter-press Fig. 1, g, h, Fig. 3, h]. These were:

<i>Cadoceras Frearsi</i> (d'Orb.) Nik.	}	free, probably from clay.
<i>Macrocephalites</i> sp.		
<i>Cadoceras</i> sp. indet. (casts of umbilici).	}	in phosphoritic nodules.
<i>Serpula flaccida</i> Goldf.		
<i>Cadoceras</i> sp. ex. aff. <i>Nanseni</i> n. sp.	}	in clay sandstone.
<i>Leda</i> cf. <i>nuda</i> Keys. sp.		
<i>Cadoceras Tchekkini</i> d'Orb. sp.	}	in gray, hard clay with a brownish weather crust.
<i>Belemnites</i> m. f. <i>subextensus</i> Nik.- <i>Panderi</i> d'Orb. ¹		
<i>Quenstedtoceras vertumnum</i> . Sintz.		

¹ Only one specimen of these *Belemnites* still shows traces of the surrounding clayey rock; all the other numerous pieces were found loose, washed out of the rock.

Pentacrinus sp. *ex. aff. bajoci-*
ensis P. de Lor. } loose, without adhering rock.
Amberleya sp. }

Moreover a large number of *phosphoritic nodules* without fossils, and several specimens of "cone-in-cone" (Tutenmergel) were found there.

None of the pieces in question have been taken from rocks *in situ* they were rather gathered, some from the "moraine" at the side of the glacier (circ. 200 ft. above the sea), some from a projecting rock¹ within the glacier, and some a little to the south-west of the glacier, below a basalt-rock at a height of 80—120 ft. above the sea, where the "clayey ground" was covered with loose pieces of "clay-ironstone".

As the various places of this locality cannot be distinguished from the labels of Prof. Nansen's collection (the labels bear only the inscription "12th July, 1896"), and as, moreover, a separation of the various places in which these loose specimens were found, is of no great importance, the fossils of July 12th, are here treated of as if originating from one locality.

The locality now to be discussed is that described in the report of the Jackson-Harmsworth Expedition², under "3. Elmwood", as "the side of the glacier at the western end of Cape Flora"; it is moreover, most probably identical with the locality specified in the above-mentioned report as "from the talus near Elmwood".

Newton includes under "3. Elmwood" both the place where the rocks collected from the "moraine" were found, and that where the clay-sandstones of the Middle Callovian were found, which rocks are *in situ* above Elmwood at about 350—450 ft. higher.

Among the fossils which Newton describes l. c. under "3. Elmwood", the following species refer to the locality "at the margin of the glacier":

Cadoceras Tchekini d'Orb. sp.³
 „ *stenolobum* (Keys.) Nik.⁴
 „ *Nanseni* n. sp.⁵

¹ There is unfortunately no record of the nature of this rock.

² E. T. Newton & J. J. H. Teall, l. c. Quart. Journ. vol. LIII, pp. 496, 497.

³ = *Amm. (Cadoceras) modiolaris* E. T. Newton, Pl. XXXIX, figs. 7 & 8.

⁴ = *Amm. (Cadoceras) Tchekini* ? d'Orb. E. T. Newton, Pl. XXXIX, fig. 5 + *Amm. (Cadoceras) modiolaris* E. T. Newton, Pl. XXXIX, fig. 9.

⁵ = *Amm. (Cadoceras) modiolaris*, "flattened variety" E. T. Newton. Pl. XXXIX, fig. 10.

Belemnites *mf. subextensus* Nik. — *Panderi* d'Orb.¹

Gorgonia(?) E. T. Newton.

(Phosphatic nodules).

The various fossils which were found loose belong to *various faunistic horizons*.

In the first place, *Cadoceras Frearsi* (d'Orb.) Nik.² p. Pl. II, fig. 10, must be referred to the *Lower Callovian*; probably also *Macrocephalites* sp. p. 73 Pl. II, fig. 11 (from its affinity to *Macrocephalites Koettlitzii* n. sp. and therefore to the group of *Macrocephalites Ishmæ* Keys. sp.). The two forms, of each of which there was only one specimen, were found without very much rock adhering to them. Judging from the nature of the nuclei, however, they have doubtless come from clayey rocks. These two Ammonites here represent the horizon that was found at the south-western end of Windy Gully, at a considerably higher level — ca. 400 ft. above the sea — i. e. the zone of *Macrocephalites macrocephalus*.

To the same horizon most probably belong a few casts of umbilici of *Cadoceras* sp. indet., consisting of blackish phosphorite with a pale gray, clayey weather crust. In these umbilical casts, I found, besides *Serpula flaccida* Goldf., a small fragment of a *Cadoceras*, whose lobe-line recalls the characteristic species of the Lower Callovian of Russia, viz. *Cadoceras Elatmæ* Nik.

To the *Middle Callovian* belongs a piece of *clay-sandstone*, containing *Cadoceras* sp. *ex. aff. Nanseni* n. sp. (p. 92, Pl. II, fig. 4), which is nearly allied to our *Cadoceras Nanseni*, and *Leda*, cf. *nuda* Keys. sp. (p. 66, fig. 11). *Leda nuda* Keys. sp. has, indeed, been found in the Petchora basin in the Upper Jura, and moreover, is mentioned from Spitzbergen, from the Aucella strata. Our form could not, however, be directly identified with *Leda nuda* Keys. sp.; it was only admitted that it resembled that species. The rock agrees perfectly with several pieces of the clay-sandstone *in situ* above Elmwood, 550 ft. above the sea, which we have decided is Middle Callovian. I therefore have no hesitation in also referring the rock with *Cadoceras* sp.

¹ = *Belemnites Panderi* E. T. Newton. Pl. XXXIX, figs. 11–14.

² Known from the Lower Callovian of the Russian government Tambow (Elatma), and of the Petchora basin.

ex. aff. Nanseni and *Leda cf. nuda* Keys. sp. to the Middle Callovian. Fragments of *Belemnites m.f. subextensus* Nik. — *Panderi* d'Orb., a species we already know as belonging to the Middle Callovian, were especially numerous in the "moraine" at the side of the glacier. Most of the pieces are without any adhering rock, and only one piece is enclosed in *gray clay, weathered a yellowish brown*. In the same rock, besides several quite indeterminable fragments of ammonites (*Cadoceras* ?) there were also various pieces of *Cadoceras Tchekini* d'Orb. sp., of which the best is figured on Pl. II, fig. 7. *Cadoceras Tchekini* — as already stated — is one of the most important fossils of the *Middle Callovian* of central and northern Russia.

Just as I now have before me fossils of the Middle Callovian from the débris at the edge of the glacier NW. of Elmwood, so also does the material which Newton examined from the same locality contain fossils of the same horizon. Newton, as far as one can judge of the material described by him, seems *only* to have had fossils of the *Middle Callovian* from this locality. Besides *Cadoceras Tchekini* d'Orb. sp., *Nanseni* n. sp., and *Belemnites m.f. subextensus* Nik. — *Panderi* d'Orb. sp., which I have before me, there is also *Cadoceras stenolobum* (Keys.) Nik. a very characteristic species of the Middle Callovian of Russia.

The most interesting of the fossils collected on July 12th, 1896, at the margin of the glacier, is unquestionably

Quenstedtoceras vertumnum, Sintzow¹.

(P. 96 Pl. II, fig 9.)

from gray clay, weathered a brownish yellow.

Sintzow records this species from the *zone of Quenstedtoceras Lamberti*, therefore from the

Upper Callovian

of the Russian geologists, from the Sukhaïa Jelchanka in the government Saratow.

¹ *Quenstedtoceras vertumnum* was the first fossil that I was able to determine after having received the material. Upon the occurrence of this species, I supported my first statement (communicated to Professor Nansen) of the occurrence of the *Lamberti* zone in the Jura of Cape Flora.

Quenstedtoceras vertumnum Sintzow belongs to the group of *Quenstedtoceras Mologæ* and *Rybinskianum*. Wherever this group occurs, it never appears earlier than in the Upper Callovian, as in Russia in the Jura of the Governments Rjasan, Twer, Jaroslaw, in the Lithuanian Jura, in Württemberg¹, and in France (Calvados)².

Even though *Quenstedtoceras vertumnum* Sintzow is the *only* fossil which is known to be of the age of the Upper Callovian, it is so characteristic that it proves without doubt the presence of this zone, i. e.

the strata with Quenstedtoceras Lamberti of the Russian geologists,
the zone of Peltoceras athleta of the German and French geologists,
in the Jura of the Cape Flora region.

Besides the above-mentioned fossils, the fragment of a stem of a *Pentacrinus* sp. ex. aff. *bajociensis* P. de Lor, discussed on p. 54 (Pl. I, fig. 1) was found on July 12th, immediately at the margin of the glacier at a

¹ *Amm. Lamberti inflatus* Quenst. 'Ammoniten' Pl. 90, fig. 16 from the "Lamberti Knollenschicht", and *Lamberti pinguis*, Pl. 90, fig. 22 from the Upper "Ornaton-Thon" of Beuren belong to this group.

² *Quenstedtoceras* appears nowhere earlier than in the zone of *Peltoceras athleta*. This can, of course, only be proved where a faunistic stratigraphic-separation between the zones of *Reineckia anceps* and *Peltoceras athleta*, with their respective equivalents, is possible, i. e. in most of the Jura districts of central and northern Russia, in Hanover, Württemberg and France. The Savoy and Engauld are apparently exceptions to this rule.

Parona and Bonarelli (Sur la faune du Callovien inferieur de Savoie. Mém. de l'acad. de Savoie vol. VI, 1895, p. 93. Pl. II, fig. 4) record a *Quenst. primigenium* n. sp. from Savoy, from the Lower Callovian (Chanazien). I cannot regard this form as a *Quenstedtoceras*; judging from its shape, involution and sculpturing (the lobe-line is not known), it is rather a *Cardioceras* and allied to *Cardioceras Chamussetti* d'Orb. sp.

From Yorkshire in England, *Quenstedtoceras* are mentioned both from the Kellaways Rock and from the Oxford Clay. To some extent, the determinations of some forms, e. g. *Quenstedtoceras Mariæ* d'Orb. sp. from Wiltshire, are incorrect. These are simply young *Cadoceras sublæve* Sow. sp. To some extent the occurrence of *Quenstedtoceras* in the Kellaways Rock, partly coinciding with the *Macrocephalus* zone, together with the other Ammonites (viz. *Peltoceras athleta* Phill. sp., *arduennense* d'Orb. sp., *Aspidoceras perarmatum* Sow. sp., *Cosmoceras Jason* Rein. sp., *Gulielmi* Sow. sp., *Hecticoceras lunula* Rein. sp., *Oppelia Beaugieri* d'Orb. sp., *Oekotraustes crenatus* Brug., sp., *Cardioceras excavatum* Sow. sp., *Quenstedtoceras Lamberti* Sow. sp., *flexicostatum* Phill. sp., *Mariæ* d'Orb. sp. etc., cf. 'The Jurassic Rocks of Britain.' vol. II, p. 236, etc., vol. V, p. 359, etc.) proves that the Kellaways Rock of the English geologists is not really everywhere, and especially not in Yorkshire, Lower Callovian, and Oxford Clay Upper Callovian. The Kellaways Rock and the Oxford Clay may be petrographically different facies of faunistically corresponding strata, and in both the Kellaways Rock (especially that of Yorkshire) and the Oxford Clay, the different zones of the Callovian, as they may be observed on the continent, cannot be separated.

height of 200 ft. above the sea, a fact which Prof. Nansen calls especial attention to in his diary. This piece, found together with fossils of the Callovian, shows in a most remarkable manner a closer affinity to species of the Bajocian than to more recent species. Whether it ought nevertheless to be referred to the Callovian, I cannot determine, as the piece, which is composed of dark, gray calcite, was found without any trace of adhering rock.

Amberleya sp. (p. 68) from the same locality probably belongs also to the Callovian; the more precise age of this form cannot be determined.

The fossils found loose on July 12th, 1896, at the margin of the glacier NW. of Elmwood, 100—200 ft. above the sea, are, as has already been shown, the faunistic representatives of the three separately-established zones in the Callovian of Russia, Württemberg (and Franconia), France, the Swiss Jura and Hanover, viz. those of:

- (3) *Peltoceras athleta*,
- (2) *Reineckia anceps*,
- (1) *Macrocephalites macrocephalus*.

While farther east, the zones of the Lower Callovian (south-western end of Windy Gully 400 ft.) and of the Middle Callovian (above Elmwood, 500—550 ft.) are distributed over a series of layers at least 150—200 ft. thick, and are *in situ* at a much higher level, we here find at the margin of the glacier NW. of Elmwood, the rocks and fossils of the Lower and Middle (and of the Upper) Callovian, *at an inconsiderable height above the sea* — 100 ft. — 200 ft. — consequently at least 200 ft. (up to 300) beneath the Lower Callovian at Windy Gully, and spread in loose blocks *over a considerably smaller vertical area*. This occurrence at a lower level, and *over a smaller vertical extent*, can be explained by a sinking of the strata west of Elmwood (vide p. 19), if it is in conjunction with a more pronounced dip¹ of the strata towards the north and north-west, than has been observed. The accumulation of the different rocks and fossils of the various zones can here also be partly due to the movement of the glacier. NW. of Elmwood, the glacier descending rapidly westwards and towards the sea can have carried rocks and fossils from various higher levels to this lower level.

¹ Professor Nansen records "horizontal layers" at the south-western end of Windy Gully, and Newton and Teall write (l. c. p. 512): "The sedimentary strata in the south of Franz Josef Land are believed to be regularly horizontal with only a slight dip to the north-east".

The clay containing *Quenstedtoceras vertumnum* must certainly have come originally from higher strata. Granted that the strata above Elmwood are undisturbed, this clay of the Upper Callovian, must there be *in situ* at a still greater height above the sea than the clay-sandstones, etc. with *Cadoceras Nanseni*, *Tchefkini* and the Lamellibranchiata belonging to the Middle Callovian. As the latter were observed above Elmwood, *in situ* at a height of about 550 ft. above the sea, the clay of the Upper Callovian with *Quenstedtoceras vertumnum* must here be situated immediately, or almost immediately below the basalt. According to Prof. Nansen the most commonly occurring rock of the Jura underlying the basalt at Cape Flora, is clay. The report of the Jackson-Harmsworth Expedition¹ records east of Elmwood "just below the basalt" (only about 8½" below it) "lighter coloured, brownish clay-shale, the thickness of which is not recorded". The Jackson-Harmsworth Expedition found no fossils in the latter. Most probably this clay, lying above the clay-sandstone and clay (with *Cadoceras Tchefkini*) of the Middle Callovian, belongs to the zone of *Quenstedtoceras Lamberti* of Russian geologists.

I cannot, of course, determine whether distinct stratigraphic limits can be drawn between the Middle and the Upper Callovian in the region of Cape Flora. The clay of the Middle Callovian with *Cadoceras Tchefkini* d'Orb. is not petrographically different from the clay of the Upper Callovian with *Quenstedtoceras vertumnum* Sintzow. Although the clays with *Cadoceras Tchefkini* etc. occur above the clay-sandstones of the Middle Callovian with *Cadoceras Nanseni* n. sp. etc., a limit petrographically recognisable could hardly be drawn between the Middle and the Upper Callovian. We are, however, not so much concerned with this matter, since our chief duty is the determination of the age only of the marine Jurassic strata occurring at Cape Flora.

There are still two types of sedimentary rocks to be mentioned, belonging to the Callovian of Cape Flora:

1. *Phosphoritic nodules.*

These were collected in various sizes, from that of a nut to that of a fist, on July 14th, at the south-western end of Windy Gully, at a height

¹ E. T. Newton and J. J. H. Teall, l. c. Quart. Journ. Geol. Soc. London, vol. LIII. p. 496.

of 400 ft., and on July 12th, at the margin of the glacier, at a height of 100—200 ft. above the sea. As some of these nodules, from the fossils they contained, viz.

Belemnites sp. indet. 1.

Cadoceras sp. indet. (? *Cad. Elatmæ* and others)

Serpula flaccida Goldf.,

were recognised as Lower Callovian, it seems natural also to refer the far more numerous nodules without fossils to the Lower Callovian. Thus from their occurrence in Windy Gully, the phosphoritic nodules would be confined to a height of about 400 ft. above the sea.

2. *Cone-in-cone* (*Tutenmergel, Nagelkalk*).

Several pieces were found loose on the talus on July 10th, NNW. of Elmwood, 100 ft., and on July 12th, at the margin of the glacier, 100 to 200 ft. above the sea. Petrographically the pieces agree perfectly with the stone marl of the Middle Callovian (with *Cadoceras Nanseni* n. sp.). Possibly for this reason, they also belong to the *Middle Callovian*. No pieces were observed *in situ*. Judging from their occurrence as débris on the edge of the glacier, at a height of about 200 ft., they must have been *in situ* at a higher level.

After becoming acquainted with the faunistic representatives of the *entire Callovian*, in the "clay formation" below the basalt at Cape Flora, the next point is to establish the age of the rocks and fossils of locality 1.

On Aug. 2nd, 1896, Professor Nansen found *in situ* at Elmwood NW. from the hut, at a height of 23—33 ft.,

hard, gray, sandy marl (with small agglomerations of pyrites), *together with light gray, soft marl* (cf. p. 11 "Lower horizon," Letter-press fig. 2, 1 a and p. 47. No. 4).

The material which Prof. Nansen collected at this locality contains:

Lingula Beani Phill.

Discina reflexa Sow. sp.

" sp. indet.

Pseudomonotis Jacksoni n. sp.

Belemnites sp. (cf. *Beyrichi* Opp.)

" " (? *Canaliculati* group)

" " indet. 2 (?).

With the exception of *Discina* sp. indet. and *Belemnites* sp. indet. 2, specimens of all the forms were found in large numbers, and, with the exception of these two forms, the species were all found both *in situ* and also loose, weathered out of the rock.

There are, moreover, very numerous remains of Lamellibranchs, but in so bad a state of preservation, and so fragmentary that they cannot be determined.

In the report of the Jackson-Harmsworth Expedition¹, mention is also made of

Avicula sp. cf. *inæquivalvis* (*Pseudomonotis Jacksoni*, n. sp.)

Belemnites div. sp. indet.

from the same locality, "SW. of Elmwood," "sandy shale."

Newton further mentions from this locality an "indeterminable" fragment of an Ammonite, which he determines as "allied to *A. Goverianus*". As neither description nor figure of this specimen is given, it is, of course, impossible to judge how far Newton's determination is correct. As no trace of Ammonites was to be found in the rather abundant rock-material which I examined from this locality, I am of opinion that the fragment mentioned by Newton does not originate from the rocks lying 23—33 ft. above the sea, but that it may have fallen from higher beds. Moreover, as Newton does not take this ammonite fragment into stratigraphic consideration at all, we may also ignore the reference to the Callovian, made on account of the "affinity" to *Cosmoceras* (*Keppleritis*) *Goverianum* Sow. sp. (if Newton's determination be correct), in the discussion of the age of the strata lying at a height of 23—33 ft. above the sea.

The great vertical distance between these beds and those of the Lower Callovian, situated at a height of 400 ft. above the sea, would *a priori* justify the supposition that here at Elmwood *older* horizons are developed than the Lower Callovian at the south-west end of Windy Gully. As far as the fossils from our locality No. 1 were determinable, the fauna fully confirms this opinion. It shows a composition wholly different from that with which we are acquainted in the fauna of the Callovian of Windy Gully, above Elmwood, and at the edge of the glacier.

¹ E. T. Newton and J. J. H. Teall, l. c. Quart. Journ. Geol. Soc. London, vol. LIII, p. 502.

The fauna of the strata found NW. of Elmwood near the shore is distinguished by the particularly abundant remains of *Pseudomonotis Jacksoni* n. sp. The frequent occurrence of a *Pseudomonotis* might lead to the supposition that we have before us deposits of Triassic age, as *Pseudomonotis* species play a very important role in the Trias strata of the Pacific and Arctic regions (Siberia, Spitzbergen). But apart from the fact that our species shows no correspondence with such Triassic *Pseudomonotis*, its occurrence together with *Belemnites* also proves, that we cannot have to do here with deposits of Triassic age. The Elmwood deposits, which lie a short distance NW. of the hut, at a height of from 23 to 33 feet above the sea, must belong to the Jura. In the Jura also, the *Pseudomonotis* are of no uncommon occurrence; in certain horizons they even preponderate: I may mention *Pseudomonotis substriata* in the Upper Lias, *Pseudomonotis elegans* in the Bajocian, *Pseudomonotis echinata* in the Bathonian.

Pseudomonotis Jacksoni is worthless, as a new species, for the accurate determination of the horizon.

The *Brachiopoda* found together with *Pseudomonotis Jacksoni* are of greater importance. Although, on the basis of these forms, it is not possible to determine with absolute certainty a single faunistic zone, yet they point to the *Brown Jura*, but not the *Callovian*.

Lingula Beani Phill. is not confined to a single faunistic zone. In Yorkshire it occurs in the Blea Wyke Beds, and perhaps also in the so called "Dogger", consequently in the zones of *Leioceras opalinum* and *Ludwigia Murchisonae*. Brauns records it from the zone of *Trigonia navis* of north-western Germany. Quenstedt mentions it from the zone of *Ludwigia Murchisonae* of Württemberg. Lepsius and Haas found it in the zone of *Sphæroceras Sauzei* of Lower Alsace. Terquem and Joudry record *Lingula Beani* from the zone of *Amm. subfurcatus* and *Niortensis*, in the department Moselle. Trautschold claims to have found *Lingula Beani* even in the "Couches de Mniowniki" of the Jura of Moscow. The imperfect illustration and description which Trautschold gives of his *Lingula Beani* does not suffice for determination as to whether the true *Lingula Beani* really does occur in such high horizons. *Lingula*

Beani Trautsch. is, moreover, otherwise interpreted from Lahusen and Eichwald^{1,2}.

Leaving the last, unauthenticated occurrence, out of consideration, *Lingula Beani* Phill. is principally distributed in various, especially lower, zones of *Bajocian*.

Discina reflexa Sow. sp. has a similar distribution³. It perhaps occurs already in the Lias of England; it is especially frequent in the Blea Wyke Beds, and is perhaps also found in the "Dogger" of Yorkshire. Quenstedt mentions it from the Opalinus Clay of Boll in Württemberg, and Lepsius has found it in strata of the same age at Gundershofen in Alsace⁴. Trautschold's statement that *Discina reflexa* occurs in his middle stratum of the Jura of Moscow, is as doubtful as is the same author's statement about the *Lingula Beani* Phill.

As we have seen, *Discina reflexa* Sow. sp., as also *Lingula Beani* Phill. is principally confined to the *Bajocian*.

The two species, *Lingula Beani* Phill. and *Discina reflexa* Sow. sp., have hitherto never been found together, except in the Blea Wyke Beds of Yorkshire, i. e. in the very lowest zones of the *Bajocian* (viz. in the *Aalénien* May.-Eym. Haug. e. p.).

The *Belemnite* remains from the sandy hard marl and the light gray marl of Elmwood, are too imperfect to allow of any accurate specific determination. Only this much can be stated with certainty, that they agree neither with the species from the Callovian of Cape Flora, nor with species from the Callovian on the whole, of arctic regions, Russia and other parts.

If the best preserved (and most frequently occurring) remains of *Belemnites*, which were compared with *Belemnites Beyrichi* Opp. in the description of the fauna, are really closely allied to this species, this would indicate the

¹ Conf. the works cited on p. 54 & 55, and A. Pavlow, 'Études sur less couches jurassiques et crétaées de la Russie, I, Jurassique supérieure et Crétaée inférieure de la Russie et de l'Angleterre'. Bull. de la Soc. Imp. des Natural. de Moscou, 1889, No. 1, p. 42.

² Fiebelkorn (Zeitschr. d. Deutsch. Geol. Ges. 1893, p. 445) unites *Lingula ovalis* Sow. *Beani* Phill. and *Zeta* Quenst. erroneously, however, and thus gives to *Lingula Beani* the same wide distribution as Trautschold.

³ Conf. works cited on p. 58.

⁴ H. J. Haas makes a new species of this Alsatian form, viz. *Disc. Quenstedti*. (cf. Haas and Petri, 'Die Brachiopoden der Juraformation von Elsass-Lothringen', 1882, p. 306).

Bathonian. It must not, however, be forgotten that kindred species (from the group of the *Hastati*) also occur in the Bajocian; in the Upper Bajocian *Bel. Württembergicus* Opp. (= *fusiformis* Quenst. non Park.), and in the Lower Bajocian, in the zone of *Trigonia navis* among the *Belemnites* generally designated as *Bel. subclavatus* Voltz, specimens may be found which are decidedly *Hastati*, and which appear very similar to *Bel. Württembergicus* and *Beyrichi*.

Still less than *Belemnites* sp. (cf. *Beyrichi* Opp.), the fragments possibly belonging to the group of the *Canaliculati* can serve for the determination of the age of the rocks west of Elmwood. The small, detached fragment of *Belemnites* sp. indet. 2 (Pl. I. fig. 24), possibly does not come from the stratum here under consideration, but may have fallen from higher strata.

Thus only the two *Brachiopods*, *Lingula Beani* Phill. and *Discina reflexa* Sow. sp. furnish any clue to the determination of the age of the deposits containing *Pseudomonotis Jacksoni* n. sp., and an abundance of *Lamellibranchs*. They point to the

Bajocian.

As it has hitherto only been in the Blea Wyke Beds (and in the "Dogger") of Yorkshire that the two species have been observed occurring together, we might probably also designate the strata exposed NW. of Elmwood at a height of 23—33 ft. above the sea, in which these two species occur together, as

Lower Bajocian,

almost corresponding to the zone of Leioceras opalinum and Ludwigia Murchisonæ. The great vertical distance — circ. 350 ft. — from the hard, sandy marl and soft marl containing Pseudomonotis Jacksoni, Lingula Beani, Discina reflexa, etc. to the clay of the Lower Callovian (at Windy Gully), lying at a height of 400 ft., may be mentioned as an additional support to our determination of the age of the strata west of Elmwood.

Marine Jura deposits other than those here mentioned cannot be observed in the material before me.

The study of the fossils and rocks collected by Prof. Nansen, and the critical examination of the fossils from the Jackson-Harmsworth Expedition, described by Newton, give the following results with regard to the Jura occurring below the basalt at Cape Flora.

As far as the slight exposures of rocks *in situ* permitted of observation, the Jura deposits of Cape Flora are composed of clay and slate-clay, interstratified with hard sandy marl, beds of stone marl and clay-sandstone, with "cone-in-cone", and phosphatic nodules, and thin layers of lignite and basalt.

The lowest¹ fossiliferous beds correspond with the

Bajocian,

and probably with the *Lower Bajocian*. At a height of from 23 to 33 feet above the sea, to the north-west, only some 300 metres from Elmwood, there occur gray, hard, sandy marls, and light gray, soft marl, in which were found:

Lingula Beani Phill.

Discina reflexa Sow. sp.

" sp. indet.

Pseudomonotis Jacksoni n. sp.

Belemnites sp. (cf. *Beyrichi* Opp.)

" sp. (?Group of *Canaliculati*).

Numerous fragments of indeterminable Lamellibranchs.

The upper third of the sedimentary strata below the basalt — from 370 to 575 feet above the sea — contains deposits of the age of the

Callovian

and the three divisions of the Callovian are all recognisable, viz:

the *Lower Callovian*

(= zone of *Macrocephalites macrocephalus*, = zone of *Cadoceras Elatmæ*).

At a height of 370—450 feet above the sea, there occur clays which are partly phosphoritic, and contain scattered phosphatic nodules (south-western end of *Windy Gully*). The fossils of the Lower Callovian, some found *in situ*, some loose near the margin of the glacier north-west of Elmwood, are:

¹ The thin alternating estuarine strata of sand with carboniferous seams, about 100 m. S. from Elmwood, possibly corresponding with the Cape Gertrude strata [cf. p. 12 (b), Letter-press fig. 1, b and p. 32], are certainly older than the Bajocian beds with *Lingula Beani* etc., but the true age, of these layers cannot be made out with certainty.

- Serpula flaccida* Goldf.
Macrocephalites Koettlitzii n. sp.
 " sp.
 1* " *Ishmæ* var. *arctica* E. T. Newton.
 * " *pila* Nik.
Cadoceras Frearsi (d'Orb.) Nik.
 " sp. sp. (? *Elatmæ* Nik.)
Belemnites sp. indet. 1.

The Middle Callovian

(= zone of *Reineckia anceps*, = zone of *Cadoceras Milaschewici*).

Above *Elmwood*, at a height of 500—550 feet above the sea, lie beds of clay-sandstone of the Middle Callovian; and at the same locality, loose pieces of a clay of the same age were found. Pieces of clay-sandstone, clay and stone marl, which, judging from the fossils they contain, belong to the Middle Callovian, were moreover found loose at various heights, in several parts of the talus heaps. The occurrences of "cone-in-cone" may also be reckoned as belonging to the Middle Callovian.

The fossils of the Middle Callovian of Cape Flora are:

- Pseudomonotis* sp. (cf. *ornati* Quenst).
Pecten Lindströmi Tullberg.
 * " cf. *demissus* E. T. Newton.
 ? *Limea* cf. *duplicata* Goldf.
Lima sp. indet.
Leda cf. *nuda* Keys. sp.
Macrodon Schourovski F. Rouill. sp.
Cadoceras Tchekini d'Orb. sp.
 * " *stenolobum* (Keys.) Nik.
 " *Nanseni* n. sp.
 " sp. ex. aff. *Nanseni* n. sp.
 " sp. indet.

Belemnites m. f. *subextensus* Nik. — *Panderi* d'Orb.

¹ The fossils marked by an asterisk are taken from the (revised) descriptions by E. T. Newton.

The *Upper Callovian*

(= zone of *Peltoceras athleta*, = zone of *Quenstedtoceras Lamberti*).

Information concerning this zone has hitherto only been obtained from a piece of clay found loose *near the margin of the glacier NW. of Elmwood*, and containing *Quenstedtoceras vertumnium* Sintzow. Rocks of this zone have not hitherto been observed *in situ* with any certainty, but it is probable that the clays near the lower limit of the basalt above Elmwood, at a height of 575 feet above sea-level, are to be referred to the Upper Callovian.

From the foregoing remarks, we may draw up the following table (p. 131) of the stratigraphic proportions of the Jura in the Cape Flora district.

It is impossible from the material before me to determine whether the great gap between the (Lower) Bajocian and the Lower Callovian in this profile includes a representation of the younger Bajocian and the Bathonian. Apparently no exposures of rocks *in situ* have been observed between the (Lower) Bajocian — from 23 to 33 ft. above the sea — and the Lower Callovian — 370—450 ft. —; as everything here appears to be covered by talus heaps.

It is also impossible to determine the true thickness and limits of the different zones. We can only show that the Callovian in the district of Cape Flora has a thickness of at least 200 ft., which is a thickness seldom attained by the Callovian of Europe and which is only surpassed by the deposits of the same age in England and NW. France.

The results of our investigations differ in no slight degree from those which Newton arrived at from his examination of the Jackson-Harmsworth-Expedition material¹.

In his stratigraphic inferences, Newton starts from his locality "3. Elmwood" e. p. (our locality 5, watercourse below the basalt above Elmwood). Here, at a height of about 550 ft. above the sea (according to Dr. Kœttlitz), interstratifications of clay-sandstone are exposed, which, according to our determination, belong to the Middle Callovian. I here quote from Newton: "At this spot a bed (No. 3) was found *in situ*, and from it a small ammo-

¹ Quart. Journ. Geol. Soc. London, vol. LIII, p. 512.

nite was obtained, which is probably *Ammonites Tchefkini*. In the water-course below this exposure, similar ammonites were found, together with *A. modiolaris* and *A. macrocephalus*. These suffice to settle the age as Lower Oxfordian, and probably the equivalent of our own Kellaways Rock; and although only one ammonite was found *in situ*, yet it is sufficiently certain that the others, if not from the same place, came from beds but little lower in the series. Similar fossils to these occur in the talus at many places around Cape Flora, showing that the same beds in all probability occur all around the Cape."

A few lines further on, Newton settles the age of these fossils as the "Ammonites macrocephalus horizon."

Newton's determination of the fossils from this locality is erroneous in some cases; his *Amm. macrocephalus* is *Cadoceras Nanseni* n. sp.; his *Amm. modiolaris* is partly *Cadoceras Tchefkini* d'Orb. sp., partly *Cadoceras stenolobum* (Keys.) Nik.; his *Amm. Tchefkini* ? d'Orb. is partly really *Cadoceras Tchefkini* d'Orb. sp., partly *Cadoceras stenolobum* (Keys.) Nik. All the fossils, like those from this locality that I have examined, point to the Middle Callovian, the zone of *Reineckia anceps* or of *Cadoceras Milashevici*, not to the Lower Callovian, nor to the "Ammonites macrocephalus horizon." *Macrocephalites macrocephalus* Schloth. sp. is not among the fossils hitherto known from the region of Cape Flora.

Newton must consequently declare the beds at the southwest end of Windy Gully — *in situ*, according to Prof. Nansen and Dr. Kœettlitz, 50—180 ft. deeper — to be older than his "Ammonites macrocephalus horizon". He described them as "perhaps of the age of the *Cornbrash*" (l. c. p. 513). We recognised in them representatives of the *Lower Callovian*, of the zone of *Macrocephalites macrocephalus* of Oppel, or of that of *Cadoceras Elatmæ* of Nikitin.

Newton's paper contains no information as to the occurrence of the Upper Callovian in the region of Cape Flora.

Concerning the age of the hard, sandy marls, and the light, soft marls lying at a height of 23—33 ft. above the sea, which we designated as (Lower) Bajocian, Newton expresses no opinion.

After we have thus partly revised Newton's stratigraphic results through the evidence of the Lower and Middle Callovian, partly supplemented them through the evidence of the (Lower) Bajocian and the Upper Callovian, the gap disappears, which, according to Newton's results, existed between the youngest marine strata of the Jura below the basalt, and the sandstones containing land-plants found north of Elmwood, and, belonging to the White Jura according to Professor Nathorst.

Newton (l. c. p. 512) supposes that the Belemnites found at Eira Harbour during Leigh Smith's expedition, and which Etheridge declared to be of Oxfordian age, are probably of the same age as the Macrocephalus horizon of Cape Flora (according to Newton's interpretation). If the Belemnites found at Eira Harbour agree with *Belemnites m. f. subextensus* Nik. — *Panderi* d'Orb., frequently found at Cape Flora, they must belong to the Middle, and not to the Lower Callovian.

V.

FACIES, FAUNISTIC CHARACTERS AND RELATIONS TO OTHER JURA FAUNAS.

In his sketch of the geology of Franz Josef Land, Dr. Kœttlitz¹ demonstrated frequent changes in the petrographic facies of the strata composing the Jura in the south of the Archipelago. Littoral and estuarine deposits alternate with beds of marine character: the southern part of the archipelago (especially Northbrook Island) must have belonged to a Jurassic coast region.

The examination of the material collected by Prof. Nansen confirms the statement regarding frequent change in the petrographic and faunistic characters, in the Jura region of Cape Flora.

The hard, sandy marls with the very numerous remains of Lamellibranchiata in the (Lower) Bajocian, represent the deposits of a littoral region or of a shallow sea near the coast. In the same way, the beds of clay sandstone of the Middle Callovian with *Cadoceras Nanseni* n. sp. and numerous Lamellibranchs may be interpreted as typical littoral deposits. The formation of the Lower, and of a part of the Middle and Upper Callovian in the shape of clayey and marly sediments, shows a less typical littoral character. But in the formation of these layers also, terrigene materials have a share. If we cannot directly declare the littoral region itself to have deposited these strata, yet we can imagine them to have been formed in shallow water, and indeed, at no great distance from the shore, as is proved by the traces, however indistinct, of vegetation in the stone marls of the Middle Callovian and by the occurrence of phosphatic nodules in the Lower Callovian.

¹ The Geographical Journal, London, 1898, vol. XI. p. 33.

The frequent petrographic changes in the Jura of Cape Flora to which Dr. Kœttlitz first called attention, indicate repeated oscillations of level in our region during Jurassic times. It is only in littoral regions and shallow seas that oscillations of sea-level with the consequent displacement of the coast line can exert so strong an influence upon petrographic facies, as for instance in the Callovian of Cape Flora (clay, stone marl, clay-sandstone, clay).

The last oscillations of level which took place in our region in Jurassic times, are indicated by the sandstones containing Upper Jurassic land-plants which occur north of Cape Flora, above the basalt, and according to Dr. Kœttlitz, at the south side of the Cape, between the second and third basalt flows. These sandstones characterise a period of upheaval of our region. The southern portion of Franz Josef Land rose out of the sea in Upper Jurassic times.

It is a peculiar fact that in all the known fossils from the marine jura of Cape Flora, the Gastropoda are represented by a single specimen only.

It may be that the collections are still imperfect, and do not therefore give an accurate or complete idea of the composition of the Jurassic fauna here: but in any case, they may be presumed to be sufficiently perfect to justify the conclusion that in comparison with the predominating Lamellibranchs and Cephalopods, the Gastropods play an unimportant role in the Dogger fauna of Cape Flora.

Great scarcity of Gastropods appears to be generally characteristic of the Jurassic fauna of the arctic regions, for, as far as we are acquainted with such faunas in East Greenland, the island of Andø, Spitzbergen, Cape Flora, Novaja Semlja, the Petchora basin, arctic Siberia, Alaska and the arctic archipelago of North America, the Gastropods in several of these faunas are considerably behind the other groups as regards numbers; and in others appear to be wholly absent.

With regard to the scarcity of Gastropoda, the Jurassic Fauna of Cape Flora, like the arctic Jurassic fauna generally, shows a great resemblance to that of the Russian Jura, in which also the Gastropods are in considerably smaller numbers than the Cephalopods and Lamellibranchs.

If we ask about the relations existing *between the fauna of the Jura of Cape Flora, and the faunas of other Jurassic regions*, we cannot yet obtain an altogether satisfactory answer.

With regard in the first place to the *Bajocian*, we cannot of course think of any comparison with the geographically adjacent Jura districts of Russia; for in the whole of east and north central Russia the series of marine Jura deposits only begins with the Callovian.

It is uncertain whether deposits of the age of the Bajocian occur only at Cape Flora, or also in other arctic regions. Toula¹ describes from Kuhn Island in East Greenland a Jurassic fauna, rich in Lamellibranchs, which he designated "Middle Dogger". The occurrence in this Dogger fauna of a Belemnite resembling *Belemnites fusiformis* Quenst., is interesting; and we have already seen that our *Belemnites* sp. (cf. *Beyrichi* Opp.) from the Bajocian of Cape Flora was allied to *Bel. fusiformis* Quenst. = *Württembergicus* Opp. It is extremely doubtful whether we ought to conclude from the occurrence of such a Belemnite, that a close affinity exists between the fauna of the Bajocian at Cape Flora, and the Dogger of Kuhn Island, from whence Toula, moreover, mentions *Goniomya Vscripta* Sow. i. e. a species already occurring in the Lower Bajocian. The circumstance worthy of notice is that both in the Dogger of Kuhn Island, and in the Bajocian of Cape Flora — that is in high arctic regions — the group of hastate Belemnites occurs, which, according to Neumayr, is wanting in the boreal and Russian Jura².

There is only one more region within the polar circle, where Jura deposits older than the Callovian, certainly occur, Wilkie Point, Prince Patrick's Island, from which Haughton³ described a few fossils as Lias. Neumayr⁴ declared them to "belong probably to the middle region of the Lower Oolite." In this faunula, an Aviculid form, "*Monotis septentrionalis* Haught. occurs, which however shows no similarity to our *Pseudomonotis Jacksoni* n. sp. from the Bajocian of Cape Flora.

¹ F. Toula, 'Beschreibung mesozoischer Versteinerungen von der Kuhn-Insel. 2. Dogger der Kuhn-Insel'. (Die zweite Deutsche Nordpolarfahrt in den Jahren 1869 und 70, vol. II. 2, pp. 505–507.)

² M. Neumayr, 'Ueber klimatische Zonen während der Jura- und Kreidezeit'. Denkschr. Akad. Wien, vol. XLVII. 1883, pp. 12, 13.

³ M'Clintock, 'Reminiscences of arctic ice-travel in search of Sir John Franklin and his companions, with geological notes and illustrations by S. Haughton.' Journ. R. Dublin Soc., vol. I. 1856, 57, Sep. copy pp. 56, 62, 63.

⁴ M. Neumayr, 'Die geographische Verbreitung der Juraformation'. Denkschr. Akad. Wien, vol. L. 1885, pp. 38, 85.

In the fauna, which Lundgreen¹ described from Cape Stewart in East Greenland, there are possibly species of older zones, besides those of the Callovian. No affinity to our Bajocian, however, is discernible. The *Lingula* sp. described by Lundgreen is certainly not *Lingula Beani* Phill., and Lundgreen's *Avicula Münsteri* is different from our *Pseudomonotis Jacksoni*.

While the fauna of the *Bajocian* of Cape Flora is without analogy in the arctic regions, it shows, on the other hand, distinct affinities to the *Central European Jura*. *Lingula Beani* Phill. and *Discina reflexa* Sow. sp. are Central European species. *Belemnites* sp. (cf. *Beyrichi* Opp.) also has its nearest known kin in the Central European Jura: *Belemnites Württembergicus* Opp. (*fusiformis* Quenst.) in Württemberg and Franconia; *Belemnites Beyrichi* Opp. in the same places, and also in the Silesian and Polish Jura, and in that of Balin near Cracow. It would, however, be precipitate to draw from these facts the conclusion that at Cape Flora the Bajocian is formed of a totally Central European fauna. In order to pronounce any definitive judgment in this respect, we must first become acquainted with the numerous Lamellibranchs which in addition to *Pseudomonotis Jacksoni* occur in the Bajocian of Cape Flora, but whose remains have as yet been quite indeterminable. For this purpose, we must in general have a more comprehensive idea of the entire fauna of the Bajocian of Cape Flora. Yet we must maintain that the indication towards Central European fauna, given by *Lingula Beani*, *Discina reflexa* and the hastate Belemnites is very important from a palæo-geographical point of view.

We are able to judge with more certainty as to the fauna of the *Callovian* of Cape Flora, than as to that of the Bajocian.

The fossils of the Callovian naturally suggest comparison first with those of the Russian Jura. The occurrence of the Ammonite genera *Macrocephalites*, *Cadoceras* and *Quenstedtoceras*, which are among the most typical of the Russian Callovian, indicate faunistic analogies between the Callovian of Cape Flora, and that of Russia.

Macrocephalites pila Nik.

Cadoceras Tchekini d'Orb. sp.

¹ B. Lundgreen, 'Anmärkingar om några Jurafossil från Kap Stewart i Ost-Grönland.' Meddelelser om Grönland, vol. XIX. 1895, pp. 191, etc.

Cadoceras stenotobum [Keys.] Nik.

„ *Frearsi* (d'Orb.) Nik.

Quenstedtoceras vertumnum Sintz.

are species which are also peculiar to the Callovian of central and northern Russia.

Macrocephalites Koettlitzii n. sp.

„ *Ishmæ* var. *artica* E. T. Newton.

Cadoceras Nanseni n. sp.

„ sp. ex. aff. *Nanseni* n. sp.

are forms which are very closely allied to Russian ones, especially those from the Callovian of the Petchora region.

Belemnites m. f. *subextensus* Nik. — *Panderi* d'Orb., which is of frequent occurrence in the Middle Callovian of Cape Flora, is remarkable for its close affinity to a species of the Russian Middle Callovian, *Belemnites subextensus* Nik.

Among the Lamellibranchiata of the Callovian,

Macrodon Schourovski F. Rouill. sp.

Leda cf. *nuda* Keys. sp.

Pecten Lindströmi Tullbg.

point partly to the Russian fauna, partly, like *Pecten Lindströmi*, to a fauna similar to the Russian.

These facts will be sufficient to place the fauna of the Callovian of Cape Flora very near to that of the Russian Callovian. *Our Callovian fauna is nothing but a part of the fauna of the Russian Callovian.*

Close faunistic relations exist, moreover, to the fauna of the Callovian of *Ataska* from which district we are acquainted, through Grewingk¹ and Eichwald², with Ammonites that have the closest affinity to *Cadoceras Tchefkini* d'Orb. sp. — i. e. *Cadoceras Wossnessenski* Grew. sp., *Cadoceras Doroshini* Eichw. sp., *Cad. Ishmæ* Eichw. sp. (not *Macrocephalites Ishmæ* Keys. sp.).

¹ C. Grewingk, 'Beitrag zur Kenntnis der orographischen und geognostischen Beschaffenheit der Nordwestküste Amerikas mit den anliegenden Inseln.' Verhandl. d. Russ. Kais. Mineral. Ges. St. Petersburg, 1848, 49, p. 344.

² E. v. Eichwald, 'Geognostisch-Palaeontologische Bemerkungen über die Halbinsel Mangischlak und die Aleutischen Inseln.' 1871.

It is very remarkable that there is scarcely any faunistic affinity between the fauna of the Callovian of Cape Flora and that of the Callovian of Cape Stewart in East Greenland. Among the numerous Lamellibranchs, which Lundgreen describes from this place, *Pecten Rinki* Lundgr. is perhaps near to our *Pecten Lindströmi* Tullbg. Otherwise, I find no species in the fauna of Cape Stewart, which even approximately corresponds to any of the species from the Callovian of Cape Flora.

As far as we can tell from our present knowledge, the very same words apply to the Callovian of Cape Flora as those with which Trautschold¹ characterised the affinity of the *Aucella strata* of Novaja Semlja to the Russian Jura. He says: "Generally speaking there is no doubt that the Jura-facies of the northern islands are the same as those of the Russian Jura, and that this northern Jura is nearest to that of the Petschora and Wytshcegda, which is also very natural".

This can naturally, only apply here in the restricted sense of our *Callovian*.

¹ S. A. Tullberg, 'Ueber Versteinerungen aus den Aucellen-Schichten Novaja-Semljas', Bihang t. K. Svensk. Vet. Ak. Handl., vol. VI, No. 3, 1881, p. 5.

VI.

PALÆO-GEOGRAPHICAL REMARKS.

The Jura of Cape Flora will be of the greatest importance to the geography of the Jurassic system.

Here, in 80° N, Lat., we make acquaintance with the most northerly Jura region of the earth¹.

One point of particular importance is the formation of *marine Bajocian* at Cape Flora. *Hence the existence of a Bajocian sea in the north of the Eurasian Juracontinent is proved beyond all doubt.* The occurrence of true European species such as *Lingula Beani* Phill., *Discina reflexa* Sow. sp. also of *Belemnites* sp. (cf. *Beyrichi* Opp.) at Cape Flora proves undeniably the connection of this arctic Bajocian sea with the central and western European sea of the Bajocian period, and especially a connection with the Bajocian sea of Yorkshire, and England generally. A connection of this kind is only possible in the west of the Eurasian continent, west of its Scandinavian part. Thus, *as early as the Bajocian period, there existed a "Shetland Straits"* (Neumayr), *which separated the Eurasian continent existing through the Lias period until the end of the Bathonian, from the nearctic Juracontinent* (Neumayr).

The Shetland Straits of the Bajocian must have extended westwards from the Lofoten island Andø, for Lundgreen² recently proved with certainty that the marine Jura fossils of Andø cannot be older than the Oxfordian.

¹ The Jura of Spitzbergen extends from about 77°, 40' to 78°, 20' N. Lat. During his last polar expedition, at about 79° Prof. Nathorst discovered Jura on Kong Carl's Land. The Jura of Kuhn Island lies in about 75° N. Lat., and the Jura of the arctic archipelago of N. America in 76°—77° N. Lat.

² B. Lundgreen, 'Anmärkningar om Faunan i Andøus Jurabildningar.' Christiania Vidensk. Selsk. Forh. 1894, No. 5.

Concerning *the extent of the Bajocian sea in the polar regions*, we can at present say but little. Whether it extended to the Greenland coast of the nearctic continent, and perhaps had its most westerly offshoots in the Dogger of Kuhn Island, cannot yet be settled. Up to the present we possess no clue as to whether, or how, the arctic Bajocian sea, of which the present Cape Flora was a part, was connected with the Bajocian(?) sea of the North American arctic archipelago.

Besides the existence of an arctic Bajocian sea, we can only prove the existence of arctic Bajocian continents, without being able to determine their border. The north of the Eurasian continent extended into the polar regions, as did also the north-east of the nearctic continent. It follows from the littoral facies and fauna of the Bajocian at Cape Flora, that a coast must have existed near this region, — there must have been a continent in the vicinity of Cape Flora.

Our knowledge of the geology of Spitzbergen leads to the supposition that in Bajocian times this group of islands was not covered by the sea.

The oldest Jurassic deposits of Spitzbergen hitherto known, are *Aucellastrata* with *Cardioceras Nathorsti* Lundgr. sp.¹ [= Upper Oxfordian]. From Novaja Semlja older marine Jura deposits than *Aucella strata* are not known. Both Spitzbergen and Novaja Semlja were mainland in Bajocian times. They were probably connected with the Scandinavian-Russian part of the Eurasian continent, and were probably also connected with one another by continuous land. Probably the arctic sea of the Bajocian flowed to the north and west of this offshoot of the Eurasian continent, which extended into the region of south Franz Josef Land.

The identification of Bajocian in the region of Cape Flora is important, because it helps to reduce the great difference which, from what we knew hitherto, appeared to exist between the extent of the Callovian sea, and that of the older Jura seas. This takes us on a step, if only a small one, in the recognition that in the distribution of sea and land upon the earth, the same state of equilibrium was maintained in the older Jura periods, as that with which we are acquainted from the Callovian period.

After proving the existence of the Callovian in the south of Franz Josef Land archipelago, the extent of the Callovian is increased by nearly 10 degrees

¹ According to a letter from Prof. Nathorst, dated Decbr. 17, 1898.

of latitude. Its most northerly occurrence hitherto known, at Cape Stewart in East Greenland, was in 70° 25' N. Lat.

The frequent change of facies, together with the character of the fauna, gives to the Callovian of Cape Flora partly a littoral, partly a shallow-water character. For some time at least in the Middle Callovian, continents — coast regions — must have existed near the marine region of the Callovian of Cape Flora. The very close faunistic affinity of our Callovian to the Russian necessitates a marine connection of our Callovian with that of Northern Russia, especially that of the Petchora basin. Hence, as also from the facies character, we conclude that in the Callovian period, the south-west part of the present Franz Josef Land has been covered by the sea, i. e. by a branch of the Russian Callovian sea.

Nor was Novaja Semlja in the Callovian period yet covered by the sea. Most probably the whole of Spitzbergen also projected from the Callovian sea; for the *Amm. triplicatus* Sow. from Spitzbergen, described by Lindström¹, does not permit of the conclusion that this Ammonite might agree with the typical species of the Callovian: *Perisphinctes funatus* Opp. sp. = *Amm. triplicatus* Quenst. Fraas² also mentions an *Amm. triplicatus* from Spitzbergen, adding that it might also be called by the name of any *Perisphinctes*. I was able to examine the original of Fraas³. It is the impression of the inner whorls of a large *Cardioceras*, and not of a *Perisphinctes*. According to all that is known concerning it, the marine Jura of Spitzbergen begins, at the earliest, with the Upper Oxfordian.

From the above, we may imagine the connection of the Callovian of Cape Flora with that of Northern Russia to be like a continuation northwards of the Russian Callovian sea of the Petchora basin, in the form of a broad bay, which stretched between the lands of Spitzbergen and Novaja Semlja, and was partly bounded on the north by land, in the region of the present Franz Josef Land.

We do not know whether Spitzbergen was yet united to the Scandinavian-Finnish peninsula in the Callovian period. This peninsula, after the Batho-

¹ G. Lindström, 'Om Trias- och Juraförsteningar från Spetsbergen', K. Svensk. Vet. Ak. Handl., vol. 6, No. 6, 1865, p. 10, pl. III, figs. 1, 2.

² Neues Jahrbuch für Mineralogie, etc. 1872, p. 203.

³ Prof. Eb. Fraas of Stuttgart had the kindness to allow me to examine the material studied by his father. I take this opportunity of tendering him my warmest thanks.

nian, was separated, as "Scandinavian Island" (Neumayr), from the Eurasian continent, by the Russian sea. Probably Spitzbergen was connected with the Callovian land of Franz Josef Land, as seems evident from the resemblance of the Upper Jurassic floras of these regions to one another¹.

Towards the east, the above-mentioned continuation of the North Russian Callovian sea extended — probably north of Novaja Semlja — as far as Alaska. This seems evident from the occurrence in Alaska of *Cadoceras* species closely allied to our own.

Towards the end of the Callovian, the sea vanished from the south of Franz Josef Land towards the south. The region of Franz Josef Land became mainland, while simultaneously — during the Oxfordian — a partial overflow of Spitzbergen and Novaja Semlja took place.

Was the region of Cape Flora (and the southern part of Franz Josef Land generally) continuously covered by the sea, from the Bajocian until the end of the Callovian? This question cannot at present be answered.

Between the Bajocian exposed at Elmwood, and the Lower Callovian observed at the south-western end of Windy Gully, there lies a series of rocks several hundred ft. in thickness, from which there are no fossils that we know of. Fossils alone might give information as to whether the younger Bajocian and the Bathonian are here developed in marine formation or not.

Here it might be possible to determine whether the fauna of the Callovian of Cape Flora has sprung from the fauna of the polar Bathonian sea. Here too lies the clue to the answering of the question, whether Koken² is right in supposing that in the Callovian period, Russia was overflowed simultaneously from Central Europe and from the north.

The small fauna of the Callovian of Cape Flora really contains nothing which might entitle it to be called the indigenous fauna of a polar Callovian sea. At present we can only name the group of *Macrocephalites Ishmæ* Keys. sp. with its members also found at Cape Flora, as specifically northern. But this group may just as well have originated in the Russian Callovian sea, from the *Macrocephalites* that migrated thither from Central and Western Europe, as in the polar sea from the *Macrocephalites* that migrated thither from Yorkshire, through the Shetland Straits. There is no justification for

¹ A. G. Nathorst, K. Svensk. Vet. Ak. Handl., vol. 30, No. 1, 1897, p. 74.

² E. Koken, 'Die Vorwelt,' p. 321.

designating the genera *Cadoceras* and *Quenstedtoceras*, allied to *Macrocephalites*, as specifically northern. The group of the *Belemnites excentrici* (Neumayr) also, to which our *Bel. m. f. subextensus* Nik. — *Panderi* d'Orb. belongs, may, from its genealogy, be traced back to Western European forms, and must not be regarded as having originated in arctic regions.

Thus we see that from the fragments of the northern Bajocian and Callovian faunas now before us, we cannot yet come to any conclusion as to the continuity of the marine fauna of the Cape Flora region from the Bajocian to the Callovian.

As far as we can tell from our knowledge of the geology of Spitzbergen and Franz Josef Land, these regions were exposed to repeated and very considerable oscillations of sea-level in the mesozoic period.

Owing to an upheaval of the land *before* the Callovian period, the position of the Bajocian sea was possibly moved from the region of Cape Flora and south Franz Josef Land, to the north and west. By a subsequent sinking of the land in the Callovian period, this region was again inundated, this time by the Russian Callovian sea¹ moving hither from the south. (The connection of the Russian Jura sea with the polar sea in which the genus *Aucella* developed, would thus be deferred to the Oxfordian period.)

It is natural that every new occurrence of marine Jura, particularly in regions with an exposed geographical situation, should be examined, in order to find out how it stands in relation to Neumayr's theory of the climatic zones in the Jurassic period. In the discussion following the reading of Newton and Teall's work on Franz Josef Land, before the Geological Society of London, Mr. J. W. Gregory pronounced Neumayr's theory to be „now quite untenable“. Impossible as I find it to regard Neumayr's theory as correct and proved, I cannot pass the severe judgement of Gregory upon it, simply on the ground of the Jura of Franz Josef Land,

The little we know of the fauna of the Bajocian of Cape Flora certainly challenges a comparison of it with the fauna of Central Europe. The forms are, however, too indistinct, and the number of known species is as yet far too small to allow of our bringing forward any definite proofs either for or

¹ This would also explain the difference from the fauna of the Callovian of Cape Stewart in East Greenland, which has branched off in other directions — and probably also under other biogenic conditions — from west-central Europe.

against Neumayr. I would not even attach too great importance to the report of the existence of hastate Belemnites far up in the north. Nor does the fauna of the Callovian of Cape Flora as yet bring any new material which might turn the balance in favour of Neumayr's advocates or of his opponents.

If new collections in the region of Cape Flora should prove that the Bajocian in this locality really contains a fauna of decided Central-European character, the region of the Jura of Cape Flora would then supply the most weighty argument for the incorrectness of Neumayr's theory.

ADDITIONAL NOTES.

The preceding chapters were written and for the most part sent to Christiania to be translated into English and printed, when No. 216 vol. LIV. of the Quart. Journ. of the Geological Society of London came out of press (Novbr. 1898), containing two valuable contributions to the Geology of Franz Josef Land:

1. Dr. A. Kœttlitz, 'Observations on the Geology of Franz Josef Land'.
2. E. T. Newton and J. J. H. Teall, 'Additional Notes on Rocks and Fossils from Franz Josef Land'.

As to the purely geological remarks given by Dr. Kœttlitz, the points relating to Cape Flora are already taken into consideration by Prof. Nansen in the sketch of the Geology of Cape Flora, with which he kindly introduced my paper.

Among the new contributions to the Jurassic Fauna and Stratigraphy in the second paper by Mr. E. T. Newton, there are some data completing our own results.

1st. From the lowest horizon [Bajocian], *NW. of Etmwood*, 23—33 ft. above the sea, Newton figures (l. c. Pl. XXIX. fig. 1) the right valve of an "*Avicula* sp". The specimen shows exactly the outline of a true *Pseudomonotis* (the anterior wing being broken) and must be considered as belonging to our species *Pseudomonotis Jacksoni*.

From the same locality, Newton mentions besides remains of *Ostrea* (which genus I could not find in the material before me) Belemnite-fragments of the *Belemnites Panderi* type. If these latter indeed originate from this horizon and have not fallen from above, they may be considered as an enrichment of the fauna of the Cape Flora Bajocian.

2nd. From the south-western end of *Windy Gully*, [Lower Callovian] Mr. Newton l. c. p. 650 describes a *Belemnites* sp. as resembling the *Bel. inornatus* Phill. Perhaps the guard figured by Newton (Pl. XXIX. fig. 5) belongs to the same species as the fragments of the large phragmocones from the same locality, here noted as *Belemnites* sp. indet. 1., which seems also to be somewhat compressed. The relationship with *Bel. inornatus* Phill. is quite uncertain.

Together with this *Belemnites* sp., in the same piece of matrix, Dr. Kœttlitz found a fragment of a large shell, which Newton (Pl. XXIX. fig. 4) determined as "*Inoceramus*-like". If this form, which according to Dr. Kœttlitz was certainly *in situ*, really belongs to *Inoceramus*, this is an interesting fact, since until today the occurrence of the genus *Inoceramus* in the *Macrocephalites macrocephalus*-zone of arctic regions was not known.

3rd. A quarter of a mile NW. of *Elmwood* Dr. Kœttlitz found a fragment of an Ammonite *in situ*, immediately below the basalt therefore higher in the cliff than the Middle Callovian (*Cadoceras Tchekkini* horizon) (l. c. pag. 635, 638, 649). The specimen was embedded in decomposed basalt or basaltic tuff. Mr. Newton determined the specimen as *Amm. Lamberti* (l. c. Pl. XXIX. fig. 2.), and deduces from it, that the beds below the basalt are of Oxfordian age and that the Oxford-clay occurs at Cape Flora.

Though it is impossible to decide, whether the figured fragment be the true *Amm. Lamberti* Sow., it is clear, that it must belong to the genus *Quenstedtoceras*. Therefore we have here a second proof of the occurrence of the *Upper Callovian* (Zone of *Quenstedtoceras Lamberti* = Zone of *Peltoceras athleta*), the first proof having been given by *Quenstedtoceras vertumnum* Sintz (cf. pag. 96).

4th. The occurrence of jurassic plant-remains at *Cape Richthofen*, recognized by Prof. Nathorst as corresponding with those of Cape Flora, proves that the land of post-Callovian-time in the Franz Josef Land Archipelago extended from Northbrook Island towards the North and North-East (cf. pag. 143).

126

ERRATA.

p. 38,	line 6,	instead of:	clayironstone,	read:	clay-sandstone
p. 45,	" 16,	— .	pyritis,	"	pyritic.
p. 46,	" 29,	— .	CaCO ₃ ,	"	CaCO ₃ .
p. 48,	" 16,	— .	No. 4,	"	No. 5.
p. 49,	" 12,	— .	the last,	"	a later.
p. 51,	" 2,	— .	30 feet,	"	23—33 feet.
p. 68,	" 32,	— .	squamons,	"	squamous.
p. 69,	" 5,	— .	capitanca,	"	capitanea.
p. 70,	" 7,	— .	V. Sutner,	"	v. Sutner.

1-19

PLATE I.

PLATE I.

The Originals lie in the mineralogical Institute, Christiania.

- Fig. 1. *Pentacrinus* sp. ex. aff. *bajociensis* (d'Orb.) P. de Loriol, p. 51.
1½ klm. NW of Elmwood, at the margin of the glacier, 150–200 ft. above the sea.
1 *a*, side view; 1 *b*, the same, 2 × enlarged; 1 *c*, upper, syzygial surface; 1 *d*, the same, 2 × enlarged.
- Fig. 2–5. *Lingula Beani* Phill., p. 54.
ca. 300 m. NW. of Elmwood, 23–33 ft. above the sea.
2, largest specimen, partly broken; *a*, from above (the exact outline is figured p. 56, Letter press fig. 8); *b*, from the side.
3, cast containing remains of the shell.
4, internal side of another specimen, showing the muscular impressions; *a*, natural size; *b*, 2 × enlarged.
5, small specimen with acute apex.
- Fig. 6–9. *Discina reflexa* Sow. sp., p. 58.
ca. 300 m. NW. of Elmwood, 23–33 ft. above the sea.
6, cast of the convex valve showing muscular scars; *a*, from above; *b*, from the side.
7, convex valve of another specimen; *a* from above; *b*, from the side.
8, posterior view of a convex valve, showing the curvature of the lines of growth, enlarged.
9, convex valve of a more flattened specimen; *a*, from above; *b*, from the side.
- Fig. 10. *Discina* sp. indet., p. 59.
ca. 300 m. NW. of Elmwood, 23–33 ft. above the sea.
Cast of a convex valve; *a*, from above; *b*, from the side.
- Fig. 11. ? *Limea* cf. *duplicata* Goldf., p. 65.
Above, N. of Elmwood, ca. 550 ft. above the sea.
Cast of a right valve; *a*, from above; *b*, from the anterior side.
- Fig. 12. *Pecten Lindströmi* Tullbg., p. 63.
Above, N. of Elmwood, ca. 550 ft. above the sea.
Impression of a left valve; *a*, nat. size; *b*, anterior part enlarged.
- Fig. 13–16. *Pseudomonotis Jacksoni* n. sp., p. 60.
ca. 300 m. NW. of Elmwood, 23–33 ft. above the sea.
13, fragment of a young shell.
14, fragment of a compressed right valve; *a*, outside; *b*, internal view, (cf. p. 61, Letter press fig. 9); *c*, in profile.
15, fragment of a right valve with slight radiating striae.
16, fragment showing the sculpture of a left valve.
- Fig. 17. *Macrodon Schourovski* F. Rouill. sp., p. 67.
Above, N. of Elmwood, ca. 550 ft. above the sea.
Right valve, partly covered with the shell.
- Fig. 18–21. *Belemnites* m. f. *subextensus* Nik — *Panderi* d'Orb., p. 100.
1½ klm. NW. of Elmwood, at the margin of the glacier, 100–200 ft. above the sea.
18, fragment of the anterior part of the rostrum; *a*, longitudinal section through the alveolar part; *b*, cross section.
19, longitudinal section through the postalveolar part of another fragment.
20, fragment of a rostrum with obtuse apex; *a*, ventral side with the ventral groove; *b*, side view; *c*, cross section through the postalveolar part; *d*, seen from behind.
21, fragment of a rostrum with acute apex; *a*, ventral side with the ventral groove; *b*, side view; *c*, seen from behind.
- Fig. 22, 23. *Belemnites* sp. (cf. *Beyrichi* Opp.), p. 103.
ca. 300 m. NW. of Elmwood, 23–33 ft. above the sea.
22, cross section through the postalveolar part.
23, longitudinal section of another individual; the apex here is restored too obtuse.
- Fig. 24. *Belemnites* sp. indet. 2., p. 104.
Locality?
Small fragment; *a*, side view; *b* and *c*, the same seen from above and below, showing slight eccentric radiation.

1-50

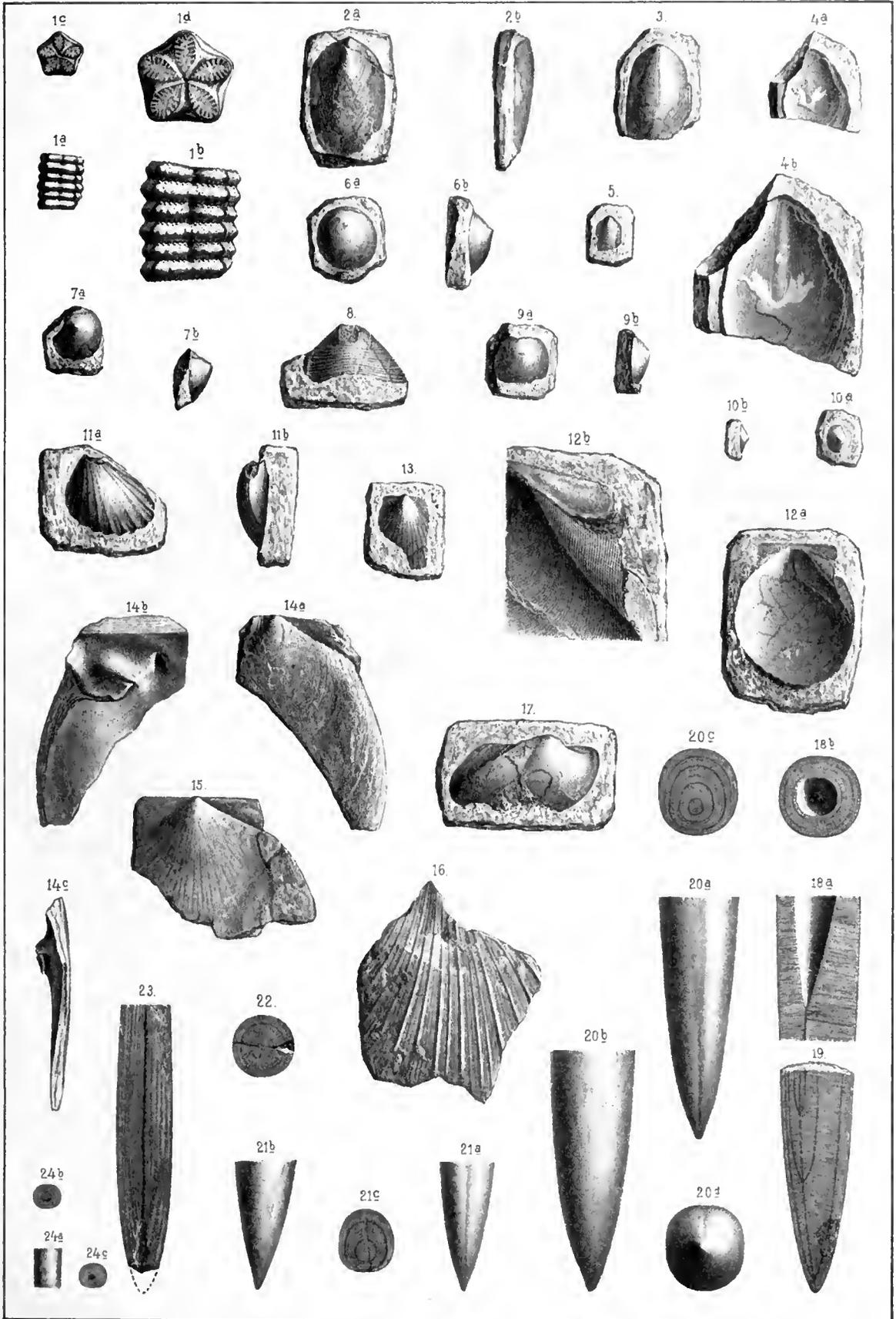

151

PLATE II.

152

PLATE II.

The Originals lie in the mineralogical Institute, Christiania.

- Fig. 1, 2, 3, 5. *Cadoceras Nanseni* n. sp., p. 86.
Above, N. of, Elmwood, ca. 550 ft. above the sea.
1, 2, 3, different juvenile individuals with compressed living chambers, with remains of the shell.
3 *b*, chambered part of 3 *a*, 3 × enlarged.
[Lobe-line cf. p. 88, Letter-press fig. 17].
5, somewhat larger specimen, figured after the wax-cast of an impression.
- Fig. 4. *Cadoceras* sp. ex. aff. *Cad. Nanseni* (n. sp.), p. 92.
1½ klm. NW. of Elmwood, at the margin of the glacier, 100–200 ft. above the sea.
Chambered cast with ½ a whorl of the living chamber, partly covered with the shell; *a*, from the side; *b*, from the front; *c*, section. [Lobe-line cf. p. 92, Letter-press fig. 18].
- Fig. 6. *Cadoceras Nanseni* n. sp., p. 86.
South-western end of Windy Gully, ca. 400 ft. above the sea.
a, compressed specimen, covered with the shell; *b*, innermost whorls, enlarged.
- Fig. 7. *Cadoceras Tchekkini* d'Orb., sp., p. 80.
1½ klm. NW. of Elmwood, at the margin of the glacier, 100–200 ft. above the sea.
a, chambered cast with compressed living chamber, from the side; *b*, the same after removal of the anterior third of the last chambered whorl; *c*, front view of 7 *b*.
[Lobe-line cf. p. 83, Letter-press fig. 15.]
- Fig. 8. *Cadoceras* sp. indet., p. 94.
Above, N. of, Elmwood, ca. 550 ft. above the sea.
a, impression with a fragment of *Lima* sp. indet. (cf. p. 68); *b*, wax-cast of the impression; *c*, reconstructed section.
- Fig. 9. *Quenstedtoceras vertumnum* Sintzow, p. 96.
1½ klm. NW. of Elmwood, at the margin of the glacier, 100–200 ft. above the sea.
Young individual with a fragment of the subsequent whorl; *a*, side view; *b*, ventral area.
[Lobe-line cf. p. 97, Letter press fig. 21.]
- Fig. 10. *Cadoceras Frearsi* (d'Orb. sp.) Nik., p. 93.
1½ klm. NW. of Elmwood, at the margin of the glacier, 100–200 ft. above the sea.
Pyritic cast, fragment of a chambered whorl; *a*, side view; *b*, section.
[Lobe-line cf. p. 93, Letter-press fig. 19.]
- Fig. 11. *Macrocephalites* sp., p. 73
1½ klm. NW. of Elmwood, at the margin of the glacier, 100–200 ft. above the sea.
Fragment of a chambered whorl, pyritic cast with remains of the shell; *a*, side view; *b*, ventral area; *c*, section.
[Lobe-line cf. p. 74, Letter-press fig. 13.]
- Fig. 12. *Macrocephalites Koettitzi* n. sp., p. 70.
South-western end of Windy Gully, ca. 400 ft. above the sea.
Cast of the chambered whorls with remains of the shell; *a*, from the side, *b*, from the front; *c*, ventral area.
[Lobe-line cf. p. 71, Letter press fig. 12.]

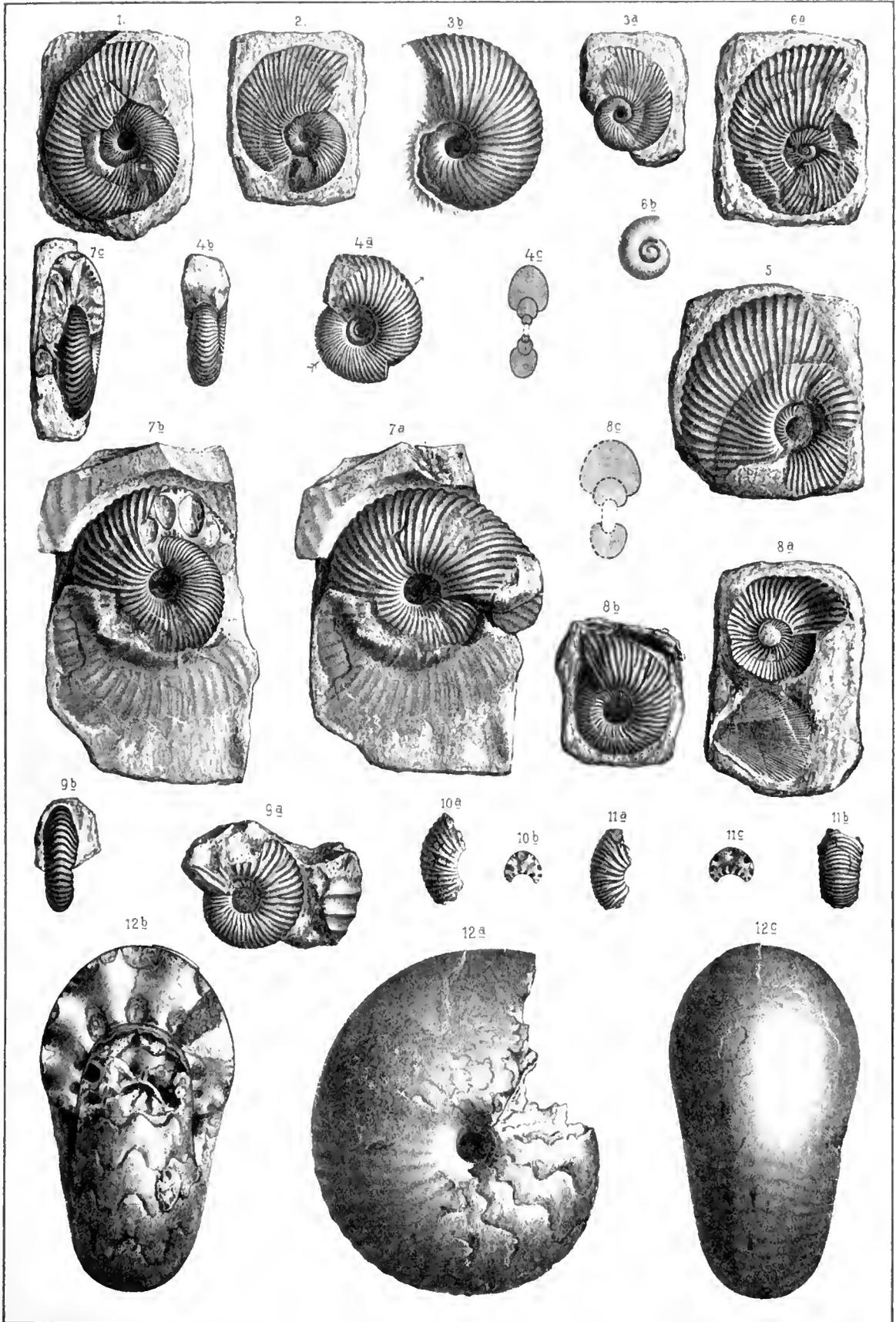

153

TABLE OF CONTENTS.

A Geological Sketch of Cape Flora and its Neighbourhood, by
 Fridtjof Nansen p. 3.
The Jurassic Fauna of Cape Flora, by J. F. Pompeckj - 33.
 Preface - 35.
 I. Previous Literature referring to the Jura of Franz Josef Land - 37.
 II. The Jurassic Sedimentary Rocks at Cape Flora - 45.
 III. The Fauna of the Jurassic Sediments at Cape Flora . . . - 50.
 1. State of Preservation of the Fossils - 50.
 2. Description of the Fossils - 51.
 Crinoidea - 51.
 Vermes - 53.
 Brachiopoda - 54.
 Lamellibranchiata - 59.
 Gastropoda - 68.
 Cephalopoda - 69.
 Ammonoidea - 69.
 Belemnnoidea - 100.
 3. Summary - 105.
 IV. Stratigraphic Results - 108.
 V. Facies. Faunistic Characters and Relations to other Jura
 Faunas - 134.
 VI. Palaeo-Geographical Remarks - 140.

Additional Notes p. 146.

Errata p. 148.



III.

FOSSIL PLANTS FROM FRANZ JOSEF LAND

BY

A. G. NATHORST.



INTRODUCTION.

Shortly after his return from the expedition with the "Fram," Dr. Nansen informed me that when in Franz Josef Land he had collected a goodly number of fossil plants, and requested me to examine them. This offer I could not withstand, though fully occupied with other work, especially as for my work in connection with the fossil Jurassic flora of Spitsbergen, it was particularly interesting to become acquainted with the Jurassic flora of Franz Josef Land. Having given a reply in the affirmative to Dr. Nansen's request, the material he had collected arrived in such good time that I was enabled to give a short account of it in the book Nansen published describing his voyage. Unfortunately there is a misstatement in "Farthest North". When first examining the material received, I believed that I had discovered, among the ferns, fragments of an *Onychiopsis*, a supposition which, however, after a subsequent examination proved erroneous. A correction forwarded in good time by Nansen to the English publisher was not attended to, and consequently, the error is still to be found in "Farthest North". In the Swedish and Norwegian editions it is, however, corrected.

There is no need for me to dwell on the occurrence of these fossil plants, Dr. Nansen himself having given a full description thereof. Both Nansen and Dr. Kœttlitz are of opinion that the plant-bearing strata must be considered as interstratified between two different tiers of basalt (old lava flows), an opinion which is confirmed by the analogous conditions on King Charles

Land, which I observed in the summer of 1898, and on which I shall touch in my work on the geology of this land.

The plant-bearing rock is broken into rather sharp-cornered, small fragments, the surface being white, yellowish, or brownish, while it is darker in fresh fractures. Some pieces show a kind of conglomerate structure, being composed of small rounded white fragments, reminding one of those that are not uncommon in volcanic tuffs, and this variety, at any rate microscopically, shows some resemblance to the white clays which are derived from volcanic tuffs. Whether this will be confirmed by further microscopical examination I cannot at present say.

The organic substance of the plants is sometimes still to be seen in a brownish softer variety of the rock, which is more like a soft bituminous shale. But the harder white or yellowish varieties only present impressions, or, more correctly speaking, the cavities left by the leaves, as their organic substance has entirely disappeared, without any other taking its place. In cross fractures, consequently, there may sometimes be seen cavities which are complete transverse sections of the coniferous leaves.

Unfortunately most of the remains of the plants are very fragmentary, and as, moreover, the leaves in themselves are small, and are not by any difference of colour distinguishable from the rock, the examination of the material has been very arduous, having almost without exception been made under the magnifying lens. There would have been no occasion to mention this, had the material been better, but as it is, the question as to the age of the deposit can only approximately be settled, as will be seen from the latter part of this article.

During the time that has elapsed since Nansen came back, the Jackson-Harmsworth expedition has also returned, and the fossils collected by the latter party have been described by Messrs. *E. T. Newton* and *J. J. H. Teall*; besides which, *Dr. Koettlitz* has given a detailed account of the geological conditions of the various localities.¹ In the article first mentioned, suggestion is made

¹ *E. T. Newton* and *J. J. H. Teall*, 'Notes on a collection of Rocks and Fossils from Franz Josef Land'. Quarterly Journ. Geol. Soc. London, vol. 53 (1897), p. 477. 'Additional notes on Rocks and Fossils from Franz Josef Land'. Ibidem, vol. 54 (1898), p. 646. *R. Koettlitz*, 'Observations of the geology of Franz Josef Land'. Ibidem, vol. 54 (1898), p. 620.

of the possibility of there being plant-bearing strata of Permian and Tertiary age, besides the Jurassic ones.

With regard to the supposed Permian fossils, they have been found at Cook's Rock and Cape Stephen in coarse sandstone, abounding in remains of plants. *Newton* mentions *Phyllothea* cfr. *columnaris*, *Rhizozamites* cfr. *Gœpperti*, *Anomozamites?*, *Zamiopteris* cfr. *glossopteroides* *Asplenium* cfr. *whitbiense*.

These plant-remains represented in pl. 41 accompanying the paper of *Newton* and *Teall*, do not seem so well preserved that it is possible to identify any of them with certainty, and it may be observed that the first and last species in the list of fossils given above are Jurassic. There is nothing to prevent the so-called *Phyllothea* from being an *Equisetum* or *Schizoneura*, and both *Rhizozamites* and *Zamiopteris* are very doubtful, which is also the case with *Anomozamites* (?). Of the so-called *Asplenium* cfr. *whitbiense*, the most one can say is that it seems to be a fern of the *Cladophlebis* type.

But though, in consequence, I cannot hazard any definite opinion concerning this fossil flora, I must say that to me it seems, it might well belong to the uppermost Trias or Rhætic. In the summer of 1898 at Bell Sound, Spitzbergen, a flora of this age was met with which was remarkable for large leaves resembling those classed by *Newton* as *Zamiopteris* and *Rhizozamites*, although the venation of those leaves was too badly preserved to allow my giving any definite opinion at present as to their generic determination. This plant-bearing stratum is succeeded by the transgrading marine Jurassic beds of Oxfordian age. I therefore do not consider it impossible that the plant-bearing sandstone at Cook's Rock and Cape Stephen may belong to the uppermost Trias, though more complete material is necessary before the question can be decided with any certainty.

With regard to the silicified slab found in the same locality, the leaves of which resembled *Baiera* and *Podozamites*, as also the leaves of a *Ginkgo*, I firmly believe that it is of Jurassic and not of Tertiary age. Similar *Ginkgo* forms are also found in the Jurassic beds, and I possess a somewhat similar specimen from King Charles Land. The coniferous twig on the same slab, which is called by *Newton* *Pinites*, should rather be considered as a *Pachyphyllum*, or some allied genus. That the compressed vegetable remains from

Cape Richthofen are probably not Tertiary I have previously pointed out to Mr. Newton, who quotes my opinion in the later article.

The plant-bearing strata of Franz Josef Land, which are as yet known to us, all belong, in consequence — with the exception of those from Cook's Rock and Cape Stephen, the age of which is still uncertain — to the Upper Jurassic, or the transition beds to the Cretaceous, while as yet, no Tertiary strata have been discovered.

DESCRIPTION OF SPECIES.

FUNGI.

Pl. I. figs. 56 and (magnified) 56a.

The specimen fig. 56, twice enlarged, is a fragment of a coniferous leaf (*Taxites*) which on either side of the midrib presents small circular impressions, in the centre of which, on further enlargement (fig. 56a), a small dot is seen. The regular position of the round impressions gives the magnified figure a certain resemblance to a *Laccopteris*, but the leaf is plainly coniferous, and, near the margins, similar round impressions are also present. There is not the slightest doubt that the circular impressions are caused by a parasite fungus; but that is all that can be said on the matter, as no further definition can be given. Another coniferous leaf on the same slab is also attacked by a similar fungus, which has, moreover, been observed also on other specimens.

FILICALES.

CLADOPHLEBIS, Brongniart.

Cladophlebis sp.

Pl. I. figs. 1 and (magnified) 43.

This small fragment represents the ordinary *Cladophlebis* type found in Jurassic deposits, but it cannot be definitely determined as to the species.

SPHENOPTERIS, Brongniart.

Sphenopteris sp. a.

Pl. I. figs. 2 and (magnified) 44.

It is possible that this small fragment belongs to a species not previously described. It is, however, difficult to decide whether it should be brought under *Cladophlebis* or *Sphenopteris*, though the latter seems more probable. The pinnules certainly present an obvious midrib, but it is possible that these pinnules themselves, in a more developed stadium, are divided in the manner characterising *Sphenopteris*, and that the specimen in question is only the very apex of the secondary segment. Owing to the undulating margin of the pinnules, there is a certain resemblance to *Asplenium petruschinense* Heer, from the Jurassic strata of Siberia (*Flora fossilis arctica*, vol. 5), but it is not possible to decide whether this resemblance points to any real affinity. The same holds good concerning *Asplenium Czekanowskianum* Heer, from the Atyrkan, a tributary of the Lena River at Lat. 71° 15' between Lena and Olenek. (*Flora fossilis arctica*, vol. 5).

The specimen is especially interesting because the epidermic cells have made distinct impressions in the rock substance, so that their oval form can be observed under a strong magnifying lens, or the microscope.

Sphenopteris sp. b.

Pl. I. figs. 3 and (magnified) 45.

This fragment belongs to the *Sphenopteris* (*Thyrsopteris*) *Murrayana*-type which is wide-spread in the Jurassic strata, but it is insufficient for any definite determination.

Sphenopteris sp. c.

Pl. I. figs. 4 and (magnified) 46.

Of this type also there is but the fragment represented, which is too incomplete for any certain determination. It may be compared with *Sphenopteris* (*Thyrsopteris*) *Maakiana* Heer from Siberian strata (*Flora fossilis arctica*, vol. 4), but also shows some similarity to *Sphenopteris denticulata* Brongn. from the Yorkshire oolite, as also to *Dicksonia borealis* Heer, from the strata of Northern Siberia. The venation is probably more intricate than the drawing represents, but it is difficult to make it out.

Sphenopteris (Adiantites) sp. d.

Pl. I. figs. 5, 6 and (magnified) 47, 48.

Of this species three specimens are here represented, the one (wood-cut fig. 1) I only received after the plates were printed. As is seen from the drawings, the leaves are constructed as in the *Adiantum*, the oblique wedge-shaped leaflets being devoid of any distinct midrib and attached to the rachis by their posterior part. The anterior margin is more or less uneven. The figures will speak for themselves.



Fig. 1. *Sphenopteris (Adiantites) sp. d.* in natural size and two pinnales magnified.

The species is probably new, in so far as can be judged from this incomplete material. Of the species previously described, it somewhat resembles *Adiantites Nympharum* Heer from Bureja in Amur, (*Flora foss. arctica*, vol. 4), the pinnales of which are however considerably larger.

Newton and Teall¹ have described two specimens from Cape Flora, bringing them under *Thyrsopteris*, though at the same time they draw attention to their similarity to *Adiantites amurensis* Heer. It seems to me that the likeness to *Adiantites Nympharum* is still greater, indeed, it may not be altogether impossible that they belong to this species. Whether the form described above should be considered as an earlier stage of development of the species described by Newton and Teall cannot be determined from the material at hand.

¹ 'Notes on a collection of Rocks and Fossils from Franz Josef Land', etc. *Quarterly Journ. Geol. Soc.* vol. 53, p. 477.

CYCADALES.**PTENOPHYLLUM, Brongniart.***Pterophyllum?* sp.

Pl. I. figs 7 and (magnified) 57.

The only specimen that with any certainty belongs to the Cycadales is the little fragment in question. It is a pinna of a frond, probably regularly divided, the pinnae of which in their entire breadth have been attached to the rachis. They are rounded at the apex, and, when enlarged, four unbranched veins are visible in the pinna represented.

This is no true *Pterophyllum*, though provisionally I place the specimen in this genus. It is more of a *Ctenophyllum* or *Ptilophyllum* which, however, cannot be decided from the material before us. Until better material be obtainable, it is not worth while discussing the relationship of this species to forms previously described. It might also be compared with those species of *Zamites* and *Pterophyllum* from the Urganian strata of Greenland described by Heer.

PODOZAMITES, Fr. Braun.*Podozamites?* sp.

Pl. I. fig. 31.

Newton and Teall, in their paper cited above, mention the occurrence of pinnae resembling those of *Podozamites*. I am, however, not fully convinced that the specimens represented on their plate 38, figs. 11 and 12 — or at any rate their fig. 11 — should not rather be classed as *Feildenia*. On the other hand it is not quite impossible that our specimen plate I, fig. 31, which shows about 18 fine veins, should really be referred to *Podozamites*; in which case it would be yet another species of *Cycadales* which has been found in Franz Josef Land.

*CONIFERÆ.**GINKGO*, Linné.

The *Ginkgo* forms found here are among the most interesting remains of the entire flora. Unfortunately, most of the leaves are but fragmentary, so that it is difficult to determine with any certainty how many species really occur. The occurrence of at least two species I consider fairly certain, probably the number is still larger in reality.

Ginkgo polaris, Nathorst.

Pl. I. figs. 8—19 and (magnified) 51.

Ginkgo polaris Nathorst, Nansen's 'Farthest North', London, vol. II. p. 486, fig. 6. 'Fram over Polhavet', Christiania, vol. II. p. 520, fig. 6.

This species is represented here with a perfect leaf (fig. 8) which has already been figured and named in the short summary of fossil plants of Franz Josef Land, included in Nansen's description of the Fram expedition 1893—96. The leaf has a truncated base, and, in the manner characteristic of this genus, is repeatedly dichotomously divided into eight lobes, the apex of which is rounded, or mostly somewhat truncated with a depression in the middle. The petiole of the leaf is short and slender. The number of veins in the lobes vary from five to ten.

Of the other specimens included under the same species, those represented in figs. 14, 15, and 17, differ by having a more wedge-shaped base, but it is just possible that the two latter figures only present the one half of the leaf. If the specimen fig. 8 be imagined as divided into two halves, the base of each of the halves would also be wedge-shaped. On the other hand as regards the specimen fig. 14, it is probably a young leaf which has not yet undergone any further division.

Of the species already described, *Ginkgo polaris* can especially be compared with *Ginkgo sibirica* Heer and *Ginkgo flabellata* Heer (Flora fossilis arctica, vols. 4 & 5) from the Jurassic strata of East Siberia, without the existence of any complete agreement with either. The leaves of the former are larger, with a more powerful petiole, the lobes also being more rounded. This is also the case with the lobes of *Ginkgo flabellata*, which moreover, are narrower; the number of veins in the lobes being also fewer (according to Heer but 3—5).

Nevertheless it must be admitted there is a very great resemblance between *Ginkgo polaris* and the two species mentioned, so that there is the temptation of classing some fragments with the one species, some with the other. As, however, the most perfect specimen of *Ginkgo polaris* does not agree with either, I have deemed it more correct to consider it as a species of its own, more particularly as no one of the many specimens examined by me, or by Newton or Teall, presents so long and strong a petiole as those possessed by the species from East Siberia.

To *Ginkgo polaris* we must therefore refer the specimens represented by Newton and Teall in pl. 38, figs 4 and 5, which they call *Ginkgo sibirica*. If they had belonged to the latter species, at any rate the specimen fig. 5, should still have shown the long petiole of the leaf. The specimen figured in their second paper, (plate 29, fig. 3) and which they with hesitation refer to *Ginkgo polaris*, is also characterised by a very short petiole.

Ginkgo polaris Nathorst var. *pygmæa* n. var.

Pl. I. figs. 20, 21 and (magnified) 50, 52.

It is probable that these specimens are only a variety of the preceding, since transition forms do not seem wanting (fig. 18). The specimen fig. 20 is the very smallest of all the *Ginkgo* leaves hitherto described, as it is even smaller than Heer's *Ginkgo pusilla* from the Jurassic strata of East Siberia, which itself is very closely allied to *Ginkgo flabellata*. The specimen in question has its leaf divided into four lobes, while the fragmentary specimen fig. 21 is divided into six, but with signs of a commencing division of the two innermost lobes, which are consequently broader than the rest. The veins in the specimen fig. 20 are five in each lobe, in the specimen fig. 21 similar in number in the narrower lobes, but nine to ten in those that are broader.

Ginkgo sp.

Pl. I. figs. 22—24.

In my opinion these specimens belong to a separate species, as they differ from *Ginkgo polaris* by having a larger, less deeply divided lamina, more distinct venation and often present a peculiar structure (fig. 23a enlarged) which seems to correspond with transverse cracks in the carbonised leaf sub-

stance; pointing therefore to rather thick leaves. A specimen, sent to me after the plates were printed, is figured in fig. 2 annexed.

Probably the specimens figs. 1—3, plate 38, of Newton's and Teall's afore-mentioned work should be referred to this same species.



Fig. 2. *Ginkgo* sp.

Both in form and venation these specimens, as far as can be judged from the material at hand, show no small resemblance to *Ginkgo pluripatita* Schimper sp. from the Weald of Germany¹. More complete specimens are however necessary, in order to decide the relationship between the two.

Male flower of *Ginkgo*.

Pl. I. figs. 33 and (magnified) 49.

This specimen is evidently a male flower of some plant belonging to the *Ginkgo* family, probably of the genus *Ginkgo* itself. The anthers are visible on either side of the axis, but their number or nature cannot be definitely ascertained. Such male flowers of the Ginkgo family may be named *Ginkganthus*.

CZEKANOWSKIA, Heer.

Czekanowskia cf. *rigida* Heer.

Pl. I. figs. 35 and 54 (magnified).

That *Czekanowskia rigida*, Heer (*Flora foss. arctica*, vol. 4) is represented in the collection from Franz Josef Land seems fairly indisputable from the specimen fig. 35, which plainly shows the dichotomous branching of the narrow leaves. The midrib is also shown very clearly.

Besides this specimen, there are many others which seem to point to the occurrence of the same species. First of all, let me mention fig. 37, a specimen which shows several leaves proceeding from a short shoot. Unfortunately they are in a bad state of preservation, so that one might question whether it could not be a *Phoenicopsis*. There is certainly also some likeness to *Pinites*, but, for that, the leaves seem to have been of too weak a consistency.

The specimen represented by fig. 36 may also be deemed fascicular leaves of *Czekanowskia*, as also specimen fig. 38, while the specimen fig.

¹ Schenk, 'Die Flora der nordwest-deutschen Wealdenformation', p. 212, pl. 24, figs. 1—8. *Palacontographica*, vol. 19, 1871.

34 (enlarged fig. 55) which shows narrower leaves, might tend to the supposition of the occurrence of *Cz. setacea*. It really seems as if the leaves of some were dichotomously branched, but it is not quite certain, so that here also our thoughts may turn to leaves of *Pinites*.

PHOENICOPSIS, Heer.

Phoenicopsis cf. *angustifolia* Heer.

Pl. I. figs. 39—41, pl. II. figs. 1—6.

The occurrence of the genus *Phoenicopsis* is proved by the specimen figured on Pl. I, fig. 41, which presents a fascicule of long linear leaves with parallel veins proceeding from a short shoot. Unfortunately the leaves of this specimen are in such a bad state of preservation, and run into one another so, that their true breadth cannot be ascertained. Consequently neither their form nor the number of veins on each leaf can be determined; these seem however to have been at least ten. The specimen, fig. 39, on the same plate, shows a fasciculate arrangement of the leaves, but they do not reach down to the short shoot.

Heer (*Flora fossilis arctica*, vol. 4) states the number of veins in *Phoenicopsis angustifolia* to be 6—10, in *Ph. speciosa* to be 15—23, in *Ph. latior* to be 20—30. Those specimens figured in Pl. II. which I suppose may belong here, have 8—10 veins, except the specimen, fig. 2, in which the upper part of the leaf shows 11. The species thus seems probably to be *angustifolia*, but this cannot be determined with perfect certainty, owing to the present material being so bad.

The fossil which is figured by Newton and Teall in their first paper on Pl. 38, fig. 10, and with some hesitation brought under *Baiera*, should evidently be placed here. The specimen is figured upside down.

FEILDENIA, Heer.

The occurrence of this genus is assumed by me chiefly in consequence of the specimen that is represented Pl. I, fig. 28 and which, as also fig. 29, has already been figured in Nansen's 'Farthest North' (vol. II, p. 486, fig. 4 & 5). However, elsewhere¹ I have adduced the difficulty of distinguishing the

¹ A. G. Nathorst, 'Zur mesozoischen Flora Spitzbergens'. Kgl. Svenska Vetenskaps Akademiens Handlingar, vol. 30, no. 1, Stockholm 1897.

leaves of this plant from those of *Phoenicopsis*, and suggested that the two genera may perhaps coincide. If it be difficult to distinguish complete leaves of the two genera the one from the other, this difficulty is of course greatly increased when such fragmentary specimens as those in question are to be determined. For this reason it is with a certain degree of hesitation I include them under this genus. The occurrence of *Feildenia* is, however, not unexpected, as it is represented in the Upper Jurassic flora of Spitsbergen.

Feildenia sp.

Pl. I. figs. 25—30, 32.

The specimen figured in fig. 28 presents a falciform bend at the base of the leaf, still more pronounced than that usual in *Feildenia Nordenskiöldi* Nath. (l. c.) from Spitsbergen. On the contrary the base of the leaf of the specimen fig. 27 is straight, the apex is rounded and not oblique, as is generally the case with the species described from Spitsbergen. In this the number of the veins is usually 6, only exceptionally 10, while 8 to 10 seems to be the usual number in the specimens from Franz Josef Land. If these really belong to the *Feildenia* they may therefore probably belong to a new species. One specimen in the brown softer rock with but 6 veins is, however, very similar to *Feildenia Nordenskiöldi* Nath. from Spitsbergen.

TAXITES, Brongniart.

Taxites cf. *gramineus* Heer sp.

Pl. II. figs. 20—23.

Cycadites gramineus Heer, 'Beiträge zur foss. Flora Spitzbergens', p. 34, pl. 8, fig. 7 (?), 8. Heer, 'Beiträge zur Jura-Flora Ostsibiriens etc.' p. 100. pl. 26, fig. 4.

Taxites gramineus Nathorst, 'Zur mesozoischen Flora Spitzbergens', p. 17.

As far as may be ascertained from these fragmentary specimens, they seem to agree very well with *Taxites gramineus* Heer sp. from the Jurassic strata of Spitsbergen and East Siberia. The leaves are about 3 to 3.5 mm. in breadth and present transverse impressions on their surface, which may certainly be considered a phenomenon of dessication, but which, at the same time, doubtless is connected with some structural peculiarity, as they so often are seen in this sort of leaf.

The specimen fig. 23 is broader than the others (4 mm.), but not more so than fully permits of its belonging to the same species. A similar specimen from Spitsbergen is figured in my work cited above (Pl. I, fig. 14).

ABIETITES, Coeppert.

Abietites(?) sp.

Pl. I. figs. 42, and (magnified) 53.

In my opinion this leaf is complete, and not the apex of a leaf of *Pinites* (*Pityophyllum*) as seems proved by its narrowing off at its base and the special structure thereof. It may therefore be compared to leaves of *Tsuga*; as however there may be a question also of *Sequoia* and other genera it cannot be determined with certainty. Nor do the other conifer remains give any clue, as among them seeds are found which may be said to point both to *Abies* and *Sequoia*.

PINITES, Endlicher.

There cannot be the slightest doubt that the genus *Pinus* — to the extent that *Linné* has allowed it — is represented in the fossil flora from Franz, Josef Land. As, however, the various remains are usually found separately, there is no possibility of deciding, in each case, whether there may not also occur some closely allied but now extinct genus. It is therefore wiser to use the denomination *Pinites* for these remains, which in no way precludes that in many cases, they should in reality belong to *Pinus* itself. In accordance with the nomenclature¹ already in use we will call the leaves *Pityophyllum*; the twigs *Pityocladus*; the cones *Pityostrobus*; the seeds *Pityospermum*; the male flowers *Pityanthus*. It is plainly more correct to name these organs separately than to connect them with one another, which will always prove more or less arbitrary and uncertain. These names are of course provisional, and will be withdrawn, so soon as the connection of the different organs with one another be proved.

Pityanthus sp.

Pl. II. figs. 7, and (magnified) 7 a.

It appears to me fairly certain that this object is a *Pinus*-like male flower, though the details of the structure of the anthers cannot be distinguished. Their edges appear however to have been fimbriated.

¹ A. G. Nathorst, 'Zur mesozoischen Flora Spitzbergens', l. c. p. 62.

Pityostrobus sp. a.

Pl. II. figs. 9, 10, and (magnified) 9 a, 10 a.

These specimens, as is generally the case with mesozoic forms, belong to the sub-division *Sapinus*, which is characterised by thin scales of cone. Thus we can choose between the genera *Cedrus*, *Larix*, *Abies*, *Tsuga* and *Picea*, of which the two last must be given the first place, if, on the whole there can be question of any known genus, which cannot be determined from the scanty material available.

The scales, as previously stated, are thin, and seem to have had an obtuse apex. They are furnished with longitudinal striæ which curve outwards on either side (fig. 9 a). The specimen fig. 10 shows parts of the scales nearer their base, with indications of impressions made by the two seeds.

Pityostrobus (?) sp. b.

Pl. II. figs 11, and (magnified) 11 a.

Possibly this little specimen may be a young cone, or more correctly the female flower of a species, which belongs to the genus *Pinus* in a limited signification. The round object presents rather powerful rhomboid impressions, and recalls *Strobilites Heeri* Nath. from the Jurassic strata of Spitsbergen¹ which Heer, in his day, considered a young *Pinus* cone.² On the other hand there might also be the question of some short shoot, for which reason it is with great hesitation I describe the fragment as *Pityostrobus*.

Pityospermum cf. *Maakianum* Heer sp.

Pl. II. fig. 15.

Pinus Maakiana Heer, 'Beiträge zur Juraflora Ostsibiriens und des Amurlandes,' p. 76, pl. 14, fig. 1.

This specimen agrees so entirely with the seeds of *Pinus Maakiana* described by Heer, more especially with his fig. 1, that the identity of the

¹ Nathorst l. c. p. 20.

² Heer, 'Beiträge zur fossilen Flora Spitzbergens', p. 45, pl. 9, fig. 7, 8. Flora fossilis arctica, vol. 4.

two can scarcely be doubted. It is much smaller than the other specimens. Probably the specimen represented by fig. 16 should also be placed here,



Fig. 3. *Pityospermum*.

but it is so torn that any determination of it is very uncertain. The specimen figured in the accompanying text-figure (fig. 3) differs by being narrower-winged, but Heer's fig. 1b is also more narrow-winged than his fig. 1a. Heer is of opinion that *Pinus Maakiana* may possibly belong to the genus *Tsuga*.

Pityospermum cf. *cuneatum* Nathorst.

Pl. II. fig. 14.

Owing to the smallness of the seed itself (scarcely one third of the seed-wing) and what appears to be an almost truncate apex of the wing, and also as regards its dimensions, this specimen seems closely allied to *Pityospermum cuneatum* from the Upper Jurassic strata of Spitsbergen, already described by me¹. However, the identity of the two—owing to the incompleteness of the specimen in question—cannot be considered certain.

Pityospermum Nanseni n. sp.

Pl. II. figs. 12, 13.

As a type for this species we must first of all reckon that specimen represented in the annexed text-figure (fig. 4) which, of all the seeds obtained,



Fig. 4.
Pityospermum
Nanseni.
Natural size.

is the most complete. It is about 11 mm. in length, the seed itself is almost round, not quite half as long as the wing, this latter having its greatest breadth about the middle. As regards its form in other respects, I refer the reader to the figure; the wing shows as usual, fine striæ radiating towards the outer margin.

Another complete specimen to be entered here is that figured by *Newton* and *Teall* in their Pl. 38, fig. 6. It has the same form and dimensions, differing only by the outer margin of the wing stretching as far as the lower side of the seed.

Here we must certainly also include the specimen on Pl. II. fig. 13, possibly also fig. 12, the wing of which, probably owing simply to its state of preservation, appears narrower.

¹ *Nathorst*, 'Zur mesozoischen Flora Spitzbergens', p. 63, pl. 5, fig. 38.

Pityospermum sp.

Pl. II. figs. 17, 18 and (magnified) 18a.

This specimen differs by the considerable size of the seed and the greater length of the wing, which also appears to be narrower. It is, however, so obliterated in the specimen, fig. 18, that its real form cannot be ascertained with any certainty.

Whether the specimen, fig. 19, is really a winged seed is uncertain, the part that should correspond to the wing seems too thick for that. It ought therefore at present to be considered as *incertae sedis*.

Newton and Teall have also figured two winged seeds (l. c. Pl. 38, figs. 7, 8) which evidently belong to one or two other species characterised by very large seeds. Their specimen fig. 8 is about 28 mm. in length.

It therefore appears as if there had been five or six species of *Pinites* growing in the same locality, which is not however *per se* improbable. From the Tertiary Taxodium slate at Cape Staratschin of Spitsbergen, Heer has described no less than 11 different species founded on seeds and scales, so that the occurrence is not without analogy among cases previously known. It is moreover possible that a part of these winged seeds may have been carried hither from a considerable distance.

Pityophyllum cf. *Staratschini* Heer sp.

Pl. II. figs. 24, 25.

Pinus Staratschini Heer 'Kreideflora der arktischen Zone', p. 129, pl. 38, fig. 6, 7. (Kgl. Svenska Vetenskaps Akademiens Handlingar vol. 12, no. 6 and Flora fossilis arctica, vol. 3).

Pityophyllum Staratschini Nathorst 'Zur mesozoischen Flora Spitzbergens', pp. 41, 68, pls. 5, 6, figs. 28—30, 32—36.

These leaves are narrower than those of *Taxites gramineus* Heer, while, at the same time, they are broader than the leaves of *Pityophyllum Lindströmi*. The surface presents the same transverse rugosities as in the former species, which is also the case with very similar leaves described by me from the Upper Jurassic beds at Advent Bay, Spitsbergen. The insufficiency of the material, however, renders the determination far from certain.

Pityophyllum cf. *Lindströmi* Nath.

Pl. II. figs. 26—34a, 38.

Pityophyllum Lindströmi Nathorst 'Zur mesozoischen Flora Spitzbergens,' pp. 40, 67, pl. 5, figs. 13—15, 18—31; pl. 6, figs. 17, 18.

The leaves of this species are generally 1—1.5, seldom 2 mm. in breadth and often show a distinct midrib, at times with an indication of two marginal veins, and moreover finer longitudinal striæ, which, I suppose, correspond with the rows of stomata. No such transverse rugosities as exist in the preceding species are present. On the lower (outer) side the leaves are convex, but on the upper (inner) side concave, as is seen by the transverse-section fig. 38, and moreover in many other specimens. For a more particular description I must refer the reader to my work cited above.

Probably the two specimens, figs. 35 (enlarged 35a) and 36, should also be included here, as they are probably to be considered as short shoots; if this be so, the species must have had many leaves in each short shoot.

The leaves in question are the most common fossils of the plant-bearing stratum, and occur in most specimens of the rock. As in the collection from Advent Bay, Spitsbergen, so also in Franz Josef Land there are accumulations of broken coniferous leaves connected in such a manner that it must be deduced that they have been the abode of some phryganid larva. This seems to indicate that the deposit, as is also probable from other reasons, has originated in fresh water.

CARPOLITHES, Sternberg.*Carpolithes* sp. a.

Pl. II. figs. 8 and 8a (magnified).

A somewhat oblique seed, the margin of which has evidently been surrounded by a narrow wing. It may be compared with my *Carpolithes* sp. c. from the Upper Jurassic strata of Spitsbergen (Nathorst, l. c. p. 69, Taf. 5, figs. 47—49, 51) though the specimen before us is far less symmetrical. Among the conifers of the present day the seeds of *Sequoia* are rather like it in appearance.

Carpolithes sp. b.

Pl. II. figs. 40 and 40a (magnified).

This may be the seed of *Taxites* or *Ginkgo*, but may even be a wingless *Pityospermum*, or one where the wing has fallen off.

Carpolithes sp. c.

Pl. II. figs. 41 and 41a (magnified).

An oval seed, striated, (fig. 41a). It is possible that it may be a *Pityospermum* without wings.

Carpolithes sp. d.

Pl. II. fig. 42 (twice magnified).

Two seeds, not unlike the preceding though more acute, are here fixed at the side of each other. It may be considered that they are impressions of two *Pinus* seeds affixed to the scale of cone.

Carpolithes sp. e.

The cast of a seed represented in the accompanying letterpress-figure (fig. 5) has on the whole a heart-like form though with a truncate base. In the centre



Fig. 5.
Carpolithes sp. e.
natural size and
magnified.

there is a deep impression or cavity, and the apex appears cleft. Thus it bears a faint resemblance to certain *Samaropsis*-forms from Eastern Siberia described by Heer, without, however, any complete agreement with any of them.

INCERTAE SEDIS.

Fig. 6.

The object here represented (fig. 6) is probably an inflorescence of some conifer. As, however, it may be also compared with twigs, I have thought



Fig. 6.
Incertae sedis.

it wiser to enter the fossil as *incertae sedis*. The cylindrical objects lying beside and above one another, on the surface, present a sculpture (badly represented in the figure) which seems to indicate that they have been constructed of small, closely packed scales. If, on the other hand, the objects be considered twigs, the sculpture would be derived from leaf-scars.

GEOLOGICAL AGE OF THE PLANT-BEARING DEPOSIT.

A glance at the accompanying list (on pp. 23—24) of the fossil plants described in these pages, will at once prove to specialists that the fossil flora from the deposit between the basalt beds of Franz Josef Land, has its greatest resemblance with the previously known Jurassic floras from Siberia and Spitsbergen. Of these, that of Siberia and the flora of Cape Boheman of Spitsbergen have by *Heer* (and afterwards by me) been brought under the Brown Jura, an opinion which, as regards the latter flora, is no longer tenable; the investigations carried on by me during the summer of 1898 having proved that it must be placed above the Oxfordian Aucella-bearing deposits. We may thus, to begin with, affirm that the plant-bearing deposit of Franz Josef Land is younger than the Oxfordian, or belongs to its uppermost portion, which also harmonises with the supposition of the lowest basalt-bed having its place above the Oxfordian marine deposits containing *Ammonites Lamberti*. There is, moreover, no doubt whatever that the flora of Franz Josef Land is younger than that of Cape Boheman and Siberia, a circumstance which is proved by its ample supply of the *Pinites* species. In this respect it agrees more with the youngest Jurassic flora of Spitsbergen, viz: that described by me as found at Advent Bay, and by *Heer* as discovered at Cape Staratschin. As a matter of fact the most common species found at Franz Josef Land seems identical with *Pityophyllum Lindströmi* Nath. also so common in the deposit at Advent Bay. The age of this deposit I have tried to define by stating that "the nearest approach to truth is made by counting the deposit as Uppermost Jurassic, to a horizon which is somewhat older than the Wealden."

The agreement between the fossil flora of Franz Josef Land and Advent Bay is, however, far from complete. Most remarkable is the absence, at Franz Josef

THE FOSSIL FLORA OF FRANZ JOSEF LAND.

List of species described in this paper.	Allied or identical species from other localities
<i>Cladophlebis</i> sp.	Belongs to the Jurassic Cladophlebis-Type.
<i>Sphenopteris</i> sp. a.	? <i>Asplenium petruschinense</i> Heer and <i>A. Czekanowskianum</i> Heer from the Siberian Jura.
<i>Sphenopteris</i> sp. b.	<i>Sphenopteris (Thyrsopteris) Murrayana</i> Brongn from the Jura of England, Siberia etc.
<i>Sphenopteris</i> sp. c.	<i>Sphenopteris (Thyrsopteris) Maakiana</i> Heer from the Siberian Jura and some other Jurassic forms.
<i>Sphenopteris (Adiantites)</i> sp. d.	<i>Adiantites Nympharum</i> Heer from the Jura of eastern Siberia.
<i>Pterophyllum?</i> sp.	
<i>Podozamites?</i> sp.	<i>Podozamites lanceolatus</i> Lindl. sp. from the Jura of Europe, Spitsbergen, Siberia etc.
<i>Ginkgo polaris</i> Nath.	<i>Ginkgo sibirica</i> Heer and <i>G. flabellata</i> Heer from the Siberian Jura.
<i>Ginkgo polaris</i> Nath. var. <i>pygmaea</i> .	
<i>Ginkgo</i> sp.	<i>Ginkgo pluripartita</i> Schimper sp. from the Wealden deposits.

List of species described in this paper.	Allied or identical species from other localities.
<i>Czekanowskia</i> cf. <i>rigida</i> Heer.	<i>Czekanowskia rigida</i> Heer from the Siberian Jura and from the Rhætic beds of Scania.
<i>Phoenicopsis</i> cf. <i>angustifolia</i> Heer.	<i>Phoenicopsis angustifolia</i> Heer from the Jura of Siberia and Spitsbergen.
<i>Feildenia</i> sp.	<i>Feildenia Nordenskiöldi</i> Nath. from the uppermost Jura of Spitsbergen.
<i>Taxites</i> cf. <i>gramineus</i> Heer sp.	<i>Taxites gramineus</i> Heer sp. from the Jura of Siberia and Spitsbergen.
<i>Abietites</i> ? sp.	
<i>Pityanthus</i> sp.	
<i>Pityostrobus</i> sp. a.	
<i>Pityostrobus</i> ? sp. b.	
<i>Pityospermum</i> cf. <i>Maakianum</i> , Heer sp.	<i>Pityospermum Maakianum</i> Heer sp. from the Siberian Jura.
<i>Pityospermum</i> cf. <i>cuneatum</i> , Nath.	<i>Pityospermum cuneatum</i> Nath. from the uppermost Jura of Spitsbergen.
<i>Pityospermum Nanseni</i> Nath.	
<i>Pityospermum</i> sp.	
<i>Pityophyllum</i> cf. <i>Staratschini</i> , Heer sp.	<i>Pityophyllum Staratschini</i> Heer sp. from the uppermost Jura of Spitsbergen.
<i>Pityophyllum</i> cf. <i>Lindstrømi</i> Nath.	<i>Pityophyllum Lindstrømi</i> Nath. from the uppermost Jura of Spitsbergen.
<i>Carpolithes</i> sp. a.	<i>Carpolithes</i> sp. c. from the uppermost Jura of Spitsbergen.
<i>Carpolithes</i> sp. b.	
<i>Carpolithes</i> sp. c.	
<i>Carpolithes</i> sp. d.	
<i>Carpolithes</i> sp. e.	? <i>Samaropsis</i> from the Siberian Jura.

Land, of *Elatides curvifolia* Dkr. sp., which both at Cape Staratschin and Advent Bay predominates to such a degree. *Baiera spetsbergensis* is also not found at Franz Josef Land, while at Advent Bay no *Ginkgo polaris*, *Phoenicopsis*, etc., appear to have been discovered. Under these circumstances it is not probable that the plant-bearing deposit of Franz Josef Land is quite contemporaneous with the plant-bearing strata of Cape Staratschin and Advent Bay, but it is difficult to decide whether it is to be considered older or younger. In favour of the former supposition there is the fact of the similarity or affinity of species in the fossil floras of Siberia and Cape Boheman (*Sphenopteris*, *Ginkgo polaris*, *Czekanowskia*, *Phoenicopsis*, *Pityospermum Maakianum*); and the most natural conclusion, in consequence, would be to consider the flora of Franz Josef Land as belonging to a period between the fossil floras of Cape Boheman and Advent Bay. The material at hand is, however, so incomplete, that a precise determination of the age of the deposit can only be made to an approximate degree. As regards its downward limits, as previously stated, it may be adduced with certainty that it must be younger than the Jurassic flora of Siberia and Cape Boheman. As these, as before stated, owing to the stratigraphical conditions must be younger than the Oxfordian, or belong to the uppermost part of it, the fossil flora of Franz Josef Land must in consequence, be still younger. How much younger, however, it is very difficult to decide. As regards its upward limits there is the difficulty that in the Polar regions no real Wealden flora is, as yet, described. There appears to be no agreement with the Urganian flora of Greenland, and it must therefore be supposed that the fossil flora of Franz Josef Land is older than the Urganian. The result of the age-problem can therefore only be thus defined: that the plant-bearing deposit was formed towards the close of the Jurassic or commencement of the Cretaceous Period, without our being able at present to settle which.

In order to avoid misapprehension, it is perhaps best, for me to mention that, together with many other authors, I reckon the Wealden as belonging to the Jurassic Period and not to the Cretaceous; a question in itself, of very slight importance.

It seems, however, as if the conditions at King Charles Land, as examined by myself in 1898, might possibly define with somewhat more precision the age of the deposit. Above the fossil-bearing marine strata which, according to

the determination of Dr. *J. F. Pompeckj* reaches up into the Neocomian, there is a plant-bearing deposit which shows affinity to the fossil flora both of the Wealden and Cape Boheman. This plant-bearing deposit cannot therefore, in consequence of its stratigraphical position, be older than the Wealden. It is covered by a basalt-bed, above which, at one point, I found fragments of a plant-bearing stratum which in every detail appeared to agree with the stratum between the basalt-beds of Franz Josef Land and which, in all probability, as is the case there, was covered by another bed of basalt. If these plant-bearing strata are identical, which cannot be fully proved owing to the condition of the material at present available, then, as a natural consequence, the fossil flora of Franz Josef Land must either belong to the Wealden, or be somewhat younger. This question will be further touched on in my work on the geology of King Charles Land when describing its fossil plants.

PLATE I.

6
2

PLATE I.

Figs. 1—42 are drawn in natural size.

- Fig. 1. *Cladophlebis* sp.
2. *Sphenopteris* sp. a.
3. *Sphenopteris* sp. b.
4. *Sphenopteris* sp. c.
5 & 6. *Sphenopteris* (*Adiantites*) sp. d.
7. *Pterophyllum*? sp.
8—19. *Ginkgo polaris* Nath.
20 & 21. *Ginkgo polaris* Nath. var. *pygmæa*.
22—24. *Ginkgo* sp.
25—30. *Feildenia* sp.
31. *Podozamites*? sp.
32. *Feildenia*?
33. Male flower of *Ginkgo*.
34. *Czekanowskia*?
35. *Czekanowskia* cf. *rigida* Heer.
36—38. *Czekanowskia*?
39—41. *Phoenicopsis* cf. *angustifolia* Heer.
42. *Abietites*? sp.

Figs 43—57 are magnified drawings.

43. *Cladophlebis* sp. (Fig. 1).
44. *Sphenopteris* sp. a. (Fig. 2).
45. *Sphenopteris* sp. b. (Fig. 3).
46. *Sphenopteris* sp. c. (Fig. 4).
47 & 48. *Sphenopteris* (*Adiantites*) sp. d. (Figs. 5 & 6).
49. Male flower of *Ginkgo* (Fig. 33).
50. *Ginkgo polaris* Nath. var. *pygmæa*. (Fig. 20).
51. *Ginkgo polaris* Nath. (Fig. 18).
52. *Ginkgo polaris* Nath. var. *pygmæa* (Fig. 21).
53. *Abietites* sp. (Fig. 42).
54. *Czekanowskia* cf. *rigida* Heer. (Fig. 35).
55. *Czekanowskia*? (Fig. 34).
56. Leaf of *Taxites* with parasitic fungus. 56 a, part of fig. 56 still more magnified.
57. *Pterophyllum*? sp. (Fig. 7).
-

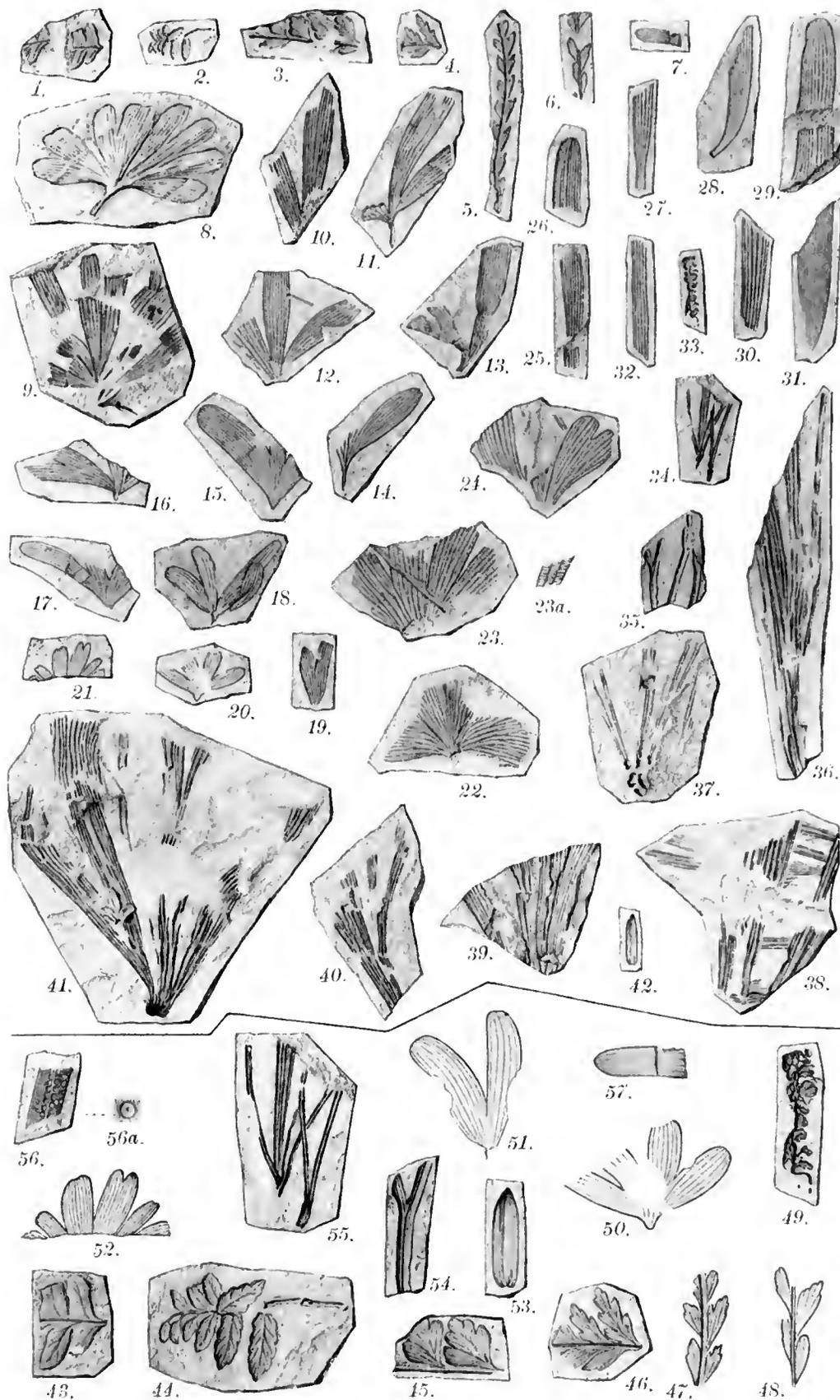
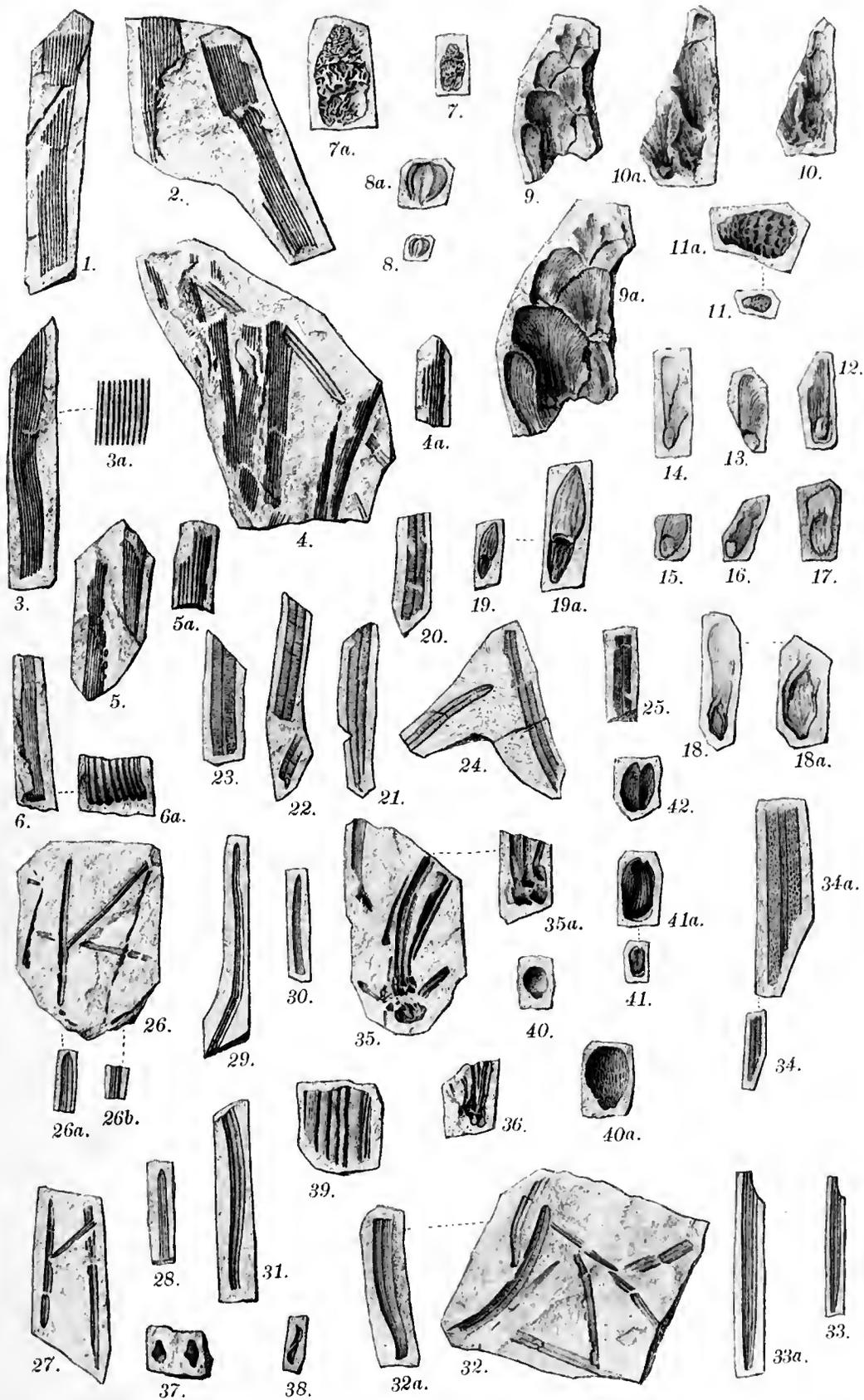

PLATE II.

PLATE II.

- Figs. 1—6. *Phoenicopsis* cf. *angustifolia* Heer. Figs 3a and 6a portions of figs. 3 and 6 magnified.
- 7, magnified 7a. *Pityanthus* sp.
- 8, magnified 8a. *Carpolithes* sp. a.
- 9 & 10, magnified 9a, 10a. *Pityostrobus* sp. a.
- 11, magnified 11a. *Pityostrobus*? sp. b.
- 12 & 13. *Pityospermum Nanseni* Nath.
14. *Pityospermum* cf. *cuneatum* Nath.
- 15, 16?. *Pityospermum* cf. *Maakianum* Heer sp.
- 17, 18, magnified 18a. *Pityospermum* sp.
- 19, magnified 19a. *Pityospermum*?
- 20—23. *Taxites* cf. *gramineus* Heer sp.
- 24, 25. *Pityophyllum* cf. *Staratschini* Heer sp?
- 26—34; 26a, 26b, 32a, 33a, 34a magnified portions. *Pityophyllum* cf. *Lindstrømi* Nath.
37. Transverse section of unknown leaf (*Pityophyllum* or *Czekonowskia*?) thrice magnified.
38. *Pityophyllum* cf. *Lindstrømi* Nath. Transverse section, twice magnified.
39. Impression of wood.
- 40, magnified 40a. *Carpolithes* sp. b.
- 41, magnified 41a. *Carpolithes* sp. c.
- 42, *Carpolithes* sp. d. Twice magnified.
-

1
30



IV.

AN ACCOUNT OF THE BIRDS

BY

ROBERT COLLETT

AND

FRIDTJOF NANSEN.

In the first three sections of this paper, the observations imparted are put together from Nansen's journals, supplemented by his verbal comments and explanations during the preparation of the work. The last section gives the observations made during the time that the ship was drifting with the ice in the summers of 1895 and 1896, and is compiled from written and verbal information received from Scott-Hansen, Blessing and Mogstad, and also from the journals kept by Sverdrup.

The first section (I) treats of the journey along the north coast of Siberia, from Yugor Strait, July 29th, 1893, until the closing in of the ship to the north-west of the New Siberian Islands on September 25th, 1893 (78° 50' N. Lat., 132° 20' E. Long.).

The birds observed during this time were principally on their way southwards. After the closing in of the ship, no birds were seen until the following year.

The second section (II) gives the observations made at the time that the 'Fram' was drifting with the ice towards the NW., during the first summer, 1894, up to the time when Nansen and Johansen started on their sledge-journey, March 14th, 1895. This last point lies in about 84° N. Lat., 101° 55' E. Long.

The first bird seen in the spring of 1894 (a gull, probably *Pagophila eburnea*), appeared on May 13th; birds were seen now and again until after the middle of August. After August 23rd, or the day when all the channels and lanes about the ship began to freeze up, no birds were seen.

During this part of the journey, 8 specimens of *Rhodostethia rosea* were shot and prepared, all of them young birds of that year. They were presented to the University Museum in Christiania.

All this way, no land was seen, not even an island; and of open water, only larger or smaller channels round the ship, especially numerous in the warmest time of the year (from the end of May until beyond the middle of August).

The third section (III) gives observations made during Nansen and Johansen's sledge-journey, first in the North Polar Sea itself in the spring of 1895, then along Franz Josef Land until the homeward journey (from Cape Flora) in August, 1896.

During the journey in the Polar Sea, the first bird seen (a *Fulmarus glacialis*) was observed on May 29th, when the travellers had begun to approach the north side of Franz Josef Land. That part of the journey in which the highest latitude, $86^{\circ} 13'6''$, was reached, was undertaken so early in the year, that no birds were yet visible.

In the summer of 1895, the newly-discovered group of islands, Hvidtenland (to the north-east of Franz Josef Land), was passed.

Several bird-islands were seen, from the Coburg Islands southwards. The last birds (young specimens of *Larus glaucus*) observed that year were seen after settling in the winter hut on Frederick Jackson Island at the end of September. After the winter, little auks (*Alle alle*) began to appear as early as February 25th (1896).

The last observations were made during the stay with Mr. Jackson at Cape Flora, and on the homeward journey along the edge of the ice in the Barents Sea, August 9th, 1896.

The fourth section (IV) gives the observations made on the 'Fram' after Nansen and Johansen had left in March, 1895, until the return of the ship in August, 1896.

During this part of the expedition, birds were observed in the highest northerly latitudes in which birds on the whole have been known to exist.

During the first year, 1895, birds were seen in the period between May 14th and September 14th. All this time, the ship was north of 84° (between

84° 27' and 85° 5' N. Lat., and between 73° and 88° E. Long.), or in a region of the Arctic Ocean, over which Nansen and Johansen had passed early in the same year, on their journey south towards Franz Josef Land.

During this period, while the ship was moving the whole time over a comparatively limited area, situated at a distance of about three hundred kilometres NE of Franz Josef Land, the total number of species observed was 10, namely, *Plectrophenax nivalis*, *Sterna macrura*, *Pagophila eburnea*, *Rissa tridactyla*, *Rhodostethia rosea*, a specimen of a *Larus* which is stated to have been black-backed, a *Stercorarius* (species undetermined), *Fulmarus glacialis*, *Cepphus mandti*, and *Alle alle*. None of the species, however, seemed to occur in any great quantity.

Farthest north was found *Fulmarus glacialis*, of which a specimen was observed in 85° 5' N. Lat.

The last summer, 1896, when the 'Fram' was north of Spitsbergen, the first bird (a snow-bunting) was observed on April 25th. It now appeared that for a distance of at least four hundred kilometres north of Spitsbergen, or between 81° and 83° N. Lat., the Arctic Ocean is inhabited by an abundant bird-life, doubtless consisting principally of young, not yet mature birds, which spend the summer months here, in and near the open channels in the ice.

Among the specimens occurring here, sometimes in great numbers, may be named *Cepphus mandti*, *Alle alle* and *Pagophila eburnea*. A few specimens of waders (*Aegialitis hiaticula* and *Crymophilus fulcarius*) were also found in these northern latitudes, and a specimen of *Xema sabini* was observed.

I.

THE SIBERIAN COAST (AUTUMN 1893).

Plectrophenax nivalis, (Lin.) 1766.

Observed everywhere along the North Siberian coast where a landing was made, up to Taimur Island, and on the west side of Cape Chelyuskin. The birds were seen, as a rule, only singly or a few together.

Falco aesalon, Tunst. 1771.

At the eastern end of Yugor Strait, on July 30th, on the little island Sakolii (or Falcon Island), a couple of these birds were seen, which evidently had young ones, for they darted down with wild screams, almost at Nansen's head. The island was a rocky one, with a precipitous cliff on the north side, near which these birds had their home.

On Renö (74° 46' N. Lat., 85° 42' E. Long.), on August 21st, another falcon was seen from the ship, but on account of the distance, it could not be determined.

? *Archibuteo lagopus*, (Gmel.) 1788.

On Sakolii Island (at the eastern end of Yugor Strait), on July 30th, almost simultaneously with the preceding, a large bird of prey was observed circling at a considerable height. As the wings were rounded, it probably belonged to the above species.

Nyctea scandiaca, (Lin.) 1766.

Both at Khabarova and all through Yugor Strait, this species was numerous in the autumn of 1893; and near the eastern end of the strait

(July 30th), as many as half a score of these birds might be counted at one time from one spot, scattered here and there over the tundra, perched on stones or grass-tussocks. At Khabarova, they were sometimes observed sitting upon the grave-crosses, on the watch for small rodents.

It is probable that the lemming (*L. obensis*) or one of the *Microtus* species had a breeding-year at the time. No living specimen of them was found, however; but all along the Siberian coast, wherever a landing was made, their holes and burrows were observed in the hillocks.

Lagopus lagopus, (Lin.) 1766.

This species was observed twice on the Yalmal Peninsula (69° 37' N. Lat.).

On August 8th, a covey was found there, consisting of a cock and four hens, all of them full-grown specimens. (They were all shot.) Subsequently a hen-bird was found, keeping guard over a single young one, rather larger than a thrush, and just able to flutter; the rest of the brood may have been taken by birds of prey (or by the arctic fox).

On August 20th, 'Ryper' were observed on Renö (74° 46' N. Lat.), but at so great a distance, that the species could not be determined. On September 8th, a specimen was observed at rather closer quarters, in Toll Bay, Chelyuskin Peninsula (76° 32' N. Lat.). The bird, which was a male, had scarcely begun to turn white, and still had a quantity of brown (not grey) feathers on its breast. The ground was not yet covered with snow.

Squatarola helvetica, (Lin.) 1766.

On August 8th, several specimens of this species were seen on the Yalmal Peninsula¹; and on August 20th and 21st, several more were seen on Renö (74° 46' N. Lat.). They all appeared to be full-grown, as the breast was still black. The ground here was a ling-covered tundra.

?*Totanus nebularius*, (Gunn.) 1767.

A good-sized wader, of a mottled grey colour, and rather smaller than a whimbrel, and which may possibly have been a greenshank, was seen on the

¹ In "Farthest North", vol. I., p. 140, this species, by an inaccurate translation, has been called the "golden plover".

Yalmal Peninsula on August 8th (69° 37' N. Lat.). It had its haunt near a brook on the tundra, where it probably had young ones, for it circled round the travellers with loud cries, and often lighted on the ground close to them.

On Renö (one of the Kjellman Islands), on August 20th, another large wader of a mottled grey colour was seen among the numerous waders occurring there. It probably belonged to this species.

Arquatella maritima, (Gmel.) 1788.

Seen here and there along the coast of Siberia as far as Cape Chelyuskin, generally in little flocks of eight or ten birds, often singly, but never in large flocks. On Renö (one of the Kjellman Islands), however, they were numerous on August 20th and 21st, and one specimen was shot¹.

The last specimens seen on the mainland were in Toll Bay, Taimur Gulf (at the beginning of the Chelyuskin Peninsula), on Sept. 8th².

Lastly, to the south of the edge of the ice, on September 20th, (77° 50' N. Lat., about 137° E. Long.), a flock of small waders, flying southwards, was seen from the ship. They were supposed to belong to this species. This was directly to the north of Kotelnoi, and their appearance here in a flock, may possibly indicate the existence of land farther north.

Phalaropus hyperboreus, (Lin.) 1766.

Seen in great numbers on Renö (one of the Kjellman Islands) on August 20th and 21st. They were in the sea near the shore (74° 46' N. Lat.).

Crymophilus fulicarius, (Lin.) 1766.

On August 20th and 21st, numerous specimens of the grey phalarope were also seen on Renö. These, too, were near the shore, but without mingling with the preceding species.

¹ A wing of this bird was brought to the Christiania Museum.

² In his journal, Nansen writes in the entry for September 2nd, (on Taimur Island), that the birds of passage had almost all gone south. During the last days of August, they met flocks of waders out on the sea, where they were probably collecting for their flight southwards.

On September 20th, when the 'Fram' had just reached the edge of the ice (77° 46' N. Lat.), a flock of waders was seen flying from the ice towards the ship, together with flocks of *Rissa tridactyla*. They followed the ship for some time, and then set off southwards. These were supposed to have been grey phalaropes.

?Anser segetum, (Gmel.) 1788.

At Khabarova, on July 30th, during an expedition to the eastern end of Yugor Strait, several flocks of grey geese were seen, consisting of old birds with their young ones, the latter just able to fly.

Branta bernicla, (Lin.) 1766.

Even at Khabarova, from July 30th to August 2nd, numerous specimens of this species were seen, and several were shot. They were subsequently observed frequently as far as Taimur Island; on certain days in the middle of August, they were to be seen in flocks of various sizes, passing the ship on their way south. On August 20th and 21st, they were again seen in large flocks, making a halt on Renö (one of the Kjellman Islands). During this time, they showed comparatively little timidity.

On August 31st, a solitary specimen was observed sitting on a piece of ice near Taimur Island (76° 30' N. Lat.). It was then snowing fast, and the ground soon became white.

Harelda glacialis, (Lin.) 1766.

On July 30th, in Yugor Strait, numerous, in some instances large, flocks were seen, seeming, near the eastern end of the strait, to number some thousands. They also occurred in the lakes on the Yalmal tundra, as far as excursions were made (August 6th and 8th). A number of them were shot for food.

Subsequently, too, they were observed occasionally up through the Kara Sea. At the Kjellman Islands (Renö), a flock was seen on August 21st.

Somateria mollissima, (Lin.) 1766.

A few solitary specimens were observed at Khabarova in Yugor Strait, on July 30th and 31st. They all appeared to be dark in colour (summer plumage).

No eider-ducks were afterwards seen until September 16th, to the east of Chelyuskin, when several flocks were seen from the ship, almost off the mouth of the Olenek. As the typical *S. mollissima* has not with certainty been observed east of the Kara Sea, it is probable that it was *S. v-nigra*.

Sterna macrura, Naum. 1819.

Seen here and there along the Siberian coast from Yugor Strait almost up to Cape Chelyuskin. Two or three were seen on August 18th on Renö (74° 46' N. Lat.). The last seen was observed in Taimur Bay (off the King Oscar Peninsula) as late as September 7th (76° 32' N. Lat.).

Rissa tridactyla, (Lin.) 1766.

Both in the Kara Sea, and all along the coast of Siberia, there proved to be very few gulls; and except in Yugor Strait, (at about the end of July and the beginning of August), they were seldom seen in any great numbers.

The species that occurred most frequently was the kittiwake. This bird was seen flying about over the sea, and was observed almost daily, though seldom otherwise than singly or a few together. It appeared to be somewhat more numerous farther east; and several specimens were observed in the middle of August along the Taimur coast, and on the Kjellman Islands. This part of the Siberian coast did not seem to afford suitable breeding-places for this species.

The ship met flocks of kittiwakes when she came up to the edge of the ice on September 20th, in 77° 46' N. Lat., to the north of the New Siberian Islands. During the few following days, they were still seen occasionally; but when the ice began to close in round the 'Fram' (Sept. 24th), they disappeared altogether. These were the last birds seen that autumn.

A dead specimen was found floating on the water on September 20th (77° 50' N. Lat.).

Larus glaucus, Fabr. 1780.

A few specimens were observed at Khabarova from July 30th to August 2nd, and also one or two subsequently in the Kara Sea; but none can be said with certainty to have been seen farther east. On Renö (Kjellman Islands), on August 20th and 21st, some large gulls were seen in the distance that were supposed to belong to this species.

? *Larus fuscus*, Lin. 1766.

On July 30th, in Yugor Strait, off Khabarova, a few specimens of a gull were observed, that possibly belonged to the above species. The back was slate-coloured, but seemed to be a shade lighter than in *L. fuscus*: the species may have been *L. fuscus*, or possibly *L. affinis*, Reinh. 1853.

On the Kjellman Islands (off Renö), on August 21st, a few gulls were again seen, belonging to one of the smaller, black-backed species (74° 46' N. Lat.).

? *Larus argentatus*, Gmel. 1788.

On August 21st, on the Kjellman Islands (Renö, 74° 46' N. Lat., 85° 42' E. Long.) a specimen of a large, light-backed species of gull was observed, with black spots on the tips of the wings. As *L. argentatus* is stated by other writers (Middendorff, Bunge) to have been observed eastwards as far as the mouths of the Lena and Yana, it is possible that this bird belonged to that species, and if so, probably to the variety *L. vegae*, Palmén 1886.

This last variety, described in "Vega-Expeditionens vetenskapliga Arbeten" (Vol. V, p. 370) in 1886, differs from the typical *L. argentatus* (from Northern and Western Europe) in being of a considerably darker colour on the back and the upper surface of the wings¹. It was found during the Vega Expedition in the spring and summer of 1879, on the Tchuktchi Coast, in large numbers. According to Palmén's investigations (l. c. p. 376), it is probable that the *L. argentatus* found by Middendorff in the Taimur Land in 1843,

¹ The feet, however, are flesh-coloured, as in the typical species, not yellow, as in *L. affinis*

and which is still preserved in the St. Petersburg Museum, belongs to this variety.

Pagophila eburnea, (Phipps) 1774.

The first specimens seen were on Taimur Island, between August 29th and September 2nd (76° 30' N. Lat.); they all appeared to be adults, with white plumage. Some few specimens were subsequently seen on the Chelyuskin Peninsula, on September 7th (King Oscar Peninsula), but none later in the autumn in the ice.

Stercorarius crepidatus, (Banks) 1773.

This species was observed at several places along the Siberian coast, from Yugor Strait up to Cape Chelyuskin.

On July 29th, a specimen was shot on a small lake close to Khabarova; its still downy young one was also shot as it swam out to hide among the rushes. The full-grown bird was white-bellied.

On Renö (Kjellman Islands), on August 20th and 21st, both this and the following species were observed, but the latter in the greater number.

On September 2nd, a good many skuas were still to be seen at Cape Laptev on Taimur Island; and on the 4th, Nansen saw several, in the sound called by Nordenskiöld the Taimur Sound, persistently chasing a *Canis lagopus*. When they became aware of Nansen's presence, they flew straight at his head, and thenceforth divided their attack between him and the fox. A considerable quantity of snow had already fallen, and most of the birds of passage had disappeared; there were also very few of either gulls or kittiwakes. Most of the specimens of Richardson's Skua, observed during the expedition, were light-bellied.

Stercorarius longicaudus, (Vieill.) 1819.

Observed frequently (in some cases mingling with the preceding species) as far as Cape Chelyuskin.

A few were even seen in the Kara Sea during the early days of August; but they did not occur with any frequency until August 11th on the Yalmal Peninsula, and subsequently along the Taimur coast (numerous specimens were observed on August 19th). In several places, *e. g.* Renö

(Kjellman Islands), they were more numerous than the larger species, a fact which had already been observed by Middendorff, and subsequently, in 1878, during the Vega Expedition.

The last specimens noted were seen on September 7th, in Taimur Bay, off the King Oscar Peninsula (76° 32' N. Lat., 98° 30' E. Long.).

? Colymbus arcticus, Lin. 1776.

On August 6th, in several lakes on the Yalmal Peninsula, was seen (and heard) a large species of *Colymbus* that was probably *C. arcticus*. None was shot.

A large *Colymbus*, probably the same species, was also seen in Yugor Strait.

Cepphus mandti, (Licht.) 1822.

A single specimen of a black guillemot was seen at the edge of the ice on September 20th, to the NW of the New Siberian Islands (77° 50' N. Lat.), shortly before the ship was enclosed in the ice. The bird was in its winter plumage (or was a young one).

Uria lomvia, (Pall.) 1811.

All the way through the Kara Sea, and along the Siberian coast to Cape Chelyuskin, no little auks or guillemots were seen.

On September 12th, when the ship was outside Khatanga Bay (on the Eastern Taimur Peninsula), a few specimens of Brännich's guillemot were seen swimming about among the pieces of ice. They probably originated from Preobraschenie Island, where Nordenskiöld, in August, 1878, during the Vega Expedition¹, found a large colony established (together with *Rissa tri-dactyla* and *Larus glaucus*). This colony is probably the first east of Novaja Zemlja.

Off the New Siberian Islands, no birds were seen. A solitary bird, seen at some distance off in the sea, on September 19th, when the ship was almost in 77° N. Lat., was supposed to be a guillemot.

¹ 'Vegas Färd kring Asien och Europa', vol. I, p. 337. (Stockholm, 1880). English edition: 'Voyage of the Vega', vol. I, p. 352. (London, 1881).

II.

THE FIRST SUMMER (1894) IN THE ICE.

Plectrophenax nivalis, (Lin.) 1766.

On June 21st, 1894, when the 'Fram' was in 81° 49' N. Lat., 121° 40' E. Long., a single specimen came to the ship, the only one that was seen. It came out of the mist to the south, and settled on the refuse-heaps near the ship, where it was shot. It was a male.

Rissa tridactyla, (Lin.) 1766.

The first kittiwake observed during the spring of 1894, was probably seen on June 22nd; but, as on several previous occasions, the bird was just far enough away to prevent the certain determination of the species¹.

As soon as channels began to open up round the ship in the summer (July, 1894), kittiwakes appeared more regularly, and were soon seen very often, hovering over them, evidently looking for crustaceans. On some days several specimens appeared; on July 12th, for instance, eight were seen at one time.

Being rather shy, only one specimen was shot (by Sverdrup), on July 14th.

They continued to make their appearance (though not, on the whole, in great numbers) until beyond the middle of August, when the lanes and channels

¹ As early as May 13th, a bird was seen in the distance that might possibly have belonged to this species, but which was more probably *Phagophila eburnea* or *Fulmarus*.

began to freeze up (August 23rd). The ship was then in 81° N. Lat., 128° E. Long. They were not seen subsequently.

Rhodostethia rosea, (Macg.) 1824.

None of this species was observed during the voyage along the Siberian coast, nor yet, with certainty, north of the New Siberian Islands during the first autumn.

In the second autumn (1894), when the ship was in 81° 5' to 81° 8' N. Lat. and 127½° E. Long., eight specimens, all young birds of that year, were shot between August the 3rd and 8th. No others were observed with certainty. The distance from the nearest known land (the New Siberian Islands and Cape Chelyuskin) was about 560 kilometres.

On August 3rd, three small gulls were seen flying round the ship; they were all shot by Nansen, and were at once recognised as young specimens of the roseate gull.¹

When the first of them was observed in the distance by Nansen, he took it for a kittiwake; but he soon saw that it was more like a skua, with its long, pointed wings, its wedge-shaped tail, and its dark colour. When Nansen came out again after having been on board to fetch his gun, there were two birds together; they flew several times round the ship, close by, and were easily shot, as they were not shy. When the first had been shot, the second came and flew backwards and forwards above Nansen, who shot at it at too long a range, for fear of damaging its skin. After fetching more cartridges, he placed himself behind a piece of ice, with his head above the top "in order to keep an eye on the bird, which was circling above the fresh-water ponds, the lanes, and the dogs, dropping down now and again when it saw something in the water". It then directed its flight straight towards him, and came right above his head, evidently to see what he was. It was shot at too close range, so that the head was shot off.

¹ One or two of the crew stated subsequently that three specimens of the same species (possibly the very same birds) had been observed several times on the previous day near the ship; they made no mention of them, however, believing them to be kittiwakes. They had circled for some time as if in play, about the masts, and it looked almost as if they were pecking at the ship's pennant.

Later in the morning came a third, which was also shot. It fell into a narrow channel in the ice, and when it was lifted up, it dropped out of its mouth two or three large shrimps, which, however, fell into the water.

On August 6th, a few specimens were again seen flying round the ship. First one came in the morning, but flew away again in a north-easterly direction, after having circled two or three times round the ship. In the afternoon, one appeared once more (possibly the same one), and was shot while seated on a piece of ice. In the evening, another specimen was shot (by Sverdrup). This, like the others, came from the NE.

On August 8th, three specimens came flying towards the ship, high up in the air. They were all shot, and were the last seen that year.

As already mentioned, they were all young birds of that year, and just old enough to fly. Most of those whose arrival could be observed, seemed to come from the NE. As clear weather had just set in after a long time of thick weather, this was possibly the reason of their making towards the ship.

In flight they most resembled the kittiwake, theirs, however, being still lighter, though sometimes appearing somewhat uncertain and, as it were, wavering (a circumstance which may be explained by their youth). They disported themselves in airy and playful movements, sometimes chasing one another, and now and then uttering a peculiar, faint cry, but generally silent. They were not shy, but often flew about in close proximity to the men; they seldom alighted on the ice, but apparently preferred hovering above the channels.

The youngest specimen of this species hitherto known and described, was one that was shot on October 10th, 1879, in Alaska (near St. Michael's, Norton Sound). This bird has been treated of in detail by Nelson in 'Birds of the Behring Sea and the Arctic Ocean' (Cruise of the Revenue Steamer 'Corwin' in Alaska, etc. 1881)¹; and a figure of the specimen is introduced into the same author's 'Report upon Natural History Collections made in Alaska', 1877—81, No. III².

¹ Washington, 1883, p. 106.

² Washington, 1887, p. 55, Pl. III.



Rhodostethia rosea, Macg. Two specimens shot Aug. 3rd, 1894.



If the ordinary breeding-time for *Rhodostethia* can be placed at the beginning of July, the specimen described by Nelson will have been about three months old¹.

The eight young birds from the 'Fram' Expedition corresponded with one another in all essential particulars². Some were rather less pure in colour than others, and might be supposed to have been a few days younger; but on the whole, the plumage was such as is worn by a young bird just old enough to fly. The neck-feathers, for instance, were still soft and half downy.

Description of Young Bird (about one month old). (See Plate). The whole of the upper surface of the body (*i. e.* the upper surface of the head and neck, starting from the base of the bill, and including the shoulder, the interscapular region and the tertiaries) chiefly brownish black, with a more or less whitish colour intermingled, the inner part of the feathers being for the most part white, the outer brownish black. The crown, and the nape of the neck are the darkest, as there the dark outer margins of the feathers (in some specimens) almost completely cover one another.

All the back and shoulder feathers end (beyond the outer dark portion of the feathers) with a narrow border of pale pinkish grey.

The sides of the head are whitish; round the eyes the colour is dark, and a dark patch extends over the region of the ears, lighter in some specimens, and faintly defined, in others more distinctly brownish black.

The throat and abdomen are white. On the newly-shot specimen, Nansen found on the abdomen a scarcely perceptible shade of orange-red. A brownish black band runs right across the breast, broader and more marked in some specimens than in others. The reason of this band is that the feathers there

¹ It appears from the figure given by Nelson, that the plumage in his specimen has already undergone some change from its very earliest young-bird's plumage (such as the 'Fram' specimens still wore). The colours, as a whole, have become lighter and purer, and a few originally dark markings have disappeared. Several pure white feathers, for instance, have appeared on the back; the cap has become lighter, and the dark band across the breast has disappeared.

As Nelson states (*l. c.* p. 55) that the number of tail-feathers is ten, his specimen must have been imperfect: their number is twelve.

² Seven of the specimens were preserved as skins, and their bodies in alcohol. The eighth, of which the head was nearly shot off, was placed in spirit. The whole collection was presented by Nansen to the University Museum in Christiania.

have narrow, faint, and indistinctly defined, brownish black borders. Some specimens, moreover, have traces of a brownish black shading along the sides of the abdomen.

The feathers of the lower part of the back are white, with broad, brownish black borders, of which the external margin shows a tinge of pinkish grey. The rump and the upper tail-coverts are white, some feathers, however, having very faint indications of a dark border at the tip.

The outer half of the shoulder-feathers and the upper wing-coverts is brownish black, with narrow blackish grey borders; the upper row of the secondary wing-coverts (overlying the secondaries and tertiaries), however, are already white in most of the specimens; while in two or three of them they are dark like the rest of the coverts.

Of the wing-feathers, all the primaries have black tips (about 20 mm. broad); in the 1st, 2nd and 3rd, the outer web, shaft and adjoining portion of the inner web is quite black, the rest of the inner web white. In the 4th and 5th, the white extends also to part of the outer web. The feathers from the 6th to the 10th are chiefly white (above the black tip). In most of the specimens, the black is sharply defined against the white; in a few (possibly the youngest), the line of demarcation is less distinct, and the colours less pure.

The secondaries are white, the innermost, however, with increasingly dark outer web. The tertiaries, which, when at rest, lie along the back, are chiefly brownish black with narrow pinkish grey borders, like the rest of the upper surface of the back.

The primary coverts are brownish black, the secondary coverts white, thus forming an oblong, white speculum upon the folded wing.

The lower surface of the wing is white, though brownish black near the outer margin: the shafts are white.

Of the tail-feathers, only the two lateral ones, as a rule, are entirely white; the rest have brownish black tips. In two or three of the specimens, the 3rd is also pure white, and in one of the eight, the 4th also. The brownish black tip is broadest in the elongated 6th (middle) tail-feather, where the breadth is sometimes as much as 42 mm. (in most of them rather less, in one only 26 mm.); in the long 6th rectrix, the dark terminal band runs in

a short point up the shaft. The middle (long) rectrices extend from 12 to 15 mm. beyond the others¹.

If the plumage of these young birds be compared with the corresponding plumage in other species of *Laridæ*, there is none that *Rhodostethia* more closely resembles in this respect than *Xema sabini*. The distribution of colour is essentially the same in both, particularly in there being dark feathers on the back, with narrow, but clearly-marked, pinkish grey, or greyish white borders. But the distribution of white and black on the wing-feathers is again quite different, and in this respect, *Rhodostethia* resembles no species of the genera *Larus*, *Rissa*, *Xema*, or *Sterna*. The black tips of the inner, short primaries (5 to 8), do not quite cover the white part on the underlying primaries, whereby an alternating row of black and white spots is produced along the superior border of the folded wing.

Food, etc. On an examination of the bodies of the specimens — which are all preserved in alcohol — it appeared that all the birds had been in good condition, and the gizzard, when they were shot, was more or less filled with food. The food consisted exclusively of crustaceans and small fish; no refuse, such as might have been taken from the neighbourhood of the ship, was found.

As already mentioned, the chief contents of the gizzards were crustaceans, and in all the specimens, parts of *Hymenodora glacialis* (Buchh. 1874) could be recognised². Prof. G. O. Sars, who has kindly determined these

¹ In the large collection of old and young specimens that was made by the International Polar Expedition to Point Barrow, in September and October, 1881 and 1882, three young birds (now belonging to the Smithsonian Institution in Washington) are described in detail in the report of this expedition (Report of the International Polar Expedition to Point Barrow, Alaska, pp. 124, 125. Washington. 1885), as they were supposed, from their plumage, to be somewhat younger than the other specimens. In these three specimens, "the middle rectrices are black-shafted, with this color extending more or less on the webs, continuous of the black of the tip".

In all the 'Fram' specimens, which were several weeks younger, the shaft, above the black tip, was white; in a single specimen, a darker shade extended a little way up from the tip on both sides of the shaft, which itself was white.

² This ephyrid, which is related to *Pasiphaë*, inhabits exclusively the Arctic Ocean. Professor G. O. Sars ("The Norwegian North Atlantic Expedition 1876—1878. Vol. XIV. Zoology. Crustacea", p. 37, Pl. IV. Christiania, 1885) considers this species to be a pelagic form that is not confined to any particular stratum of water; for while the type specimen was taken (during the 2nd German North Polar Expedition) on the very surface of the water in the sea to the east of Greenland, the numerous specimens of the North Atlantic Expedition were taken at various depths, down to 1862 fathoms.

remains of crustaceans, has only found one specimen of this species in the plankton-collections brought home by the Expedition. As these animals are very quick in their movements, they were probably not easily caught in the tow-nets, which were only slowly carried along with the drifting ice.

Of other Crustacea, only remains of *Gammarus locusta* were found, in one bird. This species is one of the commonest amphipods in the collections of the 'Fram'.

On the other hand, all the specimens contained remains of a *Gadus*, probably *G. saida*. This did not seem, however, to have been captured in the immediate vicinity of the ship, as only some vertebræ and a few otoliths remained. The length of the latter varied from 2.5 to 6 mm.

Of parasites, there were found a few small Tænioids in the intestinal tube (probably originating from the *Gadus saida*).

The eight young birds included both males and females. In those males where the testes were in the best state of preservation, the left was the longer (about 2.5 mm. long), and of a light colour; while the right one, which was rather smaller, was partly brownish black.

Larus glaucus, Fabr. 1780.

Only two or three specimens were observed while in the ice during the summer of 1894. The first specimen (that in all probability belonged to this species) was heard by one of the crew on June 19th: the atmosphere was misty, so that the bird could not be seen. On July 6th, one was certainly seen; it flew round the ship, and disappeared in a north-westerly direction (81° 31' N. Lat., 124° 26' E. Long.).

Lastly, on July 14th, a large gull was seen in the distance, that was supposed without doubt to belong to this species.

Pagophila eburnea, (Phipps) 1774.

From the spring right on until towards the end of August (1894), when the channels around the ship froze up, this species appeared very frequently, sometimes several birds daily. During this period, the ship was between 80° 50' N. Lat., 130° E. Long. and 81° 52' N. Lat., about 121° E. Long.

On May 13th, 1894, the first bird of the year was seen in the neighbourhood of the ship by Nansen and Johansen. It was either a gull (a kittiwake or an ivory gull) or a fulmar, but it was too far off to allow of its being determined with certainty. It flew over the ship towards the NNW., and was hailed as a messenger of spring.

On May 19th, at three in the afternoon, a gull was again heard. The weather was foggy, so that the bird could not be seen; but from its shrill querulous cry, it could be certainly recognised as belonging to this species. It also flew northwards, after flying once round the vessel. On the following day, a bird was again seen (possibly the one of the preceding day), and it flew southwards.

On May 23rd was heard the unmistakable cry of an ivory gull, flying NW. or NNW.; but the bird itself was not seen, as the atmosphere was thick with a wet fog. On June 2nd, two birds came, and after flying two or three times round the ship, flew away; but they returned, and remained for some time in the neighbourhood of the ship.

On June 5th, five *P. eburnea* came flying up from the south, and more followed during the day. One of these was shot — the first bird after the winter.

On June 6th, ivory gulls were seen often and at various times. They seemed to be attracted by the refuse-heaps, but did not appear to have any fixed course. During the few days following, several more were seen (on the night of June 7th, two together; on the night of June 8th, a flock of six), all of which flew due north.

On June 22nd, four were seen together, flying towards the NW. On June 25th, a few more appeared, and one of them was shot by Sverdrup.

Throughout July, ivory gulls, as well as *Fulmarus* and *Rissa*, were seen frequently, though the particular occasions were not noted down. A few were also seen in August; but after the 23rd of that month, the channels round the ship froze up, and no more birds were seen that year.

All the specimens observed seemed to be in adult plumage. They appeared to live in a great measure on blubber, and preferred to keep near places where bears had been skinned. They often alighted on the ice, and were not very shy, though more so here on the ice by the 'Fram', than they

afterwards appeared to be by the winter hut on Franz Josef Land, and during the journey along that shore.

? Stercorarius crepidatus, (Banks) 1773.

One of the smaller species of *Stercorarius* was seen a few times in July, 1894, but not sufficiently near the ship to allow of any certain determination of the species.

On July 14th, a bird was seen, that Peder Hendriksen could say without doubt was a skua. Sverdrup saw two flying above him that night, when he went out to hunt a ringed seal (*Phoca foetida*). From their description, Nansen thought they must have belonged to this species, and not to *St. longicaudus*.

Fulmarus glaciālis, (Lin.) 1766.

Like *Pagophila* and *Rissa*, this species was frequently observed while the ship was drifting with the ice the first year. It could not, however, on the whole, be said to be numerous, and when seen, was generally solitary.

The first specimen that could be determined with certainty, appeared on June 22nd, 1884, the second on the 26th. On the 29th, yet another was seen, and was shot by Scott-Hansen (81° 34' N. Lat., 122° E. Long.).

In July and the beginning of August, they were observed more frequently round the ship, until the channels froze up towards the end of August, 1894.

Cephus mandti, (Licht.) 1822.

On June 4th, 1894, at 1:30 A. M., Mogstad saw in the distance, "a black sea-bird, with white marks on its wings", flying past the ship in a direction true N. by E. (81° 29' N. Lat., 122° E. Long.), which probably belonged to this species.

In the course of the summer, solitary black guillemots were repeatedly seen flying about over the open channels near the ship. On July 13th, two were seen together; they flew several times round the 'Fram', and disappeared in the SE. Subsequently they were occasionally seen in the channels. The last was seen here on August 12th.

Although the arctic black guillemot, like its congener on the continent, must, on the whole, be considered a littoral form, it here appeared that in the summer, these birds (probably the younger, immature ones) distributed themselves over the Arctic Ocean, at considerable distances from the nearest land. Further confirmation of this fact was obtained north of Spitsbergen, during the return voyage of the 'Fram'.

? *Alle alle*, (Lin.) 1766.

On June 26th, 1894, Mogstad and Jacobsen observed a small sea-bird, belonging to this, or the previous species, flying over the ship in a north-westerly direction. As it was at a considerable height, it was taken to be a little auk, and not a black guillemot (81° 37' N. Lat., 121° E. Long.).

This may possibly have been a stray specimen, as no more of this species, nor of the larger *Alcidæ*, were observed. Breeding-cliffs and colonies of *Alcidæ* did not therefore seem to occur in the region traversed by the 'Fram' that summer.

III.

THE SLEDGE-JOURNEY AND FRANZ JOSEF LAND (1895, 1896).

Plectrophenax nivalis, (Lin.) 1766.

During the entire sledge-journey over the North Polar Sea, none of this species was observed until the arrival at the north-east side of Franz Josef Land, when half a dozen were seen on Torup's Island (Coburg Islands), on August 16th, 1895. Subsequently they were seen during the journey south, on Franz Josef Land, at most points where there was bare ground, though never in large numbers.

All through the winter, they were never seen. The first that appeared after the winter, was seen near the winter hut, on April 30th (1896).

Arquatella maritima, (Gmel.) 1788.

On June 5th, 1895, Johansen saw a wader flying over him, which may have been this species, or perhaps a phalarope (82° 18' N. Lat.).

The purple sandpiper was seen once or twice during the journey southwards along the coast of Franz Josef Land, in 1895. In the end of August and beginning of September, a few specimens were seen on the shore near the winter hut.

On June 13th, 1896, off the south coast of Northbrook Island (west of Cape Barents), several flocks of waders, evidently belonging to this species, were seen flying westwards.

During June, July and August, 1896, the purple sandpiper was very commonly seen in the neighbourhood of Cape Flora.

Branta bernicla, (Lin.) 1766.

It is probable that this species has breeding-places both in the middle and northern parts of Franz Josef Land. On September 6th (1895), two of them were seen flying over the winter hut, (on Frederick Jackson Island) in a south-easterly direction. On June 1st, 1896, during the journey south from the winter hut, on Mary Elizabeth Island, were seen a quantity of excrements and empty egg-shells from the previous year, evidently belonging to this species. The island, called "Goose Island" in Nansen's journal, is flat, and the ground is to some extent composed of mud and gravel, and is in places covered with moss and other vegetation. (81° 7' N. Lat.).

On June 5th, 1896, two brent geese were seen sitting on the shore-ice at Cape Richthofen.

Some of these birds were also seen during the stay at Cape Flora, in June and July, 1896, but no breeding-places were found there.

Somateria mollissima, (Lin.) 1766.

On only one occasion was this species observed on Franz Josef Land. A flock of six specimens was seen (simultaneously with the two *Branta bernicla*) swimming in the open water near the shore at Cape Richthofen, on June 5th, 1896. The flock included individuals of both sexes (80° 46' N. Lat.).

Sterna macrura, Naum. 1819.

Two or three specimens were seen in the vicinity of Hvidtenland, on the 7th August, 1895, (on the north side of Liv Island), in 81° 42' N. Lat.

This was the only time that this species was observed during the sledge-journey in 1895.

In June and July, 1896, several specimens were seen near Cape Flora. A pair seemed to be breeding somewhere in this neighbourhood, although no nest was found.

Rissa tridactyla, (Lin.) 1766.

During the sledge-journey, this species was seen frequently.

The first specimen in the spring, 1895, was observed on June 13th, in

about 82° 20' N. Lat. By degrees they came to be observed almost daily, and several specimens were shot (together with *Pagophila eburnea* and *Fulmarus glacialis*) as food for the dogs. Here in the ice, however, they seldom appeared otherwise than singly or only a few together.

Close to Hvidtenland, they became more numerous, and were seen in great numbers all through the autumn along the coasts of Franz Josef Land, wherever there was open water (e. g. on the NW side of Karl Alexander Land).

Along the shore near the winter hut, great numbers of them were seen daily, until the middle of September, when the sea outside was entirely frozen over, and they disappeared. They were chiefly old birds. They almost always kept only over open water, busily engaged in catching crustaceans. Flocks of them moved incessantly up and down along the shore, hovering over the water moving with the tidal current, and darting down with a dull splash against the surface of the water, whenever a crustacean or other animal appeared; but they frequently had to share their booty with *Stercorarius crepidatus*. They seemed to live exclusively on small marine animals, and never touched the blubber and flesh of the bears and walruses killed by the travellers, in which respect they differed widely from *Pagophila eburnea*, and *Larus glaucus*.

After the winter, they first appeared at the winter hut on May 13th (1896), although there was no open water within a distance of 35 kilometres. The very next day several were seen. After this they were seen fairly frequently, but not in great numbers until May 22nd, 1896, when flocks of them were seen near Cape M'Clintock, whence there was only a short distance to open water.

Cape Flora, on the south coast of Franz Josef Land, was the first place where their nesting-places were actually seen. At the time of Nansen's arrival there on the 17th June, laying had not begun; the first eggs were found some days later.

The last specimens that could have belonged to Franz Josef Land were seen during the homeward voyage in the 'Windward', on the border of the open water in the Barents Sea, on the 9th August. These seemed to be chiefly young birds of the previous year.

Rhodostethia rosea, (Macg.) 1824.

For the second time during the expedition, *Rhodostethia* was observed, this time between the 11th July and the 14th August, 1895. This was in the region between the ice far to the north of Hvidtenland, and Dickson Sound, on the north-east side of Franz Josef Land. On this occasion, not only a few were seen as in the previous year, north of the New Siberian Islands, but great numbers; and they were principally older, fully coloured birds. After passing Dickson Sound (the sound between Hohenlohe Island and Karl Alexander Land), not another specimen was seen. The region in which they were observed this time, lies between $82^{\circ} 10'$ and $81^{\circ} 30'$ N. Lat.; and it is evident that they must breed somewhere on the north-east side of Franz Josef Land — perhaps on Liv Island — though no nesting-place could be discovered during the journey.

The first individual of this species was seen on the 11th July, 1895 (about $82^{\circ} 8'$ N. Lat.). Nansen and Johansen were then at least 50 kilometres NE of Hvidtenland, or about on a level with Cape Fligely. The bird came flying from the north-east, and disappeared towards the south-east; it was full-coloured, and in flying, distinctly showed the black ring round its neck, but it was not near enough to show the rosy colour on the under surface of its body.

On the days following there was fog, and the ice had closed up, and few birds of any kind were visible. On July 14th, another roseate gull, an old bird, was seen. It came flying low, made a tour round the camp, showing its beautiful rose-coloured breast and belly, and then disappeared into the mist to the west. On July 17th, the next was seen, on the 19th, two more, all full-coloured specimens, and flying from NE to SW (about in the direction of Hvidtenland).

During the latter half of July, they were observed more frequently, though not quite every day. On the 27th, two came together from the S, circled close above the heads of the travellers, and again disappeared in the south. One of these was a young bird, the first that had been observed this season. A little later, a full-coloured bird was seen. Hvidtenland had then already been seen in the distance.

As long as the travellers were in the drifting ice itself, far from the land, the roseate gulls could not be said to be numerous. They appeared, as a rule, only singly or in pairs, seldom several together. On July 29th, for instance, they were seen altogether four times, but only single birds; on the 30th (one pair in the morning and one pair in the afternoon) and 31st July, and the 3rd August, only single, full-coloured pairs were seen each time.

Only off Hvidtenland did they become at all numerous. On the 7th and 8th August, they were seen repeatedly (near Eva and Liv Islands), whole flocks of them flying about or sitting on the edge of the glacier, which was about 50 or 60 feet above the sea. Young and old were together. Whether there was any nesting-place in the neighbourhood, however, could not be ascertained.

Eva Island is completely covered with glacier, and does not appear to have a single patch of bare ground. From the top of Adelaide Island (August 9th), a strip of low, bare ground could be discerned on the NW coast of Liv Island, possibly an old beach-line, about 20 or 30 feet high, and perhaps 1 kilometre long, apparently forming a low beach, partly covered with rock débris. With this exception, Liv Island was also snow-white, and covered with a dome-shaped ice-cap sloping down into the sea on all sides, without any abrupt glacier edge. Of all the land that was in sight, this was the only spot free from snow, where birds could possibly breed; but whether the locality would be considered suitable as a nesting-place for this species, and whether it was large enough, is doubtful, although it seemed to resemble the places where nests of the ivory gull have been found.

The last specimens were seen near the Coburg Islands between the 11th and 14th August. After that they vanished completely, and no specimen was seen during the rest of the journey; and there was thus no sign of their inhabiting any locality in the region between Dickson Sound and Cape Flora.

In their movements they recalled *Rissa tridactyla*. They appeared to find their food exclusively among the pelagic organisms on the surface of the water. They never came near the provisions (like *Pagophila eburnea* and *Larus glaucus*) to take any of them. They generally flew rather low, and were on the wing night and day. They often flew close to the kayaks, but were never seen swimming. They were extremely graceful in their move-

ments; they often rested on the edge of the ice close to the open water. As mentioned above, they were frequently seen sitting upon the edge of the glaciers, where these went precipitously down into the sea.

Now and then they might also be seen resting on the floe-ice some distance away from the water's edge. On the 8th August, Johansen came upon one sitting, apparently asleep, right on the flat ice off the shore of Adelaide Island; and it let him come within a few paces of it. It was a young bird of that year.

On rare occasions, they might be heard to utter a single note, which Nansen thought resembled the cry of a wryneck (*Iynx*). They were generally silent.

They were not shot, as they were too small to serve as food.

Larus glaucus, Fabr. 1780.

On the drifting ice itself, only occasionally observed, but numerous near the land, from Hvidtenland southwards to Cape Flora.

On June 1st, 1895, the cry of a large gull was heard above the tent, and supposed to have been that of this species¹. This was in about 82° 20' N. Lat.

Subsequently one was seen now and again flying above the lanes; but only in the neighbourhood of land did they begin to be numerous.

A nesting-place was found on the 16th August, on the north side of Torup Island (Coburg Islands). The colony was not very numerous. The nests lay on the ledges along the lower part of the cliff, and generally contained two half-grown young ones² (81° 33' N. Lat.).

All along the NW coast of Franz Josef Land, *L. glaucus* was numerous; but no other nesting-place than the one on Torup Island was seen. At about the end of August, the young birds of the year began to appear; and all through the autumn, old and young birds might be seen (together with *P.*

¹ In 'Farthest North', this species is wrongly called in several places *Larus argentatus* (Vol. II, pp. 206, 230 & 238).

² In 'Farthest North', this species has been wrongly translated as 'the black-backed gull' (Vol. II, p. 308). In the Norwegian edition, 'Fram over Polhavet' (Vol. II, p. 212), a photograph is given of the cliff with the breeding gulls.

eburnea) wherever any refuse blubber¹ was to be found, or a walrus or a bear had been cut up. They were very troublesome, making it necessary to cover up carefully all stores of blubber and meat with skins and stones, otherwise all blubber would soon have been pecked away by them.

Even towards the end of September, when the winter hut had been built, they were quite common, and, like the ivory gull, they almost every day and night alighted on the roof of the hut itself, to eat the remains of blubber still adhering to the walrus-skins covering it, and they were not a little troublesome with their persistent tapping on the frozen skins all night long. About the middle of October, when everything for miles round was covered with ice, some few young glaucous gulls still remained, daily visiting the roof of the hut, or the frozen bear-skins lying near it; and they were the last birds seen from the hut that year.

After the winter was past, the first specimens were seen at the hut on the 9th April, 1896 (*P. eburnea* and *Fulmarus* both having appeared considerably earlier), and soon began once more to visit the roof of the hut, as they had done in the autumn. During the journey south, they were seen frequently, right down to Cape Flora, though not in such abundance as either *Fulmarus* or *Pagophila*.

Pagophila eburnea, (Phipps) 1774.

This bird was observed in large numbers all through the sledge-journey after May, 1895. With its impertinent ways, and shrill, angry cry or scream, it was, in spite of its beauty, anything but a welcome companion. Like the 'carrion-birds in the desert, the same individuals often seemed to follow the travellers for a long time. They grew continually bolder, and at last were so tame that they ventured right into the tent to steal blubber.

As an example of their boldness, the following incident may be mentioned. One day (August 15th, 1895), when Nansen was asleep, lying on the ice with his head close to the side of his kayak, which was standing on the sledge, he was awakened by hearing a tapping close to his ear, and raising his head, saw an ivory gull pecking eagerly at a piece of blubber

¹ *L. glaucus*, as well as *Pagophila eburnea*, very much prefers the blubber to the flesh, in this respect resembling the bear, while the fox "prefers the flesh.

lying on the deck of the kayak, only a foot or two from his head. The bird looked at him, but by a quick motion he caught it in his hand, grasping it over the back. It screamed, pecked at his fingers, and tried to get free, which it also succeeded in doing, but with the loss of its tail feathers, which remained in Nansen's hand. The bird flew away, as well as it could without a tail, but alighted on the ice only a hundred yards off. After a while it again approached, evidently on the look-out for some new opportunity of getting at the blubber.

Nansen has observed these birds following the bears, often with loud screams, especially where seals have been seen in the neighbourhood, and there is a prospect of any being killed. He has also frequently noticed them, hovering over himself, as it seemed with special interest, while he was stalking a bear, a seal, or a walrus. On such occasions they are less welcome than usual, as they may easily warn the stalked animal by their screams.

When an animal was killed and skinned, it was often astonishing to see how quickly flocks of these birds would be on the spot, even when they had not been observed for a long while previously. Suddenly their shrill, angry cry, resembling that of a tern, would be heard high in the air. This cry may at first come only from a single bird that has chanced to pass near the spot, whose quick, keen eyes have at once discovered the prey. The cry, however, will call others, and soon ten or twenty of them may have gathered, making a most disagreeable noise.

At the winter hut, Nansen also often had an opportunity of observing how a bird might chance to pass, and discover a place where, for instance, a bear had been cut open and skinned, or where pieces of blubber, meat, etc. had been left. After having examined the place, and perhaps eaten some of the blubber, it would again fly away eastward. But almost invariably it would then happen that after a while cries were heard in the air, and a flock of from five to ten ivory gulls came flying from the east, and without hesitation came directly to the place where food had been found. Nansen often recognized the very same birds. One young bird in particular, which was easy to recognize by some special black spots on one wing, was very often to be seen in these flocks.

On May 31st (1895), the first pair was seen during the sledge-journey, and two others were heard or seen the same day (about 82° 20' N. Lat.).

On June 4th several were seen, and from that time they were seen almost daily. On June 4th, one specimen was shot and eaten — the first bird that was brought down on the sledge-journey. As it was shot, it dropped out of its mouth a large piece of blubber which it had probably taken from some seal killed by a bear. On June 7th, another couple of these birds were shot for food, but subsequently only a single one now and again was shot (as food for the dogs), as they were too small to give sufficient food for the value of a cartridge.

On Hvidtenland, on the 7th August, many of them were seen sitting on the edge of the glacier, and subsequently they were numerous along the NW coast of Franz Josef Land. At the winter hut, during the autumn, there were great numbers of them. They were chiefly old birds. Young birds were not seen before the beginning of September, and even then they were comparatively few. This fact may, however, indicate that there has been some nesting-place within no great distance; but none was seen. They continued to appear at the winter hut until the beginning of October, when all water had long been frozen over. Like *L. glaucus*, they daily perched upon the roof of the hut to peck at the blubber, often in great numbers, and it was very difficult to protect the stores against their attacks. When the travellers were inside the hut, they could easily distinguish the quick pecking of the ivory gulls from the slower, but stronger tapping of *L. glaucus*.

After the winter the first were seen as early as March 12th, 1896, when five came flying from the SE and perched on the cliff west of the hut. On April 5th, some more appeared, although no open water was to be seen in any direction. On that day, the first gull also paid a visit to the hut, but at first they were not so bold as they had been in the autumn, and it was some time before they acquired the same audacity. It could be seen by the track in the snow, that this first bird had alighted on the ground near the hut, and had walked a short distance without daring to approach the bear-skins and stores lying close to the hut. On April 9th, many ivory gulls were seen, and it was now not long before they regularly visited the roof of the hut, and the stores outside it, as they had done in the autumn, though not now in quite such large numbers.

They were seen frequently on the journey south towards Cape Flora, though never in great abundance. During the long journey over the ice

between Cape Richthofen and Cape Barents (Northbrook Island), they were seen occasionally, and *P. eburnea* seems to be less connected with open water than the kittiwake, which on the whole is seldom seen away from it.

Although *P. eburnea* often appeared simultaneously with *L. glaucus*, each species differed in several respects. When a pair of *L. glaucus* were going to swoop down upon a skinned seal or walrus, they first circled majestically above it, and then dropped down, and settled at a little distance, sitting there contemplatively for some little while, before they finally walked towards their booty. Here the smaller *P. eburnea*, which were already busy over their meal, would respectfully make way for them. *P. eburnea*, uttering its shrill, angry cry, darts like an arrow upon its prey. If a walrus or a bear were being skinned, they were instantly on the spot, and often pecked at the blubber 'almost under the very knife itself'.

Stercorarius crepidatus, (Banks) 1773.

During the journey along the north-west coast of Franz Josef Land, *St. crepidatus* was not uncommon, and it was observed almost daily during the kayak-voyage, nearly always together with *Rissa tridactyla*, which were the objects of their almost incessant attacks. At Cape Hugh Mill (81° 18' N. Lat.), where the travellers were encamped on the 25th and 26th August, 1895, the frightened cry of the kittiwakes was heard all night long, as they were chased by skuas trying to make them relinquish the booty they had captured.

At the winter hut, during the latter part of August and the beginning of September, Nansen had a good opportunity of studying their ways. From a long distance, a skua, with its sharp eyes, would at once observe if one bird in a whole flock of kittiwakes made a catch — possibly a small fish or a crustacean — worth its efforts. The skua would then silently make straight for the poor bird, not missing it even amongst a score of other kittiwakes. Darting down like an arrow, the skua would now chase the kittiwake, which would utter the most pitiful cries of distress. The wild chase would be continued until the latter had to disgorge its booty, which it had long since swallowed, when the skua would dart down, and catch the falling food before it reached the water. It very often happened, however, that the kittiwake, un-

willing to give up its prey, was so hard pressed, that in its distress it would sit down on the flat ice, where the skua never attacked it; but though leaving it alone, it would always alight on the ice some distance off, and there wait patiently. After a while, the kittiwake, thinking itself safe, would fly away. The skua, following it with its eyes, would remain quiet, and allow it to fly some distance undisturbed; but it would then suddenly fly straight at the bird once more, and the wild chase would begin anew, until the kittiwake had at last to pay its tribute. Indeed, it even happened that this manœuvre was repeated twice. It seemed an almost ridiculous waste of energy, for it would apparently require far less effort to catch another crustacean on the surface of the sea where there were plenty of them; but Nansen never observed a skua catching anything in the water. Even if the booty dropped by the kittiwake, fell into the water or on to the ice, before the skua could catch it — which, however, very seldom happened —, the skua would often fly away without making any further effort to capture it.

As a rule, the skuas observed were light-bellied.

They were still seen daily in the neighbourhood of the winter hut during the early days of September, chasing the kittiwakes. They seemed to have their haunt by a little pond, some distance to the east of the hut, where they had possibly had a nesting-place. They disappeared with *Rissa tridactyla*, when the water froze over towards the middle of September.

In the spring (1896), they had not yet appeared at the winter hut when the travellers left it on May 19th.

They were frequently observed at Cape Flora, especially near a little pond to the north-west of Elmwood, where a pair evidently had a nest. Several nests of this skua were found about Cape Flora by the men of the Jackson-Harmsworth Expedition¹.

During the homeward voyage in the 'Windward', several skuas belonging to this species were seen in the Barents Sea, especially along the edge of the ice, *e. g.* on August 9th (1896). The light-bellied, as well as the dark-coloured variety, was observed.

¹ Clarke and Bruce, 'On the Avifauna of Franz Josef Land' (*The Ibis*, April, 1898, p. 269). Also 'The Mammalia and Birds of Franz Josef Land' (*Proceedings of the Royal Physical Soc. of Edinburgh*, vol. XIV, 1899, p. 104).

Stercorarius longicaudus, (Vieill.) 1819.

During the sledge-journey over the ice north-east of Hvidtenland, in 81° 45' N. Lat., on July 30th, 1895, a skua was seen three times, which Nansen expressly states in his diary belonged to this species. The ice had just then begun to open up a good deal, and birds were seen more frequently.

This species was not observed on Franz Josef Land. During the homeward voyage in the 'Windward', a few specimens were seen in the open Barents Sea (near the edge of the ice), on August 9th, 1896.

Fulmarus glacialis, (Lin.) 1766.

This bird and *P. eburnea* were the two most frequently observed on the ice itself during the sledge-journey north of Franz Josef Land. The first bird observed in the spring of 1895 was a fulmar, which flew over the tent and the dogs on May 29th (82° 26' N. Lat.).

The same day another specimen was seen. The ice was now to some extent broken up, and lanes were beginning to form.

The next fulmar was seen on May 30th, and from the middle of June they were seen very frequently (about 82° 10' N. Lat.). They were also seen all through July, when Nansen and Johansen came nearer to Hvidtenland; but they did not seem to be especially numerous on the north or north-east side of Franz Josef Land, and no nesting-place could be found there.

A couple of these birds were shot on June 18th, 1895, and eaten. The travellers were then afraid of running short of food. In order to catch some of them to feed the dogs with, without expending cartridges, hooks were manufactured out of tins, to which were fastened pieces of meat, but without success. *P. eburnea* always managed to peck off the meat without swallowing the hooks, and the fulmars take their food almost exclusively from the surface of the water; indeed, they scarcely ever rest upon the ice, possibly because it is difficult for them to fly up. During the latter part of July and the first few days of August, 1895, one or two were often shot daily for the dogs, which at first refused to touch the strong-smelling bird, but gradually learnt to do so when food was very scarce.

They were seen near the winter hut until late in September, when all water was frozen over.

The first that appeared after the winter came as early as April 5th (1896), although there was no open water visible anywhere. On April 9th, many were seen. They afterwards appeared frequently, flying about over the ice outside the hut, and along the basaltic cliffs, though with what object it was impossible to discover, as they were never seen to settle, and the water was not yet open, nor were there any lanes in the ice. On April 29th, 1896, Nansen says in his diary: "Mollies are seen here constantly flying about, but I cannot make out why they come in here".

They were also observed frequently during the journey south from the hut. On June 3rd, they were found in large numbers established on the basaltic crags just east of the high, perpendicular, basaltic cliff of Cape Fisher (81° N. Lat.), the only nesting-place that was found during the journey. The rock here was not very precipitous, but had sloping terraces. On the high, precipitous cliff close by, there was a numerous colony of *Uria lomvia*.

At Cape Flora they were seen frequently in the course of the summer, but did not seem to nest nearer to that station than on Mabel Island¹.

During the homeward voyage in the 'Windward', some few fulmars were seen in the ice, August 8th, 1896; and along the edge of the ice, in the open Barents Sea, they were rather numerous on August 9th and 10th.

Most of the specimens belonged to the dark variety; only a few belonging to a lighter form were seen. The same also seemed to be the case farther north, on Franz Josef Land, and during the journey over the ice.

Cephus mandti, Licht. 1822.

On May 29th, 1895, when the ice had become rather broken up, the first birds of the year made their appearance during the sledge-journey, namely, a pair of *Fulmarus* and a *Cephus mandti*. The latter, which was already in full summer plumage, flew several times round the travellers, and disappeared, probably in one of the lanes which were just forming (82° 26' N. Lat.).

¹ Cf. Clarke and Bruce, *The Ibis*, 1898, p. 275.

Black (Spitsbergen) guillemots were subsequently seen now and then, mostly singly, in June, July, and the beginning of August, 1895, on the ice north of Hvidtenland, and on the north-east side of Franz Josef Land. Along the coasts of the latter they were very common, and small colonies of them were seen breeding along with much more numerous colonies of little auks, on Torup Island, at Cape Felder, Cape Helland, Cape Hugh Mill, on the cliffs east and west of the winter hut (Cape Norway), on the small island Steinen, west of the winter hut, etc.¹

The dovekie, or black guillemot, was seen as late as towards the end of September, 1895, at the winter hut.

After the winter, a couple of *C. mandti* were observed as early as March 10th (1896). These birds (as also the little auks) could scarcely have passed the winter at any great distance to the south. They were then already in summer plumage.

They afterwards appeared frequently at the winter hut, as a rule in company with little auks, one or more of them generally accompanying each large flock of those birds, when they flew to or from the sea; but they were never numerous. They could be seen inhabiting the cliffs above the winter hut along with little auks, the latter, however, where they were found together, being always much the more numerous.

During the sledge-journey southwards, the dovekie was found inhabiting the cliffs at Cape M'Clintock, together with numbers of little auks, on May 23rd, 1886. It was too early to find eggs. There also seemed to be colonies of them at Cape Richthofen.

At Cape Flora, *C. mandti* was comparatively numerous. Some specimens were seen on the voyage out through the ice to the south of Franz Josef Land, on August 8th, 1896.

Uria lomvia, (Pall.) 1811.

During the whole sledge-journey in 1895, only three specimens of this species were seen. On June 18th, (1895), one was shot (together with a

¹ According to Payer's description, the black guillemot also breeds on Crown Prince Rudolf Land — Cape Auk — where he saw it in April, 1874. (Payer, 'Oesterreich-Ungarische Nordpol-Expedition 1872—1874', p. 325. Vienna, 1876). Nansen thinks there are colonies of them at several places on this island, e. g. at Cape Brorok.

pair of fulmars) for food. The next day another was shot ($82^{\circ} 15' N. Lat.$); but after that, only a single one was observed flying southwards over the camp, on August 11th, half-way between Hvidtenland and Franz Josef Land. All through the journey south along the NE side of Karl Alexander Land, and up to the winter spent on Frederick Jackson Island, not a single specimen was seen.

The apparent total absence of these birds in the northern part of Franz Josef Land aroused Nansen's attention, as Payer, in the report of the Tegethoff Expedition and the sledge-journey to the most northerly limits of Franz Josef Land, mentions finding "*Alken, Tauchern und Teisten*"¹ — in the English edition wrongly translated "auks and divers"² — in great numbers at Cape Auk in Crown Prince Rudolf Land. One reason why Nansen did not believe he was near Crown Prince Rudolf Land was just that he found none of those guillemots which were said to be found there in thousands. It is therefore probable that the word "*Alken*" ("auks") has by some mistake come into Payer's description, and that he has meant nothing but little auks and black guillemots or dovebies (*Teist*); and it is not improbable that *Uria lomvia* really has no nesting-place on this northern part of the group of islands.

They were never observed at the winter hut (Frederick Jackson Island), either in 1895 or 1896. During the journey south, they were seen for the first time south of Cape M'Clintock and Mary Elizabeth Island, in the early days of June; and on June 3rd (1896), a numerous colony of them was seen a few kilometres farther south at Cape Fisher, in $81^{\circ} N. Lat.$ It is possible that this is their most northerly nesting-place on Franz Josef Land. Cape Fisher is a basalt cliff almost 900 feet high, rising perpendicularly out of the sea; and here there were thousands of *Uria lomvia* living, and flocks were incessantly flying to and from the open water, which was only a kilometre or two off. There seemed to have been open water right up to the

¹ "Wir fanden jetzt alle Felswander des Kronprinz Rudolphs Landes mit Tausenden von Alken, Tauchern und Teisten besetzt. Ungeheunere Schwarme erheben sich, und alles Land, auf das die Sonne schien [April, 1874, $81^{\circ} 44' N. Lat.$], belebte das leidenschaftlichen Schwirme der beginnenden Brutzeit". Payer, 'Oesterreich-Ungarische Nordpol-Expedition 1872—1874', p. 325. Vienna, 1876.

² Payer, 'New Lands within the Arctic Circle', vol. II, p. 154. London, 1876. The right translation should evidently have been: "guillemots, little auks, and dovebies", cf. *ibid.* vol. II, p. 91.

cliff only a short time before, and this is evidently the rule here all the year round.

South of Cape Fisher, there seem to be several nesting-places, and these guillomots were observed along the coast wherever there was open water. They appeared, for instance, to be breeding at Cape Richthofen ($80^{\circ} 50'$ N. Lat.); and some kilometres north of this promontory, a cliff was seen which also seemed to be inhabited by them. Along the south coast of Northbrook Island, great numbers of them were seen, and they were here much more numerous than *Alle*.

Lastly they were found (as already mentioned by Clarke and Bruce) in great numbers, breeding, at Cape Flora and other promontories on Northbrook Island and the adjacent islands; and during the travellers' stay at Elmwood during the latter part of June and beginning of July, 1896, quantities of eggs were collected by Jackson, and many birds shot for food.¹

A few were also seen in the ice in the northern part of the Barents Sea, on August 8th, 1896, apparently belonging to the brooding tribe on Franz Josef Land.

Alle alle, (Lin.) 1766.

This species was one of the first that appeared far north in the ice during the sledge-journey, and it soon became one of the most numerous there.

The first was seen on June 9th (1895), when there were a good many lanes in the ice (about $82^{\circ} 20'$ N. Lat.). After the 18th June, when the west wind began to blow, and open the ice somewhat, they suddenly appeared in great numbers. On June 19th and 20th, great numbers were seen in the lanes, where they flew to and fro in search of food, diving just outside the tent-door.

From that time they appeared almost daily, always coming from the south, and returning towards the south. They generally kept in pairs, or three or four together, and used to lie in the lanes from six to eight hours a day, but were afterwards invisible. Their visits also depended upon the

¹ Clarke and Bruce, *The Ibis*, April, 1898, p. 271.

condition of the ice. If the ice were open, they were numerous; if it were closed up, none were seen.

Off Hvidtenland they were not seen, on the whole, in very great numbers; and on these glacier-covered islands, there are no places for a colony. The first colony seen during the journey, was on the east and north sides of Torup Island (Coburg Islands), on August 16th. They were here nesting on the cliffs, above *Larus glaucus*. The number of birds in this colony amounted to thousands (81° 33' N. Lat.).

This is certainly not the most northerly colony on Franz Josef Land. Nansen saw many basaltic cliffs on Crown Prince Rudolf Land, which would evidently afford good nesting-places for them, *e. g.* Cape Brorok. As referred to above (p. 38), Payer mentions in his report of the Austro-Hungarian North Pole Expedition of 1872—1874, that in April, 1873, he found thousands of "Alken, Tauchern und Teisten" on the cliffs in Crown Prince Rudolf Land, in 81° 44' N. Lat. ('Cape Auk')¹. It is probable that this means principally *Alle alle* (probably also a small number of *Cephus mandti*).

During the journey south along the north-west coast of Franz Josef Land, colonies were found established on almost every cliff that could afford them a nesting-place. They were found, for instance (besides on Torup Island), in great numbers on Cape Felder, where, on August 16th, they had young ones scarcely ready to fly; on Cape Helland on August 18th (81° 24' N. Lat.), and in several places on Frederick Jackson Island, Cape Hugh Mill, the cliffs above, west, and east of the winter hut, on Steinen, west of the winter hut, and in the fjord farther in.

Next they were found (on May 23rd, 1896) on Cape M'Clintock, and (on June 6th, 1896) on Cape Richthofen. Cape Fisher, on the other hand, appears to be inhabited exclusively, or almost exclusively, by *Uria lomvia* (and *Fulmarus glacialis*).

South of the last-named promontory, the birds did not seem to occur in such large numbers; but, as already mentioned by Clarke and Bruce², they have settlements on Cape Flora and in several places in the southernmost parts of the group of islands.

¹ Payer, 'Die österreich-ungarische Nordpol-Expedition 1872—1874', p. 325. Vienna, 1876.

² The Ibis, 1898, p. 272.

Alle alle seems, on the whole, to reign almost supreme among the *Alcidæ* on the north-west coast of Franz Josef Land, but always together with a minority of *C. mandti*; and only south of Cape Fisher, in 81° N. Lat., did *Uria lomvia* become the more numerous of the two.

At the winter hut, they were seen for the last time in the autumn (1895), towards the end of September. After the winter, they had already made their appearance by February 25th (1896), and must thus have spent the winter not very far away to the south. In the afternoon of the above-mentioned day, first a flock, about ten in number, was seen coming from the inner part of the fjord, and flying close past the hut, along the cliffs westwards; and a little later, a flock of four came the same way. Later in the afternoon their cheerful twittering was heard again, and then they were evidently perched on the cliffs above the hut, but it was too dark to see them. The sea was still covered with ice as far as the eye could see, and the sun could not appear above the horizon until the following day. They may possibly have been on the cliff previously, without having been observed on account of the darkness.

In the beginning of March they were seen very frequently. At some part of the day, the cliff above the hut was full of them; at other times they were totally absent, having evidently gone out to the sea. Their flight to and from the cliff above the hut, and the nest-rocks farther up the fjord, seemed to be very regular in the beginning of March. Immense flocks of thousands upon thousands of them came often flying in early in the morning from the sea across the ice-covered fjord to their resting-places (nest-rocks) on the cliffs, although the distance from the open sea to the hut was at least forty kilometres, and much more to the cliffs farther up the fjords. In the afternoon, at about 2 o'clock, they would once more set off toward the sea, the flight often lasting until late in the afternoon. They often flew very high, when the air would be quite filled with the flying legions. And they seemed to steer direct west, or on some days more north-west, where the dark sky indicated that there was open sea in the distance, which was possibly seen by them from their heights; they always seemed to have a distinct object, for which they made a straight course without any uncertainty.

They fly with great velocity, and the flocks close together. They make a strange whistling or vibrating sound when they fly, probably with their wings, recalling somewhat the sound of a flying snipe in the spring. This sound is so loud, that a flock could be easily heard, even when it was so high that it was difficult to see it.

Nansen has the following remarks about them in his diary:

March 4th, at 10 A. M. The cliff above the hut was full of little auks, and they flew about, twittering, from one projecting ledge to another, and also sat on the surface of the glacier. When we again came out between 3 and 6 P. M., they had disappeared.

March 5th and 6th. No little auks were seen while the travellers were out taking a walk in the afternoon.

March 7th, at about 7 P. M. Two flocks of little auks were seen flying up the fjord, and two flocks were flying out towards the sea, or northward along the coast.

March 8th, at 9 A. M. Ten flocks of little auks were seen by Johansen while he was out, flying in from the sea.

March 10th, at 6 A. M. Johansen saw what he estimated to be millions of little auks flying up the fjord from the sea. There was an incessant succession of immense flocks, one after another. "At 2 P. M. when we came out, there was an incessant flight of flock after flock out towards the sea, and this continued until late in the afternoon. Two black guillemots were also seen."

March 11th, 3 to 7 P. M. No birds were observed.

March 12th, 10 A. M. The cliff above the hut full of little auks; many flocks were seen passing on their way out towards the sea.

March 16th, 4 to 7 P. M. The cliff above the hut full of little auks.

Farther on in the spring, after the middle of March, the flight was less regular. They would then appear later in the day, and stay longer on the cliffs. Their nesting-time had not commenced when Nansen and Johansen left the winter hut on May 19th (1896).

The arctic foxes, which had paid daily visits to the hut all through the winter, and had had the audacity to make regular excursions to the roof to take the meat that was stored there, and from which they could hardly be

driven away, entirely disappeared when the little auks began to make their appearance on the cliffs.

On August 9th, the travellers saw the last of these birds. They were six in number, sitting on the last ice-floe passed, on the edge of the open water in the Barents Sea, south of Franz Josef Land.



IV.

THE LAST TWO SUMMERS IN THE ICE. NORTH-EAST OF FRANZ JOSEF LAND, 1895; NORTH OF SPITSBERGEN, 1896.

Plectrophenax nivalis, (Lin.) 1766.

During the summer of 1895, north-east of Franz Josef Land, the 'Fram' was visited by snow-buntings only four times.

The first appeared on May 22nd. It fluttered around the ship, twittering, for some time, and then flew off towards the north ($84^{\circ} 40'$ N. Lat).

On June 10th, two more appeared near the ship, and on the day following, one. On June 19th, one more was seen, but after that, no others were seen that year. The most northerly specimen was the one observed on June 11th ($84^{\circ} 45'$ N. Lat., $83^{\circ} 5'$ E. Long.).

In the summer of 1896, when the ship was north of Spitsbergen, the first bird of the year, a snow-bunting, was seen on April 25th. It settled upon the deck, was fed with meal, and became quite tame. It remained there a few days, disappearing on April 28th ($84^{\circ} 17'$ N. Lat.).

On May 3rd, another of these birds settled near the ship. On the 6th, two came; but the dogs would not leave them alone, and they soon took their departure.

On May 25th, three made their appearance at one time. These three remained near the ship until far on into June, finding their food in the refuse-heaps. They were also often seen by the water-hole, where they appeared to be looking for crustaceans.

Two of the three specimens were males, the third a female. The males soon began to fight with one another, and on June 9th, one departed. The two birds left behind appeared to pair, and began to show signs of wishing to build; they chased one another as if in play, and were seen flying off with bits of straw, and scraps of wood-wool in their beaks. But as the ship shortly after began to move southwards, and the snow-buntings remained by the refuse-heaps, there was no opportunity of ascertaining whether any nest was actually built. The ship, at that time, was in about 83° N. Lat., or about 230 kilometres from the northern point of Spitsbergen.

Aegialitis hiaticula, (Lin.) 1766.

On June 13th, 1896, two specimens of this species were shot north of Spitsbergen, in 82° 59' N. Lat. Both specimens are now preserved (the one as a skeleton) in the Christiania Museum.

a. Wing, 120 mm.; tail, 60 mm.

b. Wing, 124 mm.; tail, 56 mm.

They were both in usual summer plumage.

The appearance of this species in the ice far above Spitsbergen, is not without interest, as hitherto only a few scattered individuals have been observed upon these islands, and there is no certain knowledge of its having been found breeding there.

Crymophilus fulicarius, (Lin.) 1766.

Was observed two or three times during the summer of 1896, in the ice to the north of Spitsbergen.

On June 10th, two specimens were shot (by Juell) in one shot, in 83° 1' N. Lat., thus about 250 kilometres north of Spitsbergen. The weather that day was calm and clear, and the wind had been NW for some days.

On the day following, four more small waders were seen, supposed to have belonged to this species. The ship was then a few kilometres farther south.¹

¹ On June 11th, a wader was seen (by Mogstad) flying past the ship. It resembled the above-named species, but seemed to be considerably larger.

The two specimens shot were both preserved, and are now in the Zoological Museum in Christiania. They appear to have been male and female, and to have been a pair. The one that is probably the female, is larger and more brightly coloured than the other; the whole of the under surface of the body is bright red, without any lighter feathers. The upper surface of the head is of a uniform black, the sides of the head and the broad band towards the nape pure white.

The colours of the male are not so pure. The feathers on the middle of the belly are whitish, the crown has red-edged feathers, and the eye region is of a dull white colour.

a. Wing, 136 mm.; tail, 67 mm.

b. Wing, 130 mm.; tail, 63 mm.

Somateria mollissima, (Lin.) 1766.

On June 19th, 1896, two eider ducks were shot north of Spitsbergen ($82^{\circ} 55'$ N. Lat.). They were male and female; they came flying up from the south, and settled in one of the channels in the ice. The ice that day was pretty closely packed. Both specimens were old and full-coloured.

No other specimens were seen in the ice.

Sterna macrura, Naum. 1819.

A single tern was observed during the summer of 1895 (June 21st), when the 'Fram' was in $84^{\circ} 32'$ N. Lat., $80^{\circ} 30'$ E. Long. It came so close to the ship, that Sverdrup was able to send a shot after it. As previously mentioned (p. 25), Nansen saw a pair of these birds in the beginning of August of the same year, somewhat farther south (north of Hvidtenland).

Similarly, north of Spitsbergen, a single specimen was seen on June 9th, 1896, in $83^{\circ} 1'$ N. Lat. Neither this species, nor *Larus glaucus*, seemed to frequent the open channels north of these large islands where they breed.

Larus glaucus, Fabr. 1780.

This species was not observed with certainty from the 'Fram' during the summer of 1895, north-east of Franz Josef Land. On June 12th, a large

gull was seen and shot at by one of the crew; but it could not be recognised with certainty ($84^{\circ} 48'$ N. Lat.).

Nor did this species appear in any great numbers during the summer of 1896, in the ice north of Spitsbergen; single specimens were observed only two or three times. One was observed on May 13th, flying over the channels ($83^{\circ} 51'$ N. Lat.). This and a pair of *Pagophila eburnea* were the first sea-birds that appeared that year.

A single specimen was seen on June 9th, and lastly one on July 31st, when the 'Fram' had already begun to approach the northern shores of Spitsbergen.

? Larus marinus, Lin. 1766.

On June 30th, 1895, in the ice north-east of Franz Josef Land, a black-backed gull was seen by two of the crew when on a hunting expedition. Mogstad was near enough to it to send a shot after it, and in doing so, distinctly saw its black back. In his journal, he calls it "Svartbag" (the Norwegian name for *Larus marinus*).

After the shot had been fired, the bird settled by a little channel to the west of the ship; but when, shortly after, a fulmar was shot from the same spot, the gull flew away. This was in $84^{\circ} 35'$ N. Lat., $75^{\circ} 0'$ E. Long.

Rissa tridactyla, (Lin.) 1766.

During the summer of 1895, only a few solitary kittiwakes were observed in the ice in the middle of June, north-east of Franz Josef Land. The first was seen on June 10th. On June 16th, two more were seen, and one of them was shot from the deck by Dr. Blessing. A fulmar was shot on the same day ($84^{\circ} 52'$ N. Lat.). This is the most northerly latitude in which birds are hitherto known to have been shot.

Lastly, a single specimen was seen on June 19th.

The contents of the stomach in those specimens where they were examined, were, as a rule, crustaceans. In one individual, a specimen of a *Gadus saida* was found, about 70 mm. in length.¹

¹ *Gadus saida*, Lep. 1773. This species was only once observed in the ice itself during the expedition. On July 16th, 1895, in $84^{\circ} 42'$ N. Lat., Dr. Blessing, when on an excursion

Above Spitsbergen they were more numerous, though few in comparison with the ivory gull.

On May 26th, small flocks of six were seen two or three times hovering over the channels in the ice, the first observed that year. On May 30th, some specimens were again seen ($83^{\circ} 50'$ N. Lat.).

After this they were seen frequently, and several specimens, all old and full-coloured, were shot.

Rhodostethia rosea, (Macg.) 1824.

The roseate gull was also seen from the 'Fram' in the summer of 1895, but in a higher latitude than Nansen and Johansen had found it (p. 26).

The first specimen was observed by Mogstad on July 18th, when the ship was in $84^{\circ} 41'$ N. Lat., $74^{\circ} 30'$ E. Long. On July 19th, another was seen by Mogstad and Sverdrup together, when they were out seal-hunting. The bird flew within 15 or 20 paces of them. Both specimens were fully coloured, and all the characteristic marks of the species were observed.

The next specimen was seen on July 22nd, by Scott-Hansen ($84^{\circ} 36'$ N. Lat.); and lastly, single specimens were seen on the 4th, 9th and 11th August, one of them being shot at by Mogstad, but without success. The last specimen was seen by Blessing during a *ski*-expedition on August 16th ($84^{\circ} 27'$).

Thus altogether seven specimens were observed that year between the middle of July and the middle of August, all fully coloured. Young birds were not observed with certainty.

The species was not observed north of Spitsbergen during the last summer (1896).

Xema sabini, (Sab.) 1818.

A gull with a black head was observed by Mogstad one day in July, 1896, in about 83° N. Lat., when the 'Fram', with steam up, had begun to

to collect *algæ*, saw a specimen of a *Gadus* lying motionless in front of a projecting piece of ice in a channel; but it disappeared under the ice like lightning when he attempted to come near it. Its length was about 120 mm. No other fish has hitherto been observed so far north as this. This species is known to Norwegian sealers by the name of "Is-Mort", Mort being the general name for the young of various species of *Gadus*.

force her way out of the ice above Spitsbergen; but in the hard work of those days, no note was made of the date. The observation was communicated to others of the crew, and its authenticity is beyond doubt.

Pagophila eburnea, (Phipps) 1774.

This species was seen almost up to 85° N. Lat.

On May 14th, 1895, in 84° 38', a bird, supposed to have been a *P. eburnea*, was seen flying from the north-north-east towards the south. This was the first bird that appeared in the spring of that year. The first undoubted specimen was seen on the 2nd June (in the same latitude) by Scott-Hansen. In the course of the summer they were seen singly several times, and altogether three specimens were shot in the beginning of July. But they did not appear to frequent this part of the ice in any great numbers.

The last specimens, two together, were noted on the 10th July.

In the summer of 1896, north of Spitsbergen, the first two specimens were seen flying above the ice-channels on May 13th (83° 50' N. Lat.).

By degrees they became exceedingly numerous, and after the middle of June, they were seen daily, sometimes in small flocks. They were always to be found at the refuse-heaps, or by the bears' carcasses, and a number of specimens were shot in the course of the summer; in and about the beginning of August alone, forty-one were shot, fourteen of them upon one day (July 29).

? *Stercorarius longicaudus*, (Vieill.) 1819.

During the summer of 1895, skuas were only seen in the ice to the north-east of Franz Josef Land, on one occasion, namely, the 4th September. On that day four or five specimens were observed, and one of them was shot at, but without result (84° 47' N. Lat., 77° 17' E. Long.). Scott-Hansen, who came fairly close to them, took them to be *St. longicaudus*, on account of the "very long tail-feathers".

These specimens were the last birds observed that year.

North of Spitsbergen, the species was not observed with certainty. On June 10th, Scott-Hansen saw in the distance two skuas flying over the ship in a north-north-westerly direction, and thought they must belong to one of the smaller species.

Stercorarius pomatorhinus, (Temm.) 1815.

This species was observed repeatedly in the middle of June, 1896, in the ice north of Spitsbergen, as a rule in small flocks of from three to six birds, but once in a large flock of nearly twenty. Two specimens were shot, and minutely described in Dr. Blessing's journal.

As early as June 13th, a skua was seen that had "a forked tail", and was probably a young bird of this species.

On June 19th (82° 57' N. Lat.), four appeared together, and one of them was shot by Mogstad. The length of the wing is stated by Dr. Blessing to have been 340 mm.; the middle tail-feathers extended 60 mm. beyond the others.

On June 21st (82° 53' N. Lat.), a straggling flock of about sixteen birds, all of the same species, was seen, and one of them was shot by Capt. Sverdrup.

Both the specimens shot were old birds, and fully coloured.

It is, on the whole, surprising to find this species comparatively numerous in the ice far to the north of Spitsbergen. It has hitherto only been known as a sporadic visitant of Spitsbergen.

Fulmarus glacialis, (Lin.) 1766.

The first fulmar in 1895, north-east of Franz Josef Land, appeared on the 30th May. Subsequently they were seen now and again, singly or two together, but scarcely more than twenty specimens in all in the course of the summer. Six of these were shot, all in a latitude above 84° 30' N. One of them was shot by Blessing on June 16th. Before it died, it vomited the contents of its stomach, which proved to be the jaws and portions of the body of a cephalopod (84° 52' N. Lat.). In other specimens, only crustaceans were found.

The last *Fulmarus glacialis* of this year was seen on September 14th, and was the last bird observed that autumn. On that day, the 'Fram' was in 85° 5' N. Lat., 79° 0' E. Long., and this is the highest latitude in which birds have ever been known to be observed.

This specimen is thus spoken of in Sverdrup's journal:

"14th September, 1895. *Bentsen saa iaftes en Havhest, som kredede om Skibet en liden Stund, og trak derpaa vestover, efter Raakene*".¹

Fulmars appeared in far greater numbers in the summer of 1896, in the ice north of Spitsbergen. The first was seen there on May 22nd (83° 45' N. Lat.). They were afterwards seen all through the summer, singly or in small flocks, circling above the channels, and occasionally picking up little animals or refuse from the surface of the water. From the middle of June until the beginning of August, when the ship forced her way out of the ice, about seventy specimens were shot by the crew, fifteen of them in one day (July 16th; 83° 14' N. Lat.). They were principally utilised as food for the dogs.

Cephus mandti, (Licht.) 1822.

The Spitsbergen guillemot was one of the birds that was observed comparatively often during the summer of 1895, north-east of Franz Josef Land. They were generally seen, however, only singly or a few together; on the 29th May, four were observed at one time, and two of them were shot (84° 32' N. Lat.). Altogether a dozen of this species were shot that summer, all in a latitude higher than 84° N. The ship was then at least 330 kilometres north-east of Franz Josef Land.

This guillemot, which (like the continental form, *Cephus grylle*)¹ finds its food principally among the littoral fish-species, thus leads here also, in these high northern latitudes, and at a distance of several hundred kilometres from the nearest mainland or island, a kind of littoral life in the channels, or among the floating pieces of ice; and it is probably *Gadus saida* that constitutes its principal food.

North of Spitsbergen, in the summer of 1896, the Spitsbergen guillemot was unusually numerous by the open channels, from latitude 84° N., southwards as far as the northern shores of Spitsbergen, this, and *Alle alle*, being the most numerous of all the species of birds that appeared in these latitudes. Sometimes as many as twenty of these guillemots might be brought down on one day, and almost one hundred and fifty were shot for the table. Dr.

¹ "Bentsen saw a fulmar this evening, which circled about the ship for a while, and then flew away towards the west, following the channels".

Blessing writes in his journal for June 12th (83° N. Lat.): "Bird-shooting goes on busily every day. Black guillemots and little auks are the birds most shot, both because there are most of them, and because they are the best for eating".

In order to learn which of the two sexes was most numerously represented in these legions, Dr. Blessing examined a number of specimens shot at the end of June and the beginning of July. It then appeared that out of forty individuals, twenty-six were males and fourteen females. In all the females, the ovaries were not fully developed, the eggs being no larger than little grains, and only in one specimen the size of small peas. The testes of the males were also quite small, and thus all the specimens were probably young and incapable of reproduction.

The first Spitsbergen guillemot of the year was observed as early as the 13th May, (in 83° 57' N. Lat.), and on the 29th, a specimen was shot, being the first bird killed that year.

All the specimens observed were in their normal summer plumage.

Uria lomvia, (Pall.) 1811.

While *Cephus mandti* and *Alle alle* occurred in great numbers in the open channels north of Spitsbergen in the summer of 1896, *Uria lomvia* and *Fratercula arctica* were comparatively rare there, only a few specimens of each of the last two species having been observed from the 'Fram'.

Of Brünnich's guillemot, for instance, scarcely more than a dozen specimens were seen altogether. The first was seen flying northwards past the ship, on June 19th (82° 55' N. Lat.); and on June 23rd, the first specimen was shot (among the little auks occurring that day in great numbers). Finally, three more were shot on the 12th and 13th July (83° 11' N. Lat.).

Fratercula arctica glacialis, (Leach) 1821.

A single specimen was observed above Spitsbergen, flying northwards along a channel, on July 12th, 1896 (83° 11' N. Lat.). Mogstad writes in his journal, that for several days there had been few birds in the channel, but on the above-mentioned day a number of birds made their appearance, especially black guillemots and little auks, and a pair of Brünnich's guillemots were shot.

No other specimens were observed in the ice.

Alle alle, (Lin.) 1766.

This species was, on the whole, rarely observed during the time that the 'Fram' was drifting north-east of Franz Josef Land, in the summer of 1895; several specimens, however, were shot between June 21st and July 7th, all in a latitude between 84° 30' and 84° 48' N. Several were also observed in the channels, but the dogs always frightened them away.

Little auks, on the other hand, appeared in great numbers in the ice north of Spitsbergen, during the last summer. From the middle of June to the middle of July, 1896, while the 'Fram' was all the time moving in about 83° N. Lat., they were found daily in the channels, and at least two hundred were shot for the table. On one day alone — the 23rd June — twenty-nine were shot.

The first little auk appeared that year on May 28th (83° 56' N. Lat.). They were most numerous on clear days, while during fog they were less plentiful.

The reason of the great difference in the number of birds north of Spitsbergen and north of Franz Josef Land, was doubtless that during the summer of 1895, the 'Fram' was drifting in closely-packed ice, where there were comparatively few open channels. In 1896, there was more or less water round the ship all the summer, and the temperature, on the whole, was higher.

Dr. Blessing also examined a number of little auks shot about the beginning of July, 1896, in order to learn the proportion of the two sexes. It then appeared that among forty birds, there were only ten females.

As the ship gradually approached Spitsbergen, the number of this species increased. Mogstad writes in his journal for August 6th (81° 34' N. Lat.): "I saw from the crow's-nest today, a channel in the west, that was literally full of little auks; a number of them were sitting on the ice, and many were lying asleep on the water. In other places, I saw flock after flock flying northwards". On the 12th August, he writes: "A countless number of little auks. All day we have been steaming among great flocks of them, consisting chiefly of young birds. This means that we have not far to go before coming to open water".

INDEX.

	Page.
<i>Aegialitis hiaticula</i> , (Lin.) 1766	45
<i>Alle alle</i> , (Lin.) 1766	23, 39, 53
<i>Anser segetum</i> , (Gmel.) 1788	9
<i>Archibuteo lagopus</i> , (Gmel.) 1788	6
<i>Arquatella maritima</i> , (Gmel.) 1788	8, 24
<i>Branta bernicla</i> , (Lin.) 1766	9, 25
<i>Cepphus mandti</i> , (Licht.) 1822	13, 22, 36, 51
<i>Colymbus arcticus</i> , Lin. 1766	13
<i>Crymophilus fulvicarius</i> , (Lin.) 1766	8, 45
<i>Falco aesalon</i> , Tunst. 1771	6
<i>Fratercula arctica glacialis</i> , (Leach) 1821	52
<i>Fulmarus glacialis</i> , (Lin.) 1766	22, 35, 50
<i>Harelda glacialis</i> , (Lin.) 1766	9
<i>Lagopus lagopus</i> , (Lin.) 1766	7
<i>Larus argentatus</i> , Gmel. 1788	11
<i>Larus fuscus</i> , Lin. 1766	11
<i>Larus glaucus</i> , Fabr. 1780	11, 20, 29, 46
<i>Larus marinus</i> , Lin. 1766	47
<i>Nyctea scandiaca</i> , (Lin.) 1766	6
<i>Pagophila cburnea</i> , (Phipps) 1774	12, 20, 30, 49
<i>Phalaropus hyperboreus</i> , (Lin.) 1766	8
<i>Plectrophenax nivalis</i> , (Lin.) 1766	6, 14, 24, 44
<i>Rhodostethia rosea</i> , (Macg.) 1824	15, 27, 48
<i>Rissa tridactyla</i> , (Lin.) 1766	10, 14, 25, 47
<i>Somateria mollissima</i> , (Lin.) 1766	10, 25, 46
<i>Squatarola helvetica</i> , (Lin.) 1766	7
<i>Stercorarius crepidatus</i> , (Banks) 1733	12, 22, 33
<i>Stercorarius longicaudus</i> , (Vieill.) 1819	12, 35, 49
<i>Stercorarius pomatorhinus</i> , (Temm.) 1815	50
<i>Sterna macrura</i> , Naum. 1819	10, 25, 46
<i>Totanus nebularius</i> , (Gunn.) 1767	7
<i>Uria lomvia</i> , (Pall.) 1811	13, 37, 52
<i>Xema sabini</i> , (Sab.) 1818	48



Original: Czettel & Deutsch Budapest

RHODOSTETHIA ROSEA (MACG) 1824.
YOUNG IN FIRST PLUMAGE.

V.

CRUSTACEA

BY

G. O. SARS.



INTRODUCTION.

Of the zoological collections brought home from the Norwegian North Polar Expedition, those relating to the marine invertebrate animals have been placed in my hands for examination and description, and I now propose to report on the results of my investigations as far as the *Crustacea* are concerned. Indeed, by far the greater number of the animals collected belongs to this extensive class, and there is comparatively little to report of other animals. As, however, all knowledge of the fauna in this far remote, and hitherto unexplored part of the North Polar Sea may be of considerable interest, it is my intention in a subsequent paper also to give a short account of the other marine invertebrates found during the Expedition.

The collection in question consists of several tubes and bottles from different localities, each, as a rule, labelled with date, depth and mode of preservation. I have carefully gone through the contents of all the samples, in order to gain both a general view of the character of the fauna, and more special information about the several species. Only one of the bottles contained true bottom-animals taken up by the aid of the trawl; all the other samples have been procured by the aid of the tow-net, and of course contain exclusively pelagic animals, chiefly *Crustacea*. Of these again *Copepoda*, chiefly belonging to the *Calanoid* group, are predominant, having been taken in nearly every haul and in considerable numbers along the whole route of the "Fram". This peculiar character of the collections is due to the unexpected physical conditions found in the Polar Sea traversed. As is well known, it has until recently been the general assumption of geographers, that the Polar basin, north of Siberia and Franz Josef Land,

could only be quite a shallow sea, with depths scarcely exceeding some hundred fathoms, and the zoological equipment of the 'Fram' Expedition was arranged in accordance therewith. But in direct contradiction to this generally adopted view, that part of the Polar Sea through which the 'Fram' drifted with the ice, proved to be everywhere of enormous depth, exceeding in this respect even the Norwegian Sea. The quantity of hemp-rope at hand was quite insufficient for dredging or trawling in such depths, and, indeed, it was a matter of no little trouble to find a means of ascertaining the depth with exactness. For this purpose it was necessary to make up from the wire-ropes of the 'Fram' a provisional sounding-line of sufficient length and consisting of thin steel-wire. To the end of this line, which of course was far from being strong enough for dredging operations, was appended in some instances a heavy water-bottle, in others an ordinary lead, and in the latter case a sample of the bottom was always brought up together with the lead. But on a preliminary examination, scarcely any traces of organisms could ever be detected in this material, and it must be concluded from this that there is at least very little animal life on the bottom in this part of the ocean. On the other hand, it is a very remarkable fact, that the more superficial strata of the sea, though almost perpetually covered with a layer of ice, through which comparatively small, temporary openings occur in the shape of channels and lanes, were found to abound with life at all times of the year, and even to the most northerly latitudes reached. It is very probable, too, that the pelagic animals observed are not strictly confined to the more superficial strata of the sea, but that they also at times descend to considerable depths, perhaps even to the strata immediately covering the bottom. In many cases the tow-net was lowered to depths exceeding 200 or 300 metres, and, as a rule, the draught was considerably richer in such instances, than when it was working in smaller depths. Moreover, the peculiar Amphipode described below as *Cyclocaris Guilelmi* Chevreux, was found several times clinging to the sounding-line at only a short distance above the water-bottle, which was hauled up from depths between 500 and 1000 metres. The imperfect development of the visual organs in this form, and likewise in some of the other pelagic animals observed, would also seem to point to abyssal habits.

As to the general character of the pelagic fauna in the North Polar Basin explored by the Expedition, it exhibits, on the whole, a pronounced resemblance to that of the North Atlantic Basin, the greater number of species having, indeed, proved to be common to both. In considering the *Calanoida* in particular, it was not a little surprising to find rather abundantly represented in the samples, some characteristic forms well known to me from the deep fjord-basins of the south and west coasts of Norway, but hardly ever recorded by any foreign zoologists, though they must doubtless also occur in the North Atlantic Basin. These forms, which have occasionally been mentioned by me as deep-water Calanoida, are, indeed, at least off our coasts, only met with in depths of more than 100 fathoms, whereas in the North Polar Basin they often ascend to the very surface of the sea. Intermingled with them were some well-known surface-Calanoids, such as the widely distributed *Calanus finmarchicus*, *Pseudocalanus elongatus*, etc. There are, moreover, a number of hitherto unknown forms, to be presently described in detail, which accordingly might be regarded as peculiar to the Polar basin; but it is not improbable that on a closer investigation, these forms will also be found to occur in the northern part of the Atlantic basin. Indeed, strictly speaking, the most westerly part of the 'Fram's' route lies on the border between the two basins; and yet the character of the fauna here did not differ in any essential manner from that in the eastern part. As, however, the superficial current in the North Polar Sea has been clearly shown to flow in a westerly direction, it is possible to suppose that some forms at least might have their centre of distribution far east, perhaps even in the Bering Sea. But as the pelagic fauna of that part of the ocean is still very imperfectly known, it is as yet impossible to decide with certainty which forms in such cases ought to be regarded as immigrants from the east. At any rate, though the existence of the western current has been demonstrated in a most convincing manner by the drift of the 'Fram', there is also full evidence of the existence of a current in quite the opposite direction, but confined to the deeper strata of the sea; for both the comparatively high temperature of the water found down to the lowest depths and its great salinity clearly show it to be derived from the Atlantic Basin. An immigration of animals to the North Polar Sea may accordingly be possible from both the west and the east; but, as the more superficial strata flowing in a westerly direction, together with the ice covering

them, are largely mingled with fresh water, and constantly subjected to a rather low temperature, they seem in reality to offer less favourable conditions for the well-being of higher organisms. I am therefore of opinion, that the bulk of the pelagic animals found in the North Polar Basin are in fact derived from the west through the Atlantic current flowing in beneath the superficial Siberian current. On the other hand, I think that the latter is of great importance in conveying a constant supply of nourishment to the pelagic animals of the North Polar Basin. This nourishment consists of microscopic algæ, chiefly *Diatomeæ*, which are found to abound in the superficial polar water of the Siberian Sea, though gradually diminishing in quantity westwards, apparently owing to their being largely fed upon by the various pelagic animals. Indeed, without such a constant conveyance of nourishing matter, there could be no such rich animal life in the Polar Sea.

It is a very remarkable fact, that forms which have hitherto been regarded as quite southern in distribution, are also represented in the Polar Sea. I have several instances of this remarkable occurrence to report on, as regards the pelagic Copepoda. Thus, in a sample taken at about the centre of the Polar basin traversed, I found a well preserved specimen of a Calanoid, differing conspicuously in its external appearance from all the other forms, and easily recognizable as a species of the genus *Hemicalanus* Claus. This genus has as yet only been known from the Mediterranean and the tropical parts of the Atlantic and Pacific Oceans, never having been met with either off the Norwegian coast or off the Atlantic coast of Europe. Furthermore, in the sea north of the New Siberian Islands, two species of the genus *Oncaea* Phillipi are found in great abundance, and both these species I have been enabled to identify with perfect certainty with species recently recorded by Dr. Giesbrecht from the Bay of Naples. One of the species, *O. conifera* Giesbr., was certainly observed by the present author many years ago off the south coast of Norway; but the other species, *O. notopoda* Giesbr., is as yet only known from the Mediterranean. In about the same tracts, in which the two above-mentioned species of *Oncaea* occurred, another very peculiar Copepod, belonging to the same group, was met with. It is a species of the genus *Lubbockia* Claus, hitherto only known from the Mediterranean and the tropical parts of the oceans. Finally, in the very same sample in which the last-named Copepod was found, I succeeded in picking up some specimens of

a small, perfectly hyaline Copepod of a still more peculiar appearance, and at once recognizable as a species of the highly remarkable genus *Mormonilla* of Giesbrecht, the systematic position of which is still rather doubtful. Only two species of this genus have hitherto been recorded, and both of them were found in the tropical part of the Pacific, south of the equator. The polar form so closely resembles one of the two species described by Dr. Giesbrecht, that I should have been much inclined to identify the two forms, were it not that the great distance between the occurrences seems to forbid such an identification. The very close, and apparently genetic relationship between the two polar species of the amphipodous genus *Pseudalibrotus* to be described below, and those occurring in the Caspian Sea, is another remarkable instance, which seems fully to corroborate the correctness of the assumption of geologists as to a direct connexion in olden times between this isolated basin and the North Polar Sea.

In order to show the general character of the pelagic fauna in the Polar Sea, I subjoin lists of the species found in 5 widely-separated tracts of the region traversed by the "Fram".

No. 1.

12th to 24th October, 1893.

Sea north of New Siberia (beginning of the drift).

In about 78° N. Lat., 136° E. Long.

Sabinea septemcarinata (Sab.). Myto-stage.

Parathemisto oblivia Krøyer.

Melospa longicornis Boeck.

Gammarus locusta, var. *mutata*, Lilljeb.

Calanus finmarchicus, Gun.

— *hyperboreus*, Krøyer.

Pseudocalanus elongatus, Boeck.

— *major*, G. O. Sars.

— *pygmæus*, G. O. Sars.

Euchæta norvegica, Boeck.

Metridia longa, (Lubb.)
Acartia longiremis, Lilljeb.
Oithona similis, Claus.
Oncaea conifera, Giesbr.
 — *notopoda*, Giesbr.
Conchœcia maxima, Brady & Norm.
Cirripedia-larva in Cypris-stage.
Clione papilionacea Pall. (*larva*).
Appendicularia.
Sagitta (*Spadella*).
Young of Ophiura?
Medusoid.
 Number of *Diatomeæ* (*Chætoceras*).

No. 2.

March—April, 1894.

In about 80° N. Lat., 134° E. Long.

Hymenodora glacialis, (Buchh.)
Thysanoëssa longicaudata, Kr.

Euthemisto libellula (Mandt).
Parathemisto oblivia, (Krøyer).
Lanceola Clausi, Bovallius.
Scina borealis, G. O. Sars.
Cyclocaris Guilelmi, Chevreux.
Pseudalibrotus glacialis, G. O. Sars.
 — *Nanseni*, G. O. Sars.
Eusirus cuspidatus, Krøyer.
Amphithopsis glacialis, Hansen.
Gammarus locusta Lin., var. *mutata*.
Amathilla pingvis (Krøyer).

Dajus mysidis Krøyer, (larvæ in 1st and last stages).
Cryptoniscid-larvæ.

- Calanus finmarchicus*, Gunn.
 — *hyperboreus*, Krøyer.
Scaphocalanusacrocephalus, G. O. Sars.
Undinella oblonga, G. O. Sars.
Euchaeta norvegica, Boeck.
Chiridius armatus, (Boeck).
 — *tenuispinus*, G. O. Sars.
Pseudocalanus major, G. O. Sars.
Spinocalanus longicornis, G. O. Sars.
Drepanopus Bungei, G. O. Sars.
Heterochaeta norvegica, Boeck.
 — *compacta*, G. O. Sars.
Augaptilus glacialis, G. O. Sars.
Metridia longa, (Lubbock).
Temorites brevis, G. O. Sars.

Conchoecia maxima, Brady & Norm.
Sagitta (Spadella).
 Only slight traces of algæ.

No. 3.

April—August, 1895.

Between 84° 15' and 84° 42' N. Lat., and between 96° and 72° E. Long.

- Thysanoëssa longicaudata* (Kr.).
Parathemisto oblivia, (Krøyer).
Lanceola Clausi, Bovallius.
Eusirus Holmi, Hansen.
Amphithopsis glacialis, Hansen.

Calanus finmarchicus, (Gunn.).
 — *hyperboreus*, Krøyer.
Scaphocalanusacrocephalus, G. O. Sars.
Scolecithrix brevicornis, G. O. Sars.
Undinella oblonga, G. O. Sars.

Euchæta norvegica, Boeck.
Undeuchæta spectabilis, G. O. Sars.
Chiridius armatus, (Boeck).
 — *tenuispinus*, G. O. Sars.
 — *brevispinus*, G. O. Sars.
Heterochæta norvegica, Boeck.
 — *compacta*, G. O. Sars.
Augaptilus glacialis, G. O. Sars.
Hemicalanus spinifrons, G. O. Sars.
Metridia longa, (Lubb.).
Temorites brevis, G. O. Sars.

Conchoecia maxima, Brady & Norm.
Sagitta (Spadella).
 No algæ.

No. 4.

October 12th, 1895.

85° 13' N. Lat., 79° E. Long.

Amphithopsis glacialis, Hansen.

Calanus finmarchicus, (Gunn.).
 — *hyperboreus*, Kr.
Scaphocalanus acrocephalus, G. O. Sars.
Undinella oblonga, G. O. Sars.
Chiridius brevispinus, G. O. Sars.
Heterochæta norvegica, Boeck.
 — *compacta*, G. O. Sars.
Augaptilus glacialis, G. O. Sars.
Metridia longa, (Lubb.).
Temorites brevis, G. O. Sars.
 No algæ.

No. 5.

February—May, 1896.

The most westerly part of the 'Fram's' route.

Between 84° 47' and 83° 57' N. Lat., and between 25° and 11° E. Long.

Thysanoëssa longicaudata, (Kr.).*Euthemisto libellula*, (Mandt).*Parathemisto oblivia* (Krøyer).*Lanceota Clausi*, Bovallius.*Cyclocaris Guilelmi*, Chevreux.*Pseudalibratus glacialis*, G. O. Sars.— *Nanseni*, G. O. Sars.*Paramphithoë brevicornis*, G. O. Sars.*Metopa longicornis*, Boeck.*Eusirus Holmi*, Hansen.*Amphithopsis glacialis*, Hansen.*Gammarus locusta* L. var. *mutata*.*Calanus finmarchicus*, (Gunn.).— *hyperboreus*, Kr.*Scaphocalanus acrocephalus*, G. O. Sars.*Euchæta norvegica*, Boeck.*Chiridius armatus*, (Boeck).*Heterochata norvegica*, Boeck.*Melridia longa*, (Lubb.).*Conchoecia maxima*, Brady & Norm.*Clione papilionacea*, Pall. jun.*Sagitta (Spadella)*.

No algæ.

I further add here a list of species from a single locality, because in this instance it has been expressly stated that the sample was taken from the very surface of the sea, whereas in all other cases the tow-net was lowered to some considerable depth below the ice.

28th June, 1895.

84° 32' N. Lat., 76° E. Long.

About midway in the route of the 'Fram'.

Sample taken by towing from a boat in a large open lane in the ice.

Parathemisto oblivia, (Krøyer).

Calanus finmarchicus, (Gunn.).

— *hyperboreus*, Kr.

Scaphocalanusacrocephalus, G. O. Sars.

Undinella oblonga, G. O. Sars.

Euchæta norvegica, Boeck.

Chiridius armatus, (Boeck).

— *tenuispinus*, G. O. Sars.

Heterochæta norvegica, Boeck.

— *compacta*, G. O. Sars.

Metridia longa, (Lubb.).

Temorites brevis, G. O. Sars.

Conchoecia maxima, Brady & Norm.

Sagitta (Spadella).

No algæ.

Of the 11 species of Copepoda enumerated from the above-named sample, 6 also occur off the Norwegian coast; but it is worthy of note, that all of them, except *Calanus finmarchicus*, are here confined to great depths, more than 100 fathoms. The above-named Hyperiid, *Parathemisto oblivia*, is also a pronounced deep-water form off our coasts, and the same is also the case with the 3 Norwegian species of *Conchoecia*, one of which, *C. borealis* G. O. Sars, is very closely allied to the arctic form here named.

In the following pages, I shall try to give an account of all the species of Crustacea found in the collections of the 'Fram', with notes on their occurrence and distribution, and with descriptions and figures of the new or less familiar forms.

The plates accompanying this account have been prepared by the autographic method employed by the present author in most of his recent publications, and will, I hope, serve for an immediate recognition of the species.

12

ACCOUNT OF THE SPECIES.

PODOPHTHALMIA.

Fam. CRANGONIDÆ.

1. *Sabinea septemcarinata* (Sab.).

A well-preserved larva in the last stage of this form (= *Myto Gaimardii*, Kroyer) is in the collection, having been taken by means of the tow-net on the 13th October, 1893, from a depth of about 50 metres.

Distribution. Coast of Norway, Atlantic coast of North America, Greenland, Spitsbergen, the Murman coast, the Kara Sea, the Bering Sea.

Fam. EPHYRIDÆ.

2. *Hymenodora glacialis* (Buchholtz).

Of this peculiar form, described and figured in detail by the present author in his account of the Crustacea of the Norwegian North Atlantic Expedition, a solitary young specimen was found in a sample taken on the 24th March, 1894, the tow-net having been lowered to a depth of 300 metres.¹

Distribution. Greenland, several stations of the Norwegian North Atlantic Expedition (cold area), the Farøe Channel, east coast of North America (Albatross Expedition).

Fam. EUPHAUSIIDÆ.

3. *Nyctiphanes norvegicus* (M. Sars).

A well-preserved specimen of this beautiful form was taken on the 22nd May, 1894, from a depth of 100 metres.

¹ That this form must have occurred rather plentifully in about the same tract, and in the very surface of the sea, is proved from the fact that easily recognizable remains of it were found in the stomachs of 8 specimens of the roseate gull (*Rhodostethia rosea*) shot between the 3rd and 8th August same year.

Distribution. Coast of Norway, Scotland, the Murman coast, Greenland, east coast of North America.

4. *Thysanoëssa longicaudata* (Krøyer).

Syn: *Thysanoëssa tenera*, G. O. Sars.

Solitary specimens of this form, in a more or less perfect state, were found in 4 different samples taken in places lying widely apart from each other (March 24th, 1894, July 30th, 1895, Feb. 4th, 1896, Feb. 13th, 1896), the tow-net having been lowered to a depth of between 50 and 300 metres

Distribution. Varanger Fjord, sea between Norway and Jan Mayen (Norw. North Atl. Exp.), Greenland.

AMPHIPODA.

Fam. HYPERIIDÆ.

1. *Euthemisto libellula* (Mandt).

This well-known arctic form was taken both at the beginning and close of the cruise, partly young, partly fully grown specimens. The greater number of the specimens are, however, from the western part of the region traversed.

Distribution. Coast of Finmark, the Murman coast, Novaja Semlja, Siberian Polar Sea, Beeren Eiland, Spitsbergen, Jan Mayen, Greenland.

2. *Parathemisto oblivia* (Krøyer).

This form also seems to be widely distributed throughout the Polar basin, having been taken along the whole route of the 'Fram' in no less than 12 different places.

Distribution. Coast of Norway, British Isles, Greenland, numerous stations of the Norwegian North Atlantic Expedition.

Fam. LANCEOLIDÆ.

Gen. *Lanceola*, Say.

Remarks. This genus was established by the American zoologist, Th. Say, as early as the year 1818, to include a peculiar Amphipod belonging to the Hyperiid group. But the genus was not recognized by subsequent authors, some of whom regarded it as synonymous with *Hyperia*, others

with *Vibilia*. It is to Dr. Bovallius that we owe the restoration of Say's genus, as he pointed out its difference from both *Hyperia* and *Vibilia*. Indeed, Dr. Bovallius even regards it as the type of a distinct family, *Lanceolidae*, at the same time adding no less than 5 new species to that originally described by Say. Of these species, one has been found during the 'Fram' Expedition, and, as only a short diagnosis, accompanied by 4 figures in outline, has been given of it by Dr. Bovallius, I find it appropriate here to describe and figure this remarkable form more in detail.

3. *Lanceola Clausi*, Bovallius.

(Pl. I).

Lanceola Clausi, Bovallius, 'On some forgotten genera of Amphipoda'. Bi-hang till Kgl. Svenska Vet. Akad. Handl. Part 10, p. 8.

The *Same*: 'Arctic and Antarctic Hyperids'. Vega-Expeditionens vetensk. arbeten, vol. IV, p. 553, Pl. 41, figs. 11—14.

Description.

The largest specimen in the collection, the one here figured, has a length of about 10 mm.; but, as Dr. Bovallius gives the length as 16 mm., it cannot be fully grown.

True, at first sight, the specimen here figured (see Pl. I. fig. 1) has the appearance of being an adult gravid female, with largely protuberant marsupium; but, on a closer examination, it is easily seen that this impression is merely due to a delusion. For the fact is that no marsupium at all is formed, and the protruding part that has this appearance, is nothing but the ventral walls of the body itself, along the middle of which, immediately beneath the skin, the ganglionic chain may be very distinctly traced. Indeed, the anterior part of the body-cavity is enormously dilated, in order to give room for the exceedingly capacious stomachal part of the intestine.

The integuments are remarkably soft and supple, and the whole body thereby acquires a peculiar vagueness in its contours, not observed in other Amphipods. As the metasome generally is bent in against the greatly swollen mesosome, the whole body looks like an irregular, soft ball.

The cephalon, unlike what is the case in the true *Hyperiids*, is very small, and abruptly truncated in front, with the anterior face somewhat concave, and bounded above by a projecting, rostrum-like angle. Between the

insertion of the 2 pairs of antennæ, it forms, on each side, a slight rounded lobe, within which the very small eyes have their place, and below, it terminates on each side in another obtuse lobe, with which the buccal mass is connected.

The segments of the mesosome are well defined in their dorsal part, exhibiting laterally an even horizontal margin, with which the extremely small coxal plates are connected; but the protruding ventral part of the 2nd to 5th segments seems to form a continuous whole. The 1st segment is rather short, scarcely exceeding in length the cephalon, whereas the 3 succeeding segments are of considerable size, the 3rd and 4th each exhibiting in front an elevated transversal eminence defined behind by a distinct depression. The 3 posterior segments rapidly diminish in size; the last 2 do not exhibit any protuberant ventral part, and on the whole are very similar in appearance to the 3 succeeding segments belonging to the metasome. The epimeral plates of the latter are comparatively small and evenly rounded.

The urosome (see also fig. 16), as in the true *Hyperiid*s, is depressed, and composed of 2 segments only, the last 2 being wholly fused together. The whole posterior division of the body, comprising the metasome and urosome, scarcely attains half the length of the anterior, and this is regarded by Dr. Bovallius as a distinctive character, separating the present species from some of the others. It is very probable, however, that in the male this division is much more fully developed than in the female.

The eyes, contrary to what is the case in the true *Hyperiid*s, are extremely small, rounded, and composed of a restricted number of visual elements, imbedded in a light red pigment.

The superior antennæ (see figs. 2, 3) issue at rather a long distance from the upper angle of the head, and widely apart from each other. They are apparently composed of only 3 joints, the first 2 constituting the peduncle, the 3rd the flagellum. Of the peduncular joints, the 1st is the larger, and is defined from the 2nd by a deep constriction. It may be that, as indicated by Dr. Bovallius for the type species, there is a very short intermediate joint in the peduncle; but I have not been able to see such a joint with any distinctness in the specimens I have examined. The terminal joint, or flagellum, is somewhat longer than the peduncle, compressed, lanceolate, and edged with very small sensory bristles. Any apical joints, I have failed to distinguish.

The inferior antennæ (see figs. 2 & 4) are a little longer and more slender than the superior, and have the peduncle composed of 4 joints, the last of which is the largest. The flagellum, as in the superior antennæ, is uniaarticulate, forming a somewhat flattened, narrow, lanceolate joint, terminating in a straight, slender spine.

The buccal mass (see figs. 1 & 2) is rather protuberant, and composed of the usual number of oral parts mutually covering each other.

The anterior lip (see figs. 2 & 5) forms a comparatively small, deeply bilobate flap, covering the masticatory parts of the mandibles, and having the edge quite smooth.

The posterior lip (fig. 6) is much larger, with the lateral lobes greatly divergent, and each terminating in an oval, somewhat recurved lappet.

The mandibles (see figs. 2 & 7) are in the form of 2 flattened, almost horizontally arranged pieces meeting in front, below the anterior lip. They do not exhibit any trace of a true molar prominence; but the inner face is rough owing to the presence of numerous small hair-like spinules. The cutting edge is simple, with the upper corner acutely produced, the lower more obtuse, and exhibiting a very small tooth-like projection. On the left mandible, just within the upper corner of the cutting edge, there is an extremely small bidentate prominence, constituting a rudiment of a secondary cutting plate. The palp is well developed, being considerably longer than the body of the mandible, and is composed of 3 well-defined joints. Of these the 1st is rather short, whereas the 2nd is elongated and somewhat compressed, exhibiting inside 4 short spiniform bristles, outside in the outer part, several slender setæ. The terminal joint is shorter than the 2nd, and conically tapered, with a delicate ciliation along the inner edge.

The anterior maxillæ (see figs. 2 & 8) exhibit all the chief parts found in typical Amphipoda. The masticatory lobe is densely hairy and divided at the somewhat oblique end into 4 strong teeth. The basal lobe is rather short, and likewise densely hairy, but without any true spines or setæ. The palp consists of only a single lamellar joint of oblong oval form, and partly covering the masticatory lobe outside. It is edged with short spinules, those on the inner margin being extremely small and densely crowded together. From the outer side of the basal part, moreover, several strong bristles are seen to originate.

The posterior maxillæ (see figs. 2 & 9) are likewise quite normal in their construction. The basal part is rather voluminous and muscular, and the 2 terminal lobes are comparatively narrow and strongly incurved. Both lobes are densely hairy, and the somewhat larger outer lobe is, moreover, armed at the tip with several strong spines.

The maxillipeds (see figs. 2 & 10), as in other *Hyperiida*, are quite destitute of palps. The broad, flattened basal part consists of a short common root-joint, and 2 juxtaposed lamellar pieces, each carrying outside a single seta, and projecting at the end inside in a short triangular lappet. These lappets, which lie in close juxtaposition, and are fringed with short bristles, undoubtedly answer to the basal lobes in other Amphipoda. It is likewise indubitable that the large lamellæ appended to the end of the basal part, represent the masticatory lobes in other Amphipoda, exhibiting, as they do, a very similar appearance. They are oblong oval in form, and, being movably articulated to the basal part, they may either be extended straight in front, or be spread out, so as to diverge more or less widely. Along the straight inner edge, there is a double row of strong spiniform bristles, and each of the lobes also carries outside, at some distance from the tip, 2 similar bristles springing from a distinct ledge.

The 2 pairs of gnathopoda (figs. 11, 12) are of essentially similar structure, being considerably shorter and thicker than the pereopoda, and also more abundantly supplied with bristles. They are quite simple, without any trace of a cheliform structure, the propodal joint being conically tapered, and carrying at the tip the small dactylus. This joint is rather more produced in the posterior than in the anterior pair; but in none of them is there any distinctly defined palm.

The 2 anterior pairs of pereopoda (fig. 13) are of quite normal appearance, and moderately slender. Of the joints, the carpal and propodal ones are somewhat compressed, and are both provided along the posterior edge with a row of short spinules. The dactylus is comparatively small and quite simple.

The 3 posterior pairs of pereopoda (figs. 14, 15) gradually diminish somewhat in length, and are all distinguished by the peculiar arrangement of the dactylus. The latter is strongly curved, finely denticulated along the concave edge, and exerted in a very acute point. It is, moreover, retractile, and capable of being received into a hollow formed by a cup-like projection of

the propodal joint (see figs. 14 a, 15 a). Otherwise, these legs are remarkably smooth, and have the basal joint scarcely broader than on the 2 anterior pairs.

The branchial lamellæ are comparatively small, and are present on the posterior gnathopoda and the 4 anterior pairs of pereopoda (see figs 1, 12, 13, 14). In the specimen examined, slight rudiments of incubatory plates were present inside the branchial lamellæ (see figs. 12, 13).

The pleopoda are rather powerfully developed, and of normal structure.

The uropoda (see fig. 16) exhibit the structure usually met with in *Hyperiid*s, the terminal rami being lanceolate in form, with the edges finely serrulate (see fig. 17). The last pair do not differ from the 2 preceding ones, except in the somewhat greater breadth of the basal part.

The telson (*ibid.*) is oblong triangular in form, and quite simple, without any armature. It does not reach to the end of the basal part of the last pair of uropoda.

Occurrence. This peculiar Amphipod occurred in 6 different samples, 5 of which were taken along the eastern part of the route of the "Fram", between latitudes 80° and 85°, the 6th much farther west, at about the 30th degree of longitude, and near the 85th degree of latitude. In all the places, the tow-net had been lowered to depths of between 100 and 300 metres. By far the greater number of the specimens found are very small, and evidently quite young. Only in one place were 2 larger specimens caught, one of which is that here described.

Distribution. Davis Straits, in lat. 72° N. (Bovallius).

Fam. SCINIDÆ.

4. *Scina borealis*, G. O. Sars.

Some specimens of this easily recognizable form were found in 3 samples collected towards the end of March and in the beginning of April, 1894, in about the 80th degree of latitude, the tow-net having been lowered, in all 3 places, to a depth of 300 metres.

Fam. LYSIANASSIDÆ.

Gen. *Cyclocaris*, Stebbing.

Remarks. This genus was established in the year 1888 by the Rev. Mr. Stebbing, to include a peculiar Amphipod from the Challenger Expedition,

the solitary specimen procured having been taken in the Pacific, at some distance from Tahiti. The genus was justly placed in the extensive family *Lysianassidæ*, though in some characters it differs rather markedly from the other known genera. It was, indeed, very surprising to find this genus represented in the Polar Sea by a well-marked and very beautiful species; and I had intended to dedicate it to our celebrated explorer, Prof. Nansen. The same species, however, has been quite recently recorded by M. E. Chevreux from the Expedition of the Prince of Monaco, and, as nothing has as yet been published about the Crustacea of the Nansen Expedition, the name proposed by M. Chevreux for this species ought of course to be retained. The species will be described in detail below.

5. *Cyclocaris Guilelmi*, Chevreux.

(Pl. II & III).

Cyclocaris Guilelmi, E. Chevreux, Bulletin de la société zoologique de France, T. XXIV, 1899, p. 148.

Remarks. The present species is nearly related to the Pacific form described by the Rev. Mr. Stebbing as *C. tahitensis*, though evidently specifically distinct, being not only of considerably larger size, but also differing in some of the structural details, as will be seen by comparing the figures here given with those reproduced in Mr. Stebbing's work. On the other hand, no doubt can arise as to the identity of the Polar form with that recorded by M. Chevreux under the above name.

Description of the Female.

The length of the largest specimens in the collection is about 18 mm. Those examined by M. Chevreux were somewhat smaller, measuring from 11 to 12 mm.

The general form of the body (see Pl. II, fig. 1) is moderately slender and somewhat compressed, with the mesosome slightly exceeding in length the metasome and urosome combined. The back is quite smooth throughout, and generally slightly curved.

The cephalon (see also fig. 2) is rather thick and massive, and, from a lateral point of view, quadrangular in form, being transversely truncated

in front. Its lateral faces are perfectly smooth, and almost wholly occupied by the unusually large, but very imperfectly developed eyes, which extend above, so as to meet along the dorsal line. The upper angle of the head forms a very small rostral projection, curved down between the bases of the superior antennæ; the lower corners are somewhat more prominent, and between them and the rostral projection, the anterior edges of the head appear very slightly curved. The inferior boundary of the lateral faces is not, as usual, emarginated or incised, but forms on each side an uninterrupted, gently curving line.

Of the segments of the mesosome, the 1st is considerably longer than the 2nd, which is comparatively very short, both together about equal in length to the cephalon. The succeeding segments gradually increase somewhat both in length and depth, the last, however, being scarcely larger than the penultimate one. The 2 anterior pairs of coxal plates are very small, and partly concealed by the 3rd pair, which are much deeper than the corresponding segment, gradually expanded distally, and extended obliquely in front, so as to reach the hind edge of the cephalon (see fig. 1). The 4th pair of coxal plates are still larger, and, as usual, emarginated behind, projecting below the emargination in an obtuse lobe. The 3 posterior pairs of coxal plates are not nearly so deep as the 2 preceding pairs, and are transversally oval in form, slightly decreasing in size posteriorly.

The epimeral plates of the metasome (see figs. 1 & 3) are of moderate size, the anterior pair being obtusely rounded, whereas the 2 posterior pairs are acutely produced behind, with the inferior edge fringed with delicate bristles.

The 3 segments of the urosome are well defined, and combined are about half as long as the metasome. The 1st segment exhibits a slight dorsal depression, and the 2nd is very short. In none of the segments could any spines or bristles be detected.

The eyes (see figs. 1 & 2), as above stated, are of quite enormous size, not only occupying the greater part of the lateral faces of the cephalon, but also extending dorsally, so as to meet in the middle. Their structure, however, is very imperfect, there being no trace of any refracting elements, but only simple, rod-like fibres, imbedded in a dark red pigment. In specimens that have been a long time in strong alcohol, the ocular pigment very soon disappears, as is also often the case in other *Lysianassidæ*. In such

specimens, the eyes appear to be altogether wanting, as indicated by M. Chevreux; but in some of the specimens from the Nansen Expedition, that have been preserved in a weaker solution of alcohol, the ocular pigment was still easily observable, though it had somewhat changed its original colour; and in these specimens the actual presence of eyes, and their enormous size could be proved with full certainty.

The superior antennæ (fig. 4) are comparatively short, about as long as the cephalon and the 2 anterior segments of the mesosome combined, and they exhibit the structure generally met with in the *Lysianassidæ*. The peduncle is short and thick, with the 2 outer joints very small. The flagellum is about twice the length of the peduncle, and is composed of 12 articulations, the 1st of which is rather large, sublaminar, and densely clothed inside with delicate sensory filaments. At the tip, this articulation, like the 3 succeeding ones, carries a rigid bristle. The accessory appendage is fully half the length of the flagellum, and is composed of 6 articulations, the 1st of which is much the largest.

The inferior antennæ (fig. 5), which issue at some distance below the superior, are about twice as long as the latter, and have the first 2 joints of the peduncle quite concealed by the antero-lateral corners of the cephalon (see fig. 2). The 2 outer joints of the peduncle are of about equal length, and are both clothed anteriorly with short bristles. The flagellum is rather slender, being fully twice as long as the peduncle, and composed of about 30 short articulations.

The buccal mass (see figs. 1 & 2) is greatly protuberant, and wholly uncovered laterally, protruding in front somewhat beyond the anterior edge of the cephalon. The peculiar structure of the mandibles and maxillipeds is easily observable, even without dissection.

The anterior lip (fig. 6) is comparatively small, exhibiting a median convex part, and 2 rounded lateral expansions.

The posterior lip (fig. 7) is much larger, with the lateral lobes widely apart, and each projecting behind in a narrow process pointing straight posteriorly.

The mandibles (fig. 8) are pronouncedly laminar, and without any trace of a molar process¹. The cutting edge is quite simple, straight, and sharp,

¹ Such a process is certainly described by M. Chevreux; but I believe that in this case he has fallen into an error, by mistaking the chitinous tendon of the rotatory muscle of the mandible for a process of this kind.

with only a very small dentiform projection at each corner. Inside the masticatory part, there is a row of thick ciliated spines extending from the lower corner of the cutting edge to about the end of the inner third part of the mandible, and at some distance from its posterior edge (see fig. 9). Anteriorly, at some distance from the cutting edge, each mandible forms an angular projection, outside which the palp is articulated. The latter is rather slender, but scarcely longer than the body of the mandible, and has the terminal joint narrow lanceolate, and shorter than the medial one, both being fringed inside with a row of delicate bristles.

The anterior maxillæ (fig. 10) exhibit quite a normal appearance. The terminal joint of the palp is divided at the tip into several strong teeth, which, as usual, slightly differ in the 2 maxillæ. The masticatory lobe is rather prominent, and is armed at the tip, and along the inner edge, with several strong spines. The basal lobe is of moderate size, and slightly curved, and carries inside 9 plumose setæ.

The posterior maxillæ (fig. 11) have both lobes rather narrow, the outer one being by far the larger. Both lobes are densely clothed along their inner edge with partly ciliated setæ.

The maxillipeds (fig. 12) are prominently characterised by the enormous development of the masticatory lobes, which form very large, broadly oval plates reaching beyond the penultimate joint of the palps, and easily observable on viewing the animal from the side (see figs. 1 & 2). They have the inner edge straight and minutely serrate, the tip obtusely truncate, and the outer edge slightly curved, with a row of delicate bristles. The basal lobes are obliquely truncated at the end, and each provided inside with a row of strong setæ. The palps are comparatively slender, and gradually taper distally, the last joint being rather narrow, oblong, and, like the other joints, clothed with scattered bristles.

The anterior gnathopoda (Pl. III, fig. 1) are very slender and but scantily setiferous. Of the joints, the ischial one is unusually prolonged, being of about the same length as the carpal one. The propodal joint is somewhat shorter than these joints, and gradually tapers distally, without exhibiting any distinctly defined palmar edge. The dactylus is comparatively small, and somewhat compressed (see fig. 1 a).

The posterior gnathopoda (fig. 2) exhibit the structure characteristic of the *Lysianassidæ*, being extremely slender and flexible, and very frequently bent in such a manner as not to be visible externally. The 2 outer joints are densely clothed with fine hairs, and carry, moreover, fascicles of slender bristles. The propodal joint is oblong oval in form, and exceeds half the length of the carpal one. It is narrowly truncated at the tip, and carries on the upper corner the very small curved dactylus (see fig. 3 a).

The 2 anterior pairs of pereopoda (figs. 3, 4) are of moderate length, and quite normal in structure.

The 3 posterior pairs (figs. 5, 6, 7), on the other hand, are more elongated than in most other *Lysianassidæ*, and slightly increase in length posteriorly. The basal joint is rather large and laminar, being obliquely rounded in the anterior pair (fig. 5), and in the 2 other pairs (figs. 6 & 7) more pyriform in outline. In all 3 pairs, the posterior edge is for some distance minutely serrate, and the infero-posteal corner drawn out to an obtusely rounded lobe. The outer part of the legs is fringed on both edges with fascicles of short spines, and has the propodal joint rather elongate and sublinear in form. The dactylus is of moderate length, and but slightly curved.

The branchial lamellæ are present at the base of all the legs, except the 1st pair (the anterior gnathopoda), and are of moderate size, with a small secondary lobe inside (see figs. 2—7). The incubatory plates (not fully developed in the specimen examined) are very narrow.

The pleopoda are of quite normal structure.

The uropoda, however, somewhat differ from those in other *Lysianassidæ*. The two anterior pairs (figs. 8, 9) have both rami lanceolate in form, terminating in a simple, naked point, and carrying on the edges short scattered spinules, the outer ramus in both pairs being shorter, and also narrower, than the inner. The last pair (fig. 10), as usual, have the basal part shorter and thicker than in the 2 preceding pairs, whereas the rami are comparatively larger, so as to project beyond those of the above-mentioned pairs. The inner ramus is uniarticulate and lanceolate in form, with the inner edge densely setiferous; the outer ramus, on the other hand, is distinctly biarticulate, the distal joint being spiniform, and projecting a little beyond the inner ramus.

The telson (fig. 11) is remarkable from its large size, as it exceeds half the length of the urosome. It is narrow lanceolate in form, and cleft nearly to

the base by a very narrow fissure. Each of the lateral halves terminates in a very acute point, and exhibits a row of about 7 small sub-marginal denticles.

The colour in the living state of the animal, according to notes of Dr. Nansen, is bright red, with somewhat darker eyes.

Occurrence. Several specimens of this interesting Amphipod were taken on the 23rd and 24th April, 1894, at about the 80th degree of latitude, clinging to the sounding-line, the latter having been lowered to a depth of between 500 and 1000 metres. As in every instance the specimens were found on the lower part of the line, at only a short distance from the water-bottle, it must be assumed that they in reality occurred in the deepest strata, near the bottom.

A single specimen was also found in a sample taken a little farther south, on the 23rd March same year, the tow-net having been lowered to 300 meters. Finally, the same form occurred in a sample taken on the 4th February, 1896, in a place lying much farther west, and north of the 85th degree of latitude, the tow-net having in this instance been lowered to only 100—130 metres. By far the greater number of the specimens caught here were, however, of rather small size, only 2 of them being apparently fully grown. From its occurrence in this place, it must be inferred that this Amphipod is not strictly a bottom-form, but, like the species of the genus *Pseudalibrotus*, sub-pelagic in habits, though at times descending to very great depths.

Distribution. Off the Lofoten Islands, taken by the aid of the bow-net ('nasse'), in a depth of 1095 metres (Expédition du Prince de Monaco).

Gen. *Pseudalibrotus*, Della Valle.

Syn: *Alibrotus*, G. O. Sars (not M.-Edw.).

Remarks. This genus was proposed by Signor Della Valle in his great works on the Gammarids of the Gulf of Naples, to include the well-known arctic species *Anonyx littoralis* of Kröyer, which I had erroneously referred to the genus *Alibrotus* of Milne-Edwards. In addition to the above-named arctic form, 2 new species of this genus have been recently described by the present author from the Caspian Sea, both belonging to the collection of Dr. O. Grimm. I have now to report 2 additional species, found in the material collected during Nansen's North Polar Expedition, both of

which are quite distinct from the previously known arctic form, *P. littoralis*, but, on the other hand, are so closely related to the 2 Caspian species, that I am much inclined to regard them as the primitive forms from which the latter are descended.

6. *Pseudalibrotus Nanseni*, n. sp.

(Pl. IV, V).

Specific Characters. Body comparatively robust, with broadly rounded back. Cephalon with the lateral lobes rather prominent and angular at the tip; postantennal angle well marked. Eyes of moderate size, oval, somewhat contracted above. 1st pair of coxal plates but slightly expanded, and obtusely truncated at the tip. The 2 posterior pairs of epimeral plates of metasome acutely produced behind. 1st segment of urosome with a distinct saddle-like depression dorsally. Antennæ rather slender and elongated, especially in the male, flagellum of both pairs in the latter provided with well developed calceolæ, accessory appendage of the superior ones 4—5 articulate. Anterior gnathopoda somewhat smaller than in the type species; posterior ones with the propodal joint transversally truncated at the tip, carrying the small dactylus about in the middle of the terminal edge. The 3 posterior pairs of pereopoda much less slender than in the type species, with the basal joint very large and lamellar, oblong oval in form, and coarsely serrate behind; last pair considerably shorter than the preceding pair, with the outer part scarcely more than half the length of the basal joint. Last pair of uropoda comparatively short, scarcely reaching beyond the others, structure about as in *P. littoralis*. Telson rather large, reaching to the end of the basal part of the last pair of uropoda, rounded quadrangular in form, tip slightly insinuated. Length of adult male about 20 mm.

Remarks. This species is easily distinguishable from *P. littoralis* by its more robust form, and more especially by the structure of the posterior pairs of pereopoda, the outer part of which is remarkably short in proportion to the basal joint. It more resembles the Caspian species, *P. platyceras* (Grimm), to which, indeed, I believe it stands in direct genealogical relation, although, on a closer comparison, several differences may be found between them, which make it necessary to keep the two species apart. I propose to name

this form in honour of Dr. Nansen, who also took special notice of it during the Expedition.

Description.

The largest specimens in the collection have a length of about 20 mm., and this is accordingly a rather large-sized form, considerably exceeding in size the type species, and about equalling in this respect the Caspian species, *P. platyceras* (Grimm).

The form of the body (see Pl. IV, fig. 1), as compared with that of *P. littoralis*, is rather more robust and less compressed, the back being broadly rounded and perfectly smooth throughout. In the adult male, the posterior division of the body, comprising the metasome and urosome, is fully as long as the anterior; but this is scarcely the case in the female, in which the metasome is less powerfully developed.

The cephalon is comparatively short, not nearly as long as the first 2 segments of the mesosome combined, and has the lateral lobes rather prominent and distinctly angular at the tip (see also fig. 2). The lower edges are deeply emarginated, to encompass the globular basal joint of the inferior antennæ, and behind the latter they project in an acute angle, the postantennal corner.

The segments of the mesosome gradually increase in size posteriorly, none of them being, however, as large as the segments of the metasome. The 4 anterior pairs of coxal plates are considerably deeper than the corresponding segments, and not very different in size. The 1st pair, however, are a little broader than the 2 succeeding ones, and slightly expanded distally, with the tip transversely truncated (see also fig. 14). The 4th pairs, as in the other species of this genus, are narrower than in most other *Lysianassidæ*, and but very slightly emarginated behind. The 3 posterior pairs of coxal plates are rather large, though somewhat less deep than the anterior, and are rounded quadrangular in form, gradually diminishing somewhat in size posteriorly.

The epimeral plates of the metasome are well developed, the 1st pair being rounded, whereas the 2 posterior pairs are each drawn out behind to an acute point.

The urosome is scarcely half as long as the metasome, and exhibits dorsally, at the base of the 1st segment, a well-marked saddle-like depression.

The eyes (see figs. 1 & 2) are clearly distinguishable, though their pigment, which originally has undoubtedly been of a light red colour, has become absorbed in the specimens by the action of the alcohol. They are of moderate size, and irregularly oval in form, being somewhat contracted in their upper part. The visual elements seem to be normally developed.

The antennæ, as in the other species of this genus, have the flagella more produced than is usually the case in the present family. They are rather more slender in the male than in the female (*conf.* figs. 1 and 2); but the relative length of both pairs is approximately the same in the two sexes, the inferior one being a little longer than the superior. In the male, the latter (see figs. 1, 3) are about the length of the whole mesosome, and have the peduncle very thick and massive, with the 2 outer joints, as usual, very short. The flagellum is composed of numerous articulations, amounting to about 50 in all, the 1st being very large and tumid, and clothed inside with numerous sensory hairs, arranged in 2 sets. The succeeding articulations each carry at the hind edge a well developed calceola of exactly the same structure as those on the inferior antennæ (figs. 6, 7). The accessory appendage exceeds half the length of the peduncle, and is composed of 5 articulations, the 1st being much the largest.

The inferior antennæ (fig. 4) have the basal joint globular and wholly exposed (*conf.* fig. 2). Of the 4 remaining joints of the peduncle, the penultimate is the largest, and is clothed on both edges with short bristles. The flagellum in the male is extremely slender and fully 3 times as long as the peduncle, being composed of about 60 articulations, which are provided anteriorly with well developed calceolæ, arranged alternately (see fig. 5). When viewed under a high magnifying power, each calceola (see figs. 6, 7) is found to consist of a short peduncle carrying at the end an oboval, slightly concave sucking disc, which extends somewhat obliquely and terminates in a very thin and hyaline, spatulate rim.

In the female, as above stated, both pairs of antennæ (see fig. 2) are somewhat shorter, and no trace of calceolæ is found on the flagella, which, moreover, are composed of a smaller number of articulations.

The buccal mass is more or less completely concealed laterally by the anterior coxal plates, so that only the mandibular palps and the maxillipeds are partly exposed (see fig. 1).

The anterior lip is simple, rounded, and the epistome not projecting.

The posterior lip (fig. 8) has the lateral lobes narrowed in front, and slightly bilobular at the tip, each being produced behind to a conical process.

The mandibles (figs. 9, 10) are very strong, with the masticatory part somewhat incurved and divided into a narrowly truncated cutting part, and a short, but distinctly prominent molar expansion, exhibiting at the tip a finely fluted triturating surface. The palp (see fig. 9) is greatly developed, considerably exceeding the body of the mandible in length, and has the last joint falciformly curved.

The anterior maxillæ (fig. 11) exhibit the usual structure. The masticatory lobe is rather prominent, and carries at the tip several strong spines, the inner edge being covered with fine hairs, and moreover armed with from 3 to 4 somewhat smaller spines. The basal lobe is comparatively small, with only 2 plumose setæ at the tip. The last joint of the palp is but slightly dilated and is, as usual, denticulated at the tip.

The posterior maxillæ (fig. 12) have the inner lobe rather small, scarcely more than half as large as the outer, both exhibiting the usual dense clothing of setæ.

The maxillipeds (fig. 13) on the whole agree in structure with those in the other species of the genus. The masticatory lobes are not very large, scarcely reaching beyond the middle of the penultimate joint of the palp, and are oval in form, with the inner edge minutely serrate. The basal lobes are narrowly truncated at the tip, and carry the usual setæ. The palps are rather large, with the joints somewhat expanded and densely setiferous.

The anterior gnathopoda (fig. 14) are somewhat less strong than in the type species, with the outer part scarcely longer than the basal joint. The propodos is about the length of the 2 preceding joints combined, and is obliquely truncated at the tip, exhibiting a well defined palm, which is armed at the inferior corner with several strong denticles.

The posterior gnathopoda (Pl. V, fig. 1) differ from those in the type species chiefly in the propodos being somewhat broader and more transversely truncated at the tip, with the lower corner scarcely at all produced.

The 2 anterior pairs of pereopoda (figs. 2, 3) are quite normal in structure.

The 3 posterior pairs (figs. 4, 5, 6) are, however, distinguished by the large size of the basal joint, as compared with the terminal part. The last pair (fig. 6) especially, look rather different from those in the other known species, being considerably shorter than the preceding pair, with the terminal part not exceeding even half the length of the basal joint. The latter is very large, laminar, and oblong quadrangular in form, with the infero-posteal corner produced to an obtusely rounded lobe. The posterior edge of this joint in all 3 pairs is coarsely serrate throughout.

The branchial lamellæ (see figs. 1—5) are rather large, but quite simple in structure, without any lateral lobes. They are wanting on the last pair of legs (fig. 6).

The 2 anterior pairs of uropoda (figs. 9, 10) have the rami quite simple, and mucronate, whereas in the type species, as shown by the present author, the inner ramus of the 2nd pair is peculiarly transformed.

The last pair of uropoda (see figs. 8, 11) are comparatively short, scarcely reaching beyond the others. In structure they resemble those in the type species, both rami, but especially the outer one, being fringed with ciliated setæ in addition to the spinules.

The telson (see figs. 8, 12) is rather large, laminar, and reaches to about the end of the basal part of the last pair of uropoda. It is rounded quadrangular in form, and slightly narrowed distally, with the terminal edge distinctly insinuated in the middle, and armed on each side with a minute denticle.

Occurrence. Some adult specimens of this form, chiefly of the male sex, were collected during the months March and April, 1894, in about 80° latitude, north of the New Siberian Islands. The specimens seem not to have been taken by the aid of the tow-net, but on bait hung down from the ship. Moreover, some young specimens of this species occurred in a sample taken on the 4th February, 1896, and much farther west, near the 85th degree of latitude.

7. *Pseudalibrotus glacialis*, n. sp.

(Pl. VI).

Specific Characters. Body somewhat less robust than in the preceding species, and more compressed, with the back evenly rounded. Cephalon with the lateral lobes distinctly angular at the tip; eyes oval, with the visual elements sometimes distinct, at others imperfectly developed. Anterior pairs of coxal plates deeper than the corresponding segments; 1st pair rather broad and expanded, with the antero-lateral corner rounded off; 5th pair more than twice as large as the last. The 2 posterior pairs of epimeral plates of metasome acut-angular behind. Urosome slightly depressed at the base dorsally. Antennæ comparatively shorter than in the preceding species, scarcely exceeding half the length of the mesosome, flagella of both pairs composed of a smaller number of articulations, accessory appendage of the superior ones 3-articulate. Anterior gnathopoda about as in the preceding species; posterior ones, however, differing in the propodos being obliquely truncated at the tip, with the lower corner produced, so as to form, with the extremely small dactylus, a minute chela. The 3 posterior pairs of pereopoda somewhat less robust than in the preceding species, with the terminal part more produced; last pair scarcely shorter than the preceding pair, with the basal joint rather broad in proportion to its length, and but little longer than the terminal part. Last pair of uropoda comparatively short, not projecting beyond the others, inner ramus considerably shorter than the outer, with only a single denticle inside, both rami without any marginal setæ. Telson rounded quadrangular in form, and but very slightly narrowed distally, terminal edge scarcely at all insinuated. Length about 9 mm.

Remarks. This species is nearly related to the preceding one, but is of much smaller size, and moreover easily distinguished by the different form of the anterior pair of coxal plates, the much shorter antennæ, and the less shortened terminal part of the last pair of pereopoda. The posterior gnathopoda, too, terminate in a somewhat different manner, and the structure of the last pair of uropoda and of the telson is also somewhat different. In all these characters, it approaches still nearer to the Caspian species, *P. caspius* (Grimm), and in my opinion, it ought, indeed, to be regarded as the primitive form, from which this species has descended. Yet on a closer comparison,

there are to be found some minor differences between these two forms, so that it will be advisable to keep them apart.

In the material collected during the Nansen Expedition, there are two distinct varieties, the one with the eyes normally developed and probably, in the fresh state, provided with light red pigment, the other with the visual elements imperfectly developed, and the pigment of a whitish colour. A specimen of the latter variety, which may be named *var. leucopis*, is represented on Pl. VI fig. 10. Both these forms agree in other respects completely, and were also found together in the same samples.

Any more detailed description of this species, I do not consider it necessary to give here.

Occurrence. Numerous specimens of this form occurred in two samples taken on the 4th and 13th February, 1896, near the 85th degree of latitude, the tow-net having been lowered to from 50 to 130 metres. Moreover, two specimens were found in another sample taken on the 21st February, 1894, much farther east.

Fam. PARAMPHITHOIDÆ.

8. *Paramphithoë brevicornis*, G. O. Sars,

The anterior half of a specimen of this form was found in a sample taken on the 4th February, 1896, near the 85th degree of latitude.

Distribution. Coast of Finmark, Spitsbergen.

Fam. AMPELISCIDÆ.

9. *Hoploöps tubicola*, Lilljeborg.

Two specimens of this well-known form were found in a bottle containing different bottom-animals taken by the aid of the trawl on the 30th October, 1893, at some distance north of the New Siberian Islands, the depth being 90 metres.

Distribution. Coast of Norway, British Isles, coast of France, Kattegat, the Baltic, Greenland, Labrador, Iceland, Spitsbergen, the Barents Sea, the Kara Sea.

10. *Haploöps setosa*, Boeck.

A single specimen of this species was taken in the same haul as the preceding one.

Distribution. Coast of Norway, Greenland, the Kara Sea, Iceland, the Barents Sea, Beeren Eiland, Spitsbergen.

Fam. STENOTHOIDÆ.

11. *Metopa longicornis*, Boeck.

This species occurred in 4 samples, 2 of which were taken on the 13th and 24th October, 1893, at the beginning of the drifting of the 'Fram', the other 2 on the 4th and 13th February, 1896, much farther west, and near the 85th degree of latitude. The specimens were accordingly taken by the aid of the tow-net, which was lowered to a depth of from 20 to 100 metres.

Distribution. Coast of Norway, Greenland.

Fam. EUSIRIDÆ.

12. *Eusirus cuspidatus*, Krøyer.

A single young specimen of this arctic form was found in a sample taken on the 19th April, 1894, north of the New Siberian Islands, the tow-net having been lowered to a depth of 40 metres.

Distribution. Coast of Finmark, Greenland, Spitsbergen.

13. *Eusirus Holmi*, Hansen.

Of this species, recently described by Dr. Hansen from the Kara Sea, there are 3 specimens in the collection, 2 of them being found in a sample taken 26th March to 4th April, 1895, the 3rd in another sample taken on the 4th February, 1896, the tow-net having been lowered to a depth of from 100 to 130 metres.

Distribution. The Kara Sea, Stat. 18 and 124 of the Norw. North Atl. Exped. (recorded as *E. cuspidatus*).

Fam. CALLIOPIDÆ.

14. *Amphithopsis glacialis*, Hansen.

This form, first described by Dr. Hansen from Greenland specimens, occurred in no less than 9 different samples, taken along nearly the whole

route of the 'Fram'. The specimens are all more or less mutilated, owing to the great fragility of the appendages, and this was also the case with the Greenland specimens examined by Dr. Hansen. It appears somewhat doubtful, whether this form should in reality be referred to the genus *Amphithopsis* of Boeck.

Distribution. Greenland, the Kara Sea.

Fam. GAMMARIDÆ.

15. *Gammarus locusta*, Lin.

var. *mutata*, Lilljeb.

Numerous specimens of this form, some of a very large size, were collected in several places along the eastern part of the route of the 'Fram'. It also occurred in 2 samples taken in the western part of the route, on the 4th and 13th February, 1896.

Distribution. Coast of Finmark, Greenland, Iceland, Spitsbergen, Franz Joseph Land, the Kara Sea, Labrador.

16. *Amathilla pingvis* (Krøyer).

A solitary specimen of this form was found in a sample taken on the 21st March, 1894, the tow-net having been lowered to a depth of 300 metres.

Distribution. Greenland, Spitsbergen, the Kara Sea.

ISOPODA.

Tribe: EPICARIDA.

Several larvæ of *Epicarida*, chiefly in the last (Cryptoniscian) stage, were found in the samples taken north of the New Siberian Islands. Among them could be determined: 1) larvæ of *Dajus mysidis*, Krøyer, both in first and last stages, 2) the Cryptoniscian larva first described by the Rev. M. Stebbing from the marsupial pouch of an *Onesimus plautus* taken in the Barents Sea, and subsequently found under similar circumstances by the present author off the Norwegian coast, 3) another larva (in the Cryptoniscian stage), closely related to the larva of *Asconiscus simplex*, G. O. Sars.

*COPEPODA.*Tribe: **CALANOIDA.**Division: *AMPHASKANDRIA.*Fam. **CALANIDÆ.**¹1. *Calanus finmarchicus* (Gunner.).

This well-known and widely-distributed species is also by far the commonest of all the Copepoda in the North Polar Basin explored by the 'Fram' Expedition, forming, indeed, in all the samples, the great bulk of the contents.

Distribution. Throughout the Arctic Ocean, coast of Norway, the Baltic, British Isles, Atlantic coast of Europe, Mediterranean, Black Sea, North Atlantic Ocean, Pacific Ocean.

2. *Calanus hyperboreus*, Kröyer.

This form also occurred in almost all the samples, being easily recognized by its large size, which is more than twice that of *C. finmarchicus*.

Distribution. Throughout the Arctic Ocean, coast of Norway as far south as the Christiania Fjord, but here confined to greater depths.

Fam. **SCOLECITHRICIDÆ.**Gen. *Scaphocalanus*, n.

Generic Characters. Cephalic segment coalesced with the 1st pedigerous segment, and in female distinctly carinated dorsally, exhibiting in front an elevated rounded crest, rostral filaments small, but distinct. Last pedigerous segment well defined, though rather small. Tail in female 4-articulate, with the last (anal) segment short, in male 5-articulate, with the 2nd segment large and tumefied. Caudal rami short, with 5 marginal setæ, the innermost but one much longer than the others. Anterior antennæ 23-articulate, the 1st, 2nd and 8th articulations much larger than the others; those in male only 20-articulate and very slender, with large sensory appendages along the proximal part. Posterior antennæ with the outer ramus shorter than the inner, and 6-articulate. Mandibles with the masticatory part rather produced, cutting

¹ The families here recorded answer to the respective sub-families of Dr. Giesbrecht.

teeth densely crowded together, and all of the same appearance, bidentate at the tip, palp with the outer ramus exceedingly large. Maxillæ with the masticatory lobe prominent and tipped with slender spines. Anterior maxillipeds comparatively short, with the anterior lobes densely crowded together, terminal sensory appendages very delicate, simple, and of comparatively small size. Posterior maxillipeds slender, with the terminal part reflexed and carrying long, slender setæ. Oral parts in adult male greatly transformed, and, excepting the mandibular palps, much reduced. Natatory legs powerfully developed, inner ramus of 1st pair uniarticulate, of 2nd pair biarticulate, of 3rd and 4th pairs 3-articulate, both rami, except in 1st pair, with irregular transverse rows of spinules behind. Last pair of legs in female very small, 3-articulate, terminal joint fusiform, with 3 spines, the innermost much elongated; those in male very large, with both legs biramous.

Remarks. This new genus is allied to the genus *Scolecithrix* of Brady, and undoubtedly belongs to the sub-family *Scolecithricinæ*, as defined by Dr. Giesbrecht, and here taken in the sense of a true family. It differs, however, from any of the 3 genera hitherto comprised in this family, in the strongly marked cephalic crest, which gives the anterior division of the body a pronouncedly navicular form: hence the generic name here proposed. Moreover, the structure of the last pair of legs in both sexes is somewhat different, and the sexual dimorphism is on the whole more prominent than in any of the other genera. The genus as yet only comprises a single species, which, however, is one of the most characteristic Calanoids of the Polar Sea. It will for this reason be described at some length in the following pages.

3. *Scaphocalanus acrocephalus*, n. sp.

(Pl. VII, VIII, IX).

Specific Characters. — *Female.* Anterior division of body oblong oval, tapering anteriorly, pronouncedly boat-shaped, with the united cephalic and 1st pedigerous segments more than twice as long as the remaining part, cephalic crest projecting considerably in front of the rostral prominence, and narrowly rounded. Last pedigerous segment with the lateral parts obtusely produced behind. Tail about $\frac{1}{3}$ as long as the anterior division, with the genital segment shorter than the two succeeding segments combined, and but

slightly protuberant below. Caudal rami scarcely twice as long as they are broad, and obliquely rounded at the end, 3 of the marginal setæ issuing from the tip, 2 from the outer edge, middle apical seta almost twice the length of the tail. Anterior antennæ slightly exceeding in length the anterior division of the body, the 8th articulation about the length of the 2nd, last one very small. The 3 posterior pairs of natatory legs with the outer ramus very large, and having the terminal spine coarsely denticulate outside. Last pair of legs with the 2nd joint rather short, but distinctly defined, inner spine of last joint twice as long as the apical one, and minutely denticulate outside. Length of body, exclusive of the caudal setæ, about 5 mm.

Male. Anterior division of body less regularly navicular, being abruptly contracted in front, with the cephalic crest obsolete. Last pedigerous segment very small, with the lateral parts somewhat extant. Tail exceeding half the length of the anterior division, 1st segment quite short, 2nd very large, fully as long as the 2 succeeding ones combined; caudal rami mobile, and, as a rule, spread out to each side, marginal setæ less fully developed than in female. Anterior antennæ comparatively shorter than in female, with the outer half exceedingly slender, proximal part with the joints partly lamellarly expanded, and clothed in front with very large sensory appendages. Posterior antennæ and mandibular palps very powerfully developed; oral parts otherwise very much reduced. Last pair of legs about the length of the natatory legs, and rather complicated in structure, 1st basal joint of both legs coalesced, 2nd basal joint of left leg simple cylindric, that of right leg much shorter, but very broad, rami of both legs slender, styliform, the outer one 3-articulate, the inner uniarticulate. Length of body $4\frac{1}{2}$ mm.

Remarks. The sexual dimorphism of this Calanoid is so very great, that it was only after some time that I could convince myself that the remarkable form figured in Pl. IX is in reality the adult male of that represented in Pl. VII and VIII. At a younger stage, on the other hand, the male resembles the female very closely, and it is accordingly only in the fully adult, or sexually mature state that this remarkable transformation takes place. It would appear from the greatly reduced oral parts, that the existence of such transformed male individuals is restricted to a very short period, and indeed, only a few specimens were found, whereas females and young males occurred very plentifully in the samples examined.

Description of the Female.

(Pl. VII, VIII).

The length of fully adult specimens, measured from the front to the end of the caudal rami, amounts to about 5 mm., and this form is accordingly very much larger than any of the previously described species belonging to this family.

The body (see Pl. VII, figs. 1 & 2), as in other Calanoids, has the anterior division very sharply marked off from the posterior, and of much larger size, exhibiting an oblong oval, or more properly navicular form, the greatest width occurring rather behind the middle. This division is composed of 5 segments, the foremost of which is more than twice as long as all the others combined, and more properly represents 2 coalesced segments, the cephalic and 1st pedigerous ones. Anteriorly this segment is gradually narrowed, and is surmounted in front by a very conspicuous median crest, appearing, in a lateral view of the animal (fig. 2), as a narrowly rounded, helmet-shaped expansion, projecting considerably beyond the rostral prominence. The latter is but very slight, and carries at the tip 2 very small tentacular appendages. From this prominence, on each side, a distinctly marked, somewhat flexuous line is seen extending obliquely back as far as the base of the posterior maxillipeds, where it abruptly curves straight backwards. As far as these lines are oblique, they constitute the inferior edges of the cephalic part of the segment, and below them the soft ventral face is somewhat protuberant, exhibiting, about in the middle, the oral aperture, and on each side the antennæ and the several oral appendages. The remaining part of the segment is somewhat shorter than the cephalic part, but still nearly as long as all the exposed pedigerous segments combined. Of these the 3 anterior slightly diminish in size, whereas the last is very small and imperfectly defined from the preceding one. In the middle, this latter segment is deeply emarginated, the lateral parts projecting behind as obtuse protuberances.

The posterior division of the body, or the tail, is scarcely more than $\frac{1}{3}$ the length of the anterior, and is very much narrower, subcylindric in form. It is composed (see fig. 9) of 4 well-defined segments, the 1st of which, or the genital segment, is much the largest, though shorter than the 2 succeeding ones combined. It is somewhat dilated in front, and forms below a slight protuberance, carrying the genital opening. Of the succeeding segments, the

penultimate one is but little smaller than the preceding segment, whereas the last, or anal segment is very short. The caudal rami, or furca, are likewise rather short, being scarcely twice as long as they are broad. They are finely ciliated inside, and obliquely rounded at the end, each carrying 5 densely plumous setæ. Of these the 2 outer are attached to distinct ledges outside the tip, whereas the remaining 3 originate from the tip itself. The middle apical seta, or the innermost but one, is much longer than the others, and may attain to twice the length of the tail. As, however, these setæ are very brittle, it is rather unusual to find specimens in which they are quite perfect. In addition to the above-mentioned caudal setæ, a very delicate unciliated bristle is found, as usual, on each of the rami, originating from the inner corner, and lying above the others.

No trace of eye could be detected in the alcoholic specimens; but it is very probable that in reality it is present in the fresh state of the animal, though of very simple structure, and easily destructible by the action of the alcohol.

The anterior antennæ (see figs. 1 & 2) slightly exceed in length the anterior division of the body, and are rather slender, gradually tapering somewhat distally. They are composed (see Pl. VIII, fig. 1) of 23 articulations, carrying in front scattered bristles of somewhat unequal length. As the normal number of articulations in the Calanoids is 25, a fusion of some of the articulations may be supposed to have taken place. It will also be found, that 2 of the articulations, viz., the 2nd and the 8th, are of unusual size and may both originally have represented 2 articulations. This being admitted, the full number of articulations is made up. The penultimate articulation is somewhat longer than the next preceding ones, and carries at the end, both in front and behind, a rather strong seta. The last articulation is extremely small, and is connected with the former along an oblique suture. It is provided at the tip with a fascicle of comparatively short bristles.

The posterior antennæ (fig. 2) are, as usual, each composed of a short biarticulate basal part, and 2 differently formed rami. The distal joint of the basal part is considerably larger than the proximal one, and carries at the end anteriorly, 2 slender ciliated setæ. The inner ramus is composed of 2 joints, the 1st long and narrow, linear in form, and carrying at some distance from the tip anteriorly, a single slender seta, the 2nd short, slightly bilobular

at the tip, and carrying about 14 long setæ arranged in a flabelliform manner. The outer ramus, which is very mobile, is somewhat shorter than the inner, and is cylindric in form. It is composed of 6 joints, the 2nd and last of which are the largest, the 3 joints lying between them being very short. This ramus carries 3 exceedingly long and finely plumose apical setæ, and 4 lateral ones of the same structure, the outermost of which, however, is rather short.

The oral aperture (see Pl. VII, fig. 3) is bounded in front by a rather voluminous, flap-shaped anterior lip, and behind by a much smaller bilobular posterior lip, both being to some extent finely ciliated on the edges turned towards the mouth.

The mandibles (see Pl. VIII, figs. 3, 4) have the masticatory part rather produced, but only slightly expanded distally, with the cutting teeth densely crowded together, and bidentate at the tip, the outer one not, as is usually the case, differing from the others. The palp is very fully developed, being rather larger than the body of the mandible, and, like the posterior antennæ, is composed of a biarticulate basal part, and 3 unequal rami. The 1st basal joint is very small and easily overlooked, whereas the 2nd is large and broad, slightly widening distally, and provided inside with a single small bristle. The inner ramus is very short and composed of 2 joints of about equal size, the last carrying at the tip about 8 slender setæ spread in a fan-like manner. The outer ramus is very greatly developed, being more than twice as long as the inner, and rather thick, fusiform in shape. It is divided into 5 well defined joints, the last of which, however, is so very small, as easily to escape attention. This ramus carries 6 extremely strong and elongated plumose setæ, 2 issuing from the last joint, and a single one from each of the preceding joints. The setæ gradually increase in length proximally, that issuing from the 1st joint being from 8 to 10 times as long as the ramus itself.

The maxillæ (fig. 5) have the masticatory lobe narrowly produced, and clothed with unusually slender spines. The opposite vibratory plate carries 8 plumose setæ, the outermost of which is shorter than the others. The remaining part of the maxilla is very delicate, membranous, and divided into 4 setiferous lobes, the 2 terminal ones more properly answering to the 2 rami in the posterior antennæ and mandibular palp. Of these 2 lobes, only the outer one is distinctly defined at the base, forming an oval, mobile lamella, edged with 7 curved setæ.

The anterior maxillipeds (fig. 6) are comparatively small, and apparently each composed of 6 joints, the 1st of which is more than twice as large as all the others combined. Anteriorly, these maxillipeds exhibit 5 digitiform lobes, closely crowded together, and tipped with long, coarsely ciliated, and partly spiniform setæ. The setæ issuing from the 2 outer, extremely small joints are transformed, as in the other forms belonging to this family, into very delicate sensory appendages. In the present form, these appendages are 5 in number, and of inconsiderable size and simple structure.

The posterior maxillipeds (fig. 7) form each a slender, doubly geniculate stem composed of 7 joints, the first 2 of which are much larger than the others, and together constitute the basal part. The 1st basal joint is somewhat lamellarly expanded, and carries anteriorly 6 ciliated setæ. The 2nd basal joint is about the same length as the 1st, but much narrower, and forms with it an elbow-shaped bend. It carries posteriorly 3 ciliated setæ, and at the end 2 similar setæ placed close together. The 5 succeeding joints constitute together the terminal part, which is very flexible and, as a rule, recurved. It is clothed posteriorly with numerous very slender setæ, increasing in length distally, the outermost almost equalling the whole maxilliped in length.

The natatory legs are powerfully developed, though the 1st pair, as usual, are considerably smaller than the 3 succeeding ones. In all of them, the inner ramus is much smaller than the outer, which is 3-articulate and in the 3 posterior pairs very large, with the joints lamellarly expanded.

The 1st pair of legs (Pl. VII, fig. 4) are not only much smaller than the others, but also of rather different structure. The 1st basal joint does not exhibit any trace of the strong plumose seta found on the inner side of all the other pairs. On the other hand, inside the end of the 2nd basal joint, there is a slender, flexuous seta, not found in the other pairs. The outer ramus is scarcely longer than the basal part, and has the 1st joint quite simple, without any spine or setæ. The 2nd joint, on the other hand, has outside at the end a very small spine, and inside a natatory seta. The last joint is but little larger than the 2nd, and is somewhat curved outwards. It carries inside 4 natatory setæ, and at the tip a comparatively small spine; its outer edge on the other hand, is without spines, exhibiting only a fine ciliation. The inner ramus is scarcely half as long as the outer, and consists of only a single joint, though an abrupt indiction of the outer edge seems to indicate

an attempt at a subdivision. It carries 5 natatory setæ, 2 of which issue from the tip, the other 3 from the inner edge.

The 2nd pair of legs (fig. 5) are much larger than the 1st, and have the outer ramus nearly twice as long as the basal part. The 1st joint of this ramus, however, is comparatively small, and is much constricted at the base, carrying outside a well developed spine, and inside a natatory seta. The 2nd joint is large and expanded, and likewise provided outside with a strong spine, inside with a natatory seta. The last joint is still larger, being fully as long as the other 2 combined, and it carries outside 3 strong spines attached to distinct ledges on the margin, inside, 4 natatory setæ, and at the tip an exceedingly strong, mucroniform spine, coarsely denticulate outside. The inner ramus is scarcely more than half as long as the outer, and is composed of 2 well defined joints, the 1st rather small, and carrying inside a single natatory seta, the last oblong fusiform, and provided with 5 natatory setæ, 2 of which issue from the tip, 2 from the inner edge, and one from the outer.

The 2 succeeding pairs of legs (Pl. VII, fig. 6, Pl. VIII, fig. 8) resemble in structure the 2nd pair, but are still larger, and have the inner ramus distinctly 3-articulate, with one natatory seta more than in that pair. The terminal joint of the outer ramus is, moreover, somewhat larger, considerably exceeding in length the other 2 combined. In all the pairs except the 1st, several transverse rows of small spinules are observed on the hind face of the rami. These spinules are especially conspicuous on the inner ramus, where they are arranged in 3 or 4 oblique rows.

The 5th pair of legs (Pl. VII, fig. 7) are very small and simple in structure, somewhat resembling those in the genus *Scolecithrix*. They are, however, less rudimentary, each leg being composed of 3 distinct joints, whereas in the above-named genus, these legs are biarticulate, or altogether wanting. The basal joints of both legs are united in the middle, constituting a common broad basal part. The 2nd joint is rather small, but well defined from both the basal and terminal joints. The last joint is oblong fusiform in shape, and carries 3 unequal spines, one apical and 2 lateral. Of the latter, that issuing from the inner edge is very much elongated and extended obliquely inwards, so as to meet the corresponding spine of the other leg. It is finely denticulate outside, whereas the other spines are quite smooth, that of the outer edge being also very small.

In young, not yet sexually mature males, this pair of legs (fig. 8) are likewise very small, but rather different in structure from those in the female, and more resembling in this respect the natatory legs. As in the latter, each leg is composed of a distinctly biarticulate basal part and 2 unequal rami, the inner uniaarticulate, the outer biarticulate. The rami do not, however, carry any natatory setæ, and there are also only very slight traces of spines to be detected. Both legs exhibit a soft cellular structure, and are still only very slightly chitinized, indicating that they are as yet imperfectly developed, and there is but little difference between them, whereas in the sexually mature state, as will be shown below, these legs are very unequal.

Description of the Sexually Mature Male.

(Pl. IX).

The length of the body does not, in any of the specimens found, exceed $4\frac{1}{2}$ mm.

The general form (see figs. 1 & 2) is very different in appearance from that of the female, both as regards the anterior and posterior divisions.

The former is less pronouncedly navicular in form, on account of the absence of the cephalic crest. Seen dorsally (fig. 1), it is abruptly contracted anteriorly, with the front obtusely truncated, not, as in the female, sharply pointed (comp. Pl. VII, fig. 1); and posteriorly it is but very slightly narrowed. The last segment is extremely small, and more broadly emarginated than in the female, with the lateral parts much less produced behind.

The tail is comparatively larger than in the female, considerably exceeding half the length of the anterior division, and is composed of 5 well defined segments. Of these the 1st is very small and greatly constricted at the base, whereas the 2nd segment is of unusually large size and considerably tumefied, equalling in length the 2 succeeding ones combined. The last, or anal segment, as in the female, is very short. The caudal rami, which in the female are quite immobile, have here a very mobile articulation with the last segment, allowing of their being considerably spread out to each side (see fig. 1). The caudal setæ, too, are less fully developed than in the female, though apparently present in the same number; and in all the specimens examined, they were widely divergent.

The superior antennæ (fig. 4) are comparatively somewhat shorter than in the female, scarcely exceeding in length the anterior division of the body; and they are composed of only 20 articulations. The two antennæ are exactly alike, both having the proximal half clothed in front with strongly developed sensory appendages, in addition to the bristles. Some of the joints of this part, moreover, have assumed a lamellar appearance, especially the third one; and the 8th joint is still more elongated than in the female, and is apparently constituted of 3 coalesced joints. The distal half of the antennæ is very narrow and, as a rule, forms with the proximal half a slight, angular curve.

The posterior antennæ are of the same structure as in the female, but are comparatively more powerfully developed.

The oral parts, on the other hand, are rather unlike those in the female, being in some respects much reduced.

The mandibles (fig. 5) have the masticatory part very poorly developed, whereas the body itself is comparatively larger and broader than in the female. This is also the case with the palp, which is much more robust than in the female, with the basal part very broad and muscular.

The maxillæ (fig. 6), though exhibiting a structure similar to that in the female, are rather smaller, and have both the masticatory lobe and the vibratory plate less fully developed.

The anterior maxillipeds (fig. 7) are extremely small and rudimentary, only with great difficulty permitting of any close examination.

The posterior maxillipeds (fig. 8) are likewise much feebler in structure than in the female, and have some of the outer setæ recurved and densely plumous.

The natatory legs (figs. 9, 10), on the other hand, agree exactly, both in size and structure, with those in the female.

The last pair of legs (fig. 11), as is usual in male Calanoida, are peculiarly transformed and prehensile in character. They are rather large, scarcely smaller than the natatory legs, and the development of the 2 legs is very unequal, though both exhibit the same chief parts, viz, a biarticulate basal part, and 2 styliform rami, the outer of which is 3-articulate, the inner uni-articulate. The 1st basal joints of the 2 legs are partly coalesced, and the 2nd is very different in the 2 legs. In the right leg it is simple cylindric, and projects far beyond that of the left leg. The 2 rami of this leg are

of about equal length, both issuing close together from the end of the basal part, and curving inwards. The 3 joints of the outer ramus gradually diminish in size, the last being rather small and lamelliform, with several small spines inside, and 2 somewhat longer setæ at the tip. The inner ramus terminates in a hook-shaped point. In the left leg, the 2nd basal joint is quite short and of irregular form, encompassing the end of the 1st basal joint of the right leg. The 2 rami are of very unequal length, and issue far apart, the outer one being twice as long as the inner, and having the 1st joint longer than the other 2 combined. This joint originates with a broad base, but rapidly contracts, and projects at the end inside to a small linguiform lobe, its 2 outer joints being very narrow and quite smooth. The inner ramus is simple styli-form, terminating in an acute point.

The musculature of the body is much stronger than in the female, and the movements of the animal must therefore be assumed to have been rather more powerful. The muscles converging from the dorsal face to the posterior antennæ and mandibular palps are especially conspicuous, exhibiting a peculiar opalescent lustre; and the muscles acting upon the tail are also unusually strong.

Occurrence. It is very strange that this large and conspicuous Calanoid has hitherto quite escaped the attention of zoologists, though it seems to be one of the commonest forms of the Polar Sea. Indeed, it occurred rather plentifully in the greater number (15) of the samples taken during the 'Fram' Expedition. It was collected both at the surface, and down to 300 metres, and seems to be as common in the western, as in the eastern part of the basin traversed. Young males occurred in almost the same number as females; but of fully adult, sexually mature males only a very limited number of specimens was found.

Gen. *Scolecithrix*, Brady.

Remarks. This genus was established in the year 1883 by Prof. Brady, to include the form previously described by Lubbock as *Undina Dance*; at the same time he adds another species, *S. minor*, which, like the former, was procured during the Challenger Expedition, and which also occasionally occurs off the coast of Norway. Dr. Giesbrecht, too, enumerates no less than

12 additional species, some from the Mediterranean, some from the tropical parts of the Atlantic and Pacific Oceans. It is, however, rather questionable, if all these species are in reality congeneric. The chief character upon which Brady founded this genus, is the peculiar transformation of the apical setæ of the anterior maxillipeds into delicate, vermiform, sensory appendages; but as shown by Dr. Giesbrecht, this character is also found in some other genera (*Xanthocalanus*, *Phaënna*), comprised by him in his subfamily *Scolecithricinæ*; and in the polar genus *Scaphocalanus*, described above, this character is also rather obvious. At any rate, the *Undina Danæ* of Lubbock ought to be regarded as the type of the genus *Scolecithrix*, and, indeed, this form is found to differ in some points very essentially from the other species. Thus, the 5th pair of legs are quite wanting in the female of this species, and the structure of the anterior antennæ and the tail is also rather different. Perhaps therefore the genus *Scolecithrix* should more properly be restricted to this form, and the other species be referred to one or two nearly-allied genera.

In the samples taken during the Nansen Expedition, I have found some few specimens of a form which must certainly be referred to this genus in the sense in which Dr. Giesbrecht takes it, but which differs very materially from the type species.

4. *Scolecithrix brevicornis* n. sp.

(Pl. X).

Specific Characters. ♀ Anterior division of body regularly oblong oval in form, front evenly rounded and less deep than in the other species; last segment imperfectly defined from the penultimate one, and having the lateral parts obtusely produced behind. Tail scarcely more than $\frac{1}{3}$ as long as the anterior division, and rather narrow, caudal rami about twice as long as they are broad. Anterior antennæ comparatively short, not nearly attaining the length of the anterior division of the body, and composed of 22 articulations, 2nd and 8th larger than the others, the last two united. Posterior antennæ with the rami subequal in length. Anterior maxillipeds with 5 very large and curved sensory appendages at the tip. Posterior maxillipeds with the terminal part recurved. Last pair of legs very small, but distinct, biarticulate, distal joint fusiform, with 3 unequal spines, one apical, one very small out-

side, and one rather large, and finely denticulated spine inside. Length of adult female scarcely exceeding 2 mm.

Remarks. As stated above, this form is very different from the type species, *S. Danæ*, Lubb., and more closely resembles the 2nd species recorded by Brady, *S. minor*; but also from this species, it may easily be distinguished by the comparatively shorter anterior antennæ, and the more regularly rounded frontal part. It is somewhat more difficult to point out the distinguishing characters in relation to the other species established by Dr. Giesbrecht. I believe, however, that the polar form is specifically distinct from any of them.

Description of the Female.

The length of fully adult specimens does not exceed 2 mm.

The general form of the body (see figs. 1 & 2) is rather short and thick, as is also the case with the other species referred to this genus. The anterior division, when seen dorsally (fig. 1), is rather regularly oblong oval in form, with the greatest width behind the middle, and somewhat exceeding $\frac{1}{3}$ of the length. It gradually tapers both in front and behind, the anterior extremity being evenly rounded, the posterior deeply incised in the middle. The cephalic segment is quite coalesced with the 1st pedigerous one, both together forming a very large segment, fully twice as long as all the others combined. Seen laterally (fig. 2), this segment appears narrowly rounded in front, whereas in *S. minor* it is almost transversally truncated. The rostral projection (see also fig. 3) is well marked, and carries 2 slender tentacular filaments. The last segment is imperfectly defined from the penultimate one, and has its lateral parts obtusely produced behind on each side of the deep median emargination (see fig. 1).

The tail is rather small, scarcely exceeding in length $\frac{1}{3}$ of the anterior division, and it is narrow cylindrical in form. Of the 4 segments composing it, the 1st, or genital segment is, as usual, the largest, though shorter than the 2 succeeding ones combined. The last segment is somewhat smaller than the penultimate one. The caudal rami are about twice as long as they are broad, and not at all divergent. The caudal setæ in all the specimens found were broken off, and their relative length cannot therefore be indicated.

The anterior antennæ (fig. 4) are comparatively short, not nearly attaining the length of the anterior division of the body, and they are composed of only

22 articulations. Of these, as in the preceding form, the 2nd and 8th are considerably larger than the others, and each apparently represents 2 coalesced articulations. This seems also to be the case with the last joint, which is rather longer than the next preceding ones. The antenna carries anteriorly short bristles of nearly uniform length.

The posterior antennæ (fig. 5) resemble in structure those in the preceding form, and, like them, have the outer ramus a little shorter than the inner.

The mandibles and maxillæ (see figs. 6, 7) are likewise of a structure very similar to that in *Scaphocalanus*.

The anterior maxillipeds (fig. 8), on the other hand, are distinguished by the large size of the 5 apical sensory appendages, which are somewhat fusiform in shape, and strongly incurved, so as to cross the spines issuing from the anterior lobes.

The posterior maxillipeds (fig. 9) are rather feeble in structure, and, as in the preceding form, have the terminal part recurved, and clothed with long, slender setæ.

The natatory legs (figs. 10—13), on the whole, agree in their structure very closely with those in *Scaphocalanus*; and, as in that form, the rami of the 3 posterior pairs are provided on their posterior face with irregular transverse rows of small spinules.

The last pair of legs (fig. 14) are very small, and still less fully developed than in *Scaphocalanus*, each leg being composed of only 2 joints, the 1st representing the basal part, the 2nd the outer ramus. The latter is much the larger, and is fusiform in outline, carrying 3 unequal spines, one apical and 2 lateral. Of the latter, the inner one is much the largest, and rather elongated, being obliquely incurved and finely spinulose on the edge.

Occurrence. Some few female specimens of this form were found in a sample taken on the 22nd May, 1894, north of the 81st degree of latitude, the tow-net having been lowered to 100 metres.

Gen. *Xanthocalanus*, Giesbr.

Remarks. This genus, established by Dr. Giesbrecht, is chiefly characterised from *Scolecithrix* by a somewhat different structure of the anterior maxillipeds, and of the last pair of legs in both sexes. Moreover, the relative length of the rami in the posterior antennæ, and the mandibular palps, is

somewhat different. Dr. Giesbrecht records 2 species of this genus, both from the Mediterranean, and I have myself found another species off the Norwegian coast. From the Nansen Expedition a single, somewhat defective female specimen of the latter species is derived, to be described below.

5. *Xanthocalanus borealis*, n. sp.

(Pl. XI).

Specific Characters. ♀. Anterior division of body rather tumid and greatly vaulted above, regularly oval in form, greatest width almost attaining half the length, front narrowly rounded, last segment imperfectly defined, with the lateral parts angularly produced behind. Tail scarcely attaining $\frac{1}{3}$ of the length of the anterior division, genital segment about the length of the 2 succeeding segments combined, last segment very small, caudal rami short, slightly divergent. Anterior antennæ exceeding in length the anterior division of the body, and 24-articulate. Posterior antennæ with the outer ramus considerably longer than the inner. Anterior maxillipeds with the outermost spine very strong and coarsely denticulate, apical sensory appendages comparatively small, 8 in number. Posterior maxillipeds with the terminal part comparatively short, and not recurved. Last pair of legs biarticulate, distal joint constricted in the middle, and carrying at the tip 3 strong, denticulated spines of about equal size. Length of adult female 4 mm.

Remarks. This form differs at once from the 2 Mediterranean species described by Dr. Giesbrecht, in its much larger size and more robust form of body. In the structure of the last pair of legs, it more resembles the smaller species, *X. minor*, than the larger *X. agilis*, the length of which according to Dr. Giesbrecht, is only 2.40 mm.

Description of the Female.

The length of the one specimen in the collection, which is an adult female, is 4 mm., or nearly twice that of the larger Mediterranean species.

The general form of the body (see figs. 1 & 2) is rather robust, with the anterior division considerably tumefied, and greatly vaulted dorsally. Seen from above (fig. 1), this division exhibits a rather regular oval form, with the

greatest width about in the middle, and almost equalling half the length. It gradually tapers both in front and behind, the anterior extremity being narrowly rounded, the posterior deeply emarginated in the middle. The front terminates below in a rather slight rostral projection, carrying 2 very small tentacular filaments. The cephalic segment is defined behind from the 1st pedigerous segment by a faint transversal suture. The last segment, on the other hand, is completely coalesced with the penultimate one, and has the lateral parts considerably produced behind, terminating in an acute corner.

The tail (see also fig. 14) is scarcely $\frac{1}{3}$ as long as the anterior division, and is cylindric in form. It is, as usual, composed of 4 segments, the 1st, or genital segment, being much the largest, and equalling in length the 2 succeeding ones combined. The last, or anal segment is extremely small. The caudal rami are comparatively short, being scarcely longer than they are broad, and are somewhat divergent. All the setæ were broken off in the specimen examined.

The anterior antennæ are rather slender, and somewhat exceed in length the anterior division of the body. They are composed of 24 articulations, the 8th of which is somewhat longer than the next adjacent ones. In the specimen examined, the distal part of both antennæ was, however, broken off.

The posterior antennæ (fig. 3) have the outer ramus considerably longer than the inner, and composed of 6 articulations, the 2nd and last of which are the largest, the 3 intermediate articulations being very short. All the joints, except the 1st, carry long ciliated setæ.

The mandibles (fig. 4) have the masticatory part but slightly expanded, with the cutting teeth closely crowded together and rather simple in structure. The palp is scarcely as large as the body of the mandible, and has the outer ramus much smaller than in the 2 preceding forms, and scarcely larger than the inner. The basal part carries 3 setæ inside.

The maxillæ (fig. 5) are quite normal in structure, with the masticatory lobe less prominent than in the 2 preceding forms, and armed with about 12 partly denticulated spines. The vibratory plate carries 9 plumose setæ, the 2 proximal ones, however, being rather short. The outer, membranous part of the maxilla, or the palp, exhibits the usual setiferous lappets, the

outermost being rather small, not extending beyond the middle of the adjacent lappet.

The anterior maxillipeds (fig. 6) are short and thick, with the 5 digitiform lobes of the anterior edge densely crowded together, and clothed with strong, coarsely ciliated setæ. On each of the 2 outermost lobes one of these setæ assumes the character of a claw-like spine. The outermost spine in particular, is very strong and coarsely denticulate laterally. The apical sensory appendages are 8 in number, and comparatively small. According to Dr. Giesbrecht, they terminate, in the species of this genus, in extremely delicate brushes, which I, however, have failed to detect in the form here in question.

The posterior maxillipeds (fig. 7) are rather slender, being almost 3 times as long as the anterior. The terminal part, however, is comparatively short, scarcely more than half as long as the 2nd basal joint, and is not reflexed. The setæ clothing this part are also rather shorter than in the 2 preceding forms, and are coarsely ciliated in their proximal part.

The natatory legs (figs. 8—11) are built upon the very same type as in the 2 preceding forms. In the 1st pair (fig. 8), however, outside the 1st joint of the outer ramus, there is a well-marked spine that is wanting in these forms.

The last pair of legs (figs. 12, 13) exhibit a rather characteristic appearance. They are each composed of only 2 joints, the 1st of which is rather short and coarsely hairy inside. The distal joint is about twice as large, oblong in form, and exhibits in the middle a conspicuous constriction. It is likewise clothed with delicate hairs both inside and outside, and carries at the end 3 strong, denticulated spines of nearly equal length, the middle one being attached to a projecting knob of the joint.

Occurrence. The above-described specimen was found in a sample taken on the 13th October, 1893, north of the New Siberian Islands, the tow-net having been lowered to a depth of 50 metres.

Distribution. Coast of Norway, rather abundant in the greater depths of the fjords, below 150 fathoms.

Gen. *Undinella*, n.

Generic Characters. Cephalic segment not coalesced with the 1st pedigerous one, front produced below to a well-marked rostral prominence

carrying 2 small tentacular filaments. Last pedigerous segment wholly coalesced with the penultimate one, and, in female, having the lateral parts lamellarly produced. Tail slender and elongated, composed in female of 4, in male of 5 segments, the last in both sexes extremely small. Caudal rami lamellar, with 4 apical setæ. Anterior antennæ in female 24-articulate, in male more slender, and clothed in their proximal part with well-developed sensory appendages. Posterior antennæ with the outer ramus much longer than the inner. Mandibles slender, with the 2 outer cutting teeth strong, bidentate at the tip, the others setiform; palp with the outer ramus comparatively small. Maxillæ with the masticatory lobe very large; vibratory lamella, on the other hand, poorly developed. Anterior maxillipeds rather strong, anterior lobes densely crowded together, and carrying comparatively short setæ, the outermost of which are claw-like, apical appendages scarcely transformed. Posterior maxillipeds exceedingly slender, with the terminal part reflexed and only sparingly setiferous. Oral parts in male not transformed. Natatory legs powerfully developed, posterior face smooth, inner ramus of the 2 anterior pairs uniaarticulate, of the 2 posterior biarticulate. Last pair of legs in female 3-articulate, terminal joint slender, sub-spatulate, terminating in a number of short digitiform spines; those in male exceedingly large and complex in structure, with both legs largely developed, the left one with a long, styliform inner ramus.

Remarks. This new genus is only provisionally placed within the family *Scolecilhricidæ*. It differs, indeed, in the character upon which this family has chiefly been founded, the apical setæ of the anterior maxillipeds being scarcely transformed at all; but in other characters it seems to approach nearer to the forms included in this family than to those of other Calanoid families. The genus comprises as yet only a single species, to be described below.

6. *Undinella oblonga*, n. sp.

(Pl. XII, XIII).

Specific Characters. Form of body rather slender, especially in the male. Anterior division regularly oblong oval in form, obtusely rounded in front, deeply emarginated behind. Cephalic segment defined behind by a distinct transversal suture, rostral prominence very conspicuous, pointing

straight downwards, tip minutely incised in the middle. Lateral parts of last segment produced in female to triangular, posteriorly-pointing lobes. Tail fully half the length of the anterior division of the body, genital segment in female considerably dilated in the middle. Caudal rami slightly widening distally, apical setæ not much elongated, and scarcely different in size. Anterior antennæ slightly exceeding in length the anterior division of the body, 8th articulation larger than the adjacent ones, and in male much elongated, apparently constituting 3 united articulations. Last pair of legs in female with the terminal joint twice as long as the middle one, and very narrow at the base, slightly widening distally, and carrying at the end 4 comparatively short denticulated spines, only the outermost of which is distinctly defined at the base; those in male much larger than the natatory legs, right leg the longest, without any inner ramus, outer ramus biarticulate, with the proximal joint bow-shaped, distal joint oblong lamellar, and bent upon the former; left leg with the outer ramus much shorter than the inner, and 3-articulate, last joint very small, setous at the tip, penultimate one produced at the end inside to a rounded denticulated lamella. Length of female about 3 mm., of male 2.50 mm.

Remarks. This is a very distinct and easily recognizable form, exhibiting in its external appearance, in the comparatively slender form and elongated tail, some resemblance to the *Cyclopoida*. In the anatomical structure of the several appendages it shows itself, however, to be a true *Calanoid*.

Description of the Female.

The length of the largest specimens amounts to about 3 mm., and this form is accordingly of medium size.

The general form of the body (see figs. 1 & 2) is rather slender, and the relative length of the 2 chief divisions is somewhat unlike that generally met with in the *Calanoida*. The anterior division is moderately vaulted above (see fig. 2) and, seen dorsally (fig. 1), is of a very regular oblong oval form, with the greatest width somewhat in front of the middle and considerably less than half the length. The anterior extremity, in this view of the animal, appears narrowly rounded, the posterior deeply emarginated in the middle. In a lateral view of the animal (fig. 2) the frontal part appears more evenly rounded, terminating below in a very conspicuous deflexed rostral

prominence. On a closer examination, this prominence (see figs. 4, 5) is found to be minutely incised at the tip, terminating in 2 short points, each carrying outside a slender tentacular filament. The cephalic segment is well defined from the 1st pedigerous one, a distinct suture being observable between them. On the other hand, no such line of demarcation is to be detected between the 2 last segments, which accordingly are completely coalesced into a single segment. The lateral parts of this segment are produced behind in the form of rather large triangular lobes projecting on each side of the base of the tail. The latter division is fully half as long as the anterior, and rather slender. It is, as usual, composed of 4 segments; but the last of these, the anal segment, is so very small, that it may easily escape attention. The 1st, or genital segment is somewhat larger than the succeeding one, and is considerably dilated in the middle, exhibiting below, moreover, a broadly rounded protuberance.

The caudal rami (see fig. 10) are pronouncedly lamellar, more than twice as long as they are broad, and gradually somewhat widening distally. They each carry 4 densely plumose setæ, 3 of which issue from the obtusely rounded tip, the 4th somewhat more externally from a distinct ledge of the outer edge. The setæ are not of any considerable length, being scarcely more than half as long as the tail. The outermost seta is a little shorter than the other 3, which are equal in length. As in most other Calanoids, moreover, a very delicate, unciliated bristle is seen originating from the dorsal face of each ramus, near the inner corner, being angularly bent, with the distal part extending outwards across the caudal setæ.

Of any eye, no trace could be detected, though most probably it has been present in the fresh state of the animal.

The anterior antennæ (fig. 6) are rather slender and attenuated, somewhat exceeding the length of the anterior division of the body. They are composed of 24 well-defined articulations, of which, as in the 3 preceding forms, the first 2 and the 8th are the largest. The joints are clothed anteriorly with short bristles, more densely crowded together in the proximal part of the antenna.

The posterior antennæ (Pl. XIII, fig. 1) have the outer ramus very fully developed, and considerably longer than the inner, its structure being about the same as in the 3 preceding forms.

The anterior and posterior lips (Pl. XII, figs. 8, 9) are of quite normal structure.

The mandibles (Pl. XIII, fig. 2) have the masticatory part rather produced, though only slightly expanded. Of the cutting teeth, the outer 2 are well developed and bidentate at the tip, whereas the others are very feeble, setiform. The palp is shorter than the body of the mandible, and has the basal part obliquely produced at the inner corner, so that the inner ramus projects considerably beyond the outer, which is rather small.

The maxillæ (fig. 3) are distinguished by the strong development of the masticatory lobe, which is unusually broad, and armed with about 12 strong, denticulated spines. The vibratory plate, on the other hand, is poorly developed, and provided with only 6 comparatively small setæ. On the terminal part, or palp, the outermost lobe is likewise poorly developed, with only 2 apical setæ.

The anterior maxillipeds (fig. 4) are of moderate size, with the basal joint more than twice as large as the others combined. The digitiform lobes of the anterior edge are densely crowded together, and carry comparatively short setæ, the outermost of which assume a claw-like structure. The apical setæ issuing from the 2 outermost, very small joints, are short and simple, being scarcely sensory in character.

The posterior maxillipeds (fig. 5) are extremely slender and elongated, with the 2nd basal joint very narrow and almost naked, forming with the 1st a more or less abrupt, elbow-shaped bend. The terminal part is very slender, almost as long as the 2nd basal joint, and is reflexed and provided with only a very restricted number of setæ.

The natatory legs (figs. 6—9) are powerfully developed, and on the whole built upon the same type as in the 3 preceding forms, though no trace is found of the small spinules clothing the posterior face of the rami in these forms. The inner ramus, however, in the 2nd pair (fig. 7), is uniarticulate, like that in the 1st pair, and in the 2 posterior pairs it is only biarticulate; but in all these pairs, on a closer examination, a slight indication of the formation of a short 1st joint may be observed. In the 3 posterior pairs, the outer ramus is very broad, with the apical spine strongly developed, and bordered outside with a hyaline, serrated rim.

The last pair of legs (fig. 10) consist each of a distinctly 3-articulate stem, the 1st joint of which is united with that of the other side to a common basal part. The 2nd joint is much narrower and, like the 1st, quite smooth. The 3rd joint is considerably longer, but very narrow in its proximal part, slightly expanding towards the end, so as to assume a narrow spatulate form. It terminates in 4 short digitiform processes finely denticulated at the edges. Of these, the outermost is distinctly defined at the base, whereas the other 3 form immediate prolongations of the joint.

Description of the Adult Male.

The length of the body scarcely exceeds 2.50 mm., and the male is accordingly somewhat inferior in size to the female.

The sexual differences are very conspicuous, though not developed to nearly such a degree as in the male of *Scaphocalanus*; and it is, indeed, in this instance, not difficult to recognize the specific relation of the male individuals.

The form of the body (see Pl. XII, fig 3) is, on the whole, still more slender than in the female, and the relative proportions of the 2 chief divisions are somewhat different, the tail being exceedingly slender, and considerably more than half as long as the anterior division. The latter is of a regular oblong oval form similar to that in the female, though somewhat narrower, and has the lateral corners of the last segment much shorter. The tail is narrow cylindric in form, and is divided into 5 segments, the 1st of which is quite short, and greatly constricted at the base. The last segment, as in the female, is very short, and the caudal rami with their setæ do not exhibit any perceptible difference from those in the female.

The anterior antennæ (fig. 7) are comparatively somewhat more slender than in the female, and, when reflexed, project far beyond the limits of the anterior division, extending to about the middle of the tail. The 2 antennæ are exactly alike, and both are found to have one articulation less than in the female, on account of the 9th being coalesced with the 8th. In addition to the usual bristles, the antennæ carry a number of rather fully developed sensory filaments, which are especially thickly set in the proximal part of the antenna.

The posterior antennæ, oral parts, and natatory legs do not exhibit in their structure any appreciable difference from those organs in the female.

The last pair of legs, on the other hand, are very different and quite enormously developed, being much larger than the natatory legs, and about equalling in length $\frac{1}{3}$ of the whole body. The 2 legs (see Pl. XIII, fig. 11), as usual, are rather differently developed, both being, however, of a rather complex structure, and strongly muscular. The 1st basal joints of the two legs are wholly coalesced, forming a common, somewhat lamellar stalk. The 2nd basal joint is rather tumid, and in the right leg considerably larger than in the left. The terminal part of the former, representing the outer ramus, is very much elongated, and of a rather irregular shape, consisting of 2 highly chitinized pieces, movably articulated together. The proximal piece is much the larger, and is curved outwards like a bow. It is very narrow, though expanding somewhat in its distal part, and projecting at some distance from the tip, inside, to a short, heel-shaped prominence. The distal piece has the form of a narrow oblong lamella, bent in the opposite direction, and gradually widening somewhat towards the tip, which is obtusely rounded. Of any inner ramus, no trace is found in this leg. In the left leg, on the other hand, the inner ramus is very fully developed, forming a long styliiform process, nearly twice as long as the outer ramus, and extending to the end of the right leg. It is likewise highly chitinized and gently curved, exhibiting at some distance from the tip a very slight dilatation. The outer ramus of this leg is composed of 3 joints, of which the first 2 form together a somewhat fusiform division bent inwards at the tip in a hook-like manner, and terminating in a rounded lamella, finely denticulated at the edge. The terminal joint, issuing outside this lamella, is very small, conical in form, and tipped with a fascicle of small bristles.

Occurrence. This peculiar Calanoid occurred in 5 of the samples, in none of them, however, in any considerable number. One of the samples was taken on the 12th November, 1895, near the northernmost point reached by the 'Fram'. Another sample was taken on the 28th June, 1895, on the very surface of the sea, all the others from depths between 100 and 300 metres.

Fam. EUCHÆTIDÆ.

7. *Euchaeta norvegica*, Boeck.

(Pl. XIV).

Syn: *Euchaeta carinata*, Moebius.
" " *glacialis*, Hansen.

Remarks. Of this form a detailed description, accompanied with figures, has been given by the present author in his account of the Crustacea of the Norwegian North Atlantic Expedition. It was there pointed out that the *E. carinata* of Moebius is identical with Boeck's species, nor can I see any essential difference between it and the form subsequently recorded by Dr. Hansen from the Kara Sea as *E. glacialis*. In the accompanying plate, I give improved habitus-figures of both sexes, from specimens collected during the Nansen Expedition.

Occurrence. Of this magnificent Calanoid, specimens were found in almost all the samples, and it seems, indeed, to be as common in the eastern as in the western part of the polar basin traversed by the 'Fram'. The largest female specimens, some of which still had their large, flattened ovisac adhering to the genital segment, measured in length about 10 mm., a truly gigantic size for a free Copepod. An unusually large 'Nauplius' found in some of the samples taken north of the New Siberian Islands, I believe to be the larva of this Calanoid.

Distribution. Coast of Norway (chiefly in great depths), the German Ocean, several stations of the Norw. North Atl. Expedition, the Kara Sea.

Fam. ÆTIDIDÆ.

Gen. *Undeuchaeta*, Giesbrecht.

Remarks. Of this genus, established by Dr. Giesbrecht, hitherto only 2 species are known, *U. major* and *minor*, both from the tropical parts of the Atlantic and Pacific Oceans. One of these (*U. major*) was believed to be perhaps identical with the form recorded by Brady from the Challenger Expedition as *Euchaeta australis*. The genus is chiefly characterised by the structure of the posterior maxillipeds. In this, as also in most other characters, a very large-sized Calanoid from the Nansen Expedition seems to

agree perfectly with the 2 species recorded by Dr. Giesbrecht, and accordingly ought to be referred to the same genus.

8. *Undeuchæta spectabilis*, n. sp.

(Pl. XV, XVI).

Specific Characters. Body of female rather robust, with the anterior division oblong oval in form, that of male considerably more slender, cephalic segment coalesced with the 1st pedigerous one; last segment, however, well defined in both sexes, though very small, its lateral corners produced in female to a short, deflexed, angular projection. Front produced below to a very small, pointed, rostral prominence. Tail in female scarcely more than $\frac{1}{3}$ as long as the anterior division, and having the segments very sharply marked off from each other. Caudal rami very short, scarcely as long as they are broad, and somewhat divergent, apical setæ very strong and densely plumose. Anterior antennæ in female about the length of the anterior division of the body, and 24-articulate, 1st joint with 2 very conspicuous plumose setæ; those in male comparatively more slender, and composed of only 22 articulations, partly clothed with delicate sensory filaments. Posterior maxillipeds very slender, 2nd basal joint exceedingly long and narrow, terminal part short, not even attaining a length equal to $\frac{1}{3}$ of that joint. 1st pair of natatory legs with the first 2 joints of the outer ramus coalesced; 4th pair with 5 strong spines inside the 1st basal joint. Last pair of legs wholly wanting in female, in male exceedingly large and powerful, with both legs biramous and of rather complex structure. Length of adult female 8 mm., of male 6 mm.

Remarks. This, next to *Euchæta norvegica*, is the largest Calanoid collected during the Expedition, equalling in size even the largest specimens of *Calanus hyperboreus*. This, indeed, will suffice to distinguish it from the 2 other species of the genus, which are very much smaller.

Description of the Female.

The length of the specimen examined, which seems to be fully grown, measures no less than 8 mm., not including the caudal setæ; and this form accordingly attains a size nearly twice that of the largest of the 2 species recorded by Dr. Giesbrecht, *U. major*, the length of which is only 4.50 mm.

The general form of the body (see Pl. XV, figs. 1, 2) is rather robust, resembling somewhat that of the species of the next genus (*Chiridius*). The anterior division of the body is moderately vaulted above (see fig. 2), and, seen dorsally (fig. 1), oblong oval in form, with the greatest width scarcely more than $\frac{1}{3}$ of the length, and occurring about in the middle. The anterior extremity appears obtusely blunted, and the posterior, as usual, deeply emarginated in the middle. The cephalic segment is coalesced with the 1st pedigerous one, only a very slight constriction occurring between them, but no distinct suture (see fig. 2). The last segment, on the other hand, is well defined from the preceding one by a distinct, somewhat arcuate suture. This segment is very small, and has the lateral parts somewhat produced behind, terminating in a short, slightly deflexed, angular corner (see fig. 2). The rostral prominence is small, but distinct, terminating in a simple acute point.

The tail is comparatively short, scarcely exceeding $\frac{1}{3}$ of the length of the anterior division. It is, as usual, composed of 4 segments, which are very sharply marked off from each other, and each provided at the end with a circlet of small spinules. Of the segments, the 1st, or genital segment is, as usual, the largest, about equalling in length the 2 succeeding ones combined. It has its greatest width beyond the middle (see fig. 1), and below forms a rounded protuberance, to which, in the specimen examined, a small spermatophore was attached (see fig. 2). The last segment is rather small and obliquely cut off on each side for the articulation with the caudal rami. The latter are very short, being scarcely longer than they are broad, and are somewhat divergent. They are finely ciliated inside, and each carry at the tip 4 very strong and densely plumose setæ of moderate length and but little differing in size. Moreover, a small, unciliated bristle occurs on each ramus outside the setæ.

Of any eye, no trace could be detected, though it is very likely that it has existed in the fresh state of the animal.

The superior antennæ (fig. 8) are about the length of the anterior division of the body, and are composed of 24 well-defined articulations, the 8th of which, as in the preceding forms, is somewhat larger than the next adjacent ones, and probably represents 2 united articulations. To the 1st articulation, 2 rather conspicuous plumose setæ are attached. For the rest, the antenna

carries in front simple bristles of somewhat unequal length, and scattered, rather small, sensory appendages.

The posterior antennæ (fig. 4) have the outer ramus about twice as long as the inner, and composed of 7 joints, the 2nd and last of which are the largest, with 4 very short articulations between them. The ramus carries 9 long plumose setæ, 3 of which issue from the tip.

The mandibles (fig. 5) are rather strong, with the masticatory part considerably expanded. Of the cutting teeth, the outermost is the largest, and, claw-shaped; the 2 succeeding ones are likewise rather large and bidentate at the tip, whereas the others are rather small and closely crowded together. The palp is scarcely more than half the length of the body of the mandible, and has the 2 rami of equal size, the basal part being quadrangular in form, and carrying, inside, 3 ciliated bristles.

The maxillæ (fig. 6) have the masticatory lobe of moderate size and clothed with about 12 denticulated spines. The vibratory plate is well developed, carrying 8 plumose setæ, of which the middle ones are very much prolonged. On the outer part of the maxilla, or the palp, the median lobe, constituting the distal part of the basal joint together with the inner ramus, is unusually prolonged, and the setæ issuing from the end of this lobe are very densely crowded together in a brush-like manner. The outermost lobe, constituting the outer ramus, is comparatively small, and is fringed with 10 curved setæ.

The anterior maxillipeds (fig. 7) are short and thick, with the 5 digitiform lobes closely crowded together, and clothed with coarsely ciliated setæ of moderate length. On each of the 2 outermost lobes, one of the setæ assumes the character of a claw-like spine. The setæ issuing from the 2 terminal joints are rather small, though distinctly ciliated.

The posterior maxillipeds (Pl. XVI, fig. 4) exhibit a rather characteristic appearance, being very slender and elongated, more than 3 times as long as the anterior. The 1st basal joint is oblong quadrangular in form, and exhibits in front 3 successive slight prominences, clothed with a restricted number of short setæ. The 2nd basal joint is fully twice as long as the 1st, and very narrow, almost linear in form. Its anterior edge is finely ciliated in its proximal part, and somewhat beyond the middle it carries 3 unequal setæ. The terminal part is comparatively short, scarcely $\frac{1}{3}$ the length of the 2nd basal joint, and is more or less strongly incurved. It is composed of 5 joints, the

2nd of which is the largest. Some of the setæ clothing this part are spiniform, and 2 of those issuing from the 1st joint are considerably longer than the others, and are coarsely ciliated at the base.

The natatory legs (figs. 5—8) are powerfully developed, and, on the whole, resemble in structure those in the *Scolecithricidæ*. The 1st pair (fig. 5), however, are rather small, as compared with the others, and have the first 2 joints of the outer ramus imperfectly defined, being only indicated by the presence of 2 successive spines on the outer edge; of these the distal one is attached to a projecting knob-like expansion of the joint. The inner ramus in this pair is uniaarticulate, with the outer edge bulging in the middle. In the 2nd pair (fig. 6) this ramus is distinctly biarticulate, and in the 2 posterior pairs (figs. 7, 8), it is composed of 3 well-defined joints. The outer ramus in the 3 posterior pairs is very large and broad, with the apical spine coarsely serrate outside. The number of natatory setæ and spines on the rami is exactly the same as in the *Scolecithricidæ* described above. In none of the pairs, however, could any spinules of the posterior face be detected. On the other hand, the 4th pair (fig. 8) is distinguished by 5 closely-set spines issuing inside the 1st basal joint, immediately above the plumose seta.

Behind the natatory legs, not the slightest trace of any limbs could be detected, and indeed, this total absence in the female of the last pair of legs is a character common to all the forms included in the present family.

DESCRIPTION OF THE ADULT MALE.

The length of the solitary specimen examined, which seems to be fully grown, is about 6 mm., and the male, accordingly, does not nearly attain the size of the female.

The general form of the body (see Pl. XVI, fig. 1) is rather more slender than in the female, with the anterior division narrow oblong, and having the lateral corners of the last segment less produced. The tail is somewhat more elongated in proportion to the anterior division, and is rather slender, being, as usual, divided into 5 segments, the last of which, however, is so very small, as easily to escape attention. The caudal rami with their apical setæ are about as in the female.

The anterior antennæ (fig. 2) appear more slender and attenuated than in the female, and are only composed of 22 articulations, the 8th and 9th

and the 11th and 12th being coalesced. The sensory appendages are more fully developed than in the female, and are more numerous, especially in the proximal part of the antenna.

The oral parts, as is not unfrequently the case in male Calanoids, are imperfectly developed and rather unlike those in the female. Even the posterior maxillipeds (fig. 3) look rather different, and more resemble those in the next genus (*Chiridius*).

The last pair of legs (fig. 9) are quite enormously developed, considerably exceeding in length even the whole tail, and, as usual, are rather asymmetrical, though both legs are found to be biramous. The 1st basal joints of the 2 legs are united, and together form a rather irregular piece considerably more expanded on the left than on the right side. The 2nd basal joint on both legs is very tumid, but is conspicuously larger on the left than on the right leg. On the other hand, the rami in the latter are longer than in the former. The outer ramus of the right leg, as in the genus *Undinella*, consists of 2 highly chitinized pieces, movably articulated to each other. The proximal piece in this form also is somewhat bow-shaped and considerably longer than the distal one, which projects inside to a rounded lobe. The outer ramus of the left leg is composed of 3 distinct joints, the 1st of which is about the length of the other 2 combined. The last joint is longer than the 2nd, to which it is very movably articulated, and it is slightly bilobular at the tip. The inner ramus is unarticulate on both legs, and essentially of the same appearance, though that of the right leg is longer and more slender. In both legs, this ramus terminates in a slightly curved lamellar expansion.

Occurrence. Of this large and conspicuous Calanoid, only 2 specimens, a female and a male, were found, both, however, being in a very perfect state of preservation, and therefore admitting of a rather minute examination. They both occurred in a sample taken between March 23rd and April 4th, 1895, near the 84th degree of latitude, the tow-net having been lowered to 130 metres.

Gen. *Chiridius*, Giesbrecht.

Remarks. This genus was established by Dr. Giesbrecht in the year 1892, to include a solitary species from the Gulf of Naples, *C. Poppei*, the chief character distinguishing it from *Undeuchæta* being the absence of a rostral projection, the spiniformly produced lateral corners of the last pedigerous segment,

and the somewhat different structure of the posterior maxillipeds. In these characters, I find that a Norwegian Calanoid, long ago recorded by Boeck as *Euchaeta armata*, perfectly agrees. This form, which is still very imperfectly known, also occurred rather plentifully in the samples taken during the Nansen Expedition, and in addition to it, 2 well-marked new species were found, undoubtedly belonging to the same genus, though differing in the presence of a very small but distinct rostral prominence. All these 3 species will be described below, figures of them being given in the accompanying plates.

9. *Chiridius armatus* (Boeck).

(Pl. XVII).

Euchaeta armata, A. Boeck, Nye Slægter og Arter af Saltvandscopepoder. Chr. Vid. Selsk. Forh. f. 1872, p. 39.

Specific Characters. Body moderately slender, with the tail almost half the length of the anterior division. Rostral projection quite obsolete. Last segment of trunk with the lateral corners gradually narrowed to acute processes pointing slightly outwards. Caudal rami rather longer than they are broad. Anterior antennæ slightly exceeding in length the anterior division of the body, and very slender, 24-articulate. Posterior antennæ with the inner ramus rather short and thick, scarcely more than half as long as the outer. Mandibular palps with the inner ramus very poorly developed. Oral parts in male much reduced. 1st pair of natatory legs with the outer ramus distinctly 3-articulate, 1st joint carrying the usual spine outside. Inner ramus of 1st and 2nd pairs uniaarticulate, that of 3rd and 4th pairs 3-articulate. Legs of last pair in male rather feeble, and simple, styliform. Length of adult female 4.30 mm., of male 3.30 mm.

Remarks. This form, as above stated, was first recorded by the late A. Boeck as a species of the genus *Euchaeta*. It was, however, like the other forms recorded by him, very imperfectly characterized, and no figures were given. For this reason, its true relationship to other forms was not recognized by Dr. Giesbrecht, who places it among other doubtful species, the genus of which could not be determined. There cannot, however, be any doubt, that Boeck's species is congeneric with that described by Dr. Gies-

brecht as *Chiridius Poppei*, though it is easily distinguishable, not only by its much larger size, but also by several structural details.

Description of the Female.

The length of the largest specimens in the collection is 4.30 mm., and this form accordingly grows to rather more than twice the size of the Mediterranean species, the length of which is only 1.80 mm.

The general form of the body (see figs. 1 & 2) is moderately slender, with the anterior division oblong oval in form, and but slightly vaulted above (see fig. 2). Seen dorsally (fig. 1), the front appears obtusely truncated; in a lateral view of the animal (fig. 2), however, it is found to be narrowly rounded, with no trace of any rostral projection below (see also fig. 3). The cephalic and 1st pedigerous segments are completely coalesced, and the same is also the case with the last 2 segments, so that the anterior division only exhibits 4 distinctly-defined segments, the 1st of which is about twice the length of the other 3 combined. The lateral corners of the last segment gradually contract to acute, spiniform processes, which point somewhat outwards (see also fig. 4).

The tail is rather slender, being almost half as long as the anterior division, and is cylindrical in form. It is, as usual, divided into 4 segments, the 1st of which, the genital segment, is somewhat shorter than the 2 succeeding ones combined, and forms a rounded protuberance below. The last, or anal segment (see fig. 13) is much shorter than the preceding ones, and is somewhat obliquely truncated at the end on each side. The caudal rami are considerably longer than they are broad, are finely ciliated inside, and each carry 3 strong plumose setæ of about equal length. In addition to these, a very short, unciliated bristle is seen at the base of the outermost seta, and another, still more delicate bristle, at the inner corner.

The eye could only be faintly traced in the alcoholic specimens. In fresh specimens it is very conspicuous and of unusual size, with bright red pigment.

The anterior antennæ (see figs. 1 & 2) slightly exceed in length the anterior division of the body. They are very slender and attenuated, and composed of 24 well-defined articulations, the 8th being, in this instance also,

conspicuously larger than those immediately adjacent to it. The antennæ are clothed anteriorly with delicate bristles of somewhat unequal length.

The posterior antennæ (fig. 5) have the inner ramus comparatively short, scarcely exceeding half the length of the outer, which is distinctly 7-articulate.

The mandibles (fig. 6) are rather strong, with the masticatory part greatly expanded, and the cutting teeth well developed. The palp is of moderate size, and highly characterised by the poor development of the inner ramus, which is extremely small, and has the terminal setæ unusually short in proportion to those of the outer ramus.

The maxillæ (fig. 7), on the whole, resemble in structure those in the genus *Undeuchæta*.

The anterior maxillipeds (fig. 8) are likewise constructed upon the same type as in that genus; but all the setæ springing from the digitiform lobes are of equal structure, none of them assuming a spiniform character.

The posterior maxillipeds (fig. 9) are rather slender and doubly geniculate, the 2 basal joints forming with each other a more or less pronounced elbow-shaped flexure, whereas the terminal part is bent in the opposite direction, or reflexed. The latter is about half the length of the 2nd basal joint, 5-articulate, and densely clothed with slender setæ.

The natatory legs (figs. 10—12) are built upon the same type as in the Calanoids described in the preceding pages. They are, however, less powerful than in *Undeuchæta*, with the outer ramus less dilated. In the 1st pair (fig. 10) this ramus is distinctly 3-articulate, the 1st joint being well defined, and provided outside with the usual spine. The inner ramus, both in this and the 2nd pair (fig. 11), is uniaarticulate, though in the latter pair there is a very slight indication of the separation of a short proximal joint. In the 2 posterior pairs (fig. 12) this ramus is, as usual, 3-articulate; but the boundary between the 2 proximal joints is far from being distinct. The last pair of legs, as in *Undeuchæta*, are wholly absent.

The adult male is rather smaller than the female, scarcely exceeding a length of 3 mm., and is easily recognizable by the much more slender tail, and the dense clothing of sensory filaments on the anterior antennæ.

The oral parts are much reduced, excepting the mandibular palps and the posterior maxillipeds, the former (fig. 4) having the inner ramus less

rudimentary than in the female, the latter scarcely exhibiting any perceptible difference either in size or structure.

The last pair of legs (fig. 15) are much feebler and simpler in structure than in the male of *Undeuchæta*, each leg forming a simple styliform stem, composed of 5 not very distinctly defined joints, the first 2 of which represent the basal part, the 3 distal ones the outer ramus. The right leg is rather longer than the left, which is strongly incurved.

Occurrence. This form occurred in no less than 14 of the samples, and in some of them rather abundantly. It may be worthy of note that it was also present in the sample which is stated to have been taken from the very surface of the sea, by skimming the water in a temporary creek in the ice.

Distribution. Coast of Norway, occurring in great abundance at depths beyond 150 fathoms, especially in the deep fjords.

10. *Chiridius tenuispinus*, n. sp.

(Pl. XVIII).

Specific Characters. ♀. Body comparatively less slender than in the preceding species, with the tail shorter, scarcely exceeding $\frac{1}{3}$ of the length of the anterior division. Front produced below to a distinct, though very small acute point. Last segment of trunk with the lateral corners produced to very slender, posteriorly-pointing spines, sharply marked off from the segment. Anterior antennæ about as in the preceding species. Posterior antennæ, however, differing in the far greater length and comparative narrowness of the inner ramus. Mandibular palps fully as long as the body of the mandible, inner ramus less rudimentary than in *C. armatus*, outer ramus very largely developed. Anterior maxillipeds with 2 of the outer setæ spiniform. Posterior maxillipeds comparatively more slender than in *C. armatus*. 1st pair of natatory legs with the first 2 joints of the outer ramus coalesced. Inner ramus of 2nd pair distinctly biarticulate. Length of adult female about 4 mm.

Remarks. This new species is easily distinguishable from the preceding one by the somewhat more robust form of the body, and especially by the very slender spiniform processes issuing from the lateral corners of the last segment of the trunk. In the other structural details also, some minor differences are found to exist, as will be seen by comparing the detail-figures here

given with those of *C. armatus*. Any more detailed description is not, I think, needed.

Occurrence. This form was found in 6 of the samples, 5 of them belonging to the eastern part of the basin traversed, the 6th lying about in the middle, near the 85th degree of latitude. The last sample was taken from the very surface of the sea, whereas the others were from some considerable depth below the ice. Only female specimens were found.

11. *Chiridius brevispinus*, n. sp.

(Pl. XIX).

Specific Characters. ♀. Body comparatively robust, with the anterior division more than 3 times as long as the posterior, and rather massive, oblong oval in form. Front produced below to a distinct, though not very large, acute rostral projection. Spiniform processes of last segment of trunk very small and somewhat incurved. Caudal rami about as in *C. tenuispinus*. Antennæ and oral parts likewise resembling in structure those organs in the latter species. 1st pair of natatory legs with the outer ramus distinctly 3-articulate, 1st joint, however, without any spine outside; the 3 succeeding pairs normal. Length of adult female reaching 4.80 mm.

Remarks. This is a rather large and robust species, somewhat resembling in its outward appearance the above-described species of the genus *Undeuchaeta*. It is, however, a true *Chiridius*, agreeing in all more essential characters with the other species of this genus, though easily distinguishable from any of them, both by its large size and its robust form of body, and especially by the very short spiniform processes of the last pedigerous segment.

Of this species also, I do not think it necessary to give any more detailed description.

Occurrence. This species, like the preceding one, occurred in 6 of the samples, but not the same as that form, as 5 of them belonged to the western part of the basin traversed. In one of the samples, taken between March 26th and April 4th, 1895, in about the 84th degree of latitude, it occurred rather plentifully; but no male specimens were found.

Fam. PSEUDOCALANIDÆ.¹Gen. *Pseudocalanus*, Boeck.

Syn: *Clausia*, Boeck (not Claparede).
 „ *Lucullus*, Giesbrecht.

Remarks. This genus was established as early as in the year 1864 by Boeck; but the name at that time proposed, *Clausia*, having been already appropriated, it was subsequently changed by him to *Pseudocalanus*. Dr. Giesbrecht did not at first recognize Boeck's genus, that named by him *Lucullus* being the very same. As yet, only a single species of this genus is known; for the species recorded by Boeck as *Pseudocalanus armatus* is generically distinct, and even belongs to a different family, *Atidiidæ*. In the samples taken during the 'Fram' Expedition, I have found 3 species referable to this genus. One of them is the type species originally recorded by Boeck.

12. *Pseudocalanus elongatus*, Boeck.

Syn: *Lucullus acupes*, Giesbrecht.

This well-known form occurred not infrequently in some samples taken between the 12th and 24th October, 1893, north of the New Siberian Islands. It was also found occasionally in a sample taken farther north.

Distribution. Coast of Norway, British Isles, west coast of France, Kiel Bay, the Baltic.

13. *Pseudocalanus major*, n. sp.

(Pl. XX).

Specific Characters. Very like the type species as to external appearance, but almost twice as large. Anterior division of body regularly oblong oval in form, scarcely broader in front than behind, and only composed of 4 segments, the last one with the lateral parts rounded off behind. Tail nearly half as long as the anterior division, genital segment about the length of the 2 succeeding ones combined, and rather protuberant below in its anterior part,

¹ The corresponding subfamily is termed by Dr. Giesbrecht *Clausocalaninæ* from the genus *Clausocalanus*; but as *Pseudocalanus* is of much earlier date, the name of the family should, according to the rule in zoology, rather be derived from that genus.

anal segment shorter than the preceding one. Caudal rami comparatively narrow, about 3 times as long as they are broad, and separated by a rather broad interval, though scarcely at all divergent, tip obtusely truncated, with a slight angular projection outside the caudal setæ; the latter 4 in number, and of moderate length. Anterior antennæ in female, when reflexed, reaching somewhat beyond the middle of the tail, and composed of 23 articulations, the 1st and 7th much larger than the others. Posterior antennæ and oral parts about as in the type species. Natatory legs likewise of a very similar structure, though comparatively somewhat more slender. Last pair of legs in male extremely slender, right leg with the terminal styliform part occupying more than half its length. Length of adult female 2.40 mm., of male 1.80 mm.

Remarks. This form so very closely resembles the type species, that I should have been much inclined to regard it only as a large variety, if both forms were not found together in the very same samples, without exhibiting any transitions. On a closer examination, indeed, some few minor differences may be also proved to exist in the structural details.

Description of the female.

The average length of adult specimens is 2.40 mm, whereas in the type species it scarcely exceeds 1.40 mm.

The general form of the body (see figs. 1 and 2) is rather slender and elongated, though perhaps somewhat less so than in the type species. The anterior division is but slightly vaulted above (see fig. 2), and, seen dorsally (fig. 1), exhibits a rather regular oblong oval form, with the greatest width about in the middle, and gradually narrowed both in front and behind. The anterior extremity appears narrowly rounded, the posterior somewhat broader and slightly emarginated in the middle. The cephalic segment is completely coalesced with the 1st pedigerous one, and the same is also the case with the last 2 segments, the whole division being accordingly composed of only 4 distinctly-defined segments, the 1st of which is nearly twice as large as the other 3 combined. The lateral parts of the last segment are rounded off, and the front carries below, as in the type species, 2 very delicate tentacular filaments.

The tail almost attains half the length of the anterior division, and is divided into 4 well-defined segments. The 1st, or genital segment, as usual, is much the largest, though scarcely attaining the length of the 2 succeeding ones combined. It is slightly dilated in front of the middle, and forms below at its anterior extremity a rather conspicuous rounded protuberance. The last, or anal segment is scarcely more than half as large as the preceding one, and is almost transversely truncated at the end. The caudal rami (see fig. 12) are narrower and more elongated than in the type species, being about 3 times as long as they are broad. They are scarcely at all divergent, though separated by a rather broad interspace, and they have the tip obtusely truncated, with a small projecting corner outside the caudal setæ. The latter, on each ramus, are 4 in number, all apical and of moderate length, the innermost but one being, as usual, the longest.

The anterior antennæ (fig. 3) are rather slender, and, when reflexed, extend about to the middle of the tail. They are each composed of only 23 articulations, the rather elongated 7th articulation apparently representing 3 united joints. The antennæ carry in front comparatively short and delicate bristles.

The posterior antennæ (fig. 4) have the outer ramus considerably longer than the inner, and 6-articulate, all the joints being setiferous.

The mandibles (fig. 5) are moderately strong, with the masticatory part rather expanded, and the cutting teeth well developed, though rather short. The palp is fully as long as the body of the mandible, and has the basal part obliquely produced at the inner corner, so that the inner ramus projects considerably beyond the outer.

The maxillæ (fig. 6) are of quite normal structure, resembling those in the type species.

The anterior maxillipeds (fig. 7) have the 5 digitiform lobes less densely crowded together than in the Calanoids described in the preceding pages, and the setæ issuing from them are rather strong and coarsely ciliated, none of them, however, assuming a spiniform character. The apical setæ issuing from the 3 very small distal joints, are well developed, resembling those of the digitiform lobes.

The posterior maxillipeds (fig. 8) are moderately slender, about twice as long as the anterior, and have the 2 basal joints of about equal length. The terminal part is a little shorter and not reflexed.

The natatory legs (figs. 9—11) considerably increase in length posteriorly, the 4th pair being nearly twice as long as the 1st. In structure they agree, on the whole, with those in the preceding Calanoids, the inner ramus being much smaller than the outer, uniaarticulate on the 1st pair, biarticulate on the 2nd, and 3-articulate on the 2 posterior pairs. Both rami are comparatively more slender than in the type species, but are otherwise of exactly the same structure. The last pair of legs are, as in the type species, wholly absent.

The adult male, of which only a solitary specimen was found, closely resembles the male of *P. elongatus*, but is considerably larger, measuring in length 1.80 mm. It is easily recognizable from the female, both in its external appearance and in the structure of the several appendages, which, on the whole, closely agrees with that in the type species.

The last pair of legs (fig. 13) are very slender, each leg forming a simple stem, which, however, is rather different on the two sides. The left leg is a little longer than the right, and is composed of 5 distinctly-defined joints, the first 2 of which may represent the basal part, the other 3 the terminal part or more properly the outer ramus. The joints of this latter part rapidly diminish in size, the 1st being about the length of the 2nd basal joint, whereas the last is extremely small and hook-shaped. The right leg, contrary to what is the case in the left, has the 1st basal joint considerably larger than the 2nd, and much more dilated at the base. The terminal part forms a slender styliform piece, occupying considerably more than half the length of the leg, and exerted to a very acute point. In the type species this piece is divided into 2 well-defined joints, which, however, in the present form are scarcely distinguishable at all.

Occurrence. This form was found rather abundantly in the samples taken between the the 12th and 24th October, 1893, north of the New Siberian Islands. As stated above, it occurred here together with the type species, from which it was at once distinguished by its much larger size. It was also found occasionally in 2 other samples taken on the 11th and 19th April, 1894, in about the 80th degree of latitude.

14. *Pseudocalanus pygmæus*, n. sp.

(Pl. XXI).

Specific Characters. ♀. Body much shorter and thicker than in the 2 preceding species, with the anterior division rather more tumid, and somewhat broader in front than behind, consisting of only 4 distinctly defined segments. Front, as in the type species, with 2 delicate filaments below. Last segment of trunk with the lateral corners rounded off. Tail scarcely more than $\frac{1}{3}$ as long as the anterior division, genital segment short and broad, anal segment scarcely smaller than the preceding one. Caudal rami comparatively short, each with 4 apical setæ. Anterior antennæ fully as long as the body, and 23-articulate. Posterior maxillipeds comparatively longer than in the 2 preceding species, with the terminal part more produced and generally reflexed. Natatory legs very slender, with the apical spine of the outer ramus exceedingly long and narrow. Length of adult female 0.86 mm.

Remarks. In its external appearance and very small size, this form so strongly recalls *Paracalanus parvus* Claus, that at first I believed it to be that species. A closer examination, however, showed it to be in reality very different, and much more nearly related to *Pseudocalanus elongatus*. Indeed, in all essential structural details, it agrees with this latter form, and ought therefore, in my opinion, to be referred to the same genus, in spite of its very different external appearance.

Description of the Female.

The length of the largest specimens found is only 0.86 mm, and this form is accordingly one of the smallest Calanoids known, being even somewhat inferior in size to *Paracalanus parvus* Claus.

The general form of the body (see figs. 1 & 2) very much resembles that in the above-named species, the anterior division being rather tumid, and having its greatest width in front of the middle. The cephalic segment is wholly coalesced with the 1st pedigerous one, both forming together a very large segment occupying more than $\frac{2}{3}$ of the whole division. Behind it, only 3 other segments appear belonging to the trunk, the last 2 segments being likewise united into one. The lateral corners of this segment, as in the 2

preceding species, are rounded off. The front carries below (see fig. 3) the usual small tentacular filaments.

The tail (fig. 5) is comparatively much shorter than in the 2 preceding species, scarcely exceeding $\frac{1}{3}$ of the length of the anterior division. It is divided into 4 well-defined segments, the 1st of which, the genital segment, is considerably dilated in the middle, and about the length of the 2 succeeding segments combined. The last, or anal segment is fully as large as the preceding segment, and almost transversely truncated at the end. The caudal rami are comparatively short, being scarcely twice as long as they are broad, and each carry at the tip 4 plumose setæ of moderate length. Moreover, a very small bristle is seen issuing from the inner corner of each ramus.

The anterior antennæ (fig. 5) are rather slender and elongated, extending, when reflexed, to the end of the caudal rami. In structure, they exactly agree with those in the preceding species.

The posterior antennæ (fig. 6) likewise resemble those in *P. major*, except that the 2nd joint of the outer ramus has only a single seta at the end, whereas in the 2 other species this joint carries 4 setæ.

The mandibles (fig. 7), maxillæ (fig. 8), and anterior maxillipeds (fig. 9) do not exhibit any essential difference from those appendages in the other 2 species.

The posterior maxillipeds (fig. 10), on the other hand, are rather more produced, and have the terminal part comparatively longer, and more generally reflexed.

The natatory legs (figs. 11—13), on the whole, agree in structure with those in the 2 preceding species, though some minor differences may be found to exist. Thus in the 1st pair (fig. 11), the 1st joint of the outer ramus is without the usual spine outside, and the inner ramus has only 4, instead of 5 natatory setæ. In the 3 other pairs (figs. 12—14) the apical spine of the outer ramus is exceedingly long and slender, being much longer than the terminal joint, and in the 4th pair (fig. 13) almost as long as the whole ramus. As in the other species of this genus, no trace of any 5th pair is present in the female.

Occurrence. This small Calanoid occurred in considerable numbers in the samples taken north of the New Siberian Islands, in October, 1893; no male specimen, however, was found.

Gen. *Spinocalanus*, Giesbrecht.

Remarks. This genus was established by Dr. Giesbrecht, to include a small Calanoid found in the tropical part of the Pacific Ocean, at a very considerable depth (1000—4000 metres), for which reason the species was named *S. abyssalis*. As the specimens were in a somewhat imperfect state of preservation, only some few detail-figures were given, to show the more important anatomical characters. On comparing these figures with those of a small Calanoid from the Nansen Expedition, I find so close a resemblance, that I am induced to refer this form to the same genus. The characteristic structure of the maxillipeds in particular, is the very same in the two forms; and the dense clothing of spinules on the natatory legs also, from which the generic name has been derived, is found to be very distinct at least on the inner ramus. The total absence of any rostral prominence or frontal appendages is likewise a character common to both forms.

15. *Spinocalanus longicornis*, n. sp.

(Pl. XXII).

Specific Characters. Body in both sexes comparatively short and thick, though rather different as regards the relative length of the 2 chief divisions. Cephalic segment not distinctly defined from the 1st pedigerous one, and somewhat applanated anteriorly, front quite simple, without the slightest trace of rostral prominence or tentacular filaments. Last 2 segments of trunk coalesced, lateral corners rounded off. Tail in female not even attaining $\frac{1}{3}$ of the length of the anterior division, in male considerably more slender and elongated. Caudal rami comparatively short, each with 4 apical setæ. Anterior antennæ considerably exceeding in length the whole body, in female 23-articulate, 7th articulation, especially in the male, very much elongated. Posterior maxillipeds very slender, with the terminal part almost twice as long as the 2nd basal joint, and clothed with very long and coarsely ciliated setæ. Natatory legs slender, inner ramus in the 3 posterior pairs armed behind

with several rows of spinules. Last pair of legs wanting in female, rather small in the male, left leg 5-articulate, right 3-articulate, and scarcely more than half as long as the left. Length of adult female 1·12 mm., of male 1·08 mm.

Remarks. This is likewise a very small Calanoid, though somewhat larger than the above-described *Pseudocalanus pygmaeus*, from which it is at once distinguished by the exceedingly long anterior antennæ, and the flattened, quite unarmed front.

Description of the Female.

The length of the body in fully adult specimens does not seem to exceed 1·12 mm., and this form is accordingly of about the same size as the type species, the length of which is indicated by Dr. Giesbrecht to vary from 1·10 mm. to 1·25 mm.

The general form of the body (see figs. 1 & 2) is comparatively short and compact, with the anterior division more than 3 times as long as the posterior, and moderately vaulted above (see fig. 2). Seen dorsally (fig. 1), this division exhibits a rather regular oblong oval form, with the greatest width behind the middle, the anterior extremity being obtusely rounded, the posterior scarcely broader, and but slightly emarginated in the middle. The cephalic segment is coalesced with the 1st pedigerous one, no distinct boundary being observable between them (in the type species, such a boundary is said to be present). Its frontal part is somewhat flattened, appearing, in a lateral view of the animal (fig. 2), narrowly rounded and without any trace either of a rostral prominence, or of tentacular filaments (see also fig. 3). The lateral corners of the last segment, which more properly represents 2 united segments, are not at all produced behind, but evenly rounded off.

The tail is very short, and, as usual, composed of 4 segments, the 1st of which, the genital segment, is somewhat dilated in front of the middle, and exhibits below a rather conspicuous rounded protuberance. The last, or anal segment (see fig. 12), is of about the same size as the preceding one, and is slightly insinuated behind between the insertions of the caudal rami. The latter are very short, scarcely longer than they are broad, and, as in *Pseudocalanus*, carry each 4 plumose setæ and a small bristle at the inner corner.

The anterior antennæ (see figs. 1 & 2) are very strongly developed, and much longer than the whole body, projecting, when reflexed, about

a 5th of their length beyond the caudal rami. They are composed, as in the 2 above-described species of *Pseudocalanus*, of 23 articulations, the 7th of which is rather elongated.

The posterior antennæ (fig. 4) have the outer ramus longer than the inner, both being of exactly same structure as in *Pseudocalanus*.

The anterior lip (see fig. 3) is rather prominent, and densely hairy at the end.

The mandibles (fig. 5) resemble those in *Pseudocalanus*, but have the basal part of the palp less produced at the inner corner, for which reason the inner ramus does not project beyond the outer.

The maxillæ (fig. 6) do not exhibit any peculiarity in their structure.

The anterior maxillipeds (see fig. 7) are well developed, and, on the whole, built upon the same type as in *Pseudocalanus*, with the digitiform lobes well separated, and clothed with coarsely ciliated setæ, the apical setæ being likewise rather strong, though somewhat shorter.

The posterior maxillipeds (ibid.) are more than 3 times as long as the anterior, and have the terminal part unusually prolonged, being almost twice the length of the 2nd basal joint. Of the 5 articulations composing this part, the 2nd is much the largest, equalling in length the 2 succeeding ones combined. The setæ of this part are all coarsely ciliated, and some of the outer ones are of very considerable length. The perfect agreement in structure of these limbs with those in the type species is very obvious on comparing the figure here given with that reproduced in Dr. Giesbrecht's great work.

The natatory legs (figs. 8—11) are very slender, and in structure resemble those in the genus *Pseudocalanus*, except that the inner ramus of the 3 posterior pairs is clothed on the posterior face with oblique rows of small spinules. In the type species the outer ramus also has similar spinules. Of the last (5th) pair of legs, no trace is to be detected.

The adult male (fig. 13), of which only 2 or 3 specimens were found, looks rather different from the female, and strongly recalls the male of *Pseudocalanus*. It is somewhat smaller than the female, scarcely exceeding 1 mm. in length, and has the anterior division of the body comparatively broader and more ovoid in form, with the anterior extremity triangularly produced and slightly keeled dorsally. The muscles moving the antennæ and

mandibular palps are very conspicuous, and much stronger than in the female, originating close together along the median line.

The tail is much more slender and elongated, almost half as long as the anterior division, and is divided into 5 well-defined segments, the 1st of which is very small, the 2nd much the largest. The caudal rami are mobile and more or less widely divergent.

The anterior antennæ (see fig. 13) are considerably dilated in their proximal part, which is clothed in front with large sensory appendages in addition to the bristles. They are only composed of 22 articulations, of which the 1st and 7th are particularly large, the latter even equalling in length the 6 succeeding joints combined, and apparently representing 4 united articulations.

The posterior antennæ are more strongly developed than in the female, and this is also the case with the mandibular palps, whereas the oral parts otherwise appear much reduced.

The last pair of legs (fig. 14) are comparatively small and simple in structure, being built upon the same type as in *Pseudocalanus*. The 2 legs each form simple stems, but are very unequal in size, the right leg being scarcely more than half as long as the left, and only composed of 3 joints, the last of which is lamelliform, not, as in *Pseudocalanus*, styliform. The left leg, as in that genus, is composed of 5 well-defined joints, the last of which is very small, and hook-shaped.

Occurrence. This form occurred not infrequently in a sample taken February—March, 1894, in about the 80th degree of latitude, and was also found occasionally in another sample taken on the 22nd May of the same year, somewhat farther north and west.

16. *Drepanopus Bungei*, G. O. Sars.

This form, recently described by the present author from specimens taken by Dr. Bunge in the mouth of the Jana River, was found, though rather sparingly, in the same 2 samples in which *Spinocalanus longicornis* occurred.

Tribe: **HETERARTHANDRIA.**

Fam. **HETEROCHÆTIDÆ.**

Gen. *Heterochæta*, Claus.

Remarks. Of this genus, established in the year 1863 by Prof. Claus, 6 species are recorded in Dr. Giesbrecht's work, 2 from the Bay of Naples, the other 4 from the tropical parts of the oceans. One of the latter, *H. abyssalis*, is identified with the form recorded by Prof. Brady from the Challenger Expedition as *H. spinifrons*, Claus. A 7th species of this genus was long ago recorded by Boeck from the Norwegian coast, under the name of *H. norvegica*; but as this species was very imperfectly characterised, its true relation to the other species could not of course be made out by Dr. Giesbrecht, who only mentions it as an undeterminable form. Boeck's species, which I have also observed myself off the Norwegian coast, is one of the most characteristic Calanoids of the Polar Basin, and together with it, I have found another, very distinct, new species. Both these species will be described below.

17. *Heterochæta norvegica*, Boeck.

(Pl. XXIII).

Heterochæta norvegica, A. Boeck, Nye Slægter og Arter af Saltvandscopepoder. Chr. Vid. Selsk. Forh. f. 1872, p. 40.

Syn: *Heterochæta spinifrons*, Moebius (not Claus).

Specific Characters. Body rather slender, especially in the male, with the anterior division regularly oblong oval in form, and somewhat depressed in its anterior part, front surmounted by a compressed and angularly deflexed rostrum, carrying on the tip 2 long straight styliform appendages; lateral corners of last pedigerous segment rounded off. Tail nearly half the length of the anterior division, genital segment in female very large, with a saddle-like depression dorsally, and considerably protuberant below; left caudal ramus much larger than the right, and about equalling in length the last 2 segments combined; the prolonged seta of this ramus exceeding the length of the whole body. Anterior antennæ in female very slender and attenuated, somewhat longer than the body, and abruptly curved near the base; those in

male comparatively shorter, left antenna distinctly geniculate, but with the part preceding the geniculation only slightly dilated. Posterior antennæ, mandibles, maxillæ, and anterior maxillipeds about as in *H. spinifrons*. Posterior maxillipeds very narrow, with the 1st basal joint much shorter than the 2nd, and carrying, about in the middle of the anterior edge, an exceedingly long and slender, flexuous spine, exceeding half the length of the maxilliped. Last pair of legs in female with the incurved spine of the 2nd joint of the outer ramus cultriform, and shorter than the terminal joint; those in male with the 2nd basal joint of right leg produced inside to a falciform, ciliated process, terminal joint of outer ramus in the right leg oblong lamellar, in the left leg rounded, with a slender apical claw and 2 short lateral spines. Length of adult female 4.56 mm., of male 4.20 mm.

Remarks. This species is certainly very closely allied to *H. spinifrons* of Claus, but cannot, in my opinion, be regarded as identical with this species, since it seems to differ not only in its much larger size, but also in some of the structural details. The form recorded by Prof. Moebius from the North Sea as *H. spinifrons*, Claus, is unquestionably Boeck's species.

Description of the Female.

The average length of adult specimens is from 4.50 to 4.60 mm., and there is no difference in this respect between polar and Norwegian specimens. On the other hand, the length of *H. spinifrons* is indicated by Dr. Giesbrecht to be only from 3.00 to 3.15 mm., and that of the other species to be far less. The northern species accordingly grows to a much larger size than does any of the other known species.

The general form of the body (figs. 1 & 2) is rather slender, with the anterior division about twice the length of the posterior. Seen dorsally (fig. 1), the former division exhibits a rather regular oblong oval form, with the greatest width in the middle, and about equalling $\frac{2}{5}$ of the length. The anterior extremity appears obtusely rounded, the posterior somewhat broader, and slightly emarginated in the middle. On a closer inspection, the anterior extremity is found to be surmounted in the middle by a sharply defined knob-shaped prominence, which in a lateral view of the animal (figs. 2 & 3) appears abruptly bent downwards, forming an angular rostrum. To the tip of this rostrum, 2 very long and delicate, perfectly straight filaments are

appended (see fig. 3). The cephalic segment is well defined from the 1st pedigerous one, and is somewhat applanated in its anterior part, exhibiting about in the middle of the dorsal face a well-marked cervical depression (see fig. 2). The last pedigerous segment is imperfectly defined from the preceding one, though not fully coalesced with it. Its lateral corners are rounded off.

The tail is composed of 4 well-defined segments, the 1st of which, the genital segment, is very large, attaining the length of the 2 succeeding ones combined. It exhibits dorsally, beyond the middle, a saddle-like depression, and is greatly protuberant below. In the specimen examined, a single large spermatophore was attached to the hind part of the segment below (see figs. 1 & 2). The 3 succeeding segments rapidly diminish in size, the last, or anal segment, being rather small and imperfectly defined from the caudal rami. The latter are rather produced and narrowed distally, pointing straight backwards. They are conspicuously asymmetrical, the left ramus being much larger than the right, and less distinctly defined from the anal segment. Each ramus carries 5 plumose setæ, 3 of which issue from the tip, the other 2 from separate ledges of the outer edge. The middle apical seta of the left ramus is enormously prolonged, considerably exceeding in length the whole body, its outer part being unciliated and hair-like. As in most other Calanoids, moreover, a small bristle is appended to the inner corner of each ramus.

The eye is wholly absent, as proved by the examination of fresh Norwegian specimens.

The anterior antennæ (see figs. 1 & 2) are extremely slender, and somewhat longer than the body, extending, when reflexed, a little beyond the end of the caudal rami. In all the specimens, they exhibit in their basal part an abrupt curvature, whereas the outer, extremely slender part is quite straight. They are composed of the full number of articulations (25), of which the 1st is by far the largest, and is somewhat compressed. Along the anterior edge they are clothed with slender, somewhat unequal bristles, which, especially in the proximal part, are densely crowded together.

The posterior antennæ, mandibles, maxillæ, and anterior maxillipeds closely agree in their structure with those appendages in the type species, for which reason I have not considered it necessary to give figures of them. In the next species, these limbs will be described in detail, and the differences from those in the present species pointed out.

The posterior maxillipeds (fig. 4) are rather slender, though scarcely longer than the very strongly built anterior maxillipeds. The 1st basal joint is comparatively short and somewhat lamellar, carrying at the end anteriorly a short spine accompanied by a small bristle. From about the middle of the anterior edge another much larger spine, or more properly seta, of a peculiar, compact consistency originates. This seta, which is unciliated and somewhat flexuous, is comparatively longer than in the type species, and gradually tapers to a fine point. The 2nd basal joint is very slender, and carries anteriorly 5 setæ, the outer 2 issuing from a particular lobe at the junction with the terminal part. The latter is shorter than the 2nd basal joint, and is composed of 5 articulations rapidly diminishing in size, and carrying comparatively short bristles.

The legs, as in the other species of this genus, are all natatory, with both rami distinctly 3-articulate. In structure they agree, on the whole, with those in *H. spinifrons*, the terminal joint of the outer ramus in the 2nd, 3rd and 4th pairs being distinguished by its large size and foliaceous character.

The 5th pair of legs (fig. 5) are considerably smaller than the next preceding ones, and are distinguished by the strong spine issuing from inside the 2nd joint of the outer ramus. In the present species this spine is shorter than the terminal joint, is somewhat cultriform, and stands out from the joint at nearly a right angle.

The adult male (fig. 6) is a little smaller than the female, scarcely exceeding a length of 4.20 mm. It is easily recognized by its more slender form, the different structure of the tail, and the geniculate left anterior antenna. The form of the anterior division of the body is about the same as in the female, except that the last segment is more distinctly defined from the preceding one. The tail is very narrow, cylindric, and composed of 5 well-defined segments, none of which is protuberant below. The caudal rami with their setæ are exactly as in the female.

The left anterior antenna (see fig. 6) is somewhat shorter than the right, and has a very distinct geniculation at about the distal 3rd part of its length. The articulations preceding this geniculation are, however, but very slightly dilated, and the movable terminal part is quite simple, consisting of 5 slender articulations.

The posterior antennæ and oral parts are of exactly the same structure as in the female.

Of the legs, too, only the last pair (fig. 7) differ in structure from those in the female. In both legs the outer ramus is transformed, and in the right leg the basal part is also peculiarly modified, its 2nd joint sending out, inside, a falciformly curved process, finely ciliated along the inner edge, and terminating in a blunt point. The outer ramus of the right leg is somewhat larger than that of the left, and otherwise also rather unlike it. Its 1st joint is conically produced at the end outside, where it carries a short spine. The 2nd joint has no spine, but forms, inside near the base, a rounded protuberance. The last joint is fully as long as the other 2 combined, and is spoon-shaped, carrying 2 small lateral spines, and inside the tip a short bristle. The outer ramus of the left leg is generally greatly incurved, and its 2 first joints have each a well-marked spine at the end outside. The last joint is rounded lamellar, with 2 rather strong lateral spines, and terminating in a slender claw. None of these rami has any trace of natatory setæ inside. The inner ramus is essentially of the same appearance in the two legs, being 3-articulate, with the 1st joint very small and less perfectly defined. Each ramus carries 7 natatory setæ, one of which issues from the 2nd joint, the other 6 from the last.

Occurrence. This characteristic Calanoid occurred in the greater number of the samples (13), and was found as frequently in the eastern as in the western part of the basin traversed. It also occurred in the above-mentioned sample, which was taken from the very surface of the sea.

Distribution. Coast of Norway (only in depths below 100 fathoms); the North Sea.

18. *Heterochaeta compacta*, n. sp.

(Pl. XXIV, XXV).

Specific Characters. ♀. Body short and compact, with the anterior division considerably tumefied and oval in form, rostral prominence much smaller than in the preceding species, with the apical filaments shorter. Tail scarcely more than $\frac{1}{3}$ as long as the anterior division, genital segment large and dilated, caudal rami somewhat less unequal than in *H. norvegica*.

Anterior antennæ scarcely longer than the anterior division of the body, and composed of 24 articulations only. Posterior antennæ more strongly built than in the type species. Anterior maxillipeds exceedingly large and powerful, with the 2 outer spines very long and claw-like. Posterior maxillipeds scarcely as long as the anterior, 1st basal joint without any transformed seta anteriorly. Last pair of legs with the incurved spine of the outer ramus fully as long as the terminal joint, and finely denticulated in its outer part. Length of adult female 3.35 mm.

Remarks. This is a very distinct species, easily recognizable from the other known forms by its unusually robust body, and the less elongated anterior antennæ. It is, however, a true *Heterochaeta*, as shown by the structure of the several appendages. Only female specimens have come under my notice.

Description of the Female.

The length of the body measures 3.35 mm., and accordingly this form is also somewhat larger than the type species, *H. spinifrons*, Claus.

The general form of the body (see Pl. XXIV, figs. 1 & 2) looks rather different from that of the preceding species, being much more robust and compact, with the tail comparatively shorter. The anterior division of the body is considerably tumefied and, viewed dorsally (fig. 1), of regular oval form, with the greatest width equal to about half the length, and occurring somewhat behind the middle. The anterior extremity appears obtusely rounded, the posterior abruptly contracted, and slightly emarginated in the middle. The rostral projection is comparatively smaller than in *H. norvegica*, and in the dorsal view of the animal (fig. 1) only causes a very slight nodiform prominence in front. It is, however, of an essentially similar form, and carries on the deflexed tip 2 straight tentacular filaments (see fig. 3). The cervical depression of the cephalic segment is clearly distinguishable in the lateral view of the animal (fig. 2). The last pedigerous segment is very small, though more distinctly defined than in the preceding species.

The tail is comparatively short and thick, scarcely exceeding $\frac{1}{3}$ of the length of the anterior division, and has the genital segment very large and dilated, the other 3 gradually diminishing in size. The caudal rami (see fig. 4) agree in their form with those in *H. norvegica*, and, as in that species, are

somewhat asymmetrical, the left ramus being larger than the right, though the difference is not so pronounced as in the above-mentioned species. The middle apical seta of the left ramus seems in this species also to have been much prolonged; but its exact length cannot be determined, as in all the specimens examined its distal part was broken off.

The anterior antennæ (fig. 5) are not nearly so slender and elongated as in *H. norvegica*, scarcely exceeding in length the anterior division (conf. figs. 1 & 2), and they are composed of only 24 articulations.

The posterior antennæ (fig. 6), on the whole, agree in their structure with those in *H. norvegica*, though being somewhat more strongly built. The outer ramus is shorter than the inner, about equalling in length the proximal joint of the latter, and it is divided into 7 well-defined joints, 4 short articulations occurring between the 2nd and last joint. All the joints, except the 1st, carry strong plumose setæ.

The anterior lip (fig. 7) is rather prominent and distinctly trilobate at the end, the lateral lobes being densely ciliated at the edges. The posterior lip (fig. 8) exhibits the usual appearance, and consists of 2 diverging rounded lobes finely ciliated on the edges.

The mandibles (fig. 9), as in the other species of this genus, have the masticatory part peculiarly modified, with only 3 unusually slender cutting teeth. Of these the outermost is very large, claw-shaped, and provided outside with a thin lamellar expansion. The other 2 are placed close together, and are separated from the first by a wide semilunar emargination. They differ slightly in the two mandibles, both on the right being bidentate at the tip, whereas on the left (fig. 9 a), only the inner is bidentate, the outer being simple. On both mandibles a ciliated bristle is attached inside the cutting teeth. The palp is normally developed, and has the outer ramus considerably larger than the inner.

The maxillæ (fig. 10) in the present genus are rather unlike those in the typical Calanoids, chiefly on account of the peculiar development of their outer part or palp. In the present species, they agree rather closely in structure with those in *H. norvegica*, as also with those in the type species *H. spinifrons*. The masticatory lobe is rather prominent, and the spines clothing its transversely truncated end are unusually slender and densely crowded together. The vibratory plate is comparatively small, and provided

with only 4 plumose setæ. The 2 setiferous lobes usually present between the masticatory lobe and the palp, are replaced by a simple conical projection, tipped with a single seta. The basal joint of the palp is comparatively small, but well defined, and carries only a single very small seta on a conical projection of the inner edge. The inner ramus is exceedingly minute, knob-like, and carries on the tip 4 likewise small setæ. The outer ramus, on the other hand, is very powerfully developed, forming a cylindrical joint fully as long as the remaining part of the maxilla, and tipped with 5 exceedingly long plumose setæ.

The anterior maxillipeds (Pl. XXV, fig. 1) are enormously developed, considerably larger even than in the preceding species. They each form a very strong curved stem apparently composed of 5 or 6 joints of very unequal length, the 1st being, as usual, much the largest. Of the usual 5 digitiform lobes, only the outer 2 are distinctly developed, the 3 proximal ones being more or less rudimentary, the 2nd even replaced by a single very small seta. The penultimate lobe carries 2 claw-like spines and a seta, and from the tip of the very slender ultimate lobe an exceedingly long and falcate claw originates, accompanied by a very small seta. Another claw-like spine of about the same size issues from the extremity of the maxilliped, lying in close proximity to the former. All these spines exhibit along the inner concave edge a very dense ciliation (see fig. 2). In structure these maxillipeds differ conspicuously both from the type species and from *H. norvegica*, whereas they closely agree with those of *H. vipera*, as figured by Dr. Giesbrecht.

The posterior maxillipeds (fig. 3) are scarcely as long as the anterior, and are far less powerful. They resemble in structure those in *H. norvegica*, differing, however, conspicuously in the absence of the long, flexuous spine of the 1st basal joint, this spine being here replaced by quite an ordinary seta.

The legs (figs. 4—8) are also, on the whole, built upon the very same type as in that species. They are all natatory and very powerfully developed, though the 1st and last pairs are rather smaller than the 3 middle pairs. In the 1st pair (fig. 4) the difference in size between the 2 rami is less pronounced than in the other pairs, the inner ramus being scarcely shorter than the outer, but fully as broad. This ramus carries, in all, 8 natatory setæ, one on the 1st, 2 on the 2nd, and 5 on the last joint. The outer ramus has the terminal joint shorter than the other 2 combined, and provided

inside with 4 well-developed natatory setæ. At the tip, this joint carries a slender spine, and outside 2 much smaller spines, which, like those of the 2 preceding joints, terminate in a thin flexible point.

The 3 succeeding pairs (figs. 5, 6, 7) are essentially of the same structure, though successively increasing somewhat in size. They have the inner ramus scarcely more than half as long as the outer, and much narrower. Its last joint in the 2nd and 3rd pairs carries 7, in the 4th pair 8 natatory setæ, 2 of which issue from the outer edge. The outer ramus is distinguished by the large size and foliaceous character of the last joint, which, especially in the 4th pair, is developed to quite an unusual extent, considerably exceeding in size the 2 other joints combined. In all 3 pairs this joint carries 5 natatory setæ inside, 3 spines outside, and at the tip another somewhat larger spine. Both the setæ and the spines are unusually short.

The 5th pair of legs (fig. 8) differ from the next preceding ones, not only in their much smaller size, but also in some of the structural details. Thus the 1st basal joint is without the plumose seta present in all the other pairs. The inner ramus, as in the 1st pair, has only 8 natatory setæ; but of these, 6 belong to the last joint, the 2nd joint having only a single seta. The outer ramus is fully twice as long as the inner, and much stronger. In the 1st joint the natatory seta is wanting, and in the 2nd it is replaced by a strong, incurved spine, finely denticulate in its outer part, and equalling in length the last joint. The latter is about as long as the other 2 combined, and carries 4 natatory setæ inside, 2 small spines outside, and at the tip a much larger spine, as in the 3 preceding pairs, finely serrate outside.

Occurrence. Solitary specimens of this form were found in 4 different samples taken on the following dates: March 24th, 1894, between March 26th and April 4th, 1895, June 28th, 1895, November 12th, 1895. One of these samples was taken from the very surface of the sea, the others in depths of from 130 to 300 metres.

Gen. *Augaptilus*, Giesbrecht.

Remarks. This genus was established in the year 1892 by Dr. Giesbrecht, to comprise 2 Mediterranean species formerly referred by Claus to the genus *Hemicalanus*, viz *H. filigerus* and *H. longicaudatus*, and at the same time he adds 5 new species from the tropical parts of the oceans, all

taken from considerable depths. The genus is easily distinguished from *Hemicalanus*, as also from *Heterochæta*, by the tail in the female being composed of only 3 segments. Moreover the structure of the oral parts is rather peculiar, though, it would seem, subject to considerable variation in the several species. To this genus I refer a very characteristic Calanoid from the North Polar Sea, in which the reduction of some of the oral parts (mandibles and maxillæ) has reached its maximum,

19. *Augaptilus glacialis*, n. sp.

(Pl. XXVI, XXVII).

Specific Characters. Body slender and elongated, with the anterior division oblong in form, and rather narrowed anteriorly. Cephalic segment well defined, but without any distinct cervical depression, front angularly bent, and carrying below 2 slender tentacular filaments. Last pedigerous segment not defined from the penultimate one, and having the lateral corners rounded off. Tail scarcely half the length of the anterior division, genital segment in female longer than the 2 succeeding ones combined, and but slightly dilated in front. Caudal rami slender and elongated, perfectly symmetrical, each with 5 strong, plumose setæ, the outermost of which originates at some distance from the others. Anterior antennæ very slender and elongated, considerably exceeding in length the whole body, and composed of 25 articulations, penultimate and antepenultimate joints each with a densely plumose seta behind; left antenna in male prehensile, antepenultimate joint produced at the end to a slender spiniform process. Posterior antennæ with the 2nd basal joint narrowly produced at the inner corner, outer ramus somewhat longer than the inner. Mandibles with the masticatory part narrowly produced, cutting teeth only 3 in number; palp very small, forming a simple cylindrical joint with 2 unequal setæ at the tip. Maxillæ rather imperfectly developed, with only a slight rudiment of the masticatory lobe, vibratory lamella likewise very small, with only 2 setæ, the one exceedingly prolonged; palp simple, cylindric, with 2 long apical setæ. Anterior maxillipeds well developed, with the digitiform lobes small and widely apart; none of the setæ claw-shaped. Posterior maxillipeds very slender, and of normal structure. Legs built upon a similar type to that in *Heterochæta*, but comparatively less powerful,

apical spine of outer ramus in the 3 middle pairs rather slender, and slightly incurved. Last pair of legs, as in *Heterochaeta*, with a strong spine inside the 2nd joint of the outer ramus; outer rami of the two legs in male not very dissimilar in size and structure, though rather unlike those in female. Length of adult female 4.82 mm.

Remarks. This is a very conspicuous Calanoid, easily recognizable from the other polar forms. Of the species recorded by Dr. Giesbrecht, *A. longicaudatus* (Claus) seems to approach nearest to the polar species, at least as regards the structure of the oral parts. It is, however, rather inferior in size, and seems also to differ in some of the structural details. In any case, it can hardly be supposed that the present species is identical with any of the hitherto recorded species, all of which have quite a southern distribution.

Description of the Female.

The length of the body in adult specimens is 4.82 mm., and this form is accordingly of rather large size, in this respect about equalling the Mediterranean species *A. filigerus*, Claus, but considerably exceeding its nearest ally, *A. longicaudatus*, the length of which is stated by Dr. Giesbrecht to be only from 3.70 to 3.85 mm.

The general form of the body (see Pl. XXVI, figs. 1 & 2) somewhat recalls that in *Heterochaeta norvegica*, but is rather more slender. The anterior division is but very slightly vaulted above (see fig. 2), and, seen dorsally (fig. 1), exhibits a narrow oblong form, with the greatest width somewhat behind the middle, and not attaining even $\frac{1}{3}$ of the length. The anterior extremity appears narrowly rounded and somewhat abruptly constricted behind, the posterior but very slightly emarginated in the middle. The cephalic segment is well defined from the 1st pedigerous one, and not quite as long as the remaining segments combined. It does not exhibit any distinct cervical depression, and the front, seen laterally (fig. 2), is rather narrow and angularly bent, projecting below in a small bifurcate rostrum, which carries 2 delicate tentacular filaments (see Pl. XXVII, fig. 1). The last pedigerous segment is wholly coalesced with the preceding one, and has the lateral corners evenly rounded off.

The tail is rather slender, though not quite attaining half the length of the anterior division. It is only composed of 3 segments, the 1st of which,

the genital segment, exceeds in length the other 2 combined, and is but slightly dilated in its anterior part. The last segment (see Pl. XXVII, fig. 11) is a little longer than the preceding one, and is rather obliquely truncated on each side at the junction with the caudal rami. The latter (*ibid.*) are perfectly symmetrical and produced to an unusual degree, being about the length of the last 2 segments combined, and are linear in form, pointing straight behind. They each carry 5 densely plumose setæ, 3 of which issue from the narrowly rounded tip, the other 2 from distinct ledges of the outer edge. One of the latter is placed at rather a long distance from the other, in front of the middle of the outer edge. The middle apical seta, or the innermost but one, is much longer than the others, and terminates in a very slender filament, curved outwards (see Pl. XXVI, fig. 1). Moreover, as in most other Calanoids, a very slender and delicate, unciliated bristle originates from the upper face of each ramus, close to the inner corner.

No trace of any eye could be detected in the preserved specimens.

The anterior antennæ (see Pl. XXVI, figs. 1, 2) are exceedingly slender and elongated, the 5 distal joints projecting, when reflexed, beyond the tips of the caudal rami. They are composed of 25 well-defined articulations, which are clothed anteriorly with delicate bristles. The penultimate and antepenultimate articulations each carry, moreover, at the end posteriorly, a remarkably large and densely plumose seta (see Pl. XXVII, fig. 2).

The posterior antennæ are very greatly developed, projecting far from the sides of the body (see Pl. XXVI, fig. 1). In structure, they exhibit several peculiarities (see Pl. XXVII, fig. 3). Thus the basal part is rather slender and quite naked, without any trace of the usual plumose setæ in front, and it is, moreover, considerably produced at the inner corner, so that the 2 rami issue at some distance from one another. At the insertion of the inner ramus, it projects to a small triangular lappet, at the base of which a small hair is attached. The inner ramus, which generally forms, with the basal part, a geniculate bend, consists, as usual, of 2 joints, the 1st of which is the larger, and is densely ciliated along the somewhat convex hind edge, but without any setæ anteriorly. The last joint is oblong oval in form, and slightly bilobular at the tip, carrying about 10 setæ, some of which are exceedingly long and slender. The outer ramus is a little longer than the inner, is cylindrical in form, and composed of only 5 joints, the 1st of which is imper-

fectly defined from the basal part. The 2nd joint is much the largest, exceeding in length the succeeding joints combined, and carries 2 setæ inside, one rather short, somewhat beyond the middle, and another much longer, at the end. The 2 very short succeeding joints carry each a seta, but that issuing from the outer joint is so very small, that it may easily escape attention. From the tip of the last joint, 3 exceedingly long and slender setæ originate.

The mandibles (fig. 4) are very small, and have the masticatory part narrowly produced, almost cylindric in form, and much longer than the other part. The cutting teeth are only 3 in number, the outermost tooth being the largest, and somewhat remote from the other 2. The palp is more rudimentary than in any other known Calanoid, consisting only of a simple cylindric joint tipped with 2 unequal setæ, and scarcely more than half the length of the body of the mandible.

The maxillæ (fig. 5) are likewise very much reduced, and rather unlike those in other Calanoids, each forming a simple narrow lamella, projecting on each side in a small setiferous lobe. The inner of these, which occurs close to the base, may answer to the masticatory lobe. It is very small, knob-like, and carries 2 unequal setæ of inconsiderable size. The outer lobe, which issues rather more distally, seems to represent the vibratory lamella. It is likewise very small, but carries 2 very strong setæ, the inner of which is prolonged to quite an extraordinary degree, being more than 3 times as long as the whole maxilla. The distal part, which answers to the palp, is narrow cylindric in form, and carries on the tip 2 strong setæ of equal length.

The anterior maxillipeds (fig. 6) are well developed, though not nearly so powerful as in *Heterochæta*, each forming a very slightly curved stem, divided into 5 joints, the 2 proximal ones being much the largest, and together representing the basal part. The 5 digitiform lobes of the anterior edge are comparatively small, and are distinctly separated from each other, the 2 proximal and the distal one each carrying a single coarsely ciliated seta, whereas the other 2 have each 2 such setæ. The setæ issuing from the 3 small terminal joints are rather slender and elongated, and, when examined under a very high magnifying power, are found to be thickly fringed along

the concave edge with small compressed denticles, similar to those represented by Dr. Giesbrecht in *A. longicaudatus*.

The posterior maxillipeds (fig. 7) are nearly twice as long as the anterior, and have the 1st basal joint a little shorter, but broader than the 2nd, with 2 slight prominences anteriorly, each carrying 3 unequal setæ. The 2nd basal joint is of about uniform breadth throughout, and carries 2 setæ in the middle of the anterior edge, and at the end 2 other setæ originating from a separate lobe. The terminal part is considerably shorter than the 2nd basal joint, and is composed of only 4 articulations. The setæ issuing from this part are of moderate length, and exhibit a similar structure to those of the anterior maxillipeds.

The legs (Pl. XXVI, fig. 5, Pl. XXVII, figs. 8, 9), are, on the whole, constructed upon the same type as in *Heterochaeta*, all 5 pairs being natatory, and having both rami distinctly 3-articulate. On a closer comparison, however, some well-marked differences may be found to exist. They are, on the whole, far less powerful than in *Heterochaeta*, especially as regards the 3 middle pairs. In the 1st pair (fig. 8), the spine issuing outside the 1st joint of the outer ramus is very much elongated, and setiform, whereas those of the 2 succeeding joints are extremely small. The relative length of the two rami, as also the number of spines and natatory setæ issuing from them, is the very same as in *Heterochaeta*; but both rami are comparatively narrower. This is still more the case with the middle pairs (fig. 9), the outer ramus of which is much less dilated, with the terminal joint scarcely as long as the other 2 combined, and not at all foliaceous in character. The 3 spines of the outer edge in this joint are very small, whereas the apical spine is rather slender and elongated, finely spinulose on both edges, and exhibiting a slight curvature inwards. The natatory setæ, too, are quite normally developed.

The last pair of legs (Pl. XXVI, fig. 5), though natatory like the preceding ones, differ from them rather conspicuously, both in their smaller size, and in some peculiarities analogous to those found in *Heterochaeta*. Thus the 1st basal joint is without the plumose seta present on the inside of the other pairs. On the other hand, the 2nd basal joint has attached to the outer corner a very slender and elongated bristle, not found in the other pairs, and extending downwards along the outer ramus almost to its end. This bristle, which is

also mentioned by Dr. Giesbrecht as occurring in the species examined by him, was at first overlooked, owing to its being partly concealed by the outer ramus, and it is not indicated in the figure here given. The outer ramus is fully twice as long as the inner, and much broader. The natatory seta of the 1st joint is wanting, and in the 2nd joint it is replaced, as in *Heterochæta*, by a strong denticulated spine, which in the present form is somewhat deflexed and a little shorter than the terminal joint. The latter is considerably larger than the other 2 joints combined, and is of oblong oval form, carrying 4 short natatory setæ inside, 2 extremely small spines outside, and at the tip another very short and blunt spine. The inner ramus is of the same structure as in *Heterochæta*, except that its terminal joint is comparatively larger, being fully as long as the other 2 combined.

The adult male (Pl. XXVI, fig. 3) resembles the female in its general habitus, but is easily recognizable by the structure of the left anterior antenna, the last pair of legs, and the tail. The latter is very slender, cylindric, and composed of 5 well-defined segments, which do not greatly differ in size. The caudal rami with their setæ are exactly as in the female.

The left anterior antenna (see fig. 3) is somewhat shorter than the right, scarcely reaching, when reflexed, beyond the caudal rami. It is distinctly geniculate at about the distal third part of its length, the 6 or 7 articulations preceding the geniculation being somewhat dilated, and containing the usual muscular band acting upon the terminal part. The latter (see fig. 4) is composed of 4 articulations, the 1st of which is the largest. The 2nd articulation is about the length of the last 2 combined, and is produced at the end anteriorly to a long styliform process, extending almost to the end of the last articulation.

The posterior antennæ, oral parts, and the 4 anterior pairs of legs do not exhibit any perceptible difference in their structure from those appendages in the female.

The last pair of legs (Pl. XXVII, fig. 10), however, are somewhat different, especially as regards the outer ramus, which is more robust, and has no spine inside the 2nd joint, nor yet natatory setæ. This ramus moreover, is slightly dissimilar on the two legs, as shown by the figure here given; but the dissimilarity is far from being so conspicuous as in *Heterochæta*.

Occurrence. This remarkable Calanoid was found in 7 different samples taken on the following dates: March 22nd, 1894, March 24th, 1894, April 11th, 1894, May 22nd, 1894, between March 26th and April 4th, 1895, May 7th, 1895, and November 12th, 1895, the tow-net having been lowered to depths of from 100 to 300 metres. One of the samples was taken near the most northerly point reached by the 'Fram'.

Gen. *Hemicalanus*, Claus.

Remarks. The generic name *Hemicalanus* was originally proposed by Dana in the year 1852; but as all the species included by him in that genus have proved to be referable to two previously established genera, viz., *Calanus* and *Centropages*, this name ought more properly to have been wholly discarded. Prof. Claus, however, in the year 1863, employed the same name in a different sense, to comprise 5 Mediterranean species, 2 of which were subsequently removed by Dr. Giesbrecht, and referred to the nearly-allied genus *Augaptilus*. To the 3 remaining species of Claus, now generally admitted to be genuine *Hemicalani*, 2 species were added by Brady from the Challenger Expedition, and Dr. Giesbrecht records 6 new species, 4 of which were found in the Gulf of Naples, the other 2 in the tropical part of the Pacific. None of these 11 species have ever been found north of the Mediterranean, and it has accordingly been generally assumed that the present genus is quite southern in distribution. It was therefore not a little surprising to find a specimen, undoubtedly belonging to this genus, in a sample taken from about the centre of the polar basin traversed by the 'Fram'. The specimen was in a sufficiently good state of preservation to allow of a close examination, both as to the external appearance and the anatomical details, and, as it may be of considerable interest to determine the relation in which this form stands to the other known species, I have given on Pl. XXVIII, figures, as exact as possible, both of the whole animal and the chief appendages. Not having been able to identify it with any of the previously known forms, I describe it here provisionally as a new species.

20. *Hemicalanus spinifrons*, n. sp.

(Pl. XXVIII).

Specific Characters. ♀. Body exceedingly pellucid and somewhat depressed, with the anterior division regularly oblong oval in form, gradually tapering both in front and behind. Cephalic segment rather longer than all the other segments of the trunk combined, and exerted in front to a long spiniform prominence pointing straight anteriorly. Last pedigerous segment united with the preceding one, and having the lateral corners evenly rounded. Tail very short, not attaining even $\frac{1}{6}$ of the length of the anterior division, genital segment rather dilated, and fully as long as the other 3 combined. Caudal rami about twice as long as they are broad, sublamellar, and slightly incurved at the end, which is transversely truncated. Caudal setæ rather strong, 5 on each ramus, 4 apical and one lateral, besides a small bristle at the inner corner. Superior antennæ considerably longer than the body, and 25-articulate, being clothed with slender bristles, some of which are rather elongated. Structure of the remaining appendages nearly agreeing with that in the other known species. Length of adult female 4 mm.

Remarks. There are 4 species to which this form bears a very close resemblance, viz, *H. mucronatus* Claus, *H. acutifrons* Giesbr., *H. oxycephalus* Giesbr., and *H. spiniceps* Giesbr. In all these species the cephalic segment is exerted in front to a similar spiniform prolongation; but as they are all closely allied, it is rather difficult to determine to which of them the polar form bears the nearest affinity. In its external appearance it seems to agree best with *H. oxycephalus*, to judge from the sketch given by Dr. Giesbrecht of this species; but the size is rather larger, and about the same as in *H. spiniceps*. I give below a detailed description of the specimen found.

Description of the Female.

The length of the body in the solitary specimen examined, which is a fully grown female, is about 4 mm., measured from the tip of the frontal process to the end of the caudal rami.

The whole body is so perfectly hyaline, even in the preserved state, that most of the inner organs appear with great distinctness through the inte-

guments, on viewing the animal from the dorsal side (see fig. 1). The general form of the body is that characteristic of the present genus, being especially distinguished from that in the nearly-allied genus *Augaptilus* by the unusually small size of the tail, as compared with the anterior division. The latter, seen dorsally, is of a rather regular oblong oval form, with the greatest width occurring somewhat in front of the middle, and not attaining $\frac{1}{3}$ of the length. It is composed of the same number of segments as in *Augaptilus*, the 1st, or cephalic segment being well defined, whereas the last 2 pedigerous segments are completely coalesced. The cephalic segment occupies rather more than half this division, and is prolonged in front to a very conspicuous, narrow spiniform projection, extending far beyond the insertions of the anterior antennæ, and carrying on the tip a very minute hair (see fig. 2). The lateral corners of the last segment are not at all produced, but are evenly rounded off.

The tail, as stated above, is of very small size, and, including the caudal rami, does not even exceed $\frac{1}{6}$ of the length of the anterior division. It consists (see fig. 12) of 4 well-defined segments, the 1st of which, the genital segment, is larger than the other 3 combined, and considerably dilated in the middle. The anal segment is a little larger than the preceding one, and is somewhat obliquely truncated on each side at the junction with the caudal rami. The latter are about twice as long as they are broad, are pronouncedly laminar, and scarcely at all divergent, the broadly truncated ends even being somewhat incurved. The 5 caudal setæ belonging to each ramus all seem to be of the same structure, and are clothed with cilia of the usual kind. 4 of them issue close together from the tip, the 5th from a distinct ledge of the outer edge. A small unciliated bristle is also attached to the inner corner of each ramus.

No trace of any eye could be detected.

The anterior antennæ (see fig. 1) are considerably longer than the whole body, and are rather thick at the base, though gradually attenuated distally. They are composed of the full number of articulations (25), and are clothed anteriorly with slender bristles, some of which are rather elongated.

The posterior antennæ (fig. 3) have the 2nd basal joint more than twice as long as the 1st, both carrying at the end anteriorly a single very small seta. The inner ramus is very long and slender, with the proximal joint

narrow cylindric and unarmed, the last, as usual, unequally bilobed, and carrying on the tip 10 slender setæ arranged in a flabelliform manner. The outer ramus is comparatively small, scarcely more than half as long as the inner, and is attached to the basal part far from its extremity. It is composed of only 5 distinctly defined joints, the 1st of which is nearly as long as the other 4 combined, the last about half as long. On the tip, this ramus carries 3 very much elongated setæ, and along the inner side 5 much shorter setæ.

The mandibles (fig. 3. bis) are rather feeble, with the masticatory part narrowly produced, and terminating in only 2 unguiform cutting teeth. The palp exhibits all the chief parts distinctly developed, and is considerably larger than the body of the mandible. Its basal part, however, is rather narrow and quite naked, being obliquely produced at the inner corner, so that the inner ramus projects considerably beyond the outer. The 1st joint of the inner ramus is imperfectly defined from the basal part, and carries 2 setæ inside; the last joint is provided at the tip with 6 slender setæ arranged in a flabelliform manner. The outer ramus exhibits the usual structure, being divided into 5 articulations, carrying long plumose setæ.

The maxillæ (fig. 6) have likewise all the chief parts distinctly developed. The masticatory lobe is rather narrow, and carries a limited number of ciliated spines. The vibratory plate is well developed, and provided with 6 densely plumose setæ. Between the masticatory lobe and the palp, a small lobe carrying a single seta occurs. The basal part of the palp is provided inside with 4 setæ, of which the proximal one issues at some distance from the others, being attached to a small knob-like projection, which may answer to the 2nd intermediate lobe. The 2 rami are both well defined from the basal part, but are of very different size, the inner one being very small, and provided with only 3 apical setæ, whereas the outer is unusually large, forming a subcylindric piece projecting far beyond the inner ramus, and carrying on the somewhat dilated and obliquely truncated extremity about 6 setæ, the 2 innermost of which are very much prolonged and densely plumose in their distal part.

The anterior maxillipeds (fig. 7) somewhat resemble those in *Augaptilus*, as described above, but differ in the fact of the basal part being divided into 3 distinctly defined joints of about equal size. The 5 digitiform lobes are

comparatively small and separated by distinct interspaces, 2 of them issuing from the 1st basal joint, 2 others from the 2nd, and the 5th from the 3rd basal joint. The lobes carry each 2 ciliated setæ of moderate length, except the proximal one, which has 3 such setæ. One of the setæ of the 5th lobe is rather strong and spiniform. A 6th lobe, carrying 3 setæ, is formed by the 1st joint of the terminal part, the 2 other joints being provided with a number of more claw-like spines.

The posterior maxillipeds (fig. 8) are rather powerful, with the 1st basal joint considerably larger than the 2nd, and the terminal part very fully developed, consisting of 5 well-defined joints carrying claw-like, anteriorly curving spines.

The legs (figs. 9, 10, 11) are all natatory, and in structure resemble, on the whole, those in the genus *Augaptilus*, though comparatively less powerful. The 1st pair (fig. 9) have the basal part bent in a peculiar manner, so that these legs extend more laterally than the other pairs. The 1st basal joint exhibits outside a very conspicuous rounded protuberance, and the 2nd has, at the outer corner, a slender bristle not found in the other pairs. The rami closely agree in structure with those in *Augaptilus glacialis*, and have the very same number of spines and setæ. The 3 succeeding pairs (fig. 10) likewise exhibit much the same structure as in the above-mentioned form, except that the apical spine of the outer ramus is comparatively smaller. The last pair of legs (fig. 11) are scarcely different in structure from the next preceding ones. They are, however, as usual, somewhat smaller, and the terminal joint of the outer ramus has only 3 natatory setæ instead of 5, and 2 spines outside, instead of 3. On the other hand, each of the 2 preceding joints has a perfectly normal natatory seta, and the 1st basal joint also has its usual plumose seta inside. The inner ramus is scarcely half as long as the outer, and its 2nd joint has only a single natatory seta.

Occurrence. The above-described specimen was found in a sample taken between March 26th and April 4th, 1895, about midway along the route of the 'Fram', and in about the 84th degree of latitude, the tow-net having been lowered to a depth of 130 metres.

Fam. TEMORIDÆ.

Gen. *Metridia*, Boeck.

Remarks. This genus, established in the year 1864 by Boeck, is very nearly allied to *Pleuromma* of Claus, the chief difference being the absence of the lateral eye (luminous organ?). Boeck records 2 species of this genus from the Norwegian coast, viz., *M. armata* and *M. lucens*; but both these forms were very insufficiently characterised. The first-named species has subsequently been identified by Dr. Giesbrecht with *Calanus longus* of Lubbock, whereas the 2nd species has not been recognized. I believe, however, that it is the same species as that subsequently described by Brady and Robertson as *M. hibernica*. To these 2 species Dr. Giesbrecht has added 6 new species, one from the Farøe channel, the others from the tropical parts of the oceans. In the samples brought home from the Nansen Expedition, one species of this genus occurred in great abundance.

21. *Metridia longa* (Lubbock).

(Pl. XXIX).

Syn: *Metridia armata*, Boeck.

Remarks. I think that Dr. Giesbrecht is quite right in identifying Boeck's species with *Calanus longus* of Lubbock, and as the specific name proposed by Lubbock is the older one, the species ought hereafter to be termed as above. The occurrence of this form in the Arctic Ocean has been already stated by several authors, and the species may therefore be sufficiently well known, for which reason I think any detailed description of it can be dispensed with. As, however, no good illustrations of it exist, I give on the accompanying plate exact figures of both sexes, together with some details, all figures drawn from specimens procured during the Nansen Expedition. The average length of adult females is 4.30 mm., or about the same as that of Norwegian specimens.

Occurrence. This form occurred rather abundantly in the greater number of the samples (14), and was taken both from the surface of the sea and down to a depth of 300 metres.

Distribution. Coast of Norway, very abundant in the great depths of the fjords, below 100 fathoms, Arctic Ocean, Spitsbergen, the Kara Sea.

Gen. *Temorites*, n.

Generic Characters. Form of body short and robust. Cephalic segment well defined, last pedigerous segment confluent with the penultimate one. Front without any rostrum or tentacular appendages. Tail symmetrical, and composed in female of 4, in male of 5 segments. Caudal rami very small, with a limited number of setæ. Anterior antennæ 24-articulate; right antenna in male prehensile. Posterior antennæ with the outer ramus 7-articulate, and about the length of the inner. Mandibles well developed, cutting teeth rather dissimilar, the outer ones unguiform, palp comparatively large, with the inner ramus the more prominent. Maxillæ with the palp imperfectly developed, inner ramus obsolete, outer not defined from the basal part, lamelliform, with strong curved setæ. Anterior maxillipeds exceedingly large and powerful, with the distal spines very much elongated and claw-shaped. Posterior maxillipeds normal. 1st pair of legs rather small, with the inner ramus biarticulate; the 3 succeeding pairs well developed, with both rami 3-articulate, the outer one very strong. Last pair of legs in both sexes simple, not biramous, in female 3-articulate, with the terminal joint long and narrow, spiniferous at the tip; right leg in male much larger than left, with the 3rd joint lamellarly expanded, and carrying at the tip a strong, incurved claw; left leg tapered distally, and carrying a straight apical spine.

Remarks. This new genus is only provisionally placed in the family *Temoridae*. It differs, in fact, very materially in some respects from the other known genera comprised in this family, and in certain points exhibits an apparent approach to the *Pontellidae*. The genus comprises as yet but a single species, to be described below.

22. *Temorites brevis*, n. sp.

(Pl. XXX, XXXI).

Specific Characters. Body in both sexes very short and stout, with the anterior division considerably tumefied, and oval in form. Tail scarcely exceeding $\frac{1}{3}$ of the length of the anterior division, and having the segments very sharply marked off from each other, anal segment smaller than the others. Caudal rami of very small size, each with only 3 plumose setæ, and an unciliated bristle at the inner corner. Anterior antennæ about the length

of the anterior division of the body, and rather densely setiferous, especially in their proximal part; right prehensile antenna in male with the dilated part, preceding the geniculation, composed of only 4 articulations, the last of which has anteriorly a deep, semilunar emargination defined by 2 spiniform projections, of which the proximal is rather strong, terminal part rather longer and 5-articulate, 1st joint fusiform, and projecting at the end anteriorly to a small hamiform prominence. 3rd and 4th pairs of legs with a deflexed spine at the outer corner of the 2nd basal joint, especially large in the 3rd pair, apical spine of outer ramus very strong and coarsely denticulate outside. Last pair of legs in female with the terminal joint almost twice the length of the other 2 combined, narrow linear in form, and carrying at the tip 2 unequal spines, the inner one the larger and somewhat incurved. Right leg of this pair in male with the 3rd joint irregularly oval in form, exhibiting outside 2 angular prominences, terminal claw abruptly curved in its outer part and carrying at some distance from the base a small spine; left leg likewise with a small spine outside the terminal spine. Length of adult female 1.10 mm., of male 1.05 mm.

Remarks. This form, at first sight, somewhat resembles the above-described new species of *Heterochaeta* (*H. compacta*), exhibiting a similar short and compact form of body. It is, however, in reality very different as regards the structural details, and is also of very inferior size.

Description of the Female.

The length of the body in fully grown specimens does not exceed 1.10 mm., and this form is accordingly of rather small size.

The general form of the body (see Pl. XXX, figs. 1 & 2) is very short and stout, so far greatly contrasting with the preceding species, *Metridia longa*, which is one of the most slender of known Calanoids. The anterior division is rather tumid and, seen dorsally (fig. 1), exhibits a rather regular oval form, with the greatest width almost equalling half the length, and occurring in the middle. The anterior extremity appears obtusely rounded, and the posterior is of about the same width, and slightly emarginated in the middle, with the lateral corners rounded off. The cephalic segment is well defined, whereas the last 2 pedigerous segments are imperfectly separated.

The front is not produced below to any rostral prominence, nor is the slightest trace of any tentacular filaments to be detected.

The tail (fig. 7) is comparatively short, scarcely exceeding in length $\frac{1}{3}$ of the anterior division, and is divided into 4 segments, which are very sharply marked off from each other. The 1st, or genital segment, as usual, is the largest, though shorter than the 2 succeeding ones combined, and is but slightly protuberant below. The last, or anal segment is both shorter and narrower than the others, and is somewhat obliquely truncated on each side at the junction with the caudal rami. The latter are very small, lamelli-form, and each carry only 3 plumose setæ, 2 of which issue from the tip, the 3rd from a distinct ledge of the outer edge. Of these setæ the middle one is the longest, and the innermost the shortest. In addition, the usual unciliated bristle occurs at the inner corner of each ramus.

No trace of any eye could be detected in the preserved specimens.

The anterior antennæ (fig. 4) are scarcely longer than the anterior division of the body, and are composed of 24 articulations, the last of which, however, is so very small, as easily to be overlooked. They are rather thickly clothed anteriorly with delicate bristles, especially in their proximal part.

The posterior antennæ (Pl. XXXI, fig. 1) are normally developed. The basal part is rather thick, and has at the end of the 1st joint a comparatively short ciliated setæ, at the end of the 2nd joint 2 much longer setæ. The inner ramus is about twice the length of the basal part, with the proximal joint somewhat compressed, and provided at some distance from the end anteriorly with a short seta. The distal joint, as usual, is lamelliform and unequally bilobed, carrying about 12 slender setæ arranged in a flabelliform manner. The outer ramus is about the length of the inner, and is divided into 7 well-defined articulations. Of these the 1st is somewhat larger than the 2nd, with which it is connected along a very oblique suture, and projects at the base anteriorly as a rounded protuberance. The 4 succeeding joints are very small, and combined are scarcely as long as the terminal joint. This ramus carries 3 apical and 5 lateral setæ.

The anterior and posterior lips (Pl. XXX, fig. 6) exhibit quite a normal appearance.

The mandibles (Pl. XXXI, fig. 2) are well developed, with the masticatory part somewhat expanded, and divided at the end into several teeth. These

are rather dissimilar, some being bidentate at the tip, some simple, and some hair-like. The outermost tooth is the largest, is unguiform, and separated from the others by a deep incision. The palp is rather large, with the basal part comparatively broad and somewhat produced at the inner corner, carrying, inside, 3 ciliated setæ. The inner ramus is well defined at the base, and projects somewhat beyond the outer, which is quite normally developed.

The maxillæ (fig. 3) differ somewhat in their structure from that usually met with, especially as regards their distal part or the palp. The masticatory lobe is well developed, and is armed with about 8 ciliated spines. The opposite vibratory plate is likewise distinct, carrying 4 long plumose setæ. The distal part of the maxilla is rather produced, and terminates in a broadly rounded lamella edged with 9 remarkably strong and curved plumose setæ. This lamella no doubt represents the outer ramus; it is, however, not at all defined at the base. Between this lamella and the masticatory lobe, the inner edge exhibits 3 successive conical projections, each tipped with a single plumose seta. The outermost of these projections, which is somewhat remote from the other 2, may answer to the inner ramus, the other 2 to the setiferous lobules found in most Calanoids between the masticatory lobe and the palp.

The anterior maxillipeds (fig. 4) are very powerfully developed, somewhat recalling those in the *Pontellidæ*. The digitiform lobes of the anterior edge are rather unequal in size, and only 4 in number, the 2 proximal ones being wholly confluent. The setæ springing from these lobes are also rather unequal, rapidly increasing in size distally, one of the 3 belonging to the outermost lobe being very much prolonged and claw-shaped. A similar character is also exhibited by 4 of the spines issuing from the short terminal part. All these claw-like spines are abruptly curved in their distal part and finely denticulate along the concave edge, their length being almost twice that of the stem of the maxilliped.

The posterior maxillipeds (fig. 5) are far less robust, and, on the whole, are built upon the same type as in the other *Temoridæ*, the 2 basal joints being somewhat lamellarly expanded, and the terminal part very flexible, composed of 5 well-defined articulations clothed with slender setæ.

Of the legs, only the 4 anterior pairs are natatory, the 5th pair being very different.

The 1st pair of legs (fig. 7) are comparatively small, and also differ in other respects from the 3 succeeding pairs. The 1st basal joint has its usual plumose seta inside, and at the inner corner of the 2nd basal joint another deflexed seta occurs, not found in the other pairs. The outer ramus is somewhat longer than the basal part, and has the first 2 joints rather broad, each carrying inside a natatory seta, but without any trace of spines outside. The last joint is somewhat shorter than the other 2 combined, and is rather narrower, having likewise the outer edge unarmed; it carries 4 natatory setæ inside, and at the tip a slender spine, outside which another much smaller spine is attached. The inner ramus is scarcely more than half as long as the outer, and is composed of only 2 joints, the last of which is the larger. It carries 5 natatory setæ, none of which issue from the outer edge.

The 3 succeeding pairs (figs. 8, 9, 10) are essentially of similar structure, and much larger than the 1st, with both rami distinctly 3-articulate, and the outer one very strongly developed, being more than twice as large as the inner. In all the 3 pairs the terminal joint of this ramus is longer than the other 2 combined, and is armed outside with 3 short spines, inside with 5 natatory setæ, and at the tip with a long spine coarsely denticulate outside. The inner ramus has likewise the last joint considerably larger than the others, and in all 3 pairs carries 10 natatory setæ, 2 of which issue outside the last joint. On a closer comparison, however, some minor differences are found to exist between these 3 pairs. Thus in the 2nd pair (fig. 8), the natatory seta of the 1st joint of the outer ramus is replaced by a short spine, and in the 3rd pair (fig. 9) a very strong deflexed spine occurs at the outer corner of the 2nd basal joint, not found in the 2nd pair. In the 4th pair (fig. 10) a similar, but much shorter spine is present, whereas the 1st basal joint is without the usual plumose seta inside.

The last pair of legs (fig. 11) are very different from the others, each forming a simple stem composed of 3 joints, of which the first 2 represent the basal part, the 3rd the outer ramus. The latter is very slender and elongated, almost twice as long as the other 2 combined, and linear in form, carrying at the tip 2 unequal spines, the inner one the longer and somewhat incurved. Otherwise these legs are quite naked.

The adult male (Pl. XXX, fig. 3) is somewhat smaller than the female, scarcely exceeding a length of 1.05 mm.

It is not very unlike the female, as regards the general form of the body, though easily recognizable by the structure of the right anterior antenna, the last pair of legs, and the tail. The latter is comparatively narrower and more regularly cylindrical in form than in the female, and is divided into 5 well-defined segments, none of which distinguishes itself by any considerable size.

The right anterior antenna (see figs. 3, 5) is very distinctly geniculate at about the distal 3rd part of its length, and has the 4 articulations preceding the geniculation rather dilated, and containing a strong muscle acting upon the terminal part. Of these articulations, the last is distinguished by a very conspicuous semilunar emargination of the anterior edge, defined proximally by a very strong spiniform process, and distally by another process of smaller size. The terminal part is considerably longer than the dilated portion, and is composed of 5 articulations, the 1st of which is the largest, and somewhat fusiform in shape, projecting at the end anteriorly in a small hamiform prominence.

The posterior antennæ, oral parts, and natatory legs exactly agree in their structure with those appendages in the female.

The last pair of legs (Pl. XXXI, fig. 12), on the other hand, are rather different, and, as usual, transformed into a prehensile apparatus, subservient to copulation. The 2 legs are rather unequally developed, the right being much the stronger. In both legs a biarticulate basal part can be distinguished, and a terminal part answering to the outer ramus, and consisting of 2 pieces, movably connected with each other, the distal one more properly representing 2 firmly connected articulations. Not the slightest trace of an inner ramus can be detected in either of the two legs. The proximal piece of the terminal part in the right leg is very large, lamellarly expanded, and of an irregular oval form, with 2 angular prominences outside, and containing a strong muscle, acting upon the distal piece. The latter is transformed into a powerful incurved claw, carrying, at some distance from the base, a small spine. On the left leg, the proximal piece of the terminal part is scarcely longer than the basal part, and not at all dilated, the inner edge being slightly insinuated in the middle, and clothed with delicate cilia. The distal piece is of about the same length as the proximal one, and terminates in a straight, denticulated spine, outside which a much smaller spine is attached.

Occurrence. This form was found in 7 of the samples, taken on the following dates: March 22nd, 1894, between March 26th and April 4th, 1894, May 22nd, 1894, May 7th, 1895, June 25th, 1895, July 30th, 1895, November 12th, 1895. One of these samples was taken from the surface of the sea, the others from depths between 100 and 200 metres.

Fam. ACARTIIDÆ.¹

23. *Acartia longiremis*, (Lilljeborg).

Some few specimens of this well-known form were found in a sample taken October 13th, 1893, north of the New Siberian Islands.

Distribution. Norwegian coast, Kattegat, the Baltic, Bay of Kiel, British Isles, coast of France.

CYCLOPOIDA.

Tribe: ISOKERANDRIA.

Fam. ONCÆIDÆ.

Gen. *Oncaea*, Philippi.

Syn: *Antaria*, Dana.

Remarks. This genus was established by Philippi as early as in the year 1843, to include a peculiar Cyclopoïd Copepod from the Mediterranean, *O. venusta*, Phil. Another species, *O. mediterranea*, was subsequently added by Claus, and Dr. Giesbrecht records no less than 8 additional species, some from the Mediterranean, some from the tropical parts of the oceans. I myself, many years ago, observed a species off the south coast of Norway, and this form has turned out to be identical with one of the Mediterranean species described by Dr. Giesbrecht as *O. conifera*. In some samples taken in the most easterly part of the polar basin traversed by the 'Fram', 2 species of this genus were found in great abundance. One of these is iden-

¹ The corresponding subfamily is termed by Dr. Giesbrecht *Parapontellina*; but as *Acartia* is of much older date than *Parapontella*, the family ought more properly to be named from that genus.

tical with the species formerly observed off the Norwegian coast, and the other is indistinguishable from a species recently described by Dr. Giesbrecht from great depths of the Pacific Ocean. The latter species will be described more in detail below. It may be here noted, that a species of this genus has been recorded (1875) by Prof. Lilljeborg from Mossel Bay in Spitsbergen, and by Mr. Bourne (1885) from Plymouth, in both cases determined as *O. mediterranea*, Claus.

24. *Oncæa notopus*, Giesbrecht.

(Pl. XXXII, figs. 1—14).

Oncæa notopus, Giesbrecht, Fauna und Flora des Golfes von Neapel: Pelagische Copepoden, p. 600, etc., Pl. 47, figs. 12, 15, 45.

Specific Characters. Body comparatively robust, with the anterior division rather tumid, oblong oval in form, greatest width about equalling half the length, and occurring in front of the middle, anterior extremity narrowly rounded. Tail not attaining half the length of the anterior division, genital segment longer than the remaining part. Caudal rami short, not nearly twice as long as they are broad, innermost apical seta longer than the outermost. Anterior antennæ with the proximal joints rather broad and compressed, 3rd joint about the length of the 2 preceding ones combined. Posterior antennæ with the terminal joint comparatively short, scarcely more than half the length of the penultimate one, and having the 2 groups of anteriorly-curving setæ close together. Posterior maxillipeds comparatively strong, dactylus shorter than the palm, and coarsely denticulate inside, the 2 palmar spines likewise spinulose and rather strong. Last pair of legs forming each a slender cylindrical piece, carrying 2 subequal spines on the tip, and extended obliquely upwards. Length of adult female 0.70 mm.

Remarks. Neither in the 3 figures given by Dr. Giesbrecht (body of female in outline, seen from the side and from above, and the left posterior maxilliped), nor in his descriptive notes, can I find any point of difference whatever between his species *O. notopus* and the polar form here in question, and I am therefore induced to believe that these two forms are in fact identical, in spite of their widely remote occurrence. The most conspicuous specific character is undoubtedly the peculiar structure of the last pair of legs, which is exactly the same in the 2 forms.

Description of the Female.

The average length of the body in fully adult specimens is 0.70 mm. Dr. Giesbrecht, on the other hand, gives the length as 0.95 mm., and this difference in size might perhaps give rise to some doubt about the identity of the 2 forms. As, however, in the next species also, the length given by Dr. Giesbrecht considerably exceeds that of polar specimens, and, moreover, Dr. Giesbrecht himself has proved, in the case of some other species, rather a wide range of variation in this respect, no great stress can, in my opinion, be laid upon this difference.

The general form of the body (see figs. 1 & 2), as compared with that of the other known species, is rather short and robust, subpyriform. The anterior division is somewhat tumefied and, seen dorsally (fig. 1), of oblong oval form, with the greatest width equal to about half the length, and occurring rather in front of the middle. It is composed of 6 well-defined segments, the 1st of which is much the largest, exceeding in length the 2 succeeding ones combined, whereas the last segment is extremely small and sharply marked off from the others, being, as in other *Cyclopoida*, very movably connected with the preceding one, so that it has more the appearance of belonging to the posterior than to the anterior division. The cephalic segment is evenly rounded anteriorly, and projects in front in a small deflexed rostral prominence, behind which the lower edges of the segment form on each side a perfectly even curve.

The tail (see fig. 4) is scarcely half as long as the anterior division, and is much narrower, sub-cylindric in form. It is composed of 4 segments, the 1st of which, the genital segment, is much larger than all the others combined. This segment is gradually somewhat dilated in front, and, unlike what is generally the case, has the 2 genital orifices on the dorsal side. In a few specimens, the 2 ovisacs were still adhering to them, each containing a very limited number of ova, generally only 4. The anal segment is a little larger than the next preceding one, and exhibits at the end dorsally a quadrangular, thin-skinned area, containing the anal orifice. The caudal rami are rather small, not nearly twice as long as they are broad, and are separated in the middle by a distinct interspace. Each ramus carries 5 setæ, 4 of which issue close together from the transversely truncated tip, the 5th from

a ledge of the outer edge, rather in front of the middle. The latter seta is very small, and this is also the case with the outermost of the apical setæ. The innermost seta is about twice as long, and distinctly ciliated, like the 2 middle ones. The latter are much longer than the others, though somewhat unequal, the inner one being considerably longer than the outer, and somewhat exceeding half the length of the tail. Moreover, from the dorsal face of each ramus an extremely delicate bristle arises, not indicated in the figure.

No trace of eyes is to be detected, and, indeed, the total absence of these organs is a character common to all the species of this genus.

The anterior antennæ (fig. 3) are shorter than the cephalic segment, and are angularly bent at the base. They are composed of only 6 articulations, the 3 proximal ones constituting a basal division, the 3 distal ones a well-defined terminal part. The 3 joints of the basal division are somewhat dilated and compressed, but rather unequal in size. The 1st joint is constricted at the base, gradually widening distally, and carries at the end anteriorly 2 slender bristles. The 2nd joint is larger than the 1st, with which it forms a geniculate bend. It carries 4 slender bristles, one of which issues near the base from a distinct ledge of the anterior edge, the other 3 from the end. The 3rd joint is about the length of the 2 preceding ones combined, and gradually tapers somewhat distally. It carries 2 successive bristles at about the middle of the anterior edge, and another bristle at the end. The terminal part is very sharply marked off from the basal part, being greatly constricted at the base, and connected with the basal part by a very mobile articulation. It is somewhat shorter than the 3rd basal joint, and of the 3 joints composing it, the 1st is much the largest, about equalling in length the other 2 combined. This part carries several very long and slender bristles, 5 of which issue from the tip.

The posterior antennæ (fig. 4) form each a simple curved stem, consisting of 3 joints, the 1st of which constitutes the basal part, the other 2 the inner ramus, no trace of an outer ramus being present. The basal joint is oblong and gently curved, with the anterior edge bulging considerably in the middle; and carrying at the end a slender bristle. The 2nd joint is shorter than the 1st, but rather broad, fusiformly dilated, and quite naked. The terminal joint is scarcely more than half as long as the 2nd, and carries 10 spiniform,

anteriorly-curving setæ, 6 of which issue close together from the tip, the other 4 from a slight protuberance of the anterior edge near the base. These 2 groups of setæ are only separated by a very short interspace.

The oral orifice occurs, at rather a long distance from the antennæ, at the tip of an obtuse protuberance projecting from about the middle of the ventral face of the cephalic segment (see fig. 2). It is bounded in front by a slight chitinous lamella, representing the anterior lip; and on each side of it the extremely small mandibles and maxillæ have their place.

The mandibles (fig. 5) each form a very small, but highly chitinized piece, the extremity of which is abruptly incurved, and produced to 2 strong cutting teeth, finely denticulated along one of their edges, and each accompanied by a slender bristle. The palp is wholly absent.

The maxillæ (fig. 6) are still smaller than the mandibles, and more membranous in structure, each carrying a single ciliated bristle inside, and 4 such bristles outside, attached to a slight lamellar expansion, the tip itself being conically produced and incurved, with 2 small apical spines.

The anterior maxillipeds (fig. 7) originate just behind the buccal protuberance, and extend obliquely in front, so that their extremities project at the sides of the oral orifice. They each consist of a thick, muscular basal part, to the end of which a more highly chitinized and incurved piece is movably articulated. This piece, which is of no considerable size, projects at the end in 2 claw-like teeth, fringed along one edge with closely-set denticles in a comb-like manner. The teeth are somewhat unequal in size, the outer one being the larger; and, as in the mandibles, they are both accompanied by a slender bristle.

The posterior maxillipeds (fig. 8), which originate immediately behind the anterior, are rather powerful, and pronouncedly prehensile, exhibiting besides the basal part, a dilated hand, upon which a strong, claw-like dactylus admits of being impinged. The basal part is quite simple, without any armature. The hand is twice as long as the basal part, and oval in form, with 2 strong, denticulated spines inside. The dactylus is very strong, somewhat shorter than the palm, and coarsely denticulated along the inner edge.

Of legs, 5 pairs are present, the 4 anterior ones being natatory, whereas the last pair are simple.

The natatory legs (figs. 9—12) are built upon the Cyclopid type, the basal part being very broad and lamellar, and both rami distinctly 3-articulate, and not differing much in size. In each pair the 2 legs are held together by a broad chitinous plate, intercalated between the 1st basal joints, so as only to admit of simultaneous movement (see fig. 9). Although these legs are of essentially the same structure, yet, on a closer comparison, several minor differences may be found to exist between them, making it necessary to describe each pair separately.

The 1st pair of legs (fig. 9) have the rami somewhat shorter than in the succeeding pairs. On the other hand, the basal part is fully as large, and has the inner corner of the 2nd joint rectangular, with a straight, deflexed spine attached to it. On the outer side of this joint, as in the 3 succeeding pairs, a small bristle is attached. The outer ramus is a little longer and also broader than the inner, and has the terminal joint about the length of the other 2 combined. Each of the latter carries outside a strong spine, but only the 2nd joint has a natatory seta inside, the 1st joint being devoid of any such seta, both in this and the 3 succeeding pairs. The terminal joint has 4 natatory setæ, and 4 spines gradually increasing in length distally, 3 of them issuing from distinct ledges of the outer edge, the 4th from the tip. All the spines, both in this and the succeeding pairs, are bordered by a hyaline, finely serrated rim. The inner ramus is fringed outside with delicate cilia, and has the terminal joint as long as the other 2 combined. It carries 7 natatory setæ, 5 of which belong to the terminal joint, which, moreover, has at the tip a spine of the same structure as those of the outer ramus.

The 2nd pair of legs (fig. 10), like the 2 succeeding pairs, have the inner corner of the 2nd basal joint produced to a short acute projection, but without any spine. Both rami are more elongated, and of about equal size, the terminal joint in both being considerably longer than the other 2 combined. The number of spines on the outer ramus is the same as in the 1st pair, but the terminal joint has one additional natatory seta. The inner ramus has only 6 such setæ, one on the 1st, 2 on the 2nd, and 3 on the last joint. On the other hand, there are 3 spines on the terminal joint, 2 of which issue from the tip, the 3rd from a ledge of the outer edge.

The 3rd pair of legs (fig. 11) have the rami still more elongated, the outer one differing from that of the 2nd pair in the absence of the proximal

spine of the terminal joint, the inner one in having only 2 natatory setæ inside the last joint¹.

The 4th pair of legs (fig. 12) have the outer ramus exactly as in the 3rd pair, whereas the inner ramus is much narrower, and projects considerably beyond the outer. This ramus also differs in having only a single natatory seta inside the terminal joint, attached at a short distance from its base.

The last pair of legs (see figs. 13 & 14), as in other *Cyclopoïda*, are very small and simple in structure, issuing somewhat laterally from the basal segment of the trunk. In most other *Cyclopoïda* the legs of this pair are biarticulate; but in the present form, the proximal joint is completely consolidated with the segment, and is only indicated by the slender bristle belonging to it, which in this case issues from the segment itself, outside the base of the distal joint. The latter is rather unlike that in the other known species of this genus, forming a slender cylindric piece provided at the tip with 2 subequal setæ. This piece extends obliquely upwards, so as to project dorsally, when the animal is viewed laterally (fig. 2): hence the specific name *notopus*, proposed by Dr. Giesbrecht for this species.

The adult male is much smaller than the female, and on the whole resembles that of the next species (conf. fig. 15). It is easily to be distinguished from the female by the more powerfully developed posterior maxillipeds, and by the structure of the tail. The latter is composed of 5 well-defined segments, the 1st of which, the genital segment, is greatly tumefied, and generally contains, within its lateral parts, 2 vesicular spermatophores ready to be evacuated. During copulation, the male grasps the female with his powerful posterior maxillipeds dorsally at the boundary between the last segment of the trunk and the genital segment; the 2 sexes are not infrequently found locked together in this manner even after having been preserved in alcohol (conf. fig. 15).

Occurrence. This form occurred very abundantly in some samples taken on the 13th October, 1893, north of the New Siberian Islands, the tow-net having been lowered to a depth of 50 metres.

Distribution. Pacific Ocean, between 90° and 124° W., 11° N. and 3° S., down to 1000 metres (Giesbrecht).

¹ In the figure here given, 3 such setæ are, by a mistake, delineated.

25. *Oncaea conifera*, Giesbrecht.

(Pl. XXXII, figs. 15, 16).

Oncaea conifera, Giesbrecht, l. c. p. 600, etc., Pl. 2, fig. 10; Pl. 47, figs. 4, 16, 21, 28, 34—38, 42, 55.

Specific Characters. Body comparatively more slender than in the preceding species, greatest width of anterior division not nearly attaining half the length. 1st pedigerous segment in female exhibiting dorsally a very conspicuous coniform gibbosity. Tail about half the length of the anterior division, genital segment scarcely longer than the remaining part of the tail. Caudal rami fully twice as long as they are broad, innermost apical seta shorter than the outermost. Anterior antennæ comparatively narrower than in *O. notopus*, 3rd joint longer than the 2 preceding ones combined, and nearly twice the length of the terminal part. Posterior antennæ with the last joint almost as long as the 2nd, and having the 2 groups of anteriorly-curving setæ separated by a rather long interspace. Posterior maxillipeds with the dactylus rather slender, and about the length of the palm, palmar spines likewise slender. 2nd, 3rd and 4th pairs of legs with the inner ramus produced at the tip, between the 2 apical spines, to a triangular projection. Last pair of legs rather small, with the distal joint short, oval, not projecting dorsally, apical setæ very unequal. Length of adult female 0.75 mm.

Remarks. This form also, at least in the female sex, is distinguished fairly well from the other species by an easily observable character, viz., the peculiar dorsal gibbosity of the 1st pedigerous segment, this character, indeed, having given rise to the specific name *conifera*, proposed by Dr. Giesbrecht. It also differs from the preceding species in several other points, mentioned in the above diagnosis. Any more detailed description of it is not, I think, needed to show its identity with the form recorded by Dr. Giesbrecht.

Occurrence. This form was found rather plentifully in the same samples, in which the preceding species occurred.

Distribution. Coast of Norway, Mediterranean, Pacific Ocean, between 87° and 132° W., 13° N. and 3° S., down to 4000 metres (Giesbrecht).

Gen. *Lubbockia*, Claus.

Remarks. This genus was established in the year 1863 by Prof. Claus, to include a peculiar pelagic Copepod found at Messina, *L. squillimana*. Another species, *L. aculeata*, has recently been added to this by Dr. Giesbrecht, both forms having been stated by the same author to occur also in the tropical parts of the oceans. North of the Mediterranean, however, neither of them have ever been recorded, and the genus has therefore been supposed to have quite a southern distribution. It was therefore very surprising to find this genus represented in the Polar Sea by a well-marked species, closely allied to one of the 2 previously known forms.

The present genus undoubtedly belongs to the same family as *Oncaea*, though differing rather markedly, both in the presence of only a single (dorsal) ovisac, and in the structure of the oral parts. The latter, as also the posterior antennæ, exhibit a pronounced resemblance in structure to those appendages in the genus *Lichomolgus*, Torell, the species of which, as is well known, live a parasitic life within the branchial cavity of Ascidians. It is, indeed, very probable, that the species both of the present genus and that of *Oncaea*, lead a semi-parasitic existence on some pelagic animals; but as yet, their hosts have not been ascertained.

26. *Lubbockia glacialis*. n. sp.

(Pl. XXXIII).

Specific Characters. ♀. Body very slender and elongated, with the anterior division somewhat tumid and, seen dorsally, oblong oval in form, somewhat more attenuated behind than in front, anterior extremity evenly rounded, penultimate pedigerous segment slightly emarginated behind, with the lateral corners scarcely produced. Tail exceedingly narrow and elongated, rod-like, about equalling in length $\frac{2}{3}$ of the anterior division, segments smooth, without any circlets of denticles behind, genital segment slightly dilated in its anterior part, anal segment scarcely more than half as long as the preceding one. Caudal rami about twice the length of the anal segment, and narrow linear in form, pointing straight behind, seta of the outer edge occurring about in the middle. Anterior antennæ 7-articulate, and clothed with very long bristles, among which a number of very delicate sensory

filaments may be discerned. Posterior antennæ with the terminal joint long and narrow, with 6 comparatively short, anteriorly-curving apical setæ, and another much longer seta issuing from a distinct ledge inside the tip. Posterior maxillipeds with the hand perfectly smooth, dactylus long and slender, finely denticulated inside. Natatory legs with the spines of the outer ramus very slender, the apical one almost attaining the length of the whole ramus, all bordered with a hyaline, smooth rim. Last pair of legs rather small, with the 2 apical spines of the same structure as those on the natatory legs, the larger one reaching only a little beyond the middle of the genital segment. Length of adult female 2.45 mm.

Remarks. This form does not agree fully with either of the 2 hitherto known species, though approaching somewhat nearer to *L. aculeata* than to *L. squillimana*. It differs materially, from the former, however, in the perfectly smooth caudal segments, as also in the relative length of these segments. Moreover, on a closer comparison, some minor differences may be found to exist in the structural details.

DESCRIPTION OF THE FEMALE.

The length of the body in fully adult specimens amounts to 2.45 mm., and this form accordingly grows to a somewhat larger size than either of the 2 hitherto known species, the larger of which (*L. aculeata*), according to Dr. Giesbrecht, has a length of 2.30 mm.

The body is highly pellucid, allowing the intestine, the anterior part of which forms a large oval dilatation (see figs. 1 & 2), to be distinctly seen through its thin walls. The general form is very slender and elongated, with the 2 chief divisions rather sharply marked off from each other. The anterior division is somewhat tumid, and, seen dorsally (fig. 1), exhibits a rather regular oblong oval or obovate form, with the greatest width not quite attaining half the length, and occurring in front of the middle. The anterior extremity appears evenly rounded, the posterior more attenuated. As in *Oncaea*, this division consists of 6 well-defined segments, the 1st of which, the cephalic segment, is about the length of the 4 succeeding ones combined. The penultimate segment is slightly emarginated in the middle, and has the lateral corners far less prominent than in *L. aculeata*, and rounded off at the tips. The last segment of the trunk, as in other *Cyclopoida*, is very

sharply marked off from the preceding one, with which it forms a very movable articulation, whereas it is firmly connected with the 1st caudal segment, so as apparently to form part of the tail. It is also much narrower than any of the preceding segments, and only very slightly dilated distally.

The tail proper (fig. 14) is exceedingly narrow, almost rod-like, and equals in length about $\frac{2}{3}$ of the anterior division. It is composed of 4 well-defined segments besides the caudal rami, all being perfectly smooth, without any traces of the circlets of denticles found in the other 2 species at the posterior edges. The genital segment is much the largest, occupying about $\frac{1}{3}$ of the length of the tail. It is slightly dilated in its anterior part, and, as in *Oncaea*, has the genital orifices situated somewhat dorsally. None of the specimens found were ovigerous; but there cannot be any doubt that the ova in the present form, as in *L. squillimana*, are congregated within a single dorsal ovisac. The anal segment is much smaller than the others, scarcely exceeding half the length of the preceding segment, whereas in the other 2 species, this segment is about the same size as the latter. The caudal rami are very slender, linear, nearly twice as long as the anal segment, and extend straight behind. They each carry 6 setæ, 4 apical and 2 lateral. One of the latter is attached close to the tip, the other at about the middle of the outer edge. Both these setæ are rather short, and this is also the case with the innermost apical seta. The remaining 3 setæ are distinctly ciliated, the middle one being much the largest, attaining nearly $\frac{1}{3}$ of the length of the tail, whereas the outer one is scarcely half as long as the inner.

No trace of eyes could be detected, and indeed in neither of the 2 previously known species have such organs been found to exist.

The anterior antennæ (fig. 3) are much shorter than the cephalic segment, and, on the whole, agree in structure with those in *Oncaea*, being clothed with slender bristles of considerable length, among which a limited number of very delicate sensory filaments may be discerned. They apparently consist of 7 joints, 4 of which belong to the basal part, the other 3 to the terminal part. The joints of the former part are, however, far from being distinctly defined. On the other hand, the lines of demarcation between the 3 joints of the terminal part are fully as distinct as in the genus *Oncaea*, which is not the case in the other 2 species.

The posterior antennæ (fig. 4) form each a very slender stem abruptly bent in front of the middle. This stem, as in *Oncea*, consists of only 3 joints, the 1st of which constitutes the basal part, the other 2 the inner ramus, the outer ramus in this instance being also quite obsolete. The basal joint is quite unarmed, and but slightly dilated distally. The 2nd joint is very small, and carries anteriorly a very delicate bristle. The 3rd joint is slender and elongated, fully as long as the other 2 combined, and is narrow linear in form. It has the posterior edge finely ciliated, and carries anteriorly 2 small bristles, separated by a long interspace. From the obtusely rounded tip, 6 comparatively short, anteriorly-curving bristles issue close together, and immediately inside them, 2 other bristles are attached to a separate ledge, one of them of considerable length.

The mandibles (fig. 5) agree with those in *Oncea* in the total absence of a palp. Otherwise, however, they are rather different, and more resemble in structure those in the parasitic genus *Lichomolgus*. As in that genus, they each terminate in a falciform lappet bordered along the convex edge with a finely serrated rim, and exerted to a thin flexible point, which projects far into the buccal cavity. Outside this lappet, a straight spine of no great size, and 2 falciform setæ are attached, and at this place the mandible is clothed with a number of delicate hairs.

The maxillæ (fig. 6) are very small and simple in structure, each terminating in a conical prominence, tipped with 2 unequal ciliated setæ, and having a thin plate outside, carrying 3 likewise ciliated setæ. This plate seems to answer to the palp, and is well-defined at the base.

The anterior maxillipeds (fig. 7) exhibit each a broad and muscular basal part, and an incurved, biarticulate terminal part. The 1st joint of the latter carries inside a strong, slightly curved spine, closely dentated along the convex edge in a comb-like manner, and opposite to it a slender ciliated seta. The 2nd joint has 2 comparatively short apical spines, the outer of which is dentated in a similar manner to the inner spine of the 1st joint.

The posterior maxillipeds (fig. 8) are rather powerful, and, as in *Oncea*, pronouncedly prehensile, consisting of a short basal joint, an oval dilated hand, and a slender, claw-like dactylus, which admits of being impinged upon the latter. Both the basal joint and the hand are quite unarmed, whereas in the other 2 species, the palmar edge is divided into a number of dentiform

projections. The dactylus is very slender, fully as long as the palm, and but slightly curved, with the inner edge finely denticulate.

The natatory legs (figs. 9—12) are built upon the very same type as in *Oncaea*, though exhibiting some minor differences, both as to the basal part and the rami. The 1st basal joint in all pairs except the 4th, has a plumose seta inside, that is wanting in *Oncaea*; and the inner corner of the 2nd joint is broadly rounded and perfectly smooth, the terminal edge projecting, in all the pairs, between the insertions of the rami, in a well-marked triangular prominence. The rami agree closely in structure with those in *Oncaea*, and carry the very same number of spines and natatory setæ. The spines, however, are much more slender, and the hyaline rim appears quite smooth. The apical spine of the outer ramus almost equals in length the whole ramus.

The last pair of legs (see figs. 13 & 14) form each a small cylindrical piece attached to the sides of the last segment of the trunk, and more properly representing the distal joint, the proximal joint being wholly consolidated with the segment. At the end of this piece are 2 unequal spines, both of exactly the same structure as the spines of the natatory legs. The inner and larger spine extends only a little beyond the middle of the genital segment, whereas in *L. aculeata*, it reaches nearly to the posterior edge, and in *L. squillimana* even projects beyond the limits of this segment.

Occurrence. Some few specimens of this peculiar Copepod, all of the female sex, were found in a sample taken May 22nd, 1894, between the 81st and 82nd degrees of latitude, the tow-net having been lowered to a depth of 100 metres.

Tribe: **AMPHARTHANDRIA.**

Remarks. This tribe is here taken in a more restricted sense than is done by Dr. Giesbrecht, who comprises in it all Copepoda in which both antennæ of the 1st pair in the male are prehensile. In my opinion, the 2 families *Monstrillidæ* and *Harpacticidæ* are so very distinct, that they ought both to be regarded as great divisions equivalent to the division *Calanoida*, only the *Cyclopoid* forms with the above character being kept in the tribe.

Fam. OITHONIDÆ¹.Gen. *Oithona*, Baird.

Remarks. Of this genus, 2 distinct species occur off the Norwegian coast, one of them being more than twice as large as the other. Boeck records these 2 species under the names *O. spinifrons* and *O. pygmaea*. The first-named form is most probably identical with *O. plumifera*, Baird, the 2nd with *O. helgolandica*, Claus, both these names having the priority to those proposed by Boeck. In Dr. Giesbrecht's opinion, both the Norwegian forms recorded by Boeck are identical with the Mediterranean species described by Claus as *O. similis*. This is evidently erroneous, since, as stated above, the 2 Norwegian forms are very distinct the one from the other. Nor can I admit the assumption of Dr. Giesbrecht, that *O. helgolandica* and *O. similis* are identical, as it seems hardly probable that Claus would have described the very same species under 2 different names. In the Polar Sea, this genus is represented by a single species, which has turned out to be identical with one of the 2 forms occurring off the Norwegian coast.

27. *Oithona helgolandica*, Claus.

Syn: *Oithona pygmaea*, Boeck.
 " " *spinifrons*, Brady (not Boeck).
 " " *spirostris*, Giesbrecht (not Claus).

Some few specimens of this form were found in 2 samples taken October 12th and 13th, north of the New Siberian Islands.

Distribution. Coast of Norway (very common), British Isles, Heligoland, Bay of Kiel.

Fam. MORMONILLIDÆ.

Gen. *Mormonilla*, Giesbrecht.

Remarks. The systematic position of this remarkable genus, established by Dr. Giesbrecht, appears somewhat doubtful, since only one sex, the female one, is as yet known. I think, however, that Dr. Giesbrecht is quite

¹ I think the establishment of this family is necessary. Dr. Giesbrecht refers the genus *Oithona* to the family *Cyclopidae*.

right in referring it to his tribe *Ampharthrandria*, and it will unquestionably also be found to belong to this tribe in the restriction here adopted, exhibiting, as it does, no affinity whatever to either the *Monstrilloida* or *Harpactoida*, whereas the *Cyclopoïd* type is unmistakable. In general appearance, this genus somewhat recalls that of *Oithona*, but in its structural details it differs to an extent that does not allow of its being included in the same family, the new family *Mormonillidæ*, established by Dr. Giesbrecht, being evidently needed for its reception. Dr. Giesbrecht records 2 species of this genus, viz., *M. phasma* and *M. minor*, both taken in the Pacific Ocean south of the equator, from great depths (1800 metres). The occurrence of a species of this genus in the Polar Sea is of considerable interest, and, in order to ascertain the relation of this form to the 2 species described by Dr. Giesbrecht, I have subjected the specimens to a very careful examination, without, however, having come to a definite conclusion as to whether the polar form is or is not identical with one of them. It seems to agree best with the species named by Dr. Giesbrecht *M. minor*; but the agreement is not quite perfect, and, as the places where these 2 forms were found are so widely remote, I prefer to describe the polar form provisionally as a new species, leaving the ultimate decision regarding the identity or non-identity of the two forms for future investigations.

28. *Mormonilla polaris*, n. sp.

(Pl. XXXIV).

Specific Characters. — ♀. Body very slender, with extremely thin and pellucid integuments. Anterior division oblong fusiform, slightly depressed anteriorly, with the greatest width occurring rather in front of the middle; anterior extremity, seen dorsally, obtusely truncate, posterior greatly attenuated. 1st pedigerous segment well defined from the cephalic segment, and rather large, exceeding in length the succeeding ones combined. 4th pedigerous segment very slightly emarginated behind, and having the lateral corners scarcely produced at all. Last segment of trunk not broader than the caudal segment, and quite simple, without any trace of appendages. Tail, inclusive of the caudal rami, somewhat exceeding half the length of the anterior division, genital segment evenly rounded below, anal segment much larger than the middle one. Caudal rami exceedingly slender and elongated, equalling in

length the caudal segments and the last segment of the trunk combined, lateral seta occurring at the end of the first 5th part of the ramus. Anterior antennæ fully as long as the anterior division of the body, and composed of only 3 distinct joints clothed with very strong setæ, which, as a rule, issue from cup-shaped ledges; 1st joint somewhat longer than the other 2 combined, the latter about equal in size. Posterior antennæ with the outer ramus about the length of the proximal joint of the inner, and 7-articulate. Outer ramus of the 3 anterior pairs of legs distinctly 3-articulate, that of 4th pair biarticulate; inner ramus of 1st pair 3-articulate, of 2nd pair biarticulate, of 3rd and 4th pairs unarticulate. Length of adult female 1.38 mm.

Remarks. As mentioned above, this form seems to be closely allied to one of the species recorded by Dr. Giesbrecht, viz., *M. minor*. Of this species, however, only 2 detail-figures have been given (a posterior maxilliped and a 2nd leg), and it is therefore as yet scarcely possible to institute any closer comparison between these 2 forms.

Description of the Female.

The length of the body, measured from the front to the end of the caudal rami, is 1.38 mm. Dr. Giesbrecht gives the length of his *M. minor* as 1.25—1.35 mm., and that of *M. phasma* as 1.58—1.73 mm.

The whole body, even in the preserved state, is so perfectly hyaline, that it was a matter of no little trouble to pick up the specimens from the sample. The general form of the body (see figs. 1 & 2) is slender and elongated, with no very sharp demarcation between the 2 chief divisions, though the posterior is much narrower than the anterior. The latter division is somewhat depressed, especially in its anterior part, and, seen dorsally (fig. 1), exhibits an oblong fusiform shape, with the greatest width not attaining $\frac{1}{3}$ of the length, and occurring considerably in front of the middle. It gradually tapers behind, somewhat less in front, and has the anterior extremity obtusely truncated. The cephalic segment is well defined, and occupies about $\frac{2}{5}$ of the length of the anterior division. Seen laterally (fig. 2), the dorsal face of this segment declines obliquely towards the front, which appears narrowly rounded, and slightly deflexed between the insertions of the anterior antennæ. The 1st pedigerous segment is rather large, exceeding in length the 2 succeeding segments combined. The penultimate segment is only very

slightly emarginated behind, and has the lateral corners scarcely at all produced. The last segment, as in other *Cyclopoida*, is very movably connected with the preceding one, and much narrower, being scarcely broader than the caudal segments. It is quite simple, subcylindric in form, and does not exhibit the slightest trace of any limbs.

The tail proper is about half the length of the anterior division, and is composed of only 3 segments, besides the caudal rami. The 1st or genital segment, as usual, is the largest, equalling in length the other 2 combined; and it is but very slightly dilated in its anterior part, with the ventral face a little protuberant, exhibiting the genital orifices on each side. How the ova are carried is still unknown, as no ovigerous specimens have as yet been met with. It is not improbable, that they are congregated within a single ovisac, which in this instance may be ventral, as in the *Calanoids*. The last, or anal segment is considerably larger than the middle one, and is transversely truncated at the end. The caudal rami (see fig. 12) are exceedingly slender and elongated, equalling in length the remaining part of the tail and the last segment of the trunk combined. They are narrow linear in form, and slightly divergent, with the inner edge finely ciliated throughout. The outer edge, on the other hand, is ciliated for a very short distance proximally, and has, at about the end of the first 5th part, a distinct ledge, to which a very slender seta is attached, extending behind almost to the tip of the ramus. The latter is transversely truncated, and carries 5 setæ, the outermost and innermost of which are very small, hair-like. The other 3, like the lateral seta, are distinctly ciliated, and of rather unequal length, the middle one being much the longest, and fully twice the length of the ramus. Of the other 2, the inner one is 3 times as long as the outer. A very delicate and slender bristle is also attached to each ramus close to the tip dorsally.

As in the other 2 species, no trace of eyes is found.

The anterior antennæ (see figs. 1 & 2) are slender and elongated, reaching, when reflexed (see fig. 2), somewhat beyond the genital segment. In spite of their great length, they are found to be composed of a very limited number of joints, only 3 of them being distinctly defined. Of these the 1st is somewhat longer than the other 2 combined, the latter being of about equal length. All the joints carry scattered setæ of unequal size, some of

them very strong, and issuing from cup-shaped ledges. From the last joint 7 or 8 such setæ originate, forming together a large brush.

The posterior antennæ (fig. 3) somewhat resemble in structure those in the *Calanoida*, having both rami well developed. The basal part is comparatively small, with its 2 joints imperfectly defined, and carries at the end anteriorly a single ciliated seta. The inner ramus is gently curved, and consists of 2 nearly equal-sized joints, the 1st of which exhibits a distinct ledge somewhat beyond the middle of the anterior edge, carrying 2 unequal setæ. The distal joint is somewhat constricted at the base, and very slightly dilated in its outer part, exhibiting traces of the bilobular form characteristic of the *Calanoida*. The anterior lobule, however, is only indicated by a very slight bulging of the anterior edge, carrying 3 or 4 successive setæ increasing in length distally. From the transversely truncated tip, 8 or 9 very slender setæ originate very close together, some of them much elongated, considerably exceeding in length the whole antenna. All the setæ are fringed with stiff hairs, unequal, and rather far apart. The outer ramus is about the length of the proximal joint of the inner, and cylindrical in form, being divided into 7 well-defined joints, the 1st of which is the largest, all the others very short. It carries in all 10 ciliated setæ of moderate length, 2 of which issue from the 1st, 3 from the last joint.

The mandibles (fig. 4) likewise recall somewhat those in the *Calanoida*, both in the structure of the masticatory part, and in the very full development of the palp. The masticatory part is rather broad, securiform, and has the cutting edge divided into 8 comparatively small and simple teeth, the outermost of which is the largest, and separated from the others by a deep incision. The palp is considerably larger than the body of the mandible, and is distinctly biramous, with the basal part oblong quadrangular in form, and carrying 3 setæ inside, 2 at the end, and one somewhat beyond the middle. Both rami are uniaarticulate and lamellar in structure, about equal in size, but of somewhat different shape. The inner ramus is oval in form, and carries along the oblique inner edge a row of 6 remarkably large and coarsely ciliated setæ, increasing in length distally. The outer ramus, which issues from the basal part somewhat more proximally, has the form of a triangular lamella, which likewise carries 6 large, ciliated setæ.

The maxillæ (fig. 5) are of more complicated structure than is usual in the *Cyclopoidea*, and, indeed, all the chief parts found in the *Calanoida* may be easily traced. The basal division is well defined, and projects inside to a conical masticatory lobe armed at the tip with 3 ciliated spines, and a similar number of short, likewise coarsely ciliated bristles. Opposite this lobe, on the outer side of the basal part, is a very small lobule carrying 2 densely plumose setæ, and apparently answering to the vibratory plate in the *Calanoida*. The palp is of considerable size, membranous in consistency, and distinctly biramous. The inner edge is divided proximally into 2 successive conical lobules, each carrying 2 unequal setæ, and evidently answering to the 2 setiferous lobes generally found in the *Calanoida*, immediately beyond the masticatory lobe. The distal part of the palp beyond these lobules, is somewhat produced, and carries 8 remarkably strong curved setæ, coarsely ciliated and successively increasing in size distally. On a closer examination, 4 of these setæ are found to issue from a well-defined, though rather short, terminal joint, which evidently represents the inner ramus. The outer ramus forms a rather large, rounded oval plate, issuing outside the proximal part of the palp, and carrying 6 very strong and densely ciliated setæ, 5 of which issue from the obtusely truncated end, the 6th from a ledge of the outer edge.

The anterior maxillipeds (fig. 6) are also rather unlike those in the typical *Cyclopoidea*, and exhibit some points of agreement with those in the *Calanoida*. They are comparatively large, and in all the specimens examined, were extended backwards along the sides of the 1st pedigerous segment (see figs. 1 & 2). They each consist of a slightly curved stem divided into 5 joints, the first 2 being rather large, and together constituting the basal part, whereas the other 3 are very small. There are 3 distinct digitiform lobes of the anterior edge, one belonging to the 1st basal joint, the other 2 to the proximal part of the 2nd basal joint. The first 2 lobes are rather narrow and somewhat upturned, each carrying 3 coarsely ciliated setæ, whereas the 3rd lobe has only 2 such setæ. Moreover a single, rather short seta occurs at some distance beyond the 3rd lobe. It may be noted, that Dr. Giesbrecht in *M. phasma* has found a 4th, very small lobe, issuing close to the base, and carrying 4 comparatively short setæ. It is very probable that a similar lobe also exists in the present species, but has been lost in

the dissection. From the very short terminal part, 5 very long and curved setæ issue, 3 of which belong to the last joint, which, moreover, carries a short, simple bristle.

The posterior maxillipeds (fig. 7) are somewhat shorter than the anterior, and are composed of only 2 distinctly defined joints, movably articulated together. The proximal joint is rather broad and expanded, with the anterior edge cut out into 3 successive rounded lobes, each carrying a remarkably thick and densely hairy seta curved obliquely upwards. This seta is accompanied on the proximal lobe by another seta of much smaller size, and on the distal lobe by 2 still smaller, hair-like bristles. Moreover, a ciliated, anteriorly-curving seta of quite normal appearance issues from a small knob-like prominence near the end of the joint anteriorly. The distal joint is scarcely more than half as long as the proximal one, and much narrower, exhibiting at the tip an imperfectly defined, very small terminal articulation. It carries 5 anteriorly-curving, ciliated setæ, diminishing in length distally, and also a very small apical bristle. In structure, these maxillipeds agree very closely with those in *M. minor*, as figured by Dr. Giesbrecht.

The natatory legs (figs. 8—11) successively diminish in size posteriorly, and exhibit a rather peculiar structure, differing considerably from that usually met with in the *Cyclopoida*.

The 1st pair of legs (fig. 8) have the basal part much larger than in the other pairs, and lamellar in structure, its 1st joint being particularly large, and provided at the end inside with a small unciliated bristle. The 2nd basal joint has the inner edge somewhat bulging in the middle, and exhibiting there 3 extremely small, hair-like bristles, below which a somewhat longer, but unciliated seta is attached. Both rami are 3-articulate, though the line of demarcation between the first 2 joints of the inner ramus is far from being distinct. The outer ramus is considerably larger than the inner, and has the 1st joint longer than the other 2 combined. At the end, this joint projects outside to a short spiniform process, but has no seta inside. Outside the 2nd joint is a similar, but somewhat larger spiniform process, and inside a very strongly developed natatory seta. The 3rd joint, which is but little larger than the 2nd, carries 4 long natatory setæ, 2 of which issue from the tip; and it exhibits outside 2 successive spiniform processes, which are still more produced than those of the 2 preceding joints.

The inner ramus has the 1st joint almost as long as the other 2 combined, and considerably broader, with 2 hair-like bristles inside. The 2nd joint has a similar bristle inside, and the 3rd joint carries 3 natatory setæ, the 2 apical ones being very long, whereas the 3rd, which issues from a ledge inside, is considerably shorter, and is peculiarly twisted in its distal part.

The 2nd pair of legs (fig. 9) have the basal part quite simple, without any bristles or setæ. The outer ramus, as in the 1st pair, is distinctly 3-articulate, with the 1st joint much longer than the other 2 combined. This joint is finely ciliated along the inner edge; but the outer edge is perfectly smooth, without any armature whatever. This is also the case with the 2nd joint, which, however, carries the usual natatory seta inside. The 3rd joint is somewhat larger than the 2nd, and carries 5 natatory setæ, and, outside the 2 apical ones, a very small ciliated bristle. The inner ramus is both shorter and narrower than the outer, and is composed of only 2 joints, the 1st quite simple, the 2nd, in addition to the 3 setæ found in the 1st pair, carrying inside them a very small ciliated bristle.

The 3rd pair of legs are of the same structure as the 2nd, except that the inner ramus (fig. 10) is uniarticulate.

The 4th pair of legs (fig. 11) are considerably smaller than the others, and have the outer ramus biarticulate, with 5 natatory setæ, 4 of which belong to the distal joint. The inner ramus, as in the 3rd pair, is uniarticulate, and much smaller than the outer, carrying 3 natatory setæ of about equal size, 2 apical and one lateral.

As stated above, not the slightest trace of any 5th pair of legs is to be detected.

Occurrence. Some few specimens of this remarkable Copepod, all of the female sex, were found in the same sample in which the above-described *Lubbockia glacialis* occurred.

*OSTRACODA.*Tribe: **MYODOCOPA.**Fam. **CONCHÆCIIDÆ.**Gen. *Conchæcia*, Dana.

Remarks. This genus was established in the year 1853 by Dana, to include 2 peculiar pelagic Ostracoda from the tropical parts of the oceans, and some years afterwards a 3rd species from the Atlantic Ocean was added by Lubbock, though referred by him to the nearly-allied genus *Halocypris*. The first statement of the occurrence of this genus also in the northern oceans, was made by the present author, who, in the year 1865, recorded 3 Norwegian species, 2 of which were taken from great depths off the Lofoten Islands. In recent times, a number of additional species have been described from different parts of the oceans, and among them is a form recorded by Messrs. Brady and Norman, which seems to be peculiar to the Arctic Ocean, and which also occurred very abundantly in the samples brought home from the Nansen Expedition. As only a very short description, accompanied by some few figures, has been given by Messrs. Brady and Norman, I propose in the following pages to describe this beautiful and large-sized form more in detail, giving figures, on the last 2 plates, of both sexes, with anatomical analyses of each.

Conchæcia maxima, Brady & Norman.

(Pl. XXXV & XXXVI).

Conchæcia maxima, Brady & Norman, A Monograph of the marine and fresh-water Ostracoda of the North Atlantic and North-western Europe, Part II. Transact. Roy. Dublin Society, Vol. V, p. 686, Pl. LXI, figs. 1—8.

Specific Characters. Shell of female moderately tumid, seen laterally, oblong oval in form, somewhat widening behind, greatest height not quite equalling half the length, rostral prominence well defined and very slightly deflexed, subrostral notch rather deep, anterior extremity below the latter narrowly rounded, posterior obtusely truncated, ventral margin very slightly

sinuated in the middle, dorsal straight, with a slight depression in the middle, and joining the hind margin at an obtuse angle: — seen ventrally, regularly oblong ovate, greatest width somewhat exceeding $\frac{1}{3}$ of the length, and occurring in the middle, anterior extremity narrowly subtruncate, posterior acute. Shell of male comparatively narrower than that of female, sub-cuneate, with the posterior extremity (seen laterally) obliquely truncated, and the ventral margin more distinctly sinuated. Valves thin and pellucid, sculptured with 2 sets of curved striæ crossing each other, and producing a close, but not very conspicuous reticulation, postero-dorsal corner armed with 3 or 4 small blunt teeth, somewhat increasing in size posteriorly. Extremity of frontal tentacle in both sexes club-shaped, hispid, but in male thicker and more sharply marked off at the base. Antennulæ in male with the 2 sensory appendages of about equal size, anterior apical seta much longer than the other 2, and having the median part somewhat thickened, and armed with numerous recurved denticles, its distal 3rd part abruptly bent downwards. Claw of accessory ramus of male antennæ much larger on the right than on the left side. Basal joint of mandibular palp about the length of the 2 succeeding joints combined. Caudal lamellæ each with 8 slender claws rapidly increasing in length anteriorly, the last, as usual, somewhat remote from the others, all being finely denticulate along the posterior edge. Length of adult female 3.50 mm., of male 3.20 mm.

Remarks. This form is very closely allied to one of the Norwegian species recorded by the present author under the name of *C. borealis*. It is, however, of larger size, and differs moreover, in the less strongly marked sculpture of the shell, as also somewhat in the form of the latter. On a closer comparison, some minor differences may also be found to exist in the structure of the several appendages.

Description of the Female.

The average length of the shell in fully adult specimens is 3.50 mm., and Messrs. Brady and Norman have even examined specimens of 3.60 mm. length. This is a size not nearly reached by any of the other known species, and this form therefore still deserves the specific name *maxima* proposed by Messrs. Brady and Norman.

The general form of the shell (see Pl. XXXV, figs. 1 & 2) is that characteristic of the genus *Conchœcia*, being rather elongated, with the anterior extremity produced above to a well-marked rostriform prominence, below which, there is a distinct notch on each side. Seen laterally (fig. 1), it exhibits an oblong oval, or rather somewhat cuneiform shape, being conspicuously narrowed in front, with the greatest height not quite attaining half the length, and occurring in its hindmost part. The rostral prominence, in this view of the shell, appears as a distinctly defined, beak-like process, projecting in front, and very slightly deflexed at the tip. Immediately below it, the shell has a rather deep sinus or notch, from which, in some cases, the natatory ramus of the antennæ may be found extended. The anterior extremity of the shell, below this notch, is narrowly rounded, the margin sloping without any intervening angle into the ventral one. The latter is somewhat oblique, and very slightly sinuated in the middle, joining the posterior margin by an abrupt curvature. The hind extremity of the shell appears broadly rounded, or rather obtusely truncated, and forms an obtuse angle above. The dorsal margin is nearly straight, and horizontal, with a very slight depression at about the middle.

Seen dorsally or ventrally (fig. 2), the shell appears moderately tumid, and rather regularly oblong ovate in form, with the greatest width about the middle, and somewhat exceeding $\frac{1}{3}$ of the length. The lateral contours are evenly curved throughout, and the posterior extremity is acute, whereas the anterior appears considerably broader, and is obtusely truncated at the tip. The dorsal face of the shell is somewhat applanated, especially in its anterior part, whereas ventrally, the valves meet at an acute angle.

The valves are perfectly equal, and are united along the dorsal face by a simple ligament, admitting of being opened to a certain extent, and again closed; but anteriorly, below the rostral prominence, there always remains a somewhat cordiform opening leading to the inner cavity of the shell. As to consistency, the valves are very thin and elastic, and of chitinous structure; and they are so pellucid, that the enclosed animal may be traced through them rather distinctly. The surface is sculptured with two sets of curved striæ crossing each other, and producing a somewhat irregular and close reticulation, which, however, is far from being so strongly marked as in the nearly-

allied species *C. borealis*, where it assumes in some places an imbricated, squamous character. At the upper posterior corner there are 3 or 4 successive small denticles, somewhat increasing in size posteriorly. These denticles are, however, as a rule, only present on the right valve. The free edges of the valves are perfectly smooth throughout their whole length.

The animal is enabled to withdraw itself completely into the shell; but more generally the tip of the frontal tentacle, the terminal appendages of the antennulæ, and the natatory ramus of the antennæ are seen projecting in front from the above-mentioned opening, and below, the tip of the mandibular palps and the caudal plates, as a rule, also project beyond the edges. The animal is fixed to the shell by a strong adductor muscle joining each valve at about the centre, and just above this muscle, it is suspended to the dorsal face by a comparatively short ligament, within which the heart has its place. We may distinguish 2 chief divisions of the body, an anterior or cephalic part, and a posterior or abdominal part, both defined by the above-mentioned dorsal ligament and by the adductor muscle. The anterior division is, as it were, cut off in front, even being somewhat concave in its upper part, whereas below it projects into the hood-like anterior lip. It carries the antennulæ above, and between them a very delicate tentacular appendage. The enormously developed antennæ are attached to the sides, and below, the mandibles with their palps, and the maxillæ originate. The posterior, or abdominal division is very voluminous, and freely mobile within the hollow of the shell. It is covered by a soft skin closely wrinkled transversally, and is deflexed, exhibiting dorsally, at about the middle, 2 successive short prominences. Below, this division carries 3 pairs of legs, and to the gradually tapering and somewhat anteriorly curving end, the coarsely spinous caudal plates are secured.

The frontal tentacle (see fig. 4) is very delicate, extending as a narrow rod straight in front, and terminating in a slightly dilated, oblong fusiform, and somewhat deflexed capitulum, which is finely hispid throughout, and projects just beneath the rostral prominence of the shell.

The antennulæ (ibid) are likewise of rather delicate structure, and, it would seem, are scarcely mobile. They each form a simple stem extending anteriorly, at each side of the frontal tentacle, and about equalling in length

the rod-like portion of the latter. This stem seems to be composed of 4 joints, which, however, are far from being distinctly defined. The first 2 joints are rather elongated, and of about equal size, the 2nd carrying above, at some distance from the tip, a slender anteriorly-curving seta. The 2 distal joints are very small, and curve abruptly downwards, forming together a short terminal part. To the end of this part, 4 subequal and very delicate sensory filaments are attached, and in front of them a very slender seta, which projects far from the tip of the rostral prominence. Within the basal joint, a number of irregularly arranged lenticular bodies of a dark brownish colour may be traced, imbedded in a ganglionic mass. These bodies, which also occur in other species of this genus, seem to represent a sort of imperfect visual organs.

The antennæ (fig. 5) are very powerfully developed, constituting the chief locomotory organs of the animal. They each consist of an exceedingly large and broad basal part, and 2 very unequal rami. The basal part almost attains half the length of the shell, and is extended anteriorly. It is oblong triangular, or obpyriform in outline, with the hind extremity very broad and somewhat obliquely rounded, the anterior tapering gradually. Its inner face is applanated, whereas the outer is convex, and within it numerous strong muscles are seen converging to the anterior extremity, and chiefly acting upon the outer, or natatory ramus. The latter is very movably articulated to the end of the basal part, and somewhat exceeds half its length. It is narrow cylindrical in form, and divided into 7 joints, the first of which is about 3 times as long as all the others combined. The latter form together a well-defined and very flexible terminal part of oblong fusiform shape, carrying, in all, 9 densely plumose natatory setæ, which successively increase in length proximally, and admit of being spread out in a fan-like manner. On a closer examination, these setæ are found to terminate in a naked lanceolate point of membranous consistency, and probably sensory in character. The inner, or accessory ramus is attached at some distance from the tip of the basal part inside, and, as a rule, extends downwards. It is composed of only 2 joints, the 1st of which has the form of a rounded, membranous lamella projecting anteriorly into 2 small successive prominences, the proximal one quite simple, acute, the distal one more prominent, and carrying 2 short setæ. The last

joint is very small and is movably articulated to the 1st, admitting, by the aid of 2 distinct muscles joining it, of being extended in front or reflexed. It carries on the tip 5 setiform appendages, the middle one being twice as long as the others, which are sensory in character.

The oral orifice (see Pl. XXXVI, figs. 1 & 2) is bounded by 2 well-defined lips, the anterior of which is very large, forming in front a very prominent, hood-like expansion, which is visible immediately below the basal part of the antennæ (see Pl. XXXV, fig. 1). The posterior edge, bounding the oral orifice in front, is highly chitinized and somewhat produced in the middle, exhibiting, on each side, a closely striated lamellar border. The posterior lip projects in 2 movable, incurved lappets of a somewhat securiform shape, and finely ciliated at the edges. Immediately behind this lip, the so-called sternal plate occurs, and from it several chitinous fillets originate, extending in different directions, to strengthen the insertions of the post-oral appendages.

The mandibles (Pl. XXXV, fig. 6), unlike what is generally the case in this division of Ostracoda, exhibit each a well-defined and highly chitinized body of narrow cuneiform shape, extending obliquely anteriorly across the sides of the cephalic part, immediately behind the basal part of the antennæ (see fig. 1). The masticatory part is defined by a neck-shaped constriction, and is squeezed in between the anterior and posterior lips. It is highly chitinized, and of a brownish hue, projecting in front to a short dentiform prominence. The cutting edge is divided into several short teeth, and immediately inside it is a closely fluted and hairy triturating surface, representing the molar tubercle (see fig. 7). The palp is very large and pronouncedly pediform, extending in front, on each side of the anterior lip, with the distal part curved downwards. It is composed of 4 well-defined joints, the 1st of which is much the largest, about the length of the 2 succeeding ones combined, and considerably dilated in its proximal part. This joint forms a rather large expansion below, with several slender setæ on the outer face, and extending as far as the tip of the masticatory part, outside which it lies. The narrowly truncated end of this expansion is divided into a row of short teeth, which no doubt assist the mandibles in cutting the food asunder. From the upper edge of this joint, at some distance

from the tip, a densely plumose seta originates. The 3 distal joints constitute together a very movable terminal part, which, as a rule, forms, with the basal joint, an abrupt geniculate bend. The joints gradually diminish in size, and carry scattered setæ, some of which are ciliated along one of the edges. Two of these setæ, issuing from the tip of the last joint, are particularly strong, almost claw-shaped.

The maxillæ (fig. 8) consist each of a thick, muscular basal part projecting inside in 2 linguiform masticatory lobes clothed with spiniform setæ, the outer one being somewhat larger than the inner. Outside these lobes, a well defined palp is movably attached, extending below. It consists of 2 joints, the 1st of which is rather large and expanded, oblong oval in form, and carries anteriorly 5 slender curved setæ, posteriorly 3 similar but shorter setæ and 2 small spines. The distal joint is rather small, and abruptly recurved, carrying several strong, curved spines at the tip.

The 2 succeeding pairs of limbs (Pl. XXXVI, figs. 3 & 4) have each, at the base outside, a trilobate vibratory (branchial) plate, placed vertically, and fringed with densely plumose setæ, the number of which is from 14 to 18. Both these pairs are pronouncedly pediform, whereas in other *Myodocopa*, the anterior pair have wholly lost their pediform character, and are generally described as a 2nd pair of maxillæ. In the present form, it is also found, that this pair, though, on the whole, resembling the succeeding one, exhibit some characters indicating that they are not exclusively locomotory, but also subservient to mastication. They are each composed (see fig. 3) of 4 distinctly defined joints, the 1st of which, however, differs materially from the others, forming a rather large and expanded basal part, provided at the anterior edge with several ciliated setæ, and, moreover, projecting at the end anteriorly in an obtusely conical prominence, densely clothed with spiniform setæ. This prominence is turned towards the mouth, and undoubtedly has the signification of a true masticatory lobe. The 3 distal joints form together a very movable terminal part or palp, which is about the length of the basal part, and is generally extended obliquely behind, almost at a right angle with the former. Its 1st joint is rather broad at the base, gradually tapering distally, and is clothed with several ciliated setæ on both edges. The 2nd joint is of about the same length, but much narrower, subcylindric in form,

and carries one ciliated seta behind, and 2 in front. The last joint is very small and carries, on the tip, 2 slender claws of somewhat unequal size, and in front of them a simple bristle.

The succeeding pair of limbs (fig. 4) are considerably longer than the preceding pair, and have the basal joint quite simple, without any spiniferous projection at the end, but provided there with only 2 plumose setæ. The terminal part is almost 3 times as long as the basal one, and is divided into 4 well-defined joints; it otherwise resembles in structure that of the preceding pair, and is likewise generally extended obliquely behind.

The last pair of limbs (fig. 5) are very small and simple in structure, extending, as a rule, obliquely upwards across the sides of the abdominal portion of the body. They each form a slightly tapered stem, exhibiting an imperfectly defined, small terminal joint, which carries 2 very slender setæ, one of which is more than twice as long as the stem. The function of these limbs cannot be locomotory, since they do not admit of being extended from the shell, whereas they most probably serve the same purpose as the peculiarly modified last pair of limbs in the *Cypridinidæ*, viz., that of cleansing the body from foreign matter introduced into the shell-cavity.

The caudal lamellæ (comp. fig. 10) are not very large, and are of semi-circular form, being movably articulated to the end of the abdominal division. They are not exactly juxtaposed, the one advancing somewhat beyond the other; and each is armed with 8 slender claws, rapidly increasing in length distally, the foremost claw being considerably elongated, and placed at some distance from the others. The claws are finely denticulated along their concave edge, and are movably articulated to the plate, which projects between them in small dentiform processes. At some distance behind the claws, 2 very small juxtaposed bristles occur.

The adult male (Pl. XXXV, fig. 3) is easily recognizable from the female, both as regards the shell and the enclosed animal.

The shell measures 3.20 mm. in length, and is accordingly somewhat smaller than that of the female. Seen laterally (fig. 3), it also appears rather narrower, with the posterior extremity more obliquely truncated, and the upper posterior corner somewhat more prominent. The ventral margin, moreover, is more distinctly sinuated in the middle.

The frontal tentacle (see Pl. XXXVI, fig. 6) has the capitulum more tumefied, and very sharply marked off from the rod-like peduncle, which appears to be divided into 2 segments.

The antennulæ (*ibid.*) are much more powerfully built than in the female, and the joints are more sharply marked off from each other. The musculation is also stronger, indicating a freer mobility of these limbs, the muscles occupying the 2nd joint, and acting upon the terminal part, being especially conspicuous. The slender seta issuing from the upper edge of this joint in the female is replaced by a short hook-like spine, curving inwards. The apical appendages are present in the same number as in the female; but they are all more or less transformed. The foremost seta is very strong, and has the distal 3rd part abruptly bent downwards, the median part being thickened, and armed below with recurved spinules. Of the 4 uniform sensory filaments present in the female, only 2 have retained their sensory character, the hindmost exhibiting, however, a peculiar twisted form, and extending straight behind. In the present species, these 2 sensory appendages are of about equal size, whereas in other species their length is rather different. The 2 remaining appendages have both assumed the character of slender setæ, much longer than the 2 above-mentioned sensory appendages, though not nearly attaining the length of the foremost seta. On a closer examination, only 3 of these appendages are seen to issue from the last joint, whereas the other 2, one sensory and one setiform, are attached inside the penultimate joint.

The antennæ resemble in structure those in the female, as regards the basal part and the natatory ramus. On the other hand, the accessory ramus is conspicuously transformed, and developed into a prehensile organ, terminating in an anteriorly-curving claw, in addition to the apical appendages. This claw is much larger on the right (fig. 7) than on the left antenna (fig. 8), and a similar asymmetry is also found in the other species, probably having some relation to the asymmetrical arrangement of the genital apparatus.

Of the other limbs, only the penultimate pair, or the 2nd pair of legs (fig. 9), differ somewhat from those in the female. They are, on the whole, more powerfully developed, and each carry at the tip, 3 very long and densely ciliated setæ, which are all of exactly the same size, and lie close together,

all being gently curved below. As these limbs are generally extended straight behind, the ends of the apical setæ are most frequently seen projecting from the hind edges of the shell (see Pl. XXXV, fig. 3).

On the left side of the abdominal part of the body, at some distance from the caudal plates, a rather large, oblong oval piece occurs, projecting freely below, and somewhat anteriorly (see Pl. XXXV, fig. 3, Pl. XXXVI, figs. 10, 11). This is the single copulative organ, containing the outer part of the seminal duct.

The inner organs cannot, of course, be very closely examined, except in fresh specimens. However, by a suitable preparation of the extracted body, it can be made sufficiently pellucid to show some of these organs rather distinctly (see Pl. XXXV, figs., 1, 3). The intestine especially is easy to observe, forming a very capacious sac-like cavity, located in the abdominal part of the body, and generally filled with contents of an opaque, dark appearance. It debouches by a short rectum between the caudal lamellæ, and to its anterior extremity leads a highly muscular œsophagus, ascending obliquely from the oral aperture. By dissection, this part of the intestinal tract is not infrequently obtained in connection with the chitinous skeleton surrounding the mouth, and can thus be subjected to a closer examination (see Pl. XXXVI, fig. 1). It is coarsely annulated throughout, and is attached to the walls of the body by numerous short muscles. Its distal extremity expands into a large hollow disc, which projects freely within the lumen of the intestinal cavity. The contents of the latter consist of a compact infiltrated mass, in which I have failed to detect any recognizable remains, either of algæ or of animals. Probably the food is so finely triturated by the mandibles, that no part of it is left unaltered.

In the female, the ovaries also, with their numerous egg-follicles, may be pretty clearly traced, owing to their opaque white colour, contrasting strongly with the dark contents of the intestine (see Pl. XXXV, fig. 1).

The young do not seem to undergo any metamorphosis, all the limbs being present, even in specimens which have evidently just escaped from the ova. The shell of the young animal, however, is rather different in shape from that of the adult animal, being far less elongated, and in

very small specimens almost globular, gradually assuming a more oval form (see Pl. XXXVI, fig. 12).

Occurrence. This form was found very abundantly in the greater number of the samples (12), and it was taken both from the surface and from depths down to 300 metres.

Distribution. Off Greenland, in lat. $74^{\circ} 49'$ N., long. $11^{\circ} 30'$ W. from a depth of 350 fathoms; Farøe channel, in lat. $60^{\circ} 20'$ N., long. $7^{\circ} 23'$ W. from a depth of 200 fathoms, cold area.

CIRRIPEDIA.

Some Cirripedia-larvæ in the characteristic so-called Cypris-stage, apparently belonging to a species of *Balanus*, were found in a sample taken October 13th, 1893, north of the New Siberian Islands.

CHRISTIANIA. *January* 1900.

G. O. SARS.

TABLE OF CONTENTS.

	Page.	Plate.
Introduction	3	
Account of the species	13	

PODOPHTHALMIA.

Fam. CRANGONIDÆ.

1. <i>Sabinea septemcarinata</i> (Sab.)	13	
---	----	--

Fam. EPHYRIDÆ.

2. <i>Hymenodora glacialis</i> (Buchholtz)	13	
--	----	--

Fam. EUPHAUSIIDÆ.

3. <i>Nyctiphanes norvegicus</i> (M. Sars)	13	
4. <i>Thysanoëssa longicaudata</i> (Krøyer)	14	

AMPHIPODA.

Fam. HYPERIIDÆ.

1. <i>Euthemisto libellula</i> (Mandt.)	14	
2. <i>Parathemisto oblivia</i> (Krøyer)	14	

Fam. LANCEOLIDÆ.

Gen. *Lanceola*, Say

3. <i>Lanceola Clausi</i> , Bovallius	15	I.
---	----	----

Fam. SCINIDÆ.

4. <i>Scina borealis</i> , G. O. Sars	19	
---	----	--

Fam. LYSIANASSIDÆ.

Gen. *Cyclocaris*, Stebbing

5. <i>Cyclocaris Guilelmi</i> , Chevreux	20	II, III.
--	----	----------

	Page.	Plate.
Gen. <i>Pseudalibrotus</i> , Della Valle	25	
6. <i>Pseudalibrotus Nanseni</i> , n. sp.	26	IV, V.
7. <i>Pseudalibrotus glacialis</i> , n. sp.	31	VI.
Fam. PARAMPHITHOIDÆ.		
8. <i>Paramphithoë brevicornis</i> , G. O. Sars	32	
Fam. AMPELISCIDÆ.		
9. <i>Haploöps tubicola</i> , Lilljeborg	32	
10. <i>Haploöps setosa</i> , Boeck	33	
Fam. STENOITHOIDÆ.		
11. <i>Metopa longicornis</i> , Boeck	33	
Fam. EUSIRIDÆ.		
12. <i>Eusirus cuspidatus</i> , Kröyer	33	
13. <i>Eusirus Holmi</i> , Hansen	33	
Fam. CALLIOPIDÆ.		
14. <i>Amphithopsis glacialis</i> , Hansen	33	
Fam. GAMMARIDÆ.		
15. <i>Gammarus locusta</i> , Lin., var. <i>mutata</i>	34	
16. <i>Amathilla pinguis</i> (Kröyer).	34	
ISOPODA.		
Tribe: EPICARIDA.	34	
COPEPODA.		
Division: CALANOIDA.		
Tribe: AMPHASKANDRIA.		
Fam. CALANIDÆ.		
1. <i>Calanus finmarchicus</i> , (Gunner.)	35	
2. <i>Calanus hyperboreus</i> , Kröyer.	35	
Fam. SCOLECITHRICIDÆ.		
Gen. <i>Scaphocalanus</i> , n.		
3. <i>Scaphocalanus acrocephalus</i> , n. sp.	36	VII, VIII, IX.
Gen. <i>Scolecithrix</i> , Brady		
4. <i>Scolecithrix brevicornis</i> , n. sp.	46	X.
Gen. <i>Xanthocalanus</i> , Giesbr.		
5. <i>Xanthocalanus borealis</i> , n. sp.	49	XI.

	Page	Plate.
Gen. <i>Undinella</i> , n.		
6. <i>Undinella oblonga</i> , n. sp.	52	XII, XIII.
Fam. EUCHÆTIDÆ.		
7. <i>Euchæta norvegica</i> , Boeck	58	XIV.
Fam. ÆTIDIIDÆ.		
Gen. <i>Undeuchæta</i> , Giesbr.		
8. <i>Undeuchæta spectabilis</i> , n. sp.	59	XV, XVI.
Gen. <i>Chiridius</i> , Giesbr.		
9. <i>Chiridius armatus</i> (Boeck).	64	XVII.
10. <i>Chiridius tenuispinus</i> , n. sp.	67	XVIII.
11. <i>Chiridius brevispinus</i> , n. sp.	68	XIX.
Fam. PSEUDOCALANIDÆ.		
Gen. <i>Pseudocalanus</i> , Boeck.		
12. <i>Pseudocalanus elongatus</i> , Boeck	69	
13. <i>Pseudocalanus major</i> , n. sp.	69	XX.
14. <i>Pseudocalanus pygmæus</i> , n. sp.	73	XXI.
Gen. <i>Spinocalanus</i> , Giesbr.		
15. <i>Spinocalanus longicornis</i> , n. sp.	75	XXII.
16. <i>Drepanopus Bungei</i> , G. O. Sars	78	
Tribe: HETERARTHANDRIA.		
Fam. HETEROCHÆTIDÆ.		
Gen. <i>Heterochæta</i> , Claus		
17. <i>Heterochæta norvegica</i> , Boeck	79	XXIII.
18. <i>Heterochæta compacta</i> , n. sp.	83	XXIV, XXV.
Gen. <i>Augaptilus</i> , Giesbr.		
19. <i>Augaptilus glacialis</i> , n. sp.	88	XXVI, XXVII.
Gen. <i>Hemicalanus</i> , Claus		
20. <i>Hemicalanus spinifrons</i> , n. sp.	95	XXVIII.
Fam. TEMORIDÆ.		
Gen. <i>Metridia</i> , Boeck		
21. <i>Metridia longa</i> (Lubbock)	99	XXIX.
Gen. <i>Temorites</i> , n.		
22. <i>Temorites brevis</i> , n. sp.	100	XXX, XXXI.
Fam. ACARTIIDÆ.		
23. <i>Acartia longiremis</i> (Lilljeb.)	106	

	Page.	Plate.
Division: <i>CYCLOPOIDA</i> .		
Tribe: <i>ISOKERANDRIA</i> .		
Fam. <i>ONCÆIDÆ</i> .		
	Gen. <i>Oncœa</i> , Philippi	106
24.	<i>Oncœa notopus</i> , Giesbrecht	107 XXXII, figs. 1—14.
25.	<i>Oncœa conifera</i> , Giesbrecht	113 XXXII, figs. 15, 16.
Gen. <i>Lubbockia</i> , Claus.		
26.	<i>Lubbockia glacialis</i> , n. sp.	114 XXXII
Tribe: <i>AMPHARTHRODRIA</i> .		
Fam. <i>OITHONIDÆ</i> .		
	Gen. <i>Oithona</i> , Baird	119
27.	<i>Oithona helgolandica</i> , Claus.	119
Fam. <i>MORMONILLIDÆ</i> .		
	Gen. <i>Mormonilla</i> , Giesbr.	119
28.	<i>Mormonilla polaris</i> , n. sp.	120 XXXV.
<i>OSTRACODA</i> .		
Tribe: <i>MYODOCOPA</i> .		
Fam. <i>CONCHÆCIDÆ</i> .		
	Gen. <i>Conchœcia</i> , Dana	127
	<i>Conchœcia maxima</i> , Brady & Norm.	127 XXXV, XXXVI.
	<i>CIRRIPEDIA</i>	137



143

PLATE I.

PLATE I.

Lanceola Clausi, Bovallius.

- Fig. 1. Female (not fully adult), viewed from left side.
- 2. Cephalon, front view, showing the antennæ and oral parts.
 - 3. Superior antenna.
 - 4. Inferior antenna.
 - 5. Anterior lip.
 - 6. Posterior lip.
 - 7. Right mandible with palp, and masticatory part of left, viewed from the inner face.
 - 8. Anterior maxilla.
 - 9. Posterior maxilla.
 - 10. Maxillipeds.
 - 11. First gnathopod.
 - 12. Second gnathopod.
 - 13. First pereopod.
 - 14. Third pereopod.
 - 14a. Same, extremity of propodal joint, with the dactylus protracted.
 - 15. Last pereopod.
 - 15a. Same, extremity of propodal joint, with the dactylus retracted.
 - 16. Urosome, dorsal view (the 2 anterior uropoda on right side omitted).
 - 17. Inner ramus of last uropod.
 - 18. Telson.
-

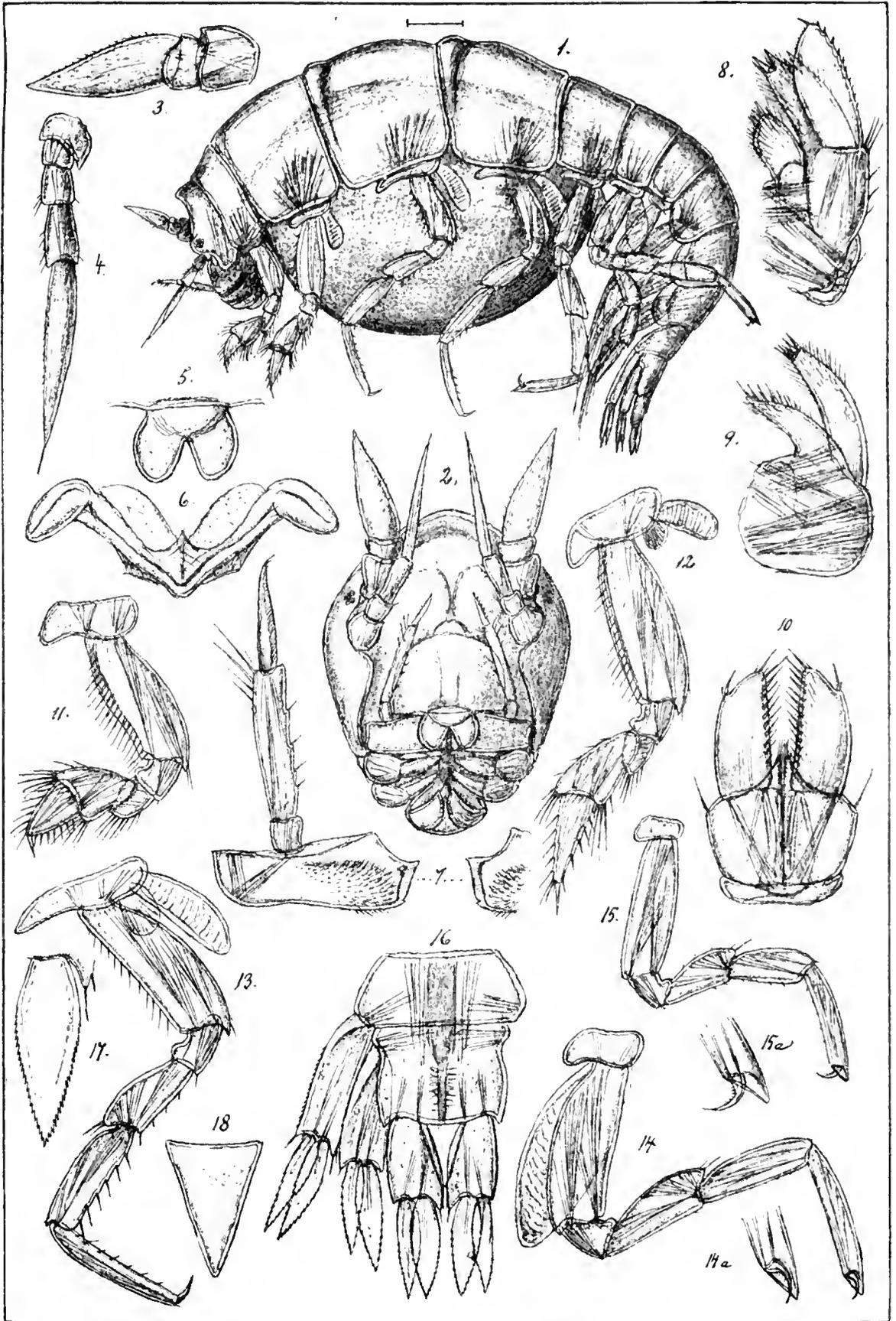

G.O. Sars autogr.

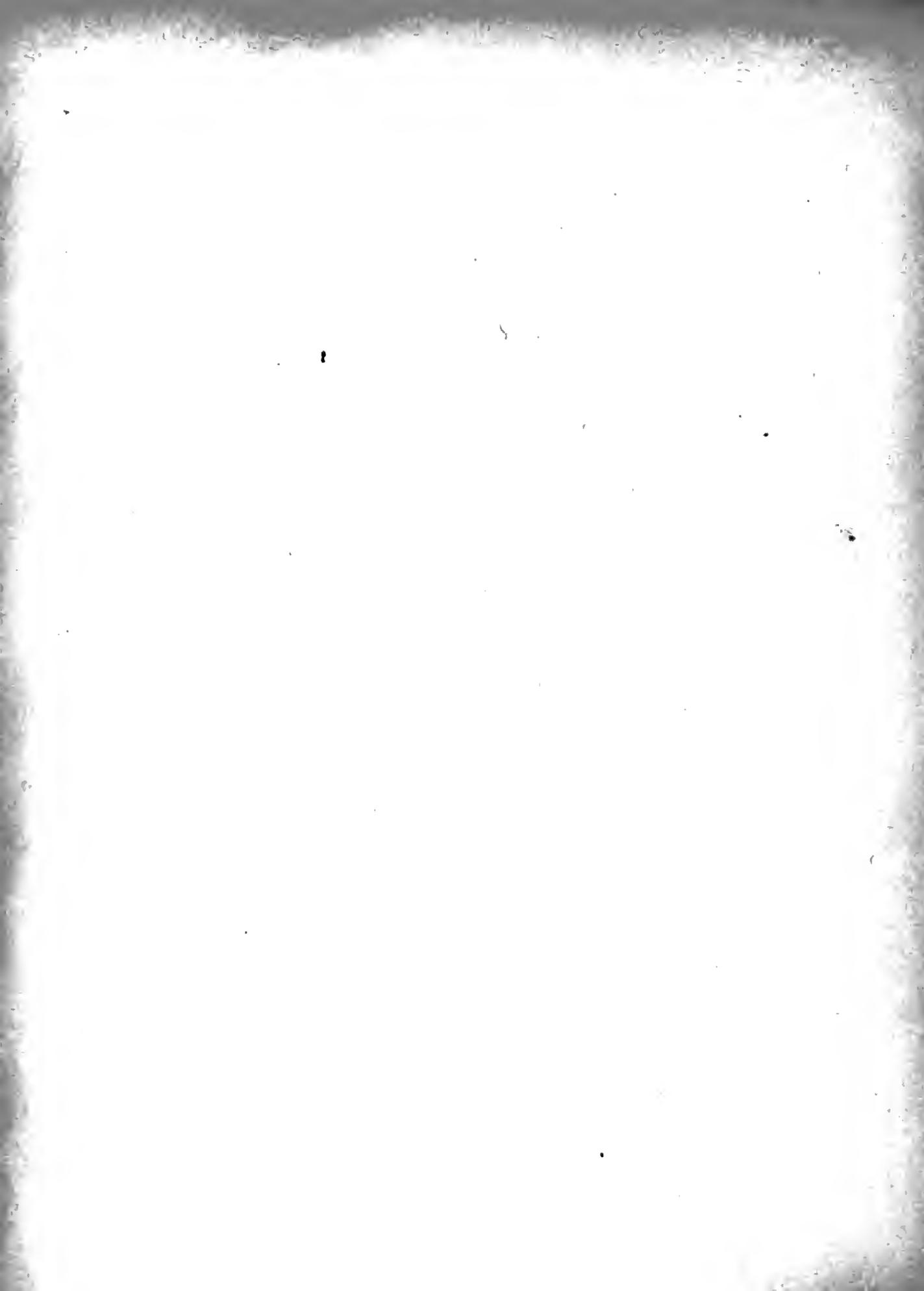

PLATE II.

PLATE II.

Cyclocaris Guilelmi, Chevreux.

- Fig. 1. Adult female, viewed from left side.
- 2. Cephalon with 1st segment of mesosome, lateral view.
 - 3. Epimeral plates of metasome, viewed from left side.
 - 4. Superior antenna.
 - 5. Inferior antenna.
 - 6. Anterior lip.
 - 7. Posterior lip.
 - 8. Left mandible with palp, viewed from the outer face.
 - 9. Right mandible, without the palp, exhibited from the inner face.
 - 10. Anterior maxilla.
 - 11. Posterior maxilla.
 - 12. Maxillipeds.
-

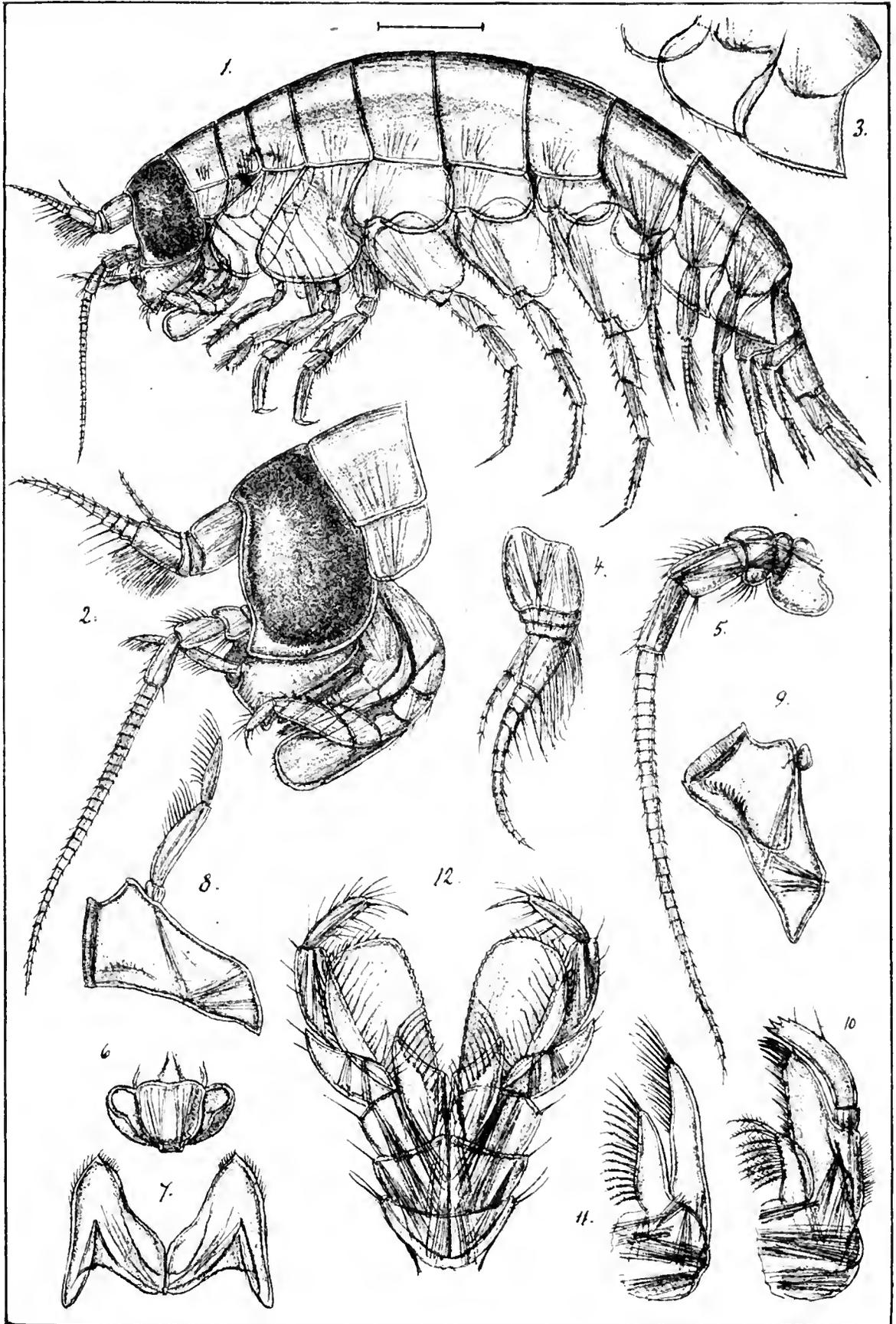
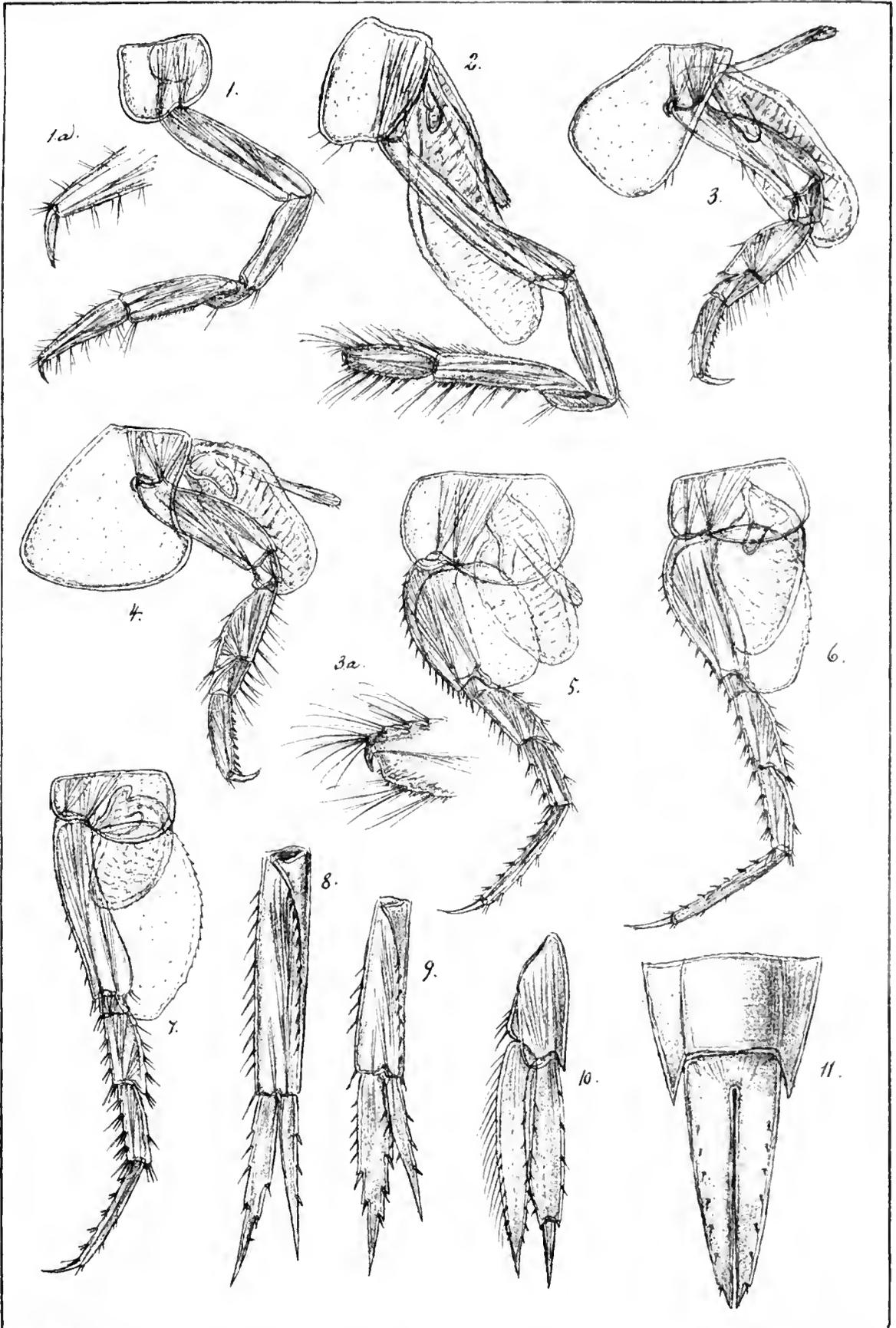

PLATE III.

Cyclocaris Guilelmi, Chevreux,
(continued).

- Fig. 1. Anterior gnathopod.
— 1a. Same, extremity of propodos.
— 2. Posterior gnathopod.
— 2a. Same, extremity of propodos.
— 3. First pereopod.
— 4. Second pereopod.
— 5. Third pereopod.
— 6. Fourth pereopod.
— 7. Last pereopod.
— 8. First uropod.
— 9. Second uropod.
— 10. Last uropod.
— 11. Terminal segment of urosome with telson, dorsal view.
-



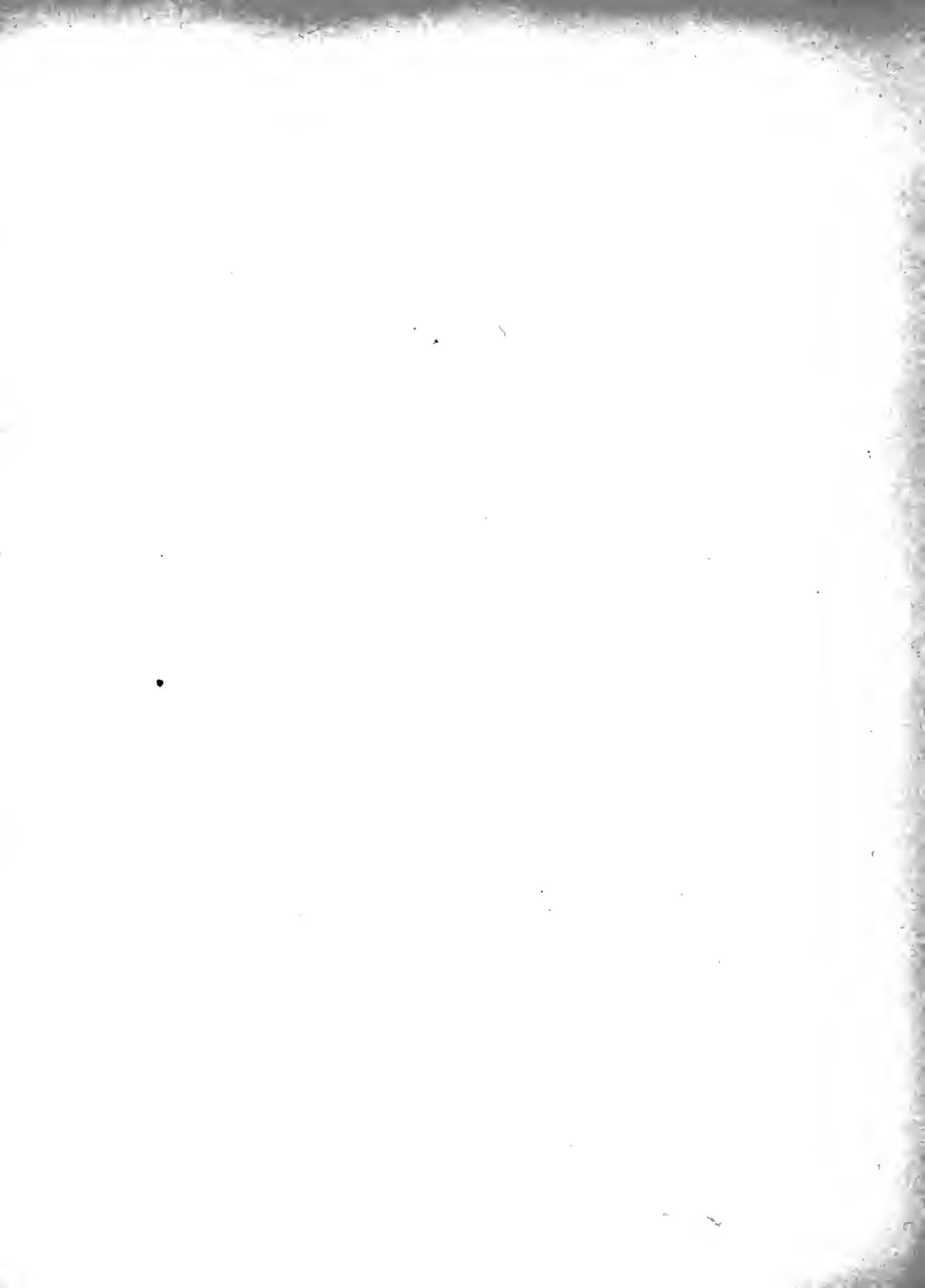

PLATE IV.

152

PLATE IV.

Pseudalibrotus Nanseni, G. O. Sars.

- Fig. 1. Adult male, viewed from left side.
- 2. Cephalon of female, with antennæ, lateral view.
 - 3. Superior antenna of male.
 - 4. Inferior antenna of same.
 - 5. Part of flagellum more highly magnified, showing the arrangement of the calceolæ.
 - 6. A calceola highly magnified, lateral view.
 - 7. Same, front view.
 - 8. Posterior lip.
 - 9. Left mandible with palp, viewed from inner face.
 - 10. Same, without the palp, lateral view.
 - 11. Anterior maxilla.
 - 12. Posterior maxilla.
 - 13. Maxillipeds.
 - 14. Anterior gnathopod.
-

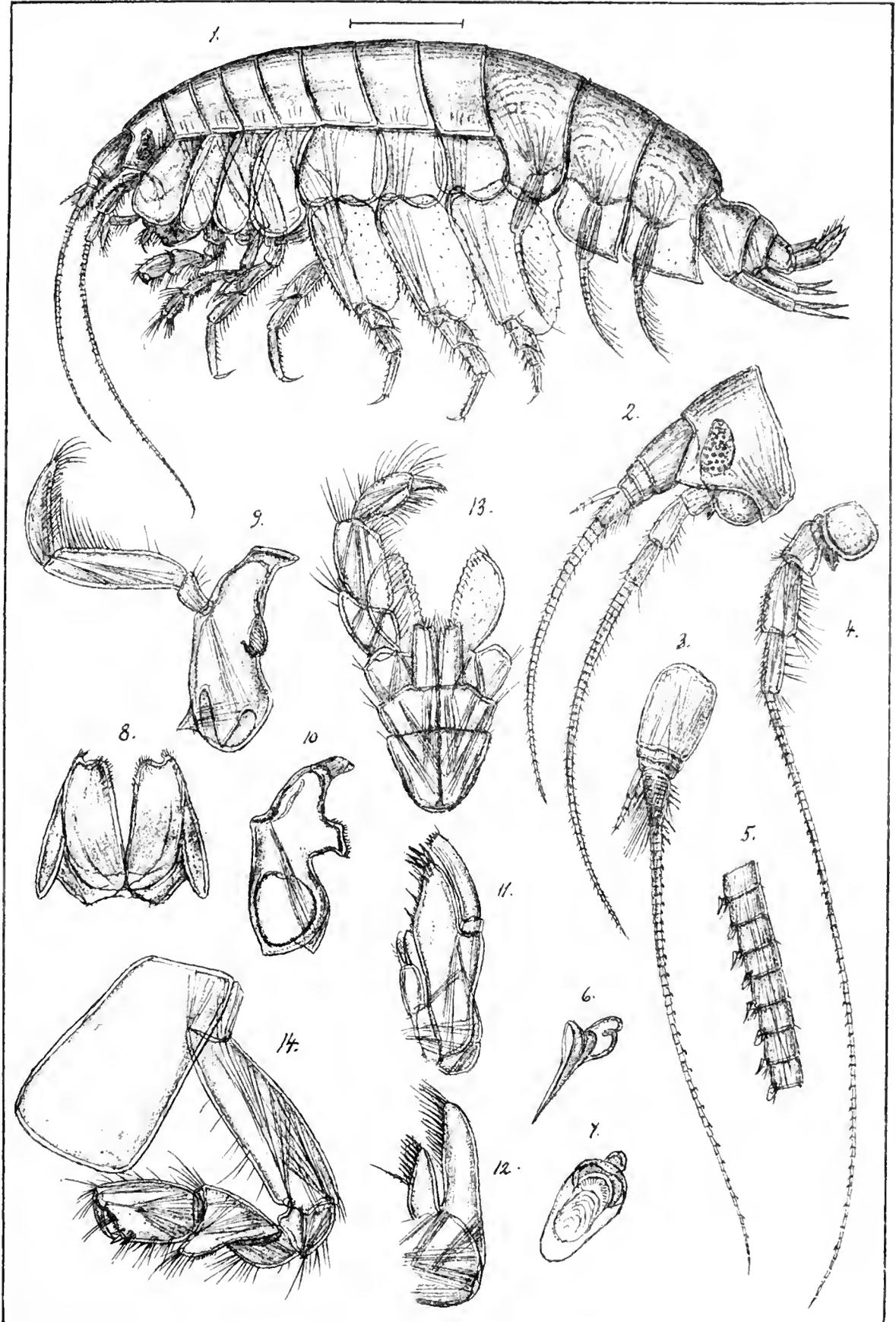

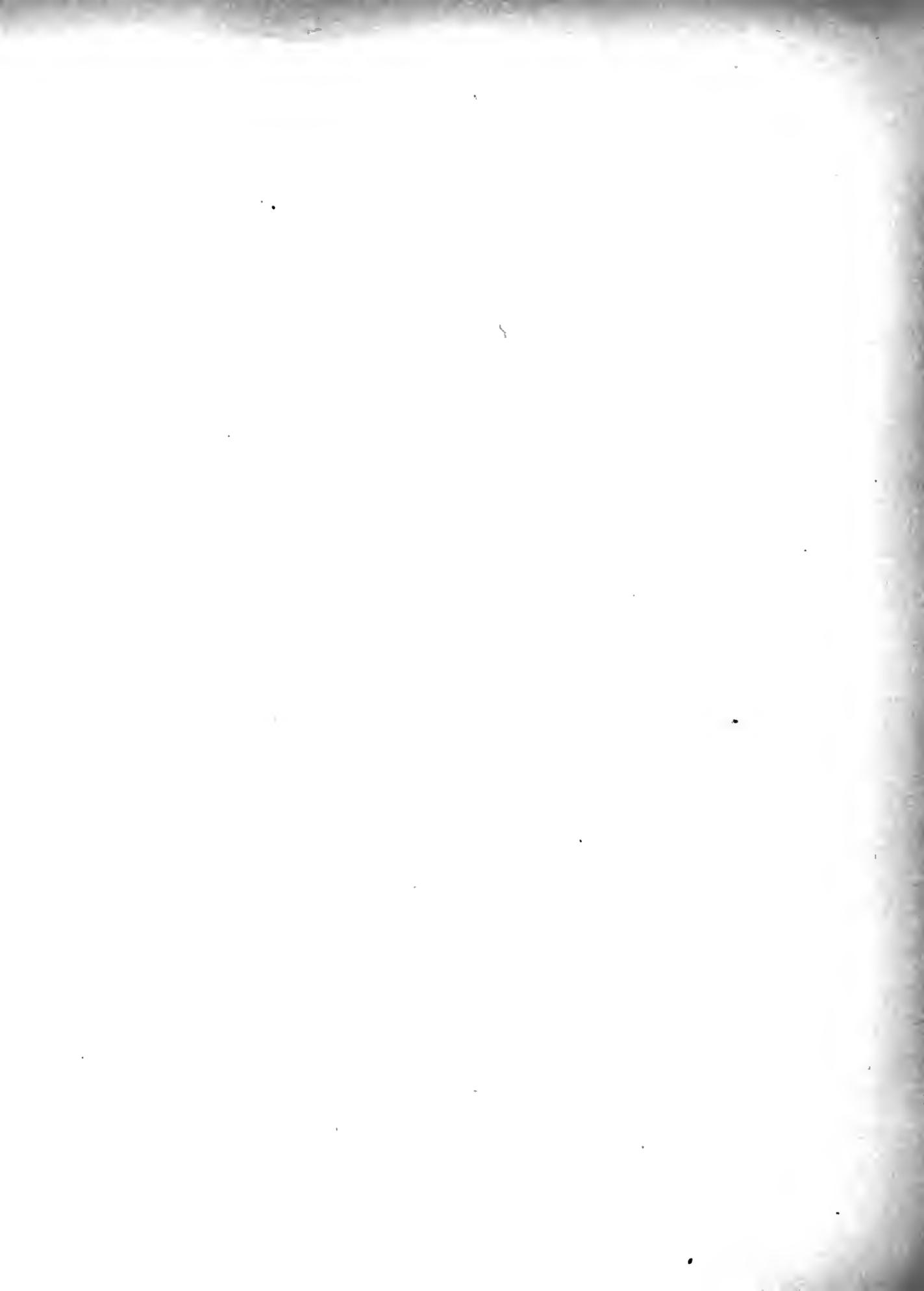

PLATE V.

PLATE V.

Pseudalibrotus Nanseni, G. O. Sars,
(continued).

- Fig. 1. Posterior gnathopod with branchial lamella.
-- 1a. Extremity of same, more highly magnified.
-- 2. First pereopod.
-- 3. Second pereopod.
-- 4. Third pereopod.
-- 5. Fourth pereopod.
-- 6. Last pereopod.
-- 7. Postero-lateral corner of last epimeral plate of metasome.
-- 8. Terminal segment of urosome, with last pair of uropoda and telson;
dorsal view.
-- 9. First uropod.
-- 10. Second uropod.
-- 11. Last uropod.
-- 12. Telson.
-

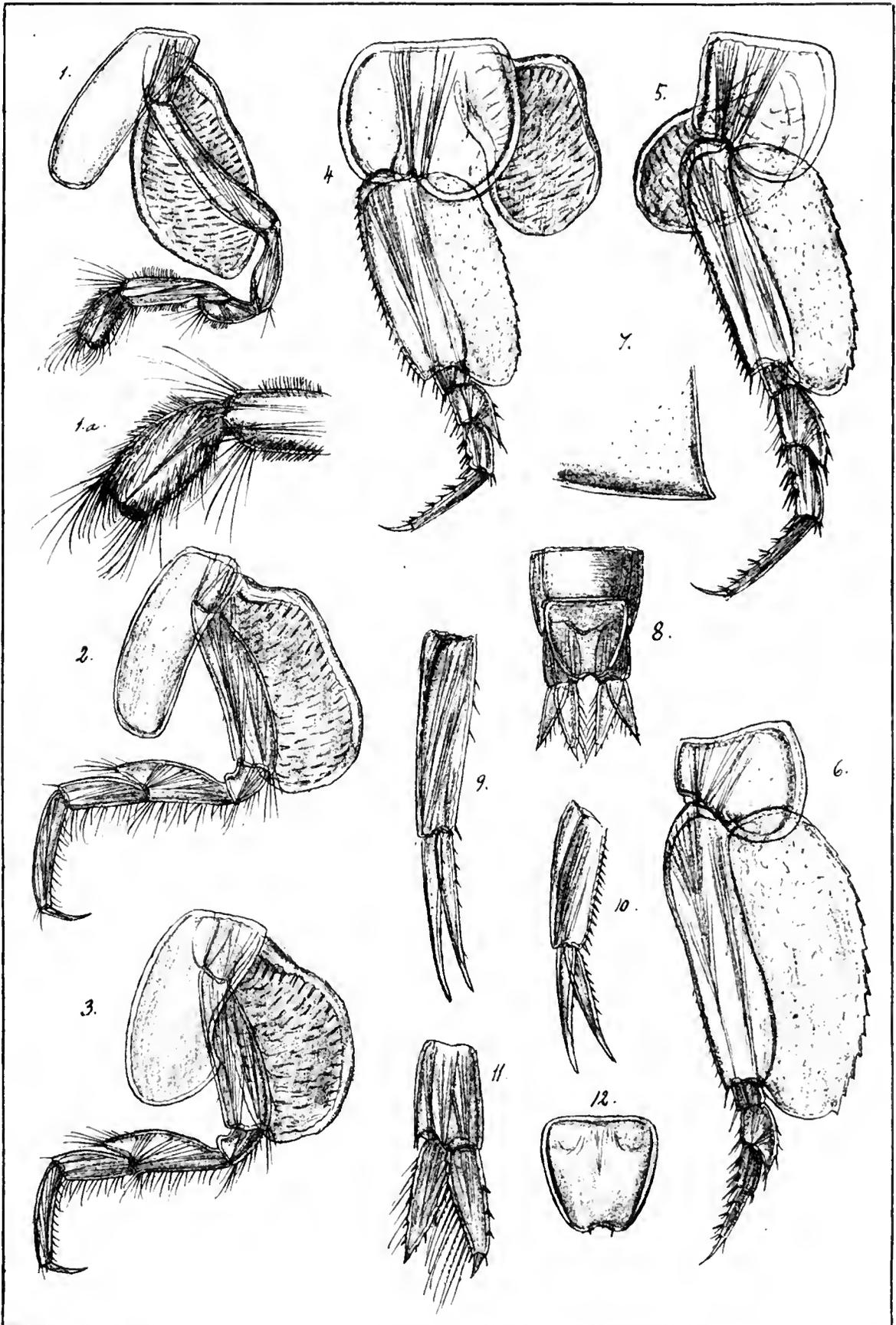
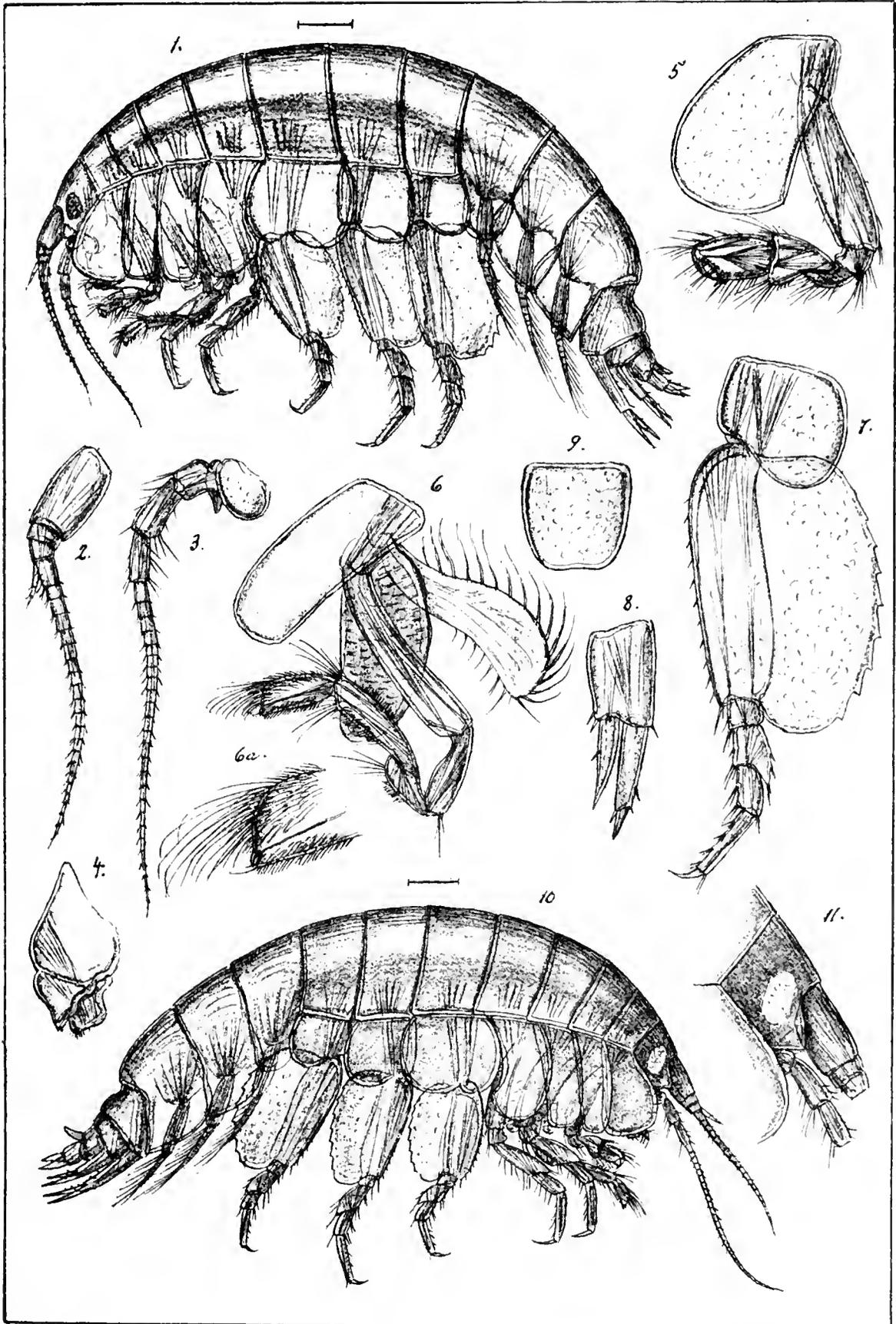

PLATE VI.

PLATE VI.

Pseudalibrotus glacialis, G. O. Sars.

- Fig. 1. Adult female of the normal form, viewed from left side.
— 2. Superior antenna
— 3. Inferior antenna.
— 4. Anterior lip with epistome, viewed from left side.
— 5. Anterior gnathopod.
— 6. Posterior gnathopod, with branchial lamella and incubatory plate.
— 6a. Same, extremity of propodos, more highly magnified.
— 7. Last pereopod.
— 8. Last uropod.
— 9. Telson.
— 10. Adult female of the variety '*leucopsis*', viewed from right side.
— 11. Anterior extremity of body, with the bases of the antennæ, lateral view.
-



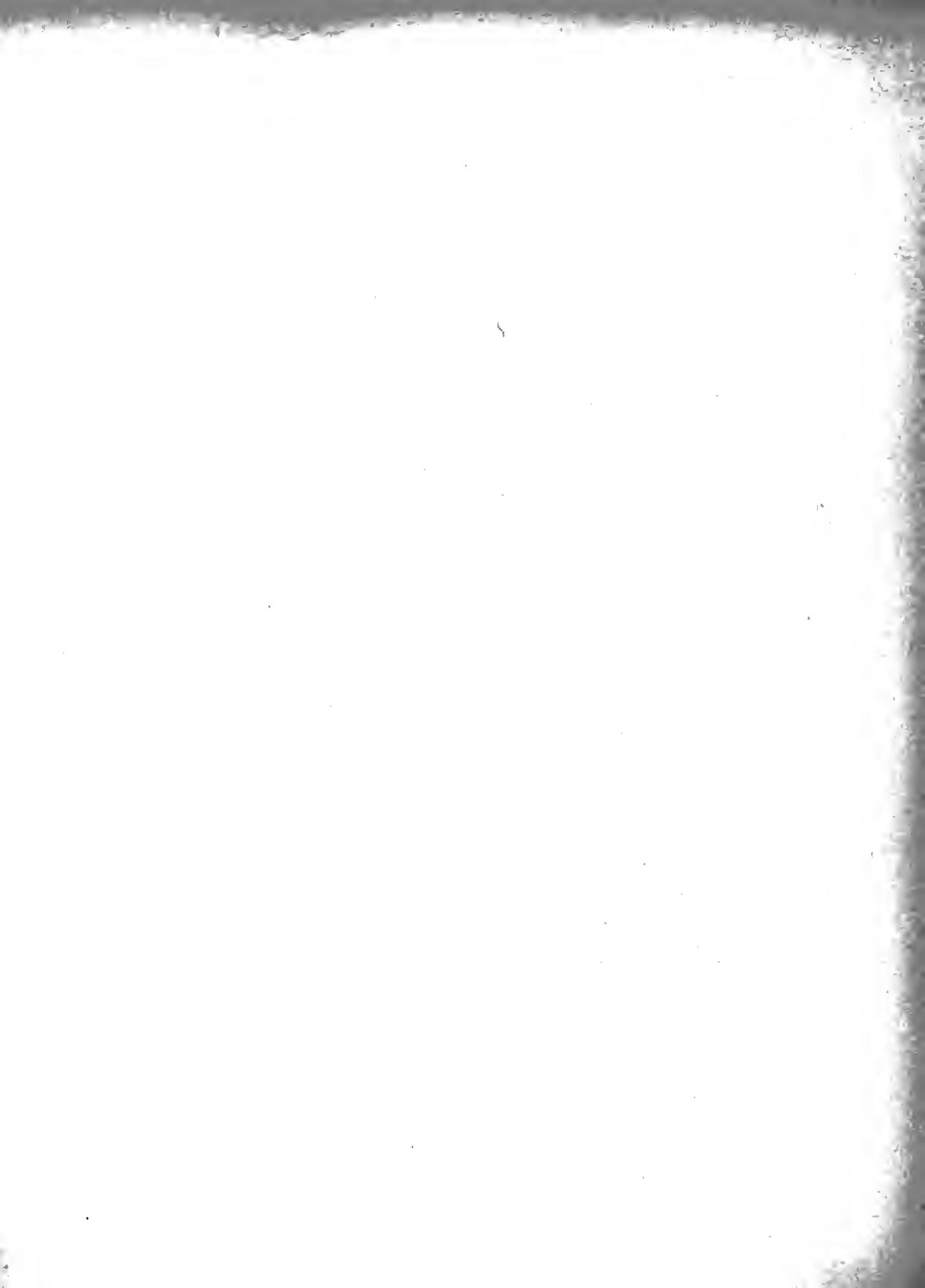
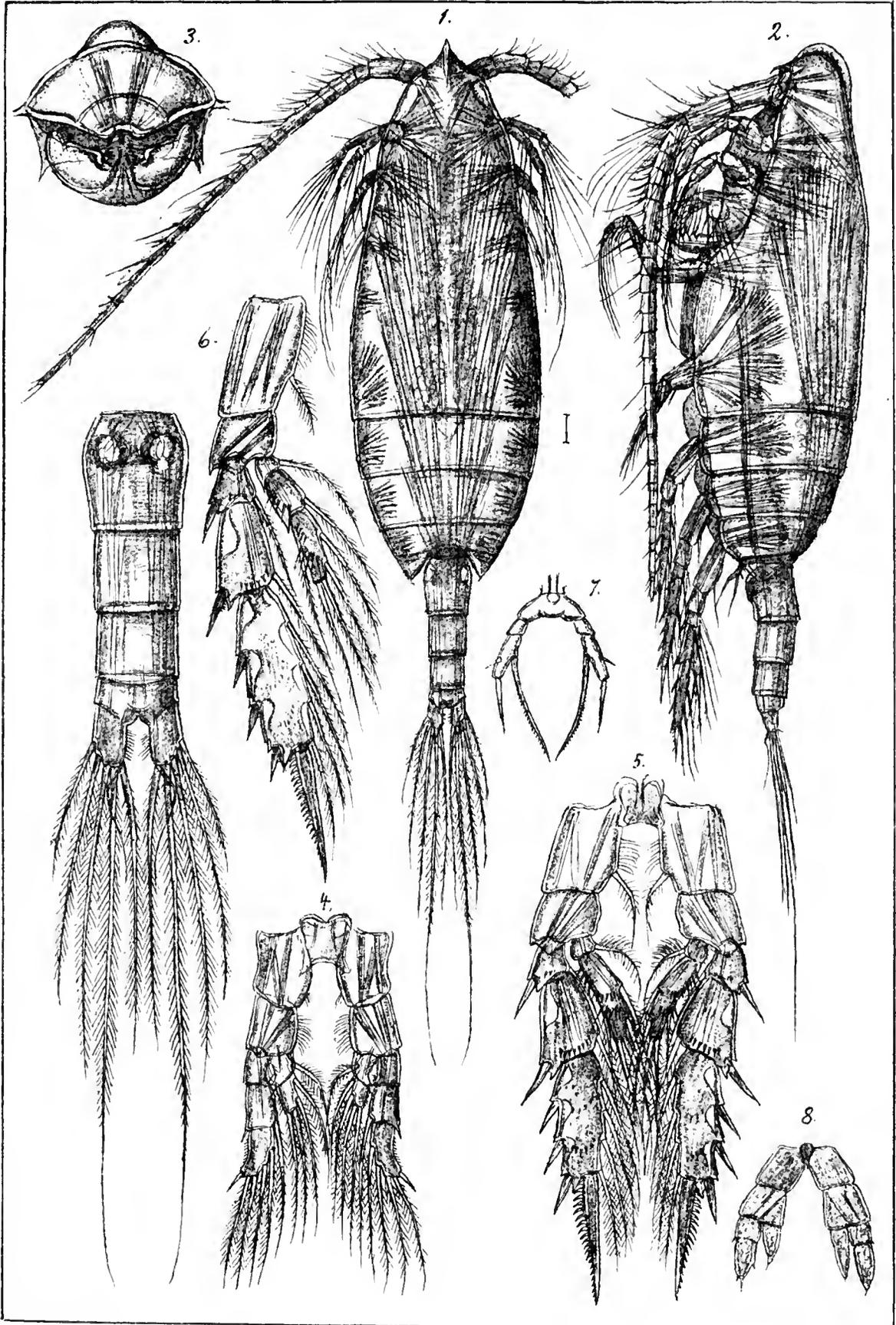

PLATE VII.

PLATE VII.

Scaphocalanus acrocephalus, G. O. Sars.

- Fig. 1. Adult female, dorsal view (right anterior antenna not fully drawn).
— 2. Same, viewed from left side.
— 3. Anterior and posterior lips, ventral view.
— 4. First pair of natatory legs.
— 5. Second pair of natatory legs.
— 6. Natatory leg of 3rd pair.
— 7. Last pair of legs.
— 8. Same of a young male specimen.
— 9 (not numbered in the plate). Tail of female, dorsal view.
-



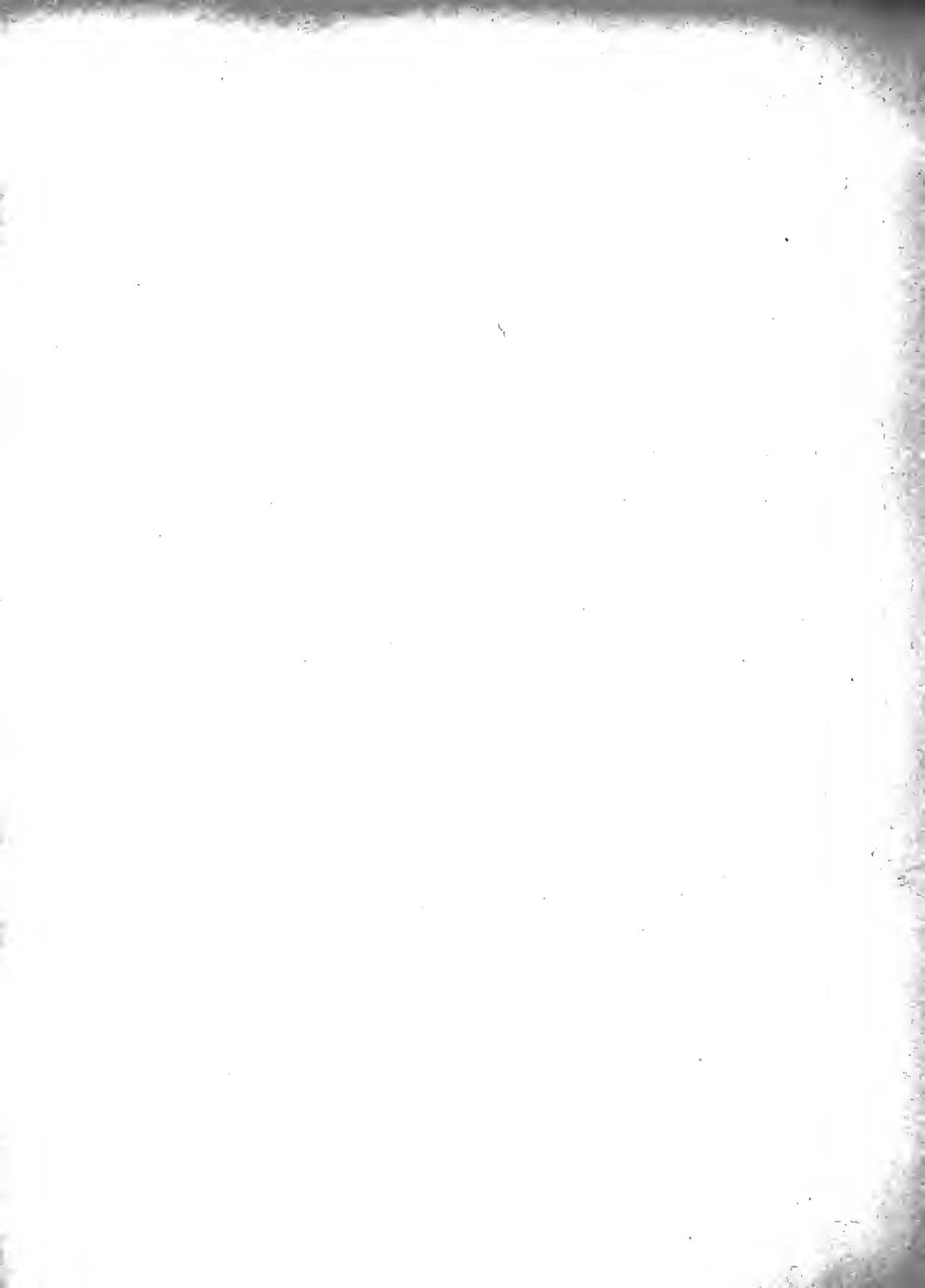

PLATE VIII.

PLATE VIII.

Scaphocalanus acrocephalus, G. O. Sars.
(continued.)

- Fig. 1. Anterior antenna.
— 2. Posterior antenna.
— 3. Mandible with palp (body viewed laterally).
— 4. Same, with the body viewed from the inner face (setæ of outer
ramus of palp not fully drawn).
— 5. Maxilla.
— 6. Anterior maxilliped.
— 7. Posterior maxilliped.
— 8. Natatory leg of 4th pair.
-

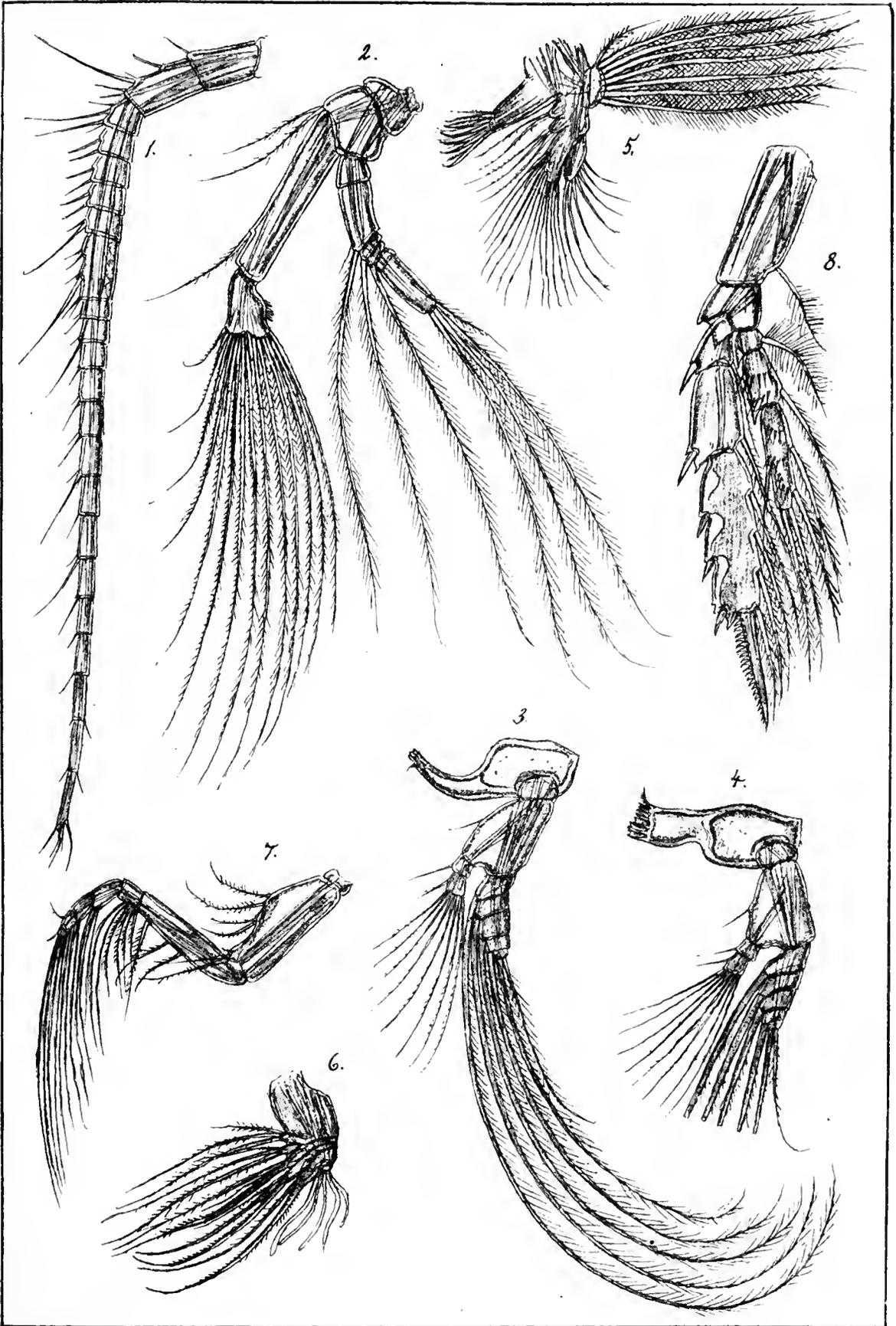



PLATE IX.

PLATE IX.

Scaphocalanus acrocephalus, G. O. Sars,
(adult male).

- Fig. 1. A complete specimen, viewed from the dorsal face.
— 2. Same, lateral view.
— 3. Rostral prominence, with the tentacular filaments.
— 4. Anterior antenna.
— 5. Mandible with palp.
— 6. Maxilla.
— 7. Anterior maxilliped.
— 8. Posterior maxilliped.
— 9. Natatory leg of 2nd pair.
— 10. Inner ramus of a natatory leg of 4th pair.
— 11. Last pair of legs.
-

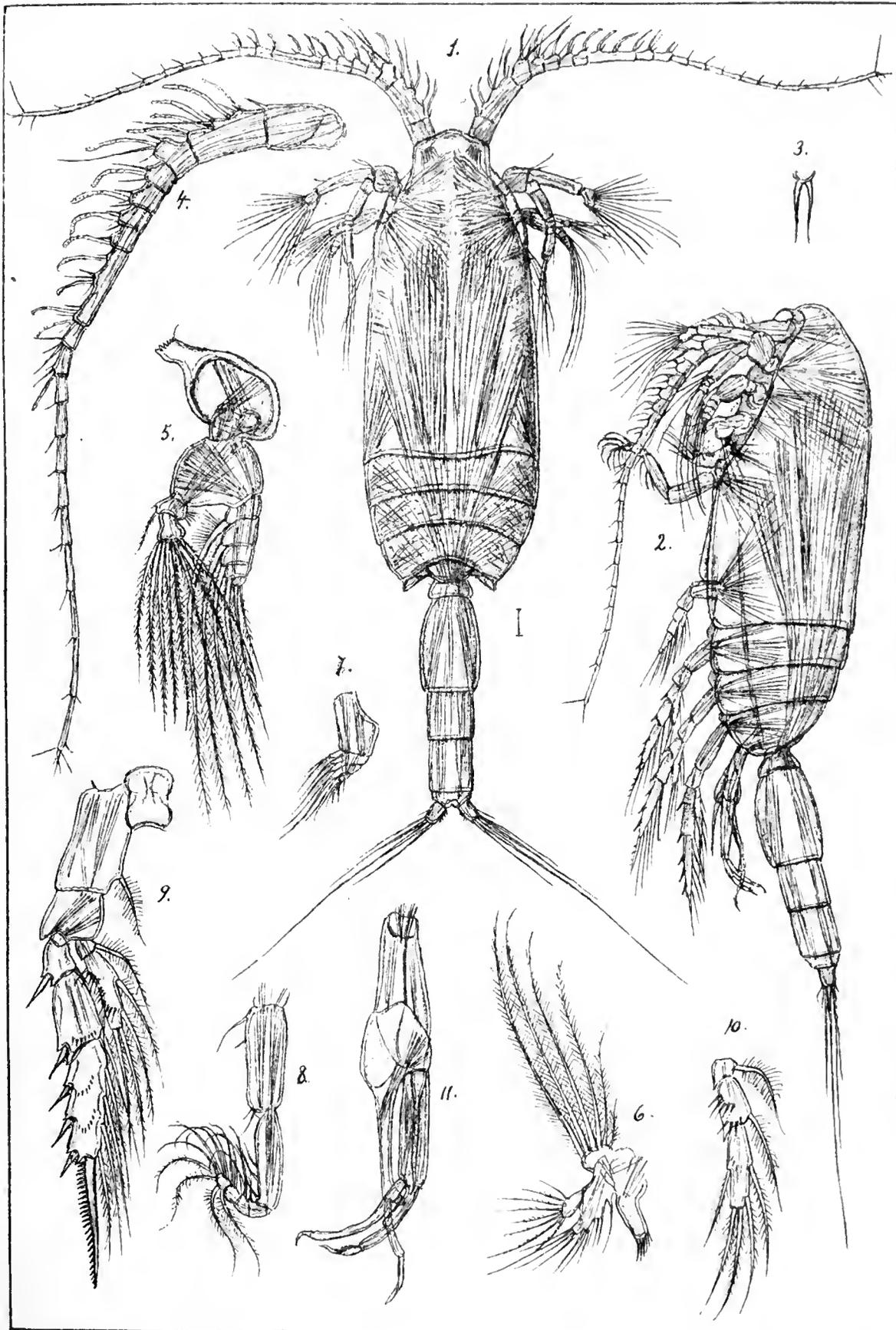

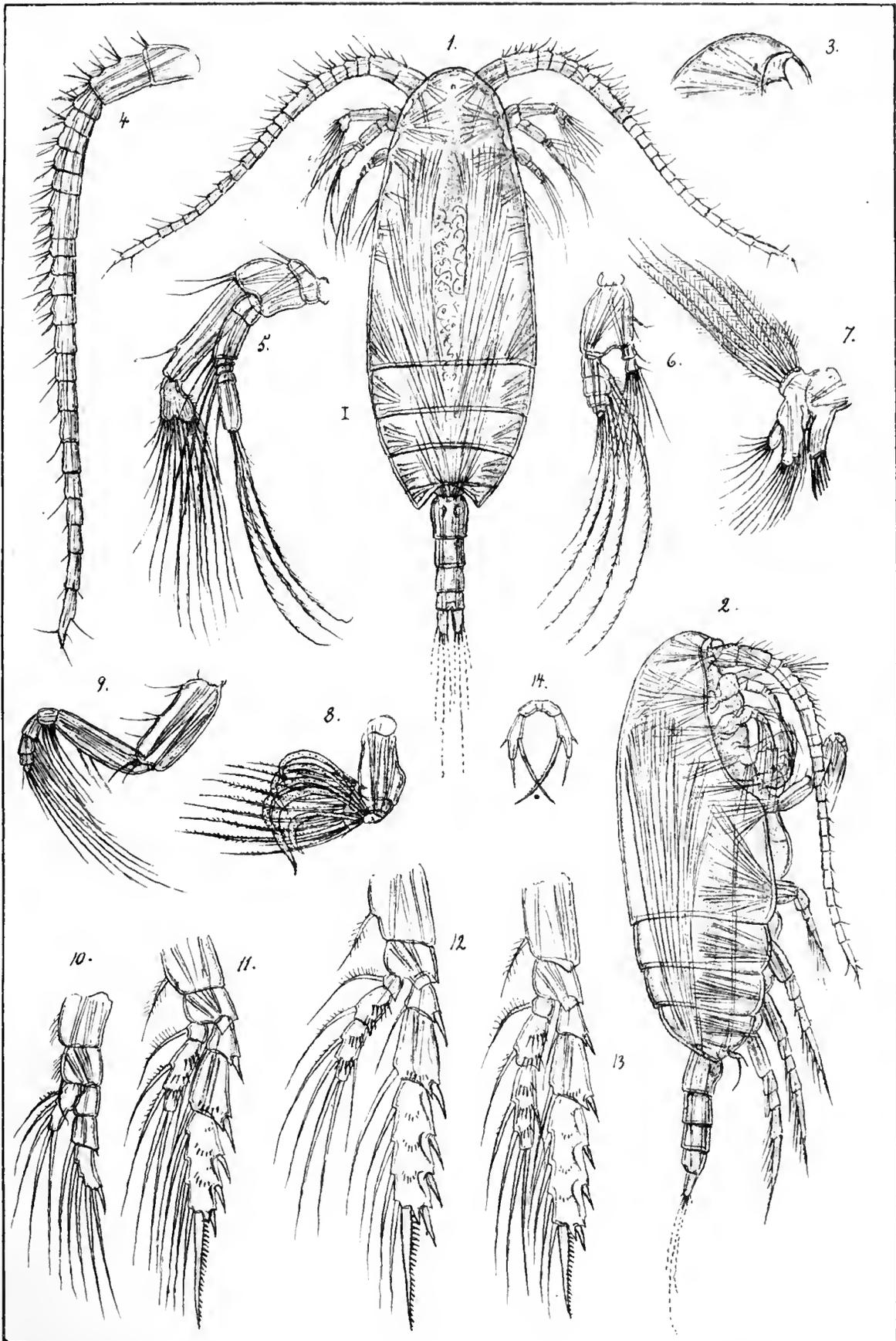

PLATE X.

PLATE X.

Scolecithrix brevicornis, G. O. Sars.

- Fig. 1. Adult female, dorsal view.
— 2. Same, viewed from right side.
— 3. Frontal part of body, lateral view.
— 4. Anterior antenna.
— 5. Posterior antenna.
— 6. Mandibular palp.
— 7. Maxilla.
— 8. Anterior maxilliped.
— 9. Posterior maxilliped.
— 10. Natatory leg of 1st pair.
— 11. Do. of 2nd pair.
— 12. Do. of 3rd pair.
— 13. Do. of 4th pair.
— 14. Last pair of legs.
-



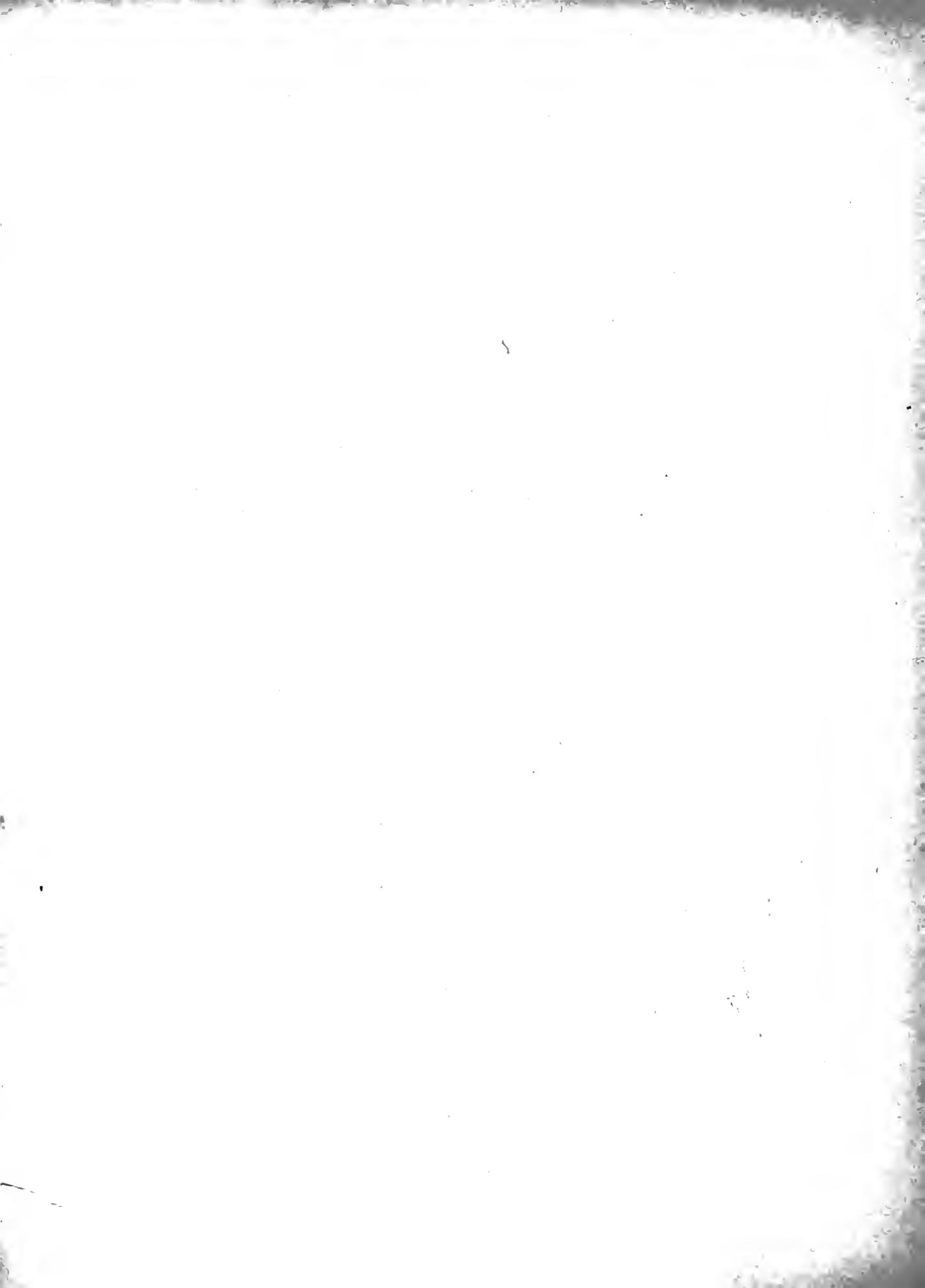
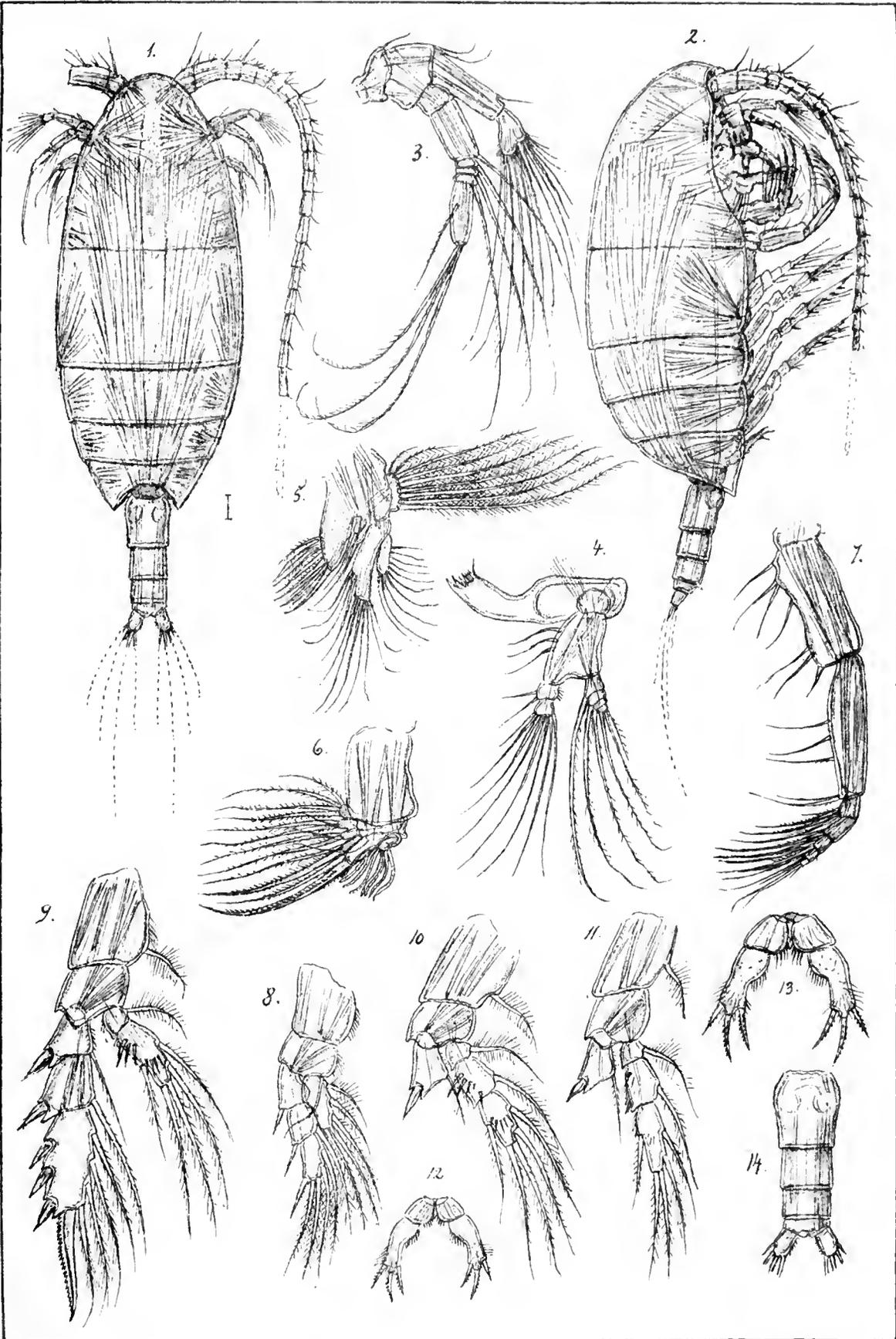

PLATE XI.

PLATE XI.

Xanthocalanus borealis, G. O. Sars.

- Fig. 1. Adult female, dorsal view.
— 2. Same, viewed from right side.
— 3. Posterior antenna.
— 4. Mandible with palp.
— 5. Maxilla.
— 6. Anterior maxilliped.
— 7. Posterior maxilliped.
— 8. Natatory leg of 1st pair.
— 9. Do. of 2nd pair.
— 10. Do. of 3rd pair.
— 11. Do. of 4th pair.
(Outer ramus in the last 2 figures not fully drawn.)
— 12. Last pair of legs.
— 13. Same, more highly magnified.
— 14. Tail, dorsal view (caudal setæ not fully drawn).
-



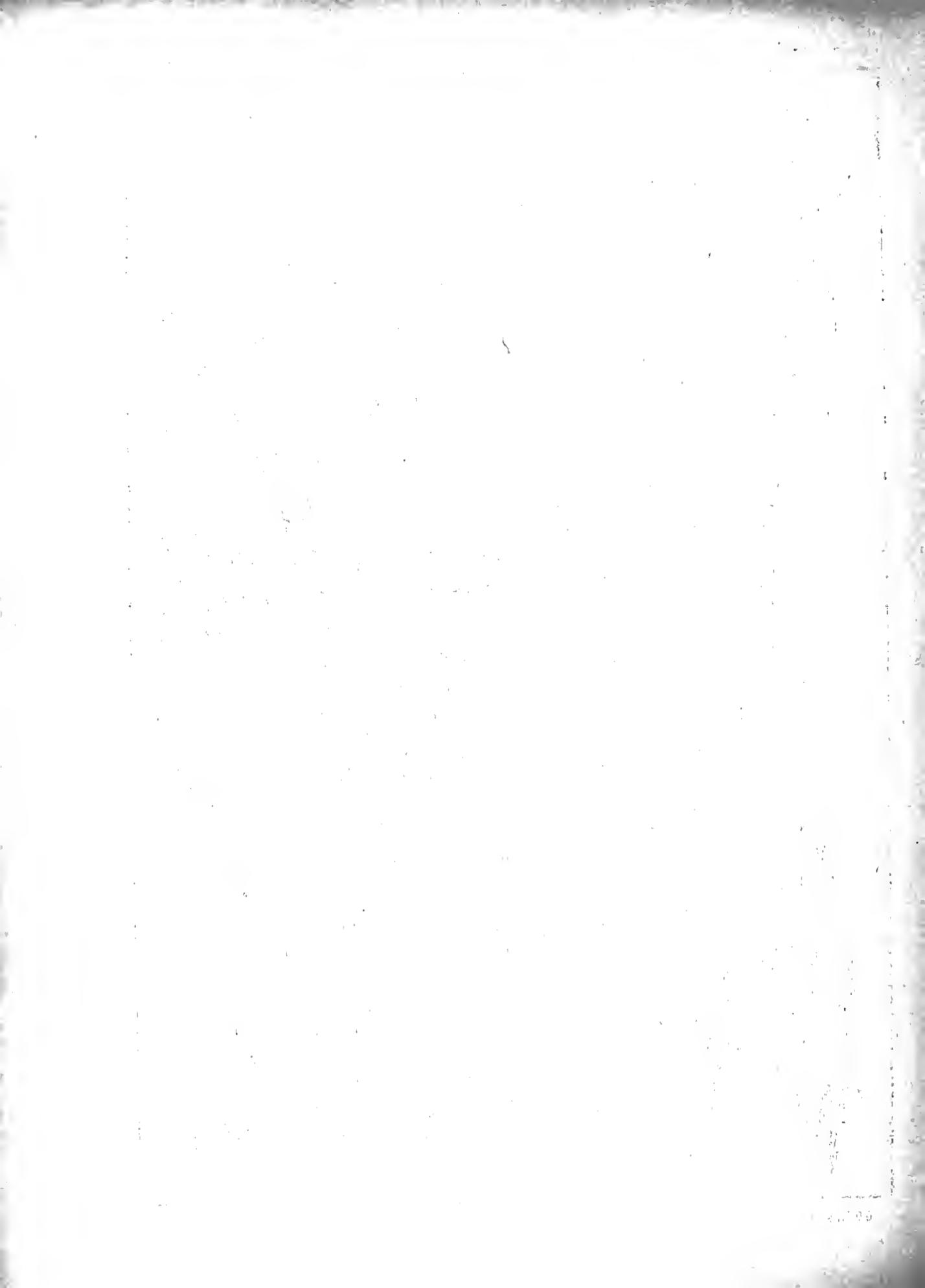
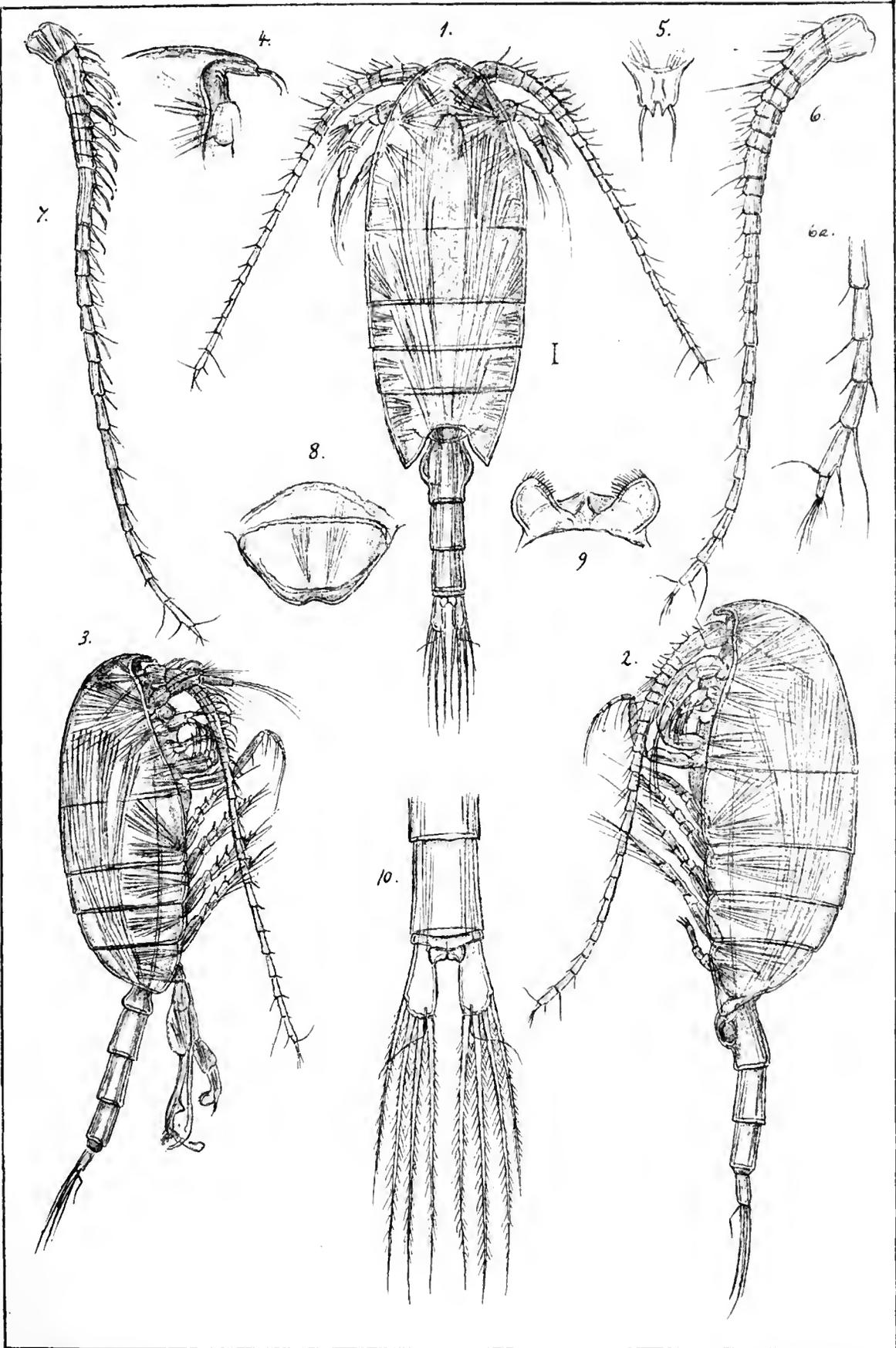

PLATE XII.

PLATE XII.

Undinella oblonga, G. O. Sars.

- Fig. 1. Adult female, dorsal view.
— 2. Same, viewed from left side.
— 3. Adult male, exhibited from right side.
— 4. Frontal part of body, lateral view.
— 5. Rostral prominence, front view.
— 6. Anterior antenna of female.
— 6a. Distal part of same, more highly magnified.
— 7. Anterior antenna of male.
— 8. Anterior lip.
— 9. Posterior lip.
— 10. Extremity of tail, dorsal view.
-



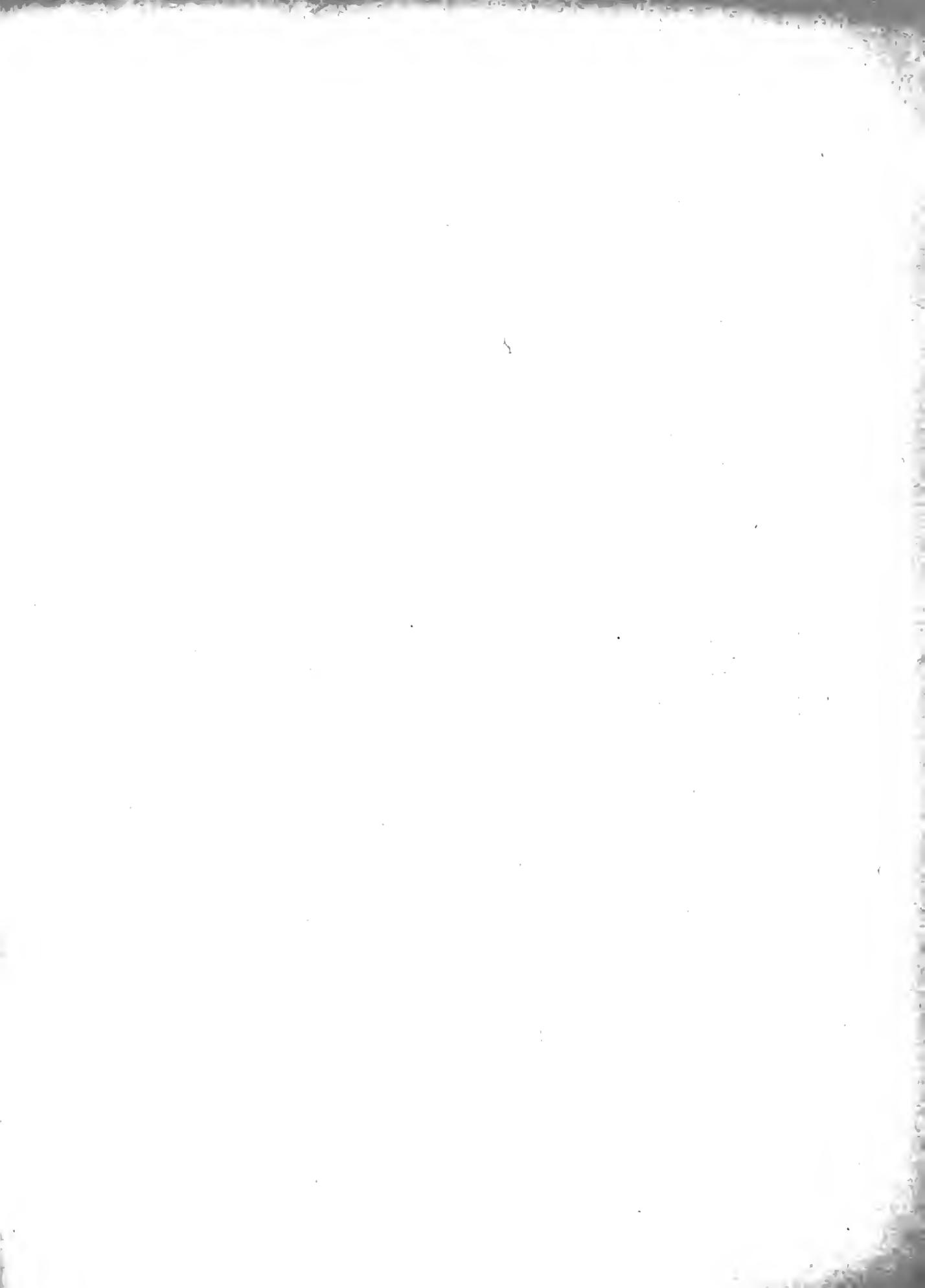

PLATE XIII.

PLATE XIII.

Undinella oblonga, G. O. Sars,
(continued).

- Fig. 1. Posterior antenna.
— 2. Mandible with palp.
— 3. Maxilla.
— 4. Anterior maxilliped.
— 5. Posterior maxilliped.
— 6. Natatory leg of 1st pair.
— 7. Do. of 2nd pair.
— 8. Do. of 3rd pair.
— 9. Do. of 4th pair.
— 10. Last pair of legs of female.
-

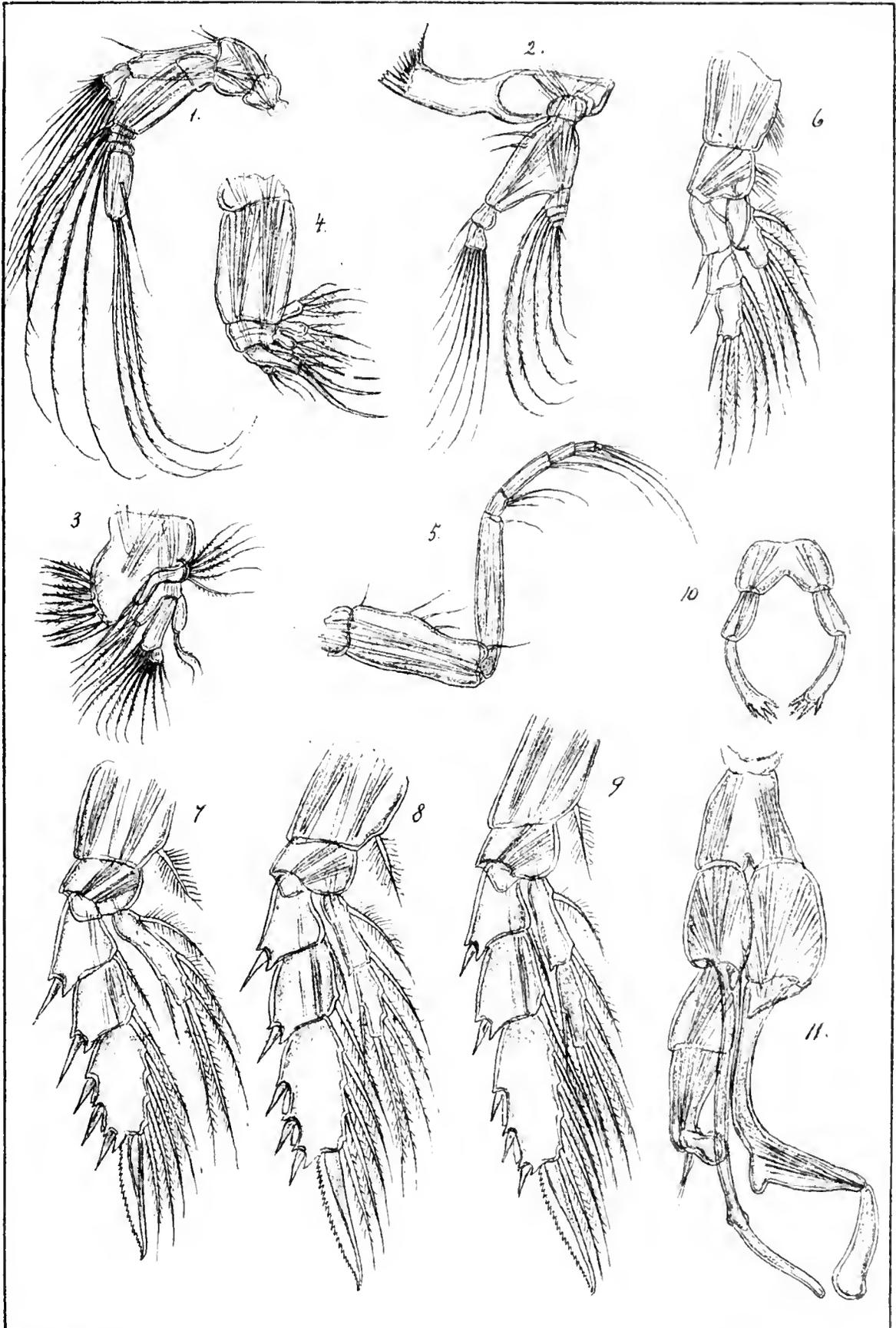
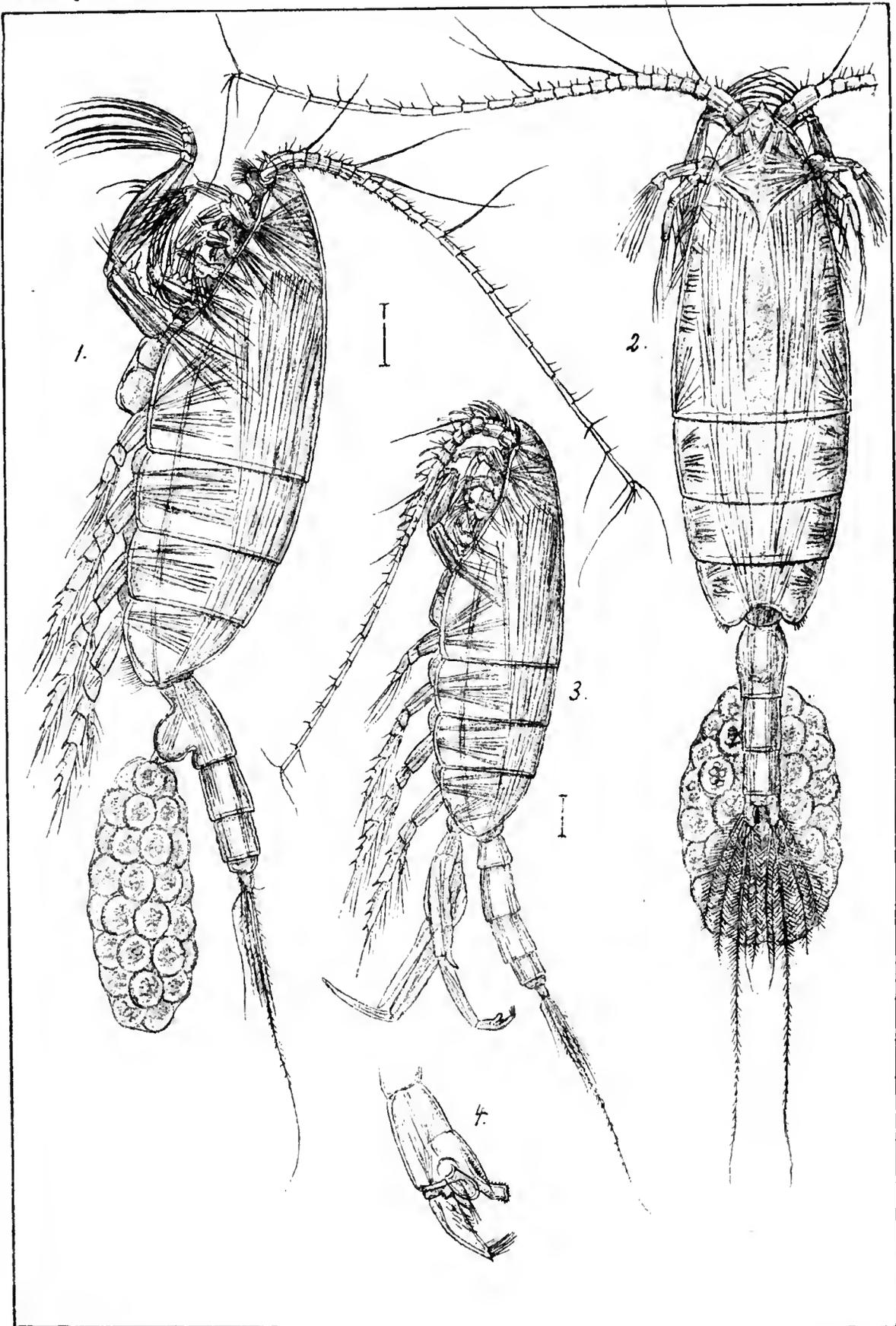

PLATE XIV.

PLATE XIV.

Euchaeta norvegica, Boeck.

- Fig. 1. Adult ovigerous female, viewed from left side.
— 2. Same, dorsal view.
— 3. Adult male, viewed from left side.
— 4. Same, distal part of left leg of last pair.
-



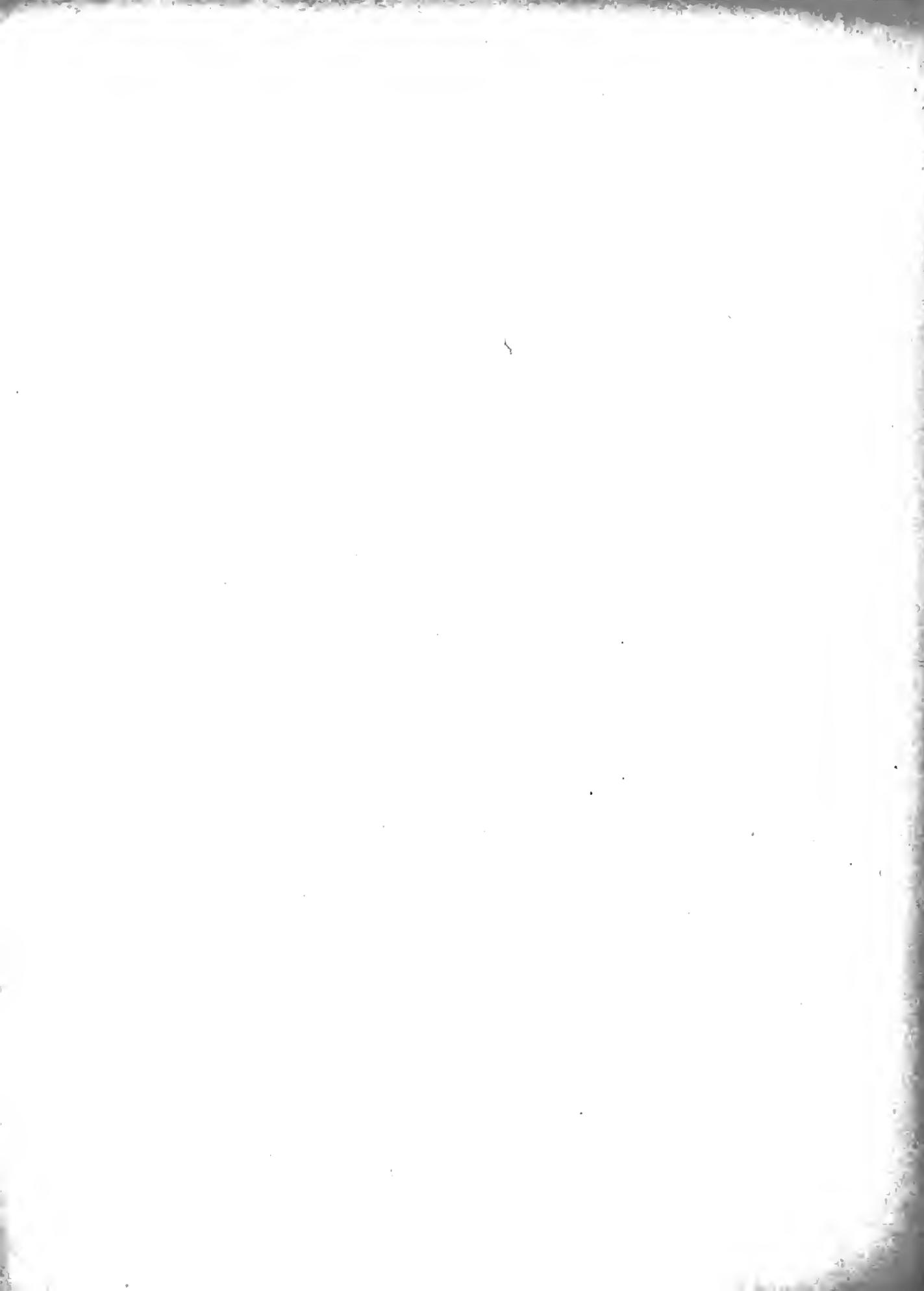
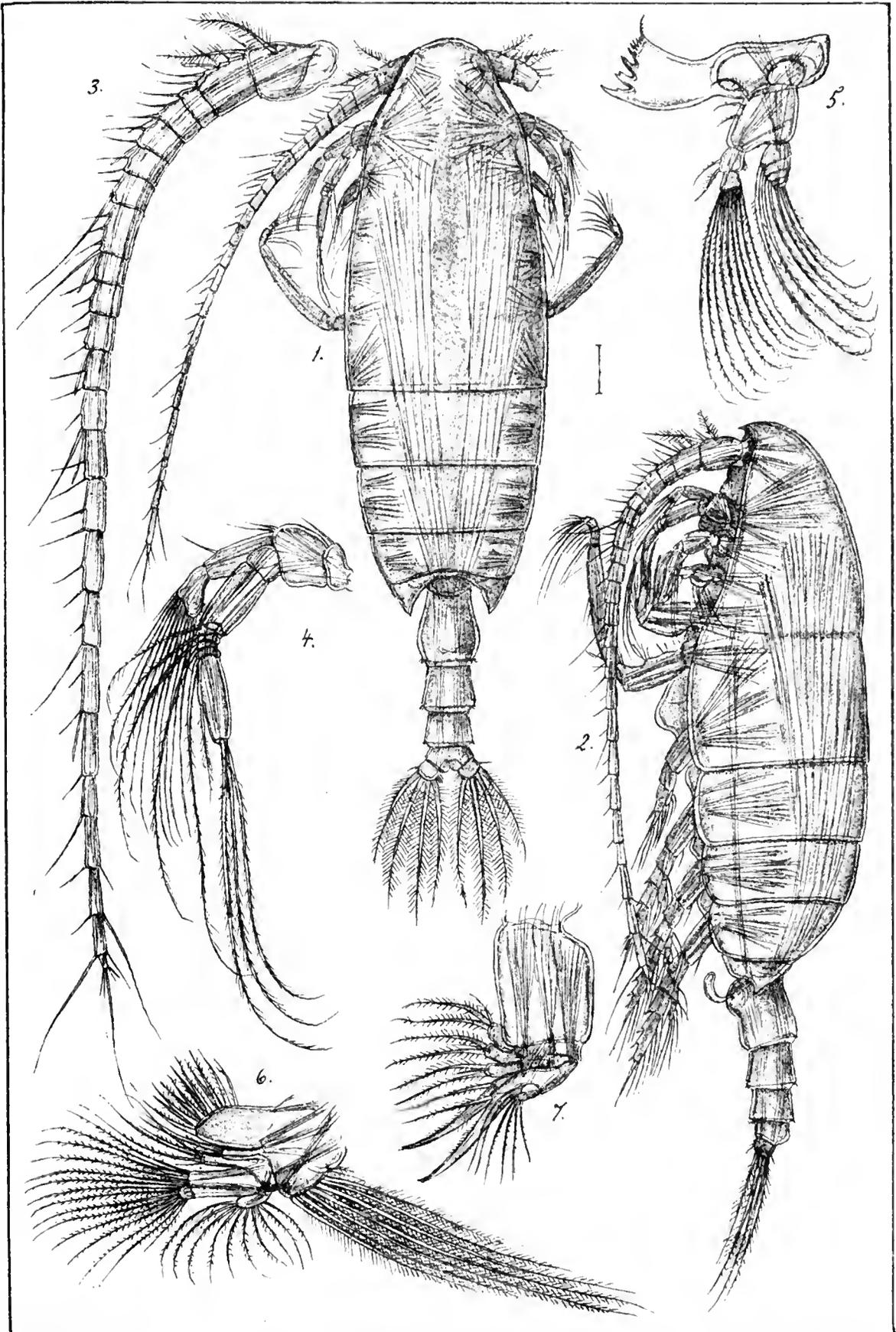

PLATE XV.

PLATE XV.

Undeuchæta spectabilis, G. O. Sars.

- Fig. 1. Adult female, dorsal view (right anterior antenna not fully drawn).
- 2. Same, viewed from left side.
 - 3. Anterior antenna.
 - 4. Posterior antenna.
 - 5. Mandible with palp.
 - 6. Maxilla.
 - 7. Anterior maxilliped.
-



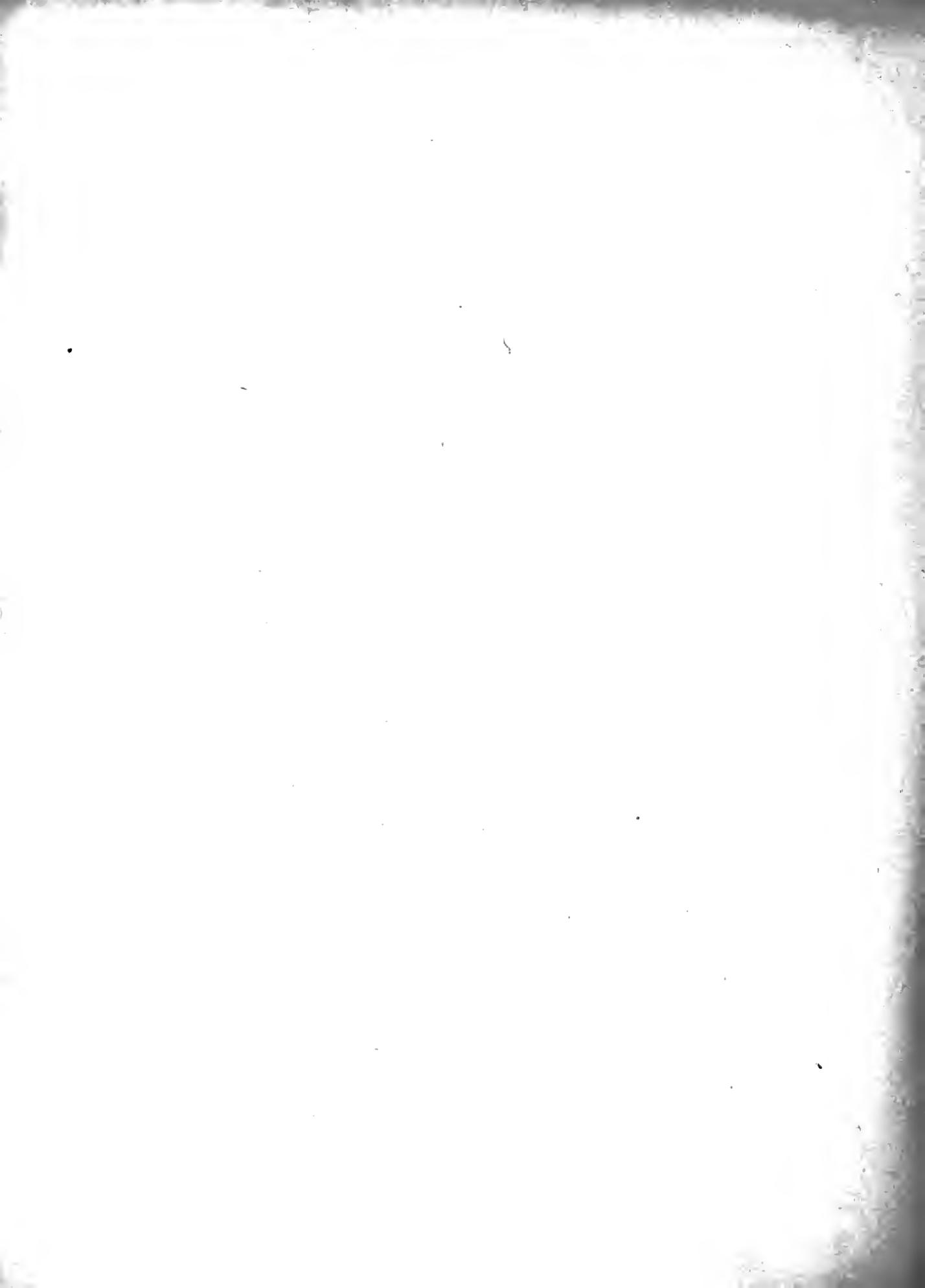
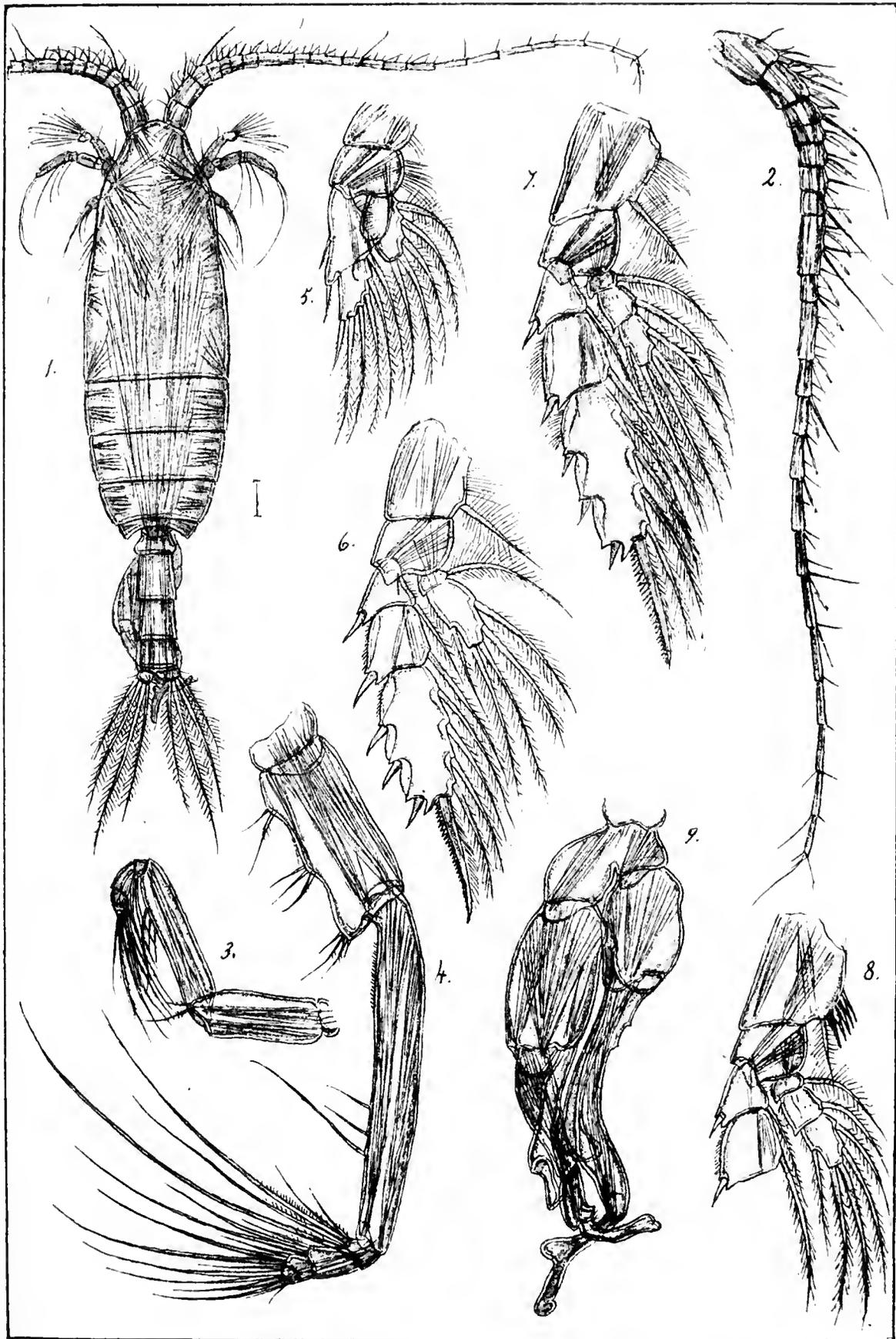

PLATE XVI.

PLATE XVI.

Undeuchæta spectabilis, G. O. Sars,
(continued).

- Fig. 1. Adult male, dorsal view.
— 2. Anterior antenna of same.
— 3. Posterior maxilliped of same.
— 4. Posterior maxilliped of female.
— 5. Natatory leg of 1st pair.
— 6. Do. of 2nd pair.
— 7. Do. of 3rd pair.
— 8. Do. of 4th pair (terminal joint of outer ramus
not drawn).
— 9. Last pair of legs of male.
-



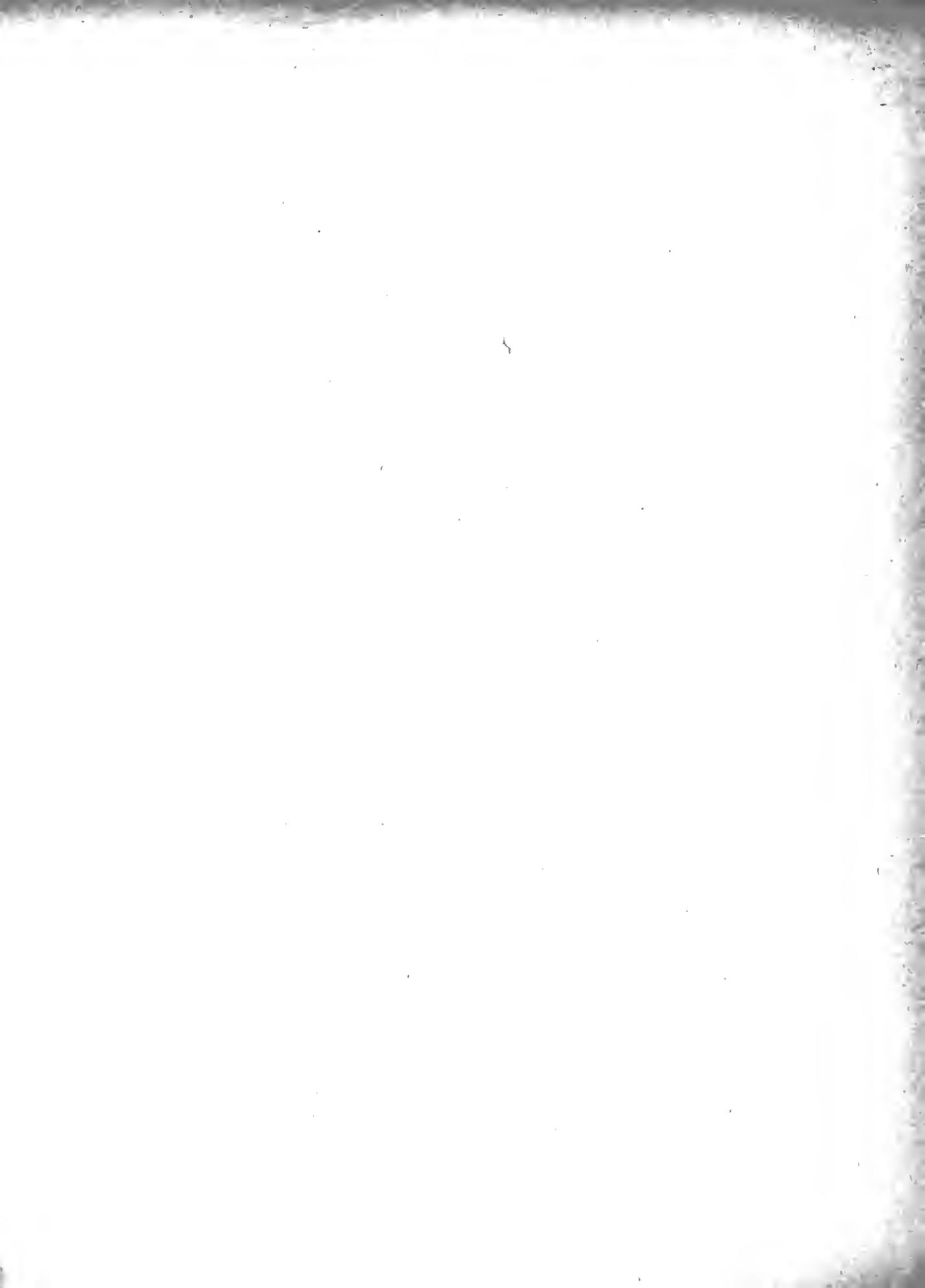

PLATE XVII.

PLATE XVII.

Chiridius armatus, (Boeck).

- Fig. 1. Adult female, dorsal view (left anterior antenna not fully drawn).
- 2. Same, viewed from right side.
 - 3. Frontal part of body, lateral view.
 - 4. Spiniform lateral corner of last segment of trunk.
 - 5. Posterior antenna.
 - 6. Mandible with palp.
 - 7. Maxilla.
 - 8. Anterior maxilliped.
 - 9. Posterior maxilliped.
 - 10. Natatory leg of 1st pair.
 - 11. Do. of 2nd pair.
 - 12. Do. of 4th pair.
 - 13. Extremity of tail with the caudal rami, dorsal view.
 - 14. Mandibular palp of male.
 - 15. Last pair of legs of same.
-

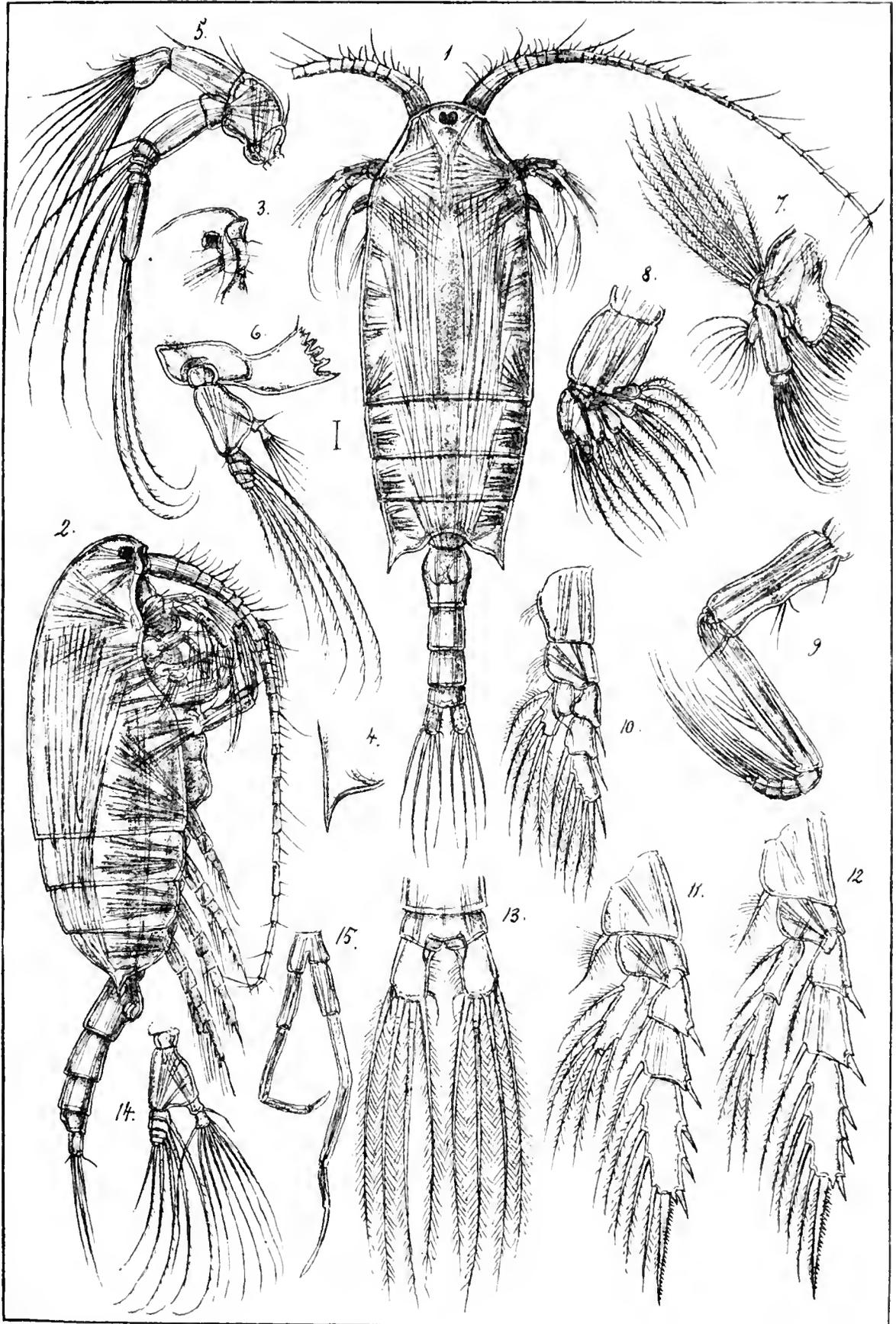



PLATE XVIII.

PLATE XVIII.

Chiridius tenuispinus, G. O. Sars.

- Fig. 1. Adult female, dorsal view (left anterior antenna not fully drawn).
— 2. Same, viewed from right side.
— 3. Frontal part of body, lateral view.
— 4. Last segment of trunk, exhibiting the spiniform processes of the lateral corners, dorsal view.
— 5. Posterior antenna.
— 6. Mandible with palp.
— 7. Maxilla.
— 8. Anterior maxilliped.
— 9. Posterior maxilliped.
— 10. Natatory leg of 1st pair.
— 11. Do. of 2nd pair.
— 12. Do. of 4th pair.
-

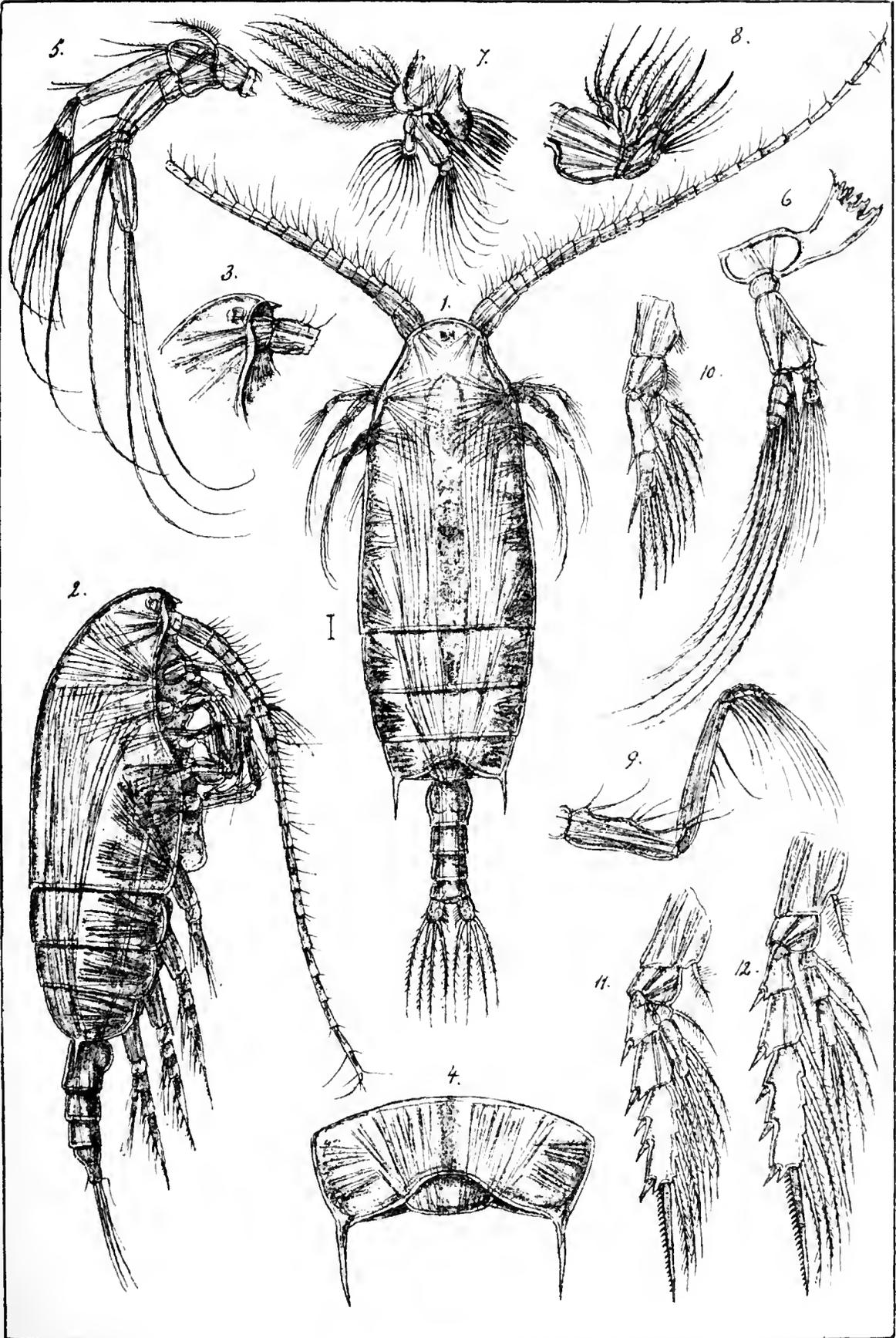



PLATE XIX.

PLATE XIX.

Chiridius brevispinus, G. O. Sars.

- Fig. 1. Adult female, dorsal view (anterior antenna not fully drawn).
— 2. Frontal part of body, lateral view.
— 3. Lateral part of last segment of trunk, showing the small spiniform process of the outer corner.
— 4. Posterior antenna.
— 5. Mandible with palp.
— 6. Maxilla.
— 7. Anterior maxilliped.
— 8. Posterior maxilliped.
— 9. Natatory leg of 1st pair.
— 10. Do. of 2nd pair.
— 11. Do. of 4th pair.
-

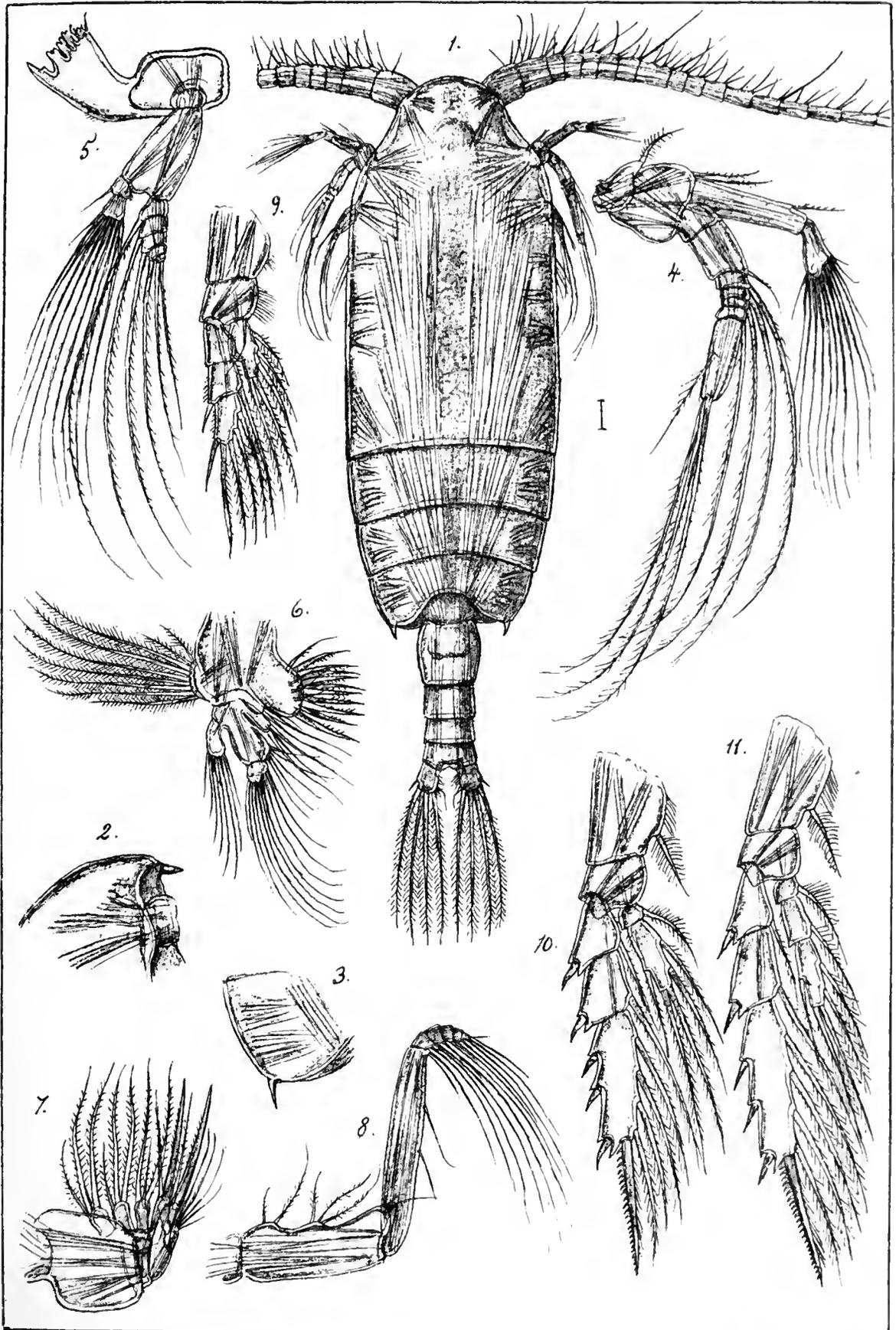



PLATE XX.

PLATE XX.

Pseudocalanus major, G. O. Sars.

- Fig. 1. Adult female, dorsal view (left anterior antenna not fully drawn).
- 2. Same, viewed from right side.
 - 3. Anterior antenna.
 - 4. Posterior antenna.
 - 5. Mandible with palp.
 - 6. Maxilla.
 - 7. Anterior maxilliped.
 - 8. Posterior maxilliped.
 - 9. Natatory leg of 1st pair.
 - 10. Do. of 2nd pair.
 - 11. Do. of 4th pair.
 - 12. Extremity of tail, with the caudal rami, dorsal view.
 - 13. Last pair of legs of male.
-

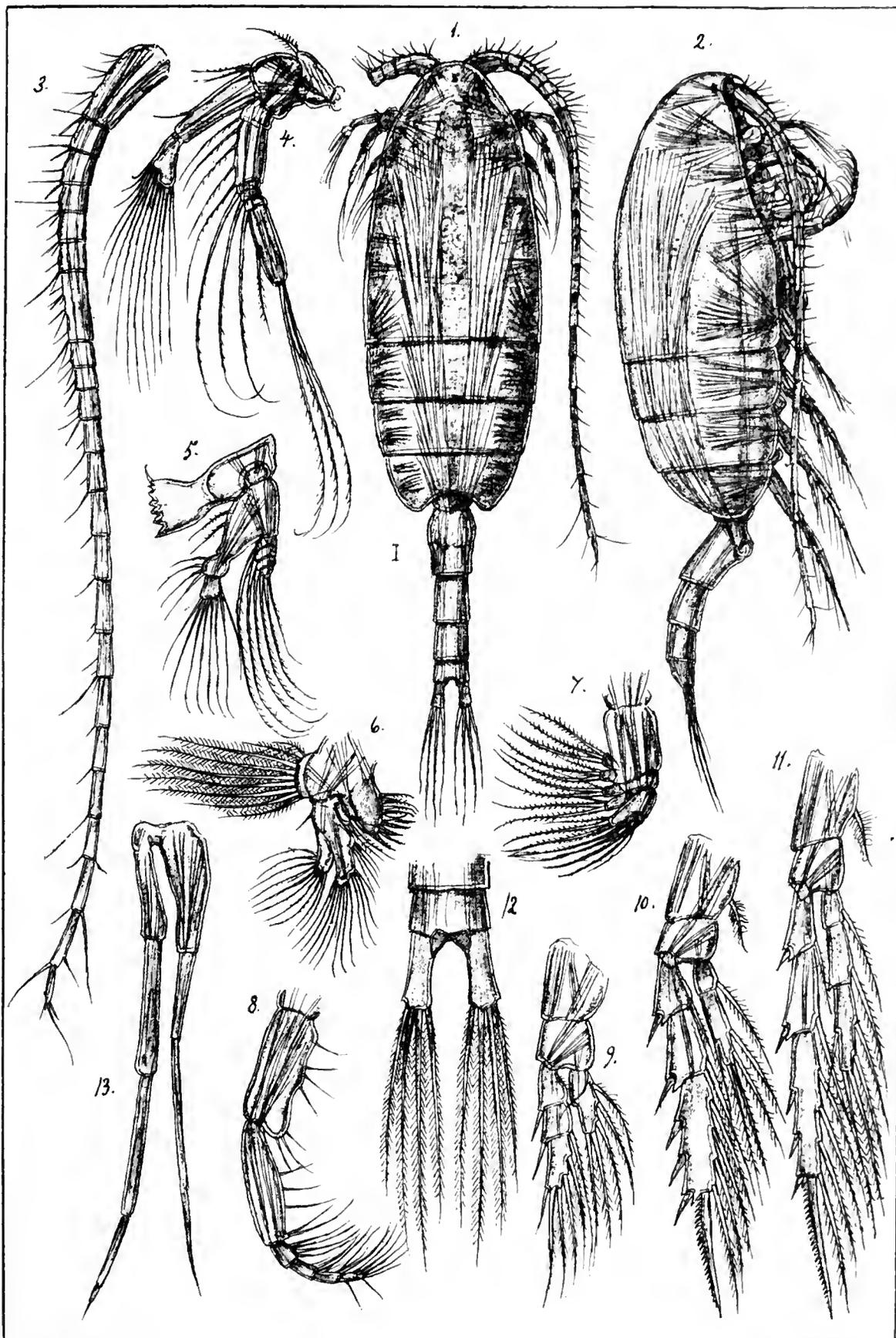
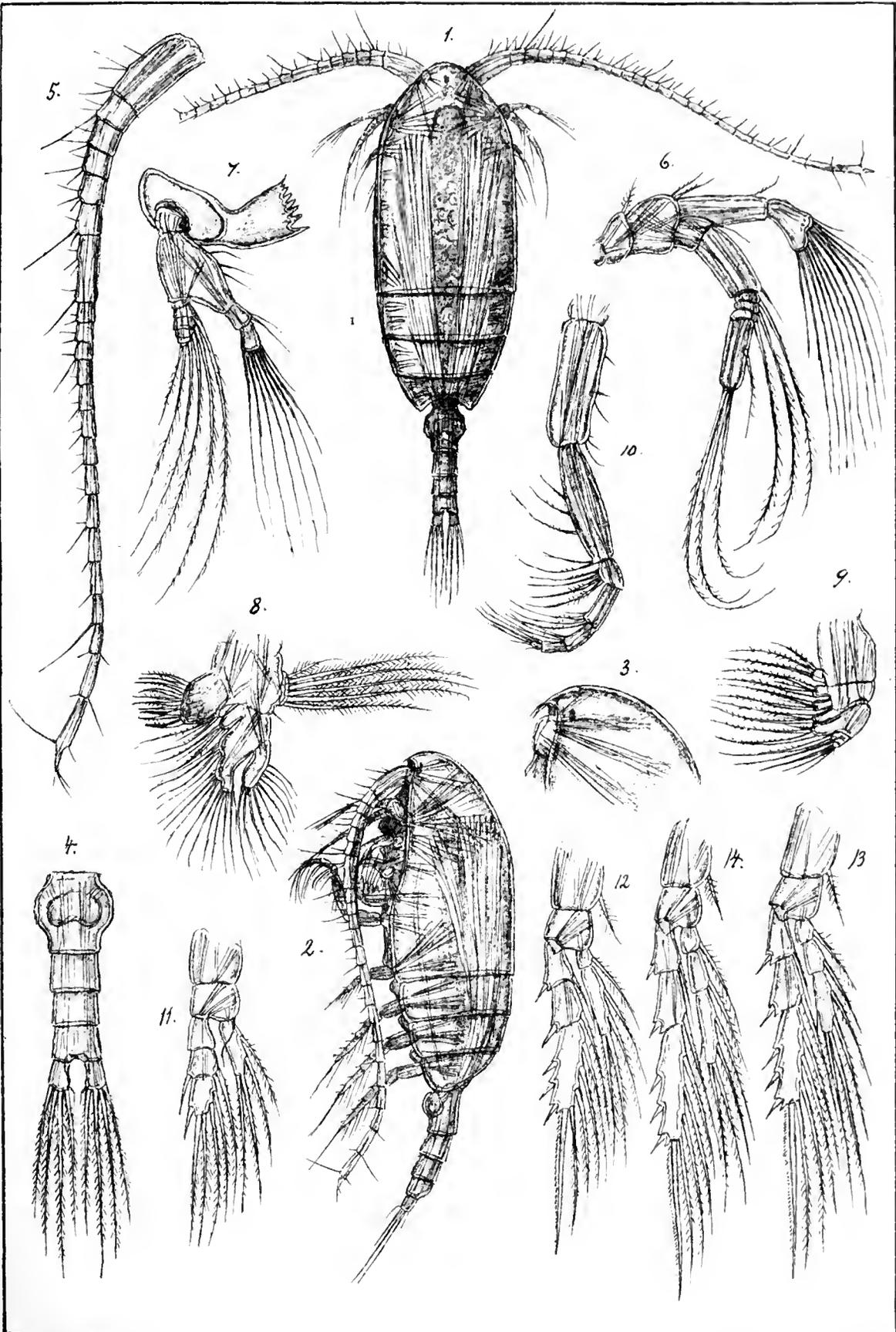

PLATE XXI.

PLATE XXI.

Pseudocalanus pygmæus, G. O. Sars.

- Fig. 1. Adult female, dorsal view (left anterior antenna not fully drawn).
- 2. Same, viewed from left side.
 - 3. Frontal part of body, lateral view.
 - 4. Tail, dorsal view.
 - 5. Anterior antenna.
 - 6. Posterior antenna.
 - 7. Mandible with palp.
 - 8. Maxilla.
 - 9. Anterior maxilliped.
 - 10. Posterior maxilliped.
 - 11. Natatory leg of 1st pair.
 - 12. Do. of 2nd pair.
 - 13. Do. of 3rd pair.
 - 14. Do. of 4th pair.
-



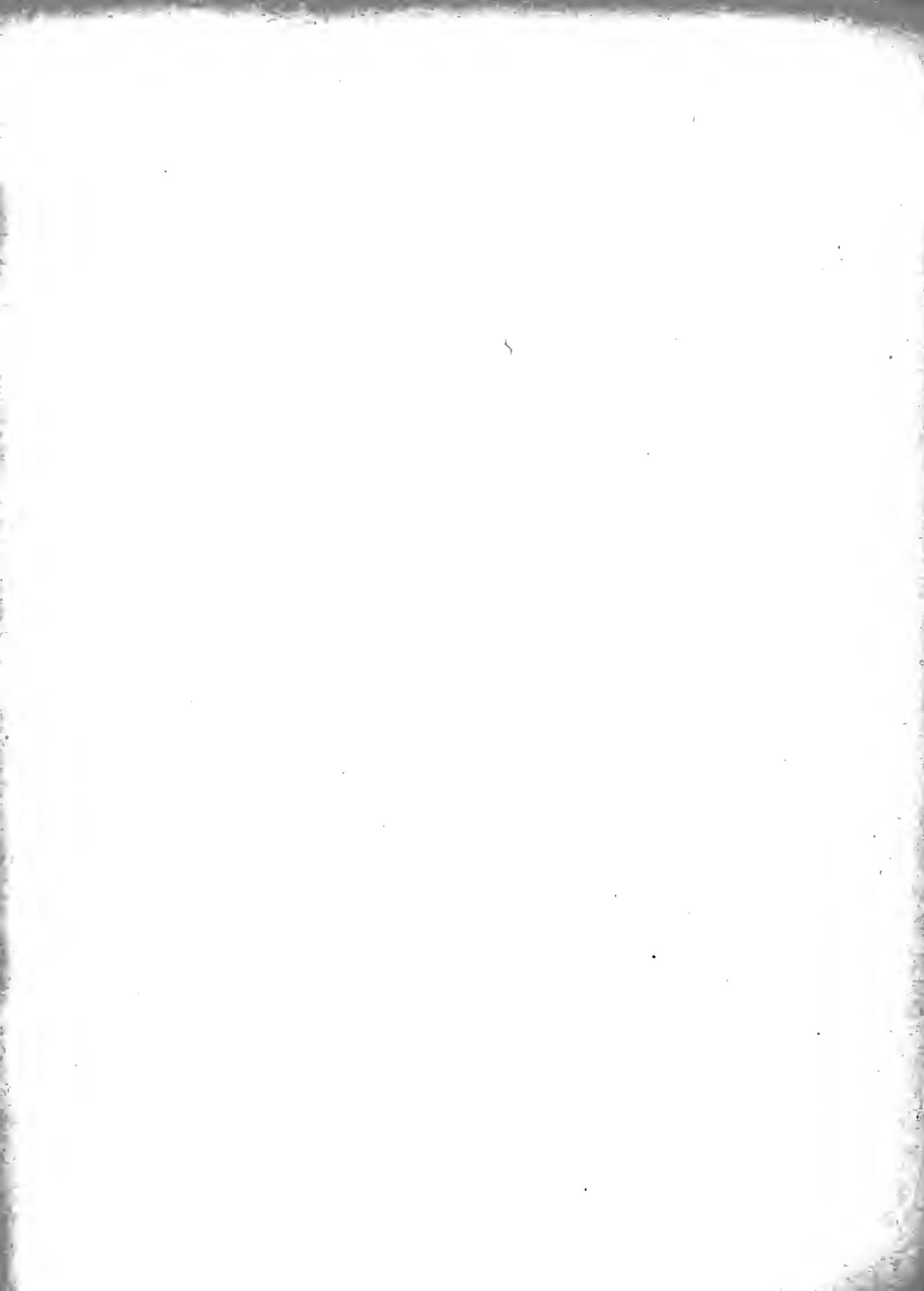
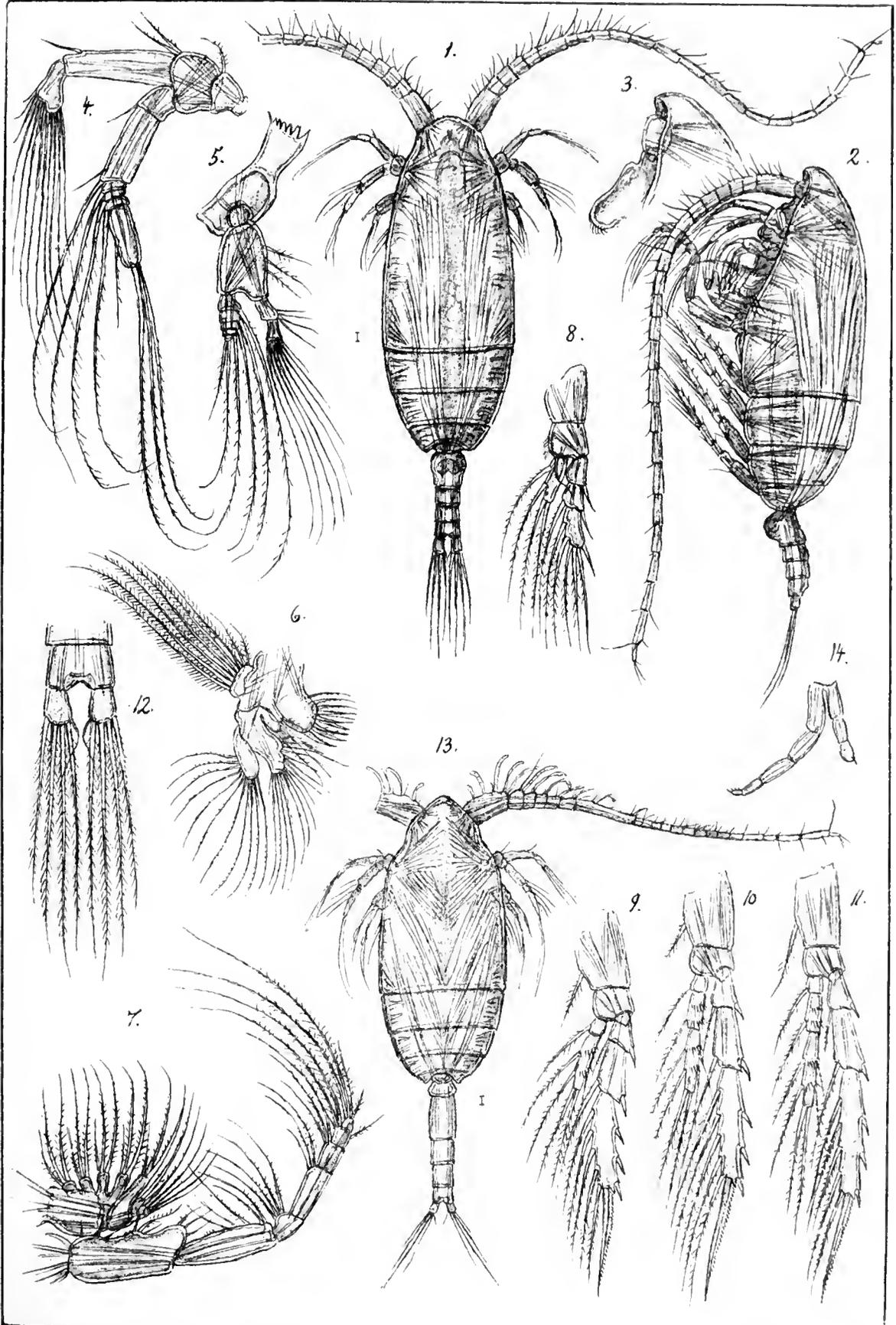

PLATE XXII.

PLATE XXII.

Spinocalanus longicornis, G. O. Sars.

- Fig. 1. Adult female, dorsal view (left anterior antenna not fully drawn).
- 2. Same, viewed from left side.
- 3. Frontal part of body, with the anterior lip, lateral view.
- 4. Posterior antenna.
- 5. Mandible with palp.
- 6. Maxilla.
- 7. Anterior and posterior maxillipeds.
- 8. Natatory leg of 1st pair.
- 9. Do. of 2nd pair.
- 10. Do. of 3rd pair.
- 11. Do. of 4th pair.
- 12. Extremity of tail, with the caudal rami, dorsal view.
- 13. Adult male, dorsal view (left anterior antenna not fully drawn).
- 14. Last pair of legs of same.
-



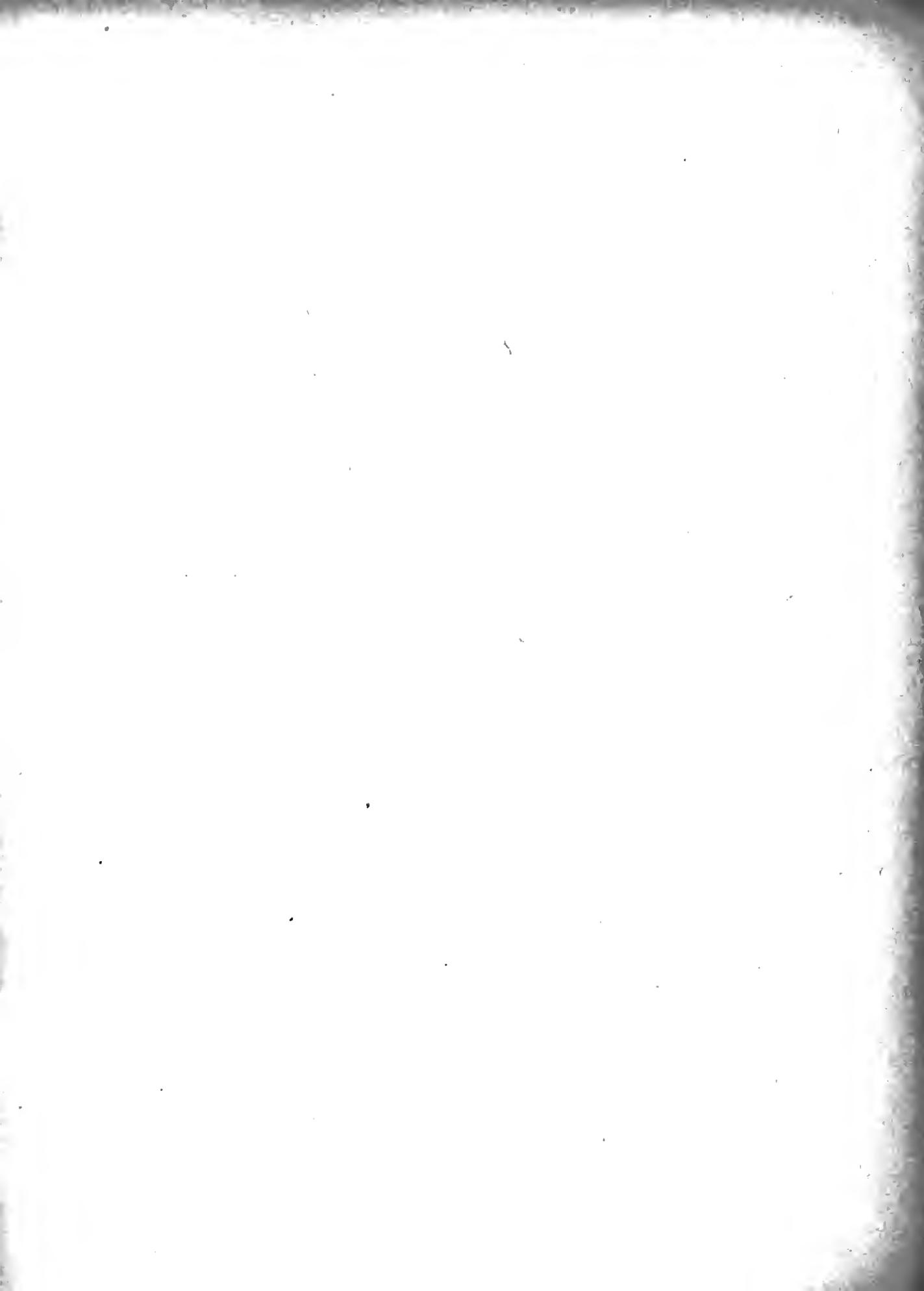
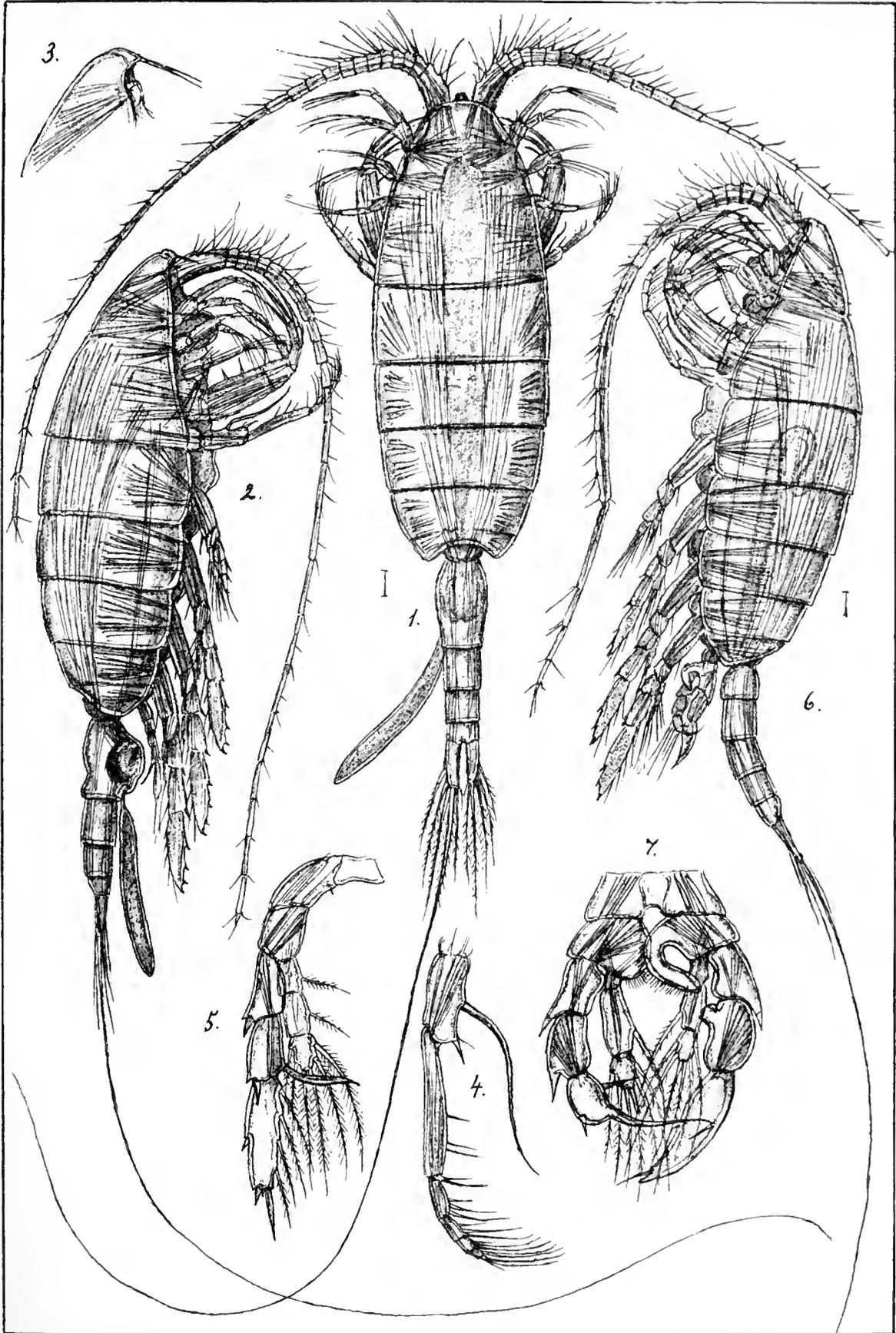

PLATE XXIII.

PLATE XXIII.

Heterochaeta norvegica, Boeck.

- Fig. 1. Adult female, with adhering spermatophore, dorsal view
(right anterior antenna not fully drawn).
- 2. Same, viewed from right side.
 - 3. Frontal part of body, lateral view.
 - 4. Posterior maxilliped.
 - 5. Leg of last pair of female.
 - 6. Adult male, viewed from left side.
 - 7. Last pair of legs of same.
-



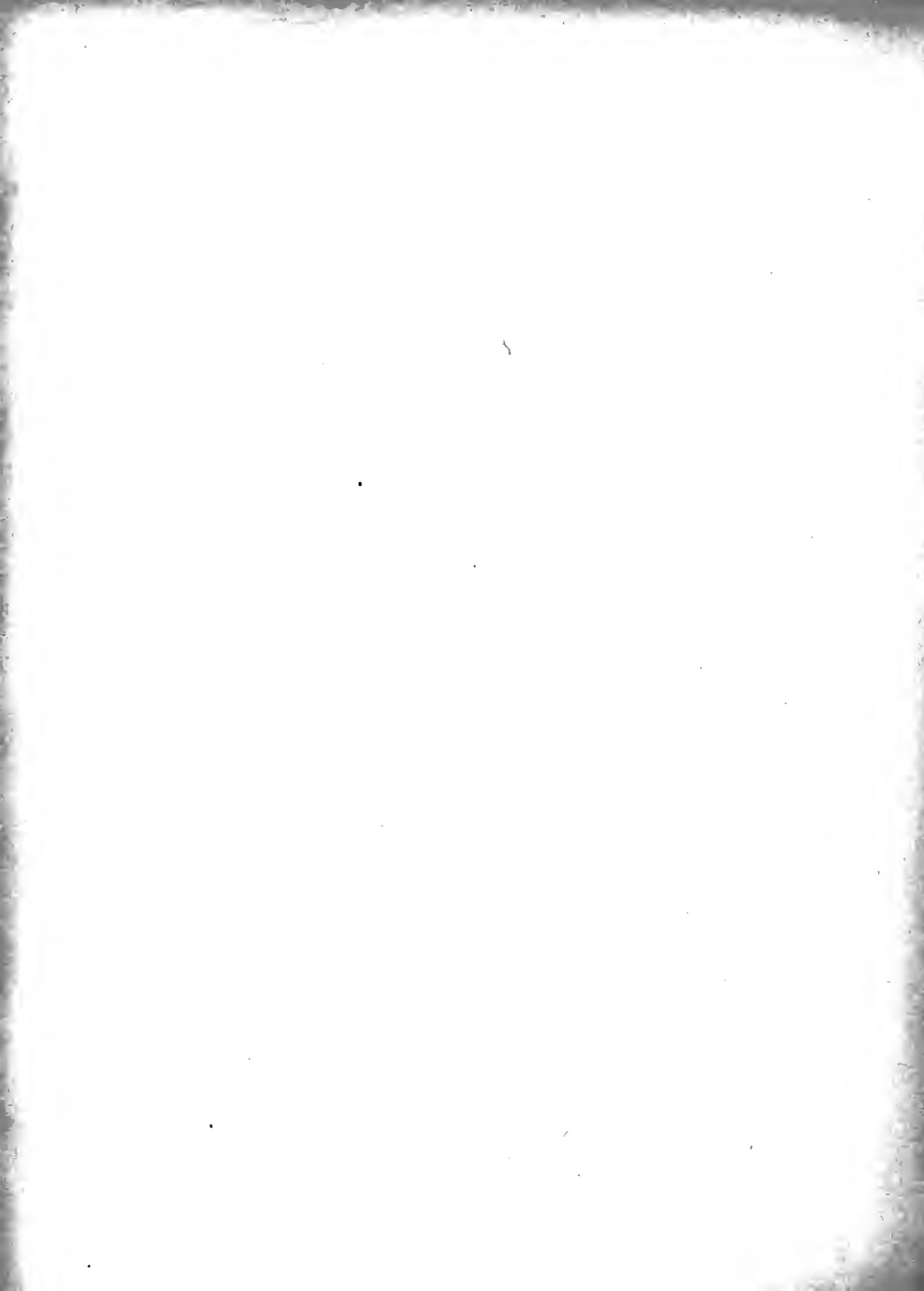
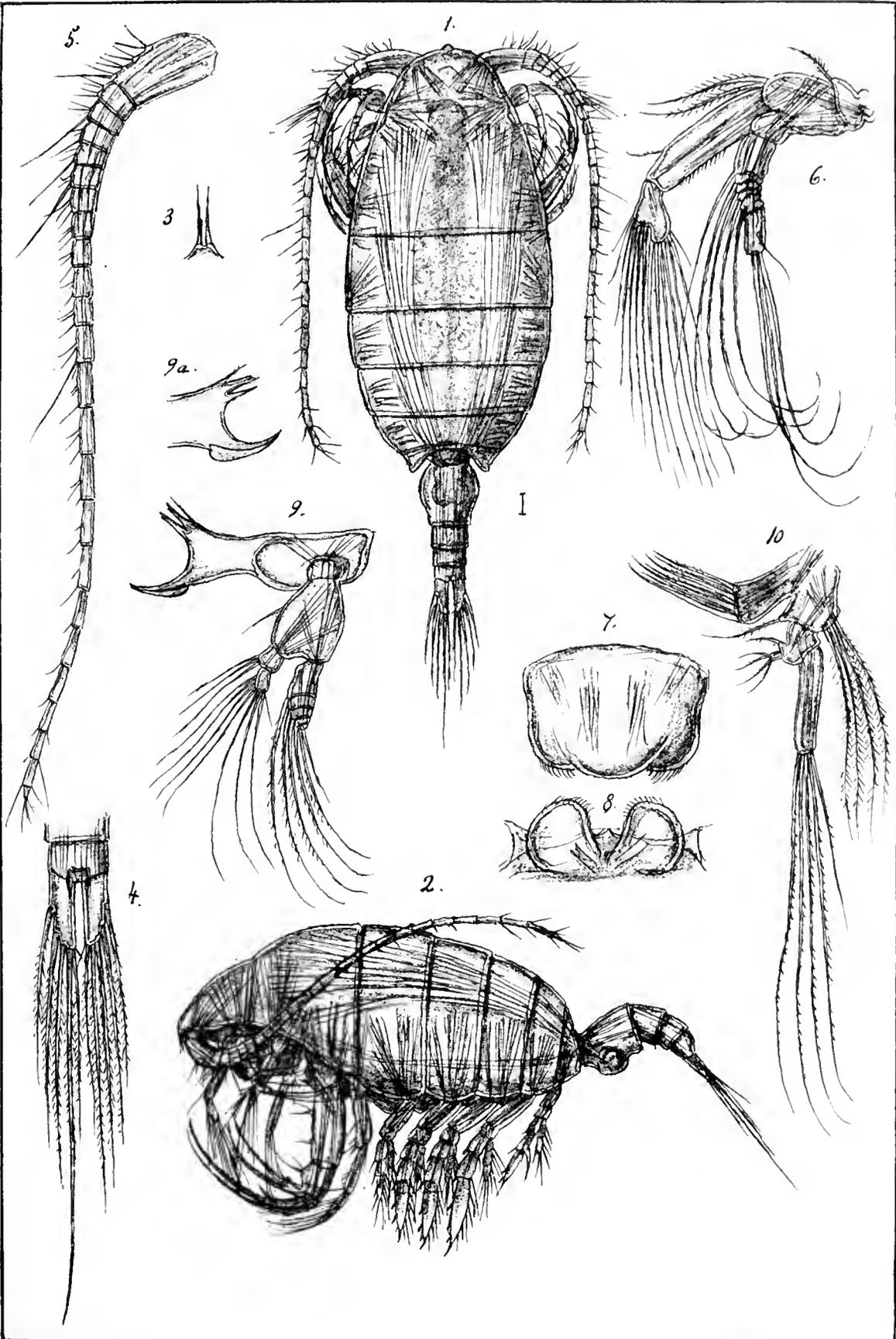

PLATE XXIV.

PLATE XXIV.

Heterochaeta compacta, G. O. Sars.

- Fig. 1. Adult female, dorsal view.
— 2. Same, viewed from left side.
— 3. Rostral prominence, with the tentacular filaments, front view.
— 4. Extremity of tail, with the caudal rami, dorsal view.
— 5. Anterior antenna.
— 6. Posterior antenna.
— 7. Anterior lip.
— 8. Posterior lip.
— 9. Right mandible with palp.
— 9a. Masticatory part of left mandible.
— 10. Maxilla.
-



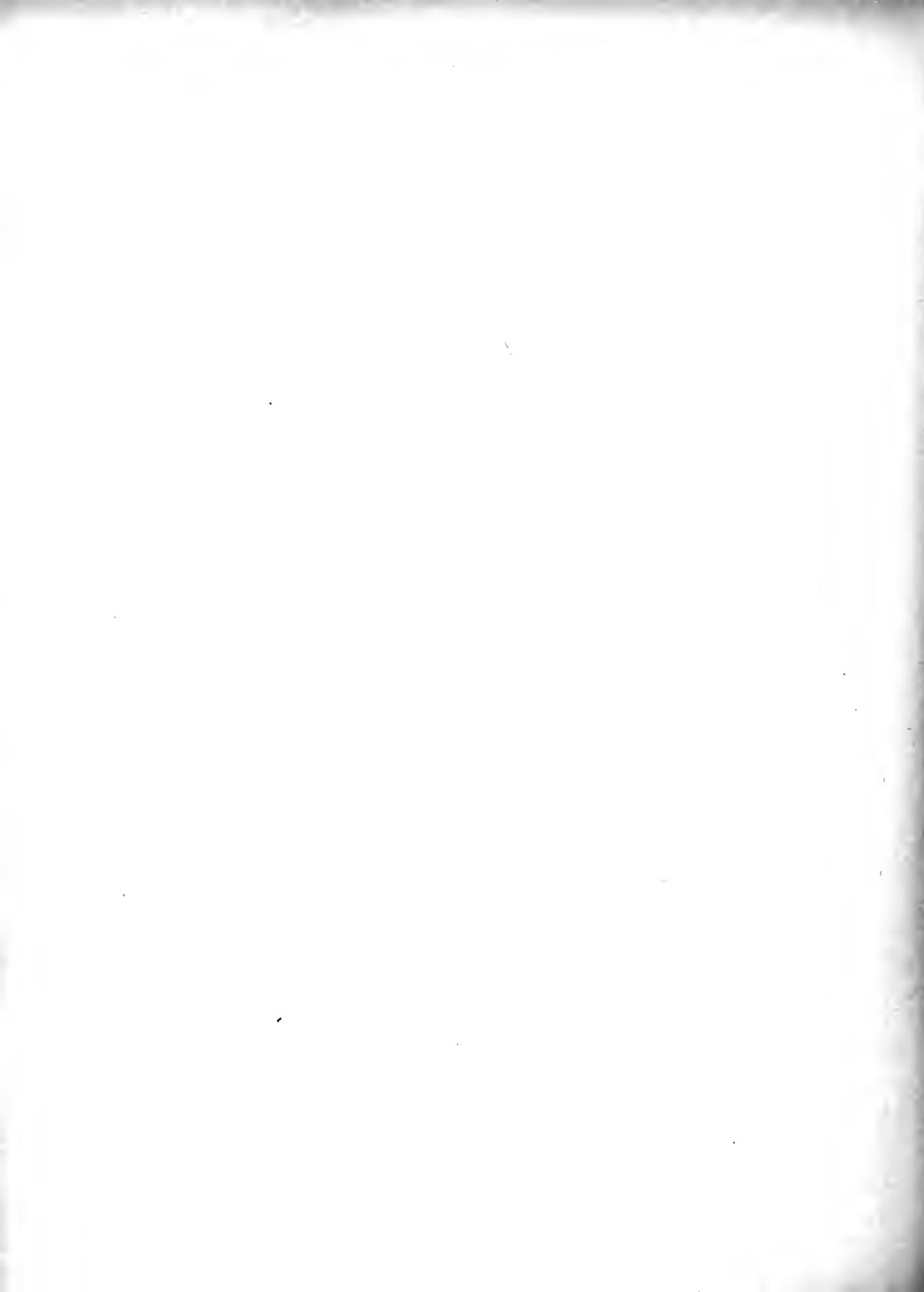
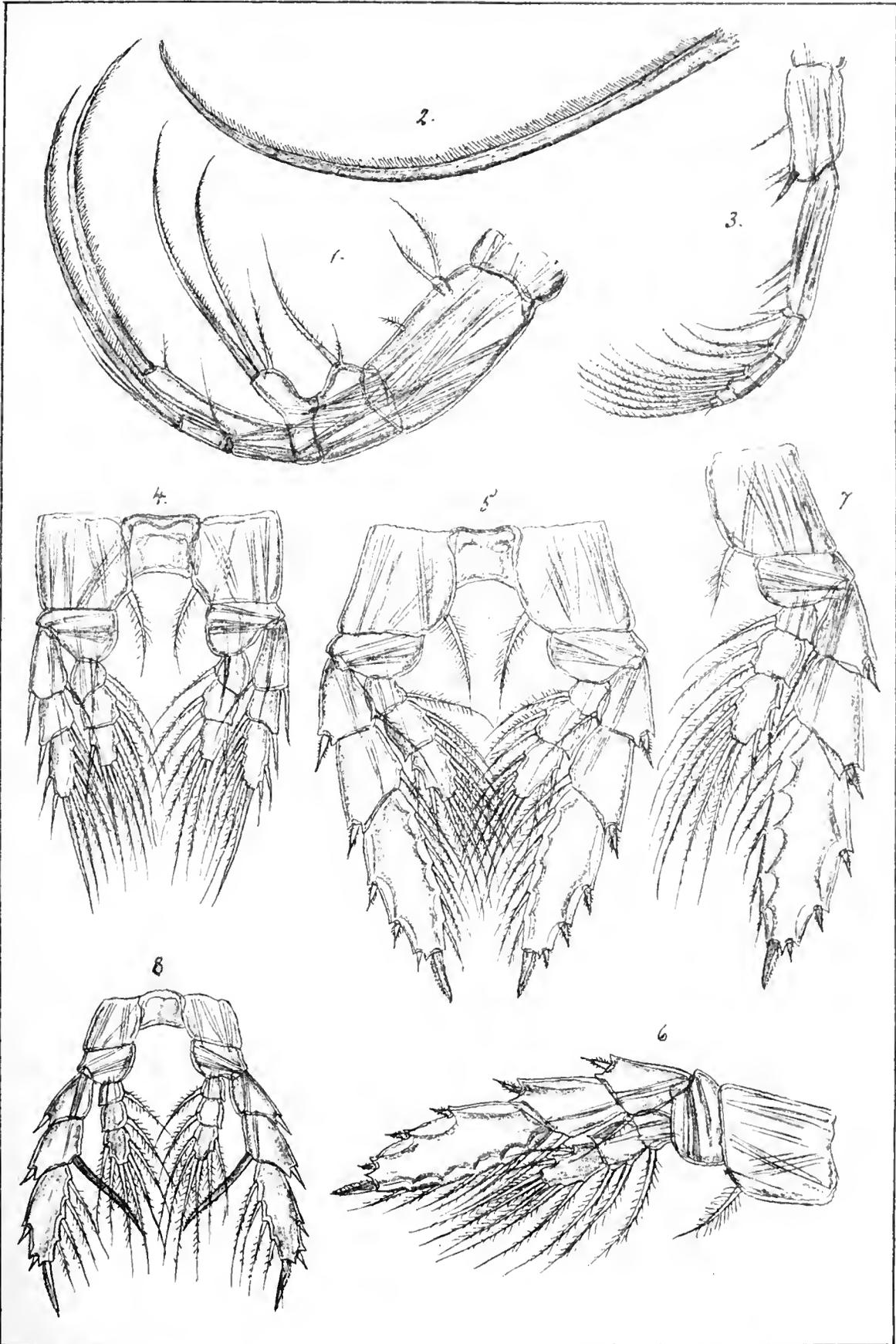

PLATE XXV.

PLATE XXV.

Heterochæta compacta, G. O. Sars,
(continued).

- Fig. 1. Anterior maxilliped.
— 2. One of the terminal claws of same, more highly magnified.
— 3. Posterior maxilliped.
— 4. First pair of legs.
— 5. Second pair of legs.
— 6. Leg of 3rd pair.
— 7. Leg of 4th pair.
— 8. Last pair of legs.
-



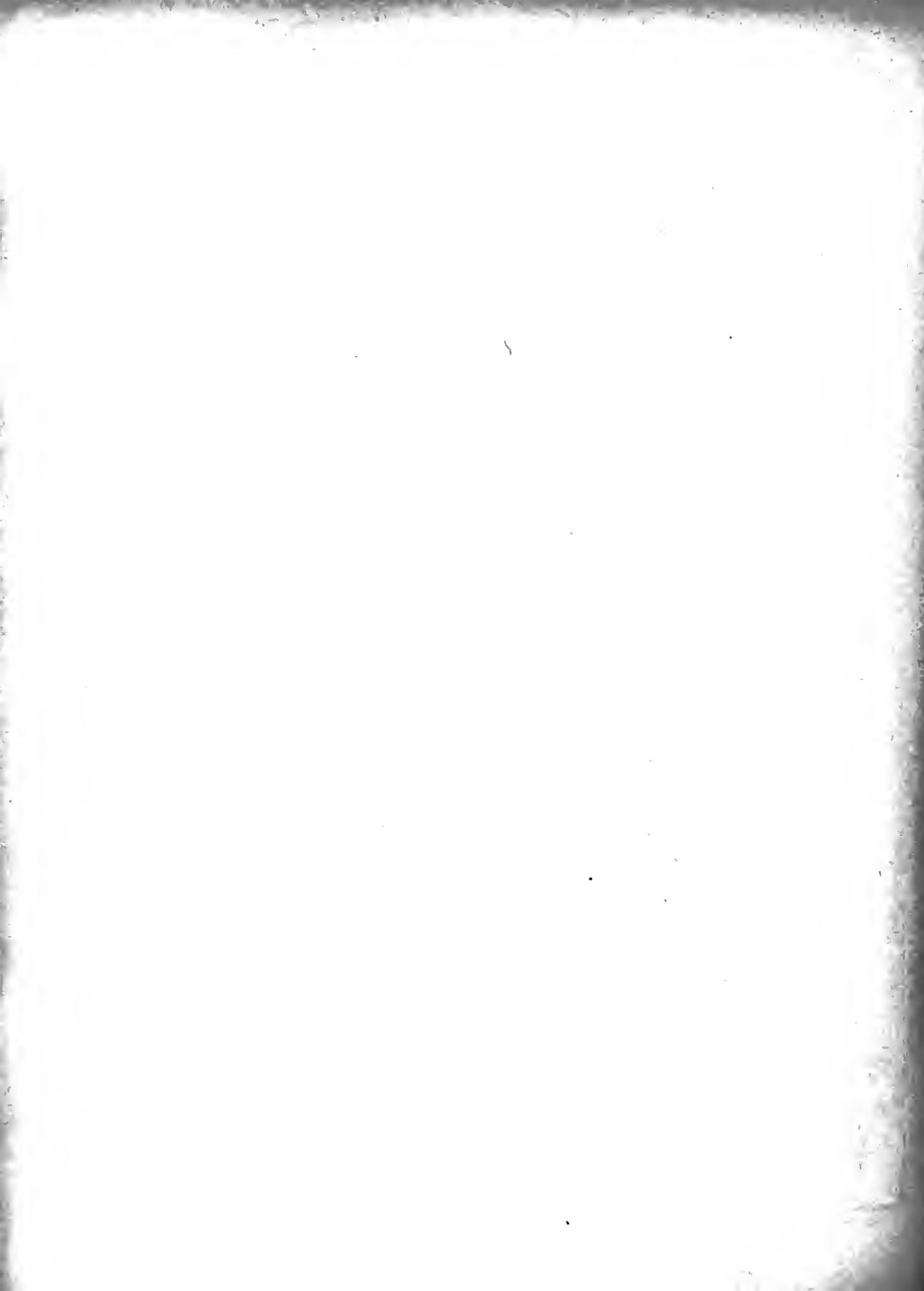
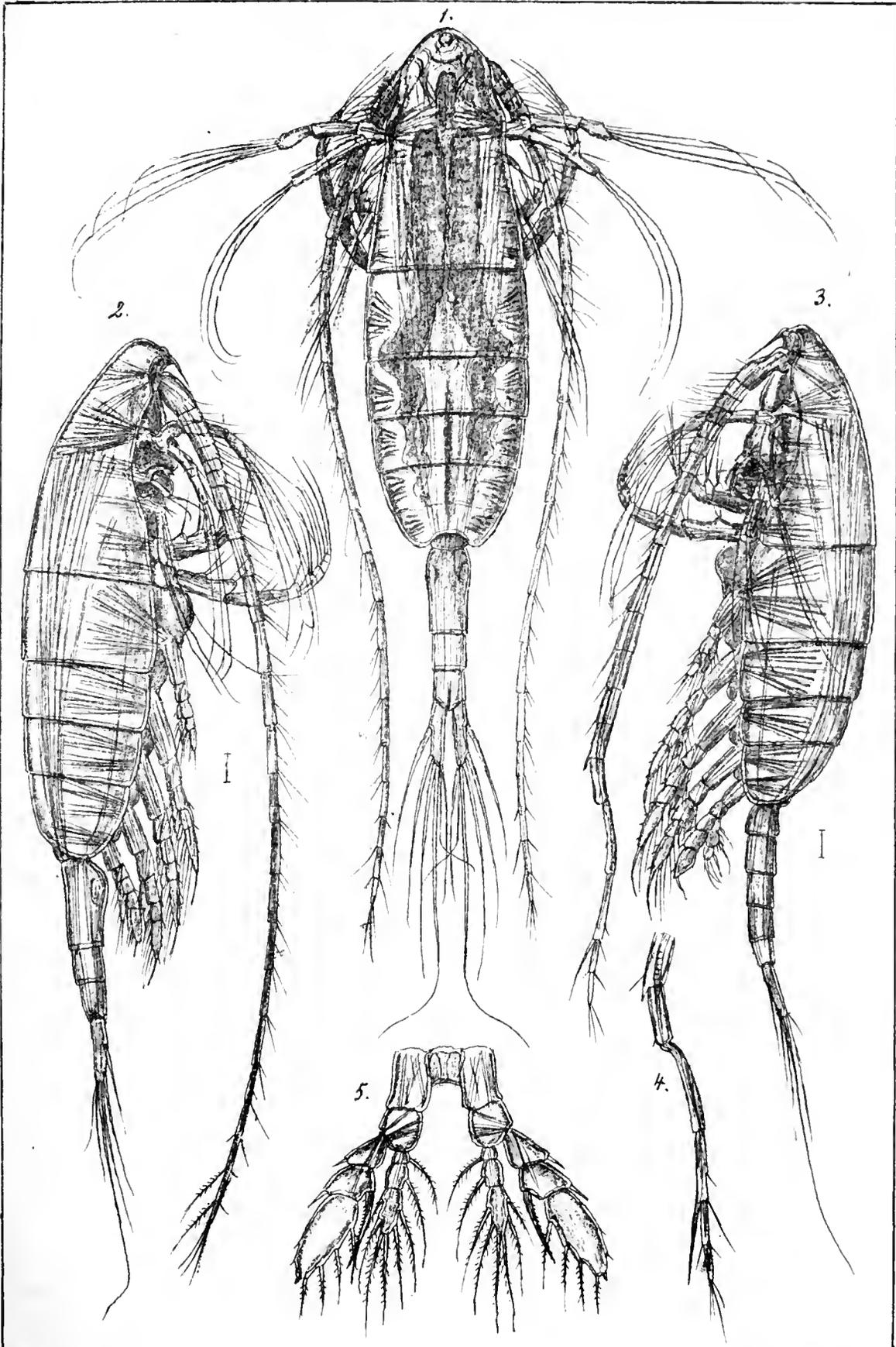

PLATE XXVI.

PLATE XXVI.

Angaptilus glacialis, G. O. Sars.

- Fig. 1. Adult female, dorsal view.
— 2. Same, viewed from right side.
— 3. Adult male, viewed from left side.
— 4. Same, terminal part of left anterior antenna.
— 5. Last pair of legs of female.
-



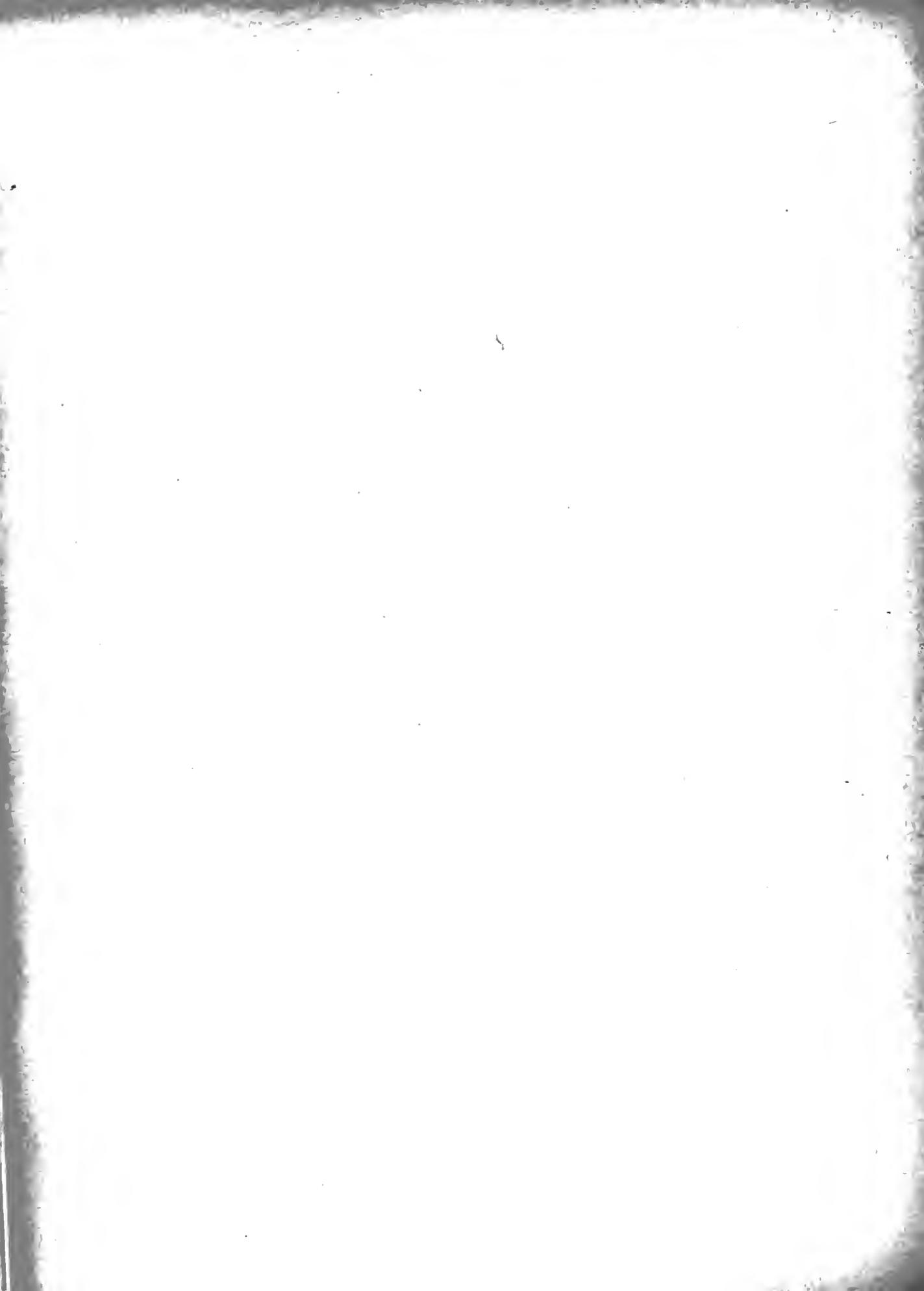

PLATE XXVII.

PLATE XXVII.

Augaptilus glacialis, G. O. Sars,
(continued.)

- Fig. 1. Rostral prominence, with the tentacular filaments, front view.
— 2. Distal part of anterior antenna.
— 3. Posterior antenna.
— 4. Mandible with palp.
— 5. Maxilla.
— 6. Anterior maxilliped.
— 7. Posterior maxilliped.
— 8. First pair of legs.
— 9. Leg of 2nd pair.
— 10. Last pair of legs of male.
— 11. Extremity of tail, with the caudal rami, dorsal view.
-

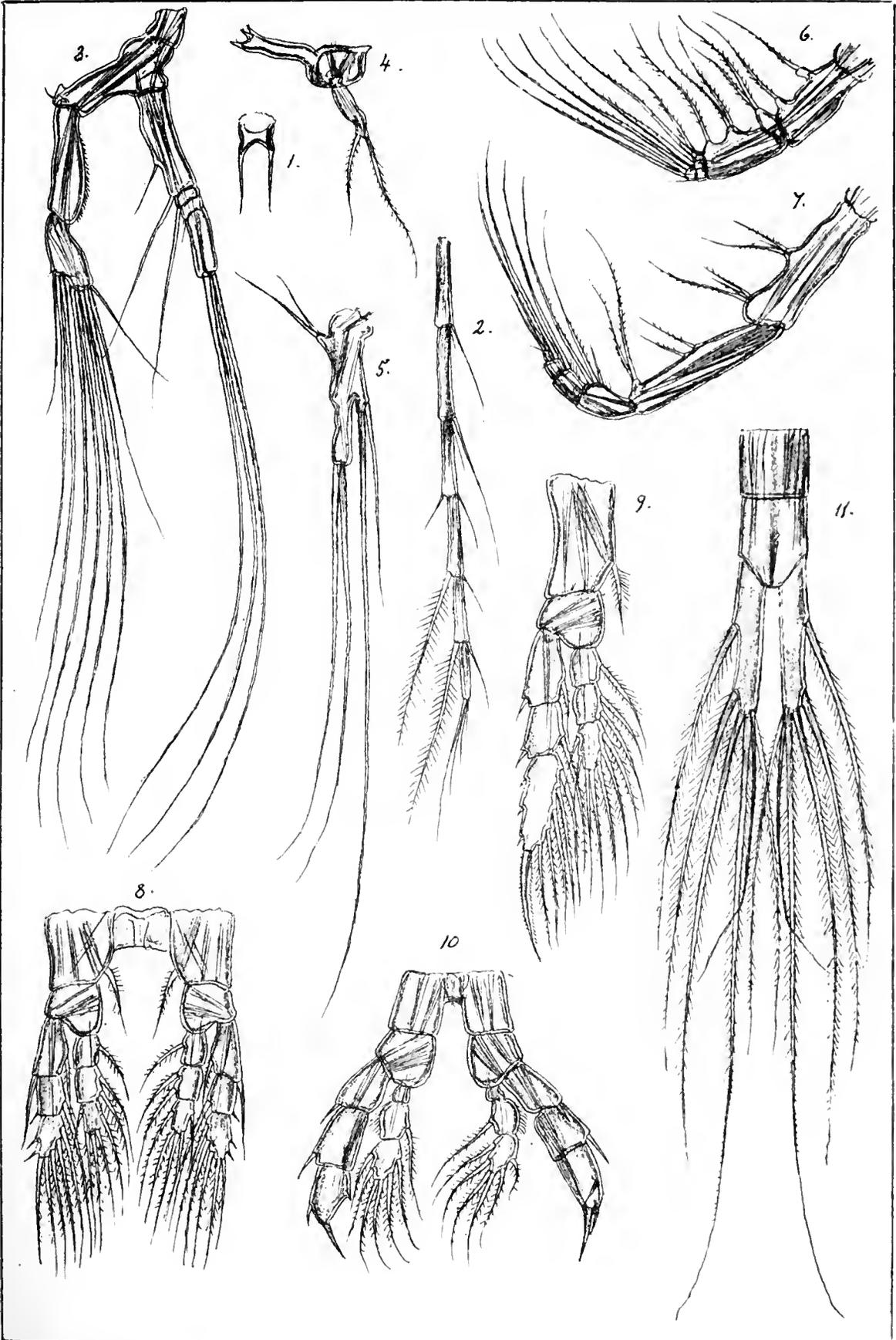

PLATE XXVIII.

PLATE XXVIII.

Hemicalanus spinifrons, G. O. Sars.

- Fig. 1. Adult female, dorsal view (left anterior antenna not fully drawn).
- 2. Spiniform frontal process.
 - 3. Posterior antenna.
 - 3 (bis). Mandible with palp.
 - 4. Body of left mandible, viewed from inner face.
 - 5. Masticatory part of right mandible.
 - 6. Maxilla.
 - 7. Anterior maxilliped.
 - 8. Posterior maxilliped.
 - 9. Leg of 1st pair.
 - 10. Leg of 2nd pair.
 - 11. Last pair of legs.
 - 12 (not numbered in the plate). Tail, dorsal view.
-

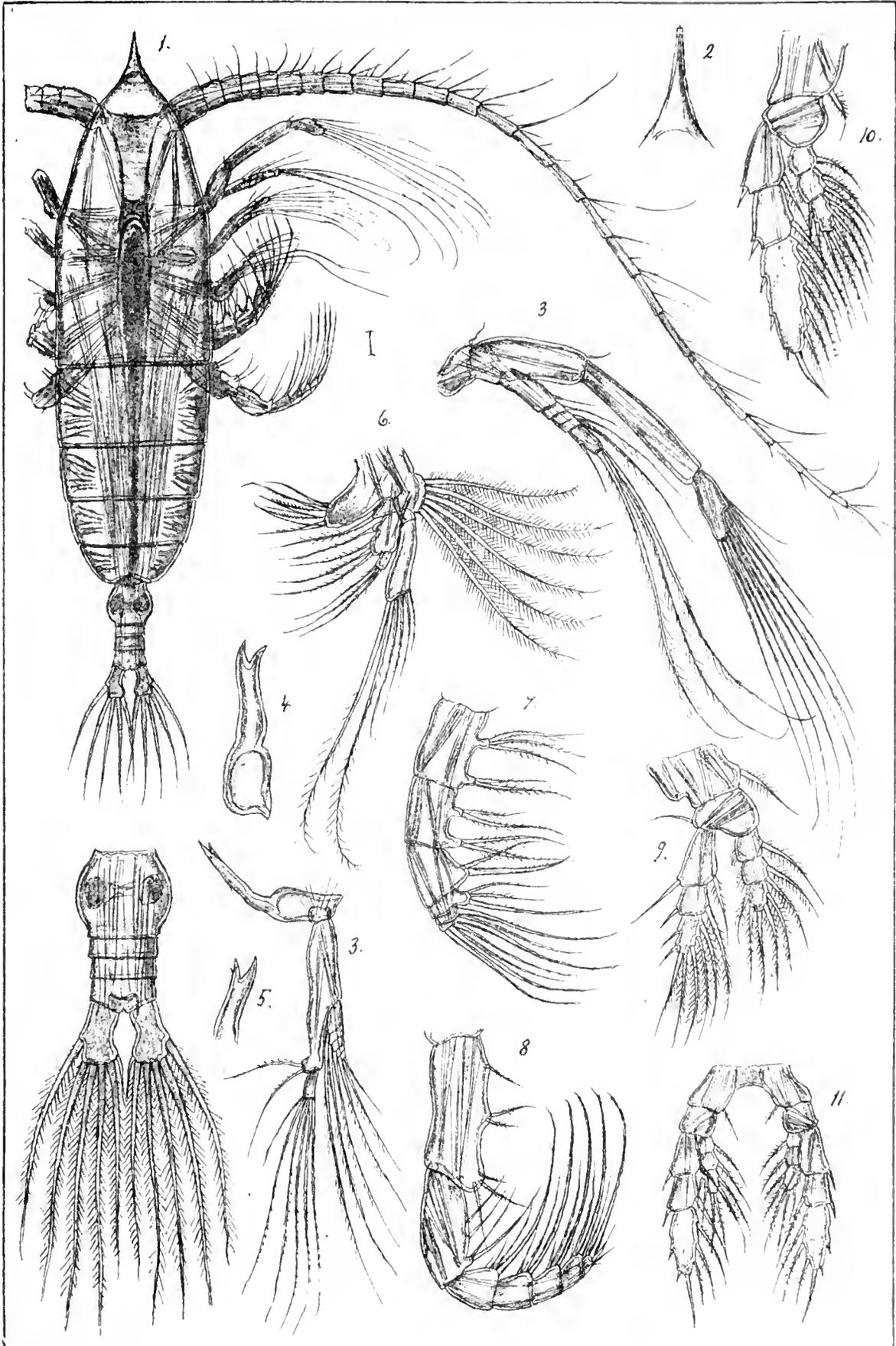

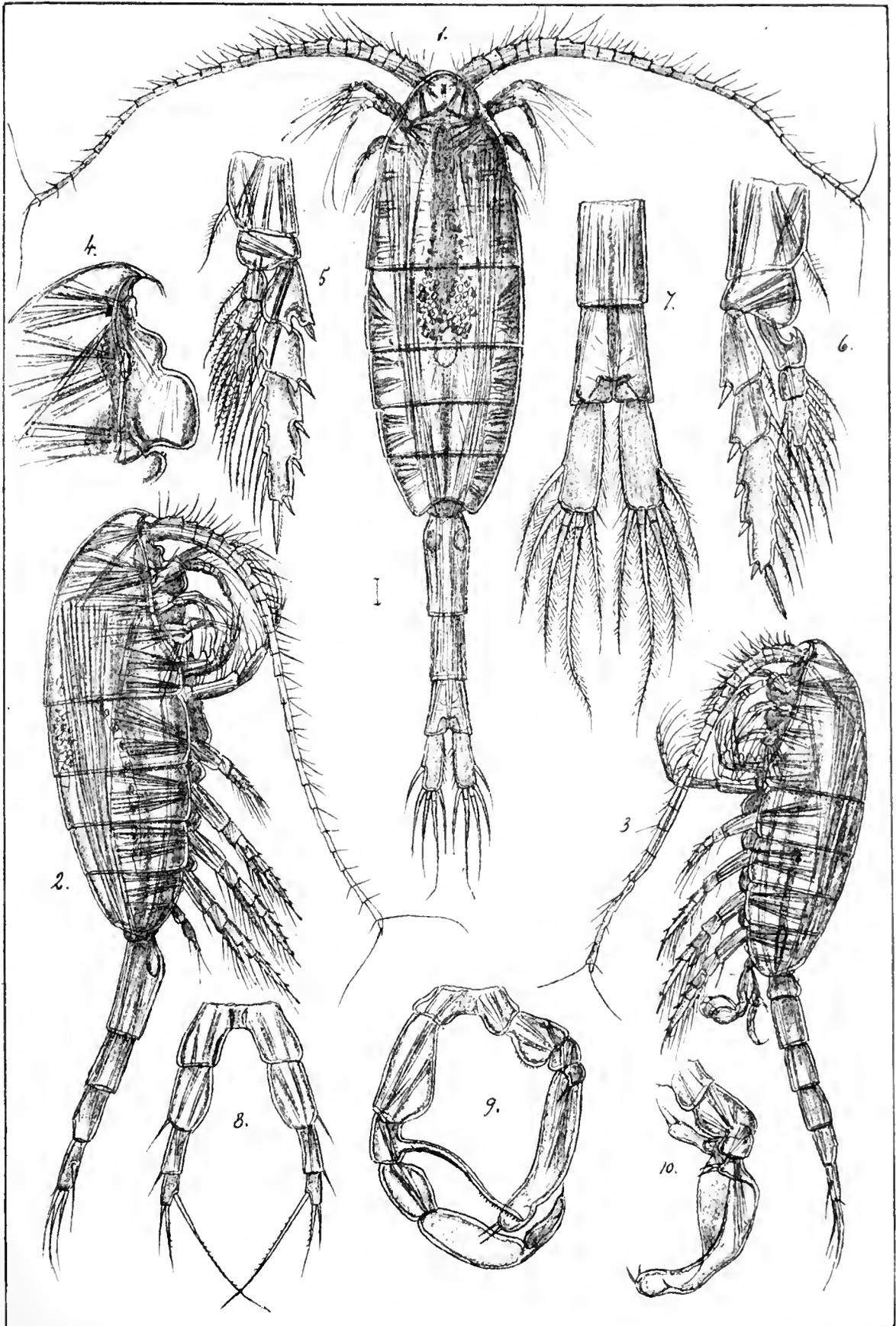

PLATE XXIX.

PLATE XXIX.

Metridia longa, (Lubbock).

- Fig. 1. Adult female, dorsal view.
— 2. Same, viewed from right side.
— 3. Adult male, viewed from left side.
— 4. Frontal part of body, with anterior and posterior lips, lateral view.
— 5. Natatory leg of 3rd pair of male.
— 6. — of 2nd pair of female.
— 7. Extremity of tail with the caudal rami, dorsal view.
— 8. Last pair of legs of female.
— 9. Last pair of legs of male.
— 10. Right leg of same pair, isolated.
-



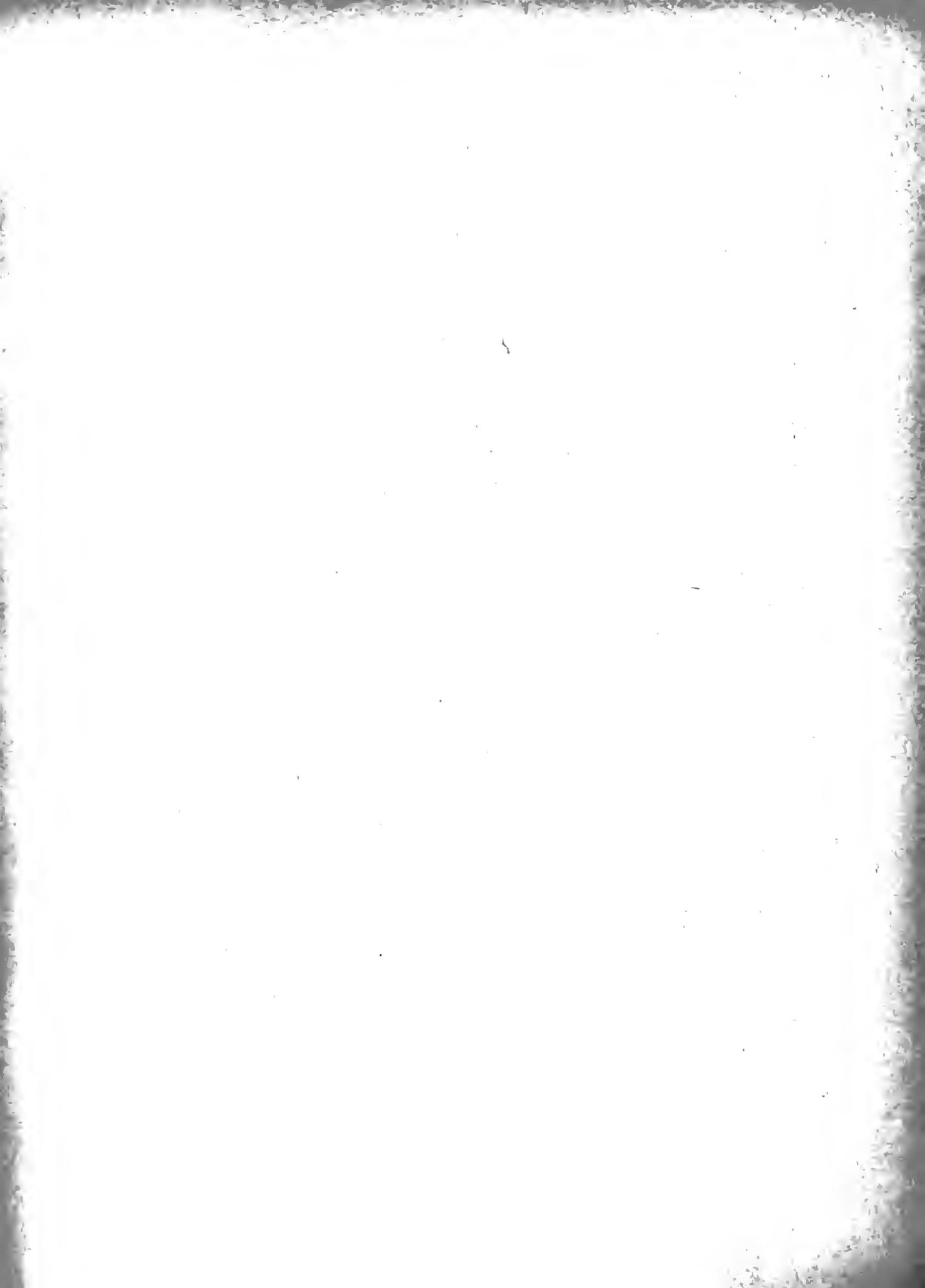
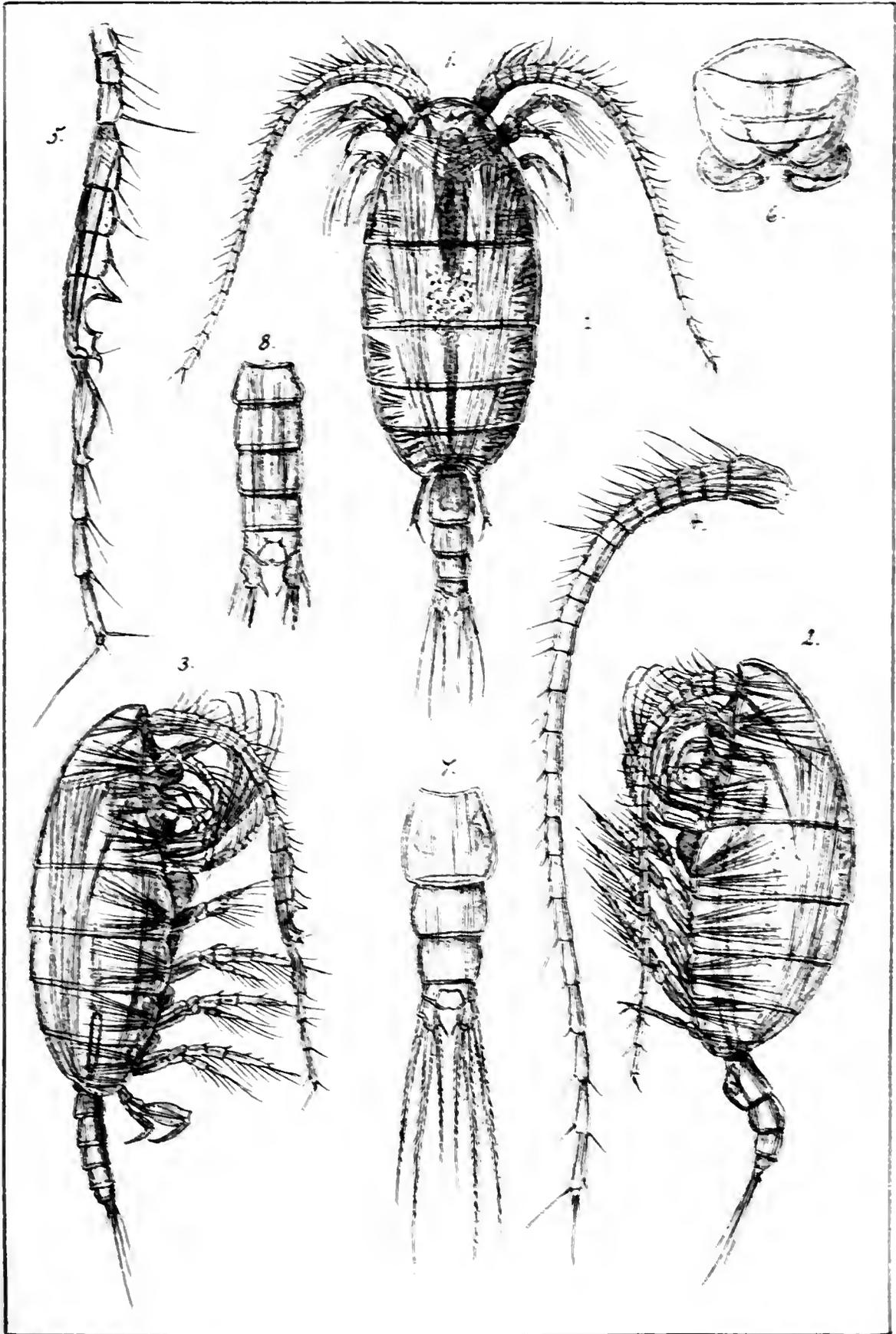

PLATE XXX.

PLATE XXX.

Temorites brevis, G. O. Sars.

- Fig. 1. Adult female, dorsal view.
— 2. Same, viewed from left side.
— 3. Adult male, viewed from right side.
— 4. Anterior antenna of female.
— 5. Right anterior antenna of male (the proximal part not drawn).
— 6. Anterior and posterior lips, ventral view.
— 7. Tail of female, dorsal view.
— 8. Tail of male (caudal setæ not fully drawn).
-



G.O. Sars autogr.

copied from the original drawing

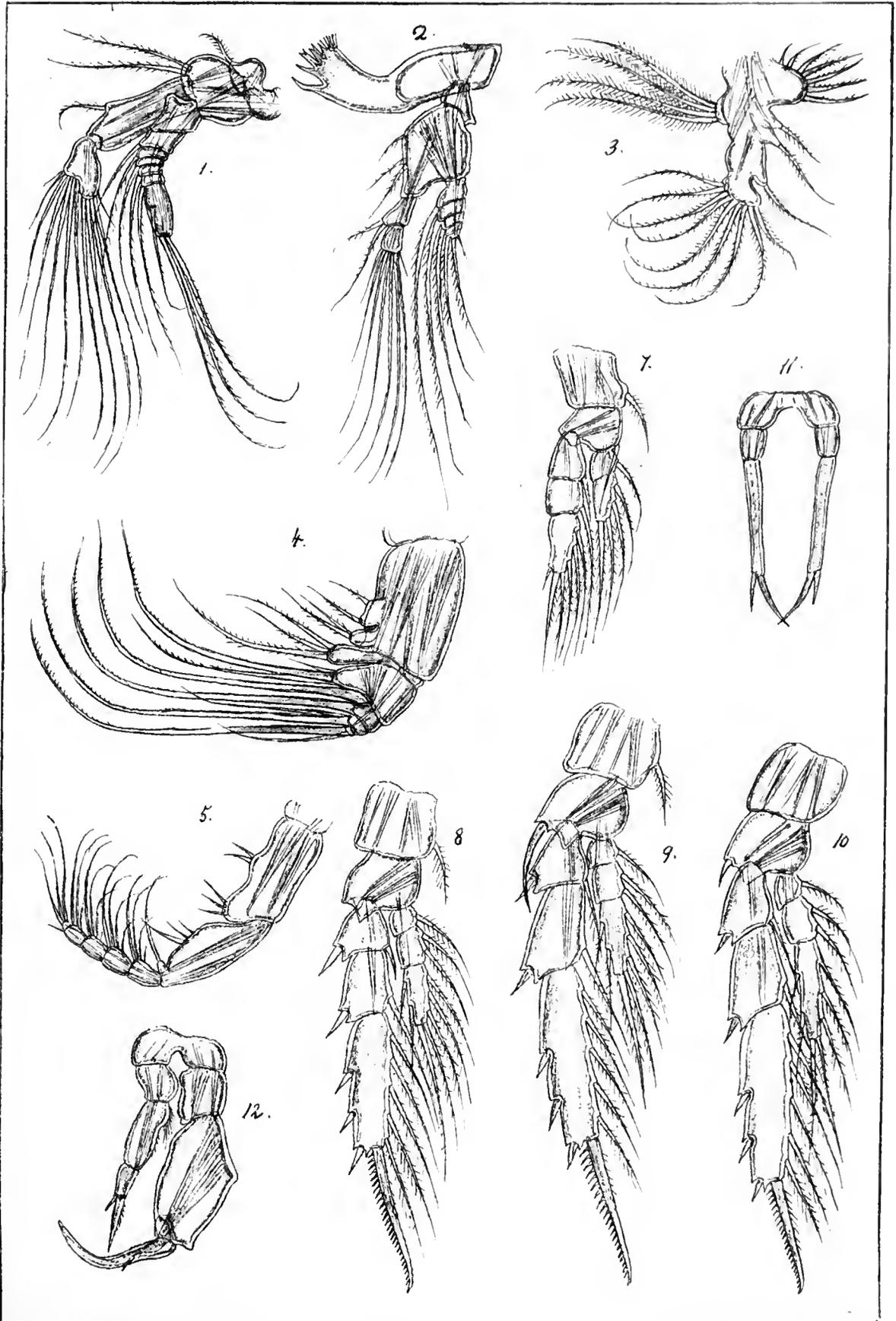

PLATE XXXI.

PLATE XXXI.

Temorites brevis, G. O. Sars,
(continued).

- Fig. 1. Posterior antenna.
— 2. Mandible with palp.
— 3. Maxilla.
— 4. Anterior maxilliped.
— 5. Posterior maxilliped.
— 6. Natatory leg of 1st pair.
— 7. Do. of 2nd pair.
— 8. Do. of 3rd pair.
— 9. Do. of 4th pair.
— 10. Last pair of legs of female.
— 11. Last pair of legs of male.
-



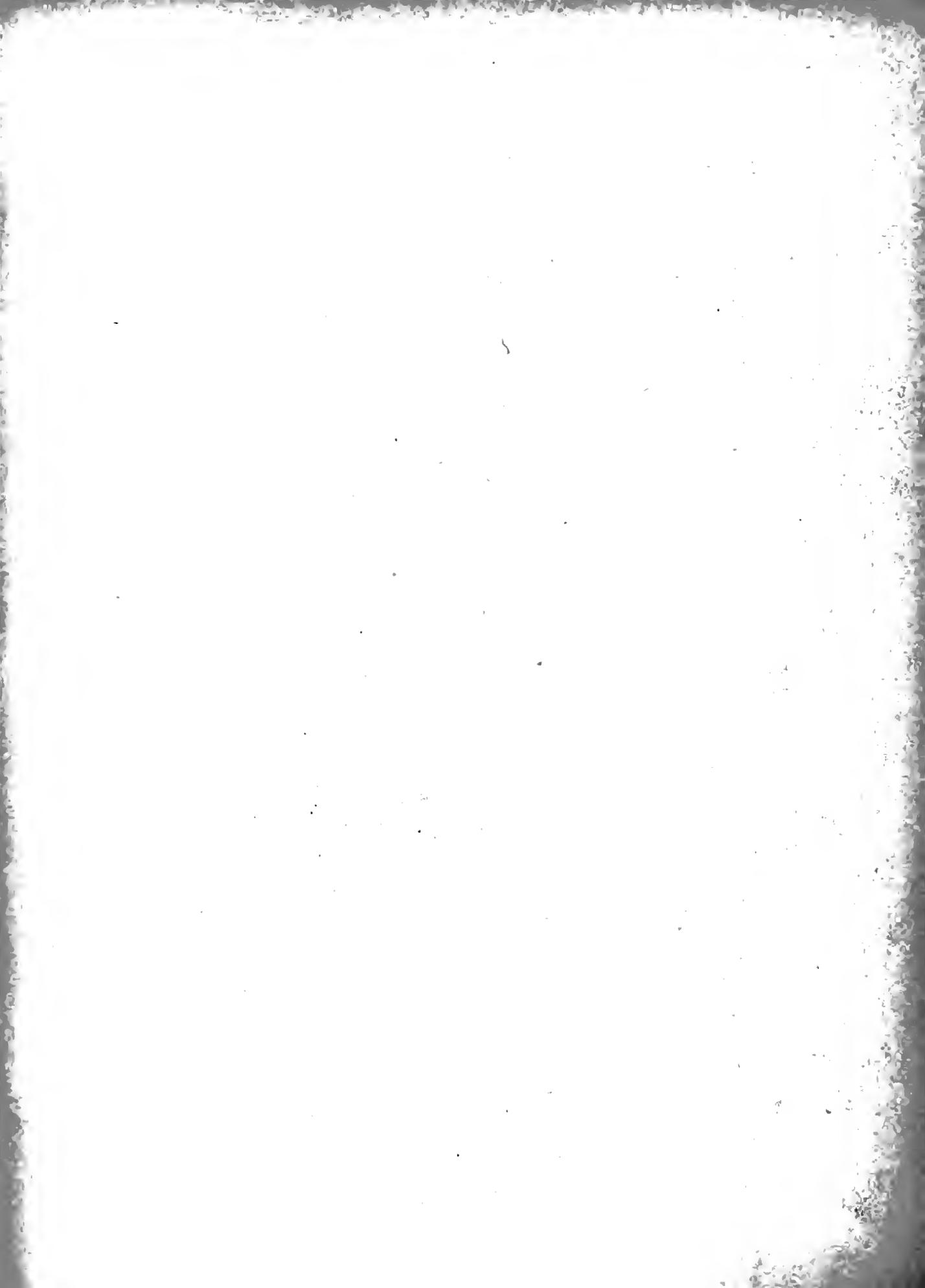

PLATE XXXII.

PLATE XXXII.

Oncaea notopus, Giesbrecht.

- Fig. 1. Adult female, dorsal view.
— 2. Same, viewed from right side.
— 3. Anterior antenna.
— 4. Posterior antenna.
— 5. Mandible.
— 6. Maxilla.
— 7. Anterior maxilliped.
— 8. Posterior maxilliped.
— 9. First pair of natatory legs.
— 10. Natatory leg of 2nd pair.
— 11. Do. of 3rd pair.
— 12. Do. of 4th pair.
— 13. Leg of last pair.
— 14. Tail, together with the last 2 segments of trunk, dorsal view.

Oncaea conifera, Giesbrecht.

- Fig. 15. Female and male in copula, viewed from left side.
— 16. Last segment of trunk, with the adjoining part of the genital segment, ventral face.
-

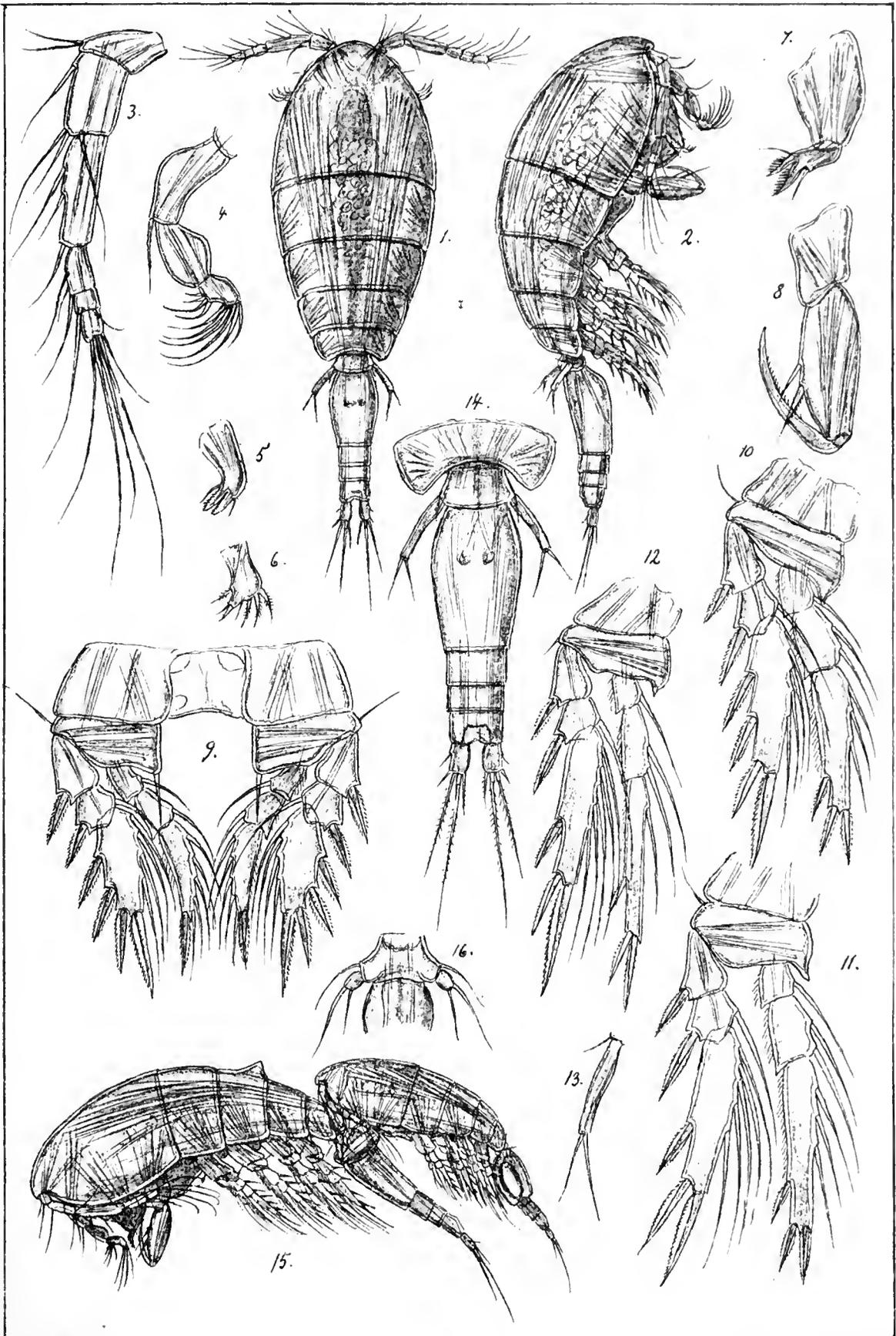

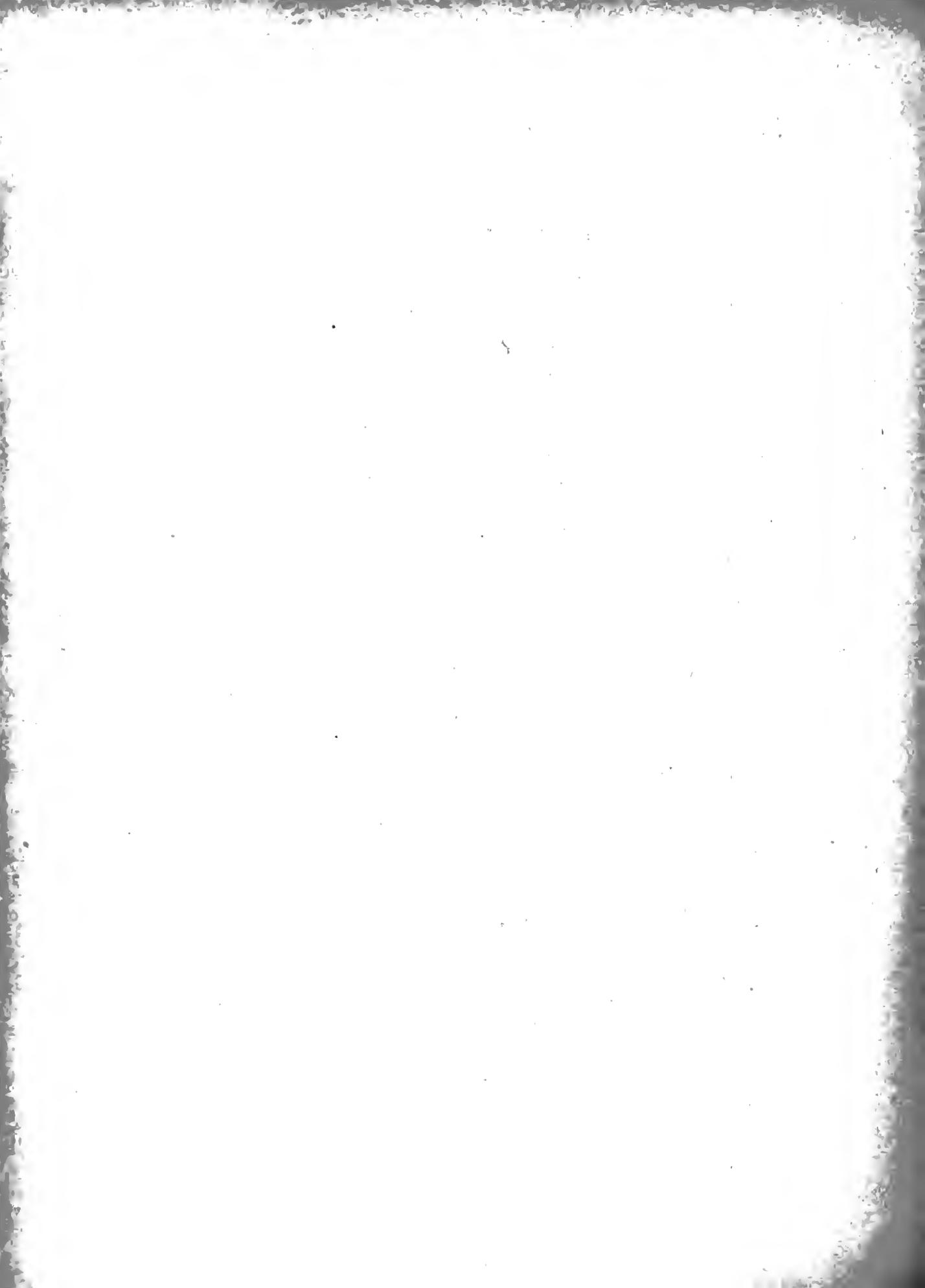
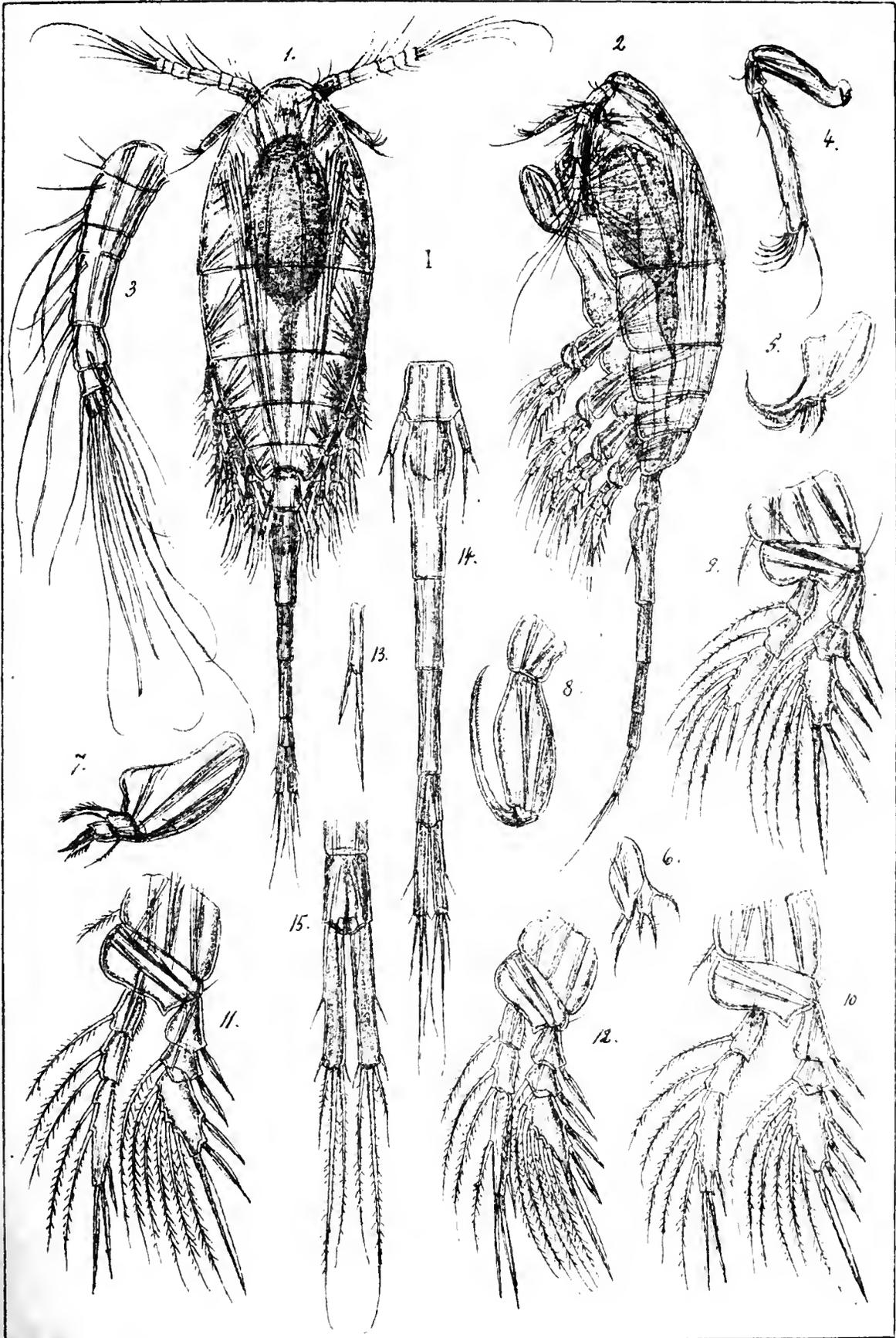

PLATE XXXIII.

PLATE XXXIII.

Lubbockia glacialis, G. O. Sars.

-
- Fig. 1. Adult female, dorsal view.
— 2. Same, viewed from left side.
— 3. Anterior antenna.
— 4. Posterior antenna.
— 5. Mandible.
— 6. Maxilla.
— 7. Anterior maxilliped.
— 8. Posterior maxilliped.
— 9. Natatory leg of 1st pair.
— 10. Do. of 2nd pair.
— 11. Do. of 3rd pair.
— 12. Do. of 4th pair.
— 13. Leg of last pair.
— 14. Tail, together with last segment of trunk, dorsal view.
-



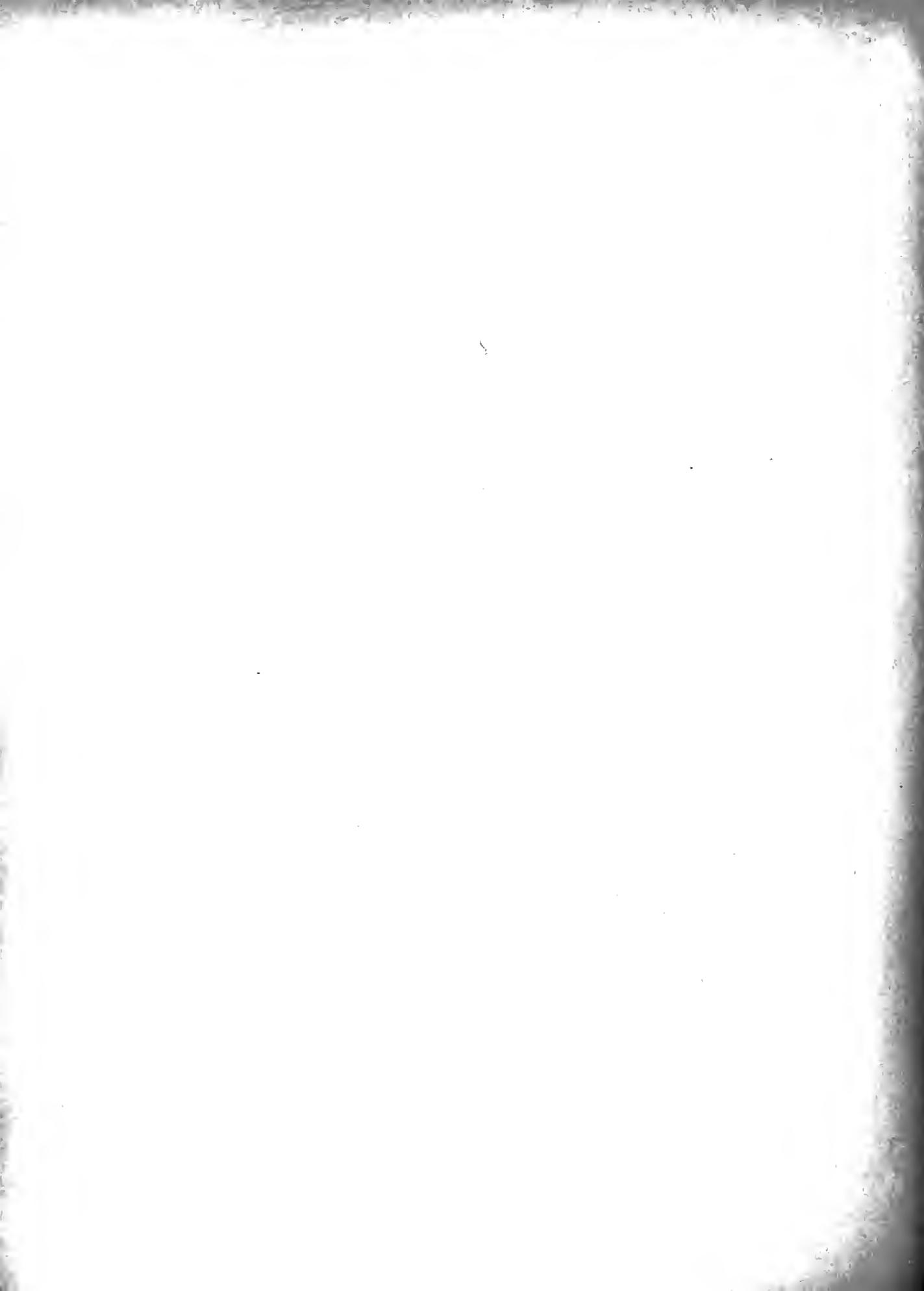
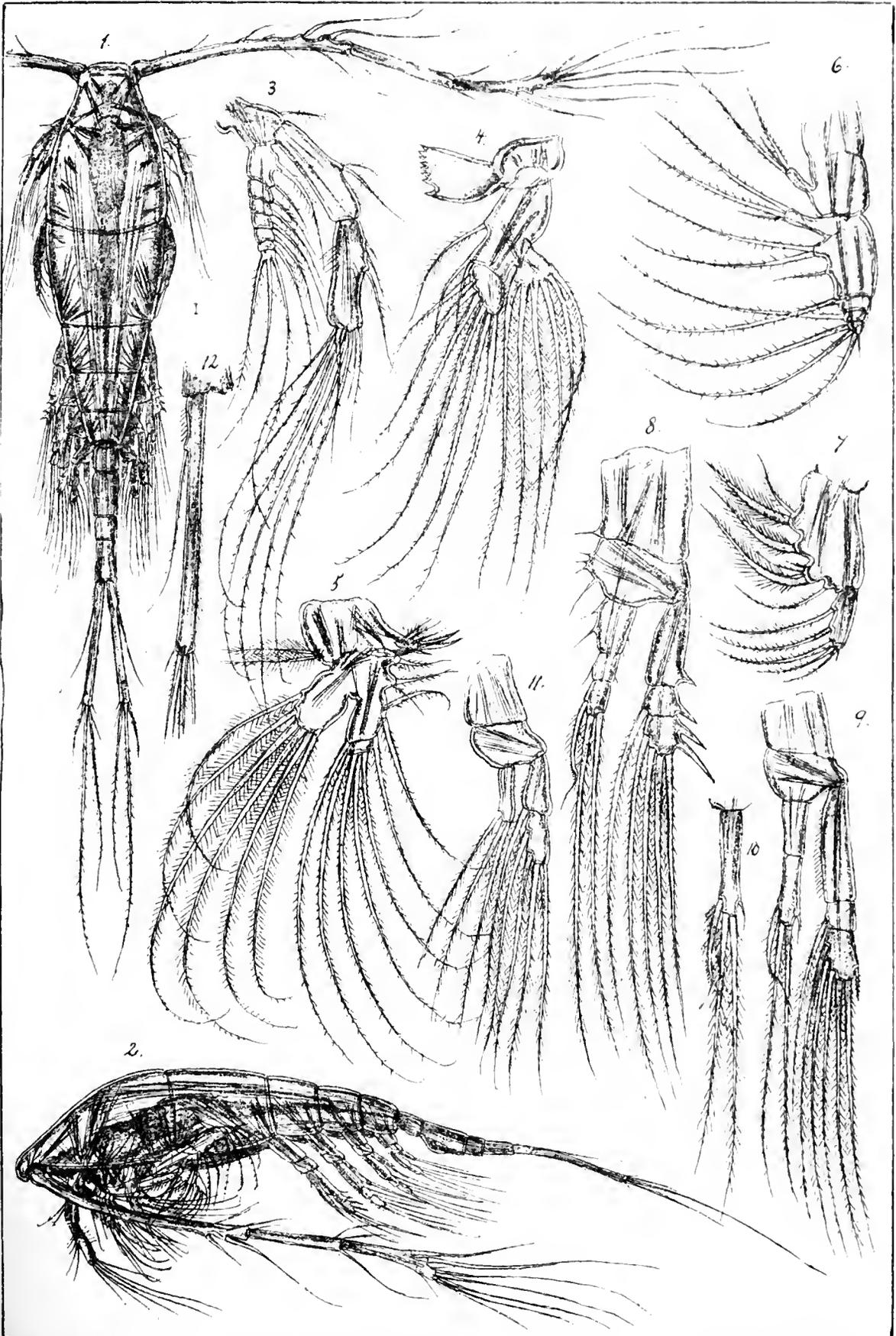

PLATE XXXIV.

PLATE XXXIV.

Mormonilla polaris, G. O. Sars.

- Fig. 1. Adult female, dorsal view (left anterior antenna not fully drawn).
- 2. Same, viewed from left side.
 - 3. Posterior antenna.
 - 4. Mandible with palp.
 - 5. Maxilla.
 - 6. Anterior maxilliped.
 - 7. Posterior maxilliped.
 - 8. Natatory leg of 1st pair.
 - 9. Do. of 2nd pair.
 - 10. Inner ramus of a leg of 3rd pair.
 - 11. Natatory leg of 4th pair.
 - 12. Caudal ramus.
-



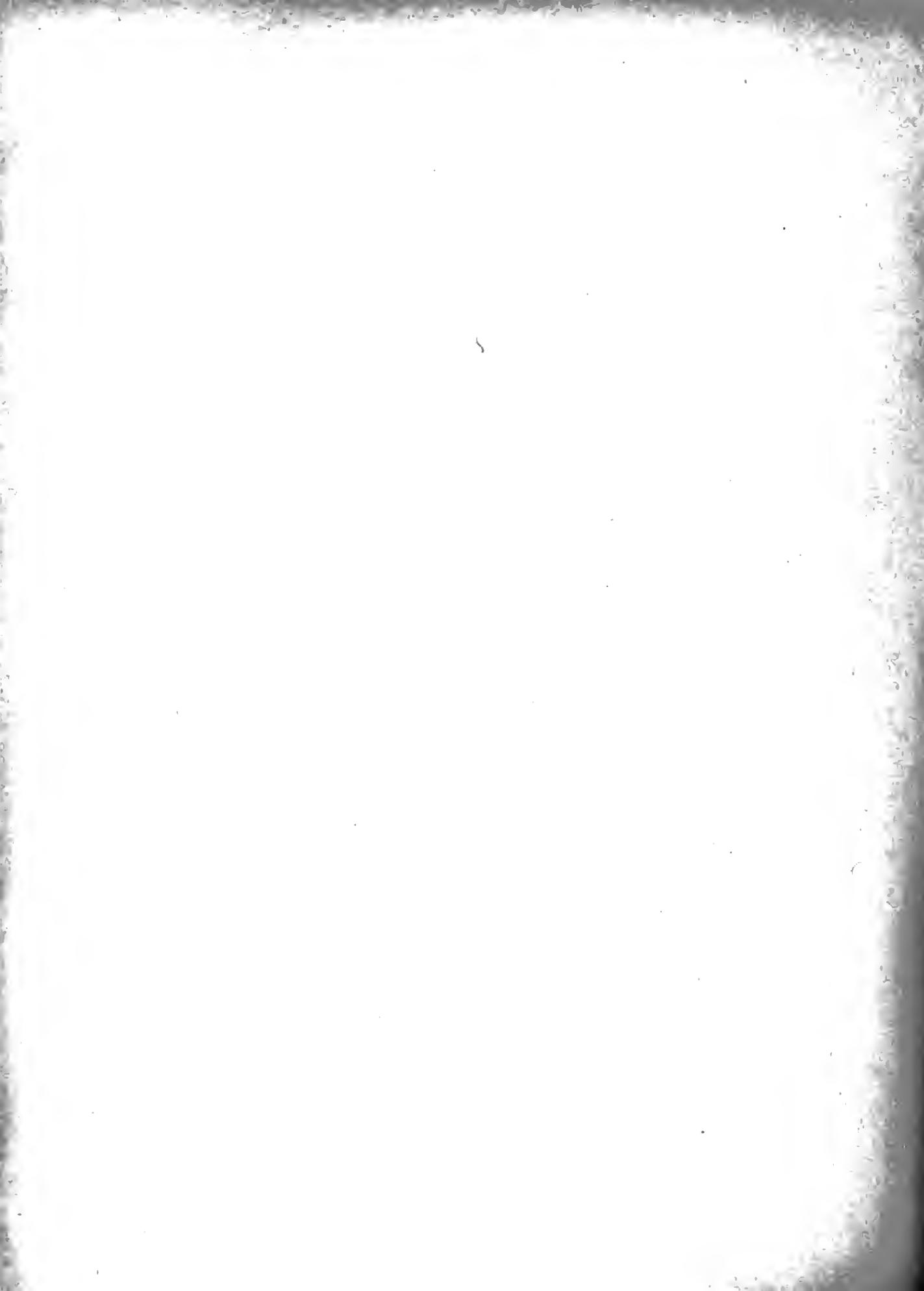
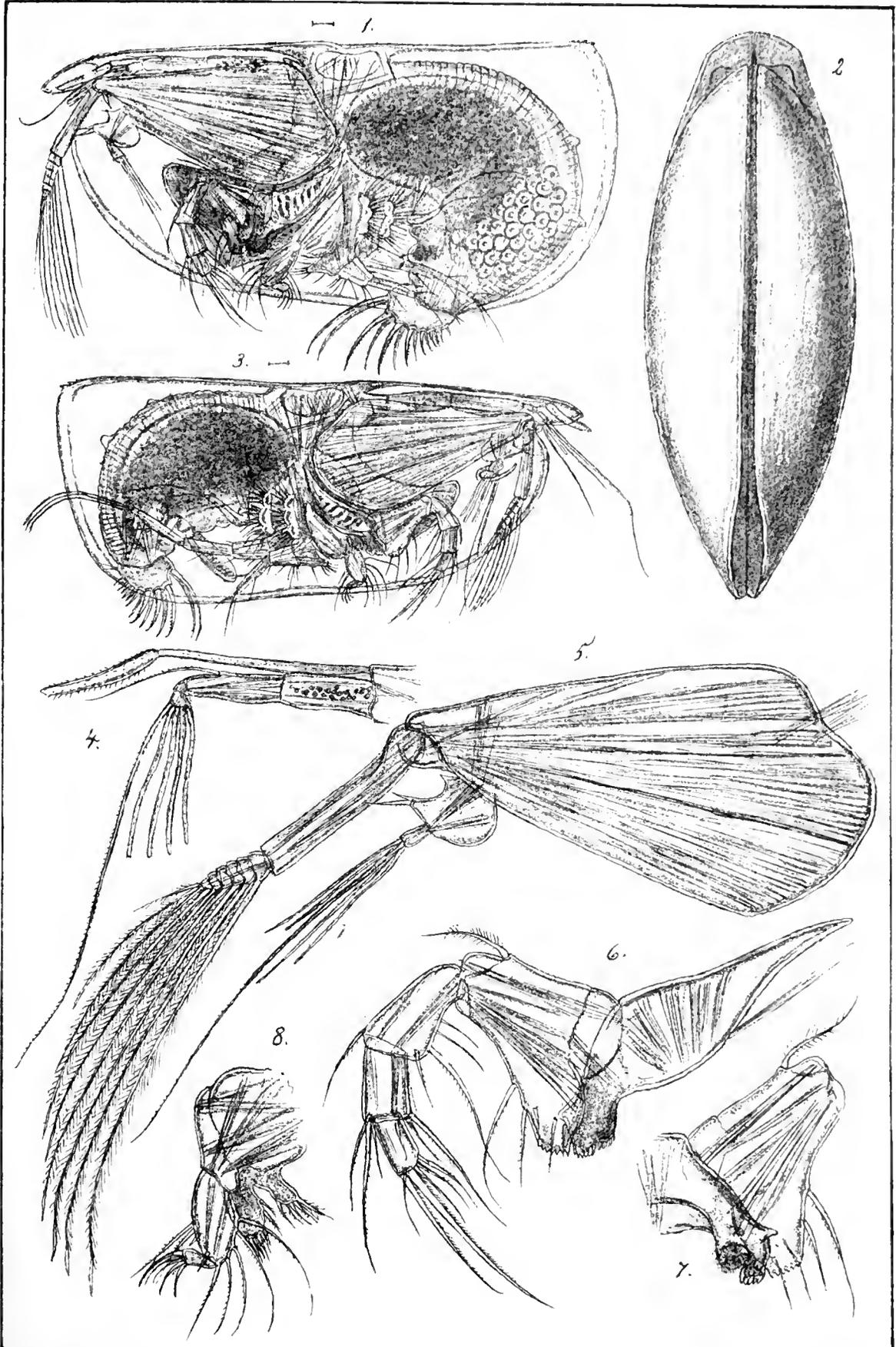

PLATE XXXV.

PLATE XXXV.

Conchoecia maxima, Brady & Norman.

- Fig. 1. Adult female, viewed from left side (left valve removed).
— 2. Shell of female, viewed from below.
— 3. Adult male, viewed from right side (right valve removed).
— 4. Antennula of female together with the frontal tentacle, lateral view.
— 5. Antenna of female.
— 6. Mandible with palp.
— 7. Same, masticatory part and basal joint of palp, viewed from the inner face.
— 8. Maxilla.
-



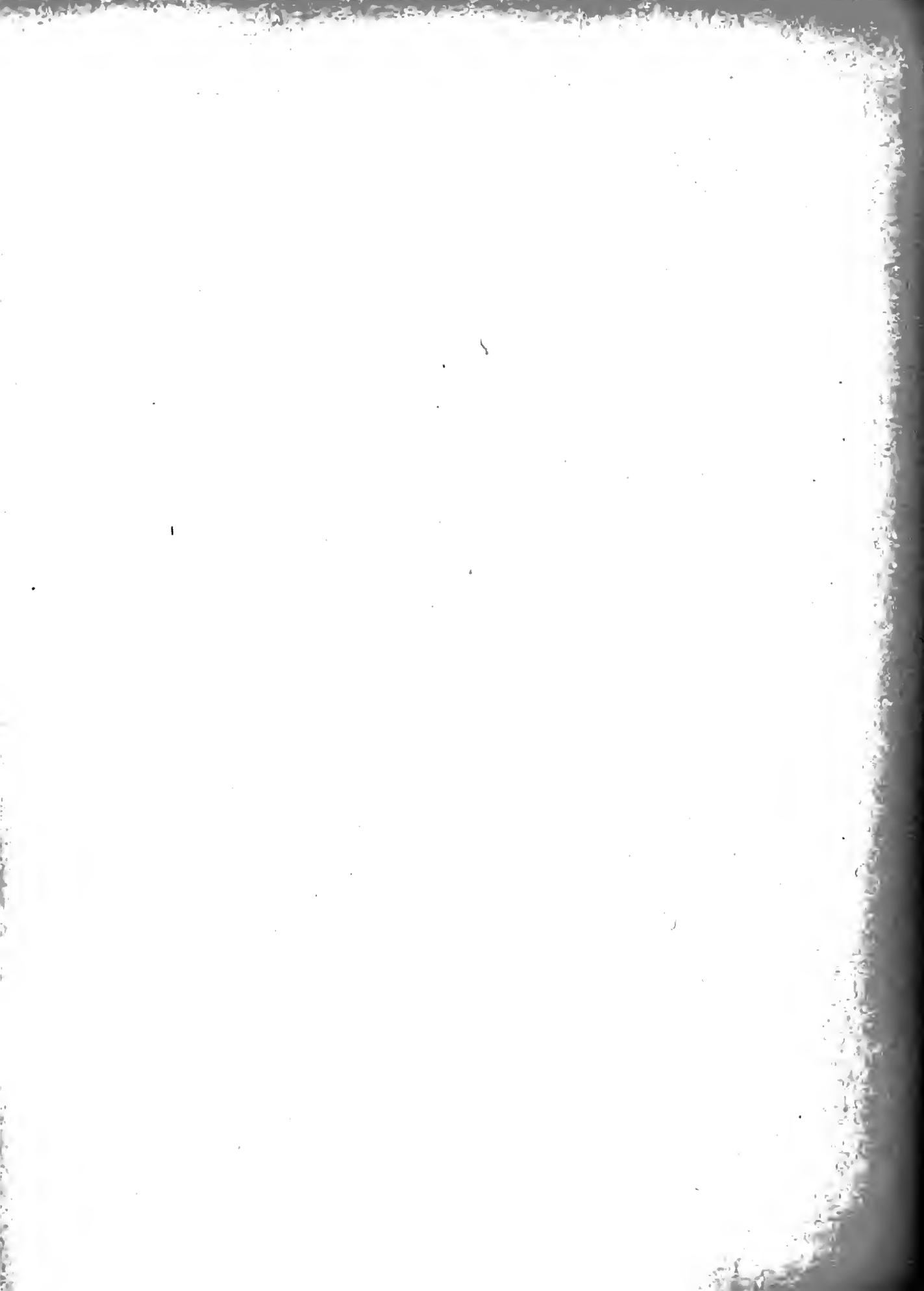
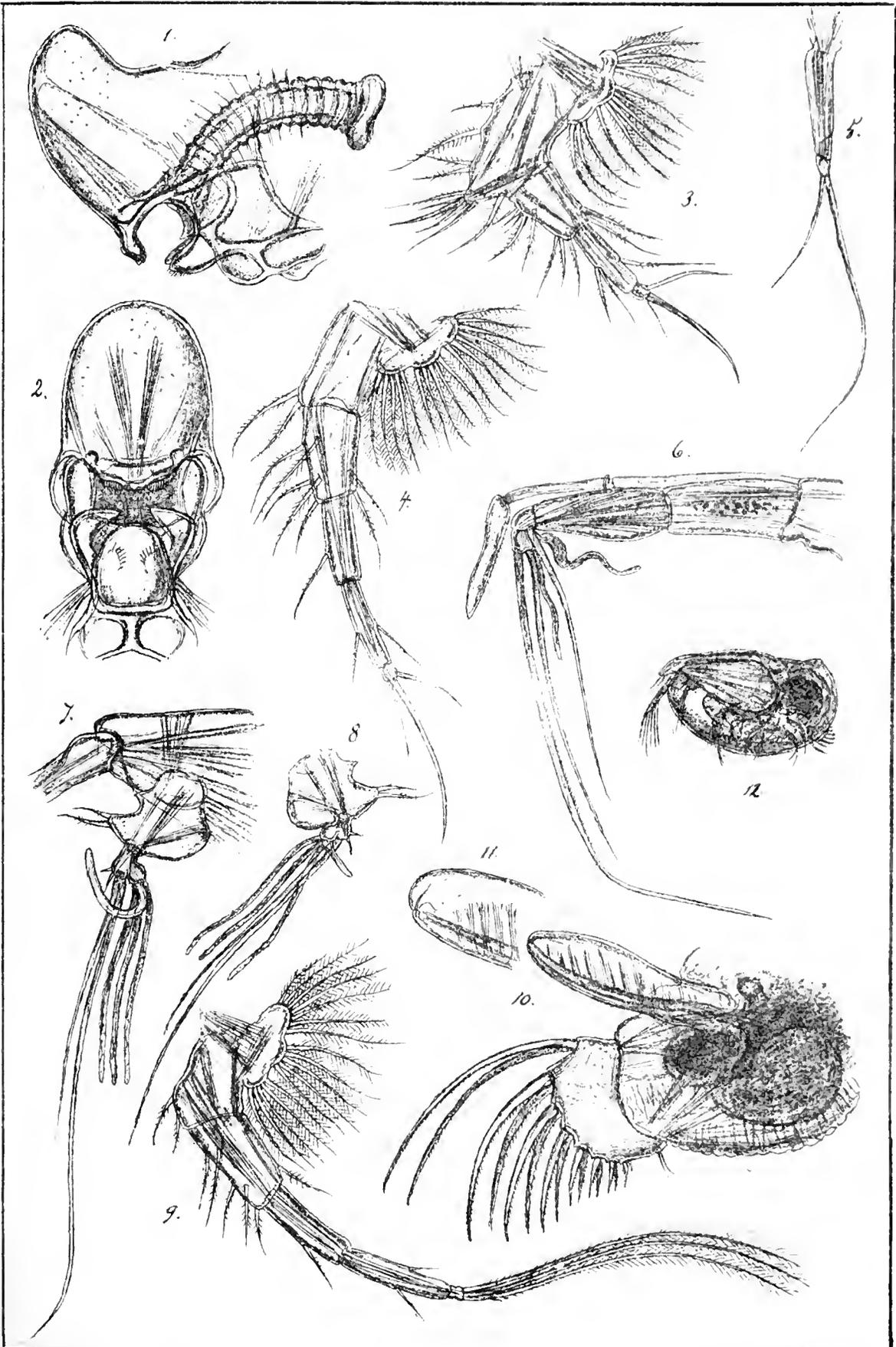

PLATE XXXVI.

PLATE XXXVI.

Conchoecia maxima, Brady & Norman,
(continued).

- Fig. 1. Anterior and posterior lips, with the adjoining parts of the chitinous skeleton and the œsophagus, viewed from left side.
- 2. Same parts, ventral view.
 - 3. Leg of 1st pair, with pertaining vibratory plate.
 - 4. Leg of 2nd pair.
 - 5. Leg of last pair.
 - 6. Antennula of male, together with the frontal tentacle, lateral view.
 - 7. End of basal part of right male antenna, with the prehensile accessory ramus.
 - 8. Left accessory ramus.
 - 9. Leg of 2nd pair of male.
 - 10. Posterior extremity of body of male, viewed from left side, showing the caudal plates and the single copulative organ.
 - 11. Distal part of the copulative organ.
 - 12. Very young specimen, viewed from left side.
-



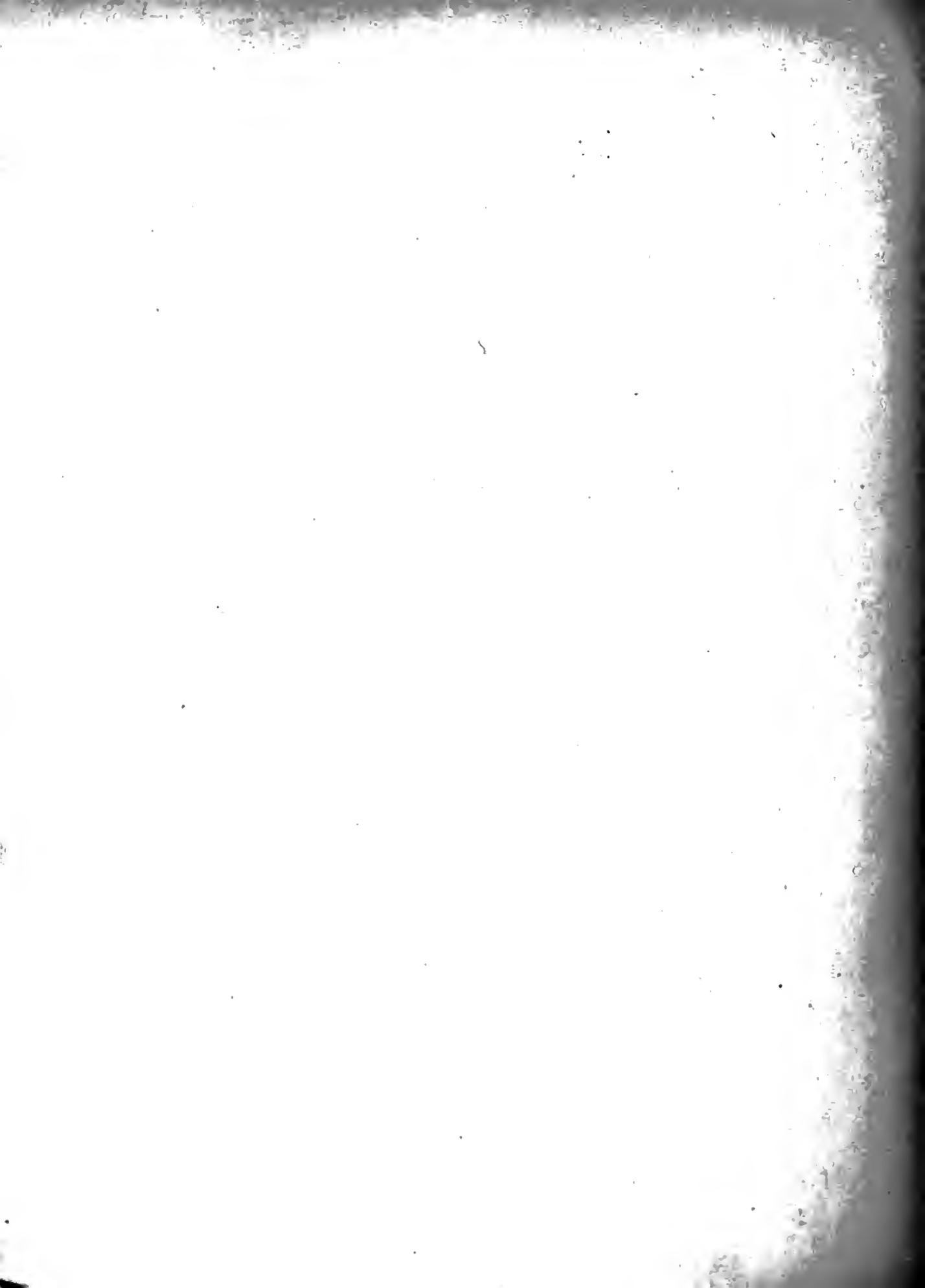

INDEX

OF SPECIES DESCRIBED IN VOL. I.

Names of new species are printed in fat-faced type.

	Number of Memoir.	Page.
<i>Abietites</i> (?) sp.	III	16
<i>Acartia longiremis</i> , (Lilljeb.)	V	106
<i>Aegialitis hiaticula</i> , (Lin.)	IV	45
<i>Alle alle</i> , (Lin.)	IV	23, 39, 53
<i>Amathilla pinguis</i> , (Krøyer)	V	34
<i>Amberleya</i> , sp.	II	68
<i>Amphithopsis glacialis</i> , Hansen.	V	33
<i>Anser segetum</i> , (Gmel.)	IV	9
<i>Archibuteo lagopus</i> , (Gmel.)	IV	6
<i>Arquatella maritima</i> , (Gmel.)	IV	8, 24
<i>Augetilus glacialis</i> , n. sp.	V	88
<i>Balanus</i> sp.	V	137
<i>Belemnites</i> , sp. (cf. <i>Beyrichi</i> , Opp.)	II	103
<i>Belemnites</i> , m. f. <i>subextensus</i> , Nik. — <i>Panderi</i> , d'Orb.	II	100
<i>Belemnites</i> , sp.	II	102
<i>Belemnites</i> , sp.	II	104
<i>Branta bernicla</i> , (Lin.)	IV	9, 25
<i>Cadoceras Frearsi</i> (d'Orb. sp.), Nik.	II	93
<i>Cadoceras Nanseni</i> , n. sp.	II	86
<i>Cadoceras</i> , sp. ex. aff., <i>Cad. Nanseni</i> (n. sp.)	II	92
<i>Cadoceras Tchefkini</i> , d'Orb. sp.	II	80
<i>Cadoceras</i> , sp.	II	94
<i>Calanus finmarchicus</i> , (Gunner.)	V	35
<i>Calanus hyperboreus</i> , Krøyer	V	35
<i>Carpolithes</i> , sp. a—e	III	20, 21

	Number of Memoir.	Page.
<i>Cepphus mandti</i> , (Licht.)	IV	13, 22, 36, 51
<i>Chiridius armatus</i> , (Boeck)	V	64
<i>Chiridius brevispinus</i> , n. sp.	V	68
<i>Chiridius tenuispinus</i> , n. sp.	V	67
<i>Cirripedia</i>	V	137
<i>Cladophlebis</i> , sp.	III	7
<i>Colymbus arcticus</i> , Lin.	IV	13
<i>Conchœcia maxima</i> , Brady & Norman	V	127
<i>Crymophilus fulvicarius</i>	IV	8, 45
<i>Cyclocaris Guilelmi</i> , Chevreux	V	20
<i>Czekanowskia</i> , cf. <i>rigida</i> , Heer	III	13
<i>Discina reflexa</i> , Sow. sp.	II	58
<i>Drepanopus Bungei</i> , G. O. Sars	V	78
<i>Euchoeta norvegica</i> , Boeck	V	58
<i>Eusirus cuspidatus</i> , Krøyer.	V	33
<i>Eusirus Holmi</i> , Hansen	V	33
<i>Euthemisto libellula</i> , (Mandt)	V	14
<i>Falco aesalon</i> , Tunst.	IV	6
<i>Feildenia</i> , sp.	III	15
<i>Fratercula arctica glacialis</i> , (Leach)	IV	52
<i>Fulmarus glacialis</i> , (Lin.)	IV	22, 35, 50
<i>Fungi</i> , gen. & sp.?	III	7
<i>Gammarus locusta</i> , Lin., var. <i>mutata</i> , Lilljeb.	V	34
<i>Ginkgo polaris</i> , Nathorst.	III	11
<i>Ginkgo polaris</i> , Nath., var. <i>pygmœa</i> , n. var.	III	12
<i>Ginkgo</i> , sp.	III	12
<i>Haploöps setosa</i> , Boeck	V	33
<i>Haploöps tubicola</i> , Lilljeb.	V	32
<i>Harelda glacialis</i> , (Lin.)	IV	9
<i>Hemicalanus spinifrons</i> , n. sp.	V	95
<i>Heterochæta compacta</i> , n. sp.	V	83
<i>Heterochæta norvegica</i> , Boeck	V	79
<i>Hymenodora glacialis</i> , Buchholtz	V	13
<i>Lagopus lagopus</i> , (Lin.)	IV	7
<i>Lanceola Clausi</i> , Bovallius	V	15
<i>Larus argentatus</i> , Gmel.	IV	11
<i>Larus fuscus</i> , Lin.	IV	11
<i>Larus glaucus</i> , Fabr.	IV	11, 20, 29, 46
<i>Larus marinus</i> , Lin.	IV	47
<i>Leda</i> , cf. <i>Nuda</i> , Keys. sp.	II	66
? <i>Limea</i> , cf. <i>duplicata</i> , Goldf.	II	65
<i>Lingula Beani</i> , Phill.	II	54
<i>Lubbockia glacialis</i> , n. sp.	V	114
<i>Macrocephalites Kættlitzii</i> , n. sp.	II	70
<i>Macrocephalites</i> , sp.	II	73

	Number of Memoir.	Page.
<i>Macrodon Schourovski</i> , F. Rouillier sp.	II	67
<i>Metopa longicornis</i> , Boeck	V	33
<i>Metridia longa</i> , Lubbock	V	99
<i>Mormonilla polaris</i> , n. sp.	V	120
<i>Nyctea scandiaca</i> , (Lin.)	IV	6
<i>Nyctiphanes norvegicus</i> , (M. Sars)	V	13
<i>Oithona helgolandica</i> , Claus	V	119
<i>Oncaea conifera</i> , Giesbrecht	V	113
<i>Oncaea notopus</i> , Giesbr.	V	107
<i>Pagophila eburnea</i> , (Phipps)	IV	12, 20, 30, 49
<i>Paramphithoë brevicornis</i> , G. O. Sars	V	32
<i>Parathemisto obliqua</i> , (Kröyer)	V	14
<i>Pecten Lindströmi</i> , Tullberg	II	63
<i>Pentacrinus</i> , sp. ex. aff. <i>bajociensis</i> (d'Orb.), P. de Loriol	II	51
<i>Phalaropus hyperboreus</i> , (Lin.)	IV	8
<i>Phoenicopsis</i> , cf. <i>angustifolia</i> , Heer.	III	14
<i>Pityanthus</i> , sp.	III	16
<i>Pityophyllum</i> , cf. <i>Lindströmi</i> , Nath.	III	20
<i>Pityophyllum</i> , cf. <i>Staratschini</i> , Heer sp.	III	19
<i>Pityospermum</i> , cf. <i>cuneatum</i> , Nathorst	III	18
<i>Pityospermum Nanseni</i> , n. sp.	III	18
<i>Pityospermum</i> , cf. <i>Maakianum</i> , Heer sp.	III	17
<i>Pityospermum</i> , sp.	III	19
<i>Pityostrobos</i> , sp. a—b	III	17
<i>Plectrophenax nivalis</i> , (Lin.)	IV	6, 14, 24, 44
<i>Podozamites</i> ? sp.	III	10
<i>Pseudalibrotus glacialis</i> , n. sp.	V	31
<i>Pseudalibrotus Nanseni</i> , n. sp.	V	26
<i>Pseudocalanus elongatus</i> , Boeck	V	69
<i>Pseudocalanus major</i> , n. sp.	V	69
<i>Pseudocalanus pygmaeus</i> , n. sp.	V	73
<i>Pseudomonotis Jacksoni</i> , n. sp.	II	60
<i>Pseudomonotis</i> , sp. (cf. <i>ornati</i> , Quenst. sp.)	II	62
<i>Pterophyllum</i> ? sp.	III	10
<i>Quenstedtoceras vertumnium</i> , Sintz	II	96
<i>Rhodostethia rosea</i> , (Macg.)	IV	15, 27, 48
<i>Rissa tridactyla</i> , (Lin.)	IV	10, 14, 25, 47
<i>Sabinea septemcarinata</i> , (Sab.)	V	13
<i>Scaphocalanus acrocephalus</i> , n. sp.	V	36
<i>Scina borealis</i> , G. O. Sars	V	19
<i>Scolecithrix brevicornis</i> , n. sp.	V	46
<i>Serpula flaccida</i> , Goldf.	II	53
<i>Somateria mollissima</i> , (Lin.)	IV	10, 25, 46
<i>Sphenopteris</i> , sp. a—d	III	8, 9
<i>Spinocalanus longicornis</i> , n. sp.	V	75

	Number of Memoir.	Page.
<i>Squatarola helvetica</i> , (Lin.)	IV	7
<i>Stercorarius crepidatus</i> , (Banks)	IV	12, 22, 33
<i>Stercorarius longicaudus</i> , (Vieill.)	IV	12, 35, 49
<i>Stercorarius pomatorhinus</i> , (Temm.)	IV	50
<i>Sterna macrura</i> , Naum.	IV	10, 25, 46
<i>Taxites</i> cf. <i>gramineus</i> , Heer, sp.	III	15
<i>Temorites brevis</i> , n. sp.	V	100
<i>Thysanoëssa longicaudata</i> , (Kröyer)	V	14
<i>Totanus nebularius</i> , (Gunn.)	IV	7
<i>Undeuchæta spectabilis</i> , n. sp.	V	59
<i>Undinella oblonga</i> , n. sp.	V	52
<i>Uria lomvia</i> , (Pall.)	IV	13, 37, 52
<i>Xanthocalanus borealis</i> , n. sp.	V	49
<i>Xema sabini</i> , (Sab.)	IV	48









Q "Fram" Expedition, 1st,
115 1893-1896
F7 The Norwegian North
v.1 Polar Expedition

P&A Sci.

PLEASE DO NOT REMOVE
CARDS OR SLIPS FROM THIS POCKET

UNIVERSITY OF TORONTO LIBRARY
