

Historic, archived document

Do not assume content reflects current scientific knowledge, policies, or practices.

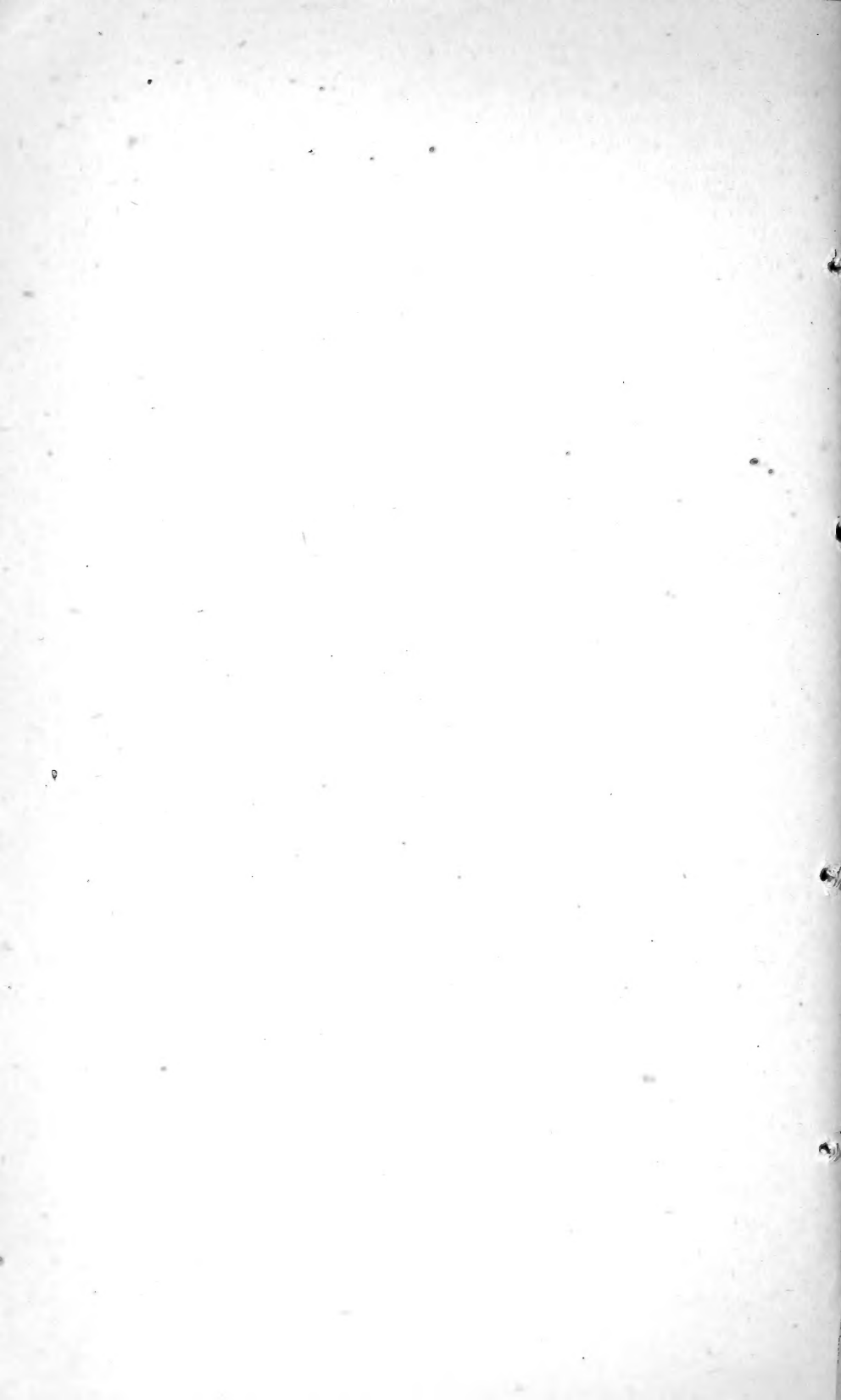

UNITED STATES DEPARTMENT OF AGRICULTURE

BULLETIN No. 780

Contribution from the Bureau of Entomology

L. O. HOWARD, Chief

Washington, D. C.

PROFESSIONAL PAPER

June 12, 1919

NOSEMA-DISEASE

By

G. F. WHITE, Specialist in Insect Diseases

CONTENTS

	Page		Page
Introduction	1	Resistance of Nosema apis to Putrefaction	35
Name of Disease	3	Resistance of Nosema apis to Direct Sunlight	37
Digestive Tract of Adult Bees	4	Period Nosema apis Remains Virulent	39
Cause of Nosema-Disease	7	Infectiousness of Brood-Combs from Nosema-Infected Colonies	43
A Three-Year Study of Nosema Infection in an Apiary	13	Resistance of Nosema apis to Carbolic Acid	44
Symptoms of Nosema-Disease	21	Effect of Drugs on Nosema-Disease	44
Methods Employed in Experimental Studies	22	Modes of Transmission of Nosema-Disease	46
Effect of Nosema Infection on the Colony and on the Apiary	23	Diagnosis of Nosema-Disease	48
Resistance of Nosema apis to Heating	29	Prognosis in Nosema-Disease	53
Resistance of Nosema apis to Drying	31	Summary and Conclusions	56
Resistance of Nosema apis to Fermentation	33	Literature Cited	58



WASHINGTON
GOVERNMENT PRINTING OFFICE

1919

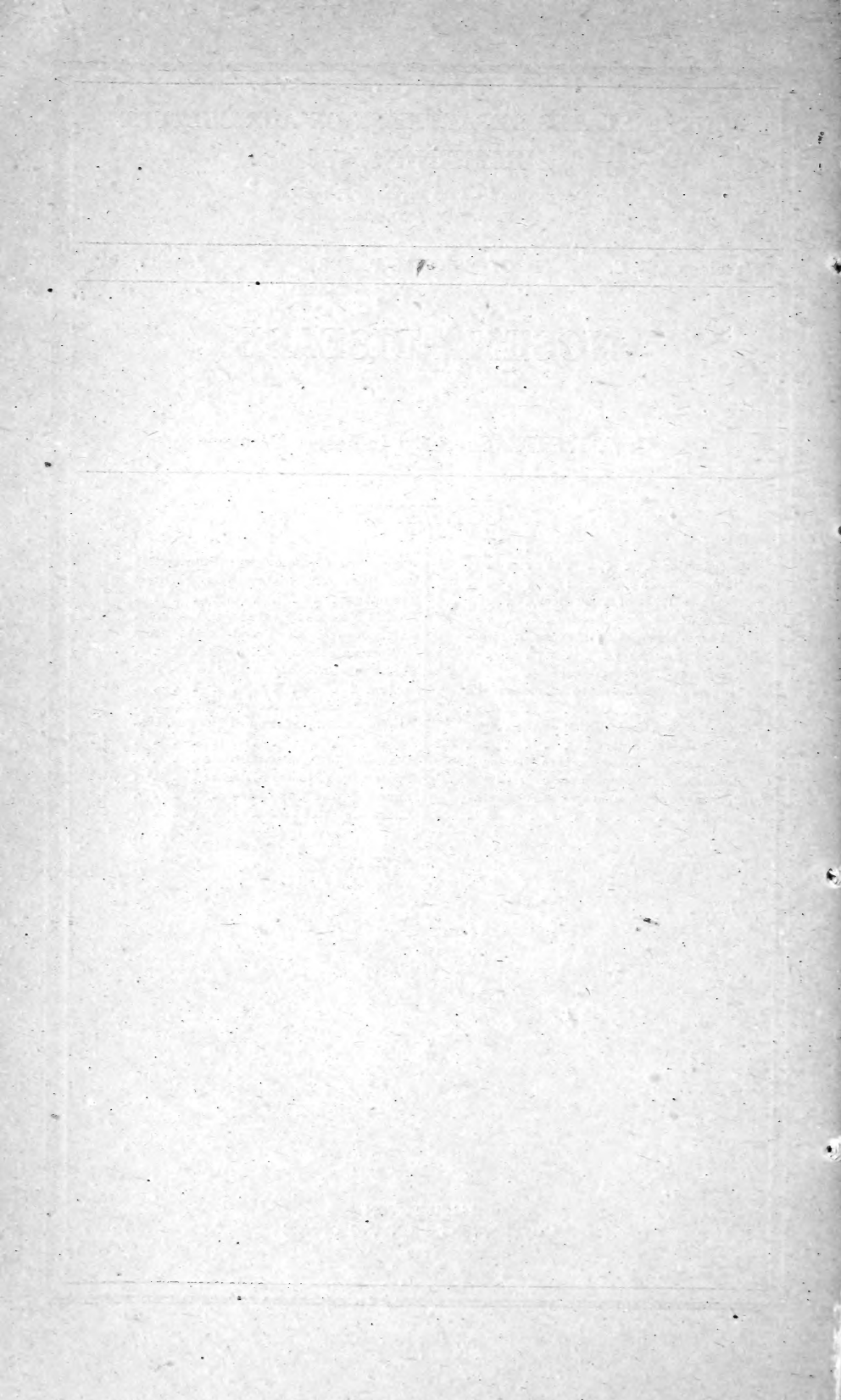



BULLETIN No. 780



Contribution from the Bureau of Entomology
L. O. HOWARD, Chief

Washington, D. C.

PROFESSIONAL PAPER

June 12, 1919

NOSEMA-DISEASE.

By G. F. WHITE,
Specialist in Insect Diseases.

CONTENTS.

	Page.		Page.
Introduction.....	1	Resistance of <i>Nosema apis</i> to putrefaction...	35
Name of disease.....	3	Resistance of <i>Nosema apis</i> to direct sunlight..	37
Digestive tract of adult bees.....	4	Period <i>Nosema apis</i> remains virulent.....	39
Cause of Nosema-disease.....	7	Infectiousness of brood-combs from Nosema- infected colonies.....	43
A three-year study of Nosema infection in an apiary.....	13	Resistance of <i>Nosema apis</i> to carbolic acid... ..	44
Symptoms of Nosema-disease.....	21	Effect of drugs on Nosema-disease.....	44
Methods employed in experimental studies..	22	Modes of transmission of Nosema-disease.....	46
Effect of Nosema infection on the colony and on the apiary.....	23	Diagnosis of Nosema-disease.....	48
Resistance of <i>Nosema apis</i> to heating.....	29	Prognosis in Nosema-disease.....	53
Resistance of <i>Nosema apis</i> to drying.....	31	Summary and conclusions.....	56
Resistance of <i>Nosema apis</i> to fermentation...	33	Literature cited.....	58

INTRODUCTION.

Nosema-disease is an infectious disease of adult honeybees. It causes the death of many individual bees, tending thereby to weaken the colonies infected. Many colonies die of the disease, but the percentage of deaths is comparatively small and entire apiaries are rarely, if ever, destroyed by it. It is not to be considered, therefore, as a particularly serious disorder. This is shown by the results recorded throughout the present paper. It is to be thought of rather as a disease the losses from which are less to the infected apiary than the losses from either of the foulbroods, although greater than those

from sacbrood. The disease is one, however, of considerable economic importance.

The fact that Nosema-disease is not a new disease deserves emphasis. The knowledge of the disease and its name only are of recent origin. Nosema-disease, like the brood diseases, has probably existed among bees longer than history records the keeping of bees by man. Since the disease is not a new one, fear regarding additional losses from it would not be justified. On the other hand, as we know of the disorder, we may entertain the hope that the losses due to it may now be lessened.

Until 1909 the existence of Nosema infection among bees was not generally known to beekeepers, although it had been studied somewhat by Dönhoff (1857) about a half century earlier. Zander began his studies a decade ago and since the appearance of his first paper (1909) a number of investigators have made studies on the disorder. In the papers which have been written concerning the infection, widely differing views regarding certain points have been expressed. To discuss these different views would be to go beyond the scope of the present bulletin.

The writer began the study of Nosema infection in 1910 following the demonstration by him that the disorder exists in the United States. In pursuing these investigations the object has been not to devise a treatment for the disease, but rather to ascertain such facts concerning the disorder that the beekeepers might be able to devise methods for its treatment with the assurance that they would be not only efficient but also economical. While there is yet much to be learned about the disease, this object has been fairly well attained. Relations which the results obtained bear to practical apiculture should be borne in mind, therefore, in reading the paper.

During the studies the effect of the disease on colonies and on apiaries, the transmission of the disease, the resistance of the infecting germ to heat, drying, sunlight, fermentation, putrefaction, and disinfectants, and the effect of drugs on the disease are among the problems which have been considered.

An earlier paper (White, 1914) refers briefly to the nature of the results obtained from these studies. The present bulletin gives all the results obtained from them which are believed to be of direct practical value to the beekeeper or otherwise of particular interest to him. The nature of the bulletin is similar, therefore, to the one on sacbrood (White, 1917) recently published.¹

¹ As in the sacbrood paper, so in the present one, technical discussions have been purposely avoided. The semitechnical points which could not well be omitted are briefly explained in the sacbrood paper. Unless the reader is familiar with the nature of such investigations, the sacbrood bulletin will probably be found helpful in following the present one.

NAME OF DISEASE.

About 60 years ago Dönhoff (1857, March) discovered small oval bodies upon examining microscopically the stomachs from adult bees which he supposed had died of exposure. He sent some of the bees to Leuckart, who after an examination of them expressed the belief that the oval bodies were the spores of a fungus ("Pilz"). The disorder was referred to by Dönhoff (1857, August) by the term "Pilz-sucht" (fungous disease).

These observations apparently had been practically forgotten at the time Zander (1909) reported his studies on a disease of adult bees in which he found small oval bodies in the walls of stomachs taken from affected bees. These were in fact the parasites that cause the disease. To the germ Zander (1909) gave the name *Nosema apis* and for the disease he (1911) used the name "Nosema-seuche."

The disorder studied by Dönhoff and the one studied by Zander are almost without question one and the same condition. It will be noted that each of these men in referring to the disorder used a term containing a reference to the parasite considered by each, respectively, as being its cause. The term "Nosema-disease,"¹ which the writer (1914) has suggested as the common name² for the disease, is not a new one, it will be observed, but simply an English translation of the term "Nosema-seuche" used by Zander.

In Switzerland "Nosemakrankheit" (Nosema-disease) (Nussbauer, 1912; Angst, 1913) is the term commonly used in referring to the disease. In Denmark Bahr (1915) used the term "Nosema-sygdommen" (Nosema-disease).

The name "Nosema-disease" possesses certain features which commend it: (1) It is definite, as it can refer only to the disease caused by *Nosema apis*; (2) it suggests the nature of the disease by referring to its cause; (3) it is readily understood; and (4) it is not long.

Care should be observed that Nosema-disease is not confused with dysentery. Leuckart (1857, March) early raised the question regarding its relation to dysentery. The question was soon afterwards

¹ It will be observed that there are two parts to the name and that the name of the disorder is not "Nosema," but "Nosema-disease." It is suggested, therefore, that the name be written, for the present at least, as a compound word. By so doing the difficulty which has been experienced by some will be avoided.

² While working on a disorder which had received the common name "Isle of Wight disease," Fantham and Porter (1911), in England, encountered a protozoan parasite belonging to the group Microsporidia which they identified as being *Nosema apis*. In selecting a technical name for the disorder caused by the parasite they chose the term "Microsporidiosis," derived, as will be observed, from the group name Microsporidia, under which the parasite is classified. The name is, therefore, an appropriate one. The term has received some criticism on account of its length and possibly on account of its not being readily understood.

As the parasite is now believed to belong to the genus "Nosema," the writer begs to suggest that as a technical name for the disorder the term "nosemosis" would have some arguments in its favor. This is not to be interpreted as proposing a substitute for the earlier term "Microsporidiosis." It is meant, rather, as an explanation of it.

taken up by Brotbeck (1857). Zander (1909) in his first paper referred to *Nosema* infection as a (malignant) dysentery. Other discussions have appeared from time to time in regard to such relationship (Maassen and Nithack, 1910; Beuhne, 1911; Maassen, 1911).

In fact the two disorders are very different and should be considered, for the present at least, as having no direct relation to each other. As both conditions are widely distributed and occur most frequently in the spring of the year, it is to be expected that not infrequently both of them may be encountered together in the same colony.

Efforts have been made to determine the name by which *Nosema*-disease has been known to beekeepers in the past. In these studies it was found (p. 16) that the highest percentage of *Nosema*-infected bees occurred in weak colonies. Consequently in asking beekeepers for samples bees from weak colonies were requested. In response to the request made approximately 150 samples were received. Fully half of these contained *Nosema apis*. Nine representative beekeepers located in different sections of the country that sent *Nosema*-infected bees were asked concerning the name by which the colonies showing the weakened condition were known. Three replied spring dwindling; two, not spring dwindling; two, weak colonies; one, bad queen; and one, "Don't know." None suggested paralysis and none dysentery.

In reply to requests for bees from colonies showing spring dwindling 38 samples were received from 14 beekeepers located in different sections of the country. Out of the 38 samples 15 upon examination revealed the presence of *Nosema apis*. From these 15 samples 314 bees were examined, of which 70 were found to be *Nosema*-infected.

Samples have been received from five beekeepers who diagnosed the condition in the colonies from which the bees were taken as paralysis. *Nosema apis* was not found in any of them.

The facts indicate, it would seem, that beekeepers had not learned to recognize the disease produced by *Nosema apis* by any one name.

DIGESTIVE TRACT OF ADULT BEES.

In *Nosema* infection the parasite *Nosema apis* enters, infects, and leaves the bee by way of the digestive tract. It is well, therefore, to know something of the location, arrangement, appearance, and structure of the organs of the alimentary canal of the healthy adult bee in order that the disease when encountered may be recognized and more fully understood.

The following description is an abbreviation of a general survey of the alimentary tract by Snodgrass (1910). The part of the alimentary canal (fig. 1) immediately following the mouth forms an enlargement called the pharynx (*Phy*). Succeeding this is the oesophagus (*O*),

a slender tube traversing the entire thorax. In the anterior part of the abdomen the œsophagus expands into a large thin-walled sac which is known as the honey stomach (*HS*); next is the short neck-like portion, the proventriculus (*Pvent*); then comes the large U-shaped portion, the stomach or ventriculus (*Vent*), an organ with thick walls and many annular constrictions. Following the stomach is the short, narrow and coiled, small intestine (*SInt*) having a circle of about one hundred long, greatly coiled, blind, thread-like tubes opening into its anterior end. These tubes are the Malpighian tubules (*Mal*). Following the small intestine is the large intestine or rectum (*Rect*). When bees have been confined for some time this latter portion of the canal is found distended with material to be voided.

Since the stomach is always invaded by the parasite in Nosema-disease, and the Malpighian tubules occasionally are, a further description of the structure of these organs seems warranted.

The stomach (fig. 1, *Vent*) is a relatively thick-walled organ lying U-shaped within the abdomen. When removed and straight-

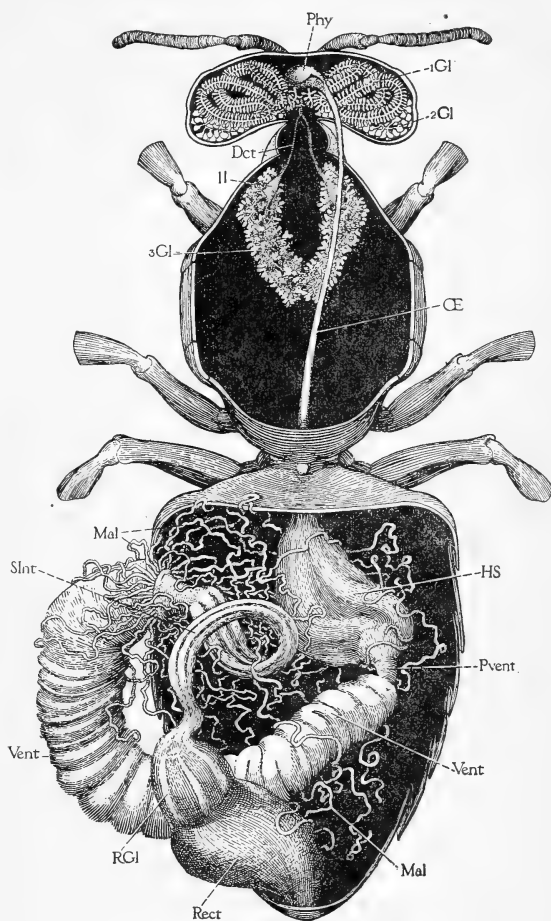

FIG. 1.—Alimentary canal of worker bee: Pharynx (*Phy*), œsophagus (*E*), honey stomach (*HS*), proventriculus (*Pvent*), stomach or ventriculus (*Vent*), small intestine (*SInt*), and large intestine or rectum (*Rect*), rectal glands (*RGI*), Malpighian tubules (*Mal*). Salivary glands of head (*1GI*) and thorax (*2GI*), and pharyngeal glands (*1GI*) are also shown. (Snodgrass.)

ened it is seen to be in general cylindrical but somewhat spindle-shaped in form. (Pl. I.) Circular constrictions present give to it a segmented appearance. The number and distinctness of these transverse markings vary somewhat. The size of the organ and its color vary also. The color varies within wide limits, being usually some shade of

brown. It may be quite light, approaching a yellow, or it may be dark, approaching the red observed in the flesh of the ox. Stomachs of the lighter shades especially are translucent.

The rather thick walls of the stomach (fig. 2) consist of an inner epithelial and an outer muscular portion. Between these is the

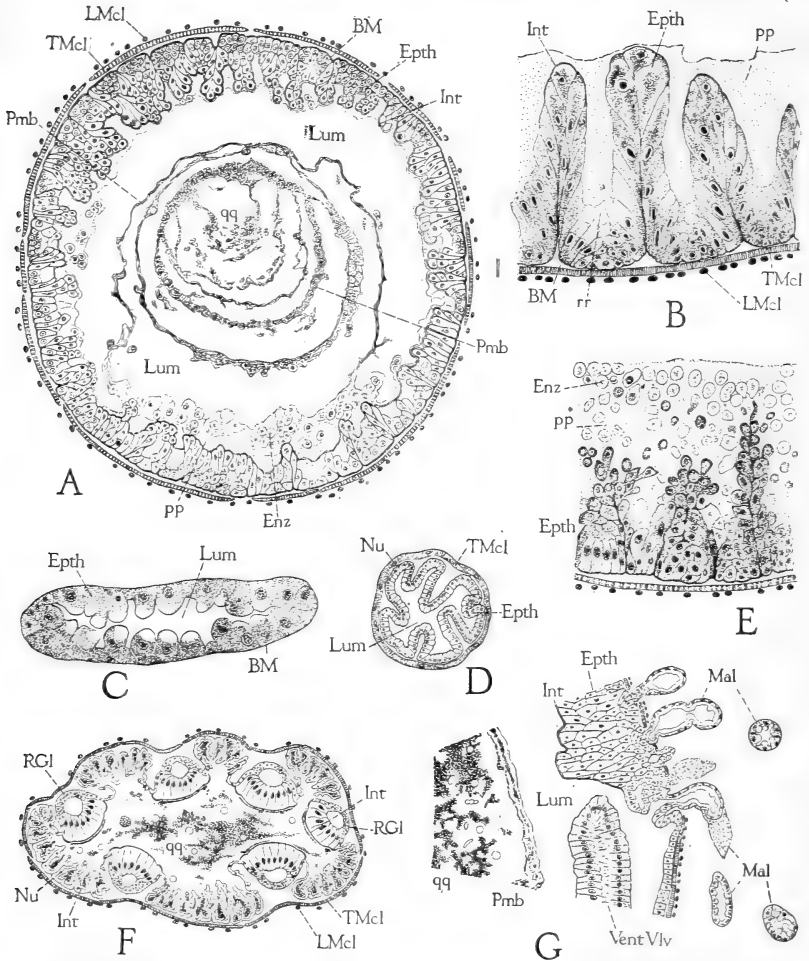

FIG. 2.—Microscopic anatomy of alimentary canal of worker bee: A, cross section of stomach showing peritrophic membranes (*Pmb*); B, wall of stomach, more highly magnified, showing epithelial layer (*Epth*), basement membrane (*BM*), and muscular portion; C, section of Malpighian tubule showing epithelium (*Epth*) and basement membrane (*BM*); D, cross section of small intestine. This portion of the canal, the rectum, and the cesophagus have a heavily chitinized intima. (Snodgrass.)

basement membrane. Both surfaces of the epithelial layer are irregular. This consists of epithelial cells (*Epth*) varying in size and outline. Closely associated with the outer surface of the epithelial layer is the basement membrane (*BM*). In connection with its inner surface is the more or less indefinite intima (*Int*) which possibly

bears some relation to the peritrophic membranes (*Pmb*). Outside the basement membrane is the muscular portion of the stomach wall consisting of three (White, 1918) muscular layers (Pl. II, D; and Pl. III, L). The outer and inner ones are made up of longitudinal and the middle one of circular fibers (fig. 3). Each layer is made up of a single layer of branched fibers.

Digestion and absorption, comparable to some extent to those obtaining in the human stomach, are functions which have been attributed to the stomach of the bee.

The Malpighian tubules (fig. 2, *G Mal*) empty into the alimentary tract at or very near the juncture of the stomach and small intestine. Microscopically their structure is seen to consist of a single layer of

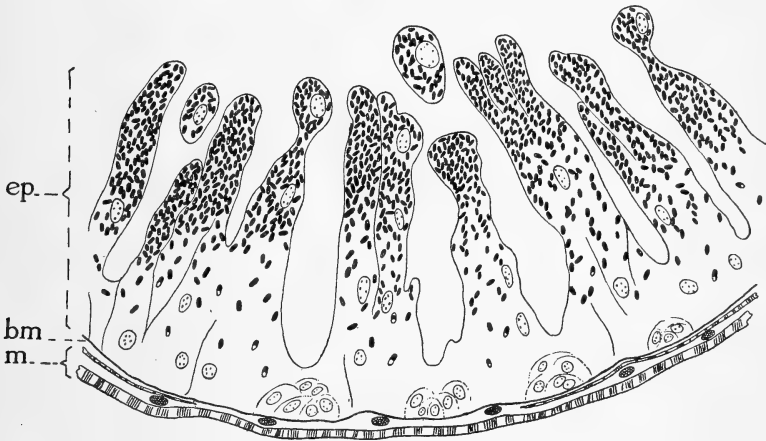

FIG. 3.—Longitudinal section of stomach of honeybee showing infection with *Nosema apis*: *ep*, Epithelial portion, containing the spores of the parasite stained black. (The younger parasites, not differentiated so easily by staining, are not shown; they are found toward the base of the cells reaching the basement membrane (*BM*), but do not extend beyond it. Younger spores sometimes show an unstained area at one end and occasionally at both ends.) *m*, muscular portion of stomach wall showing an outer and an inner longitudinal muscular layer and a middle circular one. (Author's illustration.)

epithelial cells (fig. 2, *C, Epth*) and a basement membrane (*BM*), but no pronounced intima. The function attributed to these tubules is one comparable in a measure to that of the kidneys of the vertebrates.

CAUSE OF NOSEMA-DISEASE.

THE EXCITING CAUSE.

On December 4, 1856, Dönhoff (1857, August) inoculated a colony of bees with the oval bodies he had found in the stomachs of adult bees. The inoculation was made by feeding the colony the crushed stomachs of the infected bees in a honey suspension diluted with water. Upon examining stomachs from adult bees taken from the inoculated colony in eight days following the inoculation no spores were observed. In 11 days, however, they were found to be teeming with the parasites. A second colony was then similarly fed on Decem-

ber 16. On the twenty-ninth of the same month all of the bees examined from the colony were found to be infected. The results of these experiments strongly indicated that the disorder in which the oval bodies were found was an infectious one and that the bodies were parasites which bore a causal relation to the disease. Other studies made by Dönhoff (1857, September) indicated that the parasite was quite prevalent in Germany but that there were colonies apparently free from infection.

About 50 years later Zander (1909) inoculated colonies experimentally by feeding material containing the oval bodies he had encountered in his studies. In bees from the colonies inoculated he demonstrated that the oval bodies were in the walls of the stomach. This fact showed still more conclusively that there was an infectious disease of adult bees in which the oval bodies were parasites bearing a causal relationship to the disease.

The oval bodies studied by Zander and those studied by Dönhoff in all probability are the same. To Zander, however, is due the credit for having determined their true nature. Together with Döflein he (1909) classified the germ as a protozoan (a one-celled animal parasite) belonging to the group Microsporidia and to the genus *Nosema*. Zander gave the name *Nosema apis* to the species he found in the honeybee.

The parasite *Nosema apis* grows and multiplies for the most part in the epithelium of the stomach (fig. 3; Pls. II and III) of the adult bee. Occasionally, but rarely, it is found within the epithelial cells of the Malpighian tubules (Pls. II and III). When *Nosema apis* is encountered in making an examination for the parasite it is the spore form (fig. 4; Pl. III, G, H) that is most often encountered and most readily recognized. Viewed microscopically the spore in unstained preparations is seen to be a small, refractile, more or less oval body varying somewhat in size but measuring about 2/10,000 of an inch in length and about 1/10,000 of an inch in width. Its width seems, however, to be slightly greater than one-half its length.¹ The spore is surrounded by a somewhat resistant coat which tends to maintain for it a constant form. It is not, however, a rigid structure, since, when studied in fresh preparations, it will be seen to bend to and fro as it is carried along by a current under the cover glass.

The manner in which a bee becomes infected with *Nosema apis* is in general as follows: Spores which have left the body of an infected bee with the excrement are ingested by the healthy adult bee. The environment within the stomach of the bee is favorable for the

¹ Measurements were made of spores in smears stained with iron hematoxylin and of others in preparations made by an India-ink method. In making the latter preparations thin smears of the spore containing material were made and allowed to dry, and over these smears a thin film of undiluted India ink was spread. The average length of the spores measured in the stained preparations was 4.15 μ and the average breadth 2.06 μ ; the average length in the India ink preparations was 4.46 μ and the average breadth 2.44 μ .

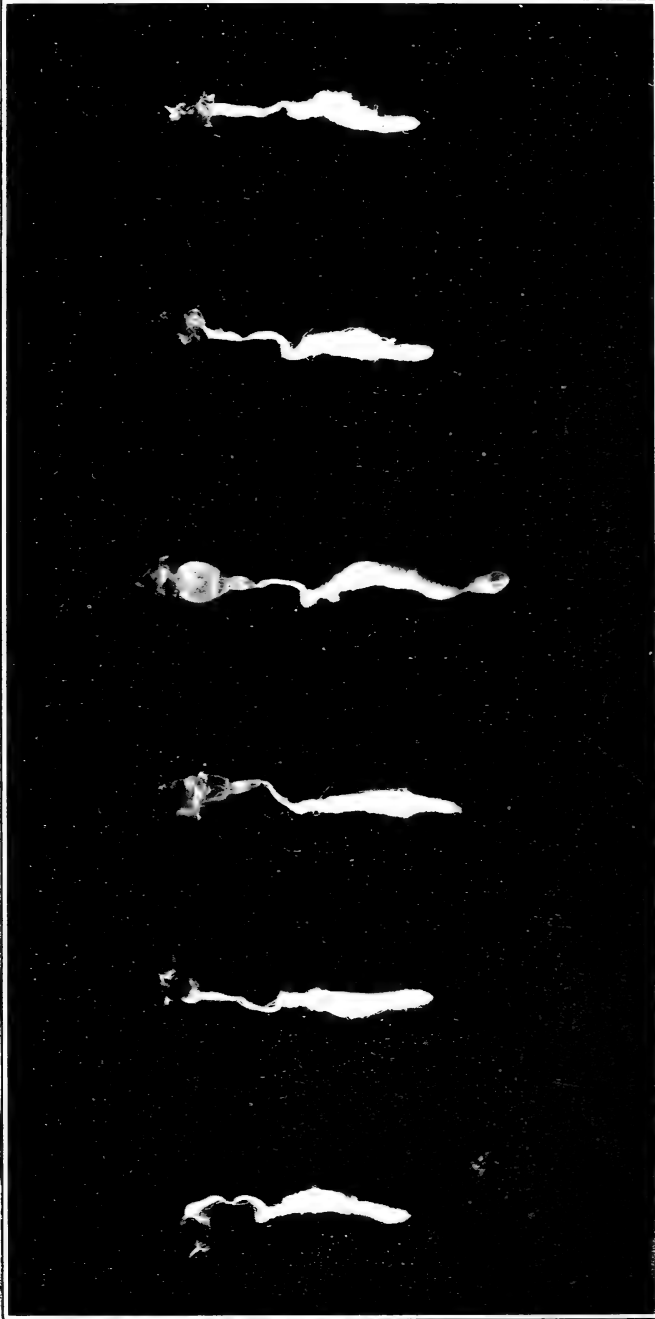

6

5

4

3

2

1

STOMACHS OF WORKER BEES REMOVED FOR EXAMINATION.

The tip of the abdomen, the large intestine, the small intestine, and, in one instance, the honey stomach also are shown. From left to right (1) a healthy stomach, (2) one recently *Nosema*-infected, (3) one infected for a longer period, and (4), (5), and (6) each respectively infected for a period longer than the one preceding it. (Original.)

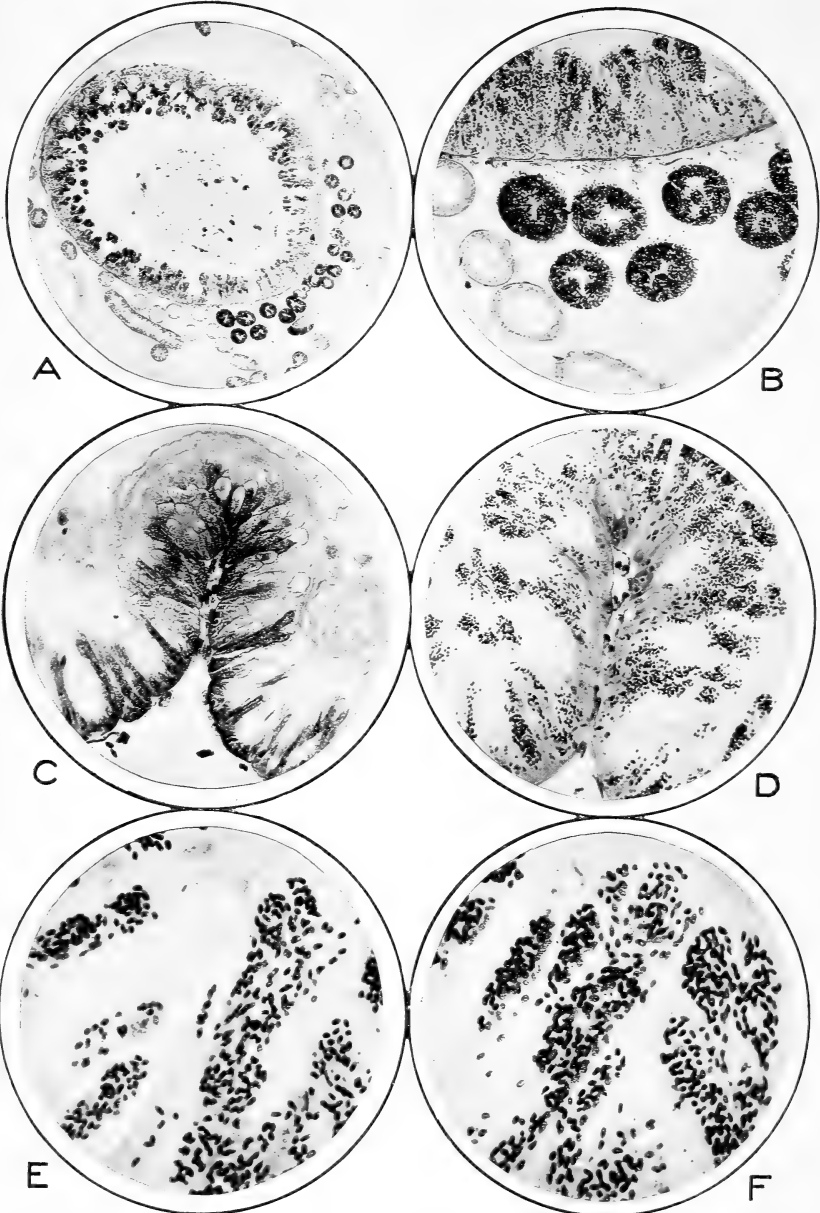

PHOTOGRAPHS OF SECTIONS OF THE STOMACH OF THE HONEYBEE AS SEEN THROUGH THE MICROSCOPE.

A, entire cross section of stomach (queen) and Malpighian tubules, showing infection of these organs with *Nosema apis*; B, a portion of A more highly magnified; C, a small portion of a longitudinal section of a stomach from a healthy bee; D, similar to C, but from a *Nosema*-infected bee; E, infected epithelium highly magnified, the disease as seen in America; F, similar to E, but from a preparation made by Zander in Germany. (Original.)

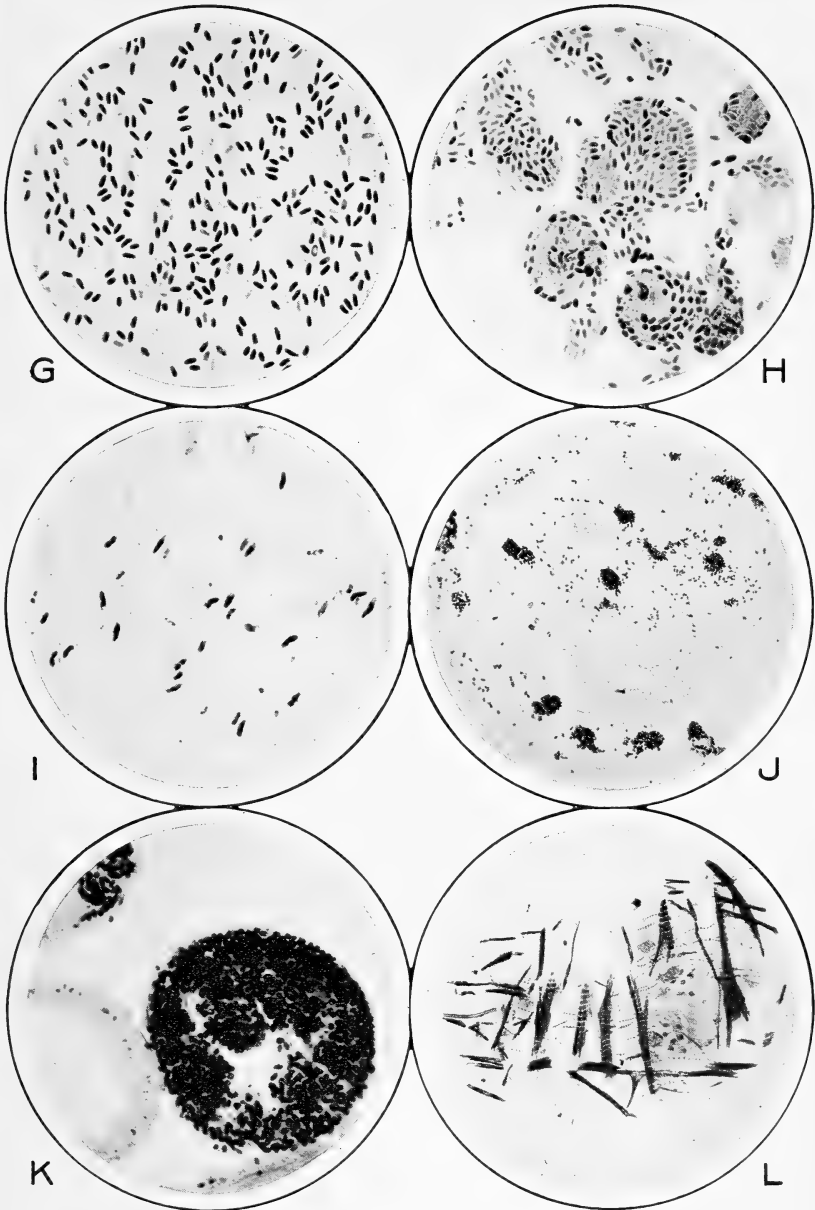

FURTHER STUDIES ON NOSEMA APIS AS REVEALED BY THE MICROSCOPE.

G, *Nosema apis* as seen in a stained smear preparation; *H*, a stained smear preparation showing within the groups how closely the cells are packed with parasites (note the nucleus of an epithelial cell below and to the right of the center); *I*, smear showing young forms (note the paired appearance); *J*, portions of epithelial cells are shed into the lumen of the stomach, carrying with them the contained parasites, accounting for the groups in this photograph; *K*, cross sections of Malpighian tubules highly magnified (the epithelial cells of the one to the left are not infected, some of those of the one above contain parasites, while all of those of the one to the right are heavily infected); *L*, tangential section of stomach wall showing the three muscular layers, the fiber of all of them being branched and striated. The inner and outer layers are made up of longitudinal fibers while the middle one consists of circular ones. (Original.)



growth and multiplication of the parasite. The digestive fluids are believed to assist in removing the spore coat. The liberated young parasite finds its way to the walls of the stomach and invades the epithelial cells. Within this epithelial tissue it grows and multiplies with great rapidity, giving rise finally to numerous spores. The cells of the epithelium at times seem to become virtually filled with the parasites (fig. 3; Pls. II and III). That portion of an epithelial cell that is normally shed into the lumen of the stomach in case of infection bears with it many spores. These are liberated gradually from the fragments, become mixed with the partially digested food of the stomach, and are carried onward first into the small and then into the large intestine and finally pass out of the alimentary tract with the excrement. Other bees ingesting these spores become infected. This in brief is the life cycle¹ through which the parasite passes.

Nosema apis reaches the tissues of the bee by way of the alimentary tract. In infecting the stomach the parasite reaches the basement membrane but does not penetrate it (Pls. II and III). The muscular part of the organ is therefore uninvolved (fig. 3). Likewise when the infection is found in the Malpighian tubules the germ does not proceed beyond the basement membrane (Pls. II and III). Furthermore the

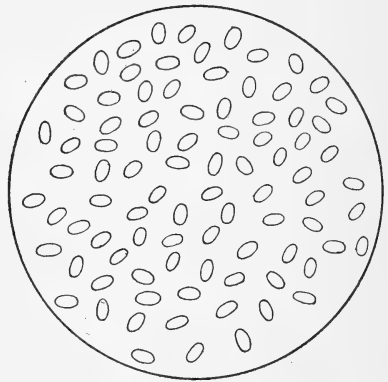

FIG. 4.—Spores of *Nosema apis* seen in a fresh preparation, indicating their general oval form. (Original.)

germ does not infect (fig. 1) the pharynx (*Phy*), the œsophagus (*Æ*), the honey sac (*HS*), the proventriculus (*Pvent*), the small intestine, or the large intestine (*Rect*)—organs which possess a pronounced chitinized intima. Infection with the parasite seems, therefore, to be confined to the epithelium of the stomach and of the Malpighian tubules. So far the writer has not encountered the germ in the blood, musculature, or any of the other tissues of the body.

Nosema apis has not been cultivated in pure cultures by artificial methods. The nature of the organism makes the accomplishment of such a task at the present time especially difficult. Direct proof obtained by the inoculation of bees with cultures of the parasite has not, therefore, been obtained. Fortunately such direct proof is not

¹ Fantham and Porter (1911 and 1912) encountered a parasite in bees taken from colonies affected with Isle of Wight disease which they have identified as *Nosema apis*. Their studies on the morphology of the parasite are interesting.

The morphology of *Nosema apis* and of *Nosema bombycis* are apparently quite similar and studies made by Stempell (1909) on the latter parasite may be referred to with profit in studying *Nosema apis*.

always necessary to establish the causal relationship between the germ and the disease.

Because of the absence of any of the higher animal parasites and of fungi in bees suffering from *Nosema*-disease these groups of parasites naturally can be eliminated as possible causal factors. Malden (1912, 1913) studied the bacteriology of *Nosema*-infected bees. He found that the number of bacteria in the diseased bees was much greater than in normal ones, the proportion being as 12 to 1. He found, however, no evidence of a direct etiological relation existing between these bacteria and the disease. Whether they play a secondary rôle is a question which admits of much discussion but one which is somewhat foreign to the present paper.

Some preliminary experiments were made by the writer in regard to the possibility of the presence of a filtrable virus in *Nosema*-disease. The results obtained indicate that no such virus is present.

By thus eliminating, at least tentatively, the higher animal parasites, the fungi, the bacteria, and the filtrable viruses—groups of parasites which cause diseases in animals—there remains another group, the protozoa. Of this group there is only one species, *Nosema apis*, that is constantly present in *Nosema*-disease. Other protozoa are occasionally encountered in adult bees, but when found are present usually in small numbers only. The conclusion is naturally reached, therefore, that *Nosema apis* is the cause of *Nosema*-disease. Such a conclusion is in harmony with views generally accepted at the present time in regard to proof necessary to establish the causal relation of such a germ to the disease.

PREDISPOSING CAUSES.

AGE.

Experimental inoculations have shown that in general adult bees of all ages are susceptible to *Nosema* infection. In nature it is found that the youngest bees are always free from infection and that the old shiny bees usually are. The absence of *Nosema apis* in the younger ones may be attributed simply to the fact that they have not yet been infected through the taking of food containing the germ. In the case of the shiny bees it seems probable that they have escaped infection, although it is possible that some of them might have been infected at one time and later recovered.

The brood does not seem to be at all susceptible to infection with *Nosema apis*. In heavily infected colonies the larvæ and pupæ apparently remain healthy. In these studies larvæ were inoculated more or less directly by means of a pipette and examinations¹ were made daily following the inoculation. The spores were found mixed with

¹ The examinations were made through fixing and sectioning inoculated larvæ.

the food within the stomach for from 1 to 3 days after the inoculation, but there was no evidence that the parasite had increased in numbers or that it had invaded the tissues.

SEX.

Nosema infection is encountered most frequently in workers, although drones and queens are susceptible. In nature it is not unusual to find from 10 to 20 per cent of the workers of diseased colonies infected. Frequently a much higher percentage is encountered. In no instance has the writer found Nosema infection in drones taken from colonies in which the disease occurred in nature. In a few instances only were the queens that were examined from such colonies found to be infected.

As a result of artificial inoculation practically 100 per cent of the workers of the experimental colony become infected. If drones are present a very large percentage of them also become infected.

Queens in experimental colonies may or may not be found infected. To obtain data relative to queens a number of inoculations were made. Table I summarizes the experiments together with the results obtained.

TABLE I.—*Nosema infection in queens in experimental colonies.*

Date of inoculation.	Period before examination.		Workers infected.	Results of inoculation.
	Days.	Per cent.		
Mar. 11, 1913.....	8	100		Queen not infected.
July 12, 1913.....	13	100		Do.
Do.....	16	100		Do.
Mar. 3, 1914.....	19	100		Do.
Oct. 5, 1914.....	22	40		Do.
Oct. 19, 1914.....	23	50		Do.
Oct. 29, 1914.....	48	100		Do.
Do.....	53	100		Do.
Feb. 4, 1915.....	23	-----		Queen Nosema infected.
Sept. 16, 1914.....	42	100		Do.
Nov. 20, 1912.....	48	100		Do.
Oct. 29, 1912.....	53	100		Do.
Aug. 6, 1914.....	162	100		Do.

It will be seen from the foregoing table that out of the 13 experimental colonies 9 of the queens upon examination were found to be free from infection while the other 5 were infected. Infection in the queen occurs less frequently, apparently, when the inoculations are made in the spring and summer than when made in the autumn or winter. Queens in colonies inoculated and kept at room temperature were found infected in some instances and not in others although practically 100 per cent of the workers in all of them became infected.

RACE.

In experiments recorded in the present paper the bees used have been largely hybrids, being for the most part grade Italians. Two each of tested Carniolans and Caucasians and a few common blacks have been among the colonies used. The bees were found to be susceptible to *Nosema* infection in all instances. It is not unlikely that future studies will show a difference among the races as to their relative immunity to the disease, but sufficient data are yet wanting to justify a definite statement in regard to the point.

CLIMATE.

Nosema infection has been reported from Australia (Price and Beuhne, 1910), Brazil (Zander, 1911), Canada (White, 1914), England (Fantham and Porter, 1911), Germany (Zander, 1909), and Switzerland (Nussbaumer, 1912). Studies have not yet been made in Denmark on the disease (Bahr, 1916). The writer (1914) has found it in samples of bees received from 27 different States of the United States. Out of 120 samples examined 40 contained the parasite. Samples showing infection were received from the coast plains and mountains of the East, from the plains of the Mississippi Valley, from the plateaus and plains of the West, and from the South and the North.

The infection was found in bees received from Florida and southern California, but in 15 samples received from Texas it was not found. The data thus far obtained indicate that less infection occurs in the southern portion of the United States than farther north. Whether it is found in the Tropics or in the coldest climate in which bees are kept is not yet known.

Laidlow (1911) reports that heavier infection was encountered in some parts of Australia than in others. Nussbaumer (1912) reported the infection from 14 of the cantons of Switzerland.

The practical import of these observations in connection with the climate, to the beekeepers of the United States at least, is that the presence of the disease in a region can not be attributed entirely to the climatic conditions present. It is possible, however, that the climate of a particular region may affect somewhat the occurrence and the course of the disease in that locality.

SEASON.

Infection in apiaries has been found to occur at all seasons of the year, but is greatest during the spring. In the studies reported in the present paper (p. 20) infection was greatest in April and May, being greater in these months than in March. Very little of a definite character is known of the infection as it occurs in nature during the winter. Experimentally it has been found that bees are susceptible to infection with *Nosema apis* at all seasons of the year.

FOOD.

As is pointed out under the heading "Climate," Nosema-disease occurs in a wide range of localities. The food and water obtained in these localities naturally differ as to quality and quantity. Infection is found in colonies having an abundance of stores and in others having a scarcity. The disease is produced readily by experimental inoculations in colonies with much and in colonies with little stores. From these observations the conclusion seems to be justified that the rôle played by food in the causation of Nosema-disease is slight, if indeed it contributes at all appreciably to it.

A THREE-YEAR STUDY OF NOSEMA INFECTION IN AN APIARY.

The presence of Nosema infection among bees in the apiary of the Bureau of Entomology was discovered in May, 1910 (White, 1914) In April, 1912, a more or less systematic study was begun on the prevalence and persistence of the infection in the apiary and was continued until June, 1915, As the apiary was being used for other purposes than these studies, it was not possible to follow all of the colonies throughout this entire period. In Table II are summarized observations made during the first year of the study.

TABLE II.—Results obtained from April, 1912, to March, 1913, inclusive, in a study of *Nosema infection in an apiary.*

Colony No.	1912														1913														
	April.		May.		June.		July.		August.		September.		Ex- per- iment No.1	October.					Decem- ber.										
	12	20	2	10	23	28	2	28	2	14	9	13		18	5	8	11	16	18	21	28	30	17	17	17	12	25		
	Per cent.																												
1	0e	2e	2e	2e	2e	1p	3p			0p	1p	14							0p	0e	0e	0e							
2											0p	1p	22						0p	0e	2e	0e							0e
3	3e	1e	3p	3p	2p	2p	2p				0p	22						0p	0e	0e	0e								0e
4	9e	D	D	D	D	D	D				1p	90						5p	S	8e	3f	M							0e
5	3e	3e	3e	3p	1p	1p	3p				1p	26						0p	6p	1p	3e	3e	M						0e
6																			0p	0e	0e	0e							0e
7											1e	8						4p	S	9e	7f	M							8f
8	0e	1e	1e	4p	4p	1p	R				1e	100						0p											D
9	0e	0e	0e	2p	2p	0p	2p					10						0p											0e
10	10e	10e	10e	D	D	D	D				1p	22						3p	0e	0e	0e							0e	
11	0e	2e	1e	1e	5p	4p					1p	22						10p	10p	10e	10e	10e						0e	
12	0e	1e	1e	1e	1e	1p						80							7p	0e	0e								0e
13	0e	1e	1e	1e	1e	1p						10							7p	0e	0e								0e
14	10e	10e	10e	D	D	D	D				1p	22						3p	0e	0e	0e							0e	
15	0e	2e	1e	1e	5p	4p						22						10p	10p	10e	10e	10e						0e	
16	0e	1e	1e	1e	1e	1p						80							7p	0e	0e								0e
17	8e	D	D	D	D	D	D												7p	0e	0e							0e	
18																			4p	4p	10p	S							0e
19																			4p	4p	10p	S							0e
20																			4p	4p	10p	S							0e
21																			4p	4p	10p	S							0e
22																			4p	4p	10p	S							0e
23																			4p	4p	10p	S							0e
24																			4p	4p	10p	S							0e
25																			4p	4p	10p	S							0e
26																			4p	4p	10p	S							0e
27																			4p	4p	10p	S							0e
28																			4p	4p	10p	S							0e
29																			4p	4p	10p	S							0e
30																			4p	4p	10p	S							0e
31																			4p	4p	10p	S							0e
32																			4p	4p	10p	S							0e
33																			4p	4p	10p	S							0e
34																			4p	4p	10p	S							0e
35																			4p	4p	10p	S							0e
36																			4p	4p	10p	S							0e
37																			4p	4p	10p	S							0e
38																			4p	4p	10p	S							0e
39																			4p	4p	10p	S							0e
40																			4p	4p	10p	S							0e
41																			4p	4p	10p	S							0e
42																			4p	4p	10p	S							0e
43																			4p	4p	10p	S							0e
44																			4p	4p	10p	S							0e
45																			4p	4p	10p	S							0e
46																			4p	4p	10p	S							0e
47																			4p	4p	10p	S							0e
48																			4p	4p	10p	S							0e
49																			4p	4p	10p	S							0e
50																			4p	4p	10p	S							0e
51																			4p	4p	10p	S							0e
52																			4p	4p	10p	S							0e
53																			4p	4p	10p	S							0e
54																			4p	4p	10p	S							0e
55																			4p	4p	10p	S							0e
56																			4p	4p	10p	S							0e

57.	D									50										
59.	1e	2p	0p							10						9p	1e			
60.	2e	3e	0e							15						8p				
63.	0e	1p	1e							5						1p				4f M 2e
65.	1p								7							10p				5f D 2e
66.	1p								8							7p	8p	W		5f D 2e
67.	1p								9							8p	M			0f W 0e
68.	3e	2p	1e							25										2e 6p 0e
69.																				4e 0e 0e
70.																				2f M 0e 2e
72.																				5p 1e 0e
73.	6e	0e	5h	5p						33										5p 1e 0e
75.	2e	2e																		0e 0e 0e
77.	2e	3e								20										5p 0e 0e
79.										12										1e

Explanation for Table II.—The number of Nosema-infected bees found in each sample of 10 bees examined is recorded. The colony from which the sample was taken is shown by its number in the first column. The results are given in columns headed by the approximate date on which the examinations were made. Approximate dates are used to abbreviate the table. As a rule they are within two days of the exact dates. The letter accompanying a number indicates the source from which a sample was taken; the letter “e” showing that the sample was taken from among the bees about the entrance of the hive; “p,” that the bees examined were carrying pollen primarily when taken; “h,” that they were carrying honey or water; and “f,” that they were taken from the brood frames. The letter “D” shows that the colony was dead; “R,” that it was removed; “S” indicates that the colony was relatively strong; “M,” that it was medium in strength; and “W,” that it was relatively weak.

From Table II it will be noted that in April there were 24 colonies in the apiary. Out of 240 bees examined from them during the month, 72 (30 per cent) were *Nosema* infected. The number of bees out of each sample of 10 was found to vary from 0 to 10.

During May, out of 410 bees examined 96 (23 per cent) were found to be *Nosema* infected.¹

During June, out of 130 bees taken from 13 colonies 19 (15 per cent) were found to be *Nosema* infected.

During July, out of 130 bees examined 21 (16 per cent) were found infected.

During September, out of 170 bees examined 14 (8 per cent) proved to be *Nosema* infected.

Out of a total of 1,140 bees examined in 1912, from April to September, inclusive, 236 (20 per cent) *Nosema* infected bees were found. The number of infected bees found in the different colonies varied from 5 to 100 per cent.²

Five of the 24 colonies died. These were dead by the end of May. It was found that the number of infected bees present in them varied from 50 to 100 per cent. The number of infected bees in the colonies that lived varied from 5 to 33 per cent.

All of the colonies that died were weak when first examined in the spring and dwindled until they disappeared. The colonies that lived gained in strength and behaved as healthy ones.

The colonies that died had sufficient stores. The queen in each of them was apparently in good condition and brood was being reared. At times, indeed, the brood was in excess of the amount that could properly be cared for by the diminishing number of bees present. These and other facts which have been observed justify the belief that the immediate cause of death in each of the five colonies that died was the *Nosema* infection that was present. These colonies, therefore, may be said to have died of *Nosema*-disease.

The number of colonies in the spring was increased during the bee season through swarming and by division.

In September an experiment was begun in the apiary in which 10 colonies were inoculated with *Nosema apis*. The results of these inoculations will be referred to later under experiment No. 1 (p. 23).

Examinations were made in 1913 for the prevalence and persistence of *Nosema* infection in the apiary studied in 1912. Naturally the colonies present were not altogether the same as those of the previous year. Some of them had been lost and some represented the increase. The results obtained are summarized in Table III.

¹ Fractions are omitted in this paper, as a rule.

² As the younger bees and the older ones were avoided in selecting samples for examination, the results recorded in this paper show a higher percentage of *Nosema*-infected bees in the colonies than actually existed.

TABLE III.—Results obtained in 1913 from a study of *Nosema* infection in an apiary.¹

Colony No.	Ex- per- iment No. 1.	March.		May.	June.			July.				Ex- per- iment No. 2.	August.		Sep- tem- ber.	October.			Per cent.	
		12.	25.	29.	3.	18.	14.	16.	19.	22.	9.		25.	23.	13.	18.	28.			
1			0 ^e																	
2			0 ^e			1 ^e		0 ^p					0 ^e							2
5			0 ^e			1 ^p		0 ^p							1 ^p					5
7			0 ^e			1 ^p									2 ^p					10
8			0 ^e			0 ^e		1 ^e												3
12		2	4 ^f	8 ^f	D															60
26			0 ^e			0 ^e							0 ^e	2 ^e						5
30			1 ^e		R															
31			1 ^e		R															
35		4	6 ^e		0 ^p	3 ^h		1 ^e		1 ^e			0 ^e	0 ^e						16
36			1 ^e			0 ^p	3 ^e					A			6 ^p			0 ^e		20
48			1 ^e			0 ^p		0 ^e					1 ^e		1 ^p					6
49			1 ^e			0 ^e		0 ^e		0 ^e			1 ^e		2 ^p					8
50			0 ^e			0 ^e		1 ^e				B	0 ^e		2 ^p		1 ^e			7
55		6	0 ^e		3 ^f															
61												C	0 ^e		9 ^p			0 ^e		30
65		7	2 ^e		0 ^e	0 ^p	0 ^p	1 ^e					1 ^e	0 ^e						6
66						1 ^p		1 ^e				D			2 ^p			0 ^e		12
67		8	0 ^e		0 ^e	0 ^e		0 ^e		2 ^h			1 ^e	0 ^e						4
68			0 ^e			0 ^p	3 ^e					E	0 ^e		3 ^p	0 ^e				10
69			0 ^e			0 ^p	0 ^p	1 ^e							1 ^p					5
70		10	0 ^e	2 ^e	4 ^e	0 ^p	0 ^e			1 ^e			1 ^e							11
72			0 ^e			1 ^e	0 ^e			5 ^h			0 ^e	0 ^e						10
73			0 ^e			0 ^e	0 ^e								0 ^p					0
75			0 ^e			0 ^e	0 ^e													0
79			1 ^e			0 ^e		1 ^e					1 ^e		0 ^e					6
81			0 ^e																	
82												F	0 ^e		1 ^p			0 ^e		3
a.						0 ^p		0 ^e					1 ^e	0 ^e						6
b.						0 ^p		0 ^e							3 ^p					10
c.														0 ^e						
d.														0 ^e						20
e.							1 ^e							0 ^e		4 ^e				25

¹ Where the number of bees examined is small, the rate indicating the percentage frequently is not given.

Explanation for Table III.—The method of recording results is the same as in Table II. Colonies examined in 1913 that were examined in 1912 bear the same numbers in Table III as in Table II. Colonies representing the increase in the spring are designated by the letters "a" to "e," inclusive. Colonies in experiment No. 1 are indicated by numbers; colonies in experiment No. 2, by capital letters.

From Table III it will be observed that in March, 1913, out of 270 bees examined from the 25 colonies then in the apiary 28 (10 per cent) were found to be *Nosema* infected.

During June bees were examined from 21 colonies, and out of 220 bees 8 (4 per cent) were found to be infected.

During July 21 colonies were examined and out of 260 bees 23 (9 per cent) were found to be infected.

During August bees from 18 colonies were examined and out of 240 bees 11 (5 per cent) were found to be infected.

During September, out of 170 bees from 17 colonies 43 (25 per cent) were found to be infected.

During October bees were examined from 6 colonies only, and out of 60 bees 1 (2 per cent) was found to be infected.

Out of a total of 1,270 bees examined during the year 1913, 121 (10 per cent) were infected, being less than the percentage found in 1912, which was 20 per cent. The spring infection was very much less in 1913 than in 1912.

The percentage of infected bees found during the spring and summer remained quite constant, increasing unexpectedly in September. The reason for the increase can not be assigned at present.

Out of the 25 colonies in the apiary in March, 1913, 1 (No. 12) died. As this colony contained a high percentage of *Nosema*-infected bees, and as it dwindled until it disappeared, it may be assumed that *Nosema*-disease was the immediate cause of its death. As in the preceding year all of the colonies that lived behaved much as do uninfected ones.

In this year another experiment was begun in the apiary. This one is described as experiment No. 2 (p. 25).

Studies similar to these made in 1912 and 1913 were continued throughout 1914 and until June, 1915. While in the main the colonies of the apiary were those of the previous years, naturally there had been some changes. The results obtained are summarized in Table IV.

TABLE IV.—Results obtained from May, 1914, to June, 1915, from a study of *Nosema* infection in an apiary.

Colony No.	1914											1915						
	May.					June.			July.	Sep-tem-ber.		Nov-ember.	March.		April.		May.	
	2	8	12	15	27	5	8	18	15	10	23	5	2	8	25	7	26	
1.....	0 ^e	1 ^p	0 ^p	1 ^p	0 ^p	5 ^p	0 ^p	0 ^p	0 ^p	0 ^e	0 ^e	0 ^e	0 ^e	0 ^p	0 ^p	0 ^h
2.....	2 ^e	2 ^p	1 ^p	1 ^h	0 ^p	0 ^p	0 ^p	0 ^p	0 ^e	0 ^e
3.....	1 ^e	1 ^e	3 ^p	2 ^h	1 ^p	1 ^p	0 ^p	0 ^p	0 ^e
4.....	1 ^e	1 ^p	1 ^p	2 ^h	0 ^p	0 ^p	0 ^e
5.....	0 ^e	1 ^p	1 ^p	2 ^h	0 ^p	1 ^p	0 ^p	0 ^p	0 ^e	0 ^e	0 ^e	0 ^e	0 ^p	1 ^p	0 ^h
6.....	0 ^e	0 ^p	1 ^p	2 ^h	0 ^p	0 ^p	0 ^p	0 ^p
7.....	1 ^e	2 ^p	0 ^p	2 ^h	1 ^h	1 ^p	0 ^p	0 ^p	0 ^e	0 ^e
8.....	0 ^e	0 ^p	2 ^p	1 ^h	0 ^e	0 ^p	0 ^p	0 ^p	0 ^e	0 ^e	5 ^e	0 ^e	D
9.....	1	0 ^p	0 ^p	4 ^h	0 ^h	1 ^p	1 ^p	0 ^p	0 ^p
10.....	0 ^p	2 ^e	2 ^e	1 ^h	0 ^p	2 ^p	0 ^p	0 ^p	0 ^p
11.....	1 ^e	1 ^p	0 ^p	1 ^h	0 ^h	0 ^p	0 ^p	0 ^p
14.....	2 ^e	2 ^e	2 ^e	0 ^e	1 ^e	0 ^p	0 ^p	0 ^p
15.....	1 ^e	1 ^p	2 ^p	2 ^h	2 ^h	0 ^p	0 ^p
16.....	2 ^e	2 ^p	2 ^p	1 ^h	0 ^h	1 ^p	0 ^p	1 ^p	0 ^e
17.....	2 ^e	4 ^p	1 ^p	4 ^h	0 ^h	1 ^p	0 ^p	1 ^p	0 ^p	1 ^e	1 ^p	0 ^h
18.....	0 ^e	1 ^p	1 ^p	3 ^h	1 ^h	3 ^p	1 ^p	0 ^p	0 ^e	5 ^e	D
19.....	0 ^e	0 ^p	1 ^p	2 ^h	2 ^h	2 ^p	0 ^p	0 ^p	0 ^e	0 ^e	0 ^p	0 ^h	0 ^h
20.....	1 ^e	1 ^p	2 ^p	1 ^h	1 ^h	3 ^p	0 ^p	0 ^p	0 ^e	0 ^e	0 ^p	0 ^h	0 ^h
21.....	1 ^e	3 ^p	0 ^p	2 ^h	1 ^h	1 ^h	0 ^p	0 ^e	1 ^p	0 ^p	0 ^h	0 ^h
22.....	0 ^e	2 ^p	2 ^p	3 ^h	2 ^h	2 ^p	1 ^p
"7".....	0 ^e	2 ^p	2 ^p	1 ^h	0 ^p	1 ^p	1 ^p	0 ^e	s	0 ^e	0 ^e
"36".....	3 ^e	2 ^p	3 ^h	0 ^h	3 ^p	1 ^p	0 ^p	t	0 ^e	0 ^p
"50".....	4 ^e	4 ^p	3 ^p	2 ^h	1 ^p	3 ^p	0 ^p	0 ^p	u	6 ^e	2 ^e	1 ^p	0 ^e	0 ^e
"66".....	2 ^e	2 ^p	0 ^p	2 ^h	1 ^p	v	0 ^e	0 ^e	0 ^e	0 ^e	0 ^e
"68".....	0 ^e	2 ^p	0 ^p	3 ^h	0 ^p	0 ^p	0 ^p	w	0 ^e
"73".....	7 ^e	5 ^e	4 ^p	6 ^h	1 ^p	3 ^p	0 ^p	x	0 ^e
"82".....	1 ^e	3 ^p	1 ^p	0 ^h	2 ^p	1 ^p	y	0 ^e	9 ^e	9 ^p	1 ^e	0 ^e
													z	0 ^e	1 ^e	3 ^p	0 ^e	0 ^e

Explanation of Table IV.—The colonies reported in Table IV for 1914 do not bear the same numbers that were assigned to them for 1913 in Table III except those designated by numbers in quotation marks. The first 9 colonies reported in the table for 1915 bear the same numbers they did in 1914. The identity of colonies numbered by letters "s" to "z," inclusive, had been lost through changes made in the apiary.

Table IV shows that out of 1,050 bees examined during May, 1914, 166 (16 per cent) were *Nosema* infected.

In June, out of 700 bees examined 60 (9 per cent) were found infected.

In July, out of 240 bees examined 2 (1 per cent) were infected.

In September, 220 bees were examined and no *Nosema*-infected one was found.

In November, 60 bees were examined and none was found infected.

Out of 2,270 bees examined during the summer of 1914, 218 (10 per cent) were found infected.

It will be noted that during the early months of the active bee season of 1914 there was a higher percentage of *Nosema*-infected bees in the apiary than during a similar period of 1913.

Two colonies were so weak in May that they were disposed of. In one of these at least (No. 13) the weakness was most probably due to *Nosema* infection.

During the first week in July the apiary was moved to a new location. It is interesting to note that the amount of *Nosema* infection after removal was reduced to practically nothing. This is not definitely accounted for by the results obtained by these investigations.¹

Examinations were made of a portion of the apiary in 1915. In March, out of 50 bees taken from 5 colonies, 6 (12 per cent) were found to be *Nosema* infected.

In April, out of 280 bees taken from 17 colonies 24 (9 per cent) were found infected.

In May, out of 200 bees taken from 10 colonies 16 (8 per cent) were infected.

Out of 530 bees examined from the apiary during the spring of 1915, 46 (9 per cent) infected ones were found.

Among the colonies that were examined during the spring of 1915 two (Nos. 8 and 18) died by the end of April. Both of these contained a rather high percentage of *Nosema*-infected bees. Two others containing an equal or greater number of infected bees lived throughout May and had recovered apparently by June. In case of these 4 colonies it can properly be said that the two colonies that died died of *Nosema* disease, whereas the two that lived recovered from it.

In Table V is given a summary of the results obtained in the study of the apiary from April, 1912, to June, 1915.

¹ That the immediate environment of the apiary determines, to some extent, the presence or absence of *Nosema*-disease and its transmission seems quite likely. In searching for the cause for such a difference the water supply of the bees, if near by, must not be overlooked (p. 46). In this connection, it may be pointed out that in the experimental apiary (Pl. IV) *Nosema* infection at no time exceeded 1 per cent, excepting naturally in inoculated colonies, although the source from which these colonies were obtained had been largely the apiary which, it will be seen from Tables II and III, showed *Nosema* infection in from 10 to 20 per cent of the bees. Here there was no slowly moving body of water used by the bees as the source of their water supply.

TABLE V.—Summary of results from a study of *Nosema* infection in an apiary.

Year.	March.			April.			May.			June.			July.		
	Bees examined.	<i>Nosema</i> infected.	Per cent.	Bees examined.	<i>Nosema</i> infected.	Per cent.	Bees examined.	<i>Nosema</i> infected.	Per cent.	Bees examined.	<i>Nosema</i> infected.	Per cent.	Bees examined.	<i>Nosema</i> infected.	Per cent.
1912.....	270	28	10	240	72	30	410	96	23	130	19	15	130	21	16
1913.....	50	7	220	8	4	260	23	9
1914.....	1,050	166	16	700	60	9	240	2	1
1915.....	50	6	12	280	24	9	200	16	8
Total.....	320	34	11	520	96	18	1,910	285	17	1,050	87	8	630	46	7

Year.	August.			September.			October.			Total bees examined.	Total <i>Nosema</i> infected.	Per cent.
	Bees examined.	<i>Nosema</i> infected.	Per cent.	Bees examined.	<i>Nosema</i> infected.	Per cent.	Bees examined.	<i>Nosema</i> infected.	Per cent.			
1912.....	60	14	170	14	8	1,140	236	20
1913.....	240	11	5	170	43	25	60	1	1,270	225	10
1914.....	220	2,210	121	10
1915.....	530	46	9
Total.....	300	25	8	560	57	10	60	1	5,150	631	12

From Table V it will be observed that the number of infected bees found at different periods of the year varied considerably. April and May furnished the highest percentage, being 18 and 17 per cent respectively. In March, June, July, August, and September the number of *Nosema*-infected bees among those examined was 11, 8, 7, 5, and 10 per cent respectively. Out of 5,150 bees taken from the apiary from April, 1912, to June, 1915, and examined, 631 (12 per cent) were *Nosema* infected.¹

Laidlow (1911) reports that out of somewhat more than 1,500 bees received from various parts of Australia, 17 per cent were found to be *Nosema* infected.

From an examination of the foregoing tables it is seen that *Nosema* infection was found to be present in practically every colony of the apiary. Had further examinations been made of the few colonies in which *Nosema apis* was not found, one could well expect, from what is known of the disease, that these, too, would have revealed the presence of the infection. It is seen also that the infection persisted throughout all seasons of the year, and that it was heaviest

¹ While this three-year study was being made the apiary served for other work. It is likely that the attending manipulations were accompanied from time to time by a certain amount of robbing. From the nature of the disease, however, it is not believed that this fact affected materially the results obtained.



EXPERIMENTAL APIARY IN WHICH THE NOSEMA-DISEASE EXPERIMENTS MADE DURING THE SUMMER OF 1915 WERE CONDUCTED. (AUTHOR'S ILLUSTRATION.)

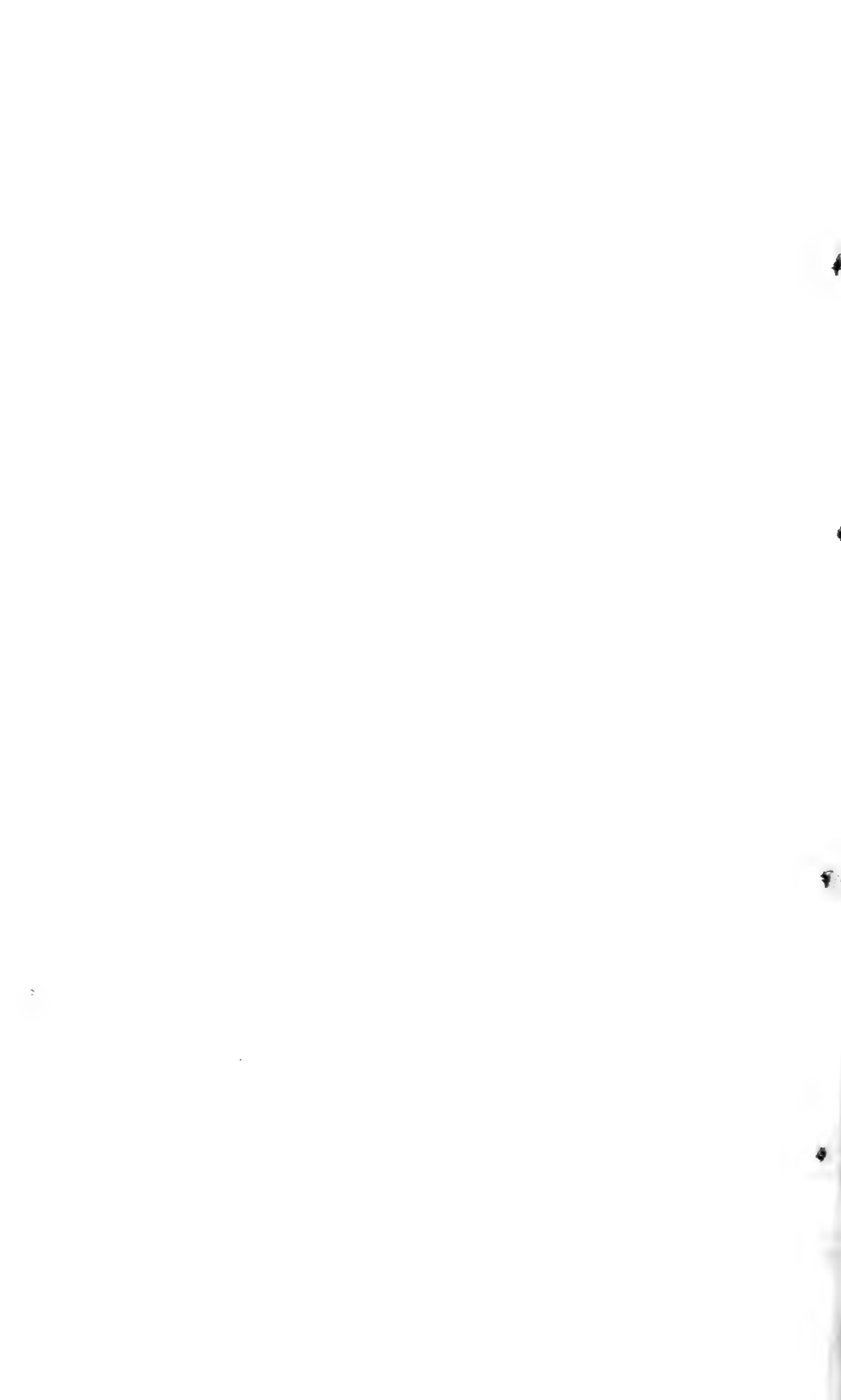

in the spring. Some colonies died as a result of the disease, while a greater number recovered from the infection, increased in strength, and behaved in all respects as healthy colonies.

The total of all the spring counts, during the period from 1912 to 1915, inclusive, of the apiary under study, was 94 colonies. Out of this number at least 12 (13 per cent) died more or less directly as the result of Nosema disease. An equal or greater loss to the apiary than this colony loss probably is the aggregate loss in strength sustained by colonies weakened by the infection but which recover from the disease.

Naturally it is particularly unfortunate from an economic point of view that the highest percentage of infected bees, and consequently the heaviest loss in strength sustained by colonies from Nosema infection, occurs in the spring.

Beuhne (1916) has reported investigations made on colonies from his own apiary which are similar in nature to the foregoing studies. The results he obtained indicate that Nosema infection in Australia is similar to the infection as it occurs in America.

SYMPTOMS OF NOSEMA-DISEASE.

Nosema-disease presents only a few symptoms. In describing them the colony rather than individual bees should be considered as the unit, since it is the colony as a whole that is of primary interest to beekeepers.

Weakness is a colony symptom which invariably will be manifest if a sufficiently large percentage of the bees of the colony are Nosema infected and if the infection persists for a sufficient period. When only a small percentage of the bees are infected the weakness resulting may never be apparent. The loss in strength may be gradual or sudden.

The behavior of a Nosema-infected colony is similar to that of a healthy one. The stores are sufficient. The queen does her work well. As the colony dwindles the queen usually is among the last handful of bees. The brood in general is normal in appearance, but in colonies weakened by the disease not infrequently it is seemingly in excess of the amount that can be properly cared for by the adult bees present.

In Nosema-disease the workers especially suffer from the infection. An infected bee manifests no outward symptoms of the disease when seen among the other bees of the colony and it performs functions similar to those performed by healthy ones.

When the stomach of an infected bee is removed it may show marked changes which are characteristic of Nosema-disease. The organ pales as a result of infection. The brownish yellow or dark reddish hue of the normal stomach is gradually lost as the disease advances. The organ (Pl. I) is often increased in size, the circular

constrictions are less marked, and the transparency is diminished. In late stages of the disease, however, the stomach approaches the normal in size and the constrictions are again well marked. The organ is then white and opaque and the tissues are friable and easily crushed. When crushed the mass presents a milky appearance.

Upon microscopic examination *Nosema apis* is found in very large numbers in the crushed tissues. The presence of the parasite is almost invariably recognized by its spore form. The presence of *Nosema*-infected bees in a colony is the one constant colony symptom of the disease.

METHODS EMPLOYED IN EXPERIMENTAL STUDIES.

As *Nosema apis* has not been grown in the laboratory by artificial methods, in carrying out these investigations it has been necessary to inoculate a large number of colonies of bees. The use of a few bees in cages was found to be inadequate for experimental purposes. A 4 to 6 frame nucleus in a 10-frame hive body (fig. 5) serves well the purposes of an experimental colony. The experimental apiary (Pl. IV), consisting usually of about 50 colonies, was the same one that was used in the sacbrood studies. During the bee season the colonies were inoculated and kept in the apiary in the open under conditions similar to those occurring in nature. Precautions similar to those observed in the sacbrood studies were followed in

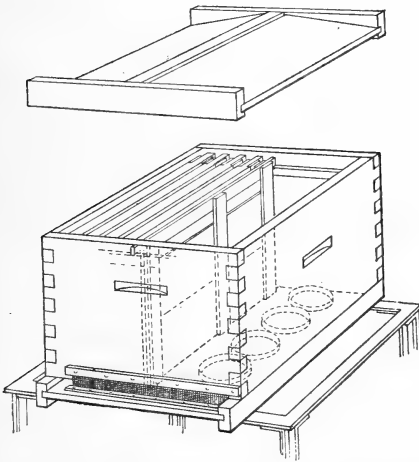

FIG. 5.—Experimental hive, having four Hoffman frames, a division board, Petri dishes as feeders, the entrance nearly closed with wire cloth, and the opening on the side of the hive body occupied by the frames. (Original.)

the present studies. During the winter colonies to be inoculated were removed to and kept in the laboratory. The top of the hive body was screened and the bees given free opportunity for flight through a hole in the window.

The manner of obtaining the parasite *Nosema apis* from diseased bees for use in the inoculations is described under "Diagnosis" (p. 48). The stomachs of from 5 to 10 infected bees are amply sufficient for each inoculation. After their removal from the bees they are crushed, suspended in sirup, and fed to a colony free or practically free from *Nosema* infection. The methods throughout are similar

in general to those employed and described in the sacbrood studies. It should be stated in addition that no watering place for the bees was provided at the time of these experiments and none with sluggish water was near by.

The results of an experiment usually can be determined during the second week following the inoculation. The diagnosis is made as described later in the present paper (p. 48). Usually one examination of 10 bees is sufficient for the determination of results. It is advisable sometimes, however, to make others.

As a rule experimental colonies inoculated during the summer recover from the infection and can be used again. The period which must elapse, however, before they can be used for a second experiment varies. An examination of the field bees should show no infection among them or only an occasional infected bee before another inoculation is made. A colony used in the laboratory is good for one inoculation only if by it Nosema-disease is produced. Should the results be negative following an inoculation, however, the colony may be used in a subsequent experiment.

It is not necessary to disinfect a hive which has housed a Nosema-infected colony. The experimental colony may or may not have a queen. If one is present no concern need be felt in regard to whether or not she is infected. No fear need be entertained that drones from infected colonies in the apiary will transmit the infection to the experimental colony.

EFFECT OF NOSEMA INFECTION ON THE COLONY AND ON THE APIARY.

To determine the effect which Nosema infection in a colony produces on the colony, and on the apiary of which the colony is a part, is a problem in the study of Nosema disease which is of vital interest to the beekeeper. Some observations have been made bearing directly upon this point.

EXPERIMENT NO. 1.

On September 13, 14, 15, and 18 ten colonies were fed a sirup suspension of the crushed intestines of Nosema-infected bees. These colonies (Table II, Nos. 6a, 12, 25, 35, 41, 55, 65, 66, 67, and 70) were in the apiary mentioned on page 13. Those selected for inoculation were not especially strong, the bees being easily accommodated on six or seven brood frames and being about an average for the apiary. Examinations show that about 10 per cent of the pollen-carrying bees of these colonies were Nosema infected at the time of the inoculation. The 32 uninoculated colonies in the apiary served as checks.

It will be seen from Table II that after inoculation 50 to 100 per cent of the pollen-carrying bees in the inoculated colonies were Nosema infected. Out of the 100 bees examined from these colonies

during the period from October 5 to October 16, inclusive, 132 (70 per cent) were found infected. These colonies when examined on October 28 showed that, out of 100 bees examined, 78 (78 per cent) were infected. It will be noted, therefore, that following the feeding inoculations there was a marked increase in the percentage of *Nosema*-infected bees in each of the 10 colonies inoculated.

In the experiment sufficient precautions were not taken to prevent robbing at the time the inoculations were made. This resulted in an increase also of *Nosema*-infected bees in some of the uninoculated colonies (Table II) of the apiary—the checks. The increase in the number of infected bees disappeared more readily from the check colonies, however, than from the inoculated ones, suggesting that probably a comparatively small amount of the contaminated sirup was obtained by the robbing bees.

On December 17, out of 100 bees taken from the 10 inoculated colonies 49 (49 per cent) were found to be *Nosema* infected, showing that the percentage of infected bees had decreased.

From comparison of the inoculated colonies in October and in December, it was observed that their strength had decreased and that they were relatively weaker than the checks. Toward the last of December one of the 10 inoculated colonies died. During the last week of the year the remaining 9 were packed for the winter as were also the check colonies. Some of the weaker check colonies were united, giving them a slight advantage in strength over the inoculated ones.

The winter 1912–13 being a favorable one for bees, the winter losses were low. In March, 1913, when the first examination of the apiary was made, 4 of the 10 colonies that had been inoculated had died out. Four of the six inoculated colonies that were still alive showed 4, 6, 2, and 2 *Nosema*-infected bees respectively in samples of 10 bees examined. Neither of the other two inoculated ones showed at the time the presence of *Nosema* infection. All of the 19 uninoculated colonies packed in December were alive in March, 1913. Out of 190 bees caught from the entrance of these check colonies during March only 6 (3 per cent) were *Nosema* infected.

By the middle of May another of the inoculated colonies (No. 12) had died, making 5 in all. Of the 10 colonies that had been inoculated in September, 1912, the 5 that lived through the winter and the following spring continued to gain in strength during the summer of 1913 and by autumn were apparently as strong and healthy as any in the apiary.

By experiment No. 1 it is shown that when colonies are inoculated with *Nosema apis* a high percentage of adult bees of each colony becomes *Nosema* infected—results which confirm similar ones previously obtained by Dönhoff (1857), Zander (1909), and others.

Such results, together with facts which are recorded on the foregoing pages, are sufficient to demonstrate that Nosema-disease is an infectious disease of adult bees.

It is shown also by the results of this experiment that there is a tendency for the infected colonies to become weakened. It is further shown that when inoculated in September colonies do not die out readily as a result of the inoculation. Furthermore the results indicate that the infection is not readily transmitted from the infected to the healthy colonies of the apiary. It is further shown that colonies inoculated in September may die as a result of the infection during the winter that follows, or they may survive the winter, gain in strength during the brood-rearing season, and by the following autumn present the appearance of healthy colonies.

EXPERIMENT NO. 2.

Beekeepers are always desirous of knowing whether combs from diseased colonies can be used in healthy ones without causing a spread of the infection. To obtain data relative to this point experiment No. 2 was begun in July, 1913 (Table III). In the experiment, brood combs from diseased colonies were inserted into colonies comparatively free from Nosema infection and kept under observation for more than a year afterwards.

Combs from the 5 colonies of experiment No. 2, which died during the winter and spring following their inoculation with *Nosema apis* in September, 1912, were inserted into the 6 colonies (Nos. 36, 50, 61, 66, 68, and 82, numbered by capital letters "A" to "F," respectively) used in the present experiment, each colony receiving from two to four combs. The colonies from which the inserted frames were obtained had been dead for from seven weeks to five months before they were given to the colonies. None of the 6 colonies were strong, the bees being easily accommodated on from four to six brood frames, a strength representing about an average for the apiary.

Out of 110 bees examined from the 6 colonies of the experiment prior to the insertion of the combs 10 (9 per cent) were found to be infected; and out of 170 bees examined after they were inserted 26 (15 per cent) were found to be infected. This increase in Nosema-infected bees can not be attributed to the introduction of the combs, since a similar increase is noted in the other colonies of the apiary serving as checks.

All of the colonies of the experiment lived through the winter and spring except one (No. 61). This colony was dead when examined in May, 1914. Dead bees taken from the bottom board of the hive showed a high percentage of Nosema-infected bees. The 5 colonies that survived gained in strength, behaved as healthy colonies, and contained a percentage of Nosema-infected bees approximating that

of the other colonies of the apiary (Table IV, colonies numbered 36, 50, 66, 68, and 82).

The results obtained indicate, therefore, that by inserting combs from *Nosema*-infected colonies, as was done in experiment No. 2, the infection is not transmitted appreciably. An explanation for this is easily seen from results recorded throughout the present paper. Further experiments on the point are summarized in Table XXVI.

EXPERIMENT NO. 3.

In this experiment 7 colonies free from *Nosema* infection were inoculated by feeding them sirup to which *Nosema apis* had been added. The bees from which the parasites were obtained for this experiment were from various sources (p. 12). They had been dead and drying in the laboratory at room temperature for at least three months. All of the 7 colonies received the first inoculation feeding on October 8. On each succeeding day for four days the feeding was repeated. Each of the inoculated colonies of the experiment was examined from time to time, but no *Nosema*-infected bees were found. The final examination in connection with this experiment was made on October 28. Out of 70 bees examined from the 7 colonies only one *Nosema*-infected bee was found. The infection in this instance probably did not result from the inoculations.

In this experiment it is shown that *Nosema apis* drying in the abdomen of bees at room temperature for three months does not produce infection when fed to healthy bees. This result suggested the interesting fact that the parasite of the bee resisted drying for a comparatively short time only (see other experiments, p. 40).

EXPERIMENT NO. 4.

In experiment No. 4, four of the colonies used in experiment No. 3 were inoculated on October 29, 1912, with *Nosema apis* taken from infected bees recently killed. Nine days after the inoculation samples of bees were examined from each of the four colonies inoculated. *Nosema* infection was found in nearly all of the bees examined. Two weeks after inoculation 50 bees were examined from each of the 4 colonies. All of the 200 bees were found to be infected. At the end of three weeks a similar condition prevailed. On December 16, 48 days after inoculation, all of the 4 inoculated colonies were alive. A large number of bees were now found on the bottom board of the hive. By this time the colonies had become very much weakened. The bees were uneasy, the cluster being easily disturbed. During the following week 1 of the colonies died out completely. The remaining 3 were chloroformed. Another colony inoculated in November gave like results, and died in January, 1913.

Each of the 5 colonies of the experiment were four-framed nuclei. As the inoculations were made late in the autumn there were no

young bees emerging. All of the bees of the colonies were exposed, therefore, to infection by the inoculation.

It is seen from this experiment that during the autumn workers infected with *Nosema apis* live, as a rule, for more than one month, but that most of them die during the second month after infection. These results led to the conclusion that heavy infection in a colony when no brood is being reared will destroy the colony, but that it may live for two or three months following the infection.

Although 100 per cent of the workers in each of the 5 colonies were infected, the queens from 3 of them were free from infection at the death of their respective colonies. The other 2 were found to be infected.

NOSEMA INFECTION WEAKENS THE COLONY.

There is good evidence at hand indicating that *Nosema* infection weakens the colony. The fact that the epithelial layer of the stomach is filled with parasites (fig. 3; Pls. I and II) at once suggests that the functions of the organ, digestion and absorption at least, would be decidedly impaired thereby. Likewise, when the Malpighian tubules are invaded (Pls. II and III), it is to be expected that the bee suffers impaired functions. The abnormal condition argues strongly that such a bee is less efficient as a member of a colony than an uninfected one. Further evidence that infection weakens a colony is seen in the fact that in nature the heaviest infection is encountered in the weaker colonies. Still further evidence is seen in the results obtained in experiments Nos. 1, 3, and 4, just recited, and from inoculations made in 1913, 1914, 1915, and 1916, now to be referred to.

On June 4, 1913, a colony was inoculated by feeding it *Nosema apis* in a sirup suspension. On the 13th it was found to be heavily infected. At this time the inoculation was repeated. When examined on July 12 the colony had not increased in strength as the uninoculated ones had done. On this date it was reinoculated. By the middle of August it had not gained in strength. No reason could be assigned for the failure of the colony to become strong other than the presence in it of *Nosema* infection resulting from the inoculation.

On June 9, 1914, a colony was inoculated with *Nosema apis*. On the 22d it was found to be heavily infected. On July 8 it was reinoculated, at which time it was weaker than the check colonies. On August 6 the colony was still relatively weak and was reinoculated. On the 17th it was still weak. The failure on the part of the colony to become stronger is attributed to the *Nosema* infection.

On August 6, 1914, a colony was inoculated with *Nosema apis*. It became heavily infected and on September 9 it seemed to be weakened as a result of the infection. It was reinoculated on this date. On December 1 it was found to be heavily infected and on January 15, 1915, it was dead.

On March 30, 1915, a colony was inoculated, resulting in heavy infection with *Nosema apis*. On June 17 the inoculation was repeated. Later a swarm was cast. Inoculations were repeated on July 3, 9, 17, 24, 31, and August 13. The colony became much weakened and later in the autumn died.

Beginning on March 22, 1916, a colony was inoculated at irregular intervals thereafter until September. Much brood was being reared in it throughout the season, but its strength in September was about equal to its strength in March.

The evidence obtained, it will be observed, is sufficient to justify the conclusion that the *Nosema* infection in a colony tends to weaken it. The weakness resulting does not occur immediately following the infection, however. During the active brood-rearing season the young bees reared may exceed the loss from disease and the colony will then actually gain in strength. On comparison of colonies that are infected with those that are not, however, it will be seen that the infected ones are the weaker. An experimental colony receiving repeated inoculations increases in strength, as a rule, during the first two weeks following the initial feeding through the emergence of young bees, but comparatively little, if any, after the first month.

The question arises as to whether the weakness is the result of infection in workers, drones, or the queen, or in a combination of these different members of the colony. Brood apparently does not become affected with *Nosema apis* (p. 10). The weakness in a colony can not be attributed, therefore, to infection of the brood. Infection among drones is rare (p. 11). Loss in strength, therefore, could not be expected to result from infection in the drones. The queen in an infected colony is more often free from the infection than not (p. 11). Weakness from *Nosema* infection can result, therefore, when the queen is free from infection. By elimination in this way the conclusion is reached that the weakness produced by *Nosema* infection in a colony is due primarily to infection among the adult workers.

Other observations made point to the same conclusion. Workers taken from colonies in which *Nosema* infection had reached a rather advanced stage were confined in the McIndoo wire-screen cages¹ and kept at room temperature. Healthy ones were similarly caged and kept under observation. The relative length of time that the infected and uninfected bees lived under these conditions was noted.

On December 8, 1914, in each of four cages were placed from 15 to 30 bees taken from colonies heavily infected with *Nosema apis*. By the end of one week, out of 79 bees confined 62 (78 per cent) had died. On the same date bees from another infected colony were similarly confined. At the end of a week out of 119 bees confined 108 (91 per cent) had died. On December 15, 1914, the experiments were

¹ Small triangular cages devised by McIndoo (1917, p. 4) in his studies on the honeybee.

repeated. Out of 138 bees in one set of four cages 125 (91 per cent) were dead at the end of one week. In the other set of four cages out of 136 bees confined 98 (72 per cent) were dead at the end of a week.

On December 8 a check experiment was begun. In each of two cages bees taken from healthy colonies were confined and kept at room temperature. At the end of one week out of 59 bees confined 5 (8 per cent) had died.

Out of a total of 472 diseased bees confined 393 (83 per cent) were dead at the end of one week, while out of a total of 59 healthy bees kept under similar conditions only 5 (8 per cent) were dead at the end of a week. Although such experiments are subject to great variation and should be repeated many times for definite results, yet the difference between 83 per cent of loss in the case of infected bees and 8 per cent of loss in the case of healthy ones is sufficiently great to justify the conclusion that the heavily infected bees under the conditions of the experiment possessed less endurance than the healthy ones. These results indicate that weakness in a colony may result directly from infection among the workers.

Throughout the investigations which have been made on the disease, therefore, evidence has been obtained indicating that weakness results not from the infection of the queen, drones, or brood, but of the workers.

RESISTANCE OF NOSEMA APIS TO HEATING.

NOSEMA APIS SUSPENDED IN WATER.

Preliminary results indicating the minimum amount of heating that is necessary to destroy *Nosema apis* were given in an earlier paper (White, 1914). Other experiments have been performed. In conducting the experiments a suspension was made in water of the crushed stomachs and intestines of *Nosema*-infected bees. This suspension was distributed in test tubes in such a dilution that the amount in each tube contained the infective material of from 5 to 10 bees. The tubes were stoppered and heated at different degrees of temperature by immersing them in water. Colonies free from infection were inoculated with the heated material and the results noted.

Table VI summarizes some of the experiments made with the results obtained.

TABLE VI.—*Experiments to determine the heat required to destroy Nosema apis suspended in water.*¹

Date of inoculation.	Temperature employed.		Period of heating.	Results of inoculations.
	° C.	° F.		
Jan. 31, 1913.....	50	122	20	Nosema infection produced.
Jan. 8, 1913.....	55	131	10	Do.
Oct. 4, 1913.....	56	133	10	Do.
Oct. 15, 1913.....	56	133	10	Do.
May 21, 1915.....	58	136	10	Do.
Oct. 15, 1913.....	57	135	10	No infection produced.
Feb. 8, 1913.....	58	136	10	Do.
Oct. 4, 1913.....	58	136	10	Do.
Aug. 28, 1915.....	59	138	10	Do.
Nov. 11, 1912.....	60	140	10	Do.
Nov. 20, 1912.....	60	140	10	Do.
May 21, 1915.....	60	140	10	Do.
Aug. 28, 1915.....	61	142	10	Do.
Nov. 12, 1913.....	65	149	10	Do.
Jan. 8, 1913.....	65	149	10	Do.
Oct. 29, 1912.....	80	176	20	Do.
Nov. 12, 1912.....	100	212	5	Do.

¹ In omitting fractions of degrees the nearest whole number is given.

From Table VI it will be observed that *Nosema apis* in a water suspension was destroyed in 10 minutes at a temperature somewhere between 135° F. (57° C.) and 138° F. (59° C.).

NOSEMA APIS SUSPENDED IN HONEY.

From preliminary experiments it was learned that the amount of heating that is required to destroy *Nosema apis* suspended in glycerin is approximately equal to that required to destroy it when suspended in water. It was anticipated, therefore, that the minimum amount of heating that would destroy the germ suspended in honey would approximate that required to destroy it when suspended in water.

Experiments were made to determine the approximate thermal death point of *Nosema apis* when it is suspended in honey. In making the experiments the technique used was similar in the main to that of the preceding group of experiments wherein suspensions in water were heated. In Table VII are summarized the experiments performed, together with the results obtained.

TABLE VII.—*Experiments to determine the heat required to destroy Nosema apis suspended in honey.*

Date of inoculation.	Temperature employed.		Period of heating.	Results of inoculations.
	° C.	° F.		
Aug. 28, 1915.....	58	136	10	Nosema infection produced.
Aug. 27, 1915.....	59	138	10	Do.
June 9, 1915.....	59	138	10	No infection produced.
May 21, 1915.....	60	140	10	Do.
June 8, 1915.....	61	142	10	Do.
Aug. 28, 1915.....	61	142	10	Do.
June 9, 1915.....	62	144	10	Do.
June 8, 1915.....	63	145	10	Do.
May 5, 1915.....	65	149	10	Do.
May 21, 1915.....	70	158	10	Do.
May 21, 1915.....	80	176	10	Do.

Table VII shows that *Nosema apis* in a honey suspension was destroyed by heating for 10 minutes at a temperature between 136° F. (58° C.) and 140° F. (60° C.), the death point being about 138° F. (59° C.).

RESISTANCE OF NOSEMA APIS TO DRYING.

In experiments relative to the effect of drying on *Nosema apis*, stomachs from *Nosema*-infected bees were crushed, and the crushed tissues were smeared on slides to the extent of a thin layer. The slides were placed in incubator, room, outdoor, and refrigerator temperatures, respectively. At different intervals after the preparation of the smears an aqueous suspension was made, germs from two slides representing the material from 5 to 20 bees being used. This was added to sirup and fed to a healthy colony. Whether or not the parasite had been destroyed was determined by the presence or absence of *Nosema*-infection in the colony following the inoculation with the sirup.

NOSEMA APIS DRYING AT INCUBATOR TEMPERATURE.

In Table VIII are summarized the experiments, together with the results obtained, in which the *Nosema* material was allowed to dry at incubator temperature.

TABLE VIII.—Resistance of *Nosema apis* to drying at incubator temperature.

Date of inoculation.	Period of drying.		Results of inoculation.
	Months.	Days.	
July 30, 1915.....	0	10	<i>Nosema</i> infection produced.
July 14, 1916.....	0	13	Do.
Oct. 5, 1914.....	0	14	Do.
July 21, 1915.....	0	18	Do.
July 29, 1916.....	0	15	No infection produced.
Sept. 11, 1914.....	0	21	Do.
Nov. 2, 1914.....	0	30	Do.
Sept. 29, 1914.....	0	40	Do.
Oct. 16, 1914.....	0	56	Do.
July 9, 1915.....	2	15	Do.
May 24, 1915.....	7	27	Do.
July 9, 1915.....	9	19	Do.

From Table VIII it will be seen that *Nosema apis* drying at incubator temperature was destroyed in from 15 to 21 days, that is, during the third week.

NOSEMA APIS DRYING AT ROOM TEMPERATURE.

In Table IX are summarized experiments in which the drying of *Nosema apis* took place at room temperature.

TABLE IX.—Resistance of *Nosema apis* to drying at room temperature.

Date of inoculation.	Period of drying.		Results of inoculation.
	Days.		
July 26, 1916.....	18		<i>Nosema</i> infection produced.
Sept. 11, 1914.....	21		Do.
Aug. 11, 1916.....	35		Do.
Oct. 2, 1914.....	42		Do.
Sept. 1, 1915.....	43		Do.
Aug. 26, 1916.....	50		Do.
Oct. 16, 1914.....	56		Do.
May 24, 1916.....	60		No infection produced.
Sept. 1, 1915.....	61		Do.
June 27, 1916.....	95		Do.

From results recorded in Table IX it will be observed that *Nosema apis* drying at room temperature remained virulent for from 56 to 60 days, that is, about 2 months.

NOSEMA APIS DRYING AT OUTDOOR TEMPERATURE.

Table X summarizes experiments in which *Nosema apis* was allowed to dry at outdoor temperature.

TABLE X.—Resistance of *Nosema apis* to drying at outdoor temperature.

Date of inoculation.	Period of drying.		Results of inoculation.
	Months.	Days.	
Sept. 11, 1914.....	0	21	<i>Nosema</i> infection produced.
Oct. 2, 1914.....	0	42	Do.
Aug. 17, 1914.....	0	46	Do.
Oct. 16, 1914.....	0	56	Do.
June 7, 1916.....	0	60	Do.
Sept. 27, 1913.....	0	60	No infection produced.
July 9, 1915.....	0	75	Do.
June 27, 1916.....	0	80	Do.
Aug. 17, 1915.....	0	85	Do.
July 17, 1916.....	0	100	Do.
May 25, 1915.....	9	0	Do.
July 17, 1914.....	10	10	Do.
July 1, 1914.....	11	0	Do.

The results recorded in Table X show that *Nosema apis* ceased to be virulent after 2 months of drying at outdoor temperature.

NOSEMA APIS DRYING AT REFRIGERATOR TEMPERATURE.

Table XI summarizes experiments in which *Nosema apis* was allowed to remain dry in the refrigerator.

TABLE XI.—Resistance of *Nosema apis* to drying at refrigerator temperature.¹

Date of inoculation.	Period of drying.		Results of inoculation.
	Months.	Days.	
Dec. 2, 1915.....	3		<i>Nosema</i> infection produced.
Jan. 3, 1916.....	4		Do.
Mar. 3, 1916.....	6		Do.
Apr. 2, 1916.....	7		Do.
Apr. 22, 1916.....	7½		No infection produced.
May 3, 1916.....	8		Do.
July 3, 1916.....	10		Do.

¹ A few times during the experiments in which the refrigerator temperature was used, the ice became exhausted, allowing the temperature to approach and possibly to reach that of the room. This higher temperature, when present, however, at no time prevailed for more than a day.

It is learned from the results recorded in Table XI that *Nosema apis* drying at refrigerator temperature remained virulent for seven months but that no disease was produced following inoculation with the material after seven and one-half months drying.

From the results obtained in the experiments relative to the resistance of *Nosema apis* to drying, given in Tables VIII-XI, it will be observed that the period the parasite remained alive, or at least virulent, varied, depending upon the environment of the germ. The shortest period for the destruction of spores was obtained under incubator conditions, while the longest period occurred under refrigerator conditions. The death probably was not due to the drying alone but to a combination of factors of which drying was an important one.

RESISTANCE OF NOSEMA APIS TO FERMENTATION.

Experiments have been made to obtain data relative to the resistance of *Nosema apis* to fermentative processes. In conducting the experiments suspensions of the crushed stomachs from *Nosema*-infected bees were made in a 10 per cent sugar (saccharose) solution and in a 20 per cent honey solution. These solutions were distributed in test tubes. Each tube contained infectious material equal to that present in the stomachs of from 5 to 10 infected bees. To each suspension was added a bit of soil to inoculate it further. Suspensions were allowed to ferment at incubator, room, outdoor, and refrigerator temperatures, respectively. At intervals reckoned in days the fermenting suspension from a single tube was transferred to about one-half pint of sugar sirup and fed to a colony free from the infection. The results were then noted.

FERMENTATION AT INCUBATOR TEMPERATURE.

In Table XII are summarized some of the results that were obtained when a suspension of *Nosema apis* in a 20 per cent aqueous solution of honey was allowed to ferment at incubator temperature.

TABLE XII.—Resistance of *Nosema apis* to fermentation in a honey solution.

Date of inoculation.	Period of fermentation.	Results of inoculation.
	<i>Days.</i>	
July 25, 1916.....	1	<i>Nosema</i> infection produced.
July 26, 1916.....	2	Do.
July 27, 1916.....	3	No infection produced.
July 28, 1915.....	4	Do.
July 12, 1915.....	5	Do.
July 15, 1916.....	8	Do.
July 17, 1916.....	10	Do.

From experiments recorded in Table XII it was shown that *Nosema apis* was destroyed by fermentation in 20 per cent honey solution at incubator temperature in three days.

FERMENTATION AT ROOM TEMPERATURE.

In Table XIII are summarized experiments in which colonies were inoculated with a suspension of *Nosema apis* in a 10 per cent sugar (saccharose) solution, which had been allowed to ferment, at room temperature.

TABLE XIII.—Resistance of *Nosema apis* to fermentation in sugar solution at room temperature.

Date of inoculation.	Time of fermentation.		Results of inoculation.
	Months.	Days.	
Sept. 8, 1915.....	0	5	Nosema infection produced.
Sept. 9, 1915.....	0	6	Do.
June 4, 1915.....	0	11	No infection produced.
Sept. 10, 1915.....	0	7	Do.
July 27, 1915.....	0	8	Do.
July 29, 1915.....	0	10	Do.
Sept. 13, 1915.....	0	10	Do.
Sept. 15, 1915.....	0	12	Do.
Sept. 16, 1915.....	0	13	Do.
Sept. 1, 1915.....	0	14	Do.
Jan. 9, 1915.....	0	18	Do.
Sept. 15, 1914.....	0	21	Do.
Sept. 29, 1914.....	0	34	Do.
June 9, 1914.....	7	12	Do.
June 10, 1914.....	10	6	Do.
May 13, 1915.....	18	6	Do.

From Table XIII it will be seen that the parasite was destroyed by fermentation in a 10 per cent sugar solution at room temperature in from 7 to 11 days. The range of variation shown may be attributed largely to variation in the temperature.

FERMENTATION AT OUTDOOR TEMPERATURE.

In Table XIV are summarized experiments made for the purpose of obtaining approximate data relative to the resistance of *Nosema apis* in a 20 per cent honey solution at outdoor temperature.

TABLE XIV.—Resistance of *Nosema apis* to fermentation in a honey solution at outdoor temperature.

Date of inoculation.	Period of fermentation.	Results of inoculation.
	Days.	
July 26, 1916.....	2	Nosema infection produced.
July 27, 1916.....	3	Do.
July 28, 1916.....	4	Do.
Sept. 8, 1915.....	5	Do.
July 29, 1916.....	5	Do.
Aug. 30, 1916.....	6	Do.
July 29, 1916.....	7	Do.
Aug. 31, 1916.....	7	Do.
Sept. 2, 1916.....	9	No infection produced.
Sept. 6, 1916.....	12	Do.

From Table XIV it will be observed that the parasite was destroyed in 9 days in the presence of fermentation processes taking place in a 20 per cent honey solution at outdoor temperature.

At refrigerator temperature it was found that *Nosema apis* resisted fermentative processes for more than seven and less than nine days.

It will be observed from the results obtained that *Nosema apis* in the presence of fermentative processes is destroyed in a comparatively short time. The period, it will be seen, varies somewhat with the temperature of the fermenting suspension. The experiments tend to indicate, furthermore, that the time element depends slightly upon the nature of the fermenting medium, the germ being destroyed sooner in a honey solution than in a saccharose one. The time element is dependent also upon the strength of the solutions employed.

RESISTANCE OF NOSEMA APIS TO PUTREFACTION.

Experiments have been made for the purpose of obtaining results relative to the resistance possessed by *Nosema apis* to putrefactive processes. The nature of the experiments was similar to those relative to fermentation but instead of sugar solutions used for the suspensions a 1 per cent peptone solution in water was employed. In the experiments, suspensions, after undergoing putrefactive changes at incubator, room, outdoor, and refrigerator temperatures, respectively, were used in the inoculation of colonies.

PUTREFACTION AT INCUBATOR TEMPERATURE.

The experiments summarized in Table XV indicate the resistance of *Nosema apis* to putrefaction at incubator temperature.

TABLE XV.—Resistance of *Nosema apis* to putrefaction at incubator temperature.

Date of inoculation.	Period of putrefaction.	Results of inoculations.
	<i>Days.</i>	
July 25, 1916.....	1	Nosema infection produced.
July 26, 1916.....	2	Do.
July 27, 1916.....	3	Do.
July 28, 1916.....	4	Do.
July 12, 1916.....	5	No infection produced.
Sept. 10, 1915.....	7	Do.
July 15, 1916.....	8	Do.
July 17, 1916.....	10	Do.

By the results recorded in Table XV it is shown that *Nosema apis* was destroyed by putrefaction at incubator temperature in five days.

PUTREFACTION AT ROOM TEMPERATURE.

In Table XVI are summarized experiments in which the putrefactive processes took place at room temperature.

TABLE XVI.—Resistance of *Nosema apis* to putrefaction at room temperature.

Date of inoculation.	Period of putrefaction.	Results of inoculation.
	<i>Days.</i>	
July 28, 1915.....	12	Nosema infection produced.
July 21, 1915.....	18	No infection produced.
July 28, 1915.....	25	Do.
Sept. 29, 1914.....	34	Do.
July 1, 1915.....	40	Do.
Aug. 20, 1914.....	52	Do.

From Table XVI it is seen that *Nosema apis* at room temperature resisted the putrefactive processes for about two weeks. As the room temperature varies it is to be expected that the time required for the destruction of the parasite will vary also.

PUTREFACTION AT OUTDOOR TEMPERATURE.

The following table summarizes experiments that indicate the period *Nosema apis* resists putrefaction at outdoor temperature:

TABLE XVII.—Resistance of *Nosema apis* to putrefaction at outdoor temperature.

Date of inoculation.	Period of putrefaction.	Results of inoculation.
	<i>Days.</i>	
July 26, 1916.....	2	Nosema infection produced.
July 27, 1916.....	3	Do.
July 28, 1916.....	4	Do.
July 29, 1916.....	5	Do.
Aug. 31, 1916.....	7	Do.
Sept. 2, 1916.....	9	Do.
Sept. 6, 1916.....	12	Do.
Aug. 26, 1916.....	15	Do.
Sept. 2, 1916.....	22	Do.

In the experiments recorded in Table XVII it will be observed that *Nosema apis* was not destroyed in the presence of putrefactive changes at outdoor temperature in 22 days.

At refrigerator temperature the parasite has resisted putrefaction for more than three months.

The foregoing experiments relative to the effect of putrefactive processes on *Nosema apis* show that the parasite may be destroyed as a result of putrefaction. They show also that the temperature of the suspension is a factor in determining the period of resistance. Furthermore, it is seen that the germ resists the destructive processes accompanying putrefaction longer than those accompanying fermentation.

RESISTANCE OF NOSEMA APIS TO DIRECT SUNLIGHT.

RESISTANCE WHEN DRY.

Petri dishes (fig. 6) which were smeared with the crushed stomachs of *Nosema*-infected bees were exposed to the direct rays of the sun.

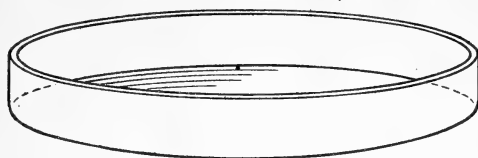

FIG. 6.—Open Petri dish. One-half of the dish, either top or bottom.

After intervals reckoned in hours healthy colonies were inoculated with a suspension made from the dishes which had been exposed. Table XVIII summarizes the experiments and the results obtained.

TABLE XVIII.—Resistance of *Nosema apis* when dry to direct sunlight.

Date of inoculation.	Period of exposure to sun.	Results of inoculation.
	<i>Hours.</i>	
Aug. 2, 1915.....	2	<i>Nosema</i> infection produced.
Aug. 21, 1914.....	5	Do.
Aug. 2, 1915.....	5	Do.
July 28, 1915.....	8	Do.
Aug. 27, 1914.....	10	Do.
Aug. 23, 1915.....	13	Do.
Aug. 20, 1915.....	15	Do.
Sept. 2, 1914.....	15	Do.
Aug. 25, 1915.....	17	Do.
Sept. 3, 1914.....	20	Do.
Sept. 14, 1915.....	29	Do.
Aug. 17, 1915.....	15	No infection produced.
Sept. 10, 1915.....	17	Do.
Aug. 19, 1915.....	18	Do.
Sept. 11, 1915.....	21	Do.
Aug. 24, 1914.....	22	Do.
Sept. 13, 1915.....	32	Do.
Aug. 4, 1914.....	34	Do.
Sept. 16, 1915.....	35	Do.

The results in Table XVIII show that *Nosema apis* was destroyed in the experiments recorded in from 15 to 32 hours' exposure to direct sunlight.

It will be readily appreciated that the time that *Nosema apis* will resist the destructive effects of the sun's rays will vary largely according to the intensity of the rays, the heat present, and the thickness of the layer of infective material exposed.

DESTRUCTION IN WATER.

In experiments made for the purpose of determining the time required to destroy *Nosema apis* suspended in water, an aqueous suspension of the crushed stomachs of about 10 bees was poured into each of a number of Petri dishes (fig. 6) and exposed to the direct

rays of the sun. The top of the dish was not on during the exposure. After intervals reckoned in hours inoculations were made of healthy colonies, the germs contained in one dish being used.

Table XIX gives a summary of a set of experiments of this kind.

TABLE XIX.—Resistance of *Nosema apis* suspended in water to the direct rays of the sun.

Date of inoculation.	Period of exposure.	Results of inoculation.
	<i>Hours.</i>	
Aug. 2, 1915.....	2	Nosema infection produced.
July 27, 1915.....	10	Do.
Aug. 20, 1915.....	12	Do.
Do.....	18	Do.
Aug. 26, 1915.....	20	Do.
Sept. 10, 1915.....	20	Do.
Aug. 27, 1915.....	27	Do.
Sept. 11, 1914.....	27	Do.
Sept. 13, 1915.....	44	Do.
Do.....	37	No infection produced.
Sept. 14, 1915.....	51	Do.
Sept. 16, 1915.....	58	Do.
Do.....	65	Do.
Sept. 17, 1915.....	72	Do.

The results in the foregoing table show that *Nosema apis* was destroyed by the direct rays of the sun in from 37 to 51 hours. It is seen, therefore, that *Nosema apis* when suspended in water shows a considerable amount of resistance. In the question of the transmission of the disease this resistance may be of considerable importance.

At the time these experiments were made the intensity of the rays was, as a rule, quite marked and, therefore, favorable for the destruction of germs. The temperature of the aqueous suspension, however, did not reach 136° F. (58° C.) and, therefore, was not sufficient to destroy the virus through heating. Some of the suspensions stood for more than a week in the Petri dishes, thereby introducing the factors of fermentation and putrefaction. The effect of these factors on the results is not known.

DESTRUCTION IN HONEY.

In performing the experiments crushed stomachs from about 10 *Nosema*-infected bees were suspended in about 3 ounces of honey in Petri dishes (fig. 7). To prevent robbing by bees the dish was used with the top on. The suspension was exposed to the direct rays of the sun with the dishes resting on a wooden support. After different intervals healthy colonies were inoculated with germs which had been exposed to the sun.

Even when resting on a wooden support it is not unusual during the summer for the honey of the suspension exposed to the sun to reach a temperature beyond the thermal death point of the parasite. To determine facts in regard to the effect of the sun's rays on *Nosema apis*, therefore, this point in regard to heat must be met by the technique employed. This could have been done quite easily but for the lack of time.

In the experiments it was found that *Nosema apis* was destroyed in all instances in which the temperature of the honey reached or exceeded 140° F. (60° C.), a temperature at which the germ is killed by heat (p. 30). Sufficient data, therefore, have not been obtained to warrant a definite conclusion regarding the time required for the

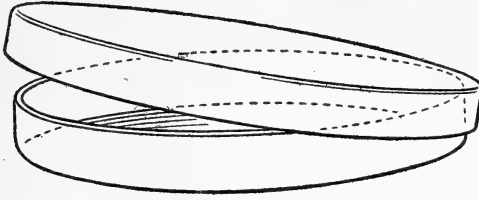

Fig. 7.—Petri dish. The top half is slightly raised. Those used here are 4 inches in diameter.

direct sunlight to destroy *Nosema apis* suspended in honey. The results obtained from the experiments made in which aqueous suspensions were exposed to the sun give some idea as to the probable approximate time which would be required.

PERIOD NOSEMA APIS REMAINS VIRULENT.

PERIOD IN HONEY.

In experiments made to determine the length of time *Nosema apis* remains virulent in honey a suspension of the parasite in honey was distributed in flasks, about one-half pint being poured into each flask. These were placed at room temperature and shielded from the light. After different intervals colonies were inoculated, the suspension from a single flask being used. The results obtained are included in Table XX.

TABLE XX.—Period *Nosema apis* remains virulent in honey.

Date of inoculation.	Period in honey.		Results of inoculation.
	Months.	Days.	
Oct. 20, 1914.....	1	0	Nosema infection produced.
Feb. 4, 1915.....	1	18	Do.
Feb. 24, 1915.....	2	0	Do.
Feb. 4, 1915.....	3	10	Do.
Jan. 16, 1915.....	3	27	Do.
July 14, 1915.....	2	6	No infection produced.
July 23, 1915.....	2	15	Do.
Oct. 21, 1915.....	2	25	Do.
June 11, 1915.....	3	5	Do.
Sept. 3, 1915.....	3	17	Do.
June 24, 1915.....	3	20	Do.
Oct. 21, 1915.....	3	21	Do.
July 24, 1916.....	4	4	Do.
Aug. 14, 1913.....	5	0	Do.
May 1, 1915.....	7	17	Do.
June 9, 1914.....	7	19	Do.
Apr. 27, 1915.....	9	7	Do.
May 5, 1914.....	9	19	Do.
July 26, 1916.....	12	0	Do.

The experiments summarized in Table XX show from the results recorded that *Nosema apis*, when suspended in honey and kept at room temperature, shielded from the light, remained virulent for from 66 to 124 days, that is, from 2 to 4 months. The wide variation noted here probably is due very largely to the variation in temperature of the honey suspension.

PERIOD IN DEAD BEES.

Among the factors tending to destroy *Nosema apis* within the remains of dead bees are drying, putrefaction, and probably fermentation. The temperature also is to be expected to vary the period of resistance. In conducting the experiments, therefore, incubator, room, outdoor, and refrigerator temperatures were used. Infected bees were killed and kept in these different environments. After different intervals suspensions were made in sirup, the crushed bodies of from 5 to 10 of the infected bees being used. Colonies were inoculated with the suspensions.

AT INCUBATOR TEMPERATURE.

Table XXI summarizes the results obtained when inoculations were made with suspensions of *Nosema*-infected material from bodies of bees kept at incubator temperature.

TABLE XXI.—Resistance of *Nosema apis* within dead bees at incubator temperature (37.5° C.).

Date of inoculation.	Period of drying.	Results of inoculation.
	<i>Days.</i>	
Apr. 9, 1916.....	2	<i>Nosema</i> infection produced.
Apr. 12, 1916.....	4	Do.
Apr. 14, 1916.....	6	Do.
June 27, 1916.....	7	No infection produced.
July 1, 1916.....	12	Do.
May 17, 1916.....	15	Do.
Aug. 4, 1915.....	16	Do.
Oct. 8, 1914.....	18	Do.
Aug. 8, 1915.....	21	Do.
Aug. 17, 1915.....	28	Do.
Oct. 19, 1915.....	30	Do.
Aug. 23, 1915.....	35	Do.
Aug. 6, 1914.....	38	Do.
Nov. 2, 1914.....	42	Do.

By the results recorded in the experiments summarized in Table XXI, it was shown that *Nosema apis* in the bodies of dead bees kept at incubator temperature ceased to be virulent in less than one week.

AT ROOM TEMPERATURE.

In Table XXII are summarized the experiments in which dead bees, kept at room temperature, furnished the *Nosema*-infected material for the suspensions used in the inoculations.

TABLE XXII.—*Resistance of Nosema apis in dead bees kept at room temperature.*

Date of inoculation.	Period of drying.	Results of inoculation.
	<i>Days.</i>	
Aug. 4, 1915.....	16	Nosema infection produced.
Aug. 10, 1915.....	21	Do.
July 17, 1916.....	28	Do.
Aug. 26, 1916.....	30	Do.
Aug. 17, 1916.....	28	No infection produced.
June 3, 1916.....	32	Do.
Aug. 23, 1915.....	35	Do.
July 26, 1916.....	36	Do.
Aug. 1, 1916.....	43	Do.
June 27, 1916.....	56	Do.
Aug. 20, 1914.....	111	Do.
Aug. 30, 1914.....	168	Do.

From Table XXII it is learned that when dead infected bees were kept at room temperature the parasite remained virulent for three or four weeks, but did not produce the disease after one month. Since the temperature of the room was not constant, variations in results obtained at this temperature are to be expected.

AT OUTDOOR TEMPERATURE.

Dead *Nosema*-infected bees were placed in a hive body standing in the experimental apiary. At different intervals suspensions were made and colonies were inoculated. In Table XXIII are summarized a few experiments indicating by the results obtained the approximate period *Nosema apis* remains virulent in the body of dead bees at outdoor temperature.

TABLE XXIII.—*Resistance of Nosema apis in dead bees drying at outdoor temperature.*

Date of inoculation.	Period of drying.	Results of inoculation.
	<i>Days.</i>	
Oct. 19, 1914.....	28	Nosema infection produced.
Aug. 23, 1915.....	35	Do.
Nov. 2, 1914.....	42	Do.
June 7, 1916.....	36	No infection produced.
June 27, 1916.....	56	Do.
July 17, 1916.....	76	Do.

From Table XXIII it is seen that *Nosema apis* in the bodies of dead infected bees kept dry at outdoor temperature remained virulent for from five to six weeks. These experiments extended over a period from June to November, as shown by the dates. It is to be expected that if they had been conducted throughout the year the results obtained would have shown a much wider range of variation.

AT REFRIGERATOR TEMPERATURE.

In Table XXIV are summarized experiments the results of which indicate the approximate period during which *Nosema apis* remains virulent in the bodies of infected bees kept at refrigerator temperature.

TABLE XXIV.—Resistance of *Nosema apis* in dead bees drying at refrigerator temperature.

Date of inoculation.	Period in refrigerator.	Results of inoculation.
	<i>Months.</i>	
Mar. 4, 1916.....	2	Nosema infection produced.
Mar. 20, 1916.....	2	Do.
Mar. 20, 1916.....	2½	Do.
Apr. 22, 1916.....	3	Do.
May 6, 1916.....	3½	Do.
Dec. 7, 1915.....	3	No infection produced.
Jan. 7, 1916.....	4	Do.
May 24, 1916.....	4	Do.
June 3, 1916.....	4	Do.
Feb. 10, 1916.....	5	Do.
Apr. 7, 1916.....	6	Do.
May 6, 1916.....	8	Do.
July 3, 1916.....	10	Do.

The results recorded in Table XXIV show that *Nosema apis* in the bodies of dead infected bees remained virulent at refrigerator temperature from two and a half to four months.

ON THE SOIL.

Dead *Nosema*-infected bees were placed on the soil in the open, but in a somewhat shaded spot. After different intervals of time colonies were inoculated, these dead bees being used as the source for the infective material. Table XXV summarizes the experiments performed, the results of which indicate the approximate period during which *Nosema apis* remains virulent in the bodies of dead bees lying on the soil.

TABLE XXV.—Resistance of *Nosema apis* in dead bees lying on the soil.

Date of inoculation.	Period on soil.	Results of inoculation.
	<i>Days.</i>	
July 16, 1915.....	13	Nosema infection produced.
Aug. 1, 1916.....	18	Do.
Aug. 28, 1915.....	25	Do.
Aug. 12, 1916.....	29	Do.
Aug. 26, 1916.....	43	Do.
Aug. 28, 1915.....	44	Do.
May 14, 1916.....	71	No infection produced.
Oct. 4, 1915.....	77	Do.
Oct. 21, 1915.....	85	Do.
Oct. 21, 1915.....	94	Do.
Oct. 4, 1915.....	104	Do.
Nov. 9, 1915.....	104	Do.

From the results recorded in Table XXV it is seen that when the dead *Nosema*-infected bees were allowed to remain on the soil exposed to outdoor conditions *Nosema apis* was virulent at the end of 44 days, but the germ had lost its virulence before 71 days. Results of experiments having the nature of those referred to in this table naturally depend largely upon the climatic conditions which prevail.

It was observed that insects, ants especially, fed upon the dead bees lying on the ground. In this way they removed much of the material containing the parasites. This fact must be borne in mind in a consideration of the length of time that bees dead of *Nosema* disease and lying on the soil might serve as a possible source of infection.

The five foregoing groups of experiments relative to the period during which *Nosema apis* remains virulent in the bodies of dead infected bees show that the period varies with the environment under which the bees are kept, the temperature being an important factor in causing the variation. It is interesting to note that under fairly favorable conditions for its preservation *Nosema apis* remains virulent within the bodies of dead infected bees only three months, while under less favorable conditions its destruction occurs in a much shorter period.

INFECTIOUSNESS OF BROOD-COMBS FROM NOSEMA-INFECTED COLONIES.

Experiments have been made for the purpose of obtaining data relative to the likelihood of the transmission of *Nosema* disease from colony to colony through the medium of brood-combs. Brood-combs on which colonies had died of the disease and others taken from colonies heavily infected with *Nosema apis* through experimental inoculation were inserted into healthy colonies after different periods of time had elapsed following their removal. Table XXVI gives a summary of experiments made and the results obtained.

TABLE XXVI.—Results from insertion of brood-combs from *Nosema*-infected colonies into healthy ones.

Date combs were inserted.	Period combs were stored.	Number of combs inserted.	Results of inoculation.
Apr. 20, 1915.....	Inserted im- mediately.	4	No <i>Nosema</i> infection pro- duced.
Do.....	do.....	3	Do.
Apr. 26, 1915.....	do.....	3	Do.
July 3, 1915.....	do.....	3	Do.
May 19, 1916.....	do.....	1	Do.
Apr. 26, 1915.....	$\frac{1}{2}$ month.....	3	Do.
Do.....	do.....	3	Do.
Apr. 24, 1915.....	1 month.....	2	Do.
June 18, 1914.....	2 months.....	2	Do.
June 29, 1914.....	do.....	2	Do.
Apr. 24, 1915.....	3 months.....	2	Do.
May 1, 1915.....	do.....	2	Do.
Aug. 22, 1914.....	4 months.....	2	Do.
May 19, 1916.....	6 months.....	1	Do.

As will be observed from Table XXVI, infection did not occur in any of the experiments in which brood-combs from *Nosema*-infected colonies were given to healthy ones. The practical import of the results is that brood-combs from *Nosema*-infected colonies need not be destroyed, but may be inserted without treatment into hives containing healthy bees with practically no fear that losses will result from such manipulation. (See also experiment No. 2, p. 25.)

RESISTANCE OF NOSEMA APIS TO CARBOLIC ACID.

Stomachs taken from *Nosema*-infected bees were crushed and suspended in aqueous solutions of carbolic acid (commercial). One, 2, and 4 per cent solutions were used. These suspensions, respectively, were distributed in test tubes and were allowed to stand at room temperature. After different intervals healthy colonies were inoculated, the suspension from a single tube being used for each.

A summary of experiments performed with the results obtained is given in Table XXVII.

TABLE XXVII.—*Effect of carbolic acid on Nosema apis.*

Date of inoculation.	Per cent of carbolic-acid solution.	Period in carbolic acid.		Results of inoculation.
		Hours.	Minutes.	
Aug. 18, 1915.....	1	0	10	No infection produced.
July 16, 1915.....	1	1	0	Do.
July 2, 1915.....	1	6	0	Do.
June 9, 1915.....	1	51	0	Do.
Aug. 18, 1915.....	2	0	10	Do.
July 16, 1915.....	2	1	0	Do.
July 2, 1915.....	2	6	0	Do.
June 8, 1915.....	2	27	0	Do.
July 16, 1915.....	4	1	0	Do.
July 2, 1915.....	4	5	0	Do.
June 8, 1915.....	4	27	0	Do.

From the preliminary results given in Table XXVII it will be noted that *Nosema apis* is rapidly destroyed in 1, 2, and 4 per cent aqueous solutions, respectively, of carbolic acid, showing that the parasite possesses very slight resistance to the disinfectant.

EFFECT OF DRUGS ON NOSEMA-DISEASE.

It is natural that beekeepers should have thought of drugs and employ them in the treatment of *Nosema* infection. Preliminary experiments have been made to obtain data relative to the effect of betanaphthol, salol (phenyl salicylate), carbolic acid (phenol), salicylic acid, formic acid, oil of eucalyptus, and quinin (bisulphate of quinin) on this infection. It will be recalled that most of these drugs have been given a trial from time to time by beekeepers in the treatment of one or more of the bee diseases.

In the experiments honey was diluted with an equal quantity of water and medicated.¹ To the medicated solution *Nosema apis* was added. This suspension was fed to a colony, usually within a half hour from the time it was made. On each of four or five days immediately following the inoculation, the colony was fed honey medicated with the drug but free from *Nosema apis*.

In Table XXVIII are summarized the experiments performed, together with the results obtained.

TABLE XXVIII.—Effect of drugs on *Nosema* infection.

Drug.	Experiment 1.		Experiment 2.		Experiment 3.		Experiment 4.	
	Proportion.	Results.	Proportion.	Results.	Proportion.	Results.	Proportion.	Results.
Betanaphthol.....	2:1,000	No infection.	1:1,000	No infection.	1:2,000	No infection.	1:5,000	Infection.
Salol.....	2:1,000	...do....	1:1,000	...do....	1:2,000	...do....	1:5,000	Do.
Salicylic acid.....	2:1,000	...do....	1:1,000	...do....	1:2,000	Infection.	1:5,000	Do.
Carbolic acid.....	3:1,000	...do....	2:1,000	...do....	1:1,000	...do....
Formic acid.....	3:1,000	...do....	2:1,000	...do....	1:1,000	...do....
Eucalyptus.....	5:1,000	Infection.	4:1,000	Infection.	2:1,000	...do....
Quinin.....	10:1,000	...do....	4:1,000	...do....	2:1,000	...do....

The results recorded in Table XXVIII show that the parasite was destroyed by some of the drugs used but that it resisted others. Their relative efficiency as indicated from these preliminary results is shown by the arrangement in the table. Betanaphthol and salol seem to be the most effective of those tried, and eucalyptus and quinin the least efficient.

Experiments were performed in which the inoculation with *Nosema apis* was not followed by feedings with medicated sirup. The results obtained show that under the conditions of the experiments the drugs affected the parasite as seen by the lower percentage of *Nosema*-infected bees in the colonies inoculated. In colonies receiving subsequent feedings of medicated sirup a still lower percentage of infected bees was found.

While it is thus established that *Nosema apis* is somewhat susceptible to the effects of some of the drugs, the experiments are altogether too few for definite conclusions as to the extent of their action. Statements regarding the effect of the drugs on *Nosema*-disease, therefore, should be accepted cautiously, for the present at least, unless they are supported by experimental or other good evidence.

¹ In obtaining the desired proportion of the drug, betanaphthol, salol, salicylic acid, and eucalyptus were dissolved in alcohol. In the case of carbolic acid, formic acid, and the bisulphate of quinin aqueous solutions of the drugs were employed.

MODES OF TRANSMISSION OF NOSEMA-DISEASE.

No problem in the study of Nosema-disease is more important than that of its transmission. The problem is at the same time one of the most difficult for complete solution. While further information is still much desired, yet it is possible from the studies which have been made to arrive at certain conclusions concerning the manner in which the disease is spread. The discussions which follow are based chiefly upon observations noted in the foregoing pages.

It is naturally safe to conclude that the transmission of Nosema-disease depends directly upon the transmission of the parasite that causes it. If the course of *Nosema apis* in nature were followed completely, therefore, the problem relative to the spread of the disease would be solved. Such a task is difficult, as the possible sources for the parasite and the accompanying conditions are various.

The fact, determined experimentally, that a suspension of *Nosema apis* in sirup when fed to bees will produce the disease shows quite conclusively that infection takes place through the ingestion of the parasite. At present there is no evidence that it takes place otherwise than by way of the alimentary tract. This leads to the important tentative conclusion that the transmission of the disease is effected through either the food or the water supply of bees, or both.

On reaching the stomach by ingestion the parasite begins its growth, invades the walls of the organ, multiplies enormously, and forms spores which are shed into the lumen and passed out of the alimentary tract with the excrement. The chances that any single parasite once outside the bee will be ingested and cause infection are very slight. The immense number that are produced, however, increases the chances very greatly. Again, the chances of infection are very much reduced by the many destructive agencies in nature encountered by the parasite. Among these are drying (p. 31), heat (p. 29), direct sunlight (p. 37), fermentation (p. 33), and putrefaction (p. 35).

The excrement is voided normally during flight and most often soon after the bee leaves the hive. Should the droppings from infected bees fall into a body of water, such water would become thereby contaminated with the Nosema parasite and the use of it by bees would expose them to infection. Should the body of water be a rapidly flowing one, naturally the chances that other colonies of the apiary might become infected from such a source would be less than if it were a sluggish one. Should such contaminated water be exposed to the sun, the rays of the latter would have a tendency to destroy the parasites. The resistance of *Nosema apis* to the destructive effects of the sun's rays (p. 38) are sufficiently great, however, that there would still remain a strong likelihood that infection might take place from the water supply. While in the water

the parasites may be subjected to fermentation or putrefaction or both. These factors would tend to destroy the germ, although its resistance under these conditions is again considerable.

It has been suggested by some writers that drops of water from showers or dew on vegetation about the apiary might become contaminated by excrement present and thus be a source of infection. This would seem to be a possibility. The extent, if any, to which the disease is thus transmitted is not yet known.

Should the excrement of infected bees fall on the soil, the chances, ordinarily, would be slight that the contained parasite would reach a bee and infect it. Should the surface water resulting from rains carry the germ into a water supply used by bees, the chances of infection from the soil as a source would be considerably increased thereby. If the bodies of dead Nosema-infected bees were washed into the water supply, contamination of it might follow.

In estimating the probable danger of infection from the bodies of bees dead of Nosema-disease, the possibility of the parasites being destroyed after the death of such bees through putrefaction (p. 35), drying (p. 31), or other means must be given due consideration.

The facts which are known concerning Nosema-disease indicate that the disease may be transmitted: (1) From the infected bees of a colony to healthy bees of the same colony, and (2) from the infected bees of a colony to healthy bees of another colony. When the infection is transmitted from infected bees to noninfected ones of the same colony, the question arises as to whether such infection takes place while the bees are within or without the hive. The fact that the heaviest infection with *Nosema apis* occurs in the spring of the year, and the further fact that only a comparatively few colonies of the apiary are likely to be heavily infected, support the tentative conclusion that the transmission of the germ takes place within the hive rather than from a source outside of it.

There are facts concerning the disease, however, which indicate that the infection under certain circumstances is not readily transmitted within the hive. For example, colonies which in the spring of the year show less than 50 per cent of Nosema-infected bees are likely to recover from the infection without treatment, showing that under such circumstances the infection is not transmitted within the hive, to any great extent at least. The fact that a colony may contain a small percentage of Nosema-infected bees throughout the year and not become heavily infected at any time furnishes further evidence that Nosema infection does not always spread with rapidity within the hive. It has been found that colonies becoming heavily infected through experimental inoculation in June, July, or August, are practically free from the infection within six weeks from the date of inoculation, showing again that the infection is not always readily transmitted within the hive.

Colonies may die out, or they may only become weakened by the disease. Each of these conditions invites robbing, which in a certain number of cases probably results in the transmission of the disease. The likelihood of the transmission of the disease through robbing, however, seems to be not nearly as great as in the case of the foul-broods.

Uninoculated colonies in the experimental apiary have always remained practically free from infection, although colonies heavily infected as the result of experimental inoculations were present. This fact suggests that very little infection, if any, results either from the visit of healthy bees to flowers previously visited by infected ones, or, furthermore, from the straying or drifting of bees from infected to healthy colonies.

The possibility that the queen may be infected and that infection will be transmitted by her to the other bees of the colony need give the apiarist no uneasiness, and no concern need be felt that drones will spread the disease in the apiary.

Fear that *Nosema*-infection might be transmitted by hives which have housed infected colonies need not be entertained; neither is it to be feared that the hands or clothing of the beekeepers, or the tools used about an apiary, will serve as means for the transmission of the disease. Furthermore, the spread of the disease is not to be attributed directly to winds.

Theoretically it would seem that combs from *Nosema*-diseased colonies, if inserted into a healthy colony, would be the means of transmitting the disease and that the danger would extend over a period of a few weeks or months (p. 39). Experimentally it is shown, however, that such combs can be inserted immediately without transmitting the disorder, at least appreciably (p. 43).

Evidence is yet to be obtained to prove that insects other than honeybees are susceptible to infection with *Nosema apis*. A few experiments made in which silkworms, maggots, and ants were inoculated with this parasite gave negative results. At the present time, therefore, there is no cause for fear that *Nosema*-disease will be transmitted as the result of a similar infection in other insects.

DIAGNOSIS OF NOSEMA-DISEASE.

Nosema-disease usually can be diagnosed from the colony symptoms present together with the gross appearance of stomachs removed from adult bees of the colony.

Weakness, especially in the spring of the year, should cause a suspicion that the disease is present. The suspicion is strengthened if in such a colony the brood in general is normal, if the adult bees are not noticeably different in outward appearance or behavior from bees of healthy colonies, if the queen is present and if stores are abundant.

While the colony symptoms may justify a very strong suspicion that the disease is present, an examination of the stomachs from adult bees of the colony is necessary in making a definite diagnosis. The selection of the proper sample for examination is important. In choosing samples it is advisable to take such bees as are most likely to show a high percentage *Nosema*-infected. Young workers, old shiny ones, and drones are, therefore, to be avoided. Workers from the field are naturally to be preferred. As bees carrying pollen are most readily recognized as being field bees, these are the ones usually sought. Sometimes it is more convenient to take bees carrying honey or water. Next to the field bees, preference should be had for bees from among those about the entrance of the hive. During the colder seasons of the year it is often necessary to take the samples from the brood-combs.

Ten bees from a colony constitute a satisfactory sample as a rule. Ordinarily these are taken at the entrance with forceps. They are killed by pinching the thorax. All of the bees of the sample should be examined.

In removing the stomach for examination the bee is held by the thorax between the thumb and index finger of one hand and with a pair of forceps held in the other the tip of the abdomen is seized and pulled gently. By this method the organs of the alimentary tract (Pl. I) forward to and including the stomach are easily obtained. Occasionally the proventriculus and honey sac are also removed by this procedure. The stomach is the most prominent of the organs removed and the one that is most readily recognized.

If the stomach upon removal appears swollen and lighter in color than a healthy one, *Nosema* infection may be suspected; if it is chalk-white and easily torn, infection is very probable; should the tissues of the organ when crushed be milky in appearance, infection is practically certain. Usually the gross examination is sufficient for a definite diagnosis of the disease as encountered in nature. Sometimes it is desirable however, to have such a diagnosis confirmed by a microscopic examination of the crushed tissues of the stomach. This is often the case in experimental studies.

If infection is present in a bee the oval glistening spores of the parasite (fig. 4) usually will be found in very large numbers upon a microscopic examination of the crushed tissues of the stomach. No staining is needed. Addition of water to the mount is not necessary but it improves the preparation, permitting the spores to be seen more distinctly. Stomachs which become dry, after their removal and before the examination is made, can be used readily by the addition of water.

Very few objects are encountered in the microscopic examination of the stomachs that are likely to be mistaken for the spores of *Nosema apis*. Occasionally yeasts are encountered. They occur, however, in small numbers only, as a rule; a variation in size is usually to be observed; and if stained they take the stain readily and intensely. The writer occasionally has encountered small oval bodies resembling spores which escape from pollen grains. They are found in comparatively small numbers when encountered, however, and are smaller than *Nosema* spores. What these bodies are has not been determined.

In examining bees that have been dead of *Nosema*-disease for some time a portion of the contents of the abdomen is suspended in water on a slide and examined microscopically. The highly refractive oval spores of the parasite will be found if the bee was *Nosema* infected at the time of its death. Younger stages of the parasite will not be encountered under these conditions.

Stages of the parasite that precede that of the spores may be recognized at times from fresh preparations. Forms approaching spores in appearance, which have been referred to as young spores, together with growing or vegetative forms appearing frequently as though they were in pairs (Pl. III, I), are seen occasionally. These younger forms are not likely to be recognized in preparations except in those made from bees recently killed and then only in small numbers. They should not be depended upon in the making of the diagnosis.

To determine very early stages of infection with *Nosema apis* the stomach of the suspected bee must be fixed, sectioned, and stained by laboratory methods.¹ The parasite is then found in the epithelial cells of the organ.

Nosema-disease, like sacbrood, is quite prevalent among bees, and like sacbrood a small amount of infection may be present in a colony without producing any appreciable loss. When a diagnosis of the disease is being made in practical apiculture, therefore, considerable caution should be observed. A colony showing only a small percentage of *Nosema*-infected bees and no other evidence of the disease is practically healthy. In reporting the presence of infection it would seem well to indicate in some way the amount of infection present. The percentage of infected bees among those examined might be given.

¹As a fixing fluid one containing a strong solution of mercuric chlorid can be recommended in studies on *Nosema apis*. Heidenhain's iron hematoxylin is a very satisfactory stain for much of the work. Other fixers, especially those containing picric acid or formalin, have been used successfully. The spores of *Nosema apis* are not readily stained by all stains. Pyronin sometimes gives good results with methyl green as a counterstain. Alcoholic eosin applied for a considerable period, with methyl blue as a counterstain, used on fixed smears made from fresh tissues, often results in desirable preparations.

In expressing a positive diagnosis the degree of infection could be indicated, for the present at least, by the terms "slight," "moderate," "heavy," and "very heavy." Slight infection by this scheme would indicate that not more than 10 per cent of the bees are infected and that no noticeable loss is to be anticipated from the infection; moderate infection would indicate that from 10 to 35 per cent are infected, that the colony will probably sustain losses from the disease, but that the chances are good for recovery; heavy infection would indicate that from 30 to 60 per cent are infected, that the colony will most likely show weakness as a result of the disease, and that it may or may not die; and very heavy infection would indicate that more than 60 per cent are infected and that the colony will probably die as a result of the disease.

While a definite diagnosis in regard to Nosema infection can always be made by laboratory methods (McCray and White, 1918), beekeepers in most instances can diagnose the disease sufficiently well for practical purposes in the apiary. Weakness should cause suspicion. If there is no other obvious cause for the weak condition a strengthened suspicion is justified. If, upon the removal of the stomachs of a few field bees (at least 10 should be examined), some white stomachs are found among them, the presence of Nosema-disease is quite certain. Should there still exist a doubt the organ should be examined further. If the tissues seem to tear easily and when crushed present a milky appearance,¹ it may be concluded that the colony is Nosema infected.

DIFFERENTIAL DIAGNOSIS.

Dysentery, paralysis, palsy, spring dwindling, Isle of Wight disease, May pest, May sickness, abdominal distension, dry dysentery, dropsy, and disappearing trick are some of the many names which have been applied to disorders among adult bees. The disorders for which the names have been used have not been sufficiently well defined in all instances, however, to insure their positive diagnosis. From the facts at hand it seems probable that the number of adult diseases is small and that each disease, therefore, from time to time has had more than one name applied to it. It seems equally probable that some of the names used have been applied to more than one disease.

Although little of a definite character is known concerning the disorders of adult bees in general, Nosema-disease is such a definite condition that its differentiation from other disorders should not be difficult. It is the only adult disease that can be diagnosed positively at the present time by laboratory methods.

¹ In testing the "milky appearance," crush the suspected stomach between two plates of clear glass.

DYSENTERY.

The term "dysentery" as applied to a disorder among adult bees is found in early beekeeping literature and is still encountered frequently. The spotting of the hive which is so often referred to as a symptom of dysentery and the absence of *Nosema apis* will serve to distinguish it from Nosema-disease.

PARALYSIS.¹

The term "paralysis" has been widely used to designate a disease of adult bees. In this country the name usually is applied to a condition in which a large number of the bees of the affected colony die suddenly with the result that often a large mass of them is found in front of the hive. When this disorder is encountered usually only a colony here and there in the apiary is affected. Whether or not the disorder is infectious has not yet been determined. Time has permitted the making of only a few preliminary experiments on this disorder by the writer. The few which have been made and the facts as observed by practical beekeepers indicate that if the disease is infectious it is only slightly so. It is not likely, therefore, to spread to any great extent in the apiary. It can be differentiated from Nosema-disease by the absence of *Nosema apis* in the bees that have died of the disorder, and in the bees remaining in the colony.

SPRING DWINDLING.

It is very probable that more than one disorder has been referred to by the term "spring dwindling." When Nosema-disease was encountered by the beekeepers in the past, most likely it was often designated spring dwindling. Other conditions which are called spring dwindling may be differentiated from Nosema-disease by the fact that *Nosema apis* is present in Nosema-disease and is absent in other conditions unless, of course, a mixed infection is present.

ISLE OF WIGHT DISEASE.

There has been encountered in many parts of England a disorder among adult bees from which heavy losses have been reported. The condition was described in 1906 by the beekeepers on the Isle of Wight, where apiaries had suffered heavy losses.

Bullamore and Malden (1912), of England, after studying the symptoms of the disease, arrived at the conclusion "that no one symptom is characteristic of the Isle of Wight disease, the only essential feature being the death of large numbers of bees within or

¹ On account of the shaking or trembling movements sometimes manifested by individual bees affected, the term "palsy" has been used to designate the condition. As this term describes more accurately a marked symptom observed in the individual bee affected, it would seem to be a more appropriate one than "paralysis."

without the hive." They believed that the condition had been endemic in parts of England for many years, and shared with Graham-Smith the belief that a large amount of the losses among adult bees ascribed to it is due to Nosema infection.

From the facts at hand it is not possible to state whether the Isle of Wight disease and Nosema-disease are one and the same disorder. Studies made on the Isle of Wight disease by English workers will most likely result in revealing further valuable facts concerning it (Anderson and Rennie, 1916). The writer examined one sample of adult bees from England taken from a colony suffering from Isle of Wight disease. No spores of *Nosema apis* were found in the sample. The results of the examination naturally prove nothing regarding the disease.

For the present the American beekeeper should bear in mind that when Nosema-disease is given as the diagnosis, a condition having the destructiveness described for the Isle of Wight disease is not meant.

OTHER DISEASES OF ADULT BEES.

It is quite probable that other diseases of adult bees than those referred to here exist. If so, they have not yet been sufficiently studied to make their recognition possible, at least by laboratory methods. Such disorders could be differentiated from Nosema-disease by the absence in them of *Nosema apis*. As Nosema infection is very widely distributed among bees, the fact must always be borne in mind that Nosema infection may occur in a colony together with other bee diseases and be of secondary importance. This caution should never be overlooked.

PROGNOSIS IN NOSEMA-DISEASE.

The prognosis in Nosema-disease varies markedly and is dependent upon the conditions present. Of these conditions the percentage of Nosema-infected bees in the colony, the strength of the colony, the season of the year, and the environment of the apiary are among the more important factors which determine the outcome of the disease.

The percentage of Nosema-infected bees in the colony may be very small, much less than 1 per cent, or it may be very large, reaching practically 100 per cent. Between these limits all degrees of infection are encountered, the prognosis in each instance being different.

As a rule colonies which in the spring of the year show less than 10 per cent of Nosema-infected bees gain in strength and the losses are not detected. This is often true also in cases where the infection is somewhat greater than 10 per cent. When the number of infected bees approaches 50 per cent the colonies become noticeably weakened and in many instances death takes place. When more than 50 per

cent are infected they become weakened and usually die as a result of the infection. Generally speaking, therefore, it may be said that when a colony contains less than 10 per cent of *Nosema*-infected bees the prognosis is excellent; that when it contains more than 10 and less than 50 per cent the prognosis is fair; that when it contains more than 50 per cent the prognosis is unfavorable; and that when the number of *Nosema*-infected bees present approaches 100 per cent the prognosis is especially grave.

In arriving at a decision as to the probable course and outcome of the infection the strength of the colony must also be considered. This factor, indeed, may be the deciding one. As a rule, the stronger the colony, the more favorable is the prognosis.

In early spring heavy losses among the workers are not replaced and the colony weakens. During the active brood-rearing season, on the other hand, the bees dying of the infection are replaced by young bees. These young bees being free from infection and the transmission of the disease within the hive during summer being slight as a rule, the prognosis at this season of the year is favorable.

Experimentally it is found that a single inoculation early in the spring will cause a colony to die as a result of the infection produced; if inoculated somewhat later, however, the colony will weaken appreciably but will recover from the infection; if inoculated during the active brood-rearing season the weakening effect resulting from the infection may not be appreciable; if inoculated toward the close of the brood-rearing season the weakness resulting will be noticeable, but the colony may winter; and if inoculated later in the autumn or during the winter the colony will die as a result of the infection. It will be seen, therefore, that the prognosis in *Nosema*-disease in every case is dependent in some measure upon the season of the year, being more favorable in the active brood-rearing season than in any other. Indeed the season may play a major rôle in determining the course and outcome of the disease.

The immediate environment of the apiary may possibly play a rôle in determining the prognosis. Opportunity for reinfection from without tends to vary the course and outcome of the disease. In this connection the nature of the water supply should not be overlooked.

The extent to which the different races of bees vary in their susceptibility to the disease, the extent to which individual colonies vary in their susceptibility, and the extent to which different strains of *Nosema apis* vary as to their virulence are not at all definitely known at the present time. The facts, however, indicate that in no instance is the variation particularly great. Much care should be exercised, therefore, in ascribing variations in losses from the disease to the two phenomena virulence of the germ and resistance of the host.

Whether a bee once infected ever recovers from the infection has not yet been established definitely. From what is known of diseases in man and animals one might expect recovery in a certain percentage of Nosema-infected bees. The data at hand indicate that occasionally recovery does take place in the worker bee. This is suggested by the fact that among the last few workers alive in a colony, following a heavy infection resulting from an experimental inoculation, some have been found upon examination to be only slightly infected and still others to be free from infection. The only conclusion that can be drawn at the present time on this point is that if recovery from the infection ever takes place in the worker bee the cases are comparatively rare.

Whether the prognosis is as grave in the case of an infected queen is not known. The facts at hand suggest that it probably is not. In the writer's experience less than 50 per cent of the queens in experimental colonies were found to be infected (Table I). Whether they had been infected and had recovered was not determined. The queens from colonies which had been inoculated from one to three weeks were found to be free from infection, indicating that infection was infrequent, at least within the period that workers and drones show the greatest percentage of infection.

Death from Nosema infection does not take place for some time after infection. The length of time an infected worker lives depends in a large measure upon the season of the year. During the active bee season death takes place as a rule in less than one month but in more than two weeks. During winter the disease may run a course of two or three months or even more. Infected drones die sooner than infected workers, whereas infected queens probably live longer. This relation is to be expected since in healthy bees a somewhat similar relation exists. It is quite likely that the age of the bee when infected is not a negligible factor in determining the course of the disease.

Finally it should be emphasized that the prognosis of Nosema infection, as it occurs in the United States, is not nearly so unfavorable as has been reported for the Isle of Wight disease in England and for Nosema infection in Bavaria, Germany. It is, however, very similar to that of the infection as it has been reported from Australia (Price, 1910; Laidlow, 1911; and Beuhne, 1916).

SUMMARY AND CONCLUSIONS.

The following statements concerning Nosema-disease seem to be justified from the facts recorded in the present paper:

(1) Nosema-disease is an infectious disorder of adult bees caused by *Nosema apis*.

(2) The disease is not particularly malignant in character, being in this respect more like sacbrood than the foulbroods.

(3) Adult workers, drones, and queens are susceptible to infection, but the brood is not.

(4) The infecting agent *Nosema apis* is a protozoan that attacks the walls of the stomach and occasionally those of the Malpighian tubules.

(5) A colony can be inoculated by feeding it sirup containing the crushed stomachs of infected bees.

(6) One-tenth of the germs present in a single stomach are sufficient to produce marked infection in a colony.

(7) Within a week following the inoculation the parasite can be found within the walls of the stomach.

(8) Before the close of the second week infection can be determined by the gross appearance of the organ.

(9) The disease can be produced at any season of the year by feeding inoculations.

(10) Infected bees may be found at all seasons of the year, the highest percentage of infection occurring in the spring.

(11) Nosema infection among bees occurs at least in Australia, Switzerland, Germany, Denmark, England, Canada, and the United States. This distribution shows that the occurrence of the disease is not dependent altogether upon climatic conditions.

(12) The course of the disease is not affected directly by the character or quantity of food obtained and used by the bees.

(13) A sluggish body of water, if near an apiary and used by bees as a water supply, and the robbing of diseased colonies, must be considered for the present as two probable sources of infection.

(14) The transmission of the disease through the medium of flowers is not to be feared.

(15) The hands and clothing of the apiarist, the tools used about an apiary, and winds need not be feared as means by which the disease is spread.

(16) Hives which have housed infected colonies need not be disinfected and combs from such colonies are not a likely means for the transmission of the disease.

(17) Bees dead of the disease about the apiary are not likely to cause infection unless they serve to contaminate the water supply.

(18) *Nosema apis* suspended in water is destroyed by heating for 10 minutes at about 136° F. (58° C.).

(19) Suspended in honey, *Nosema apis* is destroyed by heating at about 138° F. (59° C.).

(20) *Nosema apis*, drying at room and outdoor temperatures, respectively, remained virulent for about 2 months, at incubator temperature about 3 weeks, and in a refrigerator about 7½ months.

(21) *Nosema apis* was destroyed in the presence of fermentative processes in a 20 per cent honey solution in 3 days at incubator temperature and in 9 days at outdoor temperature. In a 10 per cent sugar solution it was destroyed in from 7 to 11 days at room temperature.

(22) *Nosema apis* resisted putrefactive processes for 5 days at incubator temperature, for 2 weeks at room temperature, and for more than 3 weeks at outdoor temperature.

(23) *Nosema apis* when dry was destroyed in from 15 to 32 hours by direct exposure to the sun's rays.

(24) *Nosema apis* suspended in water was destroyed by exposure to the sun's rays in from 37 to 51 hours.

(25) *Nosema apis* if suspended in honey and exposed to the sun's rays frequently will be destroyed on account of the temperature of the honey which results from the exposure.

(26) *Nosema apis* remained virulent in honey for from 2 to 4 months at room temperature.

(27) *Nosema apis* in the bodies of dead bees ceased to be virulent in one week at incubator temperature, in 4 weeks at room temperature, in 6 weeks at outdoor temperature, and in 4 months in a refrigerator.

(28) *Nosema apis* in the bodies of dead bees lying on the soil ceased to be virulent in from 44 to 71 days.

(29) *Nosema apis* is readily destroyed by carbolic acid, a 1 per cent aqueous solution destroying it in less than 10 minutes.

(30) The time element which by the experiments is shown to be sufficient for the destruction of *Nosema apis* should be increased somewhat to insure their destruction in practical apiculture.

(31) The prognosis in Nosema-disease varies markedly from excellent, in case of strong colonies with a comparatively small percentage of Nosema-infected bees, to very grave, in case of weak ones with a high percentage of infected bees.

(32) From a technical point of view the results here given must be considered as being approximate only. They are, however, in most instances sufficient for practical purposes.

LITERATURE CITED.

Since 1909 numerous articles relating to Nosema-disease have appeared in the bee journals. Among these are to be found reviews of papers detailing the results of investigations which have been made on this disorder of bees. The following list of papers, together with the bibliographies contained in them, furnishes a fairly complete reference to the literature on this disease.

ANGST, H.

1913. Die Nosemakrankheit der Bienen. *In* Schweizerische Bienen-Zeitung, Aarau, n. f. Jahrg. 36, No. 3, p. 97-104, March.

ANDERSON, JOHN, and RENNIE, JOHN.

1916. Observations and experiments bearing on "Isle of Wight" disease in hive bees. *In* Proc. Roy. Phys. Soc. Edinb., Session 1915-1916, v. 20, pt. 1, p. 23-61, 1 pl.

BAHR, L.

1915. Sygdomme hos Honningbien og dens Yngel. Meddelelser fra den Kgl. Veterinær-og Landbohøjskoles Serumlaboratorium, XXXVII, 109 p., 11 fig.

Literature, p. 108-109.

1916. Die Krankheiten der Honigbiene und ihrer Brut. Hannover. 19 p. Sonder-Abdruck aus Nr. 28 u. 29 der Deutschen Tierärztlichen Wochenschrift (24 Jahrg. 1916). (Mitteilungen aus dem Serum-Laboratorium der Königlichen Dänischen Veterinär- und Landwirtschaftlichen Hochschule.

BEUHNE, F. R.

1911. Dysentery in bees and Nosema apis. *In* Jour. Dept. Agr. Victoria, Australia, v. 9, pt. 8, p. 550-551, August 10.
1913. Diseases of bees, continued. *In* Jour. Dept. Agr. Victoria, Australia, v. 11, pt. 8, p. 487-493, 4 figs., August.
1916. Nosema apis in Victoria. *In* Jour. Dept. Agr. Victoria, Australia, v. 14, pt. 10, p. 629-632, October.

BROTBECK.

1857. Der Fadenpilz als Bienenkrankheit. *In* Bienen-zeitung, v. 13, no. 18, p. 215, September 10.

BURRI, R.

1912. Tätigkeitsbericht der Schweiz-milchwirtschaftlichen Anstalt-Bern-Liebefeld pro 1911 erstattet an das schweiz Landwirtschaftsdepartement. *In* Landwirtschaftliches Jahrbuch der Schweiz, Jahrg. 26, p. 469-491. Page 471. Im apistischen Betrieb.

DÖNHOF and LEUCKART.

1857. Ueber den Fadenpilz im Darm der Biene (mit einer lithographirten Beilage). *In* Bienen-zeitung, [Eichstädt], Jahrg. 13, Nr. 6, p. 66-67, 72, March 30.
1857. Ueber die Ansteckungsfähigkeit. *In* Bienen-zeitung, [Eichstädt], Jahrg. 13, Nr. 16 and 17, p. 199, August 27.
1857. Ueber den Verbreitung der Pilzsucht. *In* Bienen-Zeitung, [Eichstädt], Jahrg. 13, Nr. 18, p. 210, September 10.

FANTHAM, A. B., and PORTER, ANNIE.

1911. A bee-disease due to a protozoal parasite (Nosema apis). *In* Proc. Zool. Soc. London, 1911, pt. III, p. 625-626, September.

- GRAHAM-SMITH, G. S., FANTHAM, H. B., PORTER, ANNIE, BULLAMORE, G. W., and MALDEN, W.
1912. Report on the Isle of Wight bee disease (Microsporidiosis). *In* Supplement no. 8 to the Jour. Bd. Agr. [London], v. 19, no. 2, 143 p., 5 pl., May.
Bibliography, p. 139-143.
1913. Further report on the Isle of Wight bee disease (Microsporidiosis). *In* Supplement no. 10 to the Jour. Bd. Agr. [London], v. 20, no. 4, 47 p., July
Bibliography, p. 46-47.
- LIDLLOW, W.
1911. Bee diseases investigation. *In* Australasian beekeeper, v. 13, no. 2, p. 25, August 15.
- MAASSEN and NITHACK.
1910. Über die Ruhr der Bienen. *In* Mitteilungen aus der Kaiserlichen biologischen Anstalt für Land- und Forstwirtschaft, Heft. 10, p. 39-42, March.
- MAASSEN, A.
1911. Zur Aetiologie und Epidemiologie der Ruhr bei den Bienenvölkern. *In* Mitteilungen aus der Kaiserlichen biologischen Anstalt für Land- und Forstwirtschaft, Heft 11, p. 50-54, March.
- MCCRAY, A. H., and WHITE, G. F.
1918. The diagnosis of bee diseases by laboratory methods. *In* U. S. Dept. Agr. Bul. 671, 15 p., 2 pl., June 21.
- MCINDOO, N. E.
1916. The sense organs on the mouth parts of the honey bee. *In* Smithsonian Miscellaneous Collections, v. 65, no. 14, 55 p., 10 figs., Jan. 12. [Publication 2381.]
- NUSSBAUMER, THOS.
1912. Einige Erfahrungen über die Nosemakrankheit. *In* Schweizerische Bienenzeitung, n. f. Jahrg. 35 (whole ser. 48), no. 1, p. 30-33, January.
- PRICE, C. A. E.
1910. Bee mortality in the Stawell District. *In* Jour. Dept. Agr. Victoria, Australia, v. 8, pt. 1, p. 58-62, [2] fig., January 10.
- SNODGRASS, R. E.
1910. The anatomy of the honey bee. U. S. Dept. Agr. Bur. Ent. Tech. Ser. 18, 162 p., 57 fig., May 28.
Bibliography, p. 148-150.
- STEMPELL, W.
1909. Ueber *Nosema bombycis* Nägeli nebst Bemerkungen über Mikrophotographie mit gewöhnlichem und ultraviolettem Licht. *In* Arch. f. Protistenkunde, Jena, v. 16, no. 3, p. 281-358, 1 fig., pl. 19-25.
- WHITE, G. F.
1914. Destruction of germs of infectious bee diseases by heating. U. S. Dept. Agr. Bul. 92, 8 p., May 15.
1917. Sacbrood. U. S. Dept. Agr. Bul. 431, 55 p., 4 pl., 33 fig.
1918. A note on the muscular coat of the ventriculus of the honey bee (*Apis mellifica*). *In* Proc. Ent. Soc. Wash., v. 20, no. 7, p. 152-154, December 4.
- ZANDER, ENOCH.
1909. Tierische Parasiten als Krankheitserreger bei der Biene. *In* Leipziger Bienenzeitung, Jahrg. 24, Heft 10, p. 147-150, figs., Oct., and Heft 11, p. 164-166, Nov. (Also in Münchener Bienenzeitung, 1909, Heft 9.)
- ZANDER, ENOCH.
1911. Die Krankheiten und Schädlinge der erwachsenen Bienen. Stuttgart, 42 p., 8 pl. (Handbuch der Bienenkunde II.)

ADDITIONAL COPIES
OF THIS PUBLICATION MAY BE PROCURED FROM
THE SUPERINTENDENT OF DOCUMENTS
GOVERNMENT PRINTING OFFICE
WASHINGTON, D. C.
AT
10 CENTS PER COPY

▽

NATIONAL AGRICULTURE LIBRARY



1022415152