

Historic, archived document

Do not assume content reflects current scientific knowledge, policies, or practices.

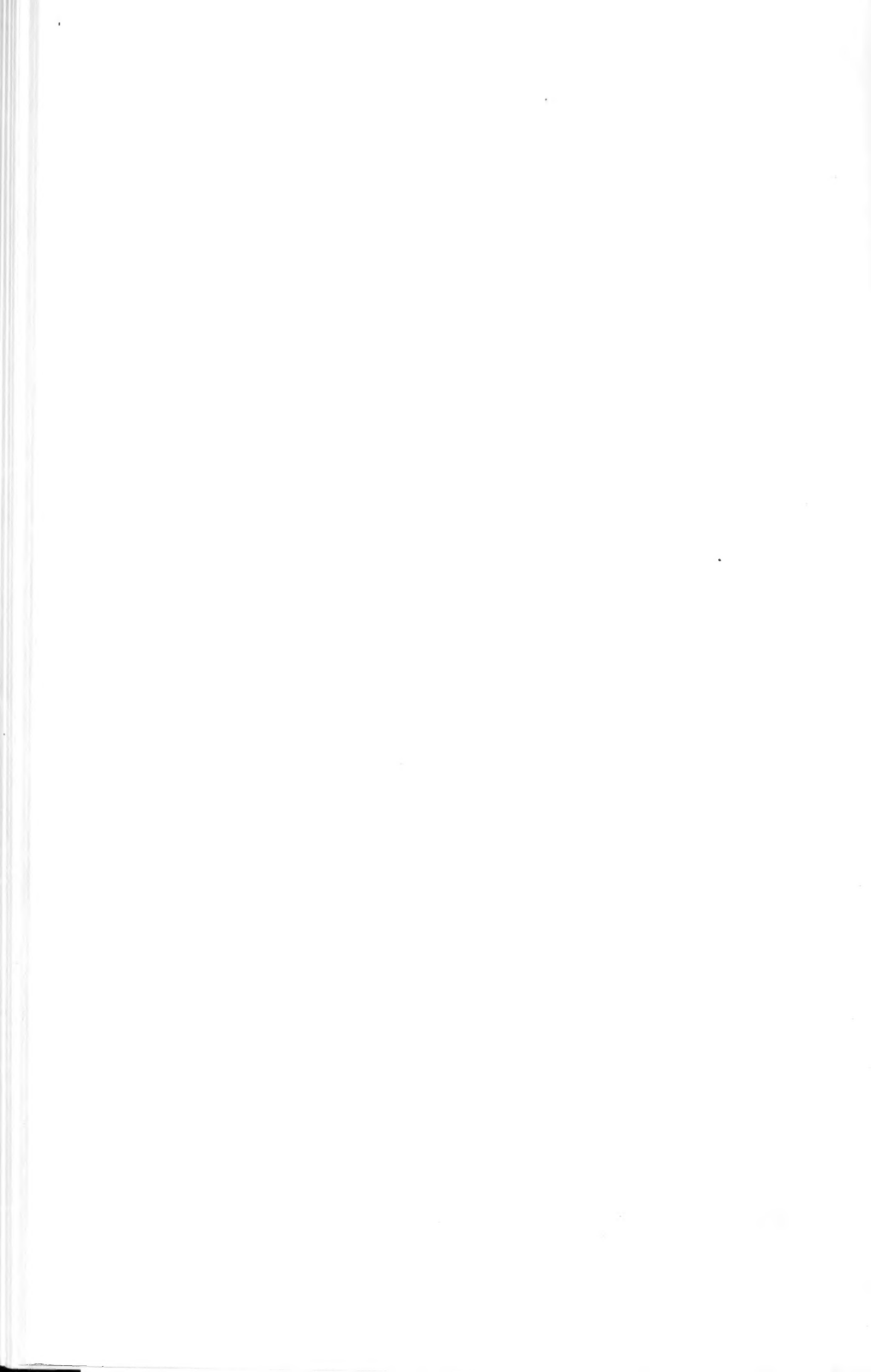

Hg 84M

cop. 2

FOREST SERVICE
UNITED STATES DEPARTMENT OF AGRICULTURE

NURSERY PRACTICE FOR TREES AND SHRUBS

SUITABLE FOR PLANTING
ON THE PRAIRIE-PLAINS

By
H. E. ENGSTROM
Associate Forester
Prairie States Forestry Project

AND
J. H. STOECKELER
Associate Silviculturist
Lake States Forest Experiment Station

LIBRARY
RECEIVED
★ SEP 19 1941 ★
U. S. Department of Agriculture



Miscellaneous Publication No. 434

1941

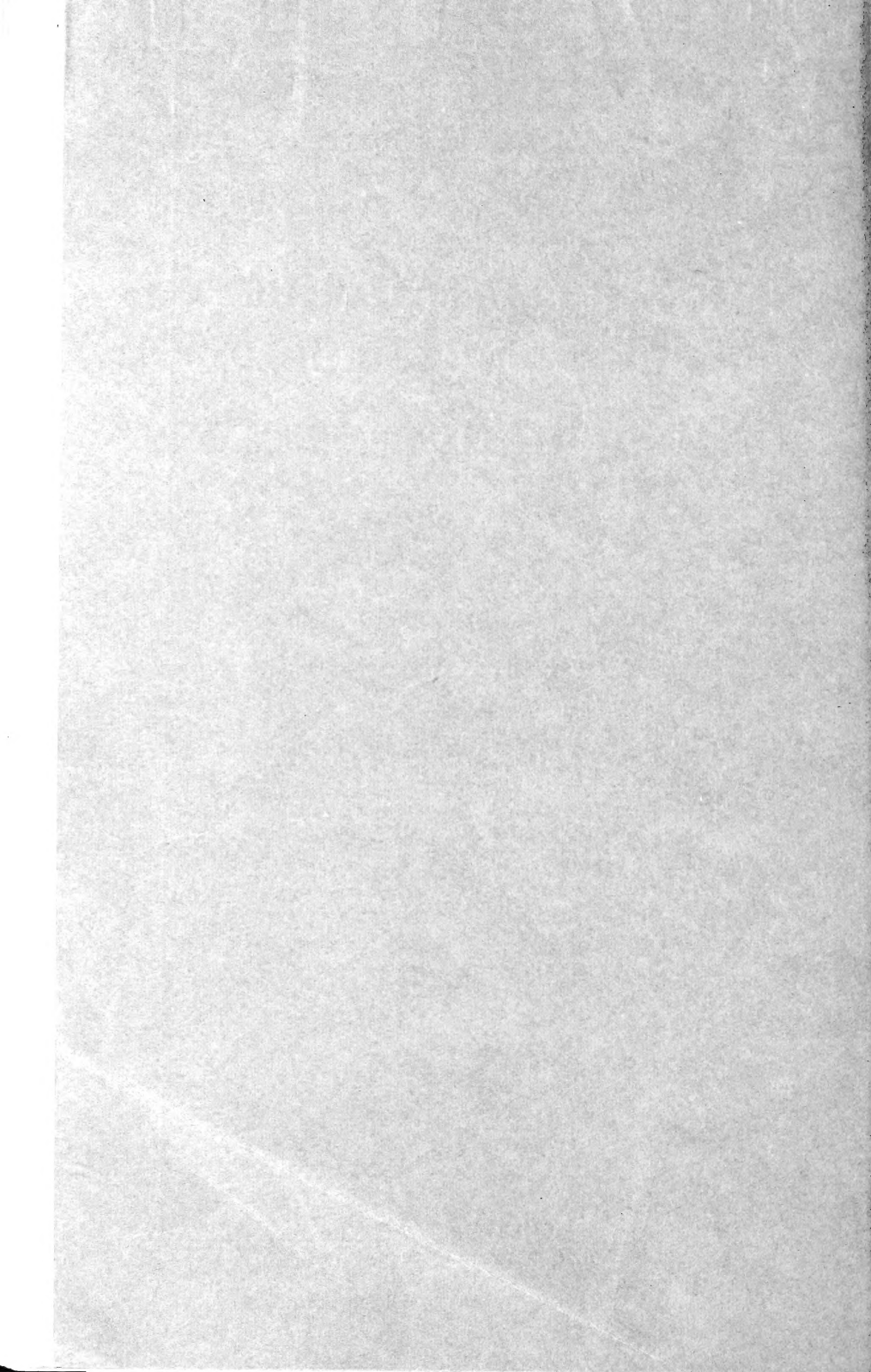

UNITED STATES DEPARTMENT OF AGRICULTURE

MISCELLANEOUS PUBLICATION No. 434

Washington, D. C.

August 1941

NURSERY PRACTICE FOR TREES AND SHRUBS SUITABLE FOR PLANTING ON THE PRAIRIE-PLAINS

By H. E. ENGSTROM, *associate forester, Prairie States Forestry Project*, and J. H. STOECKELER, *associate silviculturist, Lake States Forest Experiment Station*¹

CONTENTS

	Page		Page
Tree planting in the prairie-plains region	1	Special methods of growing planting stock	95
Collection and handling of seed	4	Propagation in beds	95
Importance of seed source	4	Transplanting	96
A seed zoning plan	7	Propagation by cuttings	98
Classes of fruits	9	Wildlings and root suckers	100
Seed collection	10	Summary of nursery operations	101
Seed extraction and drying	13	Nursery inventory	104
Storage and afterripening of seeds	18	Lifting and field grading	105
Treatments to stimulate germination	22	Lifting practice and equipment	105
Seed testing	30	Grading technique	106
Summary of collection and handling practices	33	Practical value of caliper in grading deciduous seedlings	109
Selection and maintenance of the nursery site	33	Grading standards for various species	112
Topography and location	40	Winter storage and shipping of nursery stock	118
Soil texture	40	Inside storage	119
Chemical composition and soil analyses	43	Outside storage	120
Special problems in alkaline soils	44	Packing and shipping	126
Minimum fertility requirements	48	Seedling protection	127
Maintenance of soil fertility	50	Wind	127
The water supply	54	Rain and hail	129
Quantity and quality of water required	54	Heat	130
Sources of supplemental water	58	Drought	131
Ditch irrigation	62	Frosts	131
Overhead irrigation	71	Losses occurring after lifting	132
Ground preparation and seed sowing	72	Insects feeding on the roots	132
Preparing the soil	72	Girdling and leaf-feeding insects	135
Row spacing	73	Sap-sucking insects	138
Season of sowing	74	Injurious mammals and birds	139
Depth of sowing	76	Pathology of deciduous seedlings	144
Sowing ratios to determine density of sowing	76	Selection of nursery sites	144
Sowing methods	80	Damping-off	145
Germination and seedling culture	84	Root rot	147
Care during germination	84	Leaf diseases	148
Thinning	87	Top blight and wilts	150
Controlling size and quality of seedlings	87	Miscellaneous diseases	150
Cultivation	90	Storage problems	152
Irrigation	91	Nursery costs	153
Hardening off	93	Literature cited	155
Top pruning to increase survival	94	Additional references	157
		Reference list of tree and shrub species	158

TREE PLANTING IN THE PRAIRIE-PLAINS REGION

In many sections of the country where native hardwood forests or prairie grasslands were formerly extensive, unwise use of the land has deprived the soil of its original protective cover. Over a large part

¹ Maintained in cooperation with the University of Minnesota at St. Paul, Minn.

of the prairie-plains,² this condition, aggravated by disastrous droughts of recent years, has resulted in extensive blowing and wastage of the best topsoil and the ruining of many farms. Public interest has lately been awakened to the need of restoring vegetative cover to this land by planting trees and shrubs and revegetation in general.

The need for trees and shrubs in the prairie-plains area is fundamental—for the protection and beautification of farm homes and schools, the reduction of wind erosion of fields, the protection of crops by shelterbelts, the production of fuel and fence posts, and for the



F334639

FIGURE 1.—Thrifty 2-year-old shelterbelt in Greer County, Okla., Chinese elm at left, black locust at right. Height, 12 to 14 feet. Planted by Prairie States Forestry Project, Forest Service.

furnishing of food and cover for songbirds and upland game birds and animals (figs. 1 and 2). The use of properly designed shrub wind-breaks as snow traps to reduce drifting on highways is an additional little-explored field with great possibilities.

Most of the forest planting in the past has been in the eastern and southern United States and has been aimed at bringing back the pines, spruces, and other conifers over large areas devastated by logging and repeated fires. The literature regarding the propagation of conifer seedlings is extensive and authoritative; but information concerning the seed and the propagation of the deciduous trees and shrubs suitable for prairie-plains planting is rather meager.

Tree planting on the prairie-plains received its greatest impetus between 1873 and 1891 from the Timber Culture Act passed by

² The region specifically referred to in this bulletin does not include all of the true plains or the eastern prairies, but is more or less on the dividing zone between the two areas. It includes certain parts of North and South Dakota, Nebraska, Kansas, Oklahoma, and north Texas, which lie between the 97th and 102d meridians of longitude.

Congress on March 3, 1873. In brief, this act with its subsequent amendments provided the settler with free land on the stipulation that he plant and care for a certain acreage of trees. After the repeal of the act in 1891, interest in tree planting suffered a temporary slump. Today, most of the remaining windbreaks planted in "tree-claim" days are overmature and in need of replacement.

In recent years, the passage of the Clarke-McNary Act of June 7, 1924, has revived interest in tree planting. This act, among other things, provides for Federal and State cooperation in distributing

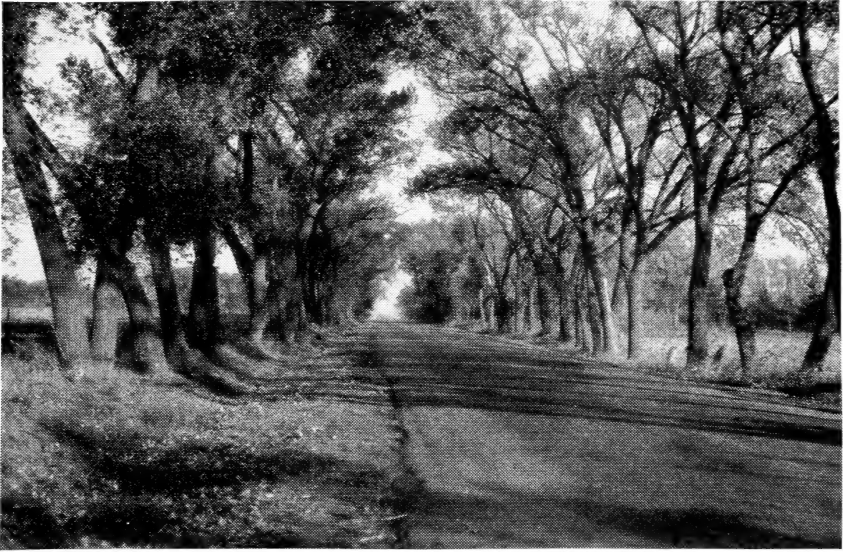

F334665

FIGURE 2.—This double row of cottonwoods along a Kansas highway serves a dual purpose in beautifying the highway and reducing wind erosion of adjacent agricultural fields.

nursery stock to farmers for demonstrations of farmstead and wind-break planting. In 1935 the Federal Government, acting through the Forest Service, started a large-scale program of shelterbelt planting on the prairie-plains within a zone 100 miles wide and 1,150 miles long. The zone extends through eastern North Dakota and South Dakota, central Nebraska and Kansas, western Oklahoma, into northern Texas. From 1935 to July 1, 1940, 14,140 miles of shelterbelts were planted under this program.

The Cooperative Farm Forestry Act, approved May 18, 1937, provides for demonstration, extension, and research in farm forestry and tree planting. The act provides that the work be initiated jointly by the various States and the Federal Government.

Planting of trees and shrubs is now one of the largest activities of the Forest Service in the prairie-plains region, and one in which the Soil Conservation Service and other public agencies are making large

contributions as well. This activity involves the planting of soil-holding trees and shrubs along gullies and on steep and eroded pastures or abandoned farm land, as well as the establishment of windbreaks and shelterbelts on the level stretches. Such plantings, which in this region are for the most part of deciduous species, are requiring many millions of trees each year and make strong demands on the forest nurseries as well as on the speed and efficiency of planting crews.

In view of the urgent need for information on behalf of these and subsequent large planting activities on the prairie-plains, this publication attempts to bring together the accumulated experience³ of the Forest Service in the field of nursery practice for deciduous trees and shrubs, especially for the prairie-plains region, including all phases of propagation, from the collection of the seed to the shipment of the trees out of the nursery. This information, it is hoped, will be of widespread interest to nurserymen, foresters, and game conservationists.

COLLECTION AND HANDLING OF SEED

IMPORTANCE OF SEED SOURCE

The source of seed of a plant is of utmost importance in determining the adaptability of the particular strain to its new environment. It often has a marked influence on growth rate, yield, form, longevity, susceptibility to insect and disease attack, ability to withstand extremes of temperature, and on ability to reproduce naturally. Years of experience in agronomy and horticulture have shown that it is extremely unwise to use seed of unknown origin. To protect the buyer, specific laws have been passed by the various State legislatures regarding identification of source and variety and declaration of the purity and germinability of seed used in ordinary farming practices.

Although no legislation exists regarding the certification of seeds and shrubs used in forest planting and other revegetational work, much the same result is accomplished by the statement of seed policy approved by Secretary Wallace for the Department of Agriculture in June, 1939. This provides that, on its various planting activities, only locally produced seed of traceable origin shall be used, if obtainable, and that substitutions shall be confined to seed from localities having very similar climate and altitude. Seed lots and nursery stock used in forest, shelterbelt, and erosion-control planting on projects of the Department shall be accompanied not only by a record of such particulars as species and year of collection, but also by proof of origin, including the locality and elevation of the place where the parent stock grew.

³ Although many men of the Forest Service have contributed their knowledge and experience to this summary, the work of Assistant Regional Forester D. S. Olson has particularly laid the groundwork for it, and his long and successful experience in propagating both hardwoods and conifers deserves special mention. In addition, separate contributions were made by Ernest Wright, of the Bureau of Plant Industry; J. A. Beal, L. G. Baumhofer, and N. D. Wygant, of the Bureau of Entomology; Harold Haecker and F. E. Garlough, of the then Bureau of Biological Survey; and I. D. Wood and R. Hilliary, formerly with the Division of Engineering, Prairie States Forestry Project. Credit is also due to the Works Progress Administration for help in collecting some of the field data. The facts presented are based largely on field experience of the Forest Service in administration of its Prairie States Forestry Project, and on laboratory and field tests conducted by its Lake States Forest Experiment Station.

Many European countries have established a system of voluntary or obligatory certification of tree seed. In their century or more of experience in tree planting they have learned the disastrous effects of wrong seed source and poor form and vigor of parent trees on the progeny. For instance, it has been observed that if the average temperature of a forest plantation of Scotch pine differs by more than 2° F. from that of the seed source, the growth rate of the trees in their new habitat will be unsatisfactory. It has also been found inadvisable to use seed which has been produced more than 1° of latitude (about 70 miles) or more than 300 feet in elevation from the planting site.

In all forest planting work in which trees native to the region are being used, the employment of seed from the nearest possible source will best guarantee those qualities of hardiness and vigor which make for success in the long run. However, in the prairie-plains region, where the native species because of sparse rainfall are greatly limited in variety, there is always a temptation to use trees creating a more novel or variegated appearance or holding the promise of quicker growth or more profitable yield. Most of these promises are false, and as a result many failures occur.

It would seem much wiser for the buyer to depend mostly on purchases of nursery stock of native origin and include only such exotic species as have been introduced long enough that true evaluation of their worth has already been made by the Department of Agriculture and the various State experiment stations. For this reason, in the list of recommended species given in table 1 are included only those foreign introductions which have been proved to be adaptable to conditions of climate and soil in some portion of the prairie-plains. Of these, Russian-olive alone is recommended without reservation for all parts of the region. The rest, as well as many of the indigenous species, are suited best to that portion indicated roughly by the State or States checked in the table. Details on soil adaptability of the various species are reported in detail by Hayes and Stoeckeler (15).⁴

A minimum program for guidance in collecting tree seed on the prairie-plains should incorporate the following:

1. Zoning of the seed-collection area on a basis of climate.
2. Limiting collection largely to local seed.
3. Picking seed only from healthy and vigorous trees of reasonably good form.
4. Keeping a careful permanent record of seed source from time of collection through to the field planting, including proper identification and labeling of the seed and a record of place and altitude of collection.
5. Importation of seed from foreign countries only after giving all possible study to the past experience with seed from different foreign sources.

⁴ Italic numbers in parentheses refer to Literature Cited, p. 155.

TABLE 1.—Species recommended for planting in the prairie-plains region

Species ¹	Natural range ²	States in which planting can be recommended ³					
		North Dakota	South Dakota	Nebraska	Kansas	Oklahoma	Texas
Medium-to-tall deciduous trees:							
Ailanthus	I			S	X	X	X
Ash, green ⁴		X	X	X	X	X	X
Ash, prairie		X	X	X	X	X	X
Boxelder		X	X		N		
Catalpa, northern	D			S	X	X	X
Coffeetree, Kentucky				S	X	X	X
Cottonwood		X	X	X	X	X	X
Elm, American		X	X	X	X	X	X
Elm, Chinese	I				X	X	X
Elm, Siberian	I	S	X	X	X	X	X
Hackberry ⁴		X	X	X	X	X	X
Hackberry, netleaf					X	X	X
Honeylocust				X	X	X	X
Honeylocust, thornless				X	X	X	X
Locust, black	D			S	X	X	X
Mulberry, red	E			X	X	X	X
Mulberry, Russian	I			X	X	X	X
Oak, bur		X	X	X	X	X	X
Osageorange	E			S	X	X	X
Pecan	E				S	X	X
Persimmon, common	E				S	X	X
Soapberry, western					S	X	X
Sycamore, American	E				X	X	X
Walnut, black				X	X	X	X
Walnut, Texas					X	X	X
Willow, white		X	X	N			
Willow, golden		X	X	N			
Conifers:							
Cypress, Arizona							X
Juniper, Rocky Mountain		X	X	X			
Pine, Austrian				S	X	X	X
Pine, ponderosa		X	X	X	X	X	X
Redcedar, eastern		S	X	X	X	X	X
Spruce, blue		X	X	N			
Spruce, western white		X	X				
Short trees or shrubs:							
Apricot	I			S	X	X	X
Bladder-senna	I				X	X	X
Buckthorn, Siberian	I	X	X	X			
Buffaloberry, silver		X	X	X			
Chaste-tree, lilac	I					X	X
Chokecherry, common		X	X	X	X		
Chokecherry, western		X	X	X	X	X	X
Crab, Siberian	I	X	X	X		X	X
Currant, golden		X	X	X	X	X	X
Desertwillow							X
Elder, American	E			X	X		
Hawthorn		X	X	N			
Honeysuckle, Tatarian	I	X	X			X	X
Jujube	I						X
Lilac, common	I	X	X	X	X		
Lilac, Persian	I		X	X	X	X	X
Maple, Tatarian	I	X	X	N			
Nannyberry	E	X	X	N			
Pea-tree, Siberian	I	X	X	N			
Plum, Chickasaw					X	X	X
Plum, sand					X	X	X
Plum, American		X	X	X	X	X	X
Redbud, eastern	E				X	X	X
Russian-olive	I	X	X	X	X	X	X
Serviceberry, common		X	X	N			
Skunkbush		X	X	X	X	X	X
Sumac, smooth		X	X	X			

¹ For scientific names of plants listed see p. 158.² Natural range of species, as regards east to west distribution, extends well into the prairie-plains region, and more or less away from streams, unless otherwise indicated by symbol, as follows: E = Extends only into edge of the prairie-plains or somewhat further on moist bottom. D = Native only at some distance or under quite different temperature and rainfall conditions. I = Not native to North America.³ S or N = Southern or northern half of State recommended for planting.⁴ And other western forms.

A SEED ZONING PLAN

Figure 3 shows a tree-seed zoning plan for the greater portion of the prairie-plains, prepared for the guidance of the Forest Service and other agencies in tree-planting activities in that area. The importance of latitudinal zones lies in the varying length of their growing seasons and increasing severity of winter temperatures to the north.

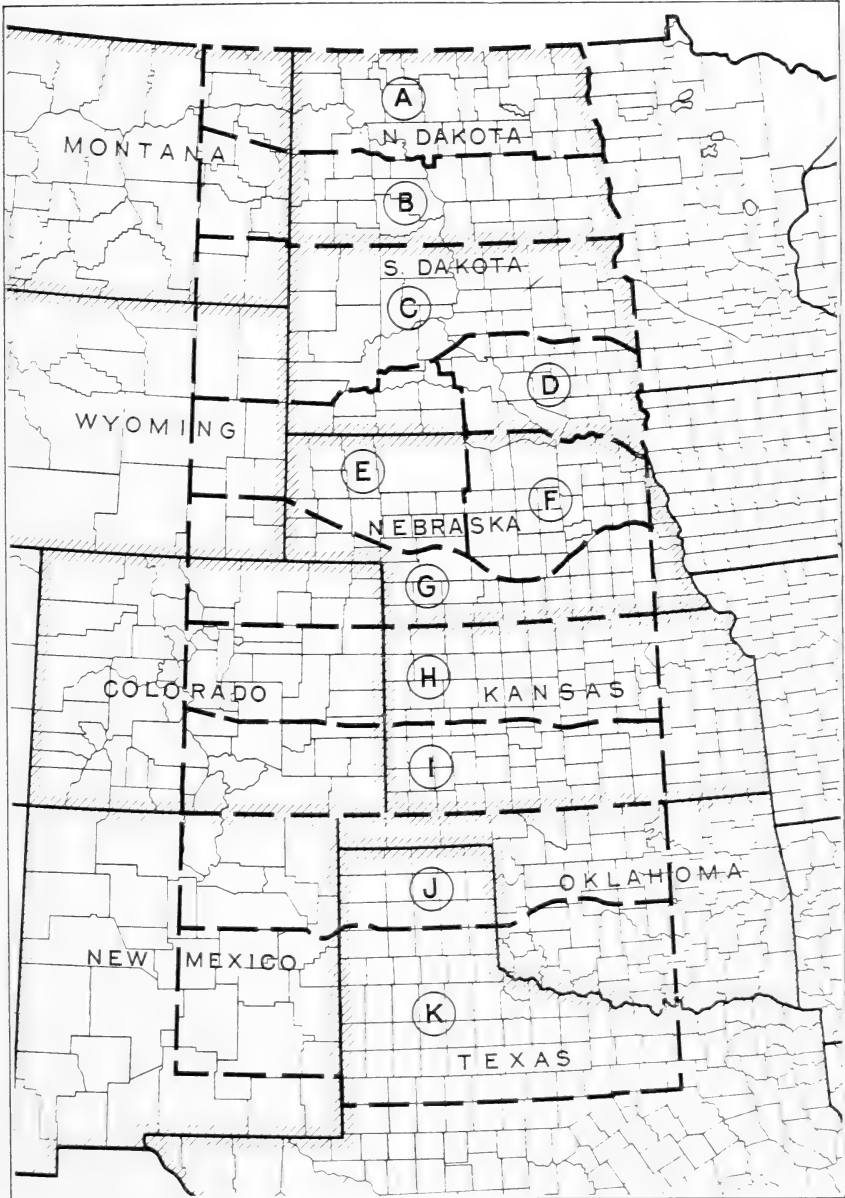

FIGURE 3.—Seed-collection zones for the Great Plains area (after Bates).

Ordinarily, seed should be collected and the progeny planted within the same zone.

Where absolutely necessary, it is considered permissible to move seed or stock from one zone to the adjoining zone but no farther, except in a few rare cases where altitude or other factors compensate for the latitudinal gap. For instance, it is possible to move blue spruce safely from the higher western part of zone G or H, to A, or to move seed of western white spruce from the Black Hills in western South Dakota to lower sites in zone A in the northern half of North Dakota. Seed of the native hardwoods on the prairie-plains should be collected preferably within 50 to 75 miles of where the trees are to be planted.

As a general rule, using northern seed in the south is not particularly dangerous but is likely to give trees of slow growth and poor development or trees which may eventually succumb to drought and heat. It may result in frost damage to the new growth if the northern stock buds out on the first warm days of spring. When southern seed is used too far north, the elimination of the progeny may occur much more promptly, since they lack the hardiness and early ripening of wood, etc., necessary to withstand the northern winters.

The danger of the south-to-north movement was illustrated by an experiment conducted by the Lake States Forest Experiment Station (table 2). Sixty-nine lots of seed of green ash, collected over the region from North Dakota to Oklahoma in 1934, were sown in northern North Dakota in the spring of 1935. Counts made in the fall of 1935 and again in the summer of 1936 to determine overwinter survival of the various lots (table 2) indicated extraordinary low survival from southernmost seed, despite its very favorable germination.⁵ It is believed that after a few years the trees from farthest south will virtually disappear. It has been found by the Forest Service that a northward move of 50 to 100 miles near the northern limits of a species' natural range may result in much more winter injury than a similar move near the center of the species' range.

TABLE 2.—*Overwinter survival of green ash from different latitudes, sown in North Dakota*

Source of seed	Lots sown	Seedlings, fall 1935		Survival, spring 1936	
		Per lot		Number	Percent
		Number	Total		
North Dakota.....	25	12	294	197	67
South Dakota.....	12	44	532	330	62
Nebraska.....	21	43	913	438	48
Kansas.....	8	30	241	94	39
Oklahoma.....	3	44	132	9	7

When the same seed lots described above were sown in a Nebraska nursery, midway in the range of the entire group, much less difference was evident (table 3), although the stock of North Dakota seed again survived the severe winter of 1935-36 slightly better than the others.

Movements from east to west—that is, generally from moister to drier climates—appear less harmful but should not be encouraged.

⁵ This is a fairly usual experience, although favorable germination is a common excuse for collecting seed in the warmer regions. These sowings were expected to produce 500 seedlings each, but most of the seed produced in 1934 was of poor quality and this seems to have been especially true of the North Dakota lots.

Most trees seem better able to adapt themselves to a shortage of moisture than to temperatures either lower or higher than those to which they are accustomed. Also, the effect of early frosts or low winter temperatures upon a southern form may not be serious if growth is checked by early fall dryness. Wood "ripening" is very important in this relation.

Several sources of seed are available in the prairie-plains region. The best source is that provided by the native trees that grow along streams and drainage ways, in gulches and draws, on rock outcrops, and in sand-dune areas. An additional source is provided by farm windbreaks, parks, street trees, and test plantings at various State and Federal experiment stations.

TABLE 3.—Overwinter survival of transplants¹ in a Nebraska nursery of stock from different seed sources

Source	Total survival	Suitable for planting, per lot ²
	Percent	Percent
North Dakota.....	78	12
South Dakota.....	68	45
Nebraska.....	75	46
Kansas.....	72	36
Oklahoma.....	65	22

¹ From fall 1935, when transplanted, to fall 1936 when field planted.

² This includes all lots and is based on a number of seed which theoretically should have germinated 500 seedlings in each lot.

It is considered safest to collect seed from native trees which have, in the course of centuries, adapted themselves to the rigorous climate of the prairie-plains. Seedlings produced from seed of parent trees growing where soil moisture is rather scant may be more uniformly drought-hardy than those growing from seed collected where soils are naturally subirrigated. Here again, however, is encountered the problem of germination quality, the drier sites generally producing fewer good seeds.

If seed is collected from planted trees or shrubs it is a good policy to pick only from individuals growing under dry-land conditions. Seed from well-formed, vigorous specimens growing in windbreaks and shelterbelts which have received no artificial watering is entirely acceptable. Such sources should be depended on for all exotic species which have shown adaptability to prairie-plains conditions. This is considered better practice than relying on new importations of seed whose origin may be entirely different from that of previous lots which have been successful here.

CLASSES OF FRUITS

To avoid misunderstanding, the following definitions are given of terms commonly employed in this discussion of seed. Descriptive botanical words not in common use are avoided as far as possible.

The term "fruit" is used in the botanical sense, not to denote something edible, but rather any product resulting from the fertilization and subsequent development of a flower, as a bean pod, or a walnut or acorn with its covering, as well as an apple, a cherry, or a strawberry.

The terms "dry," "pulpy," and "fleshy" as applied to fruits cannot be employed with any exact meaning but at least are useful for denoting the relative amounts of drying which may be necessary after the fruits have matured.

The term "drupe" denotes a single hard-coated seed ("pit" or "stone") more or less evenly surrounded by a fleshy or pulpy covering. The fruits of the cherry, plum, peach, apricot, hackberry, sumac, Russian-olive, and walnut are all drupes within this definition.

The term "nut" covers a multitude of forms and it is impossible to place all so-called nuts in any single classification.

Although the term "berry" has a very broad popular meaning, it will be used in this discussion to denote drupe-like fruits having more than 1 seed embedded near the center of the fleshy or pulpy pericarp. The fruits of the currant, honeysuckle, and buffaloberry are in this class, as are those of most of the junipers.

A "pome" is a fleshy or applelike fruit. The apples and crabs, pear, mountain ash, serviceberry, and the hawthorn ("red haw") are all botanically and structurally similar in having seeds in separate papery or leathery compartments, surrounded by a fleshy layer.

The term "pod" is a loose one but its common usage is so clearly associated with dry fruits in which the seeds lie more or less loosely, that it cannot be misunderstood. There are, of course, elongated pods like those of the honeylocusts, catalpa, and desertwillow, with which we are concerned, as well as more nearly spherical pods like those of the Jimsonweed and milkweed.

A "samara" is a winged fruit of the ash, elm, or maple. In the maples only, the fruits consist of two winged seeds joined at the base, but each such pair results from a single flower. Pine seeds have wings serving the same purpose in distribution as do the wings of samaras.

A "capsule" is a dry fruit composed of more than one carpel. The fruit of cottonwood is an example.

SEED COLLECTION

When the seed is being collected, it is not too soon to consider its probable viability or germinability. The collector can do much to obtain good seed and thereby assurance of high germination by exercising careful judgment as to maturity. Immature seed is definitely of lower keeping quality than well-ripened seed and of lower germinative capacity. Seedlings resulting from immature seed are inclined to be weak and less likely to come through early life.

As to the time of collecting, very good rules to follow are these: (1) All berries, elm seed, acorns, and the like which fall as soon as thoroughly ripe should be collected as near that general falling time as possible; (2) seeds which hang on the tree for a considerable time after apparent ripening will generally benefit by remaining there as long as it is feasible to delay collecting.

Color of the outer covering is ordinarily considered a reliable indicator of seed maturity. All species lose the green of the growing period and the seed contents change from a soft milky consistency to a firm, white or creamy-white kernel. Each fleshy or pulpy fruit, such as mulberry, hackberry, plum, and chokecherry, of course, has a typical red to purplish color and becomes soft when mature. Dry-fruited

species, such as ash, locust, and oak, assume a darker color when ripe, although ash and other winged seeds bleach after remaining on the tree some time.

From simple cutting tests may be obtained rough estimates of seed maturity before collection and thus the gathering of weeviled, hollow, or otherwise defective seed may be avoided. When careful pre-examination of the area discloses variation between trees in the quality of seed, it may be desirable to make cutting tests on seed of individual trees. This is a common-sense economy measure, since the money expended on the collection of immature, weeviled, or hollow seeds is wasted. A small-size wire nipper or side-cutter is a convenient tool for making cutting tests in the field. In judging maturity by means of cutting tests, one should note whether the kernel is firm, fills the cavity completely, and is of a white or cream color.

COLLECTING EQUIPMENT AND TECHNIQUE

The equipment necessary for efficient seed collection varies according to the species. For a season's work over a range of species, the Forest Service has found that collecting crews should, in addition to adequate transportation, be equipped with wire nippers or side-cutters for field cutting tests and other purposes, ladders, picking bags, buckets, heavy leather gloves (necessary for certain thorny species), bamboo or light wooden poles of various lengths, cutting-hooks for detaching fruit or cones (fig. 4), sacks, tags, twine, ropes, linemen's safety belts, and tarpaulins or seed-sheets. Light duck (8-ounce) tarpaulins, 14 by 16 feet, or heavy burlap lengths sewed into squares of convenient size, are preferred to heavy tarpaulins because they are easier to handle, and the seed will not bounce off them.

Collection technique varies according to species. In general, flailing, stripping, and shaking onto tarpaulins (fig. 5) are the preferred practices for species growing in planted rows or in groups in open, parklike areas where tarpaulins can be spread out and easily moved about beneath the trees. Hackberry, black locust, mulberry, and Russian-olive are a few of the more common species collected in this manner.



FIGURE 4.—A double-hook detacher for cutting fruit, cones, or small limbs from trees. Made from two discarded mower blades welded to a flat piece of steel 8½ inches long.

F342209

Where this method is impossible because of undergrowth, small-fruited species such as choke cherry must be hand-picked before falling. Such species as walnut, honeylocust, and Osageorange may be gathered from the ground after falling, since the fruit is large and easily visible. The winged seed of elm and ash are best collected on quiet days in a large, light tarpaulin or square of cheesecloth tied at the corners of bamboo poles. This is moved about beneath the trees, raised or lowered as the seed is flailed or shaken down. Sweeping elm seeds from pavements is a common commercial method of obtaining this species at low cost but only commendable when all the parent trees are desirable specimens.

Some species must be watched closely to determine exactly the right time for collection. The seed of some species, notably elm and Siberian pea-tree, falls as soon as ripe and must be collected immediately upon maturation. Seed of certain other species, although retained, is relished by rodents and birds and can only be salvaged by careful watching and prompt collections.

A number of deciduous species do not develop their fruits evenly, and at certain periods these may be found in all stages from green to ripe. An outstanding example in the prairie-plains region is the Russian mulberry, from which repeated collections every few days are desirable, over a period of 2 to 3 weeks. The ripe fruit may be gathered by lightly shaking the branches at each visit.

Other species which ripen unevenly but somewhat more promptly are honeysuckle, plum, and chokecherry. Where one collection is to be made in a given locality, it is best to delay until the bulk of the fruit has ripened fairly well, even though a part of the earlier-ripening fruit may be lost. Too early collection may result in the gathering of a large amount of unripe fruit.

For species that hold their seed into the winter, collection costs can be lowered considerably by delaying gathering until after the leaves have fallen, at which time the seed is easily visible and is also more readily detached or shaken loose. Kentucky coffeetree, hackberry, soapberry, black locust, and green ash are among those that may be handled in this manner.

Provident nurserymen make a practice of collecting a considerable surplus in good seed years and carrying it over for use in years of partial or complete failure.

All seed crops are variable in quantity and quality from year to year, just as field crops are, but sometimes for different reasons. Certain species such as hackberry, Siberian pea-tree, ponderosa pine, and redcedar produce very light seed crops in some years and the cost of collection may then be 5 to 10 times as high as in good seed years; or the seed crop may fail entirely. Consequently, it is a good policy to carry over a surplus of seed as insurance against crop failure and for the maintenance of a uniform nursery production schedule.

In the case of species which are usually fall sown, an additional reason for carrying over a surplus of seed is the fact that it is often impossible to collect and extract such seed early enough to sow much of it the same year. Hackberry and redcedar are examples of such species.



F572109

FIGURE 5.—Collecting eastern redcedar berries by stripping onto tarpaulin, Nebraska.

CARE OF FRESH SEED

Few seeds are dry enough to be stored, even in piles, immediately after collection, except for those species which become dry on the tree. Care of seed immediately after collection and before it can be extracted is, therefore, of the utmost importance. In handling newly collected seed of most species, adequate aeration in a dry atmosphere is essential. A safe procedure, if it is not possible to extract the seed immediately, is to spread the freshly gathered fruit in a thin layer in the open, stirring and shoveling occasionally, for several days following collection. After drying, the fruit can be stored temporarily while awaiting extraction.

It has been found that freshly gathered fruits of practically all deciduous species will heat if piled or sacked and left undisturbed for some time, and any appreciable amount of such heating is almost certain to destroy the usefulness of the seed. Elm seed has been observed to heat in an hour. All pulpy-fruited species and practically all dry-fruited species require close observation and care, if at all moist when collected. At the same time, these forms should never be allowed to dry excessively. Pulpy-fruited species heat more readily if crushed in handling.

SEED EXTRACTION AND DRYING

The extraction of seed from a wide range of deciduous tree species presents more varied and difficult problems than extraction of conifer seed. In connection with its Prairie States Forestry Project, the Forest Service has tried numerous extraction methods and techniques. Certain procedures and equipment have been developed which give uniformly good results, together with economical performance.

For cleaning seed it is desirable to select a few capable men and keep them at it steadily rather than to extract the seed with any available help as fast as it is collected. More seed will be cleaned and a better job accomplished as the men become trained in the work. Cleaning immediately the fruits with soft, juicy pulp which spoil quickly, and delaying the extraction of seeds which can remain for some time in the fruit or pods without harm, will permit spreading this work throughout the season without injury to the seed. It should be realized that even the drier fruits cannot be left for long in a poorly ventilated building without increasing the danger of loss through molding and decay.

Length of fermentation period of the fleshy fruits of mulberry, buffaloberry, and chokecherry influences the amount and speed of germination. In a series of tests by Carl Taylor of the Prairie States Forestry Project it was found that seed from mulberry fruit, fermented in water from 24 to 48 hours, showed a decidedly higher and more rapid germination than that unfermented. Further fermentation beyond the 2-day period markedly decreased the amount and speed of germination and 4 days of fermentation caused complete loss of viability. The same trend occurred in buffaloberry although the optimum fermentation period extended up to 4 days. The chokecherry showed some slight improvement in germination from fermentation up to 4 days, although this length of fermentation in deep containers pickled the pulp, rendering extraction more difficult.

Although Taylor's tests indicate that a limited fermentation of pulpy fruits before extraction is beneficial to germination, for safety it seems advisable to hold fermentation during extraction to a minimum. It probably should not be permitted at all if the seed is to be held for a long period in dry storage.

METHODS OF EXTRACTION

An effective extractory should contain ample floor space, should be provided with running water, floor drains, and electricity, and should be insulated and heated to permit winter work. A cold-storage chamber for stratifying and storing seed will also prove essential where these processes are to be conducted on a large scale.

Standard equipment at an extractory should include several dust-proof electric motors—preferably $\frac{1}{8}$, $\frac{1}{2}$, and 1 hp.—seed macerator, seed scarifier, rotary drier, two large fans, fanning mill, tanks and barrels, stratification boxes, and containers for storage of seed. Of necessity there will also be considerable miscellaneous equipment.

In this connection it should be mentioned that seed can be safely extracted with very little equipment provided more labor is used in the process. Large quantities of seed have been extracted with such simple equipment as a few lengths of 4- to 6-mesh hardware cloth through which the fruit is rubbed, and a few buckets or barrels to serve as containers. A plentiful water supply for washing and floating off pulp is, of course, essential.

The macerator developed for seed extraction by the Forest Service, when used in conjunction with a fanning mill, extracts rapidly and cheaply the seed of most deciduous species, as well as juniper seed. It is of all-metal construction and built on the principle of a threshing machine with cylinder and concaves.

The macerator can be used either for the threshing of dry-fruited species such as Kentucky coffeetree, honeylocust, and black locust (fig. 6, *A*) or for macerating fleshy- and pulpy-fruited species such as mulberry, chokecherry, Osageorange, redcedar, American plum, and various others (fig. 6, *B*). Some species such as ash are threshed dry in order to separate the clusters of seed. The size of the discharge opening is controlled by a metal slide, with which the operator regulates the rate at which the material passes through the machine.

For a number of the pulpy-fruited species, notably Russian-olive and redcedar, the machine can be used first to thresh the fruit from the leaves and twigs by running the machine at a rather high speed

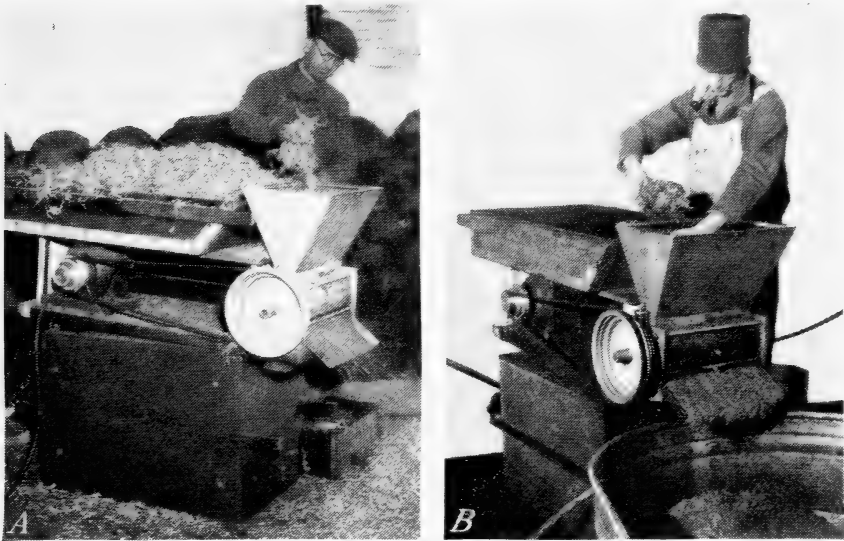

F334700—F342190

FIGURE 6.—*A*, Threshing Russian-olive seed in especially constructed macerator, seed warehouse, Fremont, Nebr. *B*, Macerating Osageorange.

with the discharge slide wide open (fig. 6, *A*) and then for separating the seed from the pulp by closing down the discharge opening and decreasing the speed. In extracting pulpy-fruited species, water is added through the hose attachment and serves to wash the pulp and seed through the discharge opening after proper maceration.

The capacity of the macerator is governed by the length of the cylinder. Macerators now in use have cylinder lengths of 12 and 18 inches. For an all-purpose machine, one with $\frac{1}{2}$ -inch teeth clearance has proved satisfactory since it will handle the small as well as the large seeds; but in order to clean seeds of all sizes to best advantage it is desirable to have a second machine with $\frac{3}{8}$ -inch clearance for the smaller seeds.⁶

A good power unit for operating this machine is a 1-hp. electric motor, although small gasoline engines are equally satisfactory.

⁶ A macerator in use at the Southern Great Plains Field Station of the Bureau of Plant Industry, at Woodward, Okla., is equipped with an adjustable macerating plate so regulated that different clearance widths can easily be obtained for the various kinds of seed processed.

The cylinder speed is controlled by the graduated V-pulleys permitting speeds from approximately 400 to 1,700 r. p. m. It has been found that optimum operating speed for greatest effectiveness varies considerably for the different species. As reported by Carl Taylor, capacities of the macerator are as follows: For a machine having a cylinder 12 inches long with teeth spaced at $\frac{3}{8}$ -inch clearance, the usual run of chokecherry is 2,000 to 2,500 pounds of the fruit per day, depending on the condition of the fruit. For redcedar, which is more gummy, 1,000 to 1,500 pounds is a good day's run. The machine can depulp from 2,000 to 3,000 pounds (dry-weight basis) of Russian-olive seed which has been previously soaked, or 1,000 pounds of buffaloberries in a day. A similar machine with an 18-inch cylinder and $\frac{1}{2}$ -inch clearance depulps 4,000 to 5,000 pounds of plums per day. Pro-rating the plum cleaning over the entire crew, washing, fanning, and other handling, the output is 950 pounds of fruit per man-day, and the total cleaning cost 15 cents per bushel of fruit, or 2 $\frac{1}{2}$ cents per pound of clean, dry seed. The speed of threshing varies considerably with the dryness of the material and the proportion of leaves and brush. The 1935 Russian-olive crop threshed around 2 to 4 tons per day. Honeylocust pods, if reasonably dry, thresh out fast enough so that the yield of clean seed is 400 to 600 pounds per day, but if the pods are well broken up by tramping before they are put through, an output of 1,100 to 1,500 pounds of clean seed is possible.

In addition to the macerator, other implements have been used with good results in tree-seed extraction work, among which the more successful are the old-fashioned restaurant potato peeler, food choppers, concrete mixers, hammer mills, feed grinders, and grain threshers. Usually it will be found that such implements work exceptionally well for one or two species but cannot be made to perform successfully over a wide range of species.

Following the macerating process, further cleaning of the seed is necessary. For dry-fruited species such as ash and locust, the wings, hulls, and other debris are removed by running the seed through a fanning mill. For a few species like Osageorange, washing the seeds through screens to separate the heavy, larger pieces of pulp is helpful, if done previous to floating off the pulp. In a number of other pulpy species, washing through screens, followed by drying and fanning, will complete the extraction. The tiny seeds of serviceberry are more difficult to separate from the pulp and fully clean by any process.

Where there is a considerable differential in weight, light seed can be separated from well-filled seed of similar size by means of a fanning mill. This will be most effective with seed having thick, bony coverings.

Seed of the fleshy-fruited species can usually be separated from the remnants of the pulp and from light seed by flotation. This method is based on variation in buoyancy under agitation in water. Good sound seed is ordinarily quite heavy and will quickly sink to the bottom, whereas pulp and poor seed will either float or settle more slowly after being put in suspension. A quantity of the macerated material is placed in a slightly tilted large wash tub into which a stream of water from a garden hose is directed at such an angle as to create a rotary swirl and a lifting effect upon the material. Slight stirring of the material in the bottom of the tub is also necessary.

The pulp and light seed will be brought to the surface and spill over the edge of the tub as the water overflows. With some experience, this simple technique is quite effective.

SEED DRIER

A rotary seed drier developed by the Forest Service is a convenient aid in drying seed following extraction, especially during winter months, when outside air drying is not feasible and inside drying space is limited. The drier (fig. 7) consists of a screen-wire cylinder 32

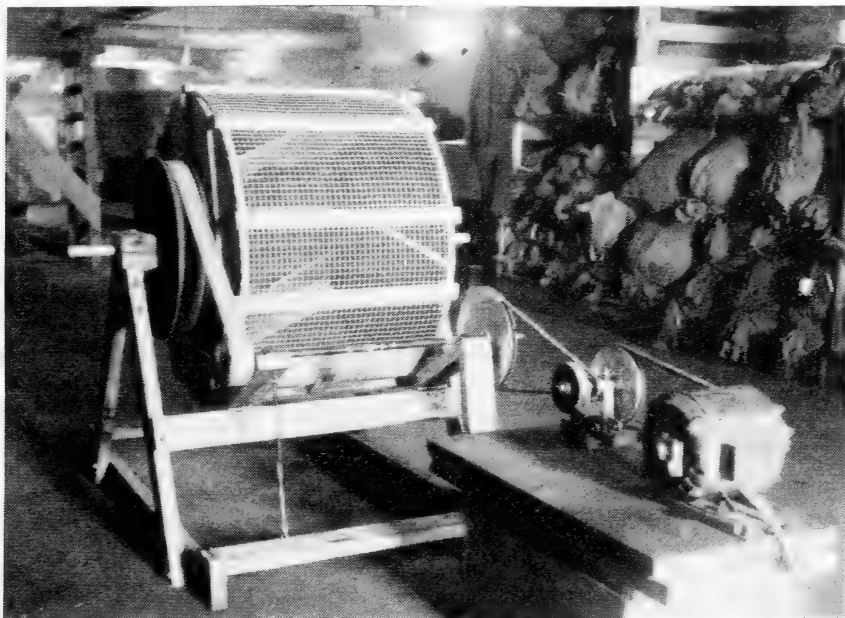

FIGURE 7.—Rotary seed drier with power hook-up.

F54219

inches in diameter and 32 inches long with wooden ends of $\frac{1}{2}$ -inch lumber. The three 1- by 3-inch baffle boards, equally spaced within the periphery of the cylinder, pick up the seed as the drum revolves and slowly spill it in a thin stream as each baffle reaches the highest point. Warm air from a heater, forced through the revolving cylinder by an electric fan, hastens the evaporation of moisture from the seed. The optimum speed for the cylinder is 12 to 15 r. p. m.

This machine dried 20 pounds of redcedar seed in one hour's operation, whereas the seed of the same quality placed on screen wire trays dried only slightly after a week's exposure in the same room. There is danger, however, in too rapid or excessive drying. This is brought out in connection with dry storage.

EXTRACTION FACTOR

Considerable loss in weight generally occurs from drying and from the removal of pulp, pods, twigs, and other debris. Very seldom will the extracted weight of good seed approach the collecting weight.

The extraction factor, or the weight percent of good seed obtained, is essential in computing in advance the quantity of fruit which must be collected to obtain a given weight of dry, clean seed. Factors for different species, computed from records which the Forest Service has maintained and assembled over several years, are given in table 6, page 34.

STORAGE AND AFTERRIPENING OF SEED

Seed collected in the fall may receive any of the following treatments, which should govern in a large measure the final cleaning processes, especially the degree of drying to which it is subjected:

1. The seed may be sown immediately or within a few weeks; whereupon such prompt-germinating seed as Siberian pea-tree may make a small amount of growth at once, but those species which are necessarily sown late in the fall or must have a definite period of afterripening will lie dormant over the winter. Afterripening is almost invariably associated with exposure to at least a moderate degree of cold; but freezing is an unavoidable, rather than a necessary part of the process.

2. The seed may be kept only over winter in a shed with dry air and a wide range of temperature, in a cold-storage room in sacks or bins, or stratified in peat, sand, or other damp medium, either outdoors, in a cellar, or in regulated cold storage. For none of these methods is severe preliminary drying necessary, and with some seed it is both useless and detrimental. One must be certain, however, that low temperatures govern from the start, since under even mild temperatures freshly treated seed may sweat considerably in sacks, bins, or other mass storage, and mold and spoil very quickly. If the seed is properly protected and then sown early in the spring, the low temperatures will be sufficient guarantee against spoilage.

3. The seed may be set aside for fall sowing after approximately a year, or for insurance against seed-crop failures within several years. Any seed which has to be kept over a summer must be treated as for longer storage, and it is for this kind of storage that special precautions must be applied at the time of extraction. However, there are many species which cannot be kept for any great length of time, and those which are known not to be long-lived must be handled with especial care if any large proportion is to remain germinable after a year or more.

THE KEEPING QUALITY OF SEED

Much is yet to be learned, in most cases, as to the length of time the seed of deciduous species will retain its viability under the best storage conditions. No comprehensive study covering the range of species has yet been made. Toumey (38) reports no germination of mulberry and 21 percent germination of black locust seed stored 10 years at room temperature in unsealed glass jars. Giersbach and Crocker (13) report that American ("wild") plum seed stored in a laboratory cupboard improved in germination up to 26 to 30 months and retained more than half their viability up to 46 months. Seed stored at 45° to 50° F. retained good germinating capacity after 53 months of storage.

Among nurserymen in the prairie-plains region it is general knowledge that seed of the legumes, green ash, boxelder, and hackberry will keep in storage at ordinary variable temperatures for 2 or more years.

Others, notably elm and depulped chokecherry seed, lose their viability rapidly and will generally produce little or no germination at the end of a year. Some success has been attained in maintaining a fair degree of viability in American elm seed for 1 year by holding it close to the freezing point after very careful drying (34).

George (12) reports that thoroughly dried American elm seed was successfully stored for 10.5 months in both open and closed containers. These lots gave 77 and 79 percent germination respectively.

Norman Devick, of the Forest Service, from a similar test at Jamestown, N. Dak., reports 12.5 percent germination of American elm seed stored dry for 11 months in burlap bags; 11 percent when stored in sealed cans under the roof of a warehouse; and 26 percent in sealed cans buried 1.5 feet underground. A portion of the first two lots was dewinged by beating the sacks against a brick wall before placing the seed in storage. Germination on the dewinged lots was 0.5 and 21.0 percent respectively for the burlap bags and sealed containers. It appears that if stored seed is to be dewinged to facilitate machine sowing, the dewinging process should be delayed until just before sowing of the seed.

E. I. Roe, of the Lake States station, has obtained a 67 percent germination on seed of Siberian elm which had been thoroughly dried and stored in airtight tin containers for 4 years at 41° F.

Because of the fact that very few experiments have been made which give a basis for an exact procedure in treating seeds, it is necessary to fall back on general experience and to formulate some general rules from a few cases in which the information is most complete.

Broadly speaking, the degree of drying which seed will tolerate, and which in itself determines or at least indicates how long the vitality will remain in seed, must be gaged by the characteristics of the particular type of seed under natural conditions. Thus, seed which fall to the ground as soon as ripe and either germinate immediately (if early) or normally lie on sheltered ground or in litter, will tolerate very little drying and will be difficult to preserve in a viable condition. With possibly few exceptions among the drupaceous fruits and berries, those forms which normally adhere to the tree well into the winter, or in some cases much longer, are accustomed to being severely dried and can be preserved. Longevity may, however, vary from 2 to 50 years, the maximum period occurring only when an ideal condition of storage has been found.

The reason for this close relation between drying tolerance and longevity is that all living seed respire, and in so doing consume the foods which are within or immediately available to the "germ" or embryo. Respiration can be checked to a very low point by dryness and by low temperatures, and the consumption of vital foods be thus slowed down; but it is not known with certainty whether this process can be completely stopped without killing the embryo. The extent to which drying can be safely employed depends on the protoplasm within the germ cells. It is undoubtedly possible for certain forms of protoplasm to be very severely dried without coagulation and death; while other forms (as in young, growing tissues of nearly all plants) will not tolerate a low moisture content.

A seed is a dormant form of a plant; but as in the case of the sleeping or hibernating animal, this does not mean complete cessation of the

life processes. In brief, seed vary in the degree to which they can be put to sleep. Insofar as this condition is caused by drying, it should be referred to as induced dormancy. In many cases this causes changes which are difficult to reverse.

The seed of green ash, for example, is certainly mature enough by the time it becomes reasonably dry on the tree and will germinate in a relatively short time if placed in warm, moist soil. Although the species does have some embryo dormancy, it does not have it in the degree that junipers and similar species have. Yet, if seed of green ash is stored for several years and becomes quite dry, the seed coat becomes so impervious to moisture as to require water-soaking for about 2 weeks before it will germinate. But it will then germinate only slightly less freely than the fresh seed. Thus, dormancy may be induced to the point where revival becomes a matter of some difficulty and yet after at least 3 or 4 years of such dormancy the seed suffers no serious loss in viability.

The more sensitive types of seed that require storage over winter can withstand little induced dormancy. They must be stored in the presence of some moisture and with temperatures below 40° F., and the dormancy they undergo, insofar as it differs from the inherent dormancy discussed later, corresponds with the winter dormancy of all kinds of woody plants and of the roots of perennials, in which severe drying of the tissues is likely to be fatal. It is not known how long this type of dormancy can be maintained in seed, but probably not more than a few months, since even at 40°, with ample moisture, respiration will proceed at a moderate rate.

Afterripening is not quite the same process in different types of seed. Some seed are ready to germinate as soon as they have completed their growth and usually have exchanged their green coloring matter for something of a ruddy hue. Others will not be ready for many months, and it is unquestioned that during this period certain chemical changes occur which represent a continuation of the ripening process. These changes are accompanied by the slow exclusion or occlusion of moisture, the latter implying that the moisture is used and combined within the seed. They may or may not depend on the gradual lowering of temperatures in the autumn.

The first practical bearing of these facts is that the afterripening of seed may be prevented and the seed germination at a later date made slower or more difficult if artificial drying is too severe or applied too soon after picking. Second, seed put away early, which may still be under compulsion to sweat out some moisture, if kept in a poorly ventilated mass at temperatures above 40° F., may be subject to molding and heating. It would hardly be possible to overemphasize the desirability of maintaining the natural routine of seed ripening as closely as possible when handling and storing seed in large quantities.

COLD STORAGE

All of the above considerations lead to the following precautions and procedures to be employed wherever there is any question as to just what degree of treatment a given kind of seed will tolerate without injury:

Do not dry seed too fast, too long, or at high temperatures. Drying under a current of moderately warm air is safer than drying in still

air at temperatures sufficiently higher to effect approximately the same rate of drying. A draft of air is somewhat cooling and affects the seed more superficially than drying at high temperatures.

Assuming the seed is to be put away somewhat moist, a temperature below 40° F. is highly desirable, and in the early fall this almost certainly requires cold storage.

Where seed is certain to be used the following spring, and stratification over winter is the easiest method for disposing of it, the temperature of the medium should be not higher than 50° F. at the start, with prospect of early lower temperatures. In short, even with types of seed which commonly require afterripening, a few seeds are likely to germinate in the early period of stratification if the temperature is 50° or more.

Cold storage in a moist atmosphere below 40° F. will fully care for seed which sprouts readily in the fall even at moderately low temperatures, and will equally well preserve elm seed. Also, even the seed which is better off in a very dry condition will not deteriorate appreciably in cold storage for some time. Cold storage can be depended on to preserve stony seed which do not tolerate any serious drying, and at the same time to "crack" them in readiness for germination.

DRY STORAGE

At the other extreme, it is well to consider what it is possible to do with seed which tolerate a very dry condition. Lodgepole pine seed, after being reasonably dried in the course of extraction, were further dried in a stream of air at 170° F. for 4 hours without the slightest injury and with actual improvement of keeping qualities, according to the experiments of Bates (1).

Other forms of severe drying have been used, holding pine seeds in atmospheres of 20 to 40 percent relative humidity as long as any loss of moisture was evident. Norway pine seed tolerated 20 percent relative humidity, with a reduction of the moisture of the seed to 3 or 4 percent. White pine is probably injured by drying to that degree and may be better preserved at 6 to 7 percent of its own weight in moisture.

Red and white pine stand about 150° and 120° F., respectively, for periods of 8 to 10 hours in the kiln without serious loss of viability.

It seems probable that nearly all leguminous seed will tolerate at least the degree of drying recommended for white pine. While these seed appear to dry adequately in ordinary air as they ripen, and to maintain vitality for years, experience to date indicates that more perfect preservation can be attained through slightly greater drying and sealed storage.

If seed can be put away in sealed containers with very low moisture contents such as indicated above, they may be kept for a long time at any moderate temperature, or still better at low temperatures. A desiccant such as calcium chloride or charcoal can be placed in the can to reduce still further the moisture content of the seed.

High temperatures, such as occur under room conditions or in sheds in the summer, are dangerous to seed not entirely because they induce increased respiration but also because they cause spoilage of fatty materials. Seed containing much food stored in the form of fats and oils are especially susceptible to decomposition if exposed to high temperatures for a considerable period.

Cellars in which temperatures do not vary greatly between winter and summer, or at least do not reach a high point in summer, would be reasonably satisfactory for maintaining the vitality of seed, were it not that humidity is usually quite high in cellars. It is useless to dry seed to an equivalent of 30 to 40 percent relative humidity if they are later to be exposed in the slightest degree to humid atmosphere. Sealed containers are essential, but that term can hardly be applied with propriety to anything except metal cans with all seams soldered, or glass jars or bottles with ground stoppers. Neither corks nor rubber gaskets can be fully depended on to exclude atmospheric moisture, which dry seed will absorb with great avidity if there is any leakage whatever.

Summarizing, for seed which can be thoroughly dried and which it is necessary and desirable to store for periods of 1 to several years:

1. Storage in sealed containers at low temperatures of 33° to 40° F. after full drying is most desirable. Somewhat higher temperatures are not harmful but are not as desirable.

2. If sealed containers cannot be employed, the constant low temperatures of a cold-storage plant offer best protection despite fairly high humidity. Ice-cooled plants are likely to be too moist.

3. If neither containers nor cold storage can be had, a well-ventilated, thoroughly dry building should be used. High temperatures occurring in poorly ventilated lofts or attics should be avoided. A north, second-story room, sealed off from the roof, is best.

4. Fatty seed, such as most pines and many nuts, should not be exposed to temperatures above 80° F.

TREATMENTS TO STIMULATE GERMINATION

Nurserymen in the prairie-plains region have definitely come to the conclusion that any seed treatment that will shorten the germinating period after sowing is helpful, since this period is the most critical of the entire nursery season. The shorter it can be made, the less danger there will be of losses from heat, damping-off, drying, crust formation, and other ills that beset the seedling during the germinating period. An additional advantage of a short germination period is that the stock produced is of a more uniform size and fewer cull seedlings result. Furthermore, the proper treatment of the seed will give a much higher percent of germination.

THE PROBLEM OF SEED DORMANCY

Any difficulty arising from the need for afterripening or pregermination treatment of seed is most readily overcome by fall sowing, when this is feasible and when it is known the seed will not spoil or become active before cold weather. As has already been indicated, for seed which are known to require a long exposure to moisture, including the afterripening period, stratification over winter is best, or at least next best to fall sowing in the nursery.

It is very difficult to draw a sharp line between processes which have already been referred to as afterripening, or completion of the ripening process, and those which are necessary as a preliminary to germination and which, in the artificial handling of seed, are referred to as pregermination treatment. The one sort merges into the other.

Under natural processes, it would probably be safe to say that anything which occurs in the seed after it falls to the ground in the autumn, or through the winter while the ground remains frozen, is afterripening, while with thawing, and in the presence of abundant moisture, the seed moves definitely toward germination, the more rapidly as temperatures rise. However, this is not always the case, since some seed, like those of the junipers, do not germinate the first spring or summer with any certainty. It then is decidedly doubtful what degree of exposure makes it possible for the seed to germinate during the second spring.

It is probable, however, that by simulating somewhat closely the temperature-moisture cycle of a single over-winter period, most seed which show any dormancy or difficulty in germination can be brought through satisfactorily. But, as has been pointed out, freezing is rarely if ever a necessary step in the procedure. Temperatures from 32° to 40° F. accomplish the same ends.

Some investigators recognize a number of types of dormancy but three types are certainly by far the most common. All of these are inherent within the seed. They are: (1) Seed coats which prevent or delay the intake of water or restrict exchange of gases; (2) dormant embryo; and (3) combination of impermeable seed coat and dormant embryo. A fourth type of dormancy is found in a few species. This is caused by lack of complete development of the embryo at the time the seed falls and necessitates additional time after seed collection in which to obtain full development of the embryo. Seed of the genus *Ginkgo* are in this class.

The type of dormancy determines the germination treatment. Impermeable seed coats can in a relatively short time be rendered permeable by acid or mechanical scarification, or by soaking in hot water. Seed which have only a slight amount of seed-coat dormancy often respond to soaking in cold water. The type of dormancy and the best known pretreatment for seed of about 50 species of trees and shrubs are given in table 6.

For seed possessing a dormant embryo, a substantial rest period is necessary, varying in length with the species. Since low temperature and a modicum of moisture that does not prevent aeration or respiration are essential for certain obscure chemical changes taking place at this time, stratification in a moist medium at about 40° F. is usually employed, until sowing in the nursery is possible. The same treatment is generally effective for seed possessing both an impermeable seed coat and a dormant embryo. Difficulties are increased, however, if stratified seed becomes too warm and begins to sprout before sowing. Practically all stony-coated seeds and nuts require 60 days or more of stratification.

Fall sowing will, under favorable conditions, effectively break the embryo dormancy or the combination of impermeable seed-coat and embryo dormancy, but it is not recommended for seed in which dormancy is caused by an impermeable seed coat alone, unless uniform moisture conditions can be assured. Such seed, which do not require a long low-temperature treatment, are bladder-senna, smooth sumac, skunk bush, ash, and sycamore (decidedly dependent on degree of previous drying), all of the legumes (Siberian pea-tree, honeylocust, black locust, redbud, and coffeetree), persimmon, soapberry, lilac, and Osageorange.

A few seeds with papery coats, like desertwillow and catalpa, ailanthus, and the elms, absorb moisture readily but may be helped by a little soaking before sowing.

METHODS OF SEED STRATIFICATION

Stratification is accomplished best by holding the seed for the required period in a moist medium at a low temperature. For most species the best temperature is about 40° F., and stratification is best accomplished in cold-storage chambers where the temperature can be held close to that point.

Sand, peat, or a mixture of the two are commonly used by commercial and Government nurseries for stratification of seed. The facilities available and condition of the seed—whether depulped or not depulped—will determine the best medium to use. In instances where no temperature control is available, or if the seed retains its pulp, pure washed sand is the safest, although unwashed sand has been used with satisfactory results. Where temperature control is available, and where the seed is free from pulp, pure granulated horticultural peat obtained from acid spruce swamps or a 1 to 1 mixture of sand and peat will give better results than sand. Peat is favored over sand because its light weight, moisture-retaining capacity, and texture facilitate handling, make the addition of water unnecessary during the stratification period, and afford better aeration for the seed. For seed retaining their pulp or where no temperature control is possible, difficulty has been experienced with peat because of heating, and it is necessary to use sand.

The moisture content of the peat or the mixture of peat and sand used as a stratification medium should be such that no water can be squeezed out by closing the hand firmly on a small quantity. Where the proper moisture content in peat mediums is achieved at the start of the stratification period, it is usually maintained evenly for the duration of the stratification period without further watering. When sand alone is used, it should not be saturated but the moisture content should be such that when a handful is picked up and compressed it will hold its shape without crumbling. It is difficult to maintain a uniform moisture content in sand since the moisture tends to drain to the bottom causing a soggy condition in the lower portions of the mass and leaving the top too dry.

The correct proportion of seed in the stratification medium will vary according to the size of the seed. A safe rule to follow is that the seed and the medium should be thoroughly mixed and each seed should be practically isolated. The volume of the medium may be somewhat less than that of the seed, but generally more satisfactory results and greater safety will be assured by using a liberal quantity of the medium. If practicable the stratified seed should be shoveled over at 10-day to 2-week intervals, assuring more uniform stratification through better aeration. This process is especially important where sand is the medium, since only in this way can the moisture content be evenly maintained throughout.

Small or moderate-sized containers such as boxes, barrels, or ice-freezing containers (fig. 8) are preferable to large ones in stratifying seed of the smaller sizes. Large boxes or bins have not proved as satisfactory as metal containers because of the difficulty in maintaining uniform moisture and temperature throughout the entire volume.

Where a longer period of stratification is possible, especially for seed occupying great space, such as walnuts and acorns, larger containers or pits placed out-of-doors may be used. Stratification out-of-doors must be maintained longer than the periods required indoors, and below-freezing temperatures should not be permitted for the whole period. Moisture absorption and chemical changes in the seed practically cease while the seed is in a frozen condition. It is, therefore, customary to make pits reasonably deep and to insulate them



FIGURE 8.—Seed in stratification in ice-freezing containers.

F342192

against a constant frozen condition during the whole winter by using straw or other mulch over the top of the mounded earth.

Considerable variation exists in the length of the stratification period required by the different species and even for different seed lots within the species. The degree of dryness, previous storage method, and age of seed are the important factors involved. Nurserymen and seed investigators have, however, arrived at the fairly definite average durations for most species, which will be presented later on.

It has been observed frequently in some species possessing the combination type of dormancy, such as plum and chokecherry, that in a short time the seed will be pitted, i. e., the seed coat will split open leaving the embryo exposed. This, however, does not mean that the seed is ready to germinate, and longer stratification must usually be employed to break the embryo dormancy.

Seed of some species, such as plum, chokecherry, Russian-olive, and lilac, may sprout in stratification as spring approaches, even though the temperature has risen very little above 40° F. Frequent inspection of stratified seed is therefore necessary, and if sprouting is observed the medium should be placed in colder storage and so maintained until the seed can be sown.

Stratified seed ready for sowing is highly sensitive and is readily susceptible to injury, especially through drying. Extreme caution is necessary in the spring when removing the seed for sowing, to guard

against drying out or heating. The medium and seed are separated before sowing largely to make the seed easier to handle in drill sowers. When the seed is larger than the particles of the stratifying medium, separation is successfully accomplished by shaking the mixture over wire-mesh screens or washing it through the screens. When the seed are small and about the same size as the medium, difficulty is encountered in attempting to separate the two, and it may be necessary to sow the seed by hand without separating it from the stratifying medium. Sowing unseparated seed by hand may be advisable on other occasions also, since no mechanical seeder has been developed that is suitable for sowing all deciduous species. In these instances, a knowledge of relative weights of stratifying medium and seed will aid in determining how much of the mixture to sow per lineal foot of row for the desired density.

ACID SCARIFICATION

Acid scarification, or a method by which impermeable seed coats are etched or pitted by acid, succeeds best and is preferred practice on such leguminous species as honeylocust, black locust, Kentucky coffeetree, redbud, and bladder-senna. It can also be used as an emergency though not a preferred treatment for a number of other species having impermeable seed coats (26).

Concentrated commercial sulfuric acid with a specific gravity of 1.84, undiluted, is recommended for this purpose. Length of treatment varies from 20 minutes to 4 hours for the different species, generally with some variation for different seed lots of the same species, depending largely upon age and the degree of drying the seed has undergone. It is a wise precaution to run preliminary tests to determine the minimum treatment to which the particular lot of seed will respond. Efficiency of the treatment is determined by the percent of seed which swell after being rinsed and placed in cold water for 1 or 2 days.

Before treating with acid, the seed should be thoroughly air-dried to avoid injury from excess heat generated when the acid absorbs water. There is less danger of excessive heating if the seed is treated in comparatively small lots. While undergoing treatment, the seed should be stirred frequently.

Glazed porcelain crocks or wooden tubs are the preferred containers for treating seed in acid. Wooden tubs become charred on the inside and last for some time. Most metal containers are corroded by the acid but if lined with paraffin, asphalt, or lead may be used without difficulty. Containers in which treatment is given, or in which acid is stored, should be kept free from extraneous matter, especially other chemicals, and should be plainly labeled.

Acid may be recovered and, although brown and sirupy, may be used repeatedly, but there will be considerable shrinkage in volume, largely because the acid adheres to the seed and is lost in rinsing.

After the acid has been used a number of times, it may be advisable to test it with a hydrometer to determine whether there is any marked change in specific gravity. Any appreciable admixture of water in the acid should be avoided.

A good alternate method is to pour just enough acid over the seed to coat it thoroughly when stirred. Frequent stirring is necessary to obtain uniform treatment. After the seed has been treated for the

correct period of time, it is rinsed thoroughly with water. By this method there is no recovery of acid, but it is preferred by many nurserymen because there is less danger of heating and subsequent injury to the seed.

Obviously, extreme precaution should be taken in using the acid. Goggles to protect the eyes, as well as rubber aprons and gloves, should be worn. Solutions of ammonia, bicarbonate of soda, or some other alkali should be available at all times to neutralize acid which may be splashed on clothes or skin, or the acid may be washed off the skin in running water. Petrolatum (vaseline) should be applied to any burns after the acid has been washed off. Acid should be poured into the container of seed, rather than seed into acid, to minimize splashing.

After the acid treatment, which should include a careful washing in running water, the seed may be sown immediately. Excellent results have been obtained however, from first soaking the acid-treated seed in cold water until swelling takes place—usually for a few hours or overnight. Where soil-moisture conditions are favorable at the time of sowing, this method should assure prompt and even germination, since the swollen seed is already in the process of germinating. Mixing the wet seed with dry sand or sawdust to absorb the surface moisture will aid in handling the seed during sowing.

If sowing is not immediately practicable after treatment, the seed can be stored. Briggs⁷ has found that the seed of honeylocust, sumac, and soapberry, washed and dried following the acid treatment, may be stored for as long as 5 months with little or no loss in viability. Nurserymen can, therefore, treat the seed of such species during the slack winter months and have it in readiness for spring sowing. Kentucky coffeetree seed, however, submitted to the same tests, showed a decrease in germination from 90 percent at time of treatment to 61 percent at the end of a 5-month period, and black locust and Russian-olive decreased as markedly. Such reductions appear to be due to the wetting and drying which follow the acid treatment when the seed is not used at once. More research is needed on the effect of storage on acid-treated seed.

MECHANICAL SCARIFICATION

Another method of rendering the seed coat permeable to water is by mechanical scarification, or the abrasion of the seed coat to crack it or reduce its thickness sufficiently to allow penetration of moisture. This is usually accomplished by placing the seed in a steel drum lined with sandpaper, revolving at about 20 r. p. m. This method has been successfully used by the Forest Service at the Bessey Nursery, Halsey, Nebr., in treating seed of redcedar.

Other methods have been satisfactory with some types of seed. Hurst, Humphries, and McKee (17) describe several scarifiers used successfully on sweetclover, among them a disk scarifier consisting of a horizontal stone revolving against an upper stationary disk faced with rubber, the seed being passed between the two disks. Chapman (9) describes a modified Ames seed scarifier in which seed of black locust was treated by blowing the seed with a fan against a curved, sandpaper-lined race.

⁷ [Briggs, A. H.] STORAGE OF SEED AFTER ACID TREATMENT. U. S. Forest Serv. Lake States Forest Expt. Sta., Forest Res. Digest, Jan.-Feb., 1936, pp. 10-12. [Multigraphed.]

A different type of scarifier was recently developed by the Lake States Forest Experiment Station (32). It consists of six vertical sandpaper-covered disks, 0.25 inch thick, 10.5 inches in diameter, and

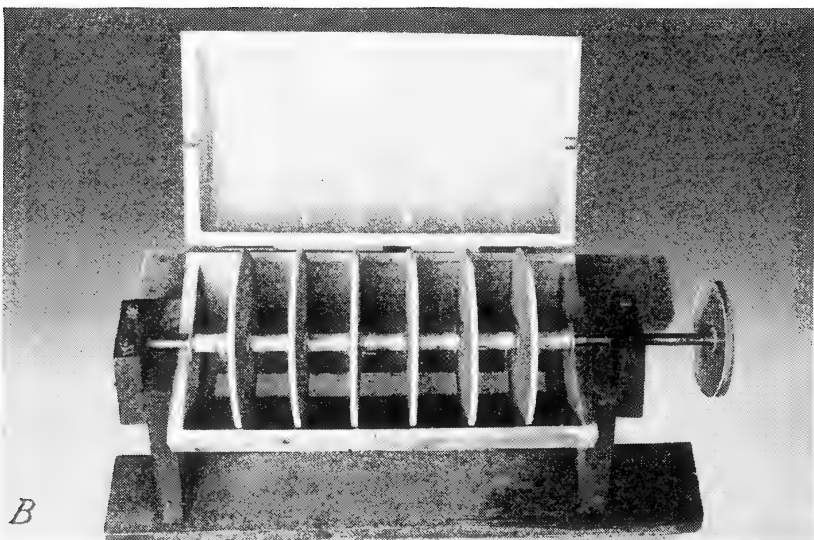
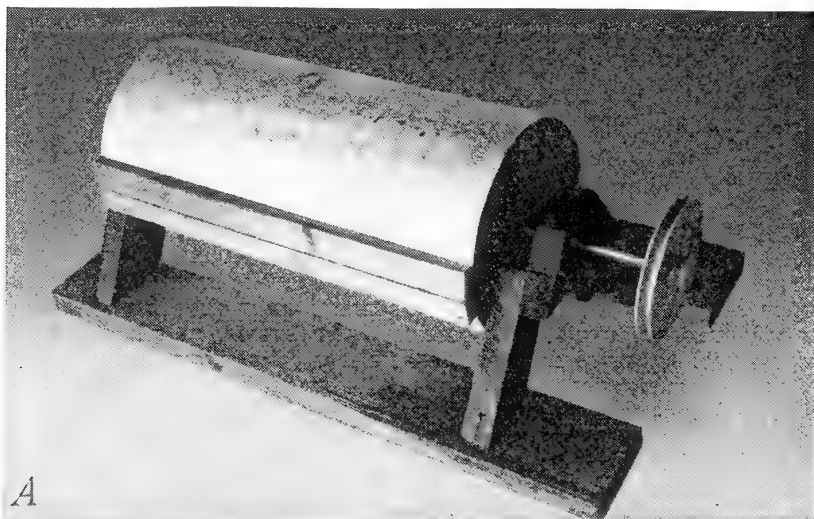

FIGURE 9.—Disk seed scarifier developed by the Lake States Forest Experiment Station. A, Exterior view; B, interior view, showing screen in bottom to allow dust to escape.

F32782₃

mounted on a $\frac{3}{4}$ -inch steel shaft, revolving inside a stationary metal cylinder also lined with sandpaper (fig. 9). The cylinder is 24 inches long, 11 inches in diameter, and is made of 28-gage galvanized iron. The ends are of 1-inch pine. A narrow 16-mesh screen is soldered in the bottom and left uncovered to allow dust to escape. The cylinder

is hinged to allow removal of seed and permit access for relining the drum and disks with abrasive. The abrasive consists of No. 2½, grade 30 E, silicon carbide sandpaper, held in place by casein glue. The cylinder is suspended on the shaft in such a manner that the removal of a pin will allow it to be rotated, thus facilitating the removal of the seed.

This scarifier is run at speeds of 500 to 900 r. p. m. and can handle about 10 pounds of tree seed of any size. Only the lower half of the cylinder is filled with seed. As the seed is scarified, it circulates gradually over the top of the cylinder, so that all seed is given an even treatment regardless of variation in size. For any nursery where large quantities of seed are to be treated, a larger machine can be built in which the wooden disks can be replaced advantageously by solid carborundum grinding wheels. All other parts can be made of metal.

This type of disk scarifier is much more effective than the revolving drum or box type. A few minutes' treatment is sufficient for thin-coated black locust and similar species. Hard-coated species will require a longer period. The length of time of treatment for a given kind of seed must be worked out by actual test for each size of scarifier. The type of abrasive used will also influence the effectiveness of the treatment. The seed used must be quite free of resin or soft pulp to prevent gumming-up of the abrasive.

SOAKING IN COLD AND HOT WATER AND OTHER TREATMENTS

Seed of all species must absorb water before they will germinate. Where scarification or stratification are not practicable, the germination period for many spring-sown seeds, even those having no dormant period, can be shortened considerably and a higher and more uniform germination obtained by soaking them in cold water until they swell. This may require as much as 2 weeks in cases where seed-coat dormancy is natural or has been induced by long or severe drying. Nurserymen have reported cases which point to the conclusion that, while soaking in water is not the preferred treatment, practically all deciduous species grown for prairie-plains planting respond to it favorably as an emergency treatment.

Water in which seed is soaked should be changed every day, otherwise it becomes sourish and has a detrimental effect on seed viability. Better still is to place the seed in burlap sacks and immerse them in running water, as a stream or river, thereby providing both fresh water and aeration. For a number of light seeds, notably elm, catalpa, and desertwillow, water absorption can best be accomplished by placing in wet sand instead of cold water. Soaking, to be most successful, must be continued until the larger portion of the seed swells. The seed should then be sown as soon as possible.

Hot-water treatment has been used with the larger legume seed as a means of softening the impermeable seed coat, in preference to acid treatment or mechanical scarification. As a general rule, a given volume of these hard-coated legumes can be immersed in an equal volume of boiling water and then allowed to cool, without injury. According to Phillips (30), the water must be just below the boiling point. This is not always effective but probably is as far as one can safely go.

Other treatments involving the use of solvents such as xylene, ether, and acetone have been used experimentally. McKeever (24) found that a 10- to 120-minute treatment of black locust seed with these chemicals aided in dissolving the impervious waxy covering and improved germination.

SEED TESTING

Seed testing is an important phase of seed and nursery work and no seed should be sown that has not been tested in some manner before sowing. Germination tests are the most reliable measure of seed viability, but only when made at the proper time and on seed thoroughly afterripened. Consequently, cutting tests must often be relied upon to indicate the percent of well-filled seed.

SAMPLING

No matter what kind of test of seed is to be made, it is imperative that the sample used be representative. It is necessary, also, to run one or preferably more separate germination tests on each lot of seed of which the origin or treatment is dissimilar. If a given lot contains a large quantity of seed, say several tons, it is safest to obtain a separate sample from each container or bin.

From 0.5 ounce to 32 ounces, depending on size of seed, or from 1,000 to 4,000 seeds, is considered a fair sample. A seed-sampling device such as is used in sampling grain will be found useful, though not essential, in obtaining a uniform sample. The original sample can be further reduced by mixing thoroughly, spreading out in a thin layer, and resampling the seed uniformly with a spoon. The final sample on which the germination test is run should contain at least 400 to 1,000 seeds.

GERMINATION TESTS

Germination-testing procedure used at the Lake States Forest Experiment Station at St. Paul, Minn., since 1930, is suggestive of methods that can be generally applied. On receipt of a sample for testing, the number of seed per pound is determined for the standard sample (including refuse) and on a clean-weight basis. A cutting test is also made on part of the sample, and percents of good, rancid, and empty seed are recorded. Usually several hundred seed are cut. Quadruplicate samples of 250 seed each are then counted out from the remainder of the sample for the germination test.

Germination tests are conducted in wooden flats 1 foot square and 3 inches deep, in which one to four small samples may be sown. The flats are filled almost to the top with a clean, sterile, medium sand, ranging in pH from 5.0 to 5.7⁸ in acidity, tamped slightly and smoothed off. The seed is scattered uniformly on the surface, pressed in with a small board, and covered with sand to a depth of two to three times the average diameter of the seed. Water is then added in sufficient amount to bring the moisture content of the sand up to 10 or 12 percent of dry weight.

Since damping-off may occasionally occur in a flat, despite the use of sterile sand, the four subsamples of each test are always sown in

⁸ On what is called the hydrogen-ion scale, 7.0 is neutral, 3.5 is strongly acid, 8.2 is the alkalinity of a limy soil, and 9 is very alkaline.

four separate flats; the germination percent is based on the average of the four samples, or such of these as have suffered no known damage. The flats are placed in the germination room, where a range in air temperatures from 60° to 85° F. is maintained, to simulate outdoor conditions. Overhead light is supplied during the day, the lamps to some extent aiding in heating the germination room.

As soon as germination is evident, the seedlings appearing above the surface are removed with forceps and their number is recorded. Tests are continued from 20 to 90 days depending on rapidity of germination.

For those species which have a rest period and require stratification, the flats of seed, properly watered, are placed for 1 to 4 months in one of several cold-storage chambers maintained at temperatures between 41° and 50° F., and then brought into the germination room. Those seeds requiring only mechanical or chemical scarification or water soaking are treated just before sowing.

CUTTING TESTS

For seed of the current year's crop, cutting tests are the most feasible and practical method for the nurseryman to determine the probable percent of good seed. The kernels of good seed are firm, white, or creamy in color, and completely fill the seed cavity. On the basis of number of seeds in a very small sample, it is possible to compute the number of good seed in an ounce or pound and thus to determine the quantity of seed that must be sown per unit of area or per foot of row, under recommended practice, to give approximately the desired stand. If the seed is several years old, the cutting test must be discounted considerably, and it may be impossible by this method to determine whether or not the seed contains life. This will depend on species, storage method, and general history of the seed.

TESTS OF EXCISED EMBRYOS

A rather recent development in seed-testing technique (11) consists in carefully removing the embryo from the seed coat and placing it on moist filter paper at 70° to 75° F. The viable embryo swells or partially germinates within 5 to 10 days and shows considerable color change. The dead embryo rots. Results show that no matter how dormant a seed may be, the healthy excised embryo usually shows some swelling and color change within a week's time.

The technique used depends on the type of seed coat. Hard-coated species such as plum, peach, hawthorn, and chokecherry are cracked with a special tool designed for this purpose. A Nebraska nurseryman has devised a pair of pliers equipped with an adjustable stop screw which works satisfactorily on many species. A small vise has also been used successfully. The hard coat is carefully cracked and the seed is placed in water overnight to soften the inner coat, which is then removed with the aid of a needle. Species such as apple and pear are soaked in water overnight and then the outer and inner coats are removed. Pine and fir seed are soaked in water, the outer coat is removed, and slits are made in the endosperm, which is again soaked in water before removing the inner coat.

Great care must be taken not to crush the seed or injure the embryo. Injured embryos do not react normally and are susceptible to mold or rot.

USE OF DYES AND STAINS

A number of investigators, notably the Russians, have been experimenting with the use of various chemical stains and dyes, which, when applied to the contents of a seed, will indicate by color whether the embryo is alive or dead. This work is still in an experimental stage but it is hoped that it will lead to a simple and accurate method of determining viability. The promptness with which such a test could be made is an obvious advantage.

RELATION OF GERMINATION TO CUTTING TESTS

Table 4 shows the relation of laboratory germination to cutting tests. All species which respond to pretreatment of any kind were given the proper treatment before testing. Although the table cannot be used indiscriminately, it does give the nurseryman some idea of these relationships. For instance, Russian-olive and honeylocust both yielded 96 percent or more of well-filled seed by the cutting test, but the former had an average germination of only 32 percent, while the latter was 83 percent. This would indicate that Russian-olive would have to be sown more heavily than honeylocust to achieve stands of equal density.

An examination of table 4 reveals that species which are dormant because of a thick seed coat generally have higher germination ratings than species with a dormant embryo. The latter, in spite of stratification and afterripening, often fail to complete their germination within 30 to 60 days.

TABLE 4.—Laboratory germination expressed in percentage of apparent viability of seed based on cutting tests

Seeds	Laboratory germination		Well-filled seed in cutting tests		Ratio of germination to cutting test		Basis, tests
	Range	Average	Range	Average	Range	Average	
Medium-to-tall deciduous trees:							
Northern catalpa.....	52-58	54	92-98	95	53-62	57	3
Green ash.....	22-31	1 27	86-96	92	24-37	29	4
Honeylocust.....	66-92	83	96-98	97	53-97	86	4
Kentucky coffeetree.....	66-92	81	97-100	99	68-92	82	5
Pecan.....		49		49		52	1
Bur oak.....		1 39		90		43	1
Post oak.....		54		74		73	1
Black locust.....		1 59		90		66	1
Western soapberry.....	47-56	1 51	84-96	90	56-58	57	2
Osageorange.....	36-57	48	94-100	98	36-57	49	3
Siberian elm.....	36-56	44	68-81	76	46-72	58	4
Conifers:							
Ponderosa pine.....	47-69	57	68-78	74	67-91	77	6
Short trees and shrubs:							
Siberian pea-tree.....	55-78	63	92-100	99	55-85	64	5
Redbud.....	73-85	79	100	100	73-85	79	2
Desertwillow.....	26-37	31	90-96	93	27-41	33	2
Russian-olive.....	24-43	1 32	96-100	98	25-43	33	5
Tatarian honeysuckle.....	31-73	52	84-92	86	37-87	60	4
Apricot.....	44-89	1 66	100	100	44-89	66	2
Siberian buckthorn.....		47		100		47	1
Skunkbush.....		28		48		58	1
Silver buffaloberry.....	40-51	45	93-99	96	43-51	47	2
Common lilac.....	24-40	32	82-88	85	27-49	38	2
Jujube.....		1 39		64		61	1

¹ These values are 10 to 20 percent lower than can be attained under nursery conditions and where the seed has been properly pretreated.

It is strongly suspected that the method of handling the species which have embryo dormancy can be improved considerably, and that higher germination of these species can be obtained in the nursery by keeping stratification temperatures near 40° to 45° F. with

adequate moisture content in the stratification medium. It is also believed that the degree of ripeness at the time of collection is an important item in the germination of the seed of species which show embryo dormancy.

RELATION OF LABORATORY TO FIELD GERMINATION

Table 5 shows the relation of laboratory germination to field germination, as determined by Alba H. Briggs of the Prairie States Forestry Project, in 1938, from tests conducted during the 1937 nursery season at Fremont, Nebr. The 1937 season was characterized by favorable weather during the germination season and, therefore, the data may at least be considered indicative of what might be expected during an average season under conditions similar to those existing at the Fremont nursery.

A study of table 5 reveals that the sowing ratios discussed later in this publication in connection with table 22 can to a large degree be justified on the basis of the variance existing between laboratory and field germination. Briggs explains that this difference represents measurements of two different quantities under different sets of conditions; i. e., laboratory germination tests are a measure of germinative capacity under the controlled ideal conditions in the laboratory, while field results are a measure of emergence capacity under variable adverse conditions of depth of sowing, moisture, temperature, and other factors seldom subject to complete control.

TABLE 5.—*Emergence capacity in nursery plots expressed in percent of laboratory germination tests*

Species	Laboratory germination (A)	Emergence in field sowings (B)	B/A
Medium-to-tall deciduous trees	<i>Percent</i>	<i>Percent</i>	<i>Percent</i>
Northern catalpa.....	71	52	73
Green ash.....	90	43	48
Honeylocust.....	90	80	89
Kentucky coffeetree.....	91	84	92
Black locust.....	78	18	23
Osageorange.....	60	30	50
Hackberry.....	60	44	73
Red mulberry.....	91	60	66
Short trees and shrubs:			
Lilac.....	37	16	43
Common chokecherry.....	30	8	27
Tatarian honeysuckle.....	52	5	10
Siberian pea-tree.....	80	62	78
Russian-olive.....	80	40	50

SUMMARY OF COLLECTION AND HANDLING PRACTICES

For convenience, preferred practices in collection, extraction, storage, and pretreatment of seed, as developed by the Forest Service for the various species, are summarized in table 6.

TABLE 6.—Summary table for seed collection, extraction, storage, and treatment for species suitable for planting in the prairie-plains region

Species ¹	Form, habitat, and range in the prairie-plains	Type of fruit	Time of collection	Method of collection	Method of extraction	Remarks on collection and extraction	Extraction factor by weight	Clean seed per pound ²	Probable type of seed damage ³	Recommendation for seed storage and pretreatment
			Code number	Code number	Code number		Percent	Number	Code number	
Medium-to-tall deciduous trees: Ailanthus.	Medium-height tree; introduced from China.	Oblong samaras borne in large clusters.	3 or 4	7 or 8	10	Seed ordinarily plentiful	85-90	17,000	18	Dry storage. No pretreatment necessary.
Ash, green, or prairie.	Medium-height tree; stream banks and draws; North Dakota to Texas.	1-seeded samara shape like canoe paddle, hanging in clusters.	4 or 5	7 or 8	10	Usually a sure crop. Seed may be stored for several years.	75	14,500-18,000	16	Fall-sow or soak in cold water changed daily 1 to 2 weeks before sowing. Or store seed dry and stratify 30 to 60 days before sowing.
Boxelder.	Medium-height native tree; stream banks, sandhills; from North Dakota to Texas.	Compressed samaras borne in pairs in clusters.	3 or 4	7 or 8	10	Seed very often empty. Examine closely before collection.	75	14,000-18,000	16	Fall-sow or stratify for 90 days.
Catalpa, northern.	Medium-height tree; introduced; planted from Nebraska to Oklahoma.	Stout, thick-walled capsule. Seed light brown with rounded fringed ends.	4 or 5	7	13	Seed ordinarily plentiful. Closely resemble inferior <i>Catalpa bignonioides</i> Walt. having thin-walled capsule and silver-gray seed, with pointed fringed ends.	10-25	13,000-36,000	18	Dry cold storage over winter. No pretreatment necessary, but seed will germinate faster if kept in wet sand several days.
Coffeetree, Kentucky.	Medium-height native tree; rich bottom lands; southeastern South Dakota to Texas.	Brown pod 6 to 10 inches long and 1 to 2 inches wide.	4 or 5	6, 7, or 8	10	Seed usually plentiful in native habitat. Dry thoroughly before cleaning.	40	200-250	15	Dry storage. Acid treatment for 4 hours is preferred.
Cottonwood	Native tall tree; bottom lands throughout the plains	A capsule containing seeds of gray-white color.	1	7 or 8	10	Cotton separates readily from seed when macerated.	4-15	250,000	18	Sow immediately after extraction. If stored, leave seed in capsule.
Elm, American	Native tall tree; along streams; North Dakota to Texas.	A samara hanging in clusters. Seed a compressed nutlet.	1	8	14	Seed crop uncertain, since early fruiting invites frost injury. Heats easily. Spread out in thin layer to dry.	50	90,000-100,000	-----	Spring-sow as soon as collected. Can store 1 year, if thoroughly dried, in cool place, air tight containers.
Elm, Chinese	Medium-height tree; introduced from China.	do.	3	8	14	Seed sources limited. Generally purchased from vendors.	50	150,000	18	Cold dry storage. Sow in spring.

Species	Medium-to-tall tree; introduced from China.	do. ⁴	1	8 or 7	14	Crop uncertain. Collect as soon as it starts to turn straw color. Seed must be dried before sacking. Heats easily, but seed can be stored for several years. Cheaper to gather after leaves have fallen.	50	18	Spring-sow. Can store 1 year in tight containers, low temperatures.
Hackberry	Medium-height tree; stream banks; hillsides; sand hills; North Dakota to Texas.	Purplish, 1-seeded drupe about 1/4 inch in diameter.	4 or 5	7 or 8	14	Good years infrequent, but seed can be stored for several years. Cheaper to gather after leaves have fallen.	55,000	16	Fall-sow or stratify for 90 days prior to spring sowing. ⁵
Honeylocust, or thornless.	Medium-height tree; stream banks; southeastern South Dakota to Texas.	Elongated, many-seeded brown, hispid pod, 10 to 16 inches long.	4 or 5	6, 7, or 8	10	Seed normally plentiful. Dry thoroughly before cleaning. Thornless variety usually preferred.	2,800-3,000	15	Dry storage over winter. Acid treatment for 1 hour preferred; mechanical scarification satisfactory; hot-water soaking successful.
Locust, black	Medium-height tree; native east of plains, but widely planted Nebraska southward.	A 4- to 8-seeded, light brown, elongated pod.	4	8	10	Generally fair seed crop	26,000	15	St. dry over winter. Test to determine best acid treatment. Mechanical treatment also successful.
Mulberry, red, or Russian.	Medium-height tree. Hardy from southeastern South Dakota southward.	Numerous 1-seeded drupelets developing into a berrylike aggregate.	1 or 2	8	11	Crop usually plentiful; long ripening period. Mash and soak in water for 1 day before macerating.	2 250,000-350,000	18	Hold in dry cold storage. No pretreatment necessary; water soaking accelerates germination.
Oak, bur	Native medium-height tree; stream banks; North Dakota to Texas.	A nut (acorn) partially enclosed in fringed cuplike hull.	4	6, 7, or 8	14	Seed crop uncertain. Store seed in cool, humid places. Not necessary to remove cups.	100	18	Fall sowing preferred. Can hold over winter in cool humid basement without stratification or stratify in outside pits.
Osageorange	Native medium-height tree; along streams; southeastern Kansas to Texas.	Drupaceous fruit, united into a compound fruit. Resembles a large green orange, each with 70 to 250 seeds.	4 or 5	6	11	Seed usually abundant. Mash before running through macerator.	2-5 12,000	16	Hold in dry storage. Soak in fresh cold water, changed daily for 5 to 7 days before spring sowing.

Code:—Continued. Probable type of seed dormancy:
 15. Seed coat.
 16. Embryo.
 17. Both seed coat and embryo.
 18. None.

Code—Continued. Method of extraction:
 9. Rub seed through 2- or 3-mesh screen.
 10. Run dry through macerator and fan to remove impurities.
 11. Run wet through macerator with water and float off or screen out pulp.
 12. Remove hulls by hand or run through corn sheller to remove husks.
 13. Dry, beat lightly, and screen out seed.
 14. Only extraction necessary is to separate from leaves and twigs by screening or fanning.

Code:—Continued. Time of seed collection:
 1. Late spring.
 2. Summer.
 3. Early fall.
 4. Fall.
 5. Winter.
 Method of collection:
 6. Pick from ground after natural fall.
 7. Hand pick from trees or shrubs.
 8. Flail or strip onto canvas, burlap, or cheesecloth.

See footnotes at end of table.

TABLE 6. Summary table for seed collection, extraction, storage, and treatment for species suitable for planting in the prairie-plains region—Continued

Species ¹	Form, habitat, and range in the prairie-plains	Type of fruit	Time of collection	Method of collection	Method of extraction	Remarks on collection and extraction	Extraction factor by weight	Clean seed per pound ²	Probable type of seed dormancy ³	Recommendation for seed storage and pretreatment
			Code number	Code number	Code number		Percent	Number	Code number	
Medium-to-tall deciduous trees—Continued.										
Pecan	Medium-height native tree; rich bottom lands; Oklahoma and Texas.	Oblong nut encased in thin husk.	4	6, 7, or 8	14	Seed crop uncertain. Avoid excessive drying.	100	125-150	16	Fall-sow or stratify 30 to 45 days before spring planting.
Peristemon, common.	Medium-height tree; stream banks; Kansas, Oklahoma, and Texas.	Pale orange, ovate, oblong berry, 1 to 1½ inches in diameter with 3 to 8 seed.	4 or 5	6, 7, or 8	11	Seed usually plentiful and easily collected. Seed embryo enclosed in endosperm.	10-20	1, 300	16	Cold dry storage, spring sowing recommended; soak several days in cold water.
Soapberry, western.	Native medium-height tree; stream banks or on sand dunes; southern Kansas to Texas.	One-seeded drupe in clusters. Yellow semitranslucent flesh. 4 furrs black in winter. Persistent.	4 or 5	7 or 8	11	Seed usually abundant. Avoid heat in g. Spread on floor and moisten until soft before extracting.	30	1, 700	15	Acid treatment 2 hours. Fall sowing without treatment also successful. Also, 30 days stratification before spring sowing.
Sycamore, American.	Native tall tree; bottom lands; southeastern Nebraska to Texas.	An aggregate (ball) 1 foot in diameter composed of numerous flattened, fleshy, indohiscent excarp enclosing hard, thick-walled nut.	4 or 5	7 or 8	9	Seed normally plentiful. Can run seed through motor to break up balls.	7	150,000 200, 000	16	Spring-sow; stratify 45 days.
Walnut, black	Medium-height native tree; rich bottom lands; South Dakota to Texas.	Round drupe with fleshy indohiscent excarp enclosing hard, thick-walled nut.	4	6, 7, or 8	12 or 14	Crop generally plentiful. Not necessary to remove husk unless reduction of bulk is desirable.	40-65	32-45	16	Fall-sow or stratify over winter in outside pits.
White, Texas.	Medium-height native tree; bottom lands; western Oklahoma and Texas.	Same as black walnut, smaller nut and thinner husk.	4	6, 7, or 8	12 or 14do	40-65	78	16	Do.
Short trees or shrubs:										
Apricot	Small tree; introduced from Russia; hardy from Nebraska southward.	Large, edible, one-seeded drupe.	2	6, 7, or 8	11	Crop uncertain. Seed often purchased from farmers. Avoid cooked seed.	30-40	200-300	16	Sow late in fall or store dry and stratify 38 to 45 days before spring sowing.
Bladder-senna	Shrub; introduced from Europe.	Inflated pod with pappery walls.	2 or 3	6 or 7	10	Seed sources limited.	50	27, 000	15	Dry storage until sowing. Acid treatment 20 minutes. Mechanical scarification also successful.

	3 or 4	7	11	20-30	16
Buckthorn, Siberian.	Clusters of small, black drupes.	7	11	24, 000	16
Buffaloberry, silver.	One-seeded, small red berry.	8	11	30, 000-40, 000	16
Chaste-tree, lilac.	Small drupe enclosing a stony seed.	7 or 8	10	59, 200	16
Chokecherry, common, and western.	1-seeded, edible, dark-colored drupe, 1/4 inch in diameter.	7 or 8	11	4, 300-6, 000	16
Crab, Siberian	Small pome 1/4 inch or more in diameter.	7	11	77, 000	16
C u r r a n t, golden.	A juicy berry containing several seeds.	7	11	200, 000	16
Desertwillow	Slender, elongated, thin-walled capsule 7 to 12 inches long.	7	13	85, 000-100, 000	18
Elder, American.	A berrylike drupe with 3 to 5 1-seeded nutlets hanging in cymes.	7	11	175, 000	16
Hawthorn	A bony one-seeded nutlets.	7 or 8	11	7, 700-16, 000	17

Code- Continued.
 Probable type of seed dormancy:
 15. Seed coat.
 16. Embryo.
 17. Both seed coat and embryo.
 18. None.

Code- Continued.
 Method of extraction:
 9. Rub seed through 2- or 3-mesh screen.
 10. Run dry through macerator and fan to remove impurities.
 11. Run wet through macerator with water and float off or screen out pulp.
 12. Remove hulls by hand or run through corn sheller to remove husks.
 13. Dry, beat lightly, and screen out seed.
 14. Only extraction necessary is to separate from leaves and twigs by screening or fanning.

Code:
 Time of seed collection:
 1. Late spring.
 2. Summer.
 3. Early fall.
 4. Fall.
 5. Winter.
 Method of collection:
 6. Pick from ground after natural fall.
 7. Hand pick from trees or shrubs.
 8. Flail or strip onto canvas, burlap, or cheesecloth.

See footnotes at end of table.

Fall-sow, or store dry and stratify 90 days before sowing.
 Fall planting preferable or stratify for 90 days.
 Stratify 90 days.
 Plant in fall or stratify 120 days and sow early in spring.
 Fall-sow or stratify for 75 days before spring sowing.
 Fall-sow or store dry and stratify 90 days before spring sowing.
 Dry cold storage. No pretreatment necessary but seed will germinate faster if kept in wet sand several days.
 Avoid drying of seed. Stratify 90 days before sowing.
 Avoid drying of clean seed. Stratify at 41° F. until germination; may take 1 or 2 years. Mechanical or acid scarification probably helpful.

TABLE 6.—*Summary table for seed collection, extraction, storage, and treatment for species suitable for planting in the prairie-plains region—*
Continued

Species	Form, habitat, and range in the prairie-plains	Type of fruit	Time of collection	Method of collection	Method of extraction	Remarks on collection and extraction	Extraction factor by weight	Clean seed per pound	Probable type of seed dormancy	Recommendation for seed storage and pretreatment
Short trees or shrubs—Con. Honey-suckle, Tatarian.	Shrub; introduced from Siberia, adapted to northern and central plains.	Several-seeded berry.	Code number 2	Code number 7 or 8	Code number 11	Seed crop usually plentiful.	Percent 5	Number 125,000-185,000	Code number 16	Store dry. No pretreatment necessary but water soaking accelerates germination.
Jujube	Small tree; introduced from Asia.	Large, edible, one-seeded drupe about 1 inch long.	4	7	11	Seed sources limited.	25-35	1,000-1,200	17	Fall-sow or stratify 90 days before spring sowing.
Lilac, common.	Low shrub; introduced from Europe.	An oblong, leathery capsule with 2 winged seeds in each 2 cells.	3	7	10	Seed crops fair. Avoid heating. Difficult to fan seed because of possible loss.	1	54,000-115,000	16	90 days' stratification or several days' soaking in fairly warm water (keep fresh) until seed coat soft. Then sow.
Maple, Tatarian.	High shrub; adapted to northern plains; introduced from China.	Compressed samaras borne in pairs in clusters.	3 or 4	7	10	Seed sources limited.	70	14,000-16,000	16	Fall-sow, or stratify immediately for spring sowing.
Nannyberry.	Native tall shrub; moist and protected areas; eastern North Dakota, South Dakota, and Nebraska.	A blue-black drupe with a one-seeded, compressed stone.	3	7	11	Seed normally abundant and easily collected.	60	* 2,180	16	Best practice seems to be stratification for a full year and then early fall sowing.
Pea-tree, Siberian.	Shrub, adapted to northern plains, introduced from Siberia.	Small dehiscent pod usually 2 to 3 inches long.	2	7 or 8	10 or 13	Collection period one week or less. Supply sometimes limited but seed can be stored from good seed years. Guard against heating of newly collected pods.	10-40	15,000-20,000	18	Dry storage. No treatment necessary but germination more rapid if seed is water-soaked or lightly scarified.
Plum, Chickasaw, sand, or American.	Native shrubs, thickets along streams or on sandhills throughout plains region.	One-seeded edible drupe varying from yellow to dark red.	2 or 3	6, 7, or 8	11	Avoid excessive drying of pits.	12-25	800-1,500	16	Fall planting preferred, or stratify 120 days and sow in early spring.
Redbud	Short tree, along stream courses; southeastern Nebraska to Texas.	Oblong, flat, brownish, many-seeded pod, 2 to 4 inches long.	4	7 or 8	10	Seed crop is usually light but viability holds up well in storage.	20-30	14,400	15	Dry storage, responds well to 30- to 60-minute acid treatment. Mechanical treatment also successful.

Russian-olive	Tall shrub; introduced from Russia.	Drupelike, with meaty outer flesh and ellipsoid strata stone.	4	7 or 8	11	30-75	1,000-3,800	16
Serviceberry, common.	Shrub, wooded draws and stream courses; North Dakota, South Dakota, and Nebraska.	Small blue-black berrylike pome with 4 or more seeds.	2	7	Seed ordinarily plentiful in northern plains. Numerous strains—small-seeded shiny form believed hardiest. Seed ordinarily scarce. Soak seed in water before extracting.	2	63,000	17
Skunkbush	Native low shrub found on dry hillsides and sandy ridges from North Dakota to Texas.	Many-seeded, compact cluster.	3 or 4	7	Seed very plentiful and easily collected. Soak before cleaning.	50	10,600	17

Code:

Time of seed collection:

1. Late spring.
2. Summer.
3. Early fall.
4. Fall.
5. Winter.

Method of collection:

6. Pick from ground after natural fall.
7. Hand pick from trees or shrubs.
8. Flail or strip onto canvas, burlap, or cheesecloth.

Code: Continued.

Method of extraction:

9. Rub seed through 2- or 3-mesh screen.
10. Run dry through macerator and fan to remove impurities.
11. Run wet through macerator with water and float off or screen out pulp.
12. Remove hulls by hand or run through corn sheller to remove husks.
13. Dry, beat lightly, and screen out seed.
14. Only extraction necessary is to separate from leaves and twigs by screening or fanning.

Code: Continued.

Probable type of seed dormancy:

15. Seed coat.
16. Embryo.
17. Both seed coat and embryo.
18. None.

¹ For scientific names of plants listed, see p. 158.

² Refers to seed with pulp or pod removed, except where indicated.

³ These represent tentative findings, since the type of seed dormancy for some of these species has not yet been fully worked out.

⁴ Siberian elm will cross with American elm under some conditions.

⁵ With pulp on.

⁶ Similar treatment for net-leaf hackberry and sugarberry. These two species can be distinguished by their orange-red or yellow fruit and are found southward from central Kansas.

⁷ Similar treatment for post oak.

⁸ With hulls on.

16. Fall-sow or stratify 90 days. Fair germination from unstratified seed soaked in water until swollen.

17. Avoid excessive drying of seed. Stratify 150 to 180 days.

17. Fall-sow or stratify 120 days before spring sowing; or acid treatment for 20 minutes; or soak in hot water.

SELECTION AND MAINTENANCE OF THE NURSERY SITE

The proper selection of a nursery site is a prime essential in successful nursery management. The topography, location, fertility, and texture of the soil and the quality and accessibility of irrigation water will markedly affect the cost of production of the nursery stock. Closeness to market or to the planting operation is an additional point to consider.

TOPOGRAPHY AND LOCATION

The ideal nursery site in the prairie-plains region is most likely to be a smooth, flat, stone-free, and moderately sandy soil on a stream terrace (fig. 10) or in an area formerly occupied by a glacial lake. Some upland sites are also satisfactory. It is highly desirable that the site have a uniform slope, preferably in one direction, in order to facilitate furrow irrigation. Acceptable gradient varies with soil texture, ranging from a minimum of 0.25 percent on the finer-textured soils having a slow infiltration rate up to a maximum of 2.0 percent on the sandier soils that permit rapid infiltration. A hilly or choppy surface adds so tremendously to the cost of the nursery operation that it is poor economy to begin nursery production on anything but the best available site even though the initial cash outlay may seem high.

One of the things to consider in the selection of a nursery site is the avoidance so far as possible of damage from frequent hailstorms. A study of the hail-insurance rates for the six prairie-plains States, based on the location of definite hail belts by the insurance companies, reveals an increasing probability of hail as one proceeds westward. Also certain local areas, such as the sand hills of Nebraska and the rolling morainic lands in the central and eastern parts of the Dakotas, where comparatively rough topography prevails, have higher rates than surrounding land. Such areas should be generally avoided in selecting a nursery site.

It is a well known fact that local terrain has a marked effect on the severity and occurrence of late spring and early fall frosts. Danger areas generally lie in basins where there is lack of adequate air movement and should be avoided in selection of a nursery site.

SOIL TEXTURE

Forest Service experience in producing many millions of deciduous seedlings has definitely shown that moderately sandy soils are most desirable for nurseries. The top 18 to 24 inches of the soil should range from a sandy loam to a loam, although the lighter silt loams are fairly satisfactory. Heavier soils are recommended only if the class of stock produced is to be balled and burlapped.

The substratum must be reasonably retentive of moisture. Sites with open and porous coarse sand or gravel substrata should be avoided, unless an overhead irrigation system is available, because of the frequent irrigation necessary on such soils. It is desirable, where furrow irrigation is used, to have a somewhat heavier subsoil below the 2-foot depth in order to retain moisture within reach of the tree roots. Its texture can range from a sandy clay to a loam, silt loam, or clay loam. If such a subsoil is present, it must be determined with reasonable certainty that no trouble will be encountered



F508455

FIGURE 10.—A Forest Service deciduous-tree nursery on terrace soil adjacent to the Missouri River, near Mandan, N. Dak.

later because of salinity, either from salts present in the soil itself or use of water highly charged with salts.

On mechanical analysis the topsoil should preferably indicate 30 to 50 percent silt plus clay⁹ and 50 to 70 percent sand, and it is desirable that the ratio of silt to clay range from 2:1 up to 4:1. Too much clay (over 20 percent) in the topsoil causes undesirable baking and cracking. A sandy clay topsoil would not be considered ideal because of its tendency to form crusts, which seriously hinder emergence.

Mechanical analyses of various portions of several prairie-plains nurseries are given in table 7. It will be noted that the soils consid-

TABLE 7.—Mechanical analyses of several prairie-plains nursery soils¹

Nursery and area	Sand	Total silt plus clay	Silt	Clay	Remarks
Fremont, Nebr.:					
Area A.....	66.6	33.4	25.2	8.2	Good hardwoods. An ideal nursery soil from point of view of texture.
Area B.....	79.0	21.0	18.0	3.0	Good ponderosa pine grown here.
Towner, N. Dak.....	86.3	13.7	8.0	5.7	Fairly good for conifers but too sandy for most hardwoods. Much improved by addition of liberal amounts of animal manures and superphosphate.
Sioux Falls, S. Dak.:					
Area A.....	47.1	52.9	39.8	13.1	Good 1-0 ² Chinese elm in this part of nursery. An ideal nursery soil.
Area B.....	58.7	41.3	32.4	8.9	Alkali spot in which 1-0 ² Chinese elm was stunted and chlorotic.
Pierre, S. Dak.:					
Area A.....	27.2	72.8	38.3	34.5	Good 1-0 ² green ash in this part of nursery, but soil is hard to work.
Area B.....	10.9	89.1	62.1	27.0	Alkali spot in which 1-0 ² green ash was stunted and chlorotic.
Midway, S. Dak.:					
Area A.....	24.7	75.3	46.0	29.3	Good 1-0 ² American elm grown here. Soil heavy for good tilth.
Area B.....	22.8	77.2	47.3	29.9	Alkali spot in which 1-0 ² American elm was stunted and chlorotic.

¹ Samples were taken to a depth of 1 foot. Soil separates determined by Bouyoucos' hydrometer method.

² 1-year seedlings not transplanted before field planting.

³ Silt plus clay refers to those soil particles that are less than 0.05 mm. in diameter. Silt ranges from 0.05 to 0.005 mm. and clay is 0.005 or finer. The clay particles that are 0.002 mm. or finer are known as fine clay and are colloidal in character. Sands range from 0.05 to 2.0 mm.

ered ideal for hardwoods have approximately a 3:1 ratio of silt to clay, with the silt-plus-clay fraction constituting less than 35 percent.

If part of the nursery is to be devoted to growing conifer seedlings, the sandier portion is most suitable, preferably where the soil is a light sandy loam or loamy sand, with a silt-plus-clay content between 15 and 30 percent.

Following are a number of reasons why moderately sandy soils are considered better than heavier soils for nursery production:

They can be worked earlier in the spring and soon after rains or irrigation and require less power in tillage.

Irrigation is uniform because of rapid and even absorption of water.

They crust and bake less on the surface, an important consideration during the germination period.

They absorb a larger percentage of the precipitation, because of decreased water loss through run-off and surface evaporation.

They are not so apt to get waterlogged under heavy irrigation.

Salt problems are not usually as serious on sandy as on heavy soils, especially where there is reasonably good underdrainage.

Sturdier and better balanced plants are obtained and root development is better, provided the soil is adequately fertile.

Less damage is incurred by root stripping during the digging.

Sandy soils are much superior for the heeling-in of stock and, since some growers use a portion of their nursery as an overwinter heel-in ground, this is an additional consideration.

On the other hand, soils classed as loams or silt loams are preferred by some nurserymen because they have the following advantages over sandy soils:

Fertility is usually greater and therefore sustained production can be maintained over a longer period without resorting immediately to the more expensive measures for maintaining soil fertility.

Less difficulty is encountered from soil blowing, and snow-fence windbreaks and other measures employed to protect against this factor are consequently not so essential.

The soils have greater moisture-retaining ability, thereby reducing moisture losses through percolation below reach of tree roots. A thorough irrigation will remain effective longer on heavier soils.

There is less likelihood of loss through leaching of soluble commercial fertilizers, such as ammonium sulfate and potash.

Before selecting a nursery site, the grower should determine the availability of detailed soil surveys. These survey maps and reports, published jointly by the United States Department of Agriculture Bureau of Plant Industry (formerly by the then Bureau of Chemistry and Soils) and the State agricultural colleges, are an invaluable aid in locating desirable sites. They are generally published for individual counties and consist of a report of the agricultural possibilities of different soil series and types, and in addition have a fairly detailed soil-type map on the scale of 1 inch to the mile.

Among the soils best adapted to a hardwood nursery are the moderately sandy to medium-textured soils of the following series:¹⁰ Bearden (T), Bridgeport (T), Canadian (T), Cass (B), Hall (T), Lincoln (B), Miles (U), Miller (B), Pratt (U), Reinach (T), Spur (B), Tripp (T), Yahola (B).

¹⁰ U = Upland; T = Terrace; B = First bottom or flood plain.

The soils listed as occurring on bottom land may be subject to flooding during periods of high water. If a nursery is to be located on these soils, a careful investigation should be made as to the height of past flood stages in relation to the proposed nursery site. There are, of course, other upland soils that are also suitable for growing deciduous nursery stock but the water table is generally deeper and development of an irrigation system is more expensive on the upland sites.

CHEMICAL COMPOSITION AND SOIL ANALYSES

The soil of the nursery site should be of high fertility and reasonably free from harmful alkalis. Inadequate soil fertility and a poor balance of nutrients result in a relatively large percent of cull stock and high production costs, and proper fertilization and cropping methods are necessary for optimum production. Expressed in a general way, any moderately sandy soil that is producing good yields of agricultural crops such as wheat, corn or sorghum, and cotton will produce satisfactory deciduous stock. Deciduous seedlings require more fertile and somewhat heavier soils than do most of the conifers.

Soil analyses can be of value in selecting nursery soils and also in determining to some extent soil fertilization and crop-rotation practice. These analyses may be expressed either in terms of total or available nutrients. In recent years, analyses based on the relative availability of various nutrients such as phosphorus and potash have been favored over the method wherein total analyses only are considered. Soils may sometimes show fairly high values in total analyses and still not have an adequate supply of nutrients in a form readily available for plant growth. For example, a soil may test fairly high in total phosphorus but still be low in readily available phosphorus, because the phosphorus is tied up in a relatively insoluble state by iron, aluminum, or calcium.

In order to arrive at some preliminary conclusions on the relation of soil condition to the quality of nursery stock produced, analyses were made of the same prairie-plains nursery soils represented in table 7.

The resulting data, shown in table 8, include several nurseries where patches of "alkali" soils caused difficulty. These patches ranged from 20 to 50 or more feet in diameter and in most of the prairie-plains nurseries were caused by so-called white alkalis. The data presented reveal some striking differences in soils; even in the same nursery variations were so great as to cause a marked difference in the quality of the stock.

At Towner Nursery good response was obtained from treatments of 20 tons of sheep manure fortified by 150 to 200 pounds per acre of 45-percent superphosphate.

The problem areas in the Pierre and Midway nurseries are small saline spots on which seedlings build up salts in the plant tissue. This interferes with the normal metabolism of the plant and so causes it to develop poorly. In both nurseries there is a higher soluble salt content in the more alkali spots, especially in Midway nursery where there is an appreciably higher content of sodium and potash salts.

TABLE 8.—*Chemical analyses of several prairie-plains nursery soils*¹

Nursery and area	pH	Total nitrogen	Total soluble salts	Available phosphorus	Available potash	Available manganese	Replaceable and soluble sodium	Ammonia nitrogen
		Percent	Parts per million	Percent	Percent	Percent	Percent	Percent
Fremont, Nebr.:								
Area A.....	6.0	0.098	320	0.0052	0.0423	0.0052	0.027	0.0015
Area B.....	6.8	.060	280	.0053	.0301	.0026	.028	.0020
Towner, N. Dak.....	7.2	.108	470	.0024	.0107	.0290	.027	.0012
Sioux Falls, S. Dak.:								
Area A.....	5.8	.189	680	.0025	.0196	.0211	.029	.0015
Area B.....	5.8	.182	370	.0023	.0176	.0149	.025	.0015
Pierre, S. Dak.:								
Area A.....	8.4	.142	1,300	.0107	.0541	.0037	.039	.0016
Area B.....	8.6	.153	1,550	.0106	.0543	.0035	.038	.0016
Midway, S. Dak.:								
Area A.....	8.2	.358	1,770	.0051	.1182	.0015	.039	.0015
Area B.....	8.4	.378	2,380	.0021	.3045	.0015	.047	.0012

Nursery and area	Replaceable calcium	Replaceable magnesium	Base-exchange capacity	Iron as Fe ₂ O ₃	Remarks
	Mil.-eqs. per 100 g.	Mil.-eqs. per 100 g.	Mil.-eqs. per 100 g.	Percent	
Fremont, Nebr.:					
Area A.....	5.22	1.14	8.95	1.68	Good for most hardwoods.
Area B.....	3.68	.29	5.55	2.31	Good for ponderosa pine.
Towner, N. Dak.....	8.70	1.69	9.55	2.63	Too light for most hardwoods.
Sioux Falls, S. Dak.:					
Area A.....	13.90	4.02	19.65	2.67	Good for 1-0 ² Chinese elm.
Area B.....	10.53	.72	12.75	1.20	Poor for 1-0 ² Chinese elm. Chlorotic.
Pierre, S. Dak.:					
Area A.....	37.50	6.22	29.55	3.61	Good for 1-0 ² green ash. Soil hard to work.
Area B.....	52.30	9.18	28.85	3.27	Poor for 1-0 ² green ash. Saline spot.
Midway, S. Dak.:					
Area A.....	56.65	14.35	47.80	4.35	Good for 1-0 ² American elm.
Area B.....	67.40	18.78	49.05	3.95	Stunted and chlorotic 1-0 ² American elm. Saline spot.

¹ Analyses by Soils Department, University of Wisconsin. Only the top foot of soil was sampled. Analyses were made by the following methods: pH, LaMotte-Kenney; total nitrogen, Kjeldahl; total soluble salts, A. O. A. C.; available phosphorus, Denige-Truog; available potash, Volk-Truog; available manganese, extraction with normal acetate and determination by oxidation; replaceable and soluble sodium, Bray's modification; ammonia nitrogen, Harper's modification; replaceable calcium and magnesium and base-exchange capacity (in milli-equivalents per 100 grams), Chapman and Kelley; iron as Fe₂O₃, by fusion and reduction of the ferric iron by Jones' reductor and titration with standard permanganate.

² 1-year seedlings not transplanted before field planting.

The cause of the poor development of Chinese elm in parts of the Sioux Falls nursery is not so obvious from the soil analysis but indications are that the limiting factor may be magnesium, iron, or possibly phosphorus. The lower base-exchange capacity in the poor spots suggests possible benefit from animal manures supplemented by superphosphate and dolomitic limestone. Field tests are under way in this particular nursery in an attempt to solve the problem of why Chinese elm alone, of all the species grown here, is of low quality in some spots.

SPECIAL PROBLEMS IN ALKALINE SOILS

A rather common problem in nurseries located in arid or subhumid regions is caused by the presence of salt in the soil, which occurs most frequently in small patches of a few hundred to a few thousand square feet in area, and causes a reduction in stand density, stunting of the growth, a chlorotic condition of the leaves, and sometimes death of the plant (fig. 11).

Alkalis can be grouped for practical purposes into two classes, viz: White and black alkalis. White alkalis include rather loosely all sulfates and chlorides of sodium, magnesium, and potassium, as well as calcium chloride. These alkalis leave a white crust on the surface of the soil and along irrigation ditches whenever they become concentrated by surface drying. Black alkali consists of sodium carbonate, leaves dark spots on the surface of the soil, and causes it to become cloddy. The blackish, greasy-looking spots on the surface are caused by action of sodium carbonate in dissolving humus in the soil.

Alkalis are harmful in several ways. If present in sufficient quantity they reduce or prevent the absorption of water by the plant roots, owing to the high concentration of salts in the soil solution.



F261054

FIGURE 11.—Failure of Chinese elm due to localized patch of saline soil.

The result is malnutrition of the plant because of a poor balance of available plant food. Black alkali creates an unfavorable physical condition of the soil known as "puddling."

The alkalis vary in their toxicity to plants, but all sodium salts are relatively quite toxic. Hilgard (16) states that one-tenth of 1 percent of sodium carbonate, one-fourth of 1 percent of sodium chloride, or one-half of 1 percent of sodium sulfate is the limit of tolerance of some agricultural plants.

Scofield (33) in discussing alkali problems indicates that, when the total quantity of mixed salts in the soil solution exceeds 1.5 percent, plants show injury and it is necessary to leach out the root zone to reduce the amount of alkali.

Experience in growing deciduous nursery seedlings in the plains indicates that with the exception of some alkali-tolerant species, the trees are less tolerant of alkalis than most agricultural crops. Green ash was found to be seriously stunted in soils where the total soluble salts ran 5,675 pounds per acre or 1,550 parts per million.¹¹ American

¹¹ Refers to amount per acre of soil to a depth of 12 inches. An acre of soil to a depth of 12 inches will weigh from 3,430,000 to 3,770,000 pounds in most plains nurseries.

elm appeared more tolerant of alkalis but was adversely affected where total soluble salts constituted 8,160 pounds per acre or 2,380 parts per million (table 9).

TABLE 9.—Comparison of 1-0 nursery stock from alkali and nonalkali portions of tree nurseries¹

Measurement	Green ash		American elm	
	From normal areas	From alkali areas	From normal areas	From alkali areas
Length of top.....inches	10.2	3.3	16.2	9.2
Length of root.....do	11.6	9.2	13.3	10.1
Diameter of stem.....do	19/64	3/64	1/64	3/64
Oven-dry weight of tops.....grams	1.38	.18	4.35	.83
Oven-dry weight of roots.....do	1.89	.25	4.73	1.24
Oven-dry weight of total plant.....do	3.27	.43	9.08	2.07
Estimated cull stock ²percent	20	100	15	80

¹ Averages of 10 plants selected at random.

² This figure based on all trees in each area.

Tests made by the junior author on recently germinated seedlings in pure solutions of sodium sulfate and also sodium carbonate indicated that Russian-olive, desertwillow, honeylocust, and Siberian elm were the most alkali tolerant of some 20 species used commonly in shelter-belt planting in the prairie plains. The tests would indicate that, in a nursery where the alkalinity occurs only in certain blocks, the more alkali-tolerant species might have more chance of survival in the alkali portions of the nursery. Besides the above, it is certain that the salt cedar is also one of the more alkali-tolerant species.

What happens chemically to the plants on alkali spots is indicated in an analysis made of chlorotic and nonchlorotic seedlings in two nurseries (table 10). In both nurseries content of nitrogen, magnesium, sodium, sulfur, and chlorine was higher in the alkali-sick seedlings and iron content was considerably lower. At Pierre, S. Dak., phosphorus content was lower in the trees from the alkali area. "Iron hunger" is a direct cause of the yellowing of the foliage termed "chlorosis." Lack of available iron interferes with photosynthesis, the formation of chlorophyll, and the manufacture of food in the leaves. With the normal metabolism of the plant thus upset, the result is a puny, off-color seedling.

TABLE 10.—Chemical content percent of seedlings from portions of forest nurseries in South Dakota of variable salinity¹

Nursery, species, and condition of seedlings ²	Nitrogen	Phosphorus	Calcium	Magnesium	Sodium	Manganese	Sulfur	Chlorine	Iron
Pierre, S. Dak.:									
Vigorous green ash.....	0.790	0.171	0.481	0.165	0.0249	0.0011	0.214	0.033	0.0456
Stunted and chlorotic green ash.....	1.315	.142	.547	.274	.0278	.0014	.292	.041	.0296
Midway, S. Dak.:									
Vigorous American elm.....	.815	.079	.675	.176	.0227	.0007	.193	.052	.0480
Stunted and chlorotic American elm.....	1.150	.083	.850	.218	.0238	.0008	.202	.064	.0384

¹ Analyses by Soils Department, University of Wisconsin, using standard quantitative methods, with all values expressed in percent.

² All stock 1 year in seedbed.

TREATMENT OF ALKALINE SOILS

The important factor in the infertility of black alkali soils, according to Breazeale and McGeorge (6), is the poor carbon dioxide relationship. Carbon dioxide was found to be either completely absent or markedly deficient. In addition, the high alkalinity of such soils caused a marked depression or even cessation of nitrate and phosphate absorption. Even though there be an abundance of soluble phosphates, they are unavailable to the plant at a pH of 8.5 or higher, the optimum pH for absorption of phosphates and nitrates being around 6.8. For this reason treatment with sulfur or some other acidifying material will benefit the soil. It will be further benefited by addition of large amounts of organic matter such as manure, which in decomposing will greatly increase the supply of carbon dioxide and at the same time counteract the puddled condition prevalent in black alkali soils.

McGeorge (23), in studying the decline of citrus-growing areas in Arizona found that the clay in these black alkali areas had the peculiar property of fixing sodium in the base-exchange complex of the soil. Practical reclamation measures involve leaching out the alkali or neutralizing it with a calcium salt such as calcium sulfate. Acidifying of the soil or water was suggested. High pH of water was found to be a serious problem in Arizona in midsummer when the water sometimes reached a pH of 8.5. He found citrus trees generally well developed and in healthy condition when the soil pH was 8.45 or less. In extremely alkaline soils calcium starvation may be a factor in poor growth of plants.

If black alkali is present the soil can be improved with gypsum (calcium sulfate), sulfur, or other acid-forming material. These materials are applied at the rate of 200 to 1,000 pounds per acre, and as high as 2 tons in case gypsum is used.

If a thin layer of impervious soil is found within 3 or 4 feet of the surface, and is underlain by a more porous material such as sand, it will be feasible to lay tile to drain localized alkali spots.

There are other measures that can be used to supplement underdrainage. Among these are scraping the salts from the surface of the soil at a time when the soil is rather dry and when a high proportion of the salts are located in the top inch of soil. Also recommended are deep tillage, good cultivation, avoidance of leaky irrigation ditches, and heavy applications of manure. None of these measures are substitutes for underdrainage. They merely supplement it.

SOIL TESTING AND INTERPRETATION

Soil tests can be of aid in determining the method of handling alkali soils. A suggested method is to sample several of the alkali spots from the surface to a depth of 2 or 3 inches and then at the 1-, 2-, 3-, and 4-foot levels.

Field test kits developed by Truog, Spurway, and other investigators can be of aid to the nurseryman in determining the type of alkalis present and to gauge the approximate treatment needed.

The minimum test should include pH, chlorides, sulfates, and a test for presence of carbonates. These tests might well be supplemented by a laboratory test for total soluble salts and a test for sodium.

A pH of 8.8 or over indicates the probable presence of some sodium carbonate, and one of more than 9.0 indicates this compound to be present in considerable quantities. This would immediately suggest the necessity of supplementing underdrainage with treatments of gypsum or sulfur.

A pH of 8.2 to 8.8 would indicate presence of white alkali, and this test can be supplemented by a test for sulfates and chlorides. If the latter exceeds 2,000 parts per million there is a certainty that these materials are present in sufficient quantity to interfere with normal development of the seedlings, and will require corrective measures. Some of the more sensitive tree species may show adverse effects from quantities as low as 1,500 parts per million. Such tests can be supplemented by observations on stunting or chlorosis of the seedlings, and of any accumulation of alkali in the form of a white crust or dark-colored spots on the surface of the soil.

All observations available to date on value of pH as a test indicate when values are below 8.2 that most shelterbelt tree and shrub species are not adversely affected. It is in the range of pH 8.2 to 8.8 that more or less serious symptoms of "salt sickness" appear.

MINIMUM FERTILITY REQUIREMENTS

The determination of a proper balance of nutrients for growing hardwood seedlings remains to be worked out in detail for various species. Minimum standards of fertility have, however, been worked out on the basis of the present available information and experience, as given in table 11. The values represent what may be considered minimum requirements for the average nursery, and there is no doubt that a soil with twice the amount of nitrogen, phosphorus, potash, calcium, and magnesium, and twice the base-exchange capacity listed in table 11 would produce excellent nursery stock. If the analysis of the soil from a proposed nursery site runs considerably below the standards shown, a better site should be selected, unless other factors which are in favor of the site, such as ideal location, good water supply, or low cost of land, outweigh the lack of adequate fertility. In such case the soil must be built up by fertilization and use of soiling crops.

TABLE 11.—Minimum standards of fertility for growing of hardwoods for prairie-plains planting

Fertility standard	Minimum level of fertility	Approximate equivalent	Fertility standard	Minimum level of fertility	Approximate equivalent
	<i>Percent</i>	<i>Pounds per acre</i>		<i>Milliequivalents per 100 grams</i>	<i>Pounds per acre</i>
Preferred pH.....	6.0 to 8.0		Replaceable calcium.....	10	2,400
Total nitrogen.....	.15	3,000	Replaceable magnesium.....	3	720
Available nitrogen (Ammonia nitrogen + nitrate nitrogen).....	.002	40	Base-exchange capacity.....	15	
Available phosphorus (as P ₂ O ₅).....	.005	100			
Available potash (as K ₂ O).....	.015	300			

Analysis of various crops shows that plants remove from the soil at least 10 chemical elements. These are nitrogen, phosphorus, potassium, calcium, magnesium, sulfur, sodium, iron, chlorine, and silicon. Voorhees and Haskell (40, p. 3) state that many plants can grow to maturity without sodium, silicon, and chlorine, but that the other elements obtained from the soil must be present for normal growth. Additional elements found include manganese, carbon, hydrogen, and oxygen, the last 3 obtained from the air or water.

More recent developments in the field of soil chemistry indicate that boron, copper, and zinc are necessary for normal development of plants and some startling results have been obtained with certain soils and crops by very light applications of chemicals containing these elements. Remarkable increases in yield and reduction of disease occurred in a number of instances.

All the evidence at hand indicates that the so-called minor elements may be very important in some cases, and it is confidently expected, as more field experiments are performed and better methods of quantitative analysis developed, that their true role in plant growth and disease resistance will be brought to light.

The functions of the various elements in the growth of a plant are numerous and complex. Van Slyke (39, pp. 48-55) states that nitrogen promotes growth of foliage and stem, gives leaves a dark-green color, and acts as a food reserve; phosphorus stimulates germination, increases root development, and is vitally necessary in seed production; potassium aids in formation of carbohydrates, is important in transference of starch from one part of the plant to the other, and increases seed production. Lime in moderate amounts increases availability of phosphorus, prevents excess acidity, stimulates growth, improves tilth of fine-textured soils, and has an ameliorating effect on toxic substances in the soil. If present in excessive amounts it may reduce availability of iron and manganese, resulting in chlorosis.

It is a well-known fact among nurserymen that an excess of nitrogen in readily available form causes undesirable succulence and top-heaviness in plants, decreases drought resistance, and increases susceptibility to fungus diseases. The beneficial effect of superphosphate fertilizers in stimulating root development and developing well-balanced, drought-resistant nursery stock is becoming generally recognized.

In most soils, if nitrogen, phosphorus, or potassium, or sometimes calcium or sulfur, are sufficiently depleted, plant growth will be influenced. In the soils of the prairie-plains region, potassium, calcium, and sulfur are invariably present in adequate amounts, but in some instances nitrogen, phosphorus, and iron may be so low that, for optimum growth of the seedlings, corrective measures may be required. This is especially true of phosphorus, because this element is the one which is most likely to be the limiting factor in production of drought-hardy planting stock. It is believed that lack of sufficient manganese in some plains soils accounts for chlorosis in nursery stock, but to date this has not been proved experimentally.¹²

¹² At the Woodward, Okla., field station of the Bureau of Plant Industry, experiments by L. F. Locke are reported as indicating that lack of available iron is the critical factor, and that chlorosis in nursery stock may in most instances be corrected by the application of iron sulfate.

MAINTENANCE OF SOIL FERTILITY

Although a tract of good fertile soil may be selected as a nursery site, it cannot be expected to be cropped repeatedly without the necessity of taking some measures to maintain its productivity. Moreover, the area selected for a nursery site will in most cases be land that has been used in the past for production of farm crops, and may need attention at the outset if the highest quality of nursery stock is to be produced.

DRAIN ON SOIL NUTRIENTS AND THEIR REPLACEMENT

The actual drain on soil nutrients by nursery stock will vary according to species, density of sowing, amount of effective water applied, and length of growing season. In the southern part of the prairie-plains the longer growing season and greater production of material per acre per year result in a heavier drain than farther north. Computation of the total green weight of 1-year-old honeylocust seedlings produced in two successive years, 1935 and 1936, in a nursery at Tecumseh, Okla., gave fresh weight of seedlings per acre (without foliage but including roots dug to a 10-inch depth) as 7,640 and 3,730 pounds respectively. The variation was due largely to annual differences in rainfall and is quite comparable with that for many agricultural crops.

Table 12 gives some additional data on the weight of the material removed from a nursery by the digging of the stock. Since the moisture content of deciduous trees at time of lifting is generally about half the fresh weight of the plant, it is apparent that the dry weight of the crop produced in Oklahoma nurseries per acre per year ranges roughly from 650 to 4,550 pounds, with an average of about 2,450 pounds. Similar data for nurseries in the northern and central parts of the prairie-plains show the crop weights to be one-half to two-thirds the values given in table 12.

On the basis of several analyses of hardwood seedlings from a North Dakota nursery, the actual drain caused by removal of a crop of which the oven-dry weight is 1 ton per acre would be 28 pounds nitrogen, 3 pounds phosphoric acid, and 9 pounds potash. The nitrogen, phosphorus, and potash contents of American elm in this nursery were 1.795, 0.1563, and 0.452 percent respectively, and for green ash the values were 1.035, 0.1475, and 0.443 percent respectively.

TABLE 12.—Green weight of 1-0¹ seedlings produced per acre in Oklahoma nurseries in 1935

Nursery and species	Spacing between rows	Trees per foot of row	Trees per acre	Total green weight
	Inches	Number	Number	Pounds per acre
Tecumseh:				
Chinese elm	40	4.5	58,800	9,050
Osage-orange	20	4.5	117,600	7,870
Honeylocust	20	4.5	117,600	7,640
Black locust	40	3.8	49,700	3,970
Oklahoma City:				
Western walnut	42	4.3	53,500	4,470
American elm	42	4.2	52,300	1,820
Green ash	40	4.5	58,800	1,250
Enid: Hardy catalpa	42	4.7	58,500	3,110

¹ 1-year seedlings not transplanted before field planting.

Any attempt to determine fertilizer treatment on the basis of analysis of plant material and amount of such material removed per acre per year will result in too light an application of fertilizer. Safe determinants are tests for readily available nutrients or actual field tests to determine the approximately correct treatment.

The productivity of a soil is maintained by application of animal manures or concentrated commercial fertilizers, or by the use of legumes and other soiling crops. In some nurseries materials such as peat, muck, and forest humus are used, especially in the form of compost. Such composts are limited to use in areas where the above materials are available close to the nursery; generally they are too expensive to ship into the plains.

Effectiveness of a fertilizer or combination of fertilizers will depend on the availability of the various nutrients in the soil and on the demands of the crop. Some clues as to which nutrients are lacking can be obtained by making an analysis of the soil which would at least include total nitrogen, available nitrogen (largely nitrate nitrogen + ammonia nitrogen), available phosphorus, available potash, base-exchange capacity, and soil reaction (pH), and then using the data in table 11 to estimate their adequacy.

Nursery soils on the prairie-plains are very liable to test low in available phosphorus, and the deficiency can most readily be corrected by addition of 20-percent superphosphate or 45-percent treble superphosphate. Bonemeal can also be used as a source of phosphorus. The 20-percent superphosphate is generally most effective at rates of application varying from 300 to 800 pounds per acre, and bonemeal at somewhat higher rates because of its lower availability. If treble superphosphate is used, quantities varying from 100 to 400 pounds per acre are satisfactory, and 150 to 200 pounds is generally sufficient.

Adequate nitrogen can be supplied to nursery stock by application of animal manure at the rate of 10 to 30 tons per acre, the quantity depending on present soil fertility and type of manure being applied. Ordinarily 10 to 15 tons per acre is adequate. Where it is not feasible to furnish nitrogen in this form, it can be supplied by using legumes in the rotation, or it may be applied in the form of 20-percent ammonium sulfate or 35-percent ammonium nitrate at the rate of 200 to 600 pounds per acre for the former and 100 to 300 pounds for the latter.

Potash is nearly always present in adequate amounts in most plains soils but any lack can be remedied by the use of animal manures which contain some potash, or by applying 100 to 200 pounds per acre of 50-percent muriate of potash or 50-percent sulfate of potash. In some cases it may be of advantage to apply combined fertilizers containing two or more of the essential nutrients, as, for example, ammonium phosphate and nitro-phoska.

A low base-exchange capacity can be corrected by adding large amounts of animal manure or compost or by the repeated plowing under of soiling crops of legumes. Low base-exchange capacity is usually associated with the sandier nursery soils which lack humus and colloidal material. A low base-exchange capacity may also be encountered on soils which have been overcropped and not fertilized for many years, or, especially in the northern plains, where wind erosion has removed a considerable part of the topsoil, rich in humus.

Tests for available nutrients are useful only as aids in determining probable soil deficiency and should be supplemented, if possible, by actual field tests of various fertilizers.

For nurseries in the prairie-plains region, the use of soiling crops with application of animal manures will usually be the most feasible method of maintaining productivity, even though it may be necessary in many cases to supplement this by the use of commercial fertilizers, especially superphosphates.

ANIMAL MANURES

Although animal manures do not run as high as commercial fertilizers in percent of different plant nutrients, they have a higher value in soil building, maintaining the soils in good tilth and increasing their ability to absorb and retain moisture. In the process of decomposition in which phosphorus and other elements are dissolved and converted into available plant nutrients, the bacteria present not only aid in the decomposition of the manure itself, but also attack the soil material. If added in liberal amounts the manure often takes care of most soil-nutrient deficiency.

It is advisable to allow animal manures to be rotted thoroughly before applying them to the soil. Fresh manure, especially that which contains a high percentage of horse excrement, has an injurious effect on many plants, commonly known as burning. Moreover, it has a higher percentage of viable weed seeds than well-rotted material. To some extent, the burning effect can be controlled by maintaining soil moisture at a fairly high level by means of irrigation.

Van Slyke (39, pp. 218-226) gives analyses of the various animal manures as shown in table 13. He gives the following values per ton as averages for the various animal manures when mixed with the usual amount of straw used as bedding or litter: Hen, \$3.55; sheep, \$2.75; steer, \$2.45; horse, \$2.40; cow, \$2.00; pig, \$1.95. These values are based on the following assumed prices per pound: Nitrogen, 12 cents; phosphoric acid, 5 cents; potash, 4½ cents.

TABLE 13.—Percentage of plant-food constituents in fresh animal excrements¹

Kind of animal and excrement	Water	Nitrogen	Phosphoric acid	Potash
Horse:	<i>Percent</i>	<i>Percent</i>	<i>Percent</i>	<i>Percent</i>
Solid (80 percent)	75	0.55	0.30	0.40
Liquid (20 percent)	90	1.35	(²)	1.25
Mixed	78	.70	.25	.55
Cow:				
Solid (70 percent)	85	.40	.20	.10
Liquid (30 percent)	92	1.00	(²)	1.35
Mixed	86	.60	.15	.45
Pig:				
Solid (60 percent)	80	.55	.50	.40
Liquid (40 percent)	97	.40	.10	.45
Mixed	87	.50	.35	.40
Sheep:				
Solid (67 percent)	60	.75	.50	.45
Liquid (33 percent)	85	1.35	.05	2.10
Mixed	68	.95	.35	1.00
Hen (mixed)	55	1.00	.80	.40

¹ From Van Slyke (39).

² Trace.

Thus it will be seen that 50 tons per acre of an animal manure having 1.0 percent nitrogen, 0.3 percent phosphoric acid, and 1.0 percent potash would add 1,000 pounds of nitrogen, 300 pounds of phosphoric acid, and 1,000 pounds of potash, and if plowed into the top 7 inches of soil would theoretically increase the total nitrogen 0.05 percent, total phosphorus 0.015 percent, and total potash 0.05 percent. The generally low phosphoric acid content of most animal manures suggests the necessity of supplementing them with the superphosphates, especially in plains nurseries.

Since animal manures, especially the wet manures, lose a high percentage of their value through leaching or too rapid fermentation, they should be put into a concrete or puddled-clay pit. If any considerable rainfall is expected, there should be a tight roof over the pit, or at least a layer of soil 1 foot thick. To keep loss to a minimum, the material should be kept compact and moderately moist. These precautions will retard denitrification. The tight pit will prevent loss of the soluble portions, particularly nitrogen and potash, of which half or more exists in soluble form in farm manure.

The rotted manure, and also the liquid portion, can be applied to the nursery in late fall after the stock has been dug, and it is considered good practice in arid or semiarid regions to plow under the manures to aid in their decomposition rather than to let them lie on the dry surface. Such applications can be made every other year in treatments of 10 to 30 tons per acre, depending on the soil, species of trees grown, and other factors.

SOILING CROPS AND OTHER FERTILIZERS

It may be found necessary, in addition to the use of farm manure, to sow a soiling crop every third or fourth year. This crop can be either a legume or a grain and should be plowed under while it is still succulent and immature. Mature soiling crops do not decompose rapidly and may produce a seed crop that will germinate the following year and add to weeding costs. One of the best ways of using animal manures most effectively is applying them to the soil before sowing the soiling crop. On the other hand, a good soiling crop cannot be produced if soil fertility is low, and this makes an application of some fertilizer before sowing, especially animal manure, most advisable.

For nursery work, preference should be given to legumes such as cowpeas, soybeans, vetch, and field peas, which are sown in spring and turned under in summer. Grain crops such as rye or oats also are excellent. The rye is often sown in fall, turned under in early summer, and followed by a crop of legumes.

From a nursery production angle, sweetclover and alfalfa have a disadvantage in that they are deep-rooted, persistent, and hard to kill. The latter does not produce much growth in 1 year, although from the point of soil building, both crops are rated very high.

If a very heavy crop is produced, it can be disked before plowing to aid in getting it turned under more completely. The plowing should be done at least 4 to 6 weeks before nursery sowing in order that the

soiling crop may decompose sufficiently and not interfere with seeding or cultivation.

Where legumes are sown, the seed should always be inoculated with the proper nitrogen-fixing bacteria before sowing. In theory, once such inoculation has been made on a given area, sufficient bacteria should carry over in the soil so that no further inoculation is necessary. In practice this does not always work out, and inoculation of every new sowing of legumes appears to be the safer procedure.

Some nurserymen make a practice of composting all fertilizer materials used in the nursery. This compost pile consists of alternate layers of manure with some material like straw, peat, humus from the forest, or the aerial portions of such crops as soybeans and cowpeas. The layers are generally from 4 to 8 inches thick, and as each layer is built up it is fortified with a small amount of a complete commercial fertilizer. This is sprinkled on top of each layer and wet down with a hose. Enough commercial fertilizer is added so that there are 100 to 200 pounds per ton of compost. The compost pile is dished at the top, and watered occasionally to prevent excessive heating. The compost is ready for use in 3 to 24 months depending on conditions favorable to fermentation and decomposition, and is applied at the rate of 5 to 10 tons per acre. Composts are expensive, however, and in most nurseries in the plains region animal manures supplemented with superphosphate, with an occasional soiling crop, will suffice in retaining soil productivity at a minimum cost.

In some cases in which it may not be feasible to use animal manures as extensively as desired because of the high cost of hauling or shipping, the nurseryman can resort to such commercial fertilizers as bonemeal, dried blood, tankage, cottonseed meal, ammonium sulfate, superphosphate, and muriate of potash. Complete fertilizers, consisting of an 8-12-4 combination of ammonium sulfate, superphosphate and muriate of potash, have given good results when worked into the soil before seeding in amounts varying from 600 to 1,000 pounds per acre.

THE WATER SUPPLY

QUANTITY AND QUALITY OF WATER REQUIRED

An adequate supply of water is an important requisite of a good nursery site. Although exact data showing the volume of water required to produce a crop of deciduous nursery seedlings in the plains region are not available, some empirical observations point to the conclusion that from 5 to 15 inches of water per year is actually used by a good stand of seedlings, depending on species and length of growing season. Since in the north not over one-third and in the south not over one-fourth of the total water applied to the land is commonly used by crops, it may readily be calculated that 20 to 30 inches per year, depending on latitude, represents the barest minimum for safety. Intensive cultivation and care in applying water may, however, go far toward reducing such apparently extravagant demands.

The amount to apply artificially will, of course, vary with the precipitation during the season. In some years no supplemental water may be needed, but in dry seasons it may be necessary to apply as much as 10 to 20 inches of water by irrigation. Therefore, as an insurance measure, a sufficient supply of irrigation water should be available in drought years. The available flow for maximum efficiency on an average-sized nursery of 30 acres should not be less than 300 gallons per minute, and there may be required as much as 800 gallons per minute on larger nurseries up to 60 acres in area.

In the prairie-plains region, however, quality of water available for irrigation is as essential as quantity. No long-time studies of this subject have as yet been completed, but from analyses of water used in a number of nurseries in the plains and observations of its effect on nursery stock, it appears the part of wisdom to select a site for deciduous stock where the total dissolved solids in whatever water must be used for irrigation are not over 600 parts per million, and preferably under 400 p. p. m., with the further stipulation that these be largely in the form of the less toxic compounds. For conifer stock, the water should have not over 200 p. p. m. of total dissolved solids, with even more stringent limitations on the allowable percent of the toxic salts, especially those of sodium and magnesium.

These limitations are narrower than those for ordinary farm crops. Irrigation experts state that a mineral content of 40 grains per gallon of water (equivalent to 680 p. p. m. of dissolved solids) represents the usual upper limit for irrigation of farm crops. If most of this mineral content, however, is in the form of carbonates and sulfates of lime, the total mineral content can be over 1,000 p. p. m. On the other hand, if most of the dissolved material consists of sulfates, chlorides, and carbonates of potash or sodium in concentrations as low as 400 or 500 p. p. m., it can soon render a soil unfit for use. This is especially true if an impervious substratum prevents proper under-drainage, thus causing a build-up of alkali salts in the surface soil, and also if the amount of irrigation water used must be large in comparison with rain water, as in dry years or in the western part of the region.

The toxicity of various alkalis and salts was studied by Breazeale (5, pp. 238-256), in an interesting laboratory experiment in which sprouted seedlings of wheat were placed in solutions of different concentrations. He found that there was a marked difference in the toxic point of salt solutions, depending on the presence or absence of calcium, which had an ameliorating effect and enabled the wheat seedlings to withstand higher concentrations of the salts. For instance, a pure solution of 4,000 p. p. m. of sodium chloride represents the approximate limit of endurance of wheat seedlings, but if a small amount of a soluble calcium salt is added, they can endure concentrations of over 10,000 p. p. m. These values are, of course, absolute maximum concentrations, and the weaker solutions of only one-half to two-thirds of lethal dosages generally result in a marked slowing down of growth rate.

The quality of ground water in the plains, according to Riffenburg (31) and others, varies considerably according to the geological formation from which the water is drawn, depth of well, and other factors. His data on analysis of water from several hundred wells indicate that a high percentage of the wells in the northern prairie-plains have from 1,000 to 2,000 p. p. m. of total dissolved solids and that water sources with only 150 to 400 p. p. m. of dissolved solids are rather scarce in the Dakotas. The shallow waters lying entirely in beds of glacial material are much less mineralized than those from deeper strata.

Data furnished by E. C. Reed of the Nebraska Geological Survey, regarding quality of Nebraska ground water, indicate that ground water is generally less heavily mineralized in that State than in the Dakotas. Table 14 is based on analysis of about 140 samples of Nebraska water. Reed states that practically all the samples which contained over 800 p. p. m. came from wells 500 to 2,000 feet in depth.

TABLE 14.—*Mineral content of Nebraska ground water*¹

Solids (p. p. m.)	Wells in each class	Solids (p. p. m.)	Wells in each class
	<i>Percent</i>		<i>Percent</i>
0-100.....	0.0	500-600.....	13.9
100-200.....	.7	600-700.....	2.9
200-300.....	6.6	700-800.....	2.9
300-400.....	43.1	Over 800 ²	7.3
400-500.....	22.6		

¹ Analyses by C. J. Frankforter, University of Nebraska. Data supplied by E. C. Reed of the Nebraska Geological Survey.

² Maximum was 7,529 p. p. m.

Before a nursery site is chosen it is strongly recommended that a sample of water be obtained from the depth which is to supply the irrigation water, and that it be analyzed by a competent hydrologist. A gallon glass jar or jug, thoroughly washed out and then rinsed several times in distilled water, is suitable for sampling. Water taken from a faucet should be allowed to run for several minutes. If water is to be obtained from a stream, some consideration must be given to the time of year of sampling and the stage of the river. Very often, as the level of the stream is lowered by lack of rainfall in summer, the salt concentration increases. If use is made of a city or town water system, analyses already made can probably be obtained from the State geologist or may be found in one of a number of U. S. Geological Survey Water Supply Papers for the area in question.

Table 15 presents an analysis of water in an Abilene, Kans., well which is considered barely acceptable for irrigation, its total dissolved solids running to 648 p. p. m.; but since most of the dissolved material is in the form of calcium carbonate and bicarbonate (items 18 and 17), which are not particularly harmful to deciduous nursery stock even in moderately large quantities, adequate underdrainage of the nursery soil would probably keep this well from building up an alkali-problem nursery, except possibly after prolonged use of the nursery site.

TABLE 15.—Analysis of a water sample from Abilene, Kans., considered barely acceptable for use in nursery irrigation ¹

Component	Analysis	Remarks
	<i>Parts per million</i>	
1. Total solids.....	648.4	High; much above average.
2. Organic and volatile matter.....	88.0	High; above average but in keeping with total solids.
3. Insoluble matter.....	19.2	Relatively low.
4. Iron, manganese, and aluminum.....	(?)	Not determined exactly but of the order of 1.5 to 2.0 p. p. m., at least one-half aluminum; relatively high if all iron or iron and manganese; not likely to produce red or brown stain on white ware.
5. Sodium.....	11.3	Relatively low.
6. Magnesium.....	23.5	Relatively high.
7. Calcium.....	130.4	Very high.
8. Chlorine ion (soluble chlorides).....	24.2	Average or little above.
9. Sulfur trioxide (soluble sulfates).....	140.6	Very high.
10. Bicarbonic acid ion (soluble bicarbonates).....	320.0	Do.
HYPOTHETICAL CHEMICAL COMBINATION OF ACID AND BASIC IONS		
11. Sodium chloride.....	40.2	Average or little above.
12. Sodium sulfate.....	Not unusual.
13. Sodium bicarbonate.....	25.3	Not unusual; bicarbonate alkalinity; little above average.
14. Sodium carbonate.....	(?)	A mere trace in this instance; not enough to be significant.
15. Magnesium sulfate.....	116.7	Very high.
16. Calcium sulfate.....	106.7	Do.
17. Calcium bicarbonate.....	400.6	Do.
18. Calcium carbonate.....	247.3	Very high; chemically equivalent to item 17; precipitated on evaporation of water.
HARDNESS, AS CALCIUM CARBONATE		
19. Permanent hardness.....	175.6	Very high.
20. Temporary hardness.....	247.3	Do.
21. Total hardness.....	422.9	Do.
22. Nitrites.....	(?)	Sufficiently high to cause water to be viewed with much suspicion if used for drinking purposes; should be boiled if drunk; not proof of bacterial contamination.
23. pH.....	Relatively high (7.2); definitely alkaline.

¹ Analysis by C. J. Frankforter, Chemist, University of Nebraska, Lincoln, Nebr.

² Small, indeterminate quantity.

An analysis is given in table 16 of water from a South Dakota well considered unfit for use in a deciduous-plant nursery. The high content of sodium compounds (items 11 to 14) and the high pH (item 23) indicate the probability of a rapid build-up of harmful alkalis and salts sufficient to cause eventual abandonment of the nursery site. Sodium is one of the most toxic elements in alkalis and in appreciable quantities will result in harm to most plant life.

The significance of pH value in relation to prolonged use of water for irrigating forest nurseries is not thoroughly understood, but it may be of interest to state that in one North Dakota nursery water with a pH of 7.2 raised the pH of the nursery soil from 6.6 to 7.6 in 2 years. The water had 187 p. p. m. of total dissolved solids, largely in the form of calcium carbonate and bicarbonate. The build-up of pH did not affect the hardwood stock in the least, but for the more sensitive conifers, especially jack pine, it was necessary to apply at time of seeding one avoirdupois ounce of aluminum sulfate per

square foot, or three-eighths fluid ounce of commercial sulfuric acid in a pint of water per square foot, to reduce pH to the level of 6.0 satisfactory for most pine seedlings.

TABLE 16.—*Analysis of a water sample from Pierre, S. Dak., not considered fit for use in nursery irrigation*¹

Component	Analysis	Remarks
	<i>Parts per million</i>	
1. Total solids.....	1,047.2	Exceedingly high.
2. Organic and volatile matter.....	82.8	High for an average water but low compared to the very high total solids.
3. Insoluble matter.....	26.0	About average for an average water but low compared to very high total solids.
4. Iron, manganese, and aluminum.....	(2)	Not determined but low compared to total solids; of the order of 1.5 to 2.0 parts per million with at least one-half aluminum; might cause staining of white ware.
5. Sodium.....	103.0	Very high; unusual.
6. Magnesium.....	25.4	Very high.
7. Calcium.....	40.3	High.
8. Chlorine ion (soluble chlorides).....	26.4	Average or little above.
9. Sulfur trioxide (soluble sulfates).....	361.9	Very, very high; unusual.
10. Bicarbonic acid ion (soluble bicarbonates).....	199.7	Very high.
HYPOTHETICAL CHEMICAL COMBINATION OF ACID AND BASIC IONS		
11. Sodium chloride.....	43.8	Average or little above.
12. Sodium sulfate.....	350.4	Very, very high; unusual.
13. Sodium bicarbonate.....	275.0	Do.
14. Sodium carbonate.....	(2)	Not actually determined but of the order of 2.5 to 3.0 p. p. m.; unusual; definitely alkaline even to phenolphthalein.
15. Magnesium sulfate.....	126.3	Very high.
16. Calcium sulfate.....	136.9	Do.
17. Calcium bicarbonate.....	(2)	Trace; unusual.
18. Calcium carbonate.....	(2)	Do.
HARDNESS, AS CALCIUM CARBONATE		
19. Permanent hardness.....	205.8	Very, very high.
20. Temporary hardness.....	(2)	Trace; unusual.
21. Total hardness.....	205.8+	Very, very high.
22. Nitrites.....	(2)	High; indicates some sort of organic contamination; not proof of bacterial contamination; water should be boiled before drinking.
23. pH.....		Very high (8.28); unusual; definitely alkaline.

¹ Analysis by C. J. Frankforter, Chemist, University of Nebraska, Lincoln, Nebr.

² Indeterminate quantity.

It should be mentioned here that the soil itself, the type of under-drainage present, the irrigator's skill and experience in applying water, and the relative amount of water needed in comparison with the amount received in rainfall, all have a bearing on the question as to whether continued use of saline water will at some time in the future create an alkali problem.

SOURCES OF SUPPLEMENTAL WATER

Assuming that the soil on a proposed nursery site is good and that the water available for supplemental irrigation is not too highly mineralized, the nurseryman still has the problem of determining the best method of pumping and distributing the water. The type of pump and motive power used will depend on the quantity needed, the pressure desired, and the depth of the water table. Deep wells, of course, cost more to develop and pump than shallow wells except possibly where artesian pressure is available. If ditch irrigation is to

be used, a pump of less pressure is needed than in a set-up in which irrigation is done by means of an overhead sprinkling system equipped with oscillators. Oscillators work best at pressures of 30 to 45 pounds, and function poorly or fail entirely when the pressure drops below 20 pounds at the point where the water enters the oscillator.

It is strongly recommended that, before final decision is made on the well location and depth, one or more test wells be dug under the supervision of a driller, preferably working under contract. The test will include an exact log of the hole, foot by foot, as recommended by Brackett and Lewis (4), to indicate character of the substrate, depth of water-bearing sand, and other pertinent data such as capacity and flow of the well and amount of draw-down for different discharge rates. The test will be used as a basis for recommending the type and capacity of the pump.

Before purchasing a pump, the buyer should become thoroughly familiar with the rating charts provided for each pump by the manufacturer. These charts show maximum working pressure developed and gallonage delivered at various heads, although it is best to deduct 30 percent from all claimed capacities for everyday working conditions. The data often include the horsepower necessary to furnish a specific flow of water at a given head and lift and give the speed in rotations per minute of the pump, as well as maximum and effective suction lift. Economy of operation and upkeep are additional factors for the buyer to consider.

PUMPING FROM SHALLOW WELLS OR OPEN WATER

Considerable expense can be averted in installation cost if the nursery lies in an area where there is a large permanent supply of good water within 10 to 50 feet of the surface. Such areas on the plains are invariably underlain by sand or gravel substrates and usually occur as terraces along streams or in the beds of old glacial lakes. In some places pumping can be done from a lake or stream, provided the entire flow of the stream is not already appropriated. Careful investigation should be made of legal priorities and water rights on such streams.

If the nurseryman is not familiar with the ground-water conditions and depths in a given locality, valuable advice can be obtained from an hydrologist or geologist familiar with the area.

Where the water table is within 10 to 30 feet of the surface and the water-bearing strata consist of sand or gravel, one of the most economical units is a horizontal centrifugal pump set down in a well pit so that it is within 5 to 10 feet of the surface of the water, which is drawn either through sand points, well screens, or strainers (fig. 12). If the water table fluctuates more than 10 feet, however, the water table at the low water stage, after prolonged pumping, may be below the effective suction lift of the pump. Although centrifugal pumps have a suction lift up to 20 or 25 feet, they work much more efficiently when placed closer to the water.

For priming, it is good policy to have the discharge pipe sloping upward from the pump, with a cut-off valve at the lower end. When the valve is opened the water retained in the pipe primes the pump.

The horizontal centrifugal pump is also well adapted to pumping from open water in lakes or streams. In such cases the suction pipe is fitted with a strainer foot valve at the intake, to screen out trash and facilitate priming. Where the water-bearing material is of a fine texture, it has been found advisable to have the well points or screens gravel-packed to allow a more rapid inflow of water and to reduce possibility of partially clogging up the well screens or points by fine particles of sand.

By gravel packing is meant surrounding the well screen or perforated casing with gravel. A 16- to 24-inch blank casing is sunk to 15 or 25 feet (or to the depth of the well) below the surface of the water;

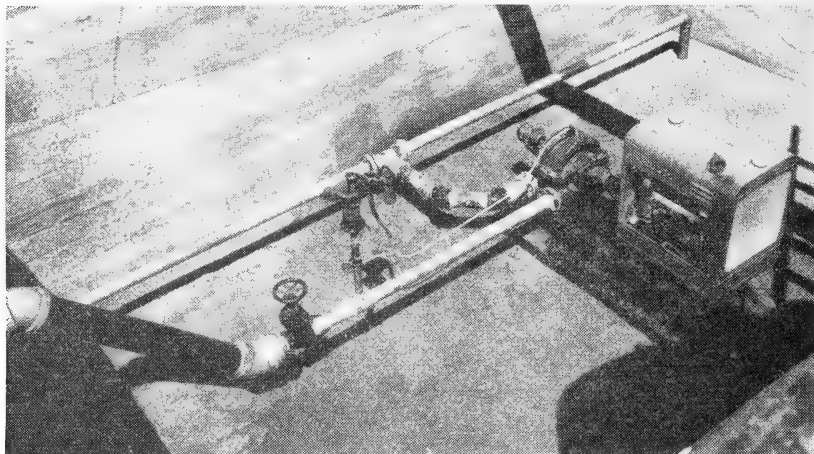

F327114

FIGURE 12.—A centrifugal pump drawing water from three 3-inch sand points. Capacity is 200 gallons per minute at 40 pounds pressure. An economical unit in pumping from open bodies of water or from shallow water-table areas underlain by sand or gravel. The effective lift of such pumps is generally 10 to 20 feet.

all the sand or silty material inside the casing is cleaned out with a sand bucket as the casing is sunk; an intake pipe with a smaller-sized perforated casing or a well screen attached is inserted in the center of the casing; and graded gravel from one-fourth to one inch in diameter is packed between the well screen and the casing. The blank casing should be 12 to 20 inches larger in diameter than the well screen or perforated casing. As packing proceeds, the outer casing is gradually withdrawn. The gravel filling is kept a foot or two higher than the bottom of the blank casing. The outer casing is completely removed after the gravel packing has been completed.

A cheaper method, used extensively in Nebraska, consists of digging a hole to the water table, setting the casing in the hole, and sinking it by weighting. A sand bucket is used to remove the material inside the casing below the water table. Gravel is poured between the casing and the sides of the hole in the upper portion of the well, and as the casing sinks, the gravel works downward along the side of the casing and leaves a gravel pack around the perforated lower part.

The portion of the casing below water is then perforated by means of a special tool devised for this purpose. Details on installations and types of casings are described by Ewing (10).

Of equal importance is proper well development by controlled pumping and surging, or the removal of the particles of sand that bridge over the openings in the well screen or casing and may appreciably reduce the flow of water. They are commonly removed by working a plunger up and down with a well rig, especially in connection with the development of a new well. The plunger is slightly smaller in diameter than the casing and its action draws the fine particles into the casing where they may be removed with a sand bucket. Another method of surging (35) used generally with the smaller-sized piston or horizontal centrifugal pumps, especially when attached to sand points, consists of pumping water down into the well pipe under pressure so that the water is forced through the screen in the sand point. This process cleans the screen by carrying the finer sand and soil particles some distance away from the screen, thus increasing the pore space around it and permitting movement of a larger volume of water through it when pumping is resumed.

When the well screen or point is attached directly to the suction line, it is essential that it be some 10 to 20 feet below the surface of the water to allow for drawdown, or lowering of the water table. Otherwise when the water level drops the pump will not function properly. The degree of drawdown depends upon the ability of the water to flow in fast enough laterally, and this in turn depends largely on the size of the particles in the water-bearing stratum, the capacity of the pump, and the length of time of pumping. Very often in situations where the water-bearing stratum is a medium to fine sand, it is necessary to put down two or three wells hooked up to a single intake or suction pipe in order to afford sufficient flow. The spacing of the points or wells will vary from 30 to 50 feet, with the pumps of 800 to 1,000 gallons-per-minute capacity.

Two other types of pumps used occasionally for shallow wells where the suction lift is not over 20 feet are piston and rotary pumps. These do not, however, have the capacities demanded in a large nursery. The rotary pump particularly is not well adapted to situations where the water contains any appreciable amount of sand or grit, as this material cuts the rotors and in short order seriously reduces the maximum suction lift of the pump as well as its capacity.

DEEP-WELL PUMPS

Where the vertical distance from the pump location to the lowest water level is more than 20 to 25 feet, there are several types of pumps available, namely, vertical turbine, vertical centrifugal, deep-well cylinder, and air-lift pumps.

The vertical turbine and the vertical centrifugal types are similar in that each has a casing which extends below the water table, and which houses an impeller-equipped shaft capable of rotating at speeds of 800 to 3,500 r. p. m. The impellers are housed in bowls near the bottom of the casing. In popular usage the term "vertical centrifugal pump" is generally applied to the type which has only one impeller blade of large diameter and is well adapted for pumping from depths

of 25 to 50 feet. Vertical turbine pumps have from 2 to 30 impellers (multistage). In deep wells the number of impellers is increased, generally by one stage for each 15 or 20 feet of head, depending also somewhat on size of casing, gallonage to be delivered at the surface, and pressure desired. Such pumps can be used in wells up to 1,000 feet deep.

The vertical centrifugal and the vertical turbine pumps are the two types most used in irrigation projects and in nurseries where the water table lies too deep to use a horizontal centrifugal pump. They have capacities of 500 to 1,000 or more gallons per minute and develop all the pressure ever needed in a nursery. Although the initial outlay is considerable, they are the best and most efficient deep-well pumps when costs are prorated over a period of years.

The deep-well cylinder pump, which operates on a plunger principle, is satisfactory for deep wells but generally has a capacity of not over 50 to 100 gallons per minute, not enough to supply the water needed in most nurseries, unless used to fill a storage pond or tank of large capacity from which water can be run by gravity into irrigation ditches.

Air-lift pumps are seldom used in irrigation projects because of low efficiency and high installation cost. Their chief mechanical advantage is that they need not be set directly over the well, as is the case for the other three types of deep-well pumps.

DITCH IRRIGATION ¹³

PLANNING AND CONSTRUCTION OF DITCHES

Ditch irrigation is the method generally used by plains nurserymen in distributing the water over the nursery. To be successful, it must be planned with due consideration for limitations chiefly connected with topography, texture of soil, and size and shape of the nursery. There is therefore no general plan that can be applied to all conditions.

A topographic map of the nursery site with a contour interval of one-half to one foot is prerequisite to laying out main and lateral ditches and deciding the direction of tree rows. These should first be plotted on the map. If the slope of the land is uniform and in one direction the irrigation system will often consist of a main ditch running down the slope on a fall of 0.1 to 0.25 percent, from which laterals run out approximately at right angles. The laterals follow around the contour of the slope and are spaced at intervals of 400 to 650 feet depending on slope of land and soil texture. Rows should not be carried down slopes of more than 2.5 feet per 100 feet in very sandy soils, 1.75 feet in sandy loams, or 1.5 feet in heavy soils. Otherwise, erosion may result during irrigation and proper penetration of the water is difficult to attain.

The distance which water may economically be carried down tree rows varies with the slope, the head of water available, and the soil type. For instance, when water is turned into a tree row, on sandy soils, the stream will advance down the row at a uniform rate of so

¹³ This section on ditch irrigation was prepared largely by I. D. Wood and R. Hilliary, formerly with the Prairie States Forestry Project, Forest Service.

many feet per minute for a certain distance. Then the rate of advance gradually slows down until a point is reached where little or no progress can be noted. It is evident that the part of the tree row near the point of diversion at the main ditch is then being overirrigated, whereas the far end of the row will be getting little or no water. For sandy loam soils, a carry of from 450 to 650 feet down a tree row should ordinarily produce good results. The distance may be increased somewhat on tighter soils. The exact distance on a given slope and for a given head of water and type of soil can be determined only by experience with the particular field in question.

When rapid percolation interferes with the carrying of water the full length of the rows, the best procedure is often to increase the quantity of water entering each row. A second expedient is to plow

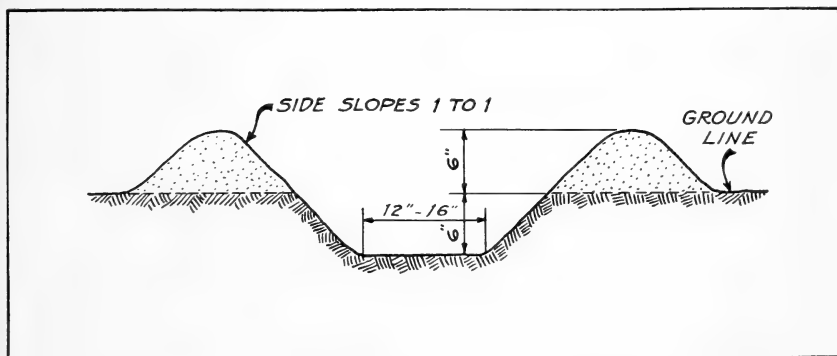

FIGURE 13.—Common type of irrigation ditch used in nurseries, but not suitable for use on slopes in excess of 18 inches per 100 feet. Bottom of ditch may range from 12 to 16 inches.

a shallow trench or run a canvas hose down one row, through which a fairly large head of water may be carried to the far end of the field, where it may be diverted to the rows not reached by the usual method.

Ditch construction is not a difficult problem, since the main and lateral ditches used in nursery irrigation are relatively small. In lighter soils, a plowed furrow may be used to make the line, after which a V-shaped scraper or small ditching machine will suffice for the remainder of the construction process. In heavier soils, it will be necessary to plow the soil loose and then remove it with the blade ditcher. In most instances, a ditch with a bottom width of 12 to 16 inches, a depth of 12 inches, and side slopes of 1:1 will suffice to carry the quantities needed in nurseries (fig. 13).

Where the water must be carried down slopes in excess of 18 inches per 100 feet to reach some particular area, ditches of the cross-section mentioned above are likely to be damaged by erosion. If the slope is short in length, the water can be conducted in a trough made of 1-x 12-inch plank; or a simple drop may be made with sand bags, which can be moved from place to place at little cost and may be used to advantage in many places to prevent erosive action of irrigation water.

The problem of carrying irrigation ditches over depressions or ravines may be solved by making a fill across the depression with a slip scraper and running the ditch across the fill—fill and ditch banks being well compacted to avoid serious breaks. Often, however, a simple flume is more desirable, especially where the ravine to be crossed must be left clear to carry away floodwater (fig. 14). In some situa-

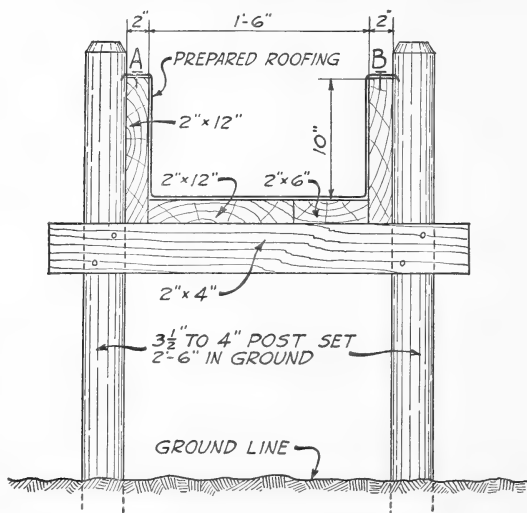

FIGURE 14.—Detail of a flume design commonly used for farm ditches. The posts are spaced 8 feet apart along the length of the flume. The prepared roofing is laid lengthwise and whatever joints are necessary are made by sealing the edges with roofing cement. The edges at *a* and *b* are securely held with roofing nails.

around the box when it is set in place or a leak will occur, resulting in a break. Water so diverted should be carried in a lister- or plow-furrow parallel and adjacent to the main or lateral ditch (fig. 15). From this furrow, diversion can often be made to 15 or 20 rows at one time. It is relatively easy to cut the banks of the lister ditch or to dam it at intervals with a shovelful or two of soil.

Canvas dams are easily and cheaply made and are effective in ditches of small size (fig. 16). The 14-ounce canvas is securely fastened to a piece of 2 by 4 laid across the ditch so that the loose end of the canvas is upstream, where it is held in place on each bank by several shovels of earth. After the water is turned in, a few extra shovels of dirt may be necessary to stop leaks. Several dams should be made so that one may always be in place before removing one where irrigation has been completed.

The portable metal dam (fig. 17), which is set securely across the ditch by means of the 4½-foot angle iron, has some advantages over the canvas dam in that it is more durable and has a greater diversity of uses. The shut-off slide facilitates letting some water pass the dam when desired. The dam with the slide open can also be set in a ditch bank and used in place of the 6- by 6-inch box shown in figure 16.

tions it may be most economical in the long run to use galvanized iron flumes throughout and have these supported on concrete or pressure-treated, creosoted piers.

It is usually necessary to dam a main ditch or lateral to divert water to rows. Canvas dams, portable metal checks, or sandbags may be used. It is considered poor practice, however, to cut the main ditch bank every few feet to obtain water for individual rows. Water can be diverted from the main ditch through a box made of 1- by 6-inch or 1- by 8-inch material (see fig. 15). Damp earth must be tamped

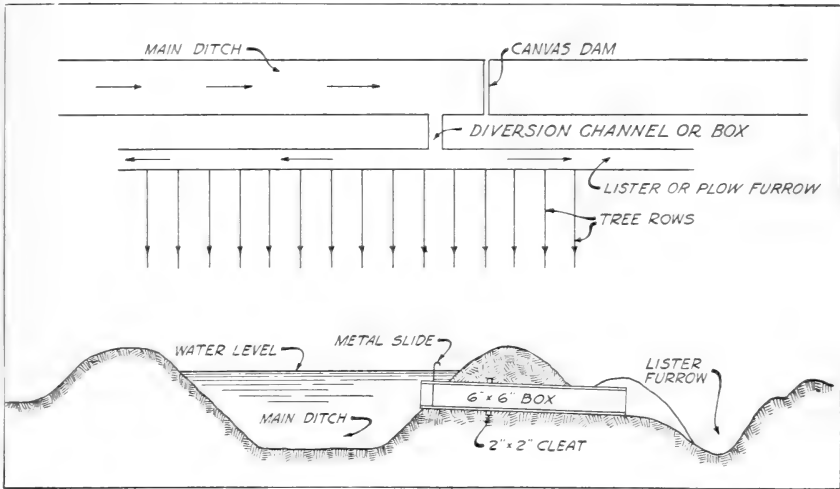

FIGURE 15.—Method of diverting water from main ditch, by means of canvas dam and diversion box.

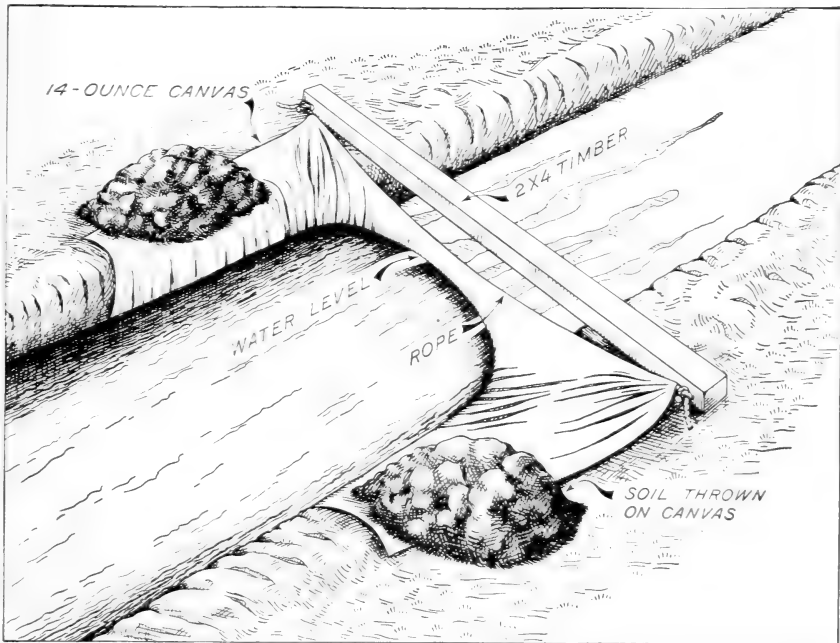

FIGURE 16.—A canvas dam constructed so as to permit bypassing part of the water.

An important feature of nursery irrigation is leveling. In fields which appear smooth and uniform to the eye, small irregularities of a few inches may either divert the flow of irrigation water from the tree

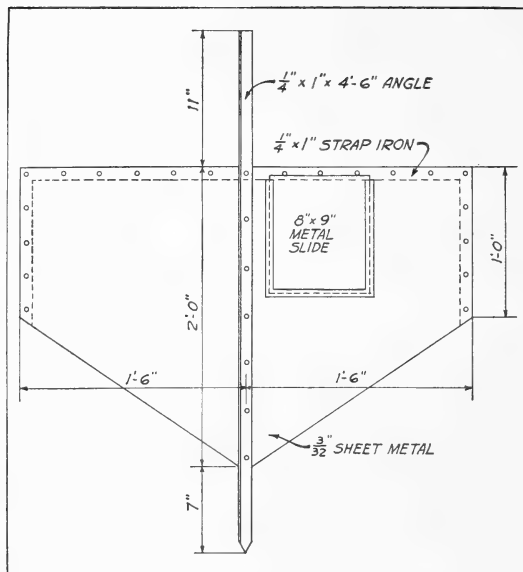
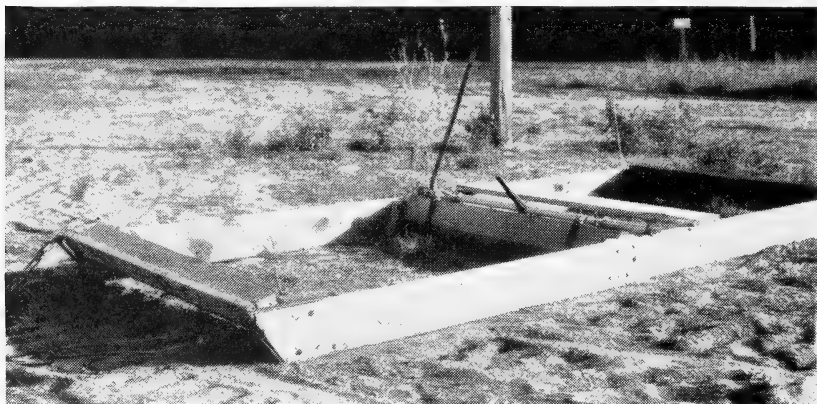

FIGURE 17.—A common design of portable metal dam.

rows or cause pools to form. To smooth out high points and fill in depressions, a drag or irrigation leveler is used (fig. 18), consisting of a rectangular frame from 16 to 24 feet long with cross members spaced at uniform intervals.

Leveling may be necessary for several seasons to get the land in the best shape for irrigation, but considerable benefit will result from one or more levelings in the same season. The leveler should be used only when the ground surface is fairly dry and in good tilth and the soil will move readily ahead of the cross members. If possible,

the leveler should be drawn once lengthwise across the field, once crosswise, and once diagonally, each season after the soil has been plowed or disked preparatory to planting. In sandy soils, where levelings are likely to pulverize the topsoil and subject it to blowing, one leveling may have to suffice. Obvious high points and deep depressions often require the use of a blade road-grader or slip scraper.



F268018

FIGURE 18.—Irrigation leveler used at Bessey Nursery, Halsey, Nebr.

MEASUREMENT OF WATER OVER WEIRS

Many nurserymen prefer to know the volume of water used throughout the season, especially where water rights must be paid for. Such measurement is usually made by means of a weir or water meter. The water meter can be used only where water is transported under pressure through pipes; in ditch irrigation, weirs are commonly used.

A weir consists of a bulkhead or wall built across a stream or ditch at right angles to the flow of water with an opening cut in the top of the

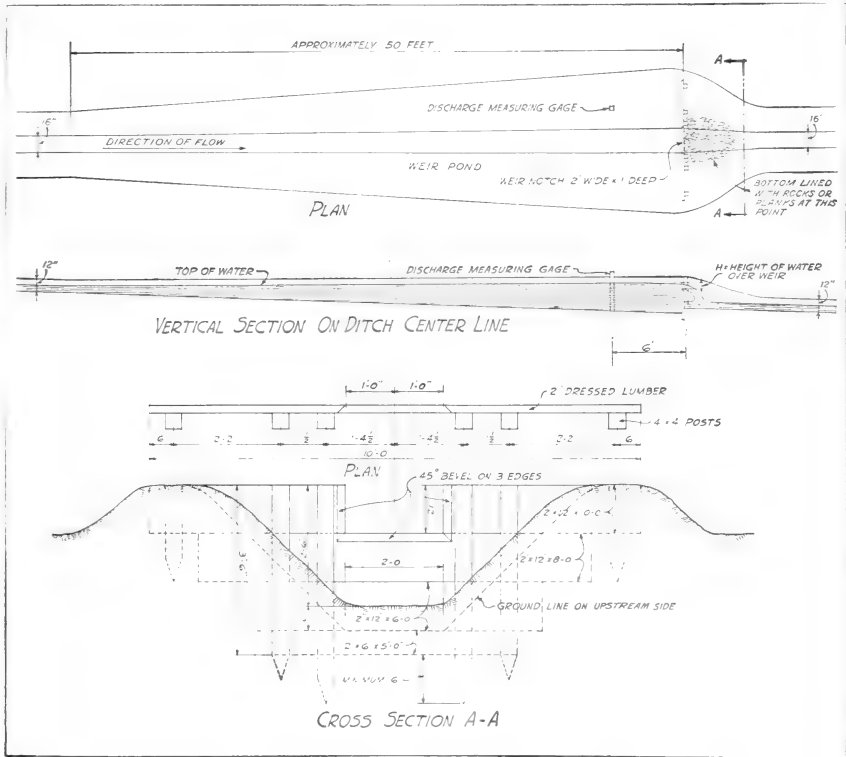

FIGURE 19.—Details of construction of a weir and weir pond.

wall through which the water is measured as it flows. The opening is called a weir notch. The bottom edge of the notch over which the water flows is called the crest. That portion of the ditch immediately upstream from the weir is called the weir pond. The height of the water surface in the weir pond above the level of the weir crest is the head. This is measured a few feet upstream from the weir. If the flow of water over the weir crest discharges into free air before striking the level of the water on the downstream side, the weir is said to have free discharge. A weir with a sharp upstream corner or edge so formed that the water springs clear of the crest is called a sharp-crested weir.

A weir notch 2 feet wide and 1 foot deep will meet the requirements of all anticipated flows used in the irrigation of most nurseries. The details of the construction of such a weir are given in figure 19. Care

is necessary to insure that the weir notch is rigid, the crest level, and the sides vertical at a 90° angle to the crest and exactly 2 feet apart. The weir must be made sharp-crested by beveling the downstream edges of the crest about 45° .

The weir pond is made by so widening and deepening the ditch for some distance upstream from the notch as to assure practically a still-water condition before the water flows over the weir. The procedure is as follows:

Commencing at approximately 50 feet upstream from the weir, widen the ditch by tapering gradually to the full width of the weir wall or bulkhead. The water must approach the weir in straight lines without swirling, eddy, or current.

Deepen the ditch gradually to the depth of the weir bulkhead.

Raise the banks starting at the weir and continuing upstream 50 to 100 feet, depending upon the grade of the ditch and how close to the head of the ditch the weir is placed. This should not be closer than about 50 feet. Experience has shown that a distance less than 25 feet between the weir and the supply discharge point usually causes too great a surface disturbance of the water to permit of an accurate measurement of the head h and is liable to result in an increased velocity of waterflow over the weir. The amount of raise should be only enough to give a free fall of water from the weir crest to the water level below.

The bottom of the ditch for a short distance downstream from the weir should be protected by an apron of rock or plank to prevent scouring from the water falling over the weir notch.

The pond must not be allowed to fill with silt and sediment or other debris.

After the weir pond has been constructed, the weir is installed in accordance with the standard weir plan (fig. 19). Care should be used in the installation of the weir to make certain of the following conditions:

The wall is set true and vertical.

The stakes are driven solid and to the required depth.

The joints are tight.

The notch is properly centered over the center line of the ditch.

The crest is perfectly level and set at the proper elevation above the ditch-bottom level.

All dimensions of the notch conform accurately to the construction plan.

Every precaution is taken to prevent water from washing under the bottom or around the sides of the weir.

The soil is properly filled in and tamped around the weir and the weir-pond bank brought flush with the top of the weir.

The ditch just below the weir is adequately lined with rock, plank, or sandbags to prevent scouring due to the water falling over the weir notch.

The weir gage may be an ordinary ruler or a hardwood stick graduated to feet and inches, but it is preferable to have it graduated to feet and tenths and hundredths of a foot. It should be set upstream from the weir notch a distance of 6 feet on a solid post driven into the ground just far enough from the ditchbank to assure that it will always be in the water. The reason for placing the gage as described is that the depth of water h (fig. 19) from which the flow over the weir is computed is measured vertically from the crest to the horizontal plane or the still-water surface in the pond upstream from the weir. There is a decided curving downward of the water surface near the weir notch and it is necessary to get beyond the effect of this curvature in order to get the correct depth. The zero of the gage should be accurately set, level with the weir crest. This may be done with a straightedge and a good carpenter's level. The crest and gage levels should be checked carefully for settling or frost action.

Table 17 shows the discharges in cubic feet per second and gallons per minute for different heights (H) of water (as measured by the weir

TABLE 17.—Discharge table for a 24-inch, rectangular, sharp-crested weir with end contractions ¹

Head		Discharge		Head		Discharge	
Feet	Inches	Cubic feet per second	Gallons per minute	Feet	Inches	Cubic feet per second	Gallons per minute
0.01	1/8	0.006	3	0.51	6 1/4	2.33	1,049
.02	1/4	.018	8	.52	6 1/2	2.40	1,080
.03	3/8	.034	15	.53	6 3/4	2.46	1,107
.04	1/2	.052	23	.54	6 1/2	2.53	1,138
.05	5/8	.072	32	.55	6 3/4	2.60	1,170
.06	13/16	.096	43	.56	6 3/4	2.67	1,202
.07	15/16	.122	55	.57	6 13/16	2.74	1,233
.08	15/16	.146	66	.58	6 15/16	2.81	1,265
.09	1 1/16	.176	79	.59	7 1/16	2.88	1,296
.10	1 1/16	.206	93	.60	7 1/16	2.96	1,332
.11	1 1/16	.236	106	.61	7 1/16	3.03	1,364
.12	1 1/16	.270	122	.62	7 1/16	3.10	1,395
.13	1 1/16	.304	137	.63	7 1/16	3.17	1,427
.14	1 1/16	.340	153	.64	7 11/16	3.25	1,463
.15	1 1/16	.378	170	.65	7 13/16	3.32	1,494
.16	1 1/16	.416	187	.66	7 15/16	3.40	1,530
.17	2 1/16	.456	205	.67	8 1/16	3.47	1,562
.18	2 1/16	.496	223	.68	8 1/16	3.56	1,602
.19	2 1/16	.540	243	.69	8 1/4	3.63	1,634
.20	2 3/16	.588	265	.70	8 3/8	3.71	1,670
.21	2 1/2	.632	284	.71	8 1/2	3.78	1,701
.22	2 5/8	.677	305	.72	8 5/8	3.86	1,737
.23	2 3/4	.723	325	.73	8 3/4	3.94	1,773
.24	2 7/8	.769	346	.74	8 7/8	4.02	1,809
.25	3	.817	368	.75	9	4.10	1,845
.26	3 1/8	.865	389	.76	9 1/8	4.18	1,881
.27	3 1/4	.914	411	.77	9 1/4	4.26	1,917
.28	3 3/8	.965	434	.78	9 3/8	4.34	1,953
.29	3 1/2	1.02	459	.79	9 1/2	4.42	1,989
.30	3 5/8	1.07	482	.80	9 5/8	4.51	2,030
.31	3 3/4	1.12	504	.81	9 3/4	4.59	2,066
.32	3 13/16	1.18	531	.82	9 13/16	4.67	2,102
.33	3 15/16	1.23	554	.83	9 15/16	4.75	2,138
.34	4 1/16	1.28	576	.84	10 1/16	4.84	2,178
.35	4 3/16	1.34	603	.85	10 3/16	4.92	2,214
.36	4 1/2	1.40	630	.86	10 5/16	5.01	2,254
.37	4 7/16	1.45	653	.87	10 7/16	5.10	2,295
.38	4 9/16	1.51	680	.88	10 9/16	5.18	2,331
.39	4 11/16	1.57	707	.89	10 11/16	5.27	2,372
.40	4 13/16	1.63	734	.90	10 13/16	5.35	2,408
.41	4 15/16	1.69	761	.91	10 15/16	5.44	2,448
.42	5 1/16	1.75	788	.92	11 1/16	5.53	2,489
.43	5 3/16	1.81	815	.93	11 3/16	5.62	2,529
.44	5 1/4	1.88	846	.94	11 1/4	5.71	2,570
.45	5 3/8	1.94	873	.95	11 3/8	5.80	2,610
.46	5 1/2	2.00	900	.96	11 1/2	5.89	2,651
.47	5 5/8	2.07	932	.97	11 5/8	5.98	2,691
.48	5 3/4	2.13	959	.98	11 3/4	6.07	2,732
.49	5 7/8	2.20	990	.99	11 7/8	6.15	2,768
.50	6	2.26	1,017	1.00	12	6.25	2,813

¹ Computed from the formula $Q = 3.247LH^{1.48} \frac{1.566L^{1.48}}{1+2L^{1.48}} H^{1.48}$

gage) flowing over a 24-inch, rectangular, sharp-crested weir, expressed in hundredths of a foot as well as in inches and fractions. Example: Water-level reading on measuring gage is 3 3/8 inches, which according to table 17, indicates that 389 gallons of water per minute is flowing over the weir. If the water level were halfway between 3 3/8 inches and 3 1/4 inches on the gage, at 3 1/16 inches, half the difference between 411 and 389, or 11, would be added to 389, making the flow 400 gallons per minute.

PIPE AND DITCH DISCHARGE DATA

Nurserymen are frequently confronted with the necessity for computing sizes of pipe needed to deliver water in desired quantities and without undue loss of pressure. As an aid in selecting correct pipe sizes for various flows of water, it is necessary to consider such factors as volume, loss of head, and distance the water must travel.

Table 18 gives, for 2-inch diameter pipe and discharge of 50 gallons per minute, a loss in head of 9.9 feet per 100 feet of pipe due to friction. For 1,000 feet of pipe the loss of head will be 10 times this amount, or 99 feet. Since the total head in feet at *D* is 79 feet, it is readily seen that the 2-inch pipe is too small. For 2½-inch pipe the loss per 100 feet is 3.32 feet, or 33.2 for 1,000 feet of pipe. The nurseryman should therefore use 2½-inch pipe, which will deliver the desired 50 gallons per minute at *D* with only 33.2 feet friction loss in the total available 79 feet of head. If 3-inch pipe were used the loss in head would be only 13.8 feet. If *D* were the same elevation as *E* and the total available head only 69 feet, the nurseryman could still use the 2½-inch pipe. If the water were received at *E* from a gravity-flow ditch, however, the total head at *D* would have been 10 feet, requiring 4-inch pipe, of which the friction head loss for 1,000 feet is $10 \times .34 = 3.4$ feet.

Discharge in gallons per minute from ditches of sizes commonly used—12 inch and 16 inch (fig. 13)—computed on the basis of a water depth of 6 inches, are given in table 19. Depth may be increased somewhat if more capacity is necessary, but there is danger of breaks in ditch banks if the water level is carried too high.

TABLE 19.—Computed discharges from 12-inch and 16-inch ditches, with water depth of 6 inches, down different gradients

Ditch 12 inches wide			Ditch 16 inches wide		
Slope (inches per 100 feet)	Approximate discharge		Slope (inches per 100 feet)	Approximate discharge	
	Cubic feet per second	Gallons per minute		Cubic feet per second	Gallons per minute
¼	0.22	99	¼	0.28	126
½	.33	148	½	.42	189
¾	.41	184	¾	.52	234
1	.47	212	1	.60	270
1½	.57	256	1½	.73	329
2	.68	306	2	.88	396
2½	.74	333	2½	.96	432
3	.82	369	3	1.05	472
3½	.89	400	3½	1.15	518
4	.94	423	4	1.21	544
6	1.16	522	6	1.49	670

OVERHEAD IRRIGATION

Since deciduous nursery seedlings can, under normal conditions, be grown satisfactorily under ditch or row irrigation, no general need exists to install the more expensive overhead sprinkling systems. Such systems, however, afford a convenient method of irrigation and are especially helpful during the germination period of small-seeded species such as elms and mulberry. Since the initial investment per acre is large, and the number of deciduous seedlings that can be grown on an acre is limited, an overhead system can be justified only as a long-time investment in permanent nurseries. In the Forest Service nurseries in the plains region, overhead sprinkling has proved satisfactory only on sandy soils where the water penetrates easily. Observations on relative effectiveness at different times of day in the warm summer months indicate that watering with the overhead system is most effective in the evening or at night. In the hot part of the day, less than 50 percent of the water may reach the ground owing to vaporization in midair, and some of the water that does reach the ground evaporates before it can penetrate to an effective depth. Nozzles with comparatively large orifices will reduce excessive loss due to vaporization.

GROUND PREPARATION AND SEED SOWING

PREPARING THE SOIL

A well-prepared seedbed is the nurseryman's first consideration in planning his season's operations. Since nursery stock production is an intensive form of crop culture, it is essential that the preparation of the soil be given much closer attention than would ordinarily be necessary in the production of most farm crops. Good tilth (the physical condition of the soil) is highly important in nursery work, since the soil must be in a finely pulverized condition to assure close contact with the seed before germination, to facilitate emergence during germination, and to permit easy cultivation during the growing season. Soil preparation technique in deciduous nurseries will vary according to soil texture. Light soils require less preparation to put in proper condition for sowing than the heavier soils, since they are less prone to become hard and cloddy and their physical condition is more easily regulated.

The proper handling of previous crop residues and fall or early winter plowing constitute a preliminary preparation. If the area has previously been in nursery crop, no crop remnants will exist except possibly discarded cull stock. Such material should be raked up and burned, since, because of its woody nature, it will not disintegrate rapidly, will interfere with all cultural operations, and may harbor disease and insect pests. In the Southern States, termites in such material may constitute a serious problem.

If the nursery area has previously been in farm crops and a considerable quantity of coarse and heavy cornstalk, stubble, or other trash remains on the ground, this material should be disked thoroughly or otherwise cut before plowing. If the quantity of the material present is excessive, it may be necessary to rake it up and remove or burn it.

Fall or early winter plowing to a depth of 6 to 8 inches is preferred. The operator should strive to achieve a narrow furrow slice standing somewhat on edge, thus leaving the land rough. If fall sowing is not practiced, fall-plowed areas should be left in rough condition over winter.

If plowing must be delayed until spring, plowing should not be done, particularly in the heavier soils, when the soil is so wet that a rough, cloddy seedbed will result. It is far better to delay plowing for a week. Disking or harrowing should immediately follow spring plowing before the surface soil has a chance to dry out. Ordinarily, best results are obtained by attaching a section of drag to the plow.

The advantages of fall or early winter plowing over spring plowing may be summed up as follows:

A maximum area of soil is exposed to the mellowing influence of alternate freezing and thawing, thereby resulting in good tilth.

The roughened condition aids in catching snow and will reduce run-off which might result from late fall, winter, or early spring rains. The moisture-catching capacity can be increased by listing after plowing. An added advantage is that the roughened condition aids in preventing the soil from blowing.

With soil-preparation work in the spring lessened, subsequent operations may get under way sooner.

Fall plowing allows the seedbed to become settled.

It permits some decomposition of crop residues and organic fertilizers.

It may help in the destruction or checking of certain insect and disease pests.

Further preparation of the soil before sowing in the spring should await favorable soil-moisture conditions, since stirring the ground when it is too wet may result in a puddled soil. When moisture conditions are favorable, the entire area should be disked, and, if necessary, cross disked. The necessary leveling should also be done at this time. If the area is subject to blowing, it may be necessary to prepare each individual block just preceding sowing rather than the entire area at one time.

Ordinarily on fall- or winter-plowed areas, disking at the proper time in the spring will constitute adequate preparation, but in some instances harrowing with a spike-tooth or spring-tooth harrow will be necessary to pulverize the soil properly. Rolling or culti-packing is seldom necessary after fall plowing but will frequently prove desirable after spring plowing to settle the seedbed.

With well-prepared seedbeds and properly handled seed, sowing resolves itself into getting the best possible adjustment of the three primary factors, namely, season, density, and depth of sowing. The method employed is but a means of obtaining the desired correlation and is, therefore, secondary. The practice of ridging the rows following sowing is also secondary, since it is merely a means of protecting the seed until germination takes place.

ROW SPACING

Distance between rows is governed by the spacing which will give the maximum production of premium-grade seedlings per acre at the lowest cost per thousand. Many items of nursery cost, such as sowing, care during germination, weeding, thinning, hand cultivating and hoeing, digging, and, to a certain extent, power cultivating, irrigating, and supervision, are largely governed by the number of miles of lineal row in the nursery rather than the number of acres.

Row spacing may be as close as 10 inches if overhead irrigation is available (fig. 20) and if a lifter is available that will dig five rows at a time.

Where ditch irrigation is used, the Forest Service nurseries have used row spacing ranging from 16 to 42 inches. Spacing as close as 21 inches requires that the nursery tract be properly leveled for irrigation. With the equipment now used and from the experience obtained, it appears that a row spacing of 21 to 27 inches will produce the maximum amount of usable stock of most species at the lowest cost per thousand. With an average production of 6 to 8 usable seedlings per lineal foot, this row spacing will grow approximately 150,000 seedlings per acre (table 20).

Seedling bands not more than 2 to 3 inches wide are preferred; wider bands greatly increase hand work and therefore weeding costs. The rows should be straight and the edges of the bands sharply defined, since this facilitates all cultural operations.



F327108

FIGURE 20.—Green ash seedlings with a 10-inch space between rows, grown under overhead irrigation.

SEASON OF SOWING

Sowing of deciduous species in the nursery may be carried on in spring, summer, or fall. With the double objective in mind of premium-grade seedlings and high germination, nurserymen have found that each species presents its own problem and that it is highly important to determine the optimum sowing season for each.

TABLE 20.—Row spacing and seedlings per foot of row needed to produce 150,000 seedlings per acre

Distance between rows, center to center (inches)	Total length of row per acre	Usable seedlings per foot	Distance between rows, center to center (inches)	Total length of row per acre	Usable seedlings per foot
	<i>Feet</i>	<i>Number</i>		<i>Feet</i>	<i>Number</i>
45.....	11,616	12.9	27.....	19,360	7.7
42.....	12,446	12.1	24.....	21,780	6.9
39.....	13,403	11.2	21.....	24,891	6.0
36.....	14,520	10.3	18.....	29,040	5.2
33.....	15,840	9.5	15.....	34,848	4.3
30.....	17,424	8.6			

In general, the nature of the seed dormancy determines for all species the optimum time of sowing. Species having embryo dormancy, or a combination of embryo dormancy and impermeable seed coat, respond either to fall sowing, which is sometimes preferable, or to stratification followed by spring sowing. Species possessing only

an impermeable seed coat are preferably spring sown, following the prescribed pretreatment of rendering the seed coat permeable. Species possessing no dormancy are preferably spring sown.

Several guiding principles can be stated with respect to spring sowing. If the seed has had some form of pretreatment involving the absorption of water, such as stratification, water soaking, or acid scarification followed by water soaking, it should be placed in direct contact with moist soil when sown, and the soil kept moist until germination is completed. Such seed should not be sown in dry soil, unless irrigation immediately follows sowing, because the dry soil may absorb moisture from the seed, thereby retarding or delaying germination and thus tending to reduce the viability of the seed. If seed has had no pretreatment, or the pretreatment did not involve the absorption of water, it can be sown in moderately dry soil with no loss in germination or vitality, provided adequate moisture for germination is received in due time.

Some variation in time of spring sowing is necessary when handling a number of species. Seed that has been in stratification the required period will usually be sown as soon as the ground is in condition and will germinate and grow even though the soil may be comparatively cold. Other species not requiring stratification vary somewhat as to their temperature requirements for germination, and sowing time may be adjusted accordingly. Leguminous species, for example, appear to respond better if their sowing is delayed until the soil has warmed up appreciably. A safe rule to follow for such species is to wait until farmers in the same locality start planting corn.

Some attention should be paid to past weather records and no sowings should be made so early that seedlings will be up prior to the average date of the last killing frost. Likewise, sowing should not be delayed when conditions are right, since late sowings are exposed to the hazard of loss from heat.

Summer sowing is sometimes resorted to for the production of seedlings of a desired size. For example, sowing of black locust is often delayed until late June in order to hold down the size of the stock. In the Northern States, certain species, notably Siberian pea-tree, require more than 1 year in the nursery to attain planting size, but if given 2 full years are likely to develop into oversize seedlings. Sowing of such species is often delayed until midsummer of the first year in order that growth the first season may be retarded.

Heat injury is the main hazard encountered in summer sowing. Germinating seedlings are quite soft and succulent, and high temperatures, especially when associated with high summer winds, burn such seedlings regardless of available soil moisture. Insect attacks also are more serious, and hardening-off is more difficult than with spring sowing.

Although fall sowing exposes the seed to certain hazards not encountered in spring sowing, it will produce a larger seedling. It has a further advantage from the nurseryman's viewpoint, in that it does away with the necessity for stratifying and otherwise handling the seed over winter. These advantages are not net gains, however, since fall sowings are subject to a number of dangers that may cause complete failure.

Throughout the winter, fall-sown seed should have direct contact with the moisture in the soil. Dry, cold ground will have very little beneficial effect on the seed requiring moisture as a part of its pre-germination treatment. Moisture absorption by the seed is negligible in frozen soil, and poor germination often occurs if the soil freezes shortly after the seed is sown. In latitudes where the ground alternately freezes and thaws during the winter months and winter precipitation provides adequate moisture, this point is of minor importance; but in the Dakotas fall sowings should be made early enough to permit some moisture absorption by the seed before the ground freezes.

If the nursery soil is heavy, alternate freezing and thawing, as in mild winters, commonly brings the seed to the surface, exposing it to drying winds, rodents, and birds. This frost heaving can largely be avoided by throwing up a broad ridge of soil to a height of 6 inches over the seed rows.

Perhaps the most serious problem to be encountered in fall sowing is that a premature warm period in the spring may cause early germination, and that subsequent freezing weather will destroy the seedlings. If the warm spell is not unduly prolonged, however, this can be guarded against by maintaining a ridge of soil over the seed rows, thus controlling or preventing to some degree the penetration of heat.

DEPTH OF SOWING

Small seed should be sown at less depth than large seed. Other important factors that enter into the depth of sowing are the texture of the soil and season of sowing. It is safe to sow at a greater depth in sandy than in fine-textured (heavy) soils, because of the comparative ease of seedling emergence. Where ridging is practiced, the season of sowing should not influence sowing depth, but if ridging is not practiced, it is desirable that fall-sown seed be sown at twice the depth of spring-sown seed of the same species.

Under the practices followed in the plains region, the following rule has been used as a guide in gaging the depth to sow the seed: Sow all seed to a depth of three times the average diameter of the clean seed kernel but in no case less than $\frac{1}{4}$ inch. This rule applies to all spring-sown seed in fine- to medium-textured soils regardless of whether ridging is practiced, and results in 0.5 inch or thereabouts as the sowing depth of a great many of the deciduous species. Very few species are sown to a depth of more than 1 inch below the soil level.

SOWING RATIOS TO DETERMINE DENSITY OF SOWING

Data obtained by the Lake States Forest Experiment Station have shown rather conclusively that first-year survival, growth, and vigor of field plantings in the plains region is in direct proportion to the caliper of the nursery stock—larger caliper stock produced better results than smaller stock. It was demonstrated that stock with a caliper of between three-sixteenths and six-sixteenths inch at a point 2 inches above the ground line was, for most species, the premium grade from point of percent of field survival and cost per surviving tree. Optimum size varied somewhat by species, a point which is discussed in detail in connection with the grading of nursery stock.

The data further showed that the caliper of the nursery stock is, to some extent, dependent on the density at which the stock was grown in the nursery.

Since average caliper of deciduous nursery seedlings decreases as the stand density increases (see table 21), it is important that densities

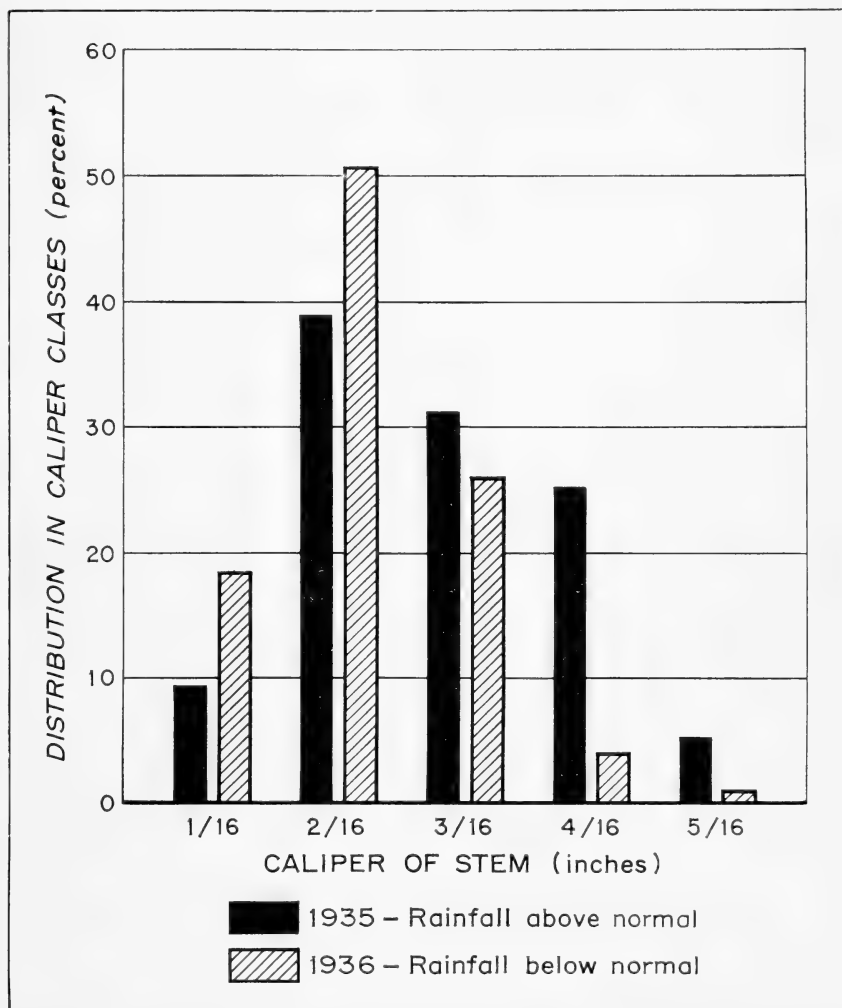

FIGURE 21.—Normality of rainfall has a marked effect on the size of nursery stock produced. Density per lineal foot of bed in both years was $7\frac{1}{2}$ seedlings.

in the nursery be maintained approximately within a range that will permit the largest number of premium-grade seedlings to be produced per lineal foot. Naturally this range of densities will vary somewhat according to species, length of growing season, precipitation (fig. 21), available soil moistures, soil texture and fertility, and species. Whether 1-year or 2-year stock is to be grown is also of importance.

TABLE 21.—Effect of stand density on caliper of seedlings as shown by number of seedlings in each caliper class

Species and number of seedlings in 10 lineal feet of row ¹	Caliper class							Average cali- per of all seed- lings
	1/16 inch	2/16 inch	3/16 inch	4/16 inch	5/16 inch	6/16 inch	7/16 inch	
Honeylocust:	<i>Num- ber</i>	<i>Num- ber</i>	<i>Num- ber</i>	<i>Num- ber</i>	<i>Num- ber</i>	<i>Num- ber</i>	<i>Num- ber</i>	<i>Inch</i>
20	2	4	3	6	3	2	0	0.22
43	5	12	10	14	2	0	0	.18
14	14	10	17	8	1	0	0	.15
50	27	21	15	7	1	0	0	.13
71	19	29	22	10	0	0	0	.14
98	44	41	12	1	0	0	0	.11
115	47	25	34	7	1	1	0	.13
Green ash:								
18	0	3	3	3	5	4	0	.26
30	0	6	7	7	3	6	1	.25
45	1	6	14	16	6	2	0	.22
59	0	16	23	15	5	0	0	.20
81	9	27	25	18	2	0	0	.17
147	38	72	22	13	2	0	0	.13
239	104	87	41	6	1	0	0	.11

¹ 6-inch-wide bands with rows 40 inches apart.

Observations made from 1935 to 1938 in 20 different deciduous nurseries in the plains region indicate that densities ranging from 5 to 10 seedlings per lineal foot of row, after the early season losses, produce the greatest number of premium-grade seedlings. It is best as a rule to grow the fast-growing species of 1-year stock in slightly denser stands than the slow-growing species. Also, species to be grown 2 years in the nursery in the Northern States can be grown in denser stands than species requiring only 1 year. The ideal sowing rate will result in the desired stand density with allowance for the inevitable losses which occur before the stand is established.

Sowing rates to produce a given density will be governed by the viability of the seed and the ratio that exists between viability and ultimate final stand. Although the viability of the seed can be determined by germination tests, the ratio between viable seed sown per lineal foot of row and the ultimate stand varies greatly. Numerous factors determine this ratio, such as soil texture and fertility, weather conditions (especially during the germination period), intensity of the nursery care, growth habits of the species, amount of loss from disease, insects, and rodents, and, lastly and perhaps most important, the size of the seed. Large-seeded species such as plum, apricot, honeylocust, and many others, which produce a sturdy vigorous growth immediately upon germination, can normally be expected to show lower mortality during and immediately following germination than small-seeded species such as elm and mulberry. Seedlings from small-seeded species are normally very delicate during early life and heavy losses can occur quickly from soil crusting, heat, wind burn, drought, and other causes. Figure 22 illustrates the comparative size of various species during early life.

For all species a certain percentage of loss is unavoidable and some oversowing must be done to allow for subsequent loss. Alba H. Briggs of the Prairie States Forestry Project, Lincoln, Nebr., in a study conducted at a Nebraska nursery during the summer of 1937, found that, at the end of the season, honeylocust, coffeetree, and walnut retained over 90 percent of their original stand, plum 89 percent, hackberry and Chinese elm 87 percent, Russian-olive 65 percent, choke-cherry 60 percent, American elm 38 percent, and mulberry 20 percent.

In every instance two-thirds to three-fourths of the total loss sustained occurred before July 1st while the seedlings were small and succulent. His findings substantiate the practice of using variable sowing ratios for different species.

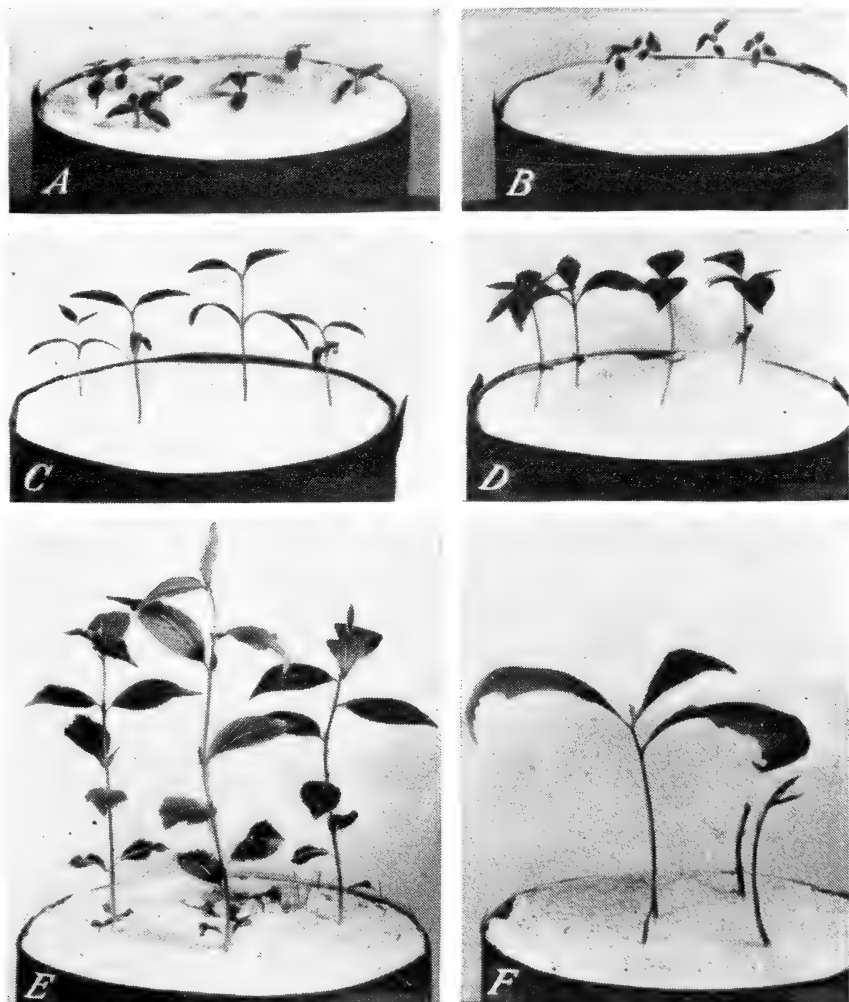

F342550-9

FIGURE 22.—Comparative height of deciduous seedlings 10 days after emergence: A, Lilac, $\frac{1}{2}$ to $\frac{3}{4}$ inch; B, Russian mulberry, $\frac{1}{2}$ to $\frac{3}{4}$ inch; C, green ash, $1\frac{1}{2}$ to 2 inches; D, chokecherry, $1\frac{1}{2}$ to 2 inches; E, American plum, 4 to 6 inches; F, bur oak, $3\frac{1}{2}$ inches. Only the tallest bur oak seedling is 10 days old.

The recommended sowing ratios for nurseries using furrow irrigation (to be found in table 22, p. 102) have been shown by experience and actual field tests to be fair ratios under normal growing conditions and good nursery practice. Should unusually favorable moisture conditions prevail, it is to be expected that these ratios will result in stands in excess of desired density, thus necessitating thinning. In case overhead irrigation is available, the ratios, especially for the smaller-

seeded species, can be cut in half because of the better moisture control that can be maintained.

Knowing the germination percentage and the ultimate stand desired per lineal foot for each species, it is possible to compute the number of seed to sow per lineal foot by the following formula: $N = \frac{100SR}{P}$, wherein N =number of seed to sow per lineal foot; S =ultimate stand desired; P =germination percent of the seed; and R =sowing ratio. For example, if a stand of 6 seedlings per lineal foot is selected as the optimum density for a particular species, and if the seed has a germination of 50 percent and the sowing ratio of 4:1, the formula then becomes $N = \frac{100 \times 6 \times 4}{50} = 48$, the number of seed to sow per lineal foot of drill.

Given the number of seed per pound and the lineal feet of row per acre, a supplementary formula of value for expressing the number of seeds sown per foot of drill in pounds of seed needed per acre is $A = \frac{NF}{M}$, wherein A =pounds of seed needed per acre; N =number of seeds sown per foot of drill; M =number of thousands of seed per pound; and F =number of thousands of lineal feet of row per acre. For example, if 48 seeds are to be sown per lineal foot and the rows are to be 2 feet apart (21,780 lineal feet of row per acre) and there are 26,000 seed per pound, the formula becomes $A = \frac{48 \times 21.78}{26} = 40.2$ pounds of seed needed per acre.

If adequate seed supplies are available, the safest procedure is to sow heavily enough to obtain stands slightly in excess of optimum density and after the seedlings are well established to thin down to the desired final stand. This is especially desirable for certain species which are difficult to establish. Costs per thousand of growing seedlings are virtually in an inverse proportion to the percent of stand, i. e., a 50-percent stocking will practically double the cost per thousand of that in a 100-percent stand. Therefore, the cost of the seed used in oversowing and of the labor involved in thinning is well justified within reasonable limits. Briggs has obtained data showing that percent of emergence of seedlings decreased consistently as rate of sowing increased, owing apparently to such factors as increased damping-off and competition for available moisture in the denser sowing.

SOWING METHODS

The method of sowing seed is secondary in importance to the factors of season, density, and depth of sowing. Emphasis should be placed on obtaining even distribution of seed and uniform depth of cover. With hard, dry seeds of spherical or ovoid shape, uniform distribution can easily be assured by mechanical drill sowing, the seeders being hooked up in multiple. However, not all of the tree species grown for plains planting lend themselves readily to machine sowing because of shape and size of seed, or pretreatment. No satisfactory mechanical sower is available that will sow all the types of seed in 2- to 3-inch bands.

Because of the lack of a suitable mechanical sower, nurserymen in the plains region have relied upon hand sowing of some seed to secure even distribution in the bands. This method (fig. 23) necessitates



FIGURE 23.—(U.S.D.A., 5592)

FIGURE 23.—Hand sowing green ash seed in narrow bands in rows spaced 10 inches apart. A, Opening the furrows; B, sowing seed; C, covering seed.

several operations, namely, opening the band or furrow, distributing the seed, covering, firming, and, in some cases, ridging the rows. This hand method is fairly satisfactory in small nurseries but it is obvious that in larger nurseries any mechanical method that will do all these operations at once will reduce sowing costs materially.

A number of seeding devices have been used with considerable success in sowing hardwoods in the plains nurseries. For seed that can be sown mechanically, the best device consists of a series of seed drills mounted on a frame and pulled by a tractor (fig. 24).

Many species of seed, however, such as those with wings, those of small size, or seed which has not been separated from the stratifica-



FIGURE 24.—Rear view of 4-row mechanical seeder.

F37540

tion medium, cannot be sown mechanically. The nurserymen of the Prairie States Forestry Project developed, however, a semimechanical method which would handle any size or shape of seed and, at the same time, operate much faster than hand sowing. The most satisfactory of these is a tractor or horse-drawn sled on which 2 to 4 men ride and distribute the seed in an even flow into a funnel or trough which is attached to the seeder (fig. 25). Boxes or bags of seed are placed within easy reach of the men doing the seeding so that there is an uninterrupted flow of seed. The seed drops into a shallow furrow opened by a metal runner or shoe and thereupon the furrow is closed by sweeps and firmed by wheels directly behind the seeding trough. In case the seed rows are to be ridged, a pair of disks are so placed as to straddle each seed row. This type of machine allows the men who are doing the seeding to see the distribution of the seed and affords them ample opportunity to obtain an even spread at all times.

Several other seeders work on the same principle but with certain modifications, such as a large funnel or hopper into which the seed is dropped, and equipment of hand levers that regulate the sowing depth between limits of $\frac{1}{4}$ to 2 inches. The entire device is swung

on an axle between two wheels so that it can be pulled with a rubber-tired tractor and raised out of the ground when necessary.

Such machines do good work if reasonable care is exercised to assure proper sowing depth. If the motive power is supplied by a tractor throttled down to an even speed of $1\frac{1}{2}$ miles per hour, a better



F353691-35369

FIGURE 25.—A, Front view of sled type of seeding machine. The seed is fed by hand into the long horizontal seed trough. B, Side view of sled type of seeding machine.

job of sowing will be accomplished than if horses or mules are used, since the latter ordinarily walk at a faster rate and at uneven speeds. At a seeding speed of close to $1\frac{1}{2}$ miles per hour and a row spacing of 21 inches, a 4-man seeder will sow approximately 8 acres in an 8-hour day.

Regardless of method followed, careful sowing should be the objective rather than low initial costs, since in the final analysis sowing costs are a relatively small part of the cost per thousand of producing seedlings. A cheap job of sowing may be quite expensive in the long run if it results in low production.

Whether seed rows should be ridged or not is largely determined by season of sowing. Ridging serves several purposes. It delays drying out of the topsoil beneath the ridge, assuring to the seed a uniform moisture for germination; it marks the row, thereby facilitating cultivation and irrigation, which are sometimes necessary before germination takes place; and it keeps the seed from being washed out by excessive heavy rains or blown out by hard winds, and to a certain extent prevents pilfering by birds and rodents. Furthermore, in the process of raking down the ridge after the seed starts to sprout, but before the sprouts reach the ground level, the first crop of weeds is removed. If the weeds are allowed to come up with the plants, they can be pulled only by a great amount of hand labor and, on weedy soil, only at the sacrifice of a considerable number of young plants.

Ridging of seed rows is recommended in all cases where fall sowing is practiced. For spring sowing its employment is a matter of judgment on the part of the nurseryman. Ordinarily, in the spring, if soil moisture conditions near the surface are good and the species sown is one that can be expected to germinate in several days, ridging need not be practiced. An overhead sprinkling system reduces the necessity for ridging.

Moisture, oxygen, and proper temperature are the three essentials for germinating seed, and if these factors are not held within certain limits, no germination will occur. It is obvious, therefore, that the ridge must not be too high and should not be packed too hard. For fall sowing, ridge heights up to 5 or 6 inches are required for protection, largely from frost heaving and premature germination; but for spring sowing, ridges 3 inches high are adequate. Higher ridges prevent heat and air from penetrating to the seed and, if the ground is wet for long periods, may cause the seed to rot.

GERMINATION AND SEEDLING CULTURE

All the cultural activities following the sowing of the seed up to the time that germination is complete, have been grouped by the writers under the term "germination culture." More specifically, the following operations are included in this term: Raking down or removing ridges, breaking crust, and any irrigating or cultivating that is intended as an aid to germination. In the plains region, nurserymen have found that careful germination culture is quite important, particularly with light-seeded species and in heavy soil. The term "seedling culture" as used here includes all cultural operations involved in bringing the seedling crop to maturity from the time germination is completed. More specifically, it includes the operations of thinning, control of growth, cultivating, weeding, irrigating, hardening off, and top pruning.

CARE DURING GERMINATION

The removing or raking down of ridges requires good judgment as to technique in performing the job and the time at which it is done. The high ridges thrown up over the seed rows in fall sowing should be partially removed as soon as the danger of premature germination is

passed. This is done to permit better heat penetration and aeration of the soil surrounding the seed. After this initial treatment, fall sowings are handled the same as spring sowings.

A knowledge of the germinating habits of the individual species is essential if the nurseryman is to determine correctly the proper time to remove the ridge. Progress of germination in the nursery has a similar trend to that of germination in the laboratory, as shown later in table 22, except that it is frequently much faster under favorable conditions. When germination of the seed is largely completed within a short time after the initial germination takes place, no difficulty is

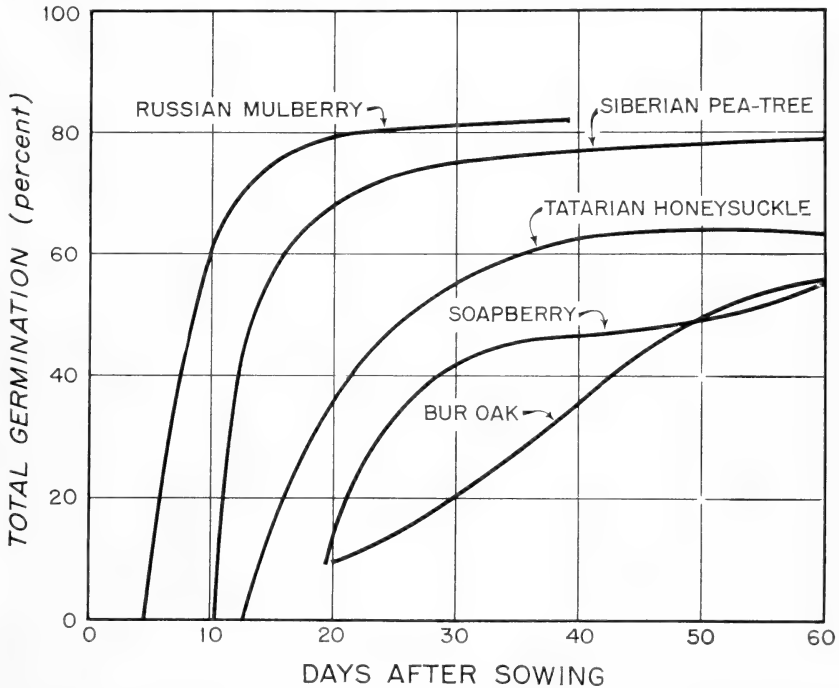

FIGURE 26.—Typical laboratory germination of seeds after being properly pretreated.

involved. In such cases the ridge will be removed as the first sprouts reach the ground level. When the seed continues germinating at an even rate over a period of 2 to 4 weeks, however, as that of soapberry, bur oak, and honeysuckle (fig. 26), the removal of the ridge should be delayed until a fair share of the sprouting seedlings have progressed into the ridge itself. Although some losses may then occur, the resulting final stand will warrant this procedure.

Removing the ridges is probably the most delicate and painstaking operation of the entire nursery season. An ordinary garden rake is the preferred tool in most cases, but small hand tools, in the use of which the laborer must get down on his knees, while considerably slower than the rake, result in a better quality of work and are therefore justified under some conditions, especially for certain tender species such as lilac. The workman down on his knees can always

judge the proper depth, whereas if he is standing he may go too deep and break off the sprout, or uncover too little and leave the seedling to emerge through an excessive soil covering, in many cases causing considerable loss.

The crusting of surface soil over the seed following rain or irrigation frequently presents a problem, especially in cases where the seed rows are not ridged or where germination is prolonged following removal of the ridges. As a solution, the Forest Service has devised a simple implement for pulverizing crusts, called the rotary crust breaker (fig. 27). This consists of a wooden cylinder enclosed in light-gage

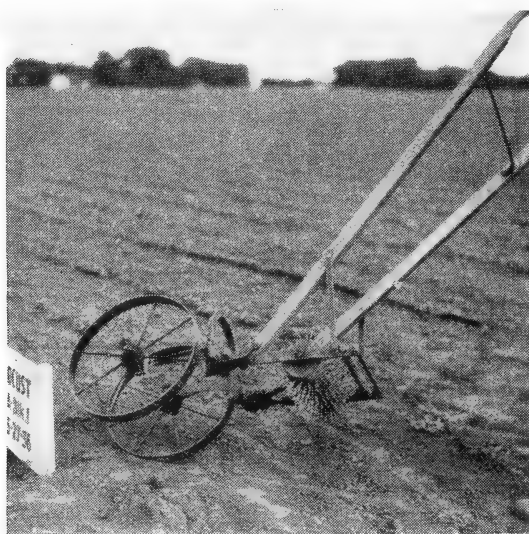

F342195

FIGURE 27.—Rotary crust breaker for pulverizing crusted soil over seed rows.

sheet metal and set with nails. The nails, punching a large number of holes in the soil, effectively pulverize the crust without damage to the germinating seedlings. A series of spring-steel prongs meshing with the nails and pressing against the roller serve to clear the implement at all times. The 2-wheel push plow for carrying the roller is preferred to handles attached to the axis of the cylinder, since it permits readier adjustment of pressure to meet the varying hardness of the crust. It also makes it easier to pass over any portions of the rows where the

seedlings may already have emerged to a satisfactory stand. Use of the crust breaker provides all the cultivation necessary during germination to aerate the soil, speed up germination, and possibly guard against damping off.

If the nursery soil is quite dry, it should be irrigated before rather than after seed sowing, in order to store up moisture in the soil for the germination period. Irrigation will ordinarily not be necessary during the germinating period if sufficient soil moisture is available at the time the seed is sown, if proper cultural practices to conserve this moisture are followed, and provided prescribed practices are followed with respect to seed treatments to hasten germination. With overhead sprinklers the problem is simplified, but in heavy soils crusting and baking will occur following application of water. Furrow irrigation presents a greater problem, since an average of 2 to 3 inches is usually the minimum that can effectively be applied under this system in the best type of nursery soils. It is desirable, therefore, to follow practices that will insure successful germination of the seed without irrigation, especially where furrow irrigation is practiced later on.

Should it become necessary to irrigate during germination, the minimum amount of water needed to soak up the seed area should be applied. To avoid washing out the seed, the water should be applied immediately adjacent to the rows rather than flooded over them. The formation of pools and standing water in slight depressions should be avoided. It is helpful to have the rows ridged to mark their location and to prevent washing out of the seed.

THINNING

If the stand following germination and early establishment is overdense, i. e., more than 8 to 12 seedlings per foot, it is good practice to remove the surplus seedlings. This will insure optimum development of the remaining seedlings and will in the end result in a higher total production of better quality stock.

Thinning should logically be done during one of the early weeding, or as soon as the seedlings have started to develop a woody stem. Prior to becoming woody, the seedlings are still susceptible to heavy losses from diseases and insects.

Insofar as possible, the smaller, weaker understory seedlings should be removed. The common method of reducing the stand density consists in pulling out the surplus seedlings by hand or cutting them out with knives or weeders. It is desirable to leave the remaining seedlings uniformly distributed over the entire seedling band.

CONTROLLING SIZE AND QUALITY OF SEEDLINGS

After the seedling stand is established, the nurseryman's task is to focus his cultural activities on obtaining a large percentage of seedlings of optimum size and quality for field planting by the end of the season, or, for those species that require it, at the end of the second season (fig. 28). As previously stated, the preferred size of seedlings for plains planting for the majority of the species is a caliper of about

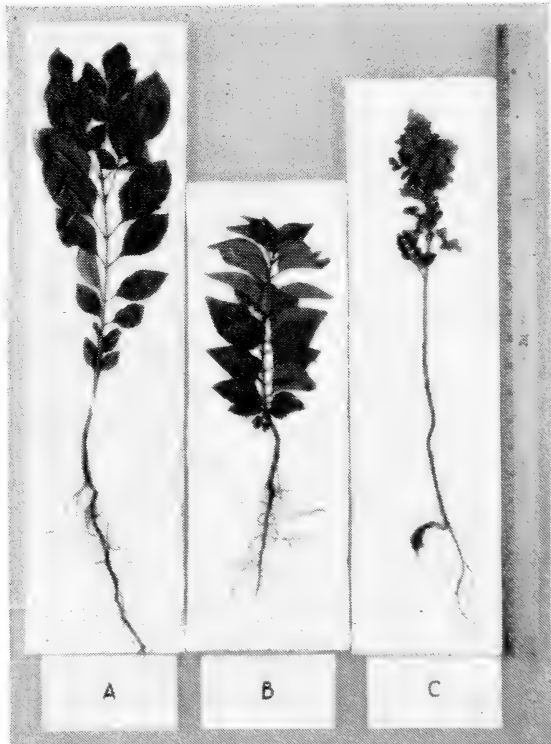

F342205

FIGURE 28.— Undersized 1-year-old seedlings from a South Dakota nursery: A, Green ash; B, lilac; C, Siberian pea-tree. These species should be grown $1\frac{1}{2}$ to 2 years in the nursery in the northern plains States to develop to premium size.

0.25 inch at a point 2 inches above the ground line. To this the nurseryman will add the quality objective of solid, woody, well-ripened stock with well-branched, compact root systems.

In this endeavor, account must be taken of the long growing season in the South as against the comparatively short season in the North, and the rapid rate of growth of such species as Chinese elm and black locust in contrast with the slower growth rate for species like green ash and hackberry. In all cases, it is best to encourage full, unretarded growth during the first half of the season and to reserve the control measures for the latter half of the season. Otherwise the nurseryman may be faced with the necessity of forcing the seedlings in the latter part of the growing season, and so cause them to remain soft and succulent late in the fall and difficult to harden off properly. Such seedlings are more subject to injury from occasional early frosts, are more difficult to handle in storage, and are more subject to desiccation in drought periods, with consequent great reductions in survival.

MOISTURE REGULATION

With optimum stand density and soil fertility, control of growth becomes largely a matter of moisture regulation. If an abundant supply of soil moisture is well distributed throughout the season, growth will be fairly consistent and, barring early frosts, will continue until late in the fall. Under such circumstances, the top growth rate of the seedlings may materially decrease during the heat of the summer but it will increase again during the cooler early-fall months, particularly in the Southern States. Therefore, for species that need to be held back or retarded, cultural practices open to the nurserymen during summer are: (1) Stopping all irrigation, and (2) hastening depletion of the soil moisture by discontinuing all cultivation, thereby packing the soil. Conversely, the opposite practices will force growth to continue.

Certain species such as green ash, honeylocust, and coffeetree need to be forced continuously by irrigation and cultivation during the hot summer months. These species are prone to "set" their terminal buds upon the advent of unfavorable growing conditions; once these buds are formed, the seedlings seldom start height growth again until the next season. Therefore, careful and frequent checking of soil moisture in various parts of the nursery to a depth of at least 1 and preferably 2 feet is essential. It is much more important to check moisture condition at many places in the nursery, even if only by estimation or rough field methods, than to obtain a very accurate record for one or two spots which may not be representative of the nursery as a whole.

Moisture content of soil can be gaged by oven drying, by the use of various instruments, or by estimation. It has been found¹⁴ that nurserymen can quickly learn to estimate closely the available moisture content of a soil by feeling of it and judging its cohesiveness. After such estimates are made, from samples taken to a depth of a foot from various places in the nursery, the samples are placed in tight cans or small glass jars with covers and later weighed. A portion of the sample is dried for 12 to 24 hours in an oven at 210° to

¹⁴ STOECKELER, J. H. MEASURING SOIL MOISTURE CONTENT IN THE FOREST NURSERY. U. S. Forest Serv., Lake States Forest Expt. Sta. release. 4 pp. July 30, 1937. [Mimeographed.]

230° F., and its moisture content computed. The total moisture content, represented by the weight of the moisture in the sample divided by the oven-dry weight of the soil, can then be compared with the recorded estimate. After a number of trials, the estimates will be reasonably close.

A quicker method of determining total moisture content than ovenization, described by Bouyoucos (2), consists in weighing the moist soil in a special cup, then pouring in an igniting alcohol to drive off the water, and reweighing the sample. Moisture content is computed as in the standard method of oven drying. The process takes only 10 to 20 minutes and is reasonably accurate in mineral soils containing less than 11 percent organic matter.

A still simpler device for rough determination of the moisture condition of soil, devised by Livingston and Koketsu (21), is a small hollow porcelain cone about 3 inches long with an absorptive area of almost 2 square inches. The cone, first dried in an electric oven or over some desiccating agent such as calcium chloride or sulfuric acid and weighed, is inserted in the soil to a desired depth, left for an hour, and reweighed to determine the amount of moisture absorbed. In dry soils about 0.1 gram of moisture is absorbed, in moderately moist soils about 1.0 gram, and in very moist soils about 2.0 grams.

All soils have a certain amount of moisture which is unavailable to plants, and the percent of unavailable moisture (known as the wilting coefficient) must be subtracted from the total moisture content of the sample to obtain the available moisture content. If available soil moisture amounting to at least 4 to 6 percent of moisture in excess of the wilting coefficient is not maintained throughout the active growing season, poor growth and inadequate storage of reserve food in the nursery seedlings will certainly be the result. The quantity of unavailable moisture in soil depends on texture; the finer the soil, the greater the amount of water held unavailable. Wilting point for nursery seedlings for several soils are: Sands, 2 to 4 percent; light sandy loam 4 to 6; fine sandy loam, 6 to 8; loam, 8 to 12; silt loams, 12 to 15.

A simple but practical method of determining wilting point¹⁵ is to grow the seedlings in a series of 10 to 20 pots for a period of 2 months and then to discontinue watering. When the leaves show definite signs of wilting, measurement of an average sample of the soil from the zone of root development gives a close value of approximate wilting point.

Various other instruments are available which measure the water-supplying power of the soil (22), or which record total or available moisture on an instrument based on a tensiometer principle (32), but these require considerable care and attention and are not as practicable and simple as the methods listed here.

ROOT AND TOP PRUNING

Root pruning may be practiced to some extent on taprooted plants to hold back top development or change rooting habits. Summer root pruning is commonly practiced on walnut to force lateral root development. It is possible that other taprooted species might be handled advantageously by summer root pruning. A cool, cloudy day should be selected for this operation and it should be followed immediately

¹⁵ Wilting points can also be determined by a quick field method based on cohesiveness of the soil (3) or by a more exact method involving use of a centrifuge (7).

by irrigation. Eight to ten inches is the customary depth for this type of root pruning. The usual tool is a sharp U-blade shrub digger with the lifter removed to prevent unnecessary disturbance of the seedling.

Blocks which are to be handled as 2-0 stock can sometimes be root pruned to advantage at the end of the first growing season if it appears that it will be necessary to retard the growth during the second season. This also makes it possible at this time, in case of shortage of planting stock of the species concerned, to pull whatever seedlings of usable grade have been produced. Such root pruning if not done in the fall of the year may be done in early spring. The soil should be packed firmly following the operation. If the soil is dry, irrigation will be necessary for best results. Ridging up the soil against fall-pruned seedlings to a height of 2 or 3 inches will also be desirable. Six to ten inches is a satisfactory pruning depth.

Top pruning to control size and quality of stock has been experimentally tried by several of the Forest Service nurseries, and for certain shrub species requiring 2 years of nursery growth it has proved itself worth while as a means of promoting low branching and retarding needless height growth. Top pruning does not appear necessary for most tree species, except in the few instances where prolonged or uneven germination has permitted a part of the stand to overtop and so retard the development of the younger seedlings. It has been suggested but not thoroughly tested as a means of forcing diameter growth in lieu of height growth on some species.

CULTIVATION

Deciduous nursery stock as a crop requires rather intensive cultivation, for which two major purposes are recognized: To reduce competition, i. e., remove weed growth; and to keep the soil in good physical condition, thus permitting aeration, normal bacterial action, and absorption of rainfall. Crusting and baking of the surface soil must be held to a minimum when normal growth is expected.

Much of the success of cultivation will depend upon the physical condition of the soil at sowing time. Those soils which are naturally mellow or friable or which have been properly prepared, can be cultivated much more easily and to better advantage than soils that are hard, cloddy, or in a puddled condition.

Cultivating tools should not go deeper than 2 to 3 inches; continuous deep cultivation, especially close to the rows, will sever the shallow spreading roots of the seedlings.

Thoroughness of the cultivation job must also be stressed; a careless job may not only result in mechanical injury to the stock, but may destroy only a small percentage of the weeds and make their later removal more difficult.

Timeliness in cultivation is equally important. Competing growth must be destroyed while it is in the seedling stage, preferably when it is less than 3 inches high. Excessive weed growth invariably makes cultivation more difficult and expensive and less effective, and will cause an unnecessary drain on soil moisture. Timeliness is also of major importance in improving the physical condition of the soil. To keep crusting, baking, or clodding at a minimum, the soil must be cultivated after each heavy rain or following every irrigation, as

soon as it is dry enough so that the upper one or two inches can be brought into a fine, mealy crumb condition.

The type and spacing of sweeps and shovels are important to assure a satisfactory job. Six-inch duck-foot shovels or 6-inch flat sweeps spaced so as to give full cut or cover are to be preferred in weed removal. Sharp, self-scouring tools are essential. Spike-tooth cultivators are desirable where improvement of the physical condition of the soil is the chief consideration.

Close row spacing in nursery operations demands a degree of accuracy and precision in cultural work not easily attained with horses; therefore, tractor power (fig. 29) is becoming increasingly popular in nursery work. Garden tractors, properly equipped, have proved

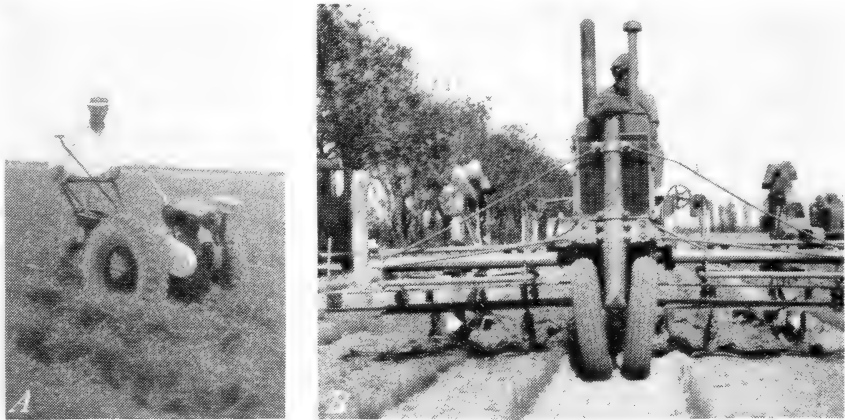

F373167 352824

FIGURE 29.—A, garden tractor equipped with cultivator for small nurseries; B, multiple-row cultivator taking 4 rows at a time.

very satisfactory; but larger tractors will do the job more economically, since they can handle a number of rows at one time. Less turnrow area and reduced losses from trampling are other advantages of tractor cultivation. In addition, the convenience of tractors for intermittent jobs is a factor to be considered.

Hand cultivation and weeding within or closely adjacent to the rows are necessary as soon as the machine cultivation between the rows has been finished (fig. 30). A wheel type of hoe is useful where the rows are narrow and straight. Hand hoes with the blade cut down to a 2-inch width are helpful in close work. These may be supplemented by small hand weeders (fig. 31).

IRRIGATION

In irrigating deciduous nurseries the frequency of irrigation and amount of water needed will be dependent on available rainfall, soil type, growth habits of the species concerned, stand density, and size of stock desired. Climatic factors such as temperature, wind velocity, and humidity are also important. For the most part, irrigation will be confined to a period of 1 to 2 months in midsummer. Without exception it should be tapered off in late summer and early fall to the

minimum quantity needed to keep the trees from actual drought injury.

In soils having a retentive subsoil, the amount of water lost by underdrainage is small, and the effects of a fairly heavy irrigation may persist for as long as 2 to 4 weeks before additional water is necessary. Care should be taken, especially in midsummer and with fairly large nursery stock, to add enough water in any one irrigation so that the soil is well moistened to a depth of 2 feet. Two or three inches of water, depending somewhat on the relative dryness of the soil just previous to irrigation, may safely be applied on a medium-textured soil with a retentive subsoil. Watering should then be dispensed with until the trees show signs of needing more water. This procedure will force maximum root development and prevent the formation of a top-heavy plant.

In sandy soils with a somewhat porous subsoil of fine sand, more frequent irrigation will be necessary and the quantity of water for one irrigation should be reduced to 1 to 2 inches. Amounts in excess of this will be lost through underdrainage.

The volume of water applied in any one irrigation will also depend somewhat on the time of year and the size of the trees. Smaller quantities will suffice and more frequent irrigations are needed on small trees that are just past the germination stage; at this time the seedlings have not developed the spread or depth of root system which they will attain by midsummer, nor is their water demand so great.

The method of distributing the water—whether by furrows or overhead system—will also influence the amount of water applied. Since furrow irrigation does not distribute the water as evenly as an overhead system, more water must necessarily be applied by the former method. If the trees at the far end of a furrow are to be watered adequately, the water used invariably soaks up the end of the tree row nearest the lateral ditch more than is absolutely necessary, and some wastage thus occurs because of underdrainage.

With ditch irrigation, fairly close control can be maintained over the amount of water to be applied by varying the head or volume going down the individual furrows. If a small quantity is desired, a large head should be used for a short time, since the water will then proceed rapidly down the furrows, thus limiting the time permitted for infiltration. If a thorough irrigation is desired, a small head of water should be run down the furrows over a considerably longer period.

HARDENING OFF

Hardening off the seedlings is a process largely controlled by weather conditions. A long cool fall season with an average amount of rainfall and number of frosts, the latter gradually increasing in intensity, represents the natural and therefore the ideal method of hardening off the seedling crop. Since he cannot depend upon such conditions, the nurseryman should strive to have his seedlings in condition to withstand the other extreme of abnormal rainfall and warm weather, followed by a sudden, killing frost. In the plains region such fall weather conditions are not uncommon.

When fall rains are not too heavy, moisture control, in the form of holding off all irrigation and ceasing cultivation, is the common,



F342796

FIGURE 30.—Hand tools useful in weeding and cultivating after the power cultivator has done its work.

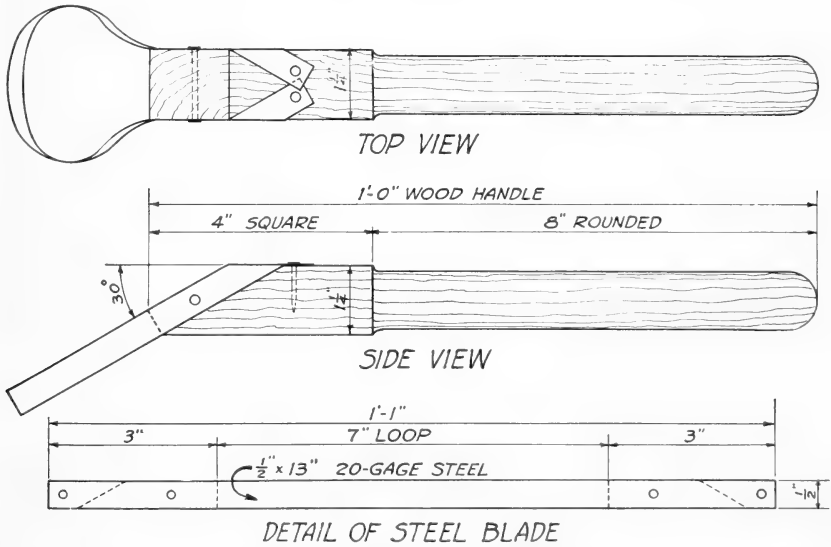

FIGURE 31.—Detail of a hand weeder.

natural method of hardening off nursery stock. All cultivation and irrigation should generally be tapered off after midsummer and usually should cease entirely from a month to 6 weeks in advance of the average killing frost, the time depending somewhat on the water-retaining capacity of the soil and on the size of the stock. A gradual depletion of the soil moisture will bring about the hardening of the seedling tissues and cause cessation of growth. When growth has ceased and tissues have hardened seedlings can withstand fairly severe frosts without having the tops killed back.

Such natural ripening processes are much to be preferred, but when they are rendered impossible by heavy fall rains, the only recourse is to such wholly artificial methods as spraying the seedlings with a copper sulfate solution to bring about defoliation, or digging and burying the seedlings in pits for several weeks to sweat off the leaves. Another method is to undercut or root-prune the seedlings with the ordinary U-blade digger with the lifter removed. Artificial ripening should be used, however, only as an emergency measure, when natural ripening has been delayed beyond the safety point because of abnormal weather conditions.

Spraying with copper sulfate solution causes a drying up of the leaves at a rate in proportion to the concentration of the solution. Parker (28) states that a solution containing 1 pound of copper sulfate to 50 gallons of water affects the leaves like a light frost, 2 pounds per 50 gallons like a heavy frost, and 3 pounds will cause ripening of the foliage within a week. This method of hardening stock has been used to some extent in commercial nurseries.

In the frequently used practice of digging the seedlings while in full leaf and burying them loosely in pits under several feet of soil, the seedlings are left for 2 to 3 weeks until the leaves loosen and can be detached easily by shaking or stripping. This method, while apparently safe, involves considerable extra handling and requires care that the seedlings are not left buried too long, to avoid heating or molding of the stock.

Undercutting the seedlings to a depth of approximately 12 inches while in full leaf reduces the moisture-absorbing capacity of the root system and brings about a wilting and gradual drying of the foliage. Undercutting has been used by some commercial nurseries with considerable success, and in recent years by some Lake States nurseries in hardening-off jack pine.

TOP PRUNING TO INCREASE SURVIVAL

Top pruning has not proved to be of any marked benefit in increasing field survival of deciduous stock which is reasonably well balanced but has in some instances increased survival of seedlings weakened by improper handling or having poor root systems, and, so far as known at this time, can be recommended for such stock. It has been observed that top pruning tends to induce lower branching and more compact growth during the first few years after planting, which is in many respects desirable, especially for the shrub species. It may result in certain tree species having a somewhat distorted form, but for windbreak planting the form of the tree is not regarded as being of primary importance. As a practical nursery measure it is desirable, since it reduces the bulk and thereby the cost of handling and planting the seedlings.

Length of top has been shown to be relatively unimportant from a survival standpoint. If trees and shrubs are top pruned, the length of top should be sufficient to permit the seedling to be easily visible after planting, in order to facilitate the cultivation job. It has been found that a top length ranging from 10 to 20 inches is adequate. Shrub species are cut back to 10 to 14 inches and tree species to approximately 18 inches.

Pruning back the stock while it is still in the nursery row is preferable to performing the operation after the seedlings have been tied in bundles. The advantages of this method of pruning are threefold: Reduction of bulk to be handled later; much greater facility in field grading; material aid in tying the bundles uniformly with the root collars on the same general level.

Good results in top pruning have been obtained by using a commercial power mower so modified that the sickle bar would run in a horizontal position at any height from 10 to 20 inches. Ordinary grain binders can also perform the top pruning operation very effectively and have an advantage over the mowing machine in that the tops can be bundled and tied to facilitate their removal from the field. Cost of top pruning is practically negligible with these machines. Hedge pruners have also been used with equally good results, but costs are higher with this hand method.

The top-pruning operation should not take place until after the seedlings have naturally defoliated, or at least until after several frosts have occurred and the leaves can be readily removed by shaking the plants. Translocation of food from the leaves into the stem and roots takes place as long as the leaves remain securely attached to the plant and their premature removal would rob the tree roots of some stored food.

SPECIAL METHODS OF GROWING PLANTING STOCK

The nursery methods detailed on the preceding pages, involving propagation from seed, without shade, in rows from 18 to 40 inches apart, will serve for most species grown for plains planting. There are a few species, however, which require shade, and some which are normally propagated from cuttings. A few species like cottonwood need not necessarily be grown in the nursery but can be collected from sandbars along streams.

PROPAGATION IN BEDS

A few deciduous species grown for plains planting are so delicate in early life that they are best grown in beds where they can be given intensive care and can readily be protected from sun and wind. Sycamore is probably the outstanding species in this group. A number of other species, notably lilac and serviceberry, make very slow growth the first year, and because of their small size require rather careful handling during the entire first season. These are frequently grown in beds the first year and then transplanted into the open field the following spring.

Beds may be of any convenient length, but a width of 4 feet is recommended as facilitating shading and weeding. Drilled rows or narrow bands spaced 6 inches apart and running lengthwise of the bed are preferred. Broadcast sowing is an alternative method.

Lifting of the stock can be done either by hand or with the type of tree lifter which removes an entire bed at one time. This lifter is generally pulled by means of a cable which is wound up on a drum attached to a tractor set at the end of the bed.

Various methods of shading beds are available. A satisfactory method is to place the slats at a height of 12 to 18 inches above the beds, on two lengths of No. 9 galvanized wire. The wires, on each side of the bed, are about 40 inches apart, held up by intermediate stakes and crosspieces or light wooden horses straddling the bed 12 feet apart, and are tightened by turnbuckles. Snow fence is generally preferred



F342194

FIGURE 32.—Snow fence stretched on longitudinal wires supported at 12-foot intervals by crosspieces joining stout stakes. The fence is shading small lilac seedlings grown in beds at Fremont, Nebr.

to lath frames for shading (fig. 32). If a large quantity is needed it may pay the nurseryman to make it up at the nursery instead of purchasing it.

Some form of sprinkling system must be resorted to for irrigation of stock grown in 4-foot-wide beds, since furrow irrigation is usually not practical. If water is available under pressure and less than an acre is in beds, garden hose and lawn sprinklers will be sufficient. For larger areas recourse must be had to stationary or movable overhead sprinklers.

TRANSPLANTING

Species grown in seedbeds are always transplanted after one season to allow more room for growth and to produce a better root system. The seedlings are lifted in the spring, and after being sorted to discard the usual 10 or 15 percent of culls, the plants are root-pruned to a length of 6 inches and taken to transplant shelters. These shelters are light, portable frames covered with canvas or burlap, and are kept within 30 to 60 feet of the transplant trenches to reduce waste motion. Under the shelters the seedlings are threaded into a wood or aluminum transplant board 8 feet long and holding 48 trees spaced 2 inches apart.

Since small deciduous seedlings with little top are likely to slip out, each inner face of the transplant board is lined with a thin strip of sponge rubber one-half inch wide and one-eighth to three-sixteenths inch thick, to provide a firmer hold on the stems of the seedlings. Details on construction of transplant boards have been given by Olsen (27). The threaded transplant boards are placed in the trench to the proper depth and the trench is filled by dragging in loose soil and caving in the side walls.

In some nurseries the transplant trench is hand-made with trencher of a commercial type, consisting of two sheets of steel from 24 to 30

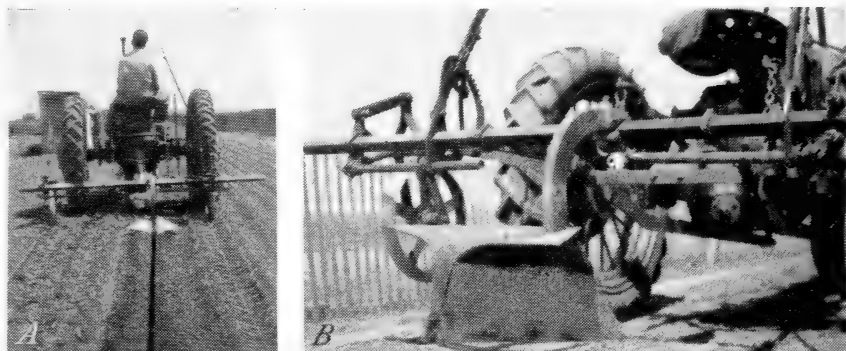

F365793-36579

FIGURE 33.—Trencher used in nursery transplanting in operation. Trencher blade is constructed of 2 pieces of $\frac{3}{16}$ -inch plow steel welded together in front and attached to tool bar of tractor by means of curved cultivator shank. Dimensions of one side of blade are as follows: Bottom length, 30 inches, top length, 20 inches, depth below flare, 10 inches, reinforcement bar at bottom is $\frac{3}{8}$ by 3 inches. Trench is 1 inch wide at bottom and 2 inches wide at top. A series of small knobs may be welded along the rear edge of the trencher blade, if the trencher has too great a smoothing effect. A, Trencher in action; B, close-up of trenching tool.

inches long and 10 to 12 inches high, welded together to form a long wedge-shaped tool. A sturdy handle of galvanized iron pipe is attached, and, in use, the instrument is jabbed into the ground by stepping on it. On withdrawal, a wedge-shaped trench is left about 10 inches deep and 1.5 to 2 inches wide at the top. The trencher is operated by one man, and where the soil is quite sandy, good production is attained.

In heavy soils, the hand trencher is not favored because of low efficiency, and because it leaves smooth, shiny side walls which may open up in very dry weather or through frost action. In the heavier soils the tractor-drawn trencher of the type shown in figure 33 is preferred because of higher production, and because of the fact that the wider trench leaves room to pack in loose soil between the tree roots and the opposite side wall. By doing this, the cracking open of the trench by drying or frost action is largely avoided.

Spacing between rows is either 21 or 27 inches in nurseries where furrow irrigation is used. In nurseries equipped with an overhead irrigation system, however, and where a Smith tree lifter is available, a row spacing as close as 10 to 14 inches has been sufficient.

With the machine method of trenching and in the average nursery soil found in the prairie-plains, a crew consisting of 2 threaders and 1 planter can transplant from 12,000 to 24,000 trees per 8-hour day. This is the equivalent of 500 to 1,000 trees per man-hour.

A comparatively new development is a four-row unit consisting of four parallel trenchers mounted on the tool bar of a Uni-carrier pulled by a tractor. This device assures absolutely uniform row spacing and permits multiple-row cultivation, which cannot be done readily when rows are lined out with a single row trencher.

Transplanting is also used as a method of saving medium-sized trees which are not cull stock. Sometimes adverse growing conditions will prevent a block of seedlings from attaining normal size by the end of the first year. In case of stock shortage, it is often necessary to take the best 20 or 30 percent of such a block for use in field planting and to grade out the remainder into liners, or medium-sized trees for transplanting, and culls.

Even though careful grading is practiced to avoid including the inherently weak plants, planting stock produced from liners is generally regarded as being less desirable than seedlings which have attained usable size during their planned nursery cycle, and is only justified as being less expensive than a new crop of seedlings. The nurseryman determines the selection of species to be lined out by one or more of the following guides: (1) If seed is unusually expensive, as that of bur oak, or if no seed is available owing to crop failure; (2) if the species is difficult to bring through the germination period, as mulberry or Russian-olive; (3) if growth rate of the species is so slow as to require that seedling stock remain in the nursery 2 years to attain usable size. Lilac and honeysuckle are outstanding examples of this class. Transplanting lilac liners, which can be expected to attain usable size in one additional season will save a year's time. A notable exception to the last group is green ash, which is so easily propagated from seed that the saving of liners is not generally feasible.

In the nurseries located in the Dakotas the growing season is so short that American plum is one of the few species grown from seed that will consistently produce a high percent of plantable seedlings in 1 year. In these nurseries the practice of growing 2-year-old stock is being adopted for almost all species. Green ash, hackberry, Siberian pea-tree, American elm, bur oak, and chokecherry are planned for 2-0 production. Lilac and honeysuckle are invariably grown for 1-1 stock. With Russian-olive, Chinese elm, boxelder, and cottonwood there is a choice of growing the stock either as 2-0 or 1-1 age classes. There is an indication that with use of the four-row trencher and refinements in transplanting technique there will be some trend toward growing some of these species in fairly dense beds for the first year to a height of 6 to 10 inches and lining them out the second year for 1-1 production.

PROPAGATION BY CUTTINGS

Some deciduous stock, such as poplars, willow, and certain strains of tamarix, has been grown from cuttings (fig. 34). This method of propagation is ordinarily limited to those species which root readily from cuttings and are difficult to propagate by seed. For most species, planting stock propagated from seed is generally considered less expensive and the quality superior to that grown from cuttings.

Out of a number of possible methods, hardwood (dormant wood) cuttings and root cuttings are most commonly used for propagation outdoors. Neither requires bottom heat, shading, or the great care which is essential for softwood (summer wood) cuttings.

Recent discoveries in propagation have demonstrated that material benefit may be obtained from the use of so-called growth hormones, which have the effect of promoting root development, thus assuring a higher percentage of rooted plants and better stock. The most satisfactory rooting stimulants found to date are indoleacetic acid and indolebutyric acid. They react differently on the various species, but either if used in excess may cause damage to the cuttings. The general method in practical use is to obtain cuttings in early spring and



F365518

FIGURE 34.—Tamarix propagated in the nursery from cuttings.

to soak the lower end for 1 or 2 days in a solution consisting of 5 to 20 mg. of the growth hormone dissolved in 1 liter of water. For some species, concentrations as high as 50 mg. to 1 liter have been used, but it is generally safer to use a lower concentration and to extend the time of treatment.

Hardwood cuttings are best taken in the fall or winter, preferably from 1- and sometimes 2-year wood; 8 to 10 inches is a satisfactory length. Tied into bundles of convenient size, the tops are dipped for about an inch or so in a solution of whitewash as a convenient means of ready identification, and the bundles are then placed in moist sand storage at a temperature of 35° to 50° until planted, or buried in outdoor pits below the frost line, preferably in well-drained sandy soils.

Cuttings taken in the spring have not always proved satisfactory since they have a tendency to leaf out in advance of rooting and consequently to exhaust their vitality and succumb before the roots have become established. No doubt, hormone treatment of such cuttings will aid in obtaining a higher percent of successful rooting. It remains to be determined experimentally whether such treatment is justified, however, in view of the fact that cuttings of tamarix, willow, and poplar, taken in fall or early winter and stored in damp sandy soil, have rooted quite successfully in the spring.

Hardwood cuttings can be planted in either fall or spring. If fall planted, they should be ridged over with soil as is done with the seed rows. Spring planting, however, has given better results and is preferred by most nurserymen. Spring-planted cuttings can also be ridged over if leafing out is not immediately expected, but the ridges should be removed as soon as the buds start unfolding. The Forest Service nurseries have followed the practice of planting the cuttings about an inch apart in drill rows in soil that has been loosened by trenching or subsoiling. Thorough firming of the soil around the cuttings and immediate irrigation if the soil is dry, are necessary steps to assure success. Cuttings should be planted to a depth that will leave one bud or approximately 1 inch of top exposed above the ground level.

Root cuttings are often used in the propagation of lilac. Cuttings 2 to 3 inches long are made during the fall and early winter from the larger roots of older plants. Root diameters of one-fourth to one-half inch have proved satisfactory. These cuttings are held in moist sand over winter in outdoor pits and planted early in the spring. They may also be fall planted. Planting is accomplished by opening a furrow to a depth of 2 inches, laying the cuttings horizontally in this furrow, and covering them with a ridge of soil, the same as is done with seed rows. Lilac can also be propagated by summer cuttings as described by Yerkes (41) to obtain specially desirable types, but the considerably lower cost of propagation from seed apparently will preclude any wide-scale use of summer cuttings.

WILDINGS AND ROOT SUCKERS

Wildings are used in lieu of nursery-grown stock for several of the species planted in the prairie plains. Cottonwood, lilac, tamarix, and currant can be used fairly successfully as wildings. Of these, cottonwood gives best field survivals.

Cottonwood wildings are occasionally scarce and those available are quite likely to require heavy culling because of borer infestation, injury from stock grazing, or other factors. As a measure of safety, therefore, the Forest Service nurseries are adopting the practice of growing at least a portion of their cottonwood requirements from seed. Nursery-grown cottonwoods are generally cleaner and thriftier plants than those collected as wildings. Transplanting has been found to assure a higher survival of small cottonwood wildings. If transplanted to the nursery for a year, these wildings develop a better root system and become more drought hardy.

Lilac and currant might properly be classed as root suckers rather than wildings since they are obtained by separating the root suckers from around the edges of older bushes. Figure 35 illustrates the better type of lilac root suckers. This species, however, gives better field survival if grown from seed for 2 years in the nursery.

Cottonwood and tamarix are usually obtained from river sand bars and flats along the borders of lakes. These species seed naturally in late spring and by fall have usually reached a usable size, although in some instances, particularly in the northern States, 2 years may be necessary. They are ordinarily dug in the fall, and subsequently handled the same as nursery stock. When the ground is wet, the



F342208

FIGURE 35.—Lilac root suckers obtained from edges of old lilac bushes.

1-year wildings may be pulled readily without the aid of tools, but 2-year wildings will often require the use of a spade or shovel to loosen the roots. In some instances U- or L-shaped nursery digger blades have been used successfully for this purpose.

A device known as a wheel puller (fig. 36) has been found to be of material aid in collecting wildings. This consists of a small-size tire rim of old-model cars to which is attached a pick handle by means of a $\frac{3}{4}$ -inch steel U-bolt. One end of the U-bolt is welded to the inner face of the rim and the other end, to which the handle is swiveled, projects over the outer face of the rim. In use, the wilding is clamped between the lower end of the handle and face of the rim and lifted by the rolling action of the wheel when pressure is applied to the upper end of the handle.

SUMMARY OF NURSERY OPERATIONS

Information of value to the nurseryman regarding the season to sow, sowing technique, germination rate, and growth rate after germination, for the various shrub and tree species suitable for planting in the prairie-plains region, is given in table 22, together with additional comment on the germination and growth habits peculiar to the several species. Particulars regarding the effects of rodents, insects, and disease, not included in table 22, are given subsequently in the discussion of seedling protection.



F354487

FIGURE 36.—Pulling cottonwood wildlings with specially devised wheel puller.

TABLE 22.—Summary table for nursery practice by species

Species	Season of sowing	Average germination in seed tests	Usual nursery sowing ratio ¹	Depth of sowing	Germination rate in intervals ² (percent)	Relative growth rate in nursery ³	Remarks ⁴
Medium-to-tall deciduous trees:							
Ailanthus	Spring	Percent 30-50	4	Inches 0.5	50-73-75-75	Fast	Vigorous, succulent grower.
Asb, green, or prairie	Spring, fall	40-70	3	.5	25-56-58-58	Slow	Normally early ripener in fall. Will go dormant very early if growing conditions unfavorable.
Boxelder	do	30-50	3	.5	3-17-20-23-X-45	Fast	Easy to propagate.
Catalpa, northern	Spring	40-70	3	.5	15-37-43-46-X-52	do	Sow after soil has warmed up. Especially subject to injury from early fall frosts. Vigorous grower in thin stands.
Coffeetree, Kentucky	do	70-90	2	1.0	35-75-80-X-X-81	Slow	Seedlings are very stocky and taprooted. Strong tendency to become dormant early if conditions unfavorable.
Cottonwood	do	40-60	10	0	(¹)	Fast	Sow on wet surface and keep moist about 4 or 5 days until seedlings established. Culture fairly simple thereafter.
Elm, American	Spring, summer	60-90	8	.25	40-82 ⁶	Slow	Heavy taproot. Soil has warmed up.
Elm, Chinese	Spring	40-70	8	.25	(¹)	do	Delay sowing until soil has warmed up.
Elm, Siberian	do	60-90	5	.25	(¹)	Fast	Mixing soil with moist sand 2 days before sowing is advisable. Many prefer digging in spring to avoid root-rot loss.
Hackberry	Fall, spring	35-65	3	.5	8-41-52-57	Slow	Heel-in in sand best for winter storage.
Honeylocust, and thornless	Spring	70-95	2	.75	43-51-72-X-X-80	Medium	Protection from wind in nursery increases growth and development.
Locust, black	Spring, summer	70-90	4	.25	66-75-70-77	Fast	This species is an easy grower if not crowded and if favorable moisture conditions are maintained.
Mulberry, red, or Russian	Spring	40-85	8	.25	57-79-80-81	do	Less from damping-off common. Can cut back tops to near ground line in midsummer to retard growth.
Oak, bur	Fall, spring	40-60	2	1.5	X-10-20-35-49-54	Slow	Sow mixed with fine sand or sawdust. After germination a persistent late grower, often injured by frost. Begin hardening-off in late summer.
Osage-orange	Spring	50-80	4	.5	40-55-63	do	Usually direct-seeded on planting site. Can be stratified over winter in near-freezing temperature. Root pruning in midsummer of first year followed by irrigation shows promise.
Pecan	Spring, fall	40-60	2	1.5	11-25-42-47-49	do	Slow to ripen; subject to early frost injury. Frequently direct-seeded on planting site. Heavily tap rooted and difficult to transplant. Nursery stock should grow 2 years with root pruning first season.
Persimmon, common	Spring	50-80	3	.75	(¹)	Medium	Heavy taproot.
Soapberry, western	do	40-80	3	.75	0-13-42-46-X-54	Slow	Strongly taprooted in nursery; relatively meager top growth.
Sycamore	do	20-50	10	.25	31-35-35 ⁶	Medium	Keep shaded first month. Easily grown thereafter.

Walnut, black	Fall, spring	40-60	2	2.0	(10)	do	Usually direct-seeded on planting site. Taprooted. Stock improved by root pruning in midsummer.
Walnut, Texas	do	40-60	2	2.0	(11)	do	Do.
Apricot	Spring, fall	50-90	2	1.5	59-72	Fast	Germinates early and subject to frosts. Hold back by high ridges.
Bladder-scenna, common	Spring	50-90	3	.5	(12)	do	Easy to grow.
Buckthorn, Siberian	Fall, spring	13 10	4	.5	14	Slow	In spring, must sow early to prevent pregermination.
Budaberry	do	50-70	8	.25	28-51-51-51	do	Not sown extensively as yet; grows readily from cuttings.
Chaste-tree, lilac	Spring	20-40	6	.25	0-25-34	Medium	Not necessary to deltap if sown as soon as seed ripens.
Chokecherry, common or western.	Spring, fall	30-70	4	.5	53-64-65	do	Germination early and subject to frost. Hold back long by high ridges.
Crab, Siberian	Spring	13 50-80	7	.25	(13)	Slow	Dedicate in early life.
Currant, slender golden	Spring, fall	40 60	7	.25	(9)	do	Propagates readily from cuttings.
Desertwillow	Spring	20-50	7	.25	20-25-28-33-X-37	Fast	Delay sowing until soil warms up. Readily propagated by hardwood cuttings.
Elder, American	do	50-70	7	.25	(14)	do	Propagates readily from cuttings.
Hawthorn	do	50-70	4	.5	(16)	Slow	Seed difficult to germinate satisfactorily.
Honeysuckle, Tatarian	do	40 80	7	.25	0 35 55 62 X 63	Medium	Fairly heavy sowing followed by thinning justified for this species. Easily propagated by hardwood cuttings.
Jujube	Fall, spring	35-50	3	1.0	20-25-28-33-X-37	Fast	Safest to grow in beds first year and then transplant. Root cuttings require only 1 year in nursery.
Lilac, common	Spring	30-60	8	.25	0 22 43 47-X-47	Slow	Easily grown after trees are past the germination stage.
Maple, Tatarian	Fall, spring	13 20	1	.5	(16)	do	Stratify 1 year before sowing in beds and mulch with straw.
Nannyberry	Fall	40 60	4	.5	10-35-50	do	Transplant end of first year.
Pea-tree, Siberian	Spring, summer	50-90	3	.5	1-08-74-76-X-78	do	Late summer sowing produces 2-3 inches growth before freeze-up. After delimitating, ridge over to avoid winter injury. In spring mow just above ground line to produce well-branched stock. Must be sprayed.
Plum, Chickasaw, sand, or American.	Spring, fall	40-70	3	1.0	(9)	Fast	Easy, vigorous growers.
Redbud, eastern	Spring	70-90	4	.5	63-73-73	Medium	Easily grown once stand is established.
Russian-olive	Fall, spring	50-80	4	.75	10-50-61-63-X-73	do	Erratic in germination. Young trees subject to heavy losses from soil adhering to leaves. Delimitates late in fall.
Serviceberry	Spring, fall	13 20-30	8	.25	(9)	Slow	Some leave trees in ground for spring digging.
Skunk bush	Fall, spring	20-40	6	.25	0-11-25-27-28	Medium	Best to grow in beds under half shade the first year, then transplant.

1 Ratio between viable seed sown and usable seedlings produced.
 2 X indicates a decade in which no record was taken. Values are given in each case for successive decades.
 3 Species labeled "slow" ordinarily require 2 years in nursery in North and South Dakota, and, occasionally, farther south. Species labeled "fast" will reach usable size in one nursery season. Species labeled "medium" occasionally require 2 years, especially in northern States.
 4 See section entitled "Seedling Protection" for information on rodents, insects, and disease.
 5 Very rapid.
 6 As reported by Rafn, Copenhagen.

7 Slower than American elm.
 8 More rapid than American elm.
 9 Fairly rapid.
 10 Slightly slower than pecan.
 11 Similar to black walnut.
 12 Similar to black locust if acid treated.
 13 Estimate only.
 14 Medium.
 15 No data.
 16 Slow.

NURSERY INVENTORY

In order that nursery and field planting activities can be properly coordinated, an inventory must be made to determine the probable nursery production in various blocks and species of stock.

To determine the approximate percent of count necessary in deciduous nurseries, and also the length of counting plots, a 100-percent count was made of all the seedlings in 9 rows, each 600 to 700 feet long, and the number recorded foot by foot. The number of seedlings per lineal foot of row ranged from 0 to 40 but fell mostly between 4 and 12 per foot. By means of a statistical analysis of the data, made by R. H. Blythe, Jr., of the Lake States Forest Experiment Station, a 1-foot-long counting plot was found to be satisfactory; and for an average block of 5 to 10 acres to the species, a total of 250 to 300 1-foot plots well distributed over the block invariably insured an accuracy of ± 10 percent. From 900 to 1,000 plots were required for an accuracy of ± 5 percent. In other words, on a 10-acre block with a space of about 2 feet between rows, a 1-foot counting plot taken mechanically every 200 feet in all rows would usually give the desired inventory within ± 5 percent. This amounts approximately to a 0.5-percent count. If a number of species are involved, a separate count should be made for each species.

Where blocks of stock are comparatively small, or where there is a considerable lack of uniformity of stand, best results have been obtained by taking mechanically a 1-foot counting plot every 100 feet. This is the equivalent of a 1.0-percent count. It is very important that the counting plots do not appear on lines across the direction of the rows but that they have a dispersed pattern. This can easily be assured by using a steel tape or rope of 100-foot length to locate the counting plot and by using a cumulative total of counting plots obtained by going down one row and doubling back on the next row.

If the seedlings have a density ranging from 0 to 12 per lineal foot, the accuracy is considerably higher with the same percent of count. Analysis of data taken where this range of density occurs indicated that a count of 250 plots selected at random gave accuracy within ± 5 percent and that 100 to 150 plots gave an accuracy within ± 10 percent.

Care should be taken in laying out the 1-foot counting plot so that only the seedlings within the 1-foot distance are counted. For this purpose a foot rule is used or a counting frame is made. The latter consists of a wooden or metal bar with two 6-inch-long tapered spikes or rigid thin metal rods fastened to it parallel to each other, 1 foot apart, and at right angles to the longer bar. This frame is pushed up against the seedling row so that the spikes or rods project through to the other side, thus sharply delineating the ends of the 1-foot-long counting plot.

If counting plots are selected at random, bias should not enter into the location of the plot, and it should be a strictly random sample. The practice of some commercial nurserymen in making the counts on zig-zag lines roughly representing two diagonals drawn through the nursery block of a given species is fairly satisfactory, but generally will not give so high a degree of accuracy as the mechanical sample taken at 100- to 200-foot intervals.

LIFTING AND FIELD GRADING

The operation of lifting and field grading requires careful planning and good crew organization if it is to be accomplished with maximum efficiency.

If the soil is quite dry, it is considered good practice to irrigate the trees from 1 to 3 days in advance to put the soil in best condition for digging and to prevent the stripping of roots that is unavoidable in hard, cloddy soil. Such irrigation is especially necessary on heavy soils; sandy soil is generally reasonably friable and will not break up into large clods even when dry.

LIFTING PRACTICE AND EQUIPMENT

Dormant deciduous seedlings may be dug with safety at any time during the fall or spring. In the southern part of the plains, lifting can also be done in the winter. If lifting is delayed until just before planting, the seedling is exposed to less danger than if it is dug earlier and held in storage during the winter months; but on the other hand, digging delayed until spring demands quick work, since deciduous seedlings do not long remain dormant after warm weather sets in. In practice, most deciduous nursery stock is dug during the fall months after the stock has become dormant and shed its leaves. In the northern plains States some stock may be left for spring digging, but in the more southerly States, where planting may be carried on throughout the fall and winter, fall or winter digging is practically mandatory.

Fall digging is preferable because it allows the seedlings to be graded, counted, and assembled ready for delivery as soon as conditions permit planting. In addition, it clears the land for the next crop, thus permitting ground preparation and fall sowing of certain species. Spring operations can get under way early in the season, resulting in a better distribution of the work load. Since the fall season is short, especially in the northern States, it is good practice to get digging operations under way as early as possible in order to complete the job before freezing weather occurs. Ordinarily, when the nursery is producing a variety of species, it will be possible to start digging soon after the first few frosts, taking first such species as green ash, catalpa, and honeylocust, which shed their leaves readily after having been frosted; following with those seedlings which are practically dormant after the early frosts but retain their leaves for another 10-day or 2-week period; and reserving to the last, species like Chinese elm, Russian-olive, chokecherry, and lilac, which retain their leaves tenaciously until late in the fall. Although not considered a desirable practice, the leaves may be hand-stripped or otherwise removed in order to complete digging before freezing weather stops all work. Removal of leaves can readily be accomplished with an ordinary garden rake the metal parts of which are wrapped with strips of cloth, rubber from inner tubes, or twine to prevent injury to the bark of the seedlings.

A number of the commercial diggers with U-shaped blades are quite satisfactory for undercutting seedlings. The most desirable is an 18-inch shrub digger on a wheel chassis. The wheel-chassis type has proved more satisfactory than the straight-beam type since the proper depth of undercutting can be more uniformly maintained.

A sharp blade with a lifter attachment is essential, although in loose soils the lifter may be removed. Tractor power has proved to be more satisfactory for pulling diggers than animal power. Generally an ample and more uniform pull is assured without the inconvenience and delay caused by frequent resting of the horses or mules. (Fig. 37.)

The digger should be set to run at a uniform depth of approximately 11 inches, since this root length has been found convenient and of

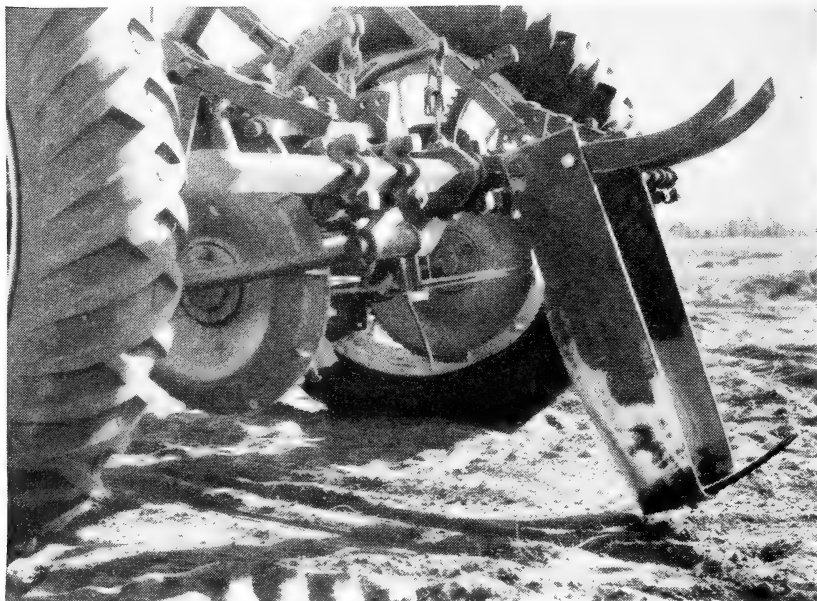

F356932

FIGURE 37.—U-blade tree digger mounted on tool bar of tractor. Depth of undercutting is gaged by adjustment of levers on tractor. Blade is raised or lowered by power lift. Blade is constructed of $\frac{5}{16}$ -inch 6-inch plow steel, reinforced at top where fastened to cultivator shank. Blade is 28 inches deep and inside width above bottom curvature is 10 inches. Rear bolt hole is 1 inch lower than front, thus giving blade necessary tilt.

adequate length for plains planting. If the lifter is set for a greater depth, additional pruning of the longer roots will be necessary. A clean sharp cut at time of digging will permit the cut ends of the root to heal up properly in the heel-in bed. Following the undercutting operations, the seedlings are pulled, long lateral roots are cut to convenient planting size, and the trees are graded, counted, and tied in bundles.

GRADING TECHNIQUE

Grading the stock in the field and selecting only the usable seedlings greatly simplifies and speeds up the entire operation and dispenses with double handling of the stock. The usual commercial practice in the plains region is to place the seedlings in a storage building immediately after pulling, and to perform all subsequent operations under cover when time is available, with a few specially trained men. Since commercial practice demands that the seedlings

be graded in a number of size classes, this procedure is the most feasible and economical. The Forest Service, however, has adopted a single usable grade, with consequent simplification of the commercial practice, making possible a field-grading technique which not only so reduces exposure time of seedlings as to preclude injury but also considerably reduces the cost of the operation.

Deciduous seedlings can be exposed to the air longer than conifers without being injured, and Alba H. Briggs of the Prairie States Forestry Project has found that most nursery seedlings exposed for 2 to 3 hours on the surface of a plowed field showed no drop-off in survival in field plantations. Wilding cottonwood and mulberry, however, were adversely affected by more than an hour's exposure. Present technique in Federal nurseries in the plains is such that seedlings are not exposed more than 5 to 15 minutes.

The general technique developed for field grading is outlined in the series of steps given below, one man performing one only of the steps involved. Although operation 2 is necessary only for a few species, it must in these cases be performed on the individual seedlings before they are bunched or bundled, if the laterals are to be removed effectively.

The five or six operations follow one another in logical sequence and, therefore, the system lends itself readily to efficient crew organization. Occasionally, when conditions permit, steps 1 and 3 can be performed to advantage by one man. When step 2 is omitted, a unit crew of nine men can work three rows at a time very efficiently, operations 1 and 3 being performed by three men each, one on each row, and operations 4, 5, and 6 being handled by one man each working all three rows. An average output of 3,000 usable seedlings per man per day can reasonably be expected of a large crew of 30 to 40 men if they are properly organized and supervised.

1. After being undercut, all the seedlings regardless of size are pulled, soil and leaves shaken free, and trees laid down crosswise on the row behind the puller as he progresses up the row (fig. 38).



F354481

FIGURE 38.—The first operation in field grading: Pulling undercut nursery seedlings.

2. Lateral roots exceeding 4 to 5 inches in length are cut back to this length by the second man, who follows behind the puller with hand shears or knife.

3. Grading and counting is performed in one operation by the grader, who selects the usable seedlings in bunches of 10 from those spread out before him. As each bunch of ten is deposited on the ground, he proceeds to select and count 10 seedlings for the next bunch. Usable seedlings are selected largely on the basis of caliper of stem and development of root system. Seedlings with badly stripped or broken root systems or split stems are rejected along with the undersized trees. It will be found that certain men can learn quickly to estimate with surprising accuracy the caliper of seedlings and in short order develop an appraising eye in selecting usable stock. More details on the basis for field grading of nursery stock will be given later.



F342198

FIGURE 39.—Methods of tying seedling bundles: Left, bundle tied twice with the single-wrap tie; right, bundle tied once with double-wrap tie.

4. Following the grader, an assembler groups the bunches of 10 seedlings into bundles of 50, the number that has proved to be the most satisfactory to handle for 1- or 2-year-old stock used in windbreak planting. Some care is necessary to keep the root collars even in each bundle. The bundles of 50 are then carried to the tier for tying. The assembler also groups the ungraded smaller trees into bundles and carries them to the tier. These are heeled in separately so that the better trees may later be selected for lining out.

5. The tier twists moisture-resistant tarred lath yarn twice around the bundle (double-wrap tie) or once around (single-wrap tie), preparatory to heeling in (fig. 39). He must vary his method to fit best the sizes and shapes of the bundles, and especially to avoid bruising the bark of the seedlings.

The double-wrap is preferred for a single tie, since it will withstand more handling than the single-wrap tie and is also less likely to bruise or girdle the bark of the seedling when drawn tight. For average seedling sizes of most species one good double-wrap tie per bundle near the root collar is sufficient to prevent the bundle from coming apart when handled. For larger bundles, two single-wrap ties, one near the root collar and one near the top of the bundle,

should be used. For species having a heavy root system, such as walnut, coffeetree, and soapberry, two ties, one below the point of heaviest root caliper and one near the top of the bundle, are helpful to prevent loosening. Two ties should be used as little as possible, however, since they cause very compact bundles, which do not keep as well in overwinter storage as bundles tied above the roots only; in the heel-in beds it is harder to get soil in contact with the center of tight bundles.

6. The seedlings are heeled in temporarily until transported to the place of storage. Because the seedlings are seldom if ever watered in the temporary heel-in beds, the soil should be firmly tramped around the roots and the entire bed should be mounded over with soil, leaving only a few inches of top exposed.

Some nurserymen will find it convenient to pick out the marginal grades also and heel these in separately from the premium grades. In case of stock shortage, the trees in the marginal grade may be shipped and planted in the more favorable sites where moisture conditions are better. Sometimes the marginal grades are transplanted in the nursery to get them up to larger size the second year.

PRACTICAL VALUE OF CALIPER IN GRADING DECIDUOUS SEEDLINGS

A relatively low top-root ratio has long been regarded as a very important criterion in selecting conifer planting stock. Top-root ratio, as used by nurserymen, indicates the "balance" of a seedling, the relation of the weight of the entire top including foliage to the weight of the root severed at the ground line, on either a green or an oven-dry basis. It should not be confused with stem-root ratio, the weight of stem without leaves divided by weight of roots, or with leaf-root ratio, the weight of the leaves divided by weight of roots.

To provide a comparison of these criteria of balance as employed on deciduous stock, table 23 presents top-root, leaf-root, and stem-root ratios for four species grown in a North Dakota nursery. It will be seen that there is a fair correlation between the criteria, and that for these species the values fall in ascending order by all six methods. The table would further indicate that as a practical field method, ratios expressed on a fresh-weight basis are satisfactory, since they correspond quite closely with the oven-dry values.

TABLE 23.—Comparison of several criteria of balance in hardwood nursery stock

Age class and species	Top-root ratio ¹		Leaf-root ratio ²		Stem-root ratio ³	
	Fresh weight	Oven-dry weight	Fresh weight	Oven-dry weight	Fresh weight	Oven-dry weight
3-0 bur oak	0.74	0.71	0.53	0.49	0.21	0.22
3-0 chokecherry	1.72	1.57	1.22	1.05	.50	.52
3-0 green ash	2.40	2.23	1.68	1.48	.72	.75
3-0 Russian-olive	4.55	4.32	2.47	2.48	2.04	1.83

¹ $\frac{\text{Weight of stem + leaves}}{\text{Weight of roots}}$

² $\frac{\text{Weight of leaves}}{\text{Weight of roots}}$

³ $\frac{\text{Weight of stem (without leaves)}}{\text{Weight of roots}}$

The best conifer planting stock usually has ratios of 1:1 up to 3:1. Stock with higher values than 3:1 does not usually survive so well in the field, although this figure will vary somewhat by species and depends on the total weight and caliper of the plant. Poorer survival in stock with a high top-root ratio is partially attributed to the relatively large transpiration area in proportion to the absorbing area of

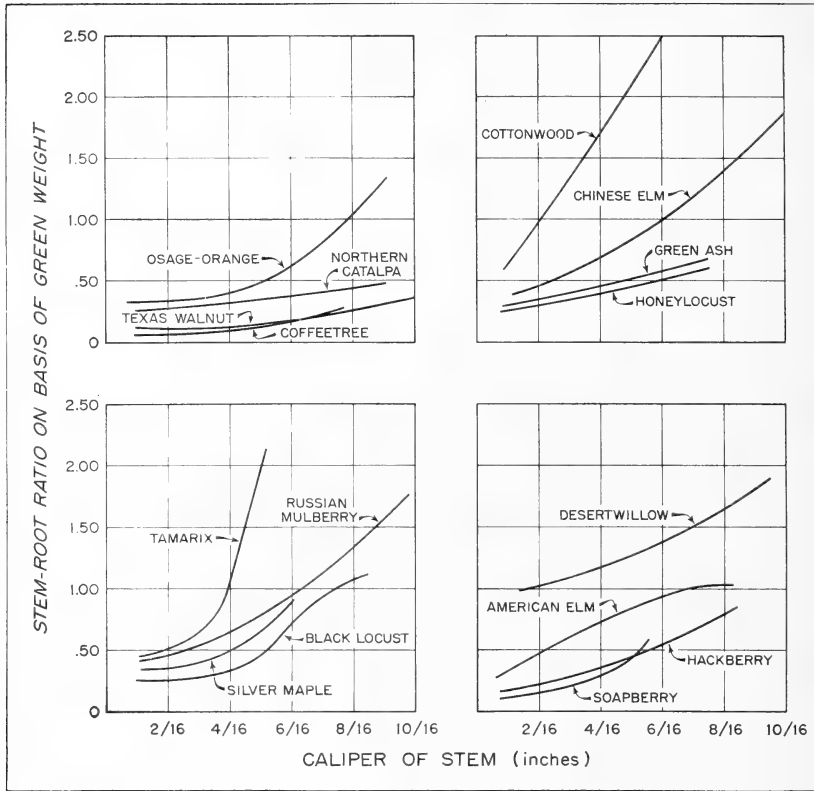

U.S.F.S.W.O.-1940

FIGURE 40.—Stem-root ratio of various caliper classes of 1-year-old nursery and wilding stock; the cottonwood and tamarix were wilding stock, and other species were nursery grown.

the roots and the consequent difficulty in supplying adequate moisture for the plant under stress.

Deciduous nursery seedlings usually have lower values than conifer stock. In figure 40, giving measurements of 14 species of deciduous trees, and 2 shrubs, it will be noted that almost all of the stock had a ratio of less than 1:1. The smallest with the best stem-root ratio had the poorest survival, while the largest trees with a ratio slightly poorer than average had the best survival. From this evidence, it was concluded that stem-root ratio was of little use in gaging the quality

of deciduous field-planting stock, and that caliper and total weight of the seedlings were much more important.¹⁶

Because caliper of stem is considered the best and most practical basis of grading deciduous nursery stock, the nurseryman should instruct and train his field graders as to the caliper specifications for each species. In case only one plantable grade (includes premium and marginal sizes) is considered for field planting, the process is

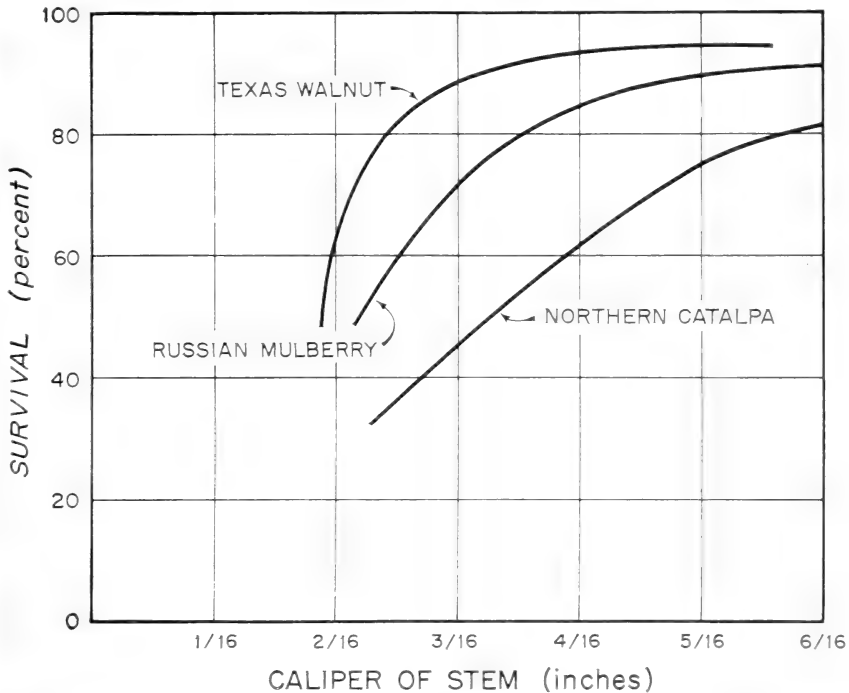

FIGURE 41.—First-year field survival in a drought year of various caliper classes of stock within the same height class. The walnut and catalpa are in the 8- to 12-inch class, the mulberry in the 18- to 24-inch.

very simple, and the men can easily learn to estimate caliper, especially in the smaller size classes, to the nearest sixteenth or thirty-second of an inch.

Some nurserymen have used height of top as a basis for grading nursery stock. While this is a fairly good basis, it is not as foolproof as caliper of stem. This is indicated by the curves in figure 41, which show that survival percent in a given height class varies considerably over a range of calipers.

In summary, it might be said that stocky, sturdy seedlings of good caliper are much preferred to tall, spindling stock of poor caliper.

At what point on the stem seedlings should be calipered is a moot question. At 1 or 2 inches above the ground line or root collar, it is

¹⁶ It is conceivable that heavy watering or fertilizing of the stock in dense stands might produce seedlings of adequate caliper, but having a very poor root system and stem-root ratios as high as 3:1 or 4:1. Such stock would probably have poor field survival. However, if the nursery practices recommended in this publication are followed as regards stand density and proper use of water, it is almost impossible to get seedlings that are seriously defective because of poor balance.

possible to inventory standing trees in the nursery in late summer and determine roughly the probable amount of usable stock which the nursery will produce. Some nurserymen for various reasons use the root collar or thickened portion of the plant just below the juncture of stem and root as a point of calipering. One advantage of this method is that some species, especially shrubs, which do not develop a definite central stem, if calipered above the ground line would be classed as culls in spite of satisfactory total weight and root development. Table 24 gives the caliper relationship of measurements at the root collar, and at points one-half, 1, and 2 inches above it for 2 different sizes of trees for 10 common deciduous species. It will be noted that there is a more rapid taper in such species as walnut, catalpa, and coffeetree than for honeylocust or Osageorange. The amount of taper may be influenced somewhat by soil and by density of seedlings in the row but seems to be correlated much more closely with the species. Caliper relationship of other sizes of trees can be obtained by plotting caliper 2 inches above the root collar as the abscissa on coordinate paper and the higher caliper values on the ordinate. The 2 plotted points for any one species can be connected and projected, and other values can be read from the straight line drawn through the 2 points. Thus a black walnut seedling calipering $\frac{5}{32}$ inch at 2 inches will measure $\frac{9}{32}$ inch at the root collar.

The point where stock is measured may seem unimportant, but it must be kept in mind that one-sixteenth inch difference in caliper specifications may represent as many as 20 percent of the seedlings, especially in the slower-growing species.

TABLE 24.—*Relation of caliper at 2 inches above root collar (in thirty-seconds of an inch) to calipers at other points on the stem of 1-year-old nursery seedlings*

Species	When caliper at 2 inches above root collar is 4.0			When caliper at 2 inches above root collar is 6.0		
	1 inch above root collar	$\frac{1}{2}$ inch above root collar	Root collar	1 inch above root collar	$\frac{1}{2}$ inch above root collar	Root collar
Black walnut.....	5.0	6.2	7.8	7.3	8.7	10.5
Northern catalpa.....	5.1	6.2	7.8	7.3	8.8	10.5
Coffeetree.....	4.5	5.0	6.5	6.5	7.6	9.4
American elm.....	4.8	5.7	7.0	6.9	8.0	9.4
Black locust.....	4.6	5.5	6.7	6.7	7.7	9.1
Green ash.....	4.8	5.8	6.4	7.0	8.1	8.9
Chinese elm.....	4.7	5.6	6.4	6.7	7.6	8.7
Russian mulberry.....	4.4	4.8	6.3	6.6	7.2	8.5
Honeylocust.....	4.7	5.0	5.6	6.8	7.3	8.3
Osage-orange.....	4.4	5.0	5.8	6.5	7.0	8.0

GRADING STANDARDS FOR VARIOUS SPECIES

The only logical criterion for grading nursery stock is field survival of various sizes of stock over a period of years. In order to set up a grading standard, the Forest Service conducted a rather comprehensive experiment near Mangum, Okla., in 1936, in which over 20,000 1-year-old seedlings involving 14 different species were carefully graded into various sizes and then field planted (36). For most species there were 10 or more lots of 100 trees each. Survival counts were made at the end of the first year and data were obtained on the height growth and vigor of the surviving seedlings.

Every individual seedling was measured for height (from ground line to tip of stem) and caliper and put into a specific grade. Caliper was obtained in sixteenths of an inch at a point 2 inches above the ground line, in order to make these measurements comparable with those already presented regarding the effect of density of stand (number of trees per lineal foot of row) on the size of stock produced, which were also taken at 2 inches from the ground. Weights were also measured on 25 to 70 representative seedlings of each species to obtain data on the relation of caliper to weight, the stem-root ratios, and the effect of top pruning on balance, and weight-caliper curves were drawn. Height-caliper curves were drawn based on 100 to 300 measurements for each species. Both sets of curves are shown in figure 42. The indication is that seedlings vary in form and taper according to species, some being short and stubby, others long and slender.

The results of the first-year field survivals for representative species are shown in figures 43 and 44. A few irregularities in survival are attributable to differences in soil and the cultivation given after planting. An examination of the bar charts brings out a definite relation of size of planting stock to field survival. Small grades of stock below $\frac{1}{16}$ -inch caliper are generally culls, trees between $\frac{1}{16}$ - and $\frac{1}{8}$ -inch caliper are marginal grades, and those above $\frac{3}{16}$ -inch caliper are premium grades for most species. (Fig. 45.)

Small trees of slow-growing species, or those with medium growth rate in the nursery, have a higher survival than trees of the same caliper class in fast-growing, succulent nursery or wilding stock. For instance, a honeylocust, Osageorange, or American elm seedling of $\frac{1}{16}$ -inch caliper had a better survival than the same size tree of Chinese elm, cottonwood, or catalpa. For practically all species, stock with a caliper of $\frac{1}{16}$ -inch, the best size for field planting, gave uniformly good survival.

There are, besides survival, a number of advantages in favor of sturdy plants of good caliper. For one thing, they grow better and more vigorously than small stock. For instance, seedlings of black locust in the $\frac{1}{16}$ -inch-caliper class had an average height of 29 inches at the end of the first season after field planting; whereas, those of $\frac{1}{16}$ -inch caliper and over, even after having been top-pruned to 6 inches at time of planting, had an average height of 50 inches. This stand will close earlier, and cultivation can be dispensed with in a shorter time.

Larger trees are less likely to be plowed out or buried during cultivation. On very sandy areas they are not so likely to be injured by the blowing away of soil from the roots or by having the bark cut away by the moving sand. Survival examinations in Oklahoma showed rather high loss in small seedlings where the rows crossed over sandy knolls, mostly from the blowing away of several inches of soil from the roots. In large stock the loss was much lower.

Again, their greater supply of stored food aids the larger plants to establish their root systems sooner, making them less susceptible to midsummer droughts and other ill chances. Examination of the root systems of 1-year-old seedlings in the middle of the first season in the field showed that large planting stock had a much wider spread of roots and usually had penetrated deeper than small stock. In case

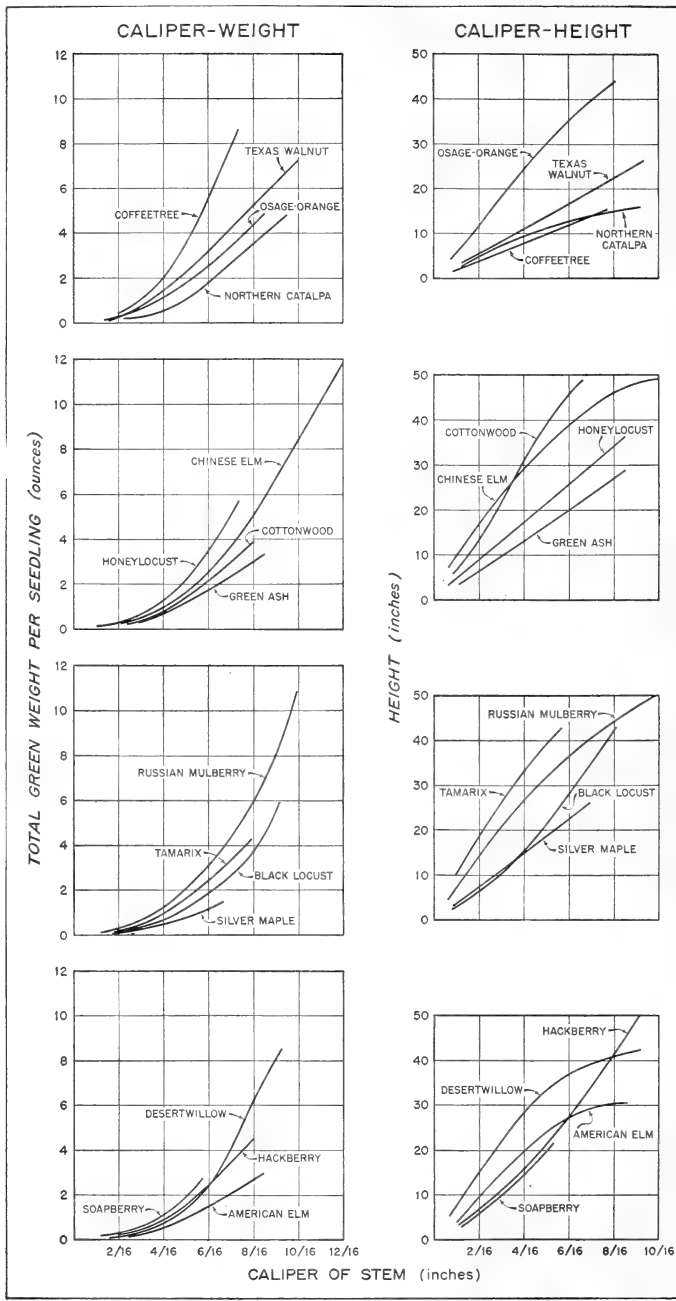

FIGURE 42.—Relation between caliper of stem and total green weight and height of top of various species of nursery and wilding stock.

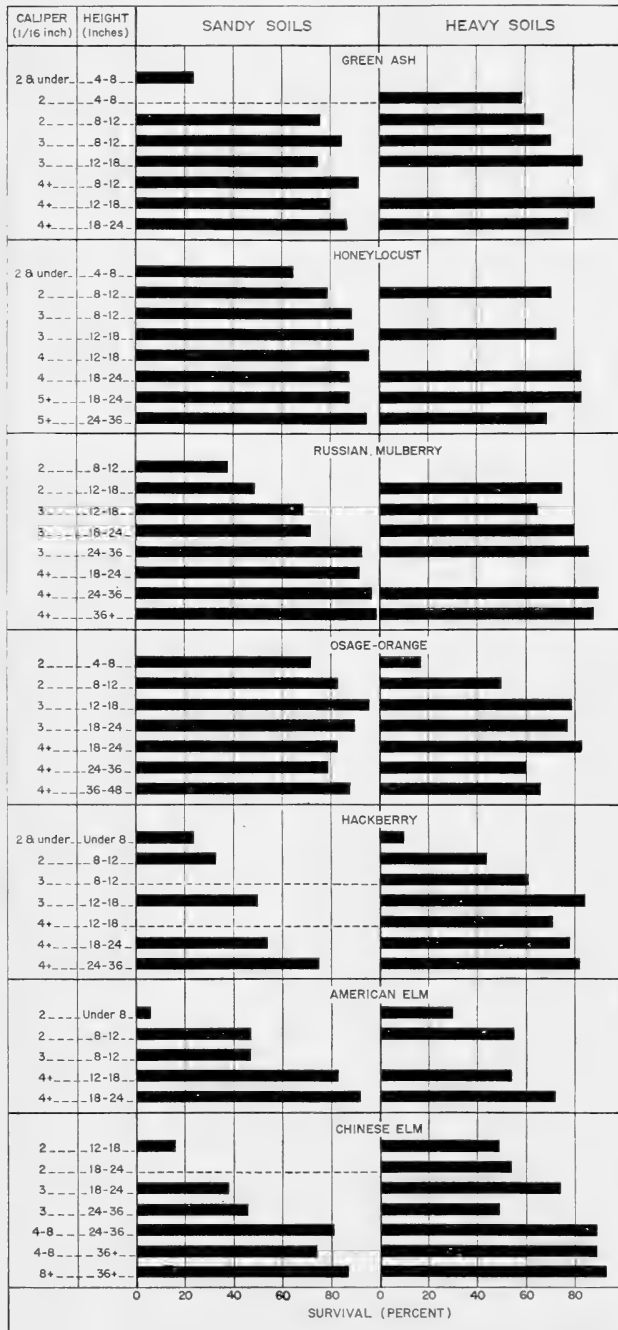

FIGURE 43.—Relation of caliper and height class to first-year field survival of seven species of nursery stock in a drought year, in sandy and heavy soils.

the trees are defoliated in early summer by insects, the large plant still has enough reserve of food left in the roots to put out a second crop of leaves, whereas small plants may not have the necessary reserve and will suffer severely from a single defoliation.

On the basis of field survival obtained in the experiment and a knowledge of caliper-weight relationships for the various species,

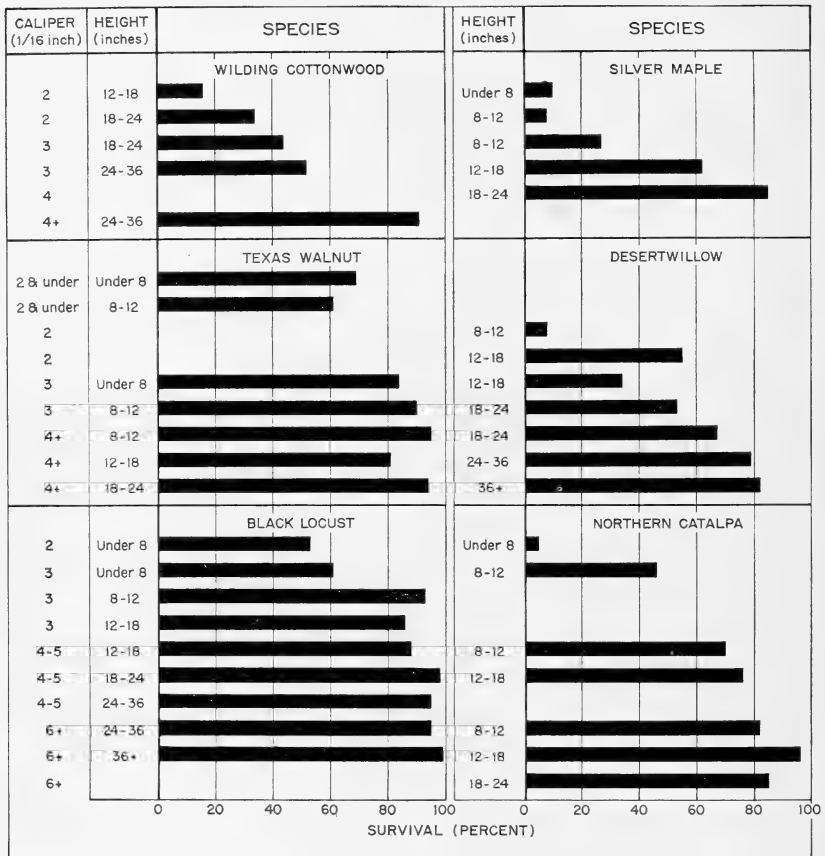

FIGURE 44.—Relation of caliper and height class to first-year survival of six species of nursery stock in a drought year, in sandy soil only.

grading recommendations have been set up for 14 species as shown in table 25. Survivals to be expected of the premium grades in average years are 70 to 99 percent; of the marginal grades, 40 to 70 percent; and of the culls, 5 to 40 percent. In years of normal rainfall the grades here classed as marginal would probably have good survival, but to get consistently high first-year survivals most of the nursery stock should fall in the premium grade. If it is necessary in years of low nursery production to use a certain percent of trees in the marginal grades, only the larger seedlings should be used, and success will then depend upon exceptionally favorable moisture conditions in the field.



FIGURE 45. One-year-old seedlings from a Nebraska nursery: *A*, Hackberry; *B*, wild plum; *C*, honeylocust; *D*, Russian-olive; *E*, Chinese elm; *F*, Russian mulberry. The large seedlings are premium grade, the small seedlings are in the marginal grade, those of *D*, *E*, and *F* are culls.

Much the best policy is to follow nursery practices—mainly proper watering, correct density of sowing, and use of appropriate age classes—which will assure the maximum production of trees in the premium grades.

The grading standards, of course, apply to seedlings to be planted in climatic conditions such as occur between the 97th and 102d meridians. To make a general rule, one could say that at the eastern edge of the plains, because of more favorable moisture conditions, it would be safe to plant some of the smaller stock of the marginal grade; while in the drier sections, especially in the western half of the plains, only the larger, sturdier, and better-balanced trees of the premium grades should be planted.

TABLE 25.—*Classification of nursery stock on the basis of field survival in a drought year*

Species	Premium grades		Marginal grades		Culls		
	Minimum caliper ¹	Minimum green weight	Caliper	Green weight	Maximum caliper	Maximum green weight	Maximum height
	<i>Inch</i>	<i>Ounce</i>	<i>Inch</i>	<i>Ounce</i>	<i>Inch</i>	<i>Ounce</i>	<i>Inches</i>
Osageorange.....	$\frac{3}{32}$	0.4	$\frac{3}{32}$ — $\frac{1}{2}$	0.2—0.4	$\frac{3}{32}$	0.2	8
Honeylocust.....	$\frac{3}{32}$.4	$\frac{3}{32}$ — $\frac{1}{2}$.2— .4	$\frac{3}{32}$.2	6
Green ash.....	$\frac{3}{32}$.4	$\frac{3}{32}$ — $\frac{1}{2}$.2— .4	$\frac{3}{32}$.2	6
Soapberry.....	$\frac{3}{32}$.4	$\frac{3}{32}$ — $\frac{1}{2}$.2— .4	$\frac{3}{32}$.2	6
Black locust.....	$\frac{3}{32}$.5	$\frac{3}{32}$ — $\frac{1}{2}$.2— .5	$\frac{3}{32}$.2	6
Texas walnut.....	$\frac{3}{32}$.7	$\frac{3}{32}$ — $\frac{1}{2}$.2— .5	$\frac{3}{32}$.2	6
Hackberry.....	$\frac{3}{32}$.5	$\frac{3}{32}$ — $\frac{1}{2}$.2— .5	$\frac{3}{32}$.2	10
American elm.....	$\frac{3}{32}$.5	$\frac{3}{32}$ — $\frac{1}{2}$.2— .5	$\frac{3}{32}$.2	8
Russian mulberry.....	$\frac{3}{32}$.5	$\frac{3}{32}$ — $\frac{1}{2}$.25— .5	$\frac{3}{32}$.25	12
Desertwillow.....	$\frac{3}{32}$.5	$\frac{3}{32}$ — $\frac{1}{2}$.2— .5	$\frac{3}{32}$.2	12
Chinese elm.....	$\frac{3}{32}$.8	$\frac{3}{32}$ — $\frac{1}{2}$.25— .8	$\frac{3}{32}$.25	16
Silver maple.....	$\frac{3}{32}$.5	$\frac{3}{32}$ — $\frac{1}{2}$.25— .5	$\frac{3}{32}$.25	10
Catalpa.....	$\frac{3}{32}$.5	$\frac{3}{32}$ — $\frac{1}{2}$.25— .5	$\frac{3}{32}$.25	6
Wilding cottonwood.....	$\frac{3}{32}$.6	$\frac{3}{32}$ — $\frac{1}{2}$.3— .6	$\frac{3}{32}$.3	18

¹ The upper limit for caliper in all species in the premium grades can be set at $\frac{1}{32}$ inch. Trees above that caliper show good survival but are so large as to reduce planting speed materially.

In all cases, trees which are classed as culls should be discarded. It is considered extremely poor policy to use the cull grade in field planting, no matter how urgent the need is for stock. It is also considered poor policy to transplant cull stock for an additional year in the nursery, if the stock represents the poorest 10 or 20 percent of a block of seedlings which was produced under favorable growing conditions and which had germinated uniformly. Such stock includes most of the seedlings which are defective from a hereditary viewpoint, and these weaklings will probably succumb shortly after being field planted. On the other hand, if a high percentage of the trees in the block are undersized because of shortage of moisture or natural slow growth rate, the seedlings can be left for another year in the nursery. An alternative would be to undercut the seedlings in the tree rows, pull the plantable stock, and leave the rest in place to grow into the 2-0 age class.

WINTER STORAGE AND SHIPPING OF NURSERY STOCK

Fall-dug nursery stock which is not immediately planted must be stored over winter to hold it in readiness for spring planting. The two methods of storage commonly used are inside storage and heel-in or outside storage. The Forest Service has found heel-in storage to be

the more successful in that, if properly done, it affords less chance of molding or drying loss.

INSIDE STORAGE

Inside storage is of chief advantage to commercial nurseries which use the winter months for grading and assembling orders, since it affords ready access to the stock at any time during the storage season. Its greatest disadvantage is the large outlay required to construct and operate a suitable building. The essentials of a nursery-stock storage building are adequate rack and working space and

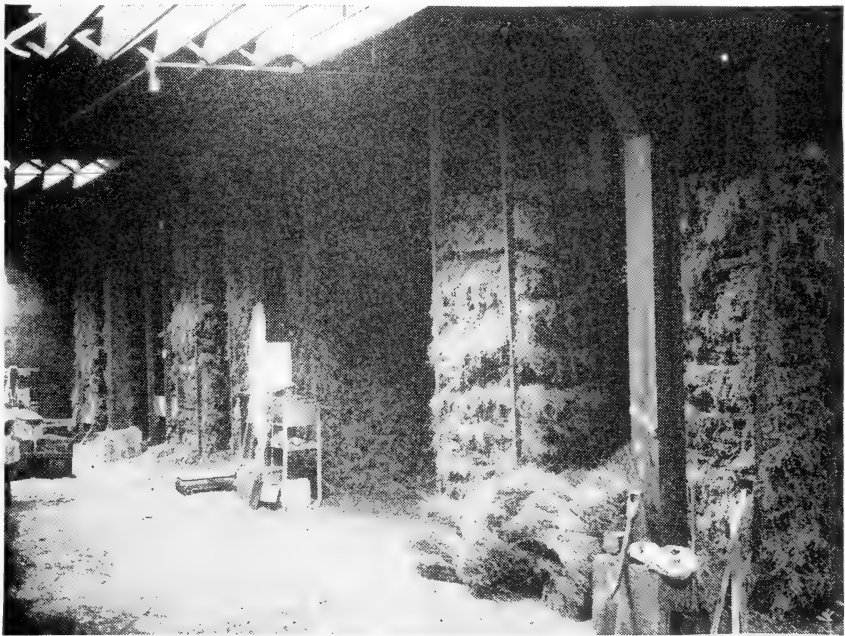

F342199

FIGURE 46.—Winter storage of seedlings, Fremont, Nebr.

proper insulation and construction for the control of temperature, humidity, and aeration (fig. 46). Laurie and Chadwick (20) describe in detail the construction of storage buildings.

Temperatures in the storage building should be near freezing to hold the seedlings dormant for many months. A temperature range from 34° to 38° F. is most satisfactory, and even 30° may be permitted if the stock is well covered with packing material. In addition to holding the stock dormant, low temperatures reduce the rate of respiration and keep fungi inactive. In a well-insulated building desired temperatures are readily maintained by correct ventilation technique. During spring and fall months the temperature in the storage sheds may be reduced by opening ventilators at night, or whenever outside temperatures are below those inside, and closing them when the opposite condition exists. In milder winter days

when it may be necessary to raise the temperatures occasionally, the ventilators should be opened during the day when outside temperature is above freezing, and closed at night.

The best humidity for stock storage is 85 to 90 percent. If lower than 85 is permitted, the stock may shrivel, and if above 90, molds and other storage diseases may spread. Proper moisture content is best maintained by relative humidity of the air rather than by contact with moist packing material. Humidity can be reduced by opening of ventilators or increased by sprinkling the walls and floors with water. A daily check should be made with a wet-and-dry bulb psychrometer or hygrometer to determine the relative humidity.

Figure 47 illustrates a desirable plan of an inside storage room that can be varied to suit the dimensions of any warehouse. The individual sections are 4 feet long and separated by 2 by 4's. In general, 4-foot, or preferably 6-foot aisles are necessary to permit the workmen to move freely. A space of about 6 feet is allowed between the first tier of stock and outside storage walls, varying with the effectiveness of the insulation; but it is best to keep the stock well away from the outside walls, especially in northern States. An 18-inch free space for ventilation should be left between the inside walls and the first tier of stock, also between the adjoining tiers.

Figure 48 illustrates a convenient method of setting up the tiers for racking the seedlings, patterned after the system in use at the Plumfield Nursery at Fremont, Nebr. Since no nailing is required the racks can be set up readily with no breakage of lumber. The shelving is quickly and easily inserted by means of the shelf hook. The shelves permit the racking of the seedlings from floor to ceiling without excessive pressure at any point and facilitate separation of the various species and grades.

The seedlings are racked with the roots out and tops in. Tops may be allowed to overlap if aeration is provided, if they are clean of leaves, and if they are not exposed to dripping moisture.

Although it is not necessary to pack the roots where the storage humidity is properly maintained, they should be protected with a light covering of shingletow or sphagnum moss as a safeguard against fluctuation of temperature and, to some extent, variation in humidity. If the packing material is soaked in water and then allowed to drain before using, it will retain sufficient moisture to make frequent sprinkling unnecessary in a storage shed where a proper range of humidity is maintained.

OUTSIDE STORAGE

Outside heel-in conditions vary widely from north to south in the prairie-plains region. In the southern prairie-plains States, the ground seldom remains frozen for any great length of time and heel-in beds may be opened and stock heeled in or removed as needed, with very little delay because of frozen ground. Farther north, where the ground remains frozen over winter, the stock must be heeled in before the ground freezes and remain in the beds until the spring thaw.

The essentials of a satisfactory heel-in site are (1) sandy soil, (2) adequate drainage, (3) ready accessibility to an all-weather road, (4) a convenient warehouse or other suitable building large enough for assembling orders and packing out stock for planting. Water,

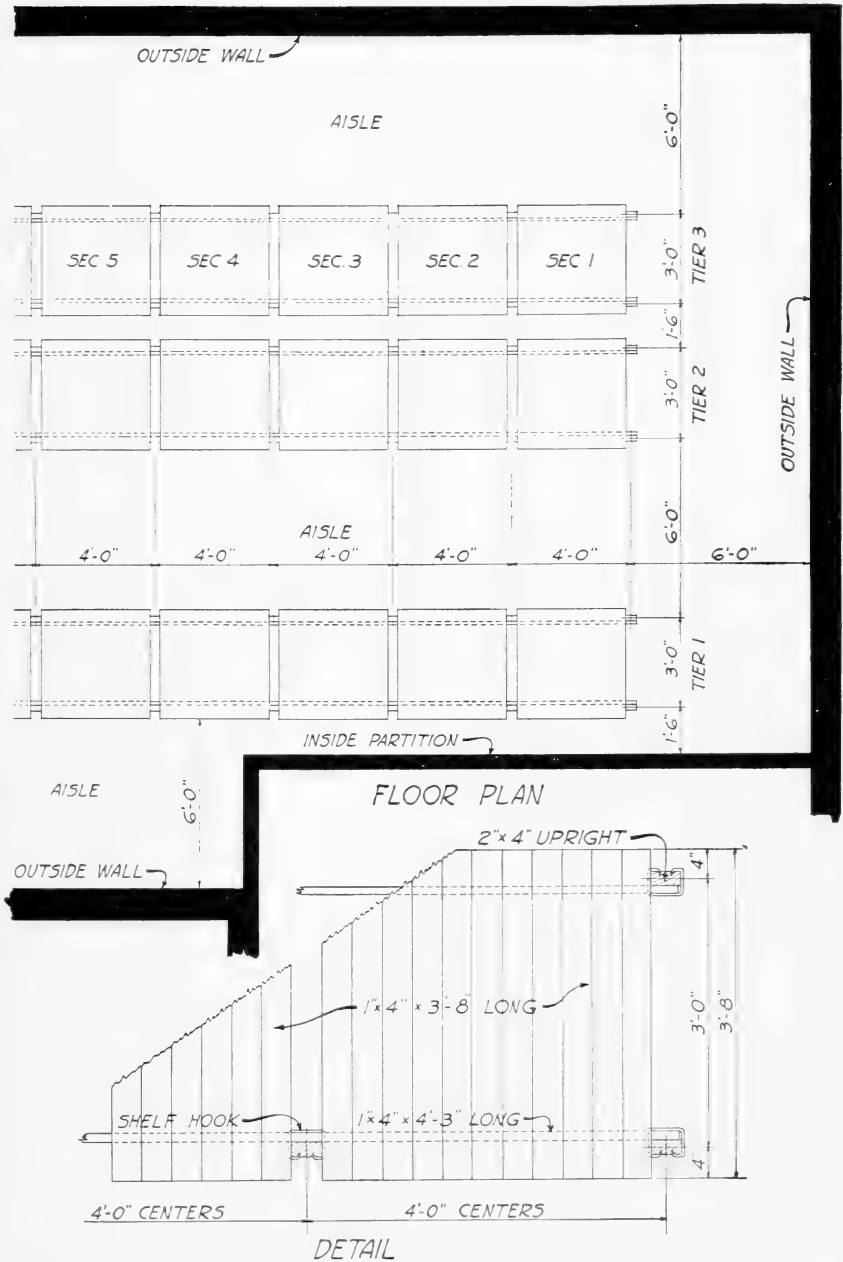

FIGURE 47.—Floor plan of an inside storage room for nursery stock.

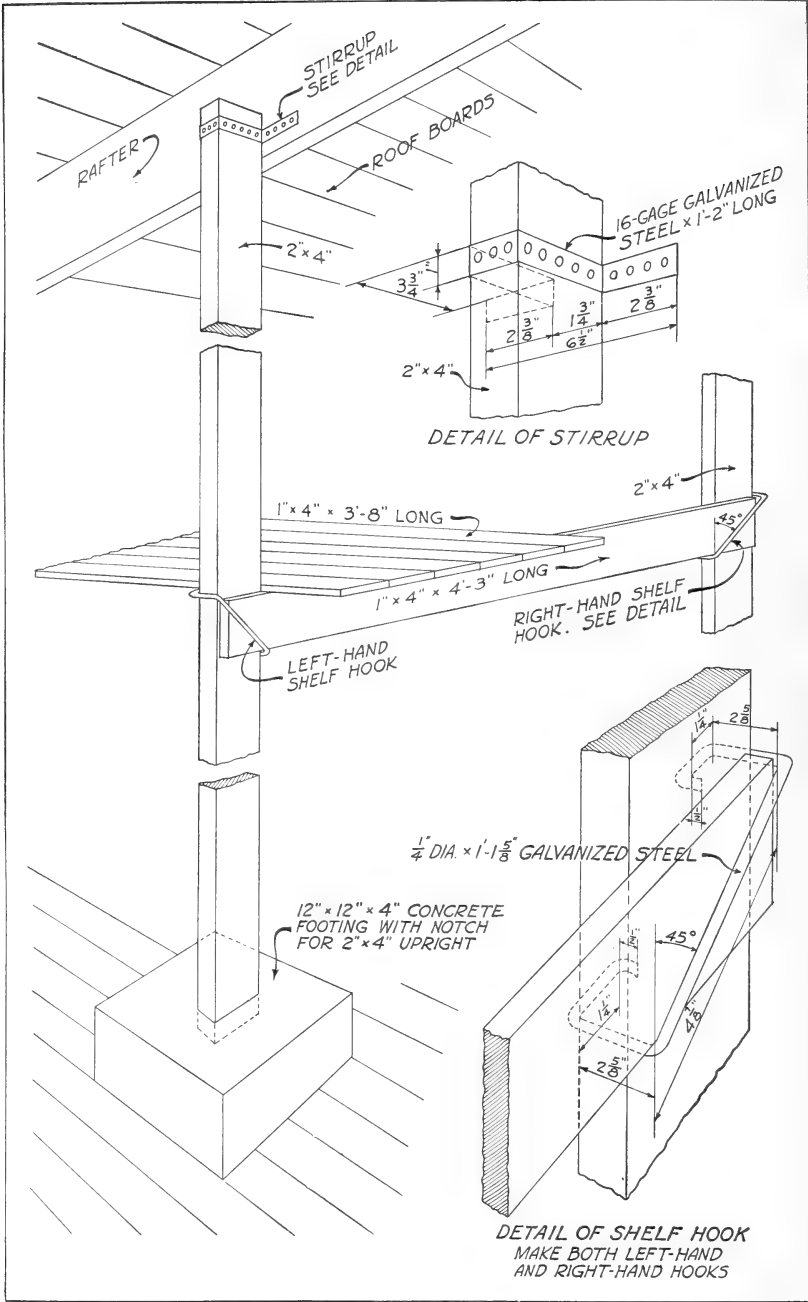

FIGURE 48.—Method of setting up racks for inside storage of nursery stock.

preferably under pressure, is desirable but not essential. If the other requirements are met, the site will require very little water which can be hauled in as needed.

A deep sandy soil with adequate surface and subsurface drainage is of first importance, since the soil is the storage medium for the stock. Sandy soil when washed in or firmly tamped settles closely around the seedlings, filling up all the larger air pockets. With adequate drainage, a sandy site will not become waterlogged, thus making it possible to heel in or remove stock at any time that the ground is not frozen. A further reason for selecting well-drained



F365475

FIGURE 49.—Outsize storage in heel-in beds.

sites is that alternate freezing and thawing of waterlogged heel-in beds may cause serious damage to the stock.

In such a heel-in storage plot as that shown in figure 49, the length and number of individual beds are limited only by the space available. Figure 50 gives the lay-out of a plot containing six beds 10 feet wide and 150 feet long. Beds of this width will generally accommodate 20 bundles of 50 seedlings, or 1,000 seedlings, in each row, thus simplifying all stock records. One such bed, of which six are shown in the plan, allows approximately 1,500 square feet of bed space, and accommodates about 150,000 seedlings of usable size.

A 40-foot turnrow should be left at the end of the beds, and a 16-foot roadway on both sides of each 2-bed unit to facilitate loading and unloading of trucks. An 8-foot alley left between the two beds in a unit permits increasing the width of the rows when more than 10 feet is necessary to accommodate 20 bundles. This alley will also allow for drainage and working space, and furnish a source of soil for mounding over the beds. As a matter of convenience in getting around the beds, a 3- or 4-foot cross path is made every 50 feet.

Figure 51 illustrates the technique followed in heeling in seedlings. A trench about 3 feet wide is dug across the full width of the bed with a back wall slope from the vertical of 30° to 45° . The depth of the trench should be sufficient to accommodate the roots of the seedlings without curling when the trees are laid on the sloping back wall with the root collars 1 or 2 inches below the original ground level.

Twenty bundles of seedlings are laid close together against the back wall of the trench. Soil from the forward wall or bottom of the

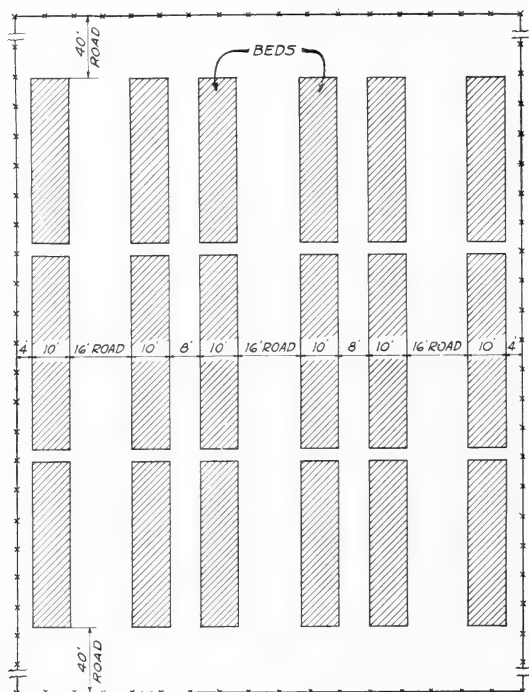

FIGURE 50.—Plan for a heel-in storage plot of six 150 by 10 foot beds, accommodating approximately 900,000 seedlings.

trench is then shoveled against the seedlings and firmly tamped, building up a new back wall about 8 inches in front of the first and sloping at approximately the same angle. The men should use their feet to pack the soil around the roots. An alignment pole is placed across the bed in line with the new back wall. A piece of $1\frac{1}{2}$ -inch iron pipe will be found very satisfactory for this purpose. The purpose of the pole is to prevent the individual bundles in the second row from being forced out of line and to enable the entire row of bundles to be pushed forward if necessary, during the process of firming the soil about the roots. This procedure is repeated for each succeeding row of bundles.

The beds may then be crowned over with soil, leaving the top one-third or one-half of the seedlings exposed (fig. 51, E). The crowning over of the beds assures adequate covering of the seedlings, in addition to providing drainage to carry off excessive moisture in the form of rainfall.

When insufficient soil-moisture content necessitates watering the beds heavily following heeling-in, in order to settle the soil closely about the seedlings, care must be taken to avoid overwatering, especially if drainage conditions are not perfect. If no water is applied, closer attention will need to be paid to tamping the soil about the seedlings. To accomplish this best, the small space between the rows of bundles should be thoroughly packed before the beds are crowned over.

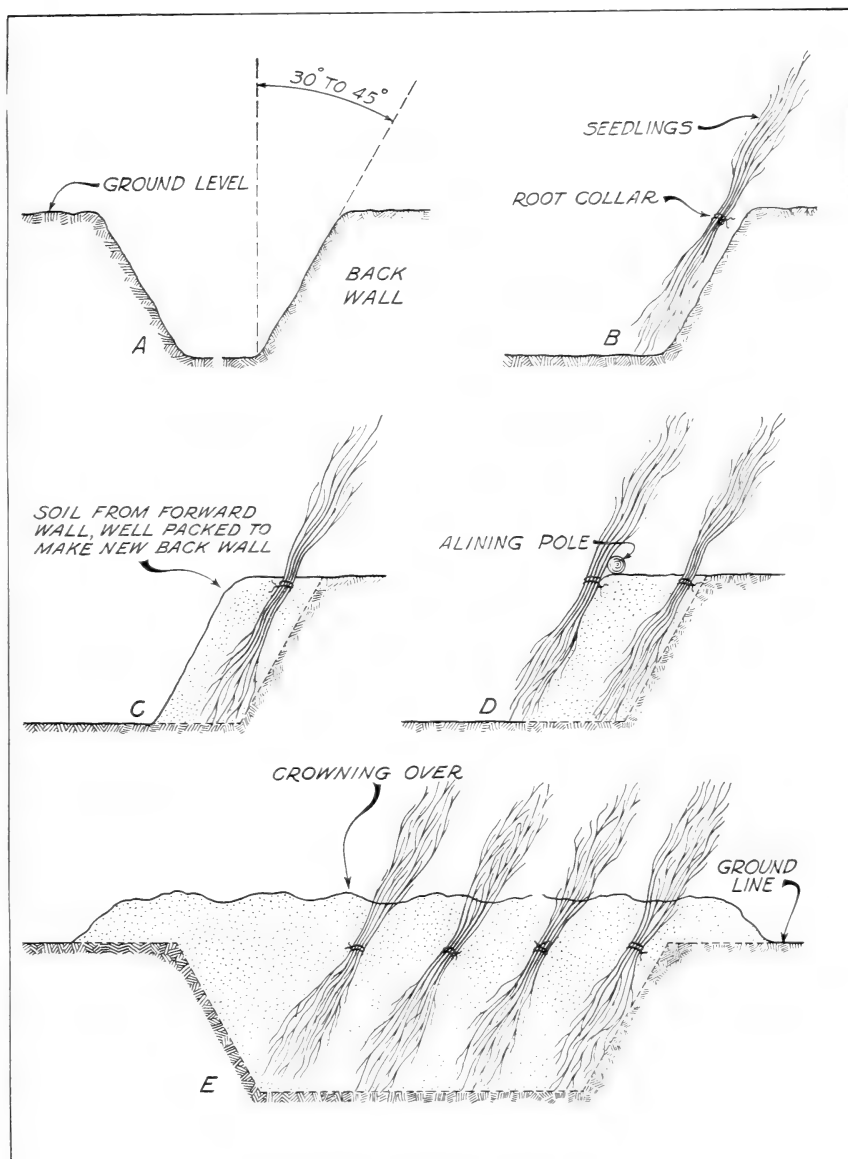

FIGURE 51.—Steps in heeling in nursery stock: A, A trench 3 feet wide with a 30° to 45° slope from the vertical on the back wall; B, bundle of seedlings placed with root collars 1-2 inches below ground line (indicated by twine binding); C, first row packed in and new back wall ready for second row; D, position of alinement pole; E, trench filled with four seedling rows.

In the southern and central parts of the plains region, where freezing and thawing alternate and drying winds commonly occur during the winter months, the beds can be covered with straw in late fall to protect the tops of stock from drying. The straw cover will also prevent the ground from freezing and will give access to the stock at all

times. This is a desirable feature, especially in Oklahoma and Texas where field planting is carried on throughout most of the winter months.

When trees in heel-in beds respond in the spring to rising soil temperatures and leaf out and begin growth, precautionary measures are necessary to hold them dormant until planting preparations are completed. The fundamentals of such procedure lie in keeping direct sunlight from the beds, thereby retarding the rise of ground temperatures. In the northern plains, stock can be held dormant in the heel-in beds by covering the beds in winter with 1 or 2 feet of packed snow. If the snow is then covered with a thick layer of straw, the beds reserved for late spring planting will remain frozen as long as desired. The snow and straw covering should be extended well out from the edge of the beds, to prevent thawing out from the sides, and should be put on after the frost has penetrated the ground from 3 to 6 inches. In the spring, the beds will thaw out rapidly after the straw cover is removed, and shipment of trees can begin at once.

A simple adaptation of this method is to heel-in the trees on a strip of ground 30 to 50 feet wide on the lee side of a 4-foot, slat-wire fence. A snowdrift will form over the trees, and its melting can be retarded in early spring by covering the drift with straw. Stock so retarded will leaf out very rapidly after the snow melts and the straw cover is removed, perhaps because of the abundant moisture from the melted snow. If growth must still be retarded the stock should be moved at once into a drier section of the heel-in site.

In the southern Plains the ground seldom freezes deeper than 6 or 8 inches and snow is seldom available for holding seedlings dormant. It is necessary to shade the beds with burlap or snow fence while the trees are still dormant. It is important to remember that the main purpose of the shading is to hold down soil temperatures. To expedite work and aid in ventilation, the shade should be high enough to allow easy working space below it.

As a last resort, and in case the trees in heel-in beds do start leafing out and it is known that they will not be planted for some time, it is advisable to move them from one bed to another; this will serve to check growth for some little time.

PACKING AND SHIPPING

Stock used in shelterbelt planting is first transported from each individual nursery to heel-in beds in each planting district for over-winter storage and subsequent shipment to the planting areas. In this operation, bulk shipments by either trucks or rail are satisfactory. Rail transportation in refrigerator cars equipped with heaters is especially advantageous in the late fall or early spring to prevent freezing of stock in transit. Long-distance transportation is also best accomplished by rail or by large trucks if the amount of stock involved will amount to a full car or van. Large van shipments have an advantage over rail shipment since they can be loaded at the nursery and unloaded at the district heel-in beds, thereby avoiding extra handling. When stake-body trucks are used, they should be lined on the sides with a tarp, plywood, or similar material to prevent drying out of stock. Thoroughly saturated shingletow should be used liberally in packing the bundles into the truck and heavy canvas tarpaulins should be lashed over the top of the load.

When stock is to be shipped from the central storage or heel-in grounds to the planting site, orders are sent in to the shipping point in advance, specifying the date planting is to begin. The orders list the species and amount of stock required for each individual field planting. The night before the stock is to be planted, the shipping force packs into crates, directly from the heel-in bed, enough trees to keep all crews busy the entire day. It is desirable to mark each crate with a tag showing species, age class, number of trees, and seed source, in case various sources are involved. In most cases age class and seed source need not be recorded on each tag if the stock in each species used on a given district is all of single species and age class. The crates used in shipment are of such a size as to be easily handled and also to serve as seats for the planting crew.

SEEDLING PROTECTION

In the nursery and in the process of distribution, seedlings are more susceptible to injury or loss from a variety of causes than at any later time in the field. Concentration of large quantities of nursery stock in heel-in beds and in storage sheds increases the probability of loss. Intensive protective measures are important at these stages, both because of the immediate values involved and because future work plans depend upon the stock being available in specific amounts at a definite time.

It is considered good policy in growing large quantities of nursery stock to allot production to several medium-sized nurseries separated by some distance, rather than to concentrate all production in one large nursery. Then if a localized catastrophe, such as disease, insects, or a hailstorm, strikes a single nursery and seriously disrupts an entire season of field planting planned on a minimum production schedule, the blow to the planting program will be less severe than if the stock were concentrated.

Protection of seedlings involves guarding against loss by four major groups of factors, meteorological, entomological, biological, and pathological. The chief meteorological factors which cause loss in the nursery are wind, heavy rain, heat, drought, hail, and frosts. For most of these, certain measures can be taken to prevent or minimize damage.

WIND

Wind adversely affects seedling production chiefly (1) by uncovering the seed and seedlings and blowing them out of the ground, or covering over or burying them; (2) by causing mechanical injury from particles of sand sweeping along the ground and cutting the small seedlings near the ground line, or sand blasting the tender foliage or cotyledons; (3) by accelerating depletion of the soil moisture; and (4) by intensifying the drying effect of high temperatures on the plant tissues.

Protection from wind is most important during the germination period and early life of the seedling, since this is the time when maximum injury occurs. On nursery sites with fine-textured soils, which are not protected by permanent shelterbelts, considerable benefit may be obtained from the use of snow fences placed at intervals of 50 to 200 feet at right angles to the direction of prevailing wind. Closer spacing is needed on sandy soils.

Protection from soil movement may also be obtained by cultivating in a manner that will leave the ground rough or ridged. A ridge of soil thrown over the seed rows will appreciably reduce the danger of the seed being uncovered (fig. 52). Because the destructive hot winds so damaging to young seedlings come generally from the south, nurserymen run the rows in an east-west direction whenever the lay of the land permits, to break the sweep of the wind near the ground.

If at all possible, nursery sites should be located so as to take advantage of natural or artificial tree windbreaks (fig. 53). In planning



F360359

FIGURE 52.—Ridging of seed rows and use of snow fence aid in giving winter protection to fall-sown seed.

a permanent windbreak of trees for a nursery site in the plains region, provision should be made to enclose the area at least on the south, west, and north sides from which the damaging winds usually come; the east side may also be enclosed to advantage. The intensive protection afforded by a windbreak has been shown to extend out to the leeward side to a distance of 10 to 15 times the height of the windbreak. Windbreaks should therefore be spaced in such a manner as to provide reasonably good protection when the trees are 10 to 20 years old. This means that the parallel belts should not be farther than 660 feet apart, and less on unstable sandy soils.

Annual plants—such as sorghum, cane, sunflower, and Sudan grass have been tried as windbreaks in many nurseries in the plains region, but results are disappointing. The plants are of little help to the seedlings during the early critical period because of lack of height at that time. Another disadvantage is that they sap the soil moisture and stunt the seedlings in the nearby rows. If used at all they should be planted adjacent to irrigation ditches where their sapping effect will not be so evident.

RAIN AND HAIL

The beating action of the rain in heavy downpours or of hail frequently causes loss of young seedlings through breakage of the fragile stems. Heavy rains may also wash the soil on slopes and expose the roots of seedlings or may bury the seedlings under mud and silt. Seed may also be washed out or buried so deep as to prevent germination. In some cases, pools formed in low areas drown out the seedlings.

Judicious site selection will in a large measure prevent damage from heavy rainfall, except that which occurs just as the seedlings



F329682

FIGURE 53.—A portion of Forest Service nursery near Pierre, S. Dak., showing protection afforded by native cottonwood, green ash, and redb cedar.

are germinating. Slopes exceeding 2 percent, which may wash appreciably, should be avoided. Low, undrained spots which permit formation of large puddles should be filled in by a grader.

In case a heavy rain has buried or partially covered recently germinated seedlings, it is advisable to get on the area as soon as possible and uncover the tops of any seedlings which may be held down by soil, before smothering or rotting takes place. This rotting effect is especially serious on leaves of young Russian-olive seedlings, and plains nurserymen have devised a tractor-drawn rotary brush to remove soil from the foliage of the young plants.

In the plains region, hail storms are of frequent occurrence but generally of comparatively limited spread. The nurseryman can do little to prevent hail injury. Where seedlings are grown in beds, covering them with close-mesh wire screens or lath shades is effective, but this is not a practical measure for large-scale nursery operation. The desirability of avoiding "hail belts" in locating nursery sites has already been stressed.

HEAT

Heat, unless associated with drought, will not have any serious effect on well-established seedlings, except to retard growth. It is common knowledge that young seedlings that are in the process of germinating or that still have succulent stems, are particularly susceptible to high temperatures even though adequate subsoil moisture is present. Such injury may appear either as heat lesions on the stem at the ground line, or burning of the leaves and succulent tops. The logical solution of the problem of heat injury is to use nursery technique that will produce sturdy woody stems as early in the season as possible.

Shading and irrigation by overhead sprinklers are helpful in reducing damage from heat, but shading is not a practical measure in large deciduous tree nurseries unless the seedlings are grown in beds. Sprinkling may have to be done twice a day on soils of low water-holding capacity.

For a dark-colored, loamy sand nursery soil in North Dakota, it was found that 1½ hours of overhead watering, starting at 12:10 p. m., reduced soil-surface temperatures from 125° to 96° F. on a day when the air temperature in the shade was between 100° and 106°. The hourly record was 103°, 117°, 119°, and 107° respectively at 2, 3, 4, and 5 p. m. On the unwatered areas the temperature at the surface remained around 125° until 4 p. m., but dropped to 110° by 5 p. m. Six-week-old seedlings of ponderosa pine in this nursery showed definite heat lesions on the southwest side of their stems when soil-surface temperatures exceeded 120°. It is believed that the temperature at which plants will suffer injury depends not only on the length of exposure, age, and development of the species but also on the nature and size of the soil particles and color of the soil.

Heat injury to nursery stock is always more prevalent in coarse, sandy soils than in fine-textured soils, even in cases where soil temperatures are not essentially different. This appears to be due to the greater reflection of heat from the sandy surface, and higher conductivity of the sandy material. The lower water-holding capacity of the very sandy soils makes it necessary to watch surface temperatures more closely; heat injury may occur as soon as the surface quarter inch of soil has dried out, even though there is abundant moisture below the surface level.

During the prevalence of high temperatures in 1936 in the plains area, heat injury caused considerable loss in the nurseries, especially where no overhead irrigation was available. Furrow irrigation failed to distribute moisture on the surface of the soil either rapidly or evenly. Fortunately, such extremes of temperature are the exception rather than the rule, and it is not considered justifiable to install overhead systems to cut down severe heat losses occurring only at such wide intervals.

Observations indicate that stand density in seedlings growing in narrow bands has little effect in preventing heat losses during the critical period of emergence and establishment. The main advantage of denser stands is that there is less mechanical injury from wind and beating rains. After passing through the initial critical period, however, stands of average density (8 to 12 seedlings per lineal foot),

because of their larger leaves and more rapid growth, will as quickly afford mutual protection as the overdense stands of 30 to 40 seedlings per foot.

Foliage appears to give the most protection to the stems of the plants from the direct rays of the sun if the rows are in line with the sun in midafternoon, when temperatures are highest. In a few nurseries it has been observed that heat injury was reduced if the rows ran in a north-to-south or northeast-to-southwest direction. Slope of the land will govern row direction, however, wherever furrow irrigation is practiced. Even where overhead irrigation is used, the row direction will probably be influenced more by the direction of prevailing wind during the growing season than by the possibility of heat injury.

DROUGHT

Injury from drought occurs in nurseries when the soil moisture is depleted to such an extent that the moisture cannot be absorbed by the roots of the seedlings at the rate required to offset the moisture lost by transpiration. This results in wilting and if prolonged will cause the death of the seedlings. High temperatures, low humidity, wind, and intense solar radiation will increase the rate of transpiration and will intensify the injury caused by low soil-moisture content.

When adequate natural rainfall does not occur, restoration of soil moisture by irrigation is an absolute necessity to prevent serious drought injury. An adequate irrigation system is an indispensable part of the physical equipment of any nursery located in areas where periodic droughts occur.

FROSTS

Killing frosts in late spring or early fall are of relatively common occurrence in the plains region. Proper nursery practices, such as delaying spring sowing until danger of frost injury to germinating seedlings is past, are the best safeguard against normal frosts. No wholly practical safeguard exists against the occasional severe late spring or early fall frosts.

If a sprinkling system is available, it should be turned on during cold nights to reduce or prevent damage. This is the most feasible protective measure that can be suggested for nurseries equipped with overhead irrigation.

Smudge pots, such as are used in California orchards to create an insulating blanket of smoke, may possibly have some effect on the prairie plains, if topography and air conditions are favorable. They have not been tried to date.

Mulching or covering the seedlings with straw will prevent injury from late spring frosts where stock is grown on a small scale in beds, but it is not practical for large nursery operations.

Tops of seedlings may suffer severe killing-back by frosts but, unless the root crown is injured, such seedlings will sprout from the root collar the next spring and establish new stems. Thus it can be said that the root crown or collar (for species which do not sucker from the roots) is the heart of the seedling. When it is dead the seedling is dead, regardless of the condition of the other parts. Covering the young seedlings with soil for 24 to 48 hours will ordinarily not prove harmful, and where warning is given soon enough this may greatly lessen the

damage. A better method, however, of preventing outright killing of the stock consists of ridging soil against the trees in the fall. At the time of the last cultivation, the throwing of a 3- or 4-inch ridge of soil against the stems of the seedlings will insure protection of the root crown against injury. Such hilling-up may be easily accomplished with a disk-shovel attachment to the cultivator.

LOSSES OCCURRING AFTER LIFTING

The losses which occur after the nursery stock has been dug are influenced by weather conditions, such as drying or freezing, but are chiefly due to human failure to take the necessary precautions.

Since the handling of deciduous stock in distribution does not require the painstaking care to avoid exposure of the roots of the seedling that is necessary with conifer stock, the 10 to 15 minutes required in the distribution procedure already outlined allows an ample margin of safety.

Occasionally shriveled roots and bark indicate seedlings that have been unwittingly exposed in transit or in handling to such a degree that injury from drying has resulted. This does not necessarily mean that the seedlings are dead or need be discarded. If the stock is covered with moist packing material for several days and soaked down with water or buried in moist soil for several days or the roots are placed in fresh water, the trees may absorb sufficient moisture to revive. If the stock has not been dried too much, the cells will again become turgid and the seedlings will have most of their normal vigor restored. If the seedlings do not return to their normal condition after several days and the roots begin to discolor and slough off, the trees are dead and should be discarded.

It is well known that the roots of plants are more subject to injury by freezing than the tops, and freezing of the roots of seedlings at some point during the handling process is a common cause of damage. Frozen stock should be thawed out gradually, with as much moisture present as is possible and with a minimum of handling. Properly thawed out, they will in many cases show no evidence of injury. If injury has occurred, it can sometimes be detected by a discoloration of the cambium layer of the roots. If the frozen stock is on a truck, the safest procedure is to drive the truck into a cool shed (40° to 60° F.), add additional packing material, sprinkle with cold water, and allow to thaw out over a period of several days. Cold water added from time to time will assist in drawing the frost from the trees. It is advisable to heel-in such seedlings in moist soil for a week. If the injury is slight, a normal or healthy appearance will be restored, whereas if the injury has been fatal, rotting and discoloration of the roots will be evident.

INSECTS FEEDING ON THE ROOTS ¹⁷

Some of the most dangerous pests of those most likely to cause damage to hardwood stock in plains nurseries, and the most difficult to control are insects that feed on the roots. White grubs and termites are among the worst offenders; wireworms and borers cause

¹⁷ The following sections on nursery insects and their control are contributed by J. A. Beal, entomologist, L. G. Baumhofer, associate entomologist, and N. D. Wygant, assistant entomologist, Bureau of Entomology and Plant Quarantine.

minor damage. Soil poisons or fumigants offer the best possibilities for control, but they must be used with certain precautions to prevent injuring the seedlings.

WHITE GRUBS

White grubs are the larvae of the large, well-known May beetles or "June bugs" (*Phyllophaga* sp.). These larvae are white, fleshy grubs with a brown head and three pairs of prominent legs. The body is held in a curved position. They are general feeders on the roots of plants and, although more common in grassland, at times are serious nursery pests. Soon after the roots of forest tree seedlings are eaten off, the foliage wilts, and the seedlings can be pulled with ease. When only part of the roots are destroyed, the trees may be dwarfed.

In South Dakota, Nebraska, and possibly in Kansas, the more injurious species require 3 years to complete their life cycle. The smaller first-year grubs, from eggs deposited in the soil late in the spring of the current year, generally cause little damage unless they are very numerous. Most of the damage occurs during the second year of development when the grubs are feeding heavily through the entire season. Feeding the third year continues only until midsummer when the grubs transform to pupae and adults in the soil, emerging the following spring. Adults are emerging each year, and consequently grubs in all stages may be found at any time. In the region where the 3-year life cycle prevails, the brood which emerged in 1932, 1935, and 1938 was by far the most numerous. Consequently there is more danger of white grub damage the year following these flights, if the nurseries are infested. In North Dakota it is likely that 4 years are required for some species to develop, while in the south the life cycle may be completed in 2 years.

Fumigation by flooding the infested soil with carbon disulfide emulsion has given some success in control on small areas, but the results vary in different soils and under different temperature and moisture conditions. Since the grubs go deep for the winter, this method can be used only during warm summer weather when they are feeding within a few inches of the surface. As the surface dries the grubs go down; consequently, fumigation while the upper soil is moist, or a day or two after irrigation, would probably be most effective. Half-grown stock apparently will not be damaged by the chemical, but young seedlings are more susceptible to injury.

A 50-percent emulsion, consisting of equal parts of carbon disulfide and a special commercial soap solution, may be used for this purpose. Treatment consists of diluting this 50-percent stock emulsion in the proportion of 1½ quarts to 50 gallons of water and applying at the rate of 3 pints per square foot of soil surface. An emulsion may also be prepared by using 1 part of rosin fish-oil soap, 3 parts of water, and 10 parts of carbon disulfide, by volume. Place the soap and water in a closed container and agitate until the mixture is uniform. Then add the carbon disulfide and agitate until the mixture becomes creamlike. This stock emulsion is diluted in the proportion of 1 quart to 50 gallons of water, and is applied at the rate of 3 pints per square foot as above. Late in the afternoon while the ground is still warm is the best time for application. The making of six or eight holes per square yard will also aid in the penetration of the gas.

These can be made with a broom handle or similar stick and should be about 5 inches deep. Puddling should be avoided, and the solution should not come in contact with the foliage, since there is danger of burning.

In handling carbon disulfide there must be no smoking or fires, as the strong vapor is explosive in confinement. Containers should be kept tightly closed to prevent rapid evaporation and loss of the gas in storage.

TERMITES

Termites, sometimes called white ants, resemble somewhat the true ants except that they are cream colored and the body is not constricted between the thorax and abdomen. Termites live in colonies in the soil or in wood and never work exposed on the surface. They feed on wood or other organic matter. While principally destructive to wooden structures, one species (*Reticulitermes tibialis* Banks) has caused considerable damage in the southern nurseries by feeding on the roots of seedlings. It is not likely that they will become important in the more northern nurseries.

In regions where termites are common nursery soil should be kept free of all decaying wood and of as much other organic material as possible, since such material harbors termite colonies. Where termites are known to occur in large numbers it would be advisable to let the land lie idle for a year, clean up any debris such as wood, stalks, or stubble, and thereafter use only well-rotted manure or preferably commercial fertilizers to stimulate tree growth. In cases where these protective measures cannot be undertaken, treatment of the soil with heavy dosages of carbon disulfide prior to seeding, although costly, could probably be relied upon to free the area of termites. Where trees are growing in an infested block, considerable precaution in treating would be necessary so as not to injure the trees. The use of carbon disulfide emulsion as suggested for control of white grubs would probably also be effective against termites. Paradichlorobenzene crystals worked into the soil to a depth of 3 or 4 inches with a hoe or other implement, at the rate of 3½ pounds per 100 square feet, have given indications of good control against root-feeding termites. Care should be taken to keep the crystals at least 2 inches from the seedlings.

WIREWORMS

Wireworms are slender larvae of uniform width, with a hard, tough, brownish or yellowish skin. They are the larvae of click beetles and feed on the roots of a large variety of plants. Wireworms are likely to be numerous in soil that has been in sod for several years, and occasionally may cause some damage in nurseries that have been under cultivation. Control is very difficult in soil where nursery stock is being grown because treatments severe enough to affect the insects would probably also destroy the seedlings.

BORERS

Occasionally where nurseries are planted on newly cleared land or where stock remains in the nursery for more than 1 year, considerable damage is done by borers. In the former case the larvae of a species of long-horned beetle of the genus *Prionus*, which usually work in the roots of larger trees, may remain temporarily in the soil and feed on

the roots of seedlings. To avoid such damage, stump land or land containing trees or brush should be cultivated for a year or two before using it for a nursery site. Trees which remain more than one season in the nursery may be seriously damaged by the flatheaded apple tree borer (*Chrysobothris femorata* (Oliv.)). To avoid this injury, trees should be kept in good growing condition and, if possible, should be removed from the nursery and planted out each season.

GIRDLING AND LEAF-FEEDING INSECTS

Cutworms and grasshoppers are here classed as girdling insects, although they are not always true stem girdlers but may feed also on the buds and foliage. A great many species of insects are true leaf feeders, but these can be discussed in a few groups since the control measures for the species within a given group are very similar. The common method of control is to spray a poison such as lead arsenate on the infested foliage so that the poison will be taken into the digestive tract with the food of the insect.

CUTWORMS

Cutworms are the larvae of the night-flying (noctuid) moths or "millers." Many species work on the seedlings at or just below the ground line, but a few species of climbing cutworms and the army cutworms may feed on the upper stems, buds, and foliage. Feeding in most cases takes place at night, and during the day the larvae may be found hiding in the soil near the injured seedlings. Although some species overwinter as pupae or adult moths, most of the cutworms pass the winter as partially grown larvae and start work during the first warm days of spring. The worst damage is likely to occur when the seedlings are coming up; during a single warm night a great many seedlings may be cut off.

Early discovery of the cutworms will prevent much damage. They can be controlled by scattering poisoned bran mash over the nursery in the evening. The bait should be made up as follows:

Large quantities:	
Coarse wheat bran.....	100 pounds.
Crude arsenic or paris green.....	5 pounds.
Molasses or syrup.....	2½ gallons.
Water.....	10 to 12 gallons.
Small quantities:	
Coarse wheat bran.....	5 pounds (1 peck).
Crude arsenic or paris green.....	4 ounces.
Molasses or syrup.....	1 pint.
Water.....	2 to 3 quarts.

The poison, molasses, and most of the water should be combined and then evenly mixed with the bran. The solution should be stirred constantly while applying it to the bran to prevent the arsenic from settling out. Enough water should then be added to make a crumbly mixture that will just stick together when tightly squeezed in the hand.

The bait should be thinly scattered over the nursery at the rate of 10 to 20 pounds (dry weight) per acre. Since the cutworms feed at night, and the bait is not attractive after it has dried out, it is necessary to spread it during a warm evening or late in the afternoon. Where damage was serious the previous spring and the cutworms have again

been found in the soil, it is advisable to make a scattering of the bait some warm evening just before the seedlings come up, to prevent heavy damage later. Frequently serious losses occur before the injury is noticed or treatment applied.

Several species of army cutworms appear at different times during the season in the plains States. When abundant, large numbers of the larvae will travel together over the ground, destroying vegetation as they advance. Poisoned baits, sprays, or dusts can be used to stop their progress. Also, to protect the nursery, a deep furrow with vertical sides can be plowed at a right angle to the line of march. The larvae falling into this furrow can be killed by dragging a log through it; or if shallow holes are dug at intervals in the furrows the worms that collect in them can be crushed or destroyed with kerosene.

GRASSHOPPERS

Grasshoppers feed on nearly all cultivated plants and occasionally become nursery pests. The infestation usually comes from areas adjacent to the nurseries, since the grasshoppers seldom originate in cultivated land.

Eggs enclosed in sacs or "pods" are laid in the soil late in the summer or in the fall, usually in grain stubble, meadows, and sod along ditch banks, fences, and roadsides. In the southern plains States the eggs may hatch as early as February, but in the northern plains States hatching usually does not occur until May or June. The young grasshopper nymphs resemble the mature insects, except that the wings are not fully developed and not functional until the final or adult stage. Although maturity is reached in 40 to 70 days, the hoppers may continue to feed until cold weather. There is usually only one generation a year.

During the early nymphal stages the young hoppers feed near the place where they hatch and can readily be poisoned at this time. In the later stages they move about in search of food and if numerous may infest the nurseries. Considerable migration may occur following the cutting of adjacent hay and small grain fields. The nurseries can be protected from such migrations by spreading poisoned bran mash in a barrier strip, from several rods to 100 feet or more wide, around the nursery. Several applications at intervals of 4 or 5 days will usually be necessary. A couple of deep furrows with vertical sides can also be used around the edge of the nursery to trap young grasshoppers. As they collect in these furrows they can be killed by daily applications of poisoned bait. After the insects have developed to the flying stage, these barriers will be of no value.

The poisoned bait is prepared as follows:

Coarse wheat bran (free from shorts or flour)-----	100 pounds.
Crude arsenic-----	5 pounds.
Cane molasses (low grade, such as blackstrap)-----	1½ gallons.
Water-----	10 to 12 gallons.

Spread the bran out on a tight floor or similar surface to a depth of 8 to 10 inches. Thoroughly mix the required quantities of water, arsenic, and molasses in a container. Gradually splash the solution, which should be continually stirred to prevent settling, over the bran and work it into a mash with a shovel or rake until it contains no lumps and is moist throughout.

This bait should be spread thinly and evenly at the rate of 10 pounds (dry weight) per acre, or more heavily if the insects are very numerous. It should fall into flakes when scattered with the hand and in this form will be safe for use. If left on the ground in lumps there is danger that livestock will pick up the poison. As the mash dries it becomes less attractive, and it is necessary to apply it when the grasshoppers are starting their first feeding of the day, usually early in the morning. In the case of migrations the hoppers may feed at almost any time where food is found. Spread the bait on a clear day, preferably when the temperature is between 70° and 85° F.

A mixture of half bran and half sawdust, or better, 60 percent bran and 40 percent sawdust, can be substituted in the above formula, but this mixture is not always as satisfactory as bran alone. Most sawdusts are suitable if they are fairly fine and a year or more old. Although fresh sawdust from cottonwood can be used, fresh pine sawdust is not suitable. Two quarts of liquid sodium arsenite (4 pounds per gallon material) or 2½ pounds of dry sodium arsenite can be substituted for the 5 pounds of crude arsenic. Five pounds of paris green can also be substituted, but this is much more expensive. Calcium arsenate, sodium arsenate, or lead arsenate should not be used.

CATERPILLARS

Caterpillars are the larvae of butterflies and moths. They are wormlike, smooth, spiny, or hairy, with 3 pairs of true legs and usually 5 pairs of false or prelegs, including the anal pair.

Insects of this group can be readily controlled by applying a spray of lead arsenate mixed in the proportion of 1½ to 2 pounds (powdered form) to 50 gallons of water. Other arsenicals such as calcium arsenate or paris green may be used, but with them there is greater danger of burning the foliage. A sticker such as fish oil or linseed oil, at the rate of 4 ounces for each pound of lead arsenate, will make the poison adhere to the foliage and give protection for a longer period.

BLISTER BEETLES

Blister beetles are of medium to large size, slender, with the portion between the head and wing covers (the prothorax) narrowest. The body and wing covers are comparatively soft. The color may be black, grayish, tan, or some other shade, either plain, spotted, or striped. Only the adults feed on the foliage, and they infest a variety of plants. In the nurseries certain species prefer Siberian pea-tree and locust foliage, although other seedlings may also be attacked. These beetles are distributed over the entire plains region. The larvae of some species feed on grasshopper eggs and therefore are beneficial in this stage.

Spraying the foliage with 1½ pounds of lead arsenate to 50 gallons of water will protect the seedlings, largely by repelling the beetles, although some will be poisoned. As the new growth comes out beetles will return to feed on this portion, and it will be necessary to spray several times to give good protection. The use of a sticker in the spray is not advisable where these repeated applications are made. Sodium fluosilicate applied as a dust has given good control of certain species, but there is some danger of burning the foliage.

FLEA BEETLES

The flea beetles are a group of very small leaf beetles, usually of metallic color. They are very active and jump vigorously when disturbed. They eat very small holes through the leaves. The adults of some species are rather general feeders on foliage while others attack only one species or related species of host plants. The larvae of most species live on roots in the soil but are generally not very harmful in this stage.

Flea beetles are difficult to control because the arsenicals are apparently distasteful and repel them. However, fairly heavy doses of lead arsenate, 2 to 3 pounds to 50 gallons of water, will give considerable protection if thoroughly applied to all the foliage. Several applications at about 10-day intervals may be required.

SAP-SUCKING INSECTS

Sap-feeding insects cannot be controlled by stomach poisons, such as the arsenicals, because the plant parts that would carry the poison are not eaten. They feed by inserting their beaklike mouth parts into the plant tissues and drawing out the juices. Contact insecticides, that kill by coming in contact with the body, must be used. There are a great many insects with sucking mouth parts, but the most common ones encountered in nurseries are the aphids and scale insects.

APHIDS

Aphids, or plant lice, are small, soft-bodied insects averaging about the size of a large pinhead. Many are green but some are yellowish, brown, or black. The sucking out of the sap from the stems or leaves seldom kills the host, but heavy feeding may cause wilting, discoloration, or even dwarfing of the seedlings.

A number of generations are produced during a single season, and the aphid population builds up rapidly under favorable conditions. Infestations should, therefore, be treated early. The usual recommendation for control is a spray made up of 1 pint of a 40-percent nicotine sulfate solution in 100 gallons of water, and the addition of 3 to 4 pounds of common laundry soap or fish-oil soap as a spreader. In smaller quantities, 1 teaspoon to 1 gallon of water plus a tablespoonful of soap makes a comparable spray. Where directions for aphid control are given on the container of the nicotine solution purchased, these should be followed. Pyrethrum and derris compounds have also been used successfully against aphids.

SCALE INSECTS

Scale insects usually resemble tiny scales of wax or very small galls attached to the bark or leaves. They can be divided into three general groups: (1) The armored scales, which are flattened and either oystershell shaped, pear shaped, or rounded in outline, and covered with a waxy excretion; included in this group are the oystershell scale, San Jose scale, Putnam's scale, scurfy scale, and elm scurfy scale. (2) The tortoise scales, which are tortoise-shaped or globular, and either naked or with a portion covered with a cottony substance; rather com-

mon in this group is the cottony maple scale. (3) The mealybugs, which are oval in form and soft-bodied, usually appear as if they had been dusted with flour. The European elm scale belongs to this group, but during its third stage it lacks the dusty covering and has a white, waxy fringe around the outer edge of the body.

While scale insects are not likely to cause serious damage to seedlings during the short time in the nursery, the stock should be kept free from scales lest the pests be transported to the field. The most common control measure is to spray with a dormant-strength miscible oil, oil emulsion, or lime sulfur, preferably in the spring just before the buds open. Such sprays are on the market under different proprietary names and should be used according to the directions of the manufacturers. With the heavy oils there is a possibility that dormant strengths will injure some of the thin-barked seedlings. During the growing season a summer white-oil emulsion or a summer strength of lime sulfur may be used, but these usually are not so effective as the dormant sprays. Usually none of these treatments will give complete control in one season, and consequently if only a small portion of the nursery stock is infested it should be destroyed and not sent to the field. Under more serious conditions it is possible that fumigation might be used for some of these scale insects at the time of shipment.

INJURIOUS MAMMALS AND BIRDS¹⁸

Mammals and birds may cause considerable damage to some species in the nursery by digging up or pilfering the seed shortly after it has been sown or by nipping and breaking off the seedlings as they emerge from the soil. Damage may also be done to larger seedlings by mammals which feed on the bark, roots, and leaves of the trees. Mammals usually cause more damage than birds in nurseries growing deciduous stock. Protection must be extended to include the seed and seedling stage in the nursery as well as in the heel-in ground.

FIELD MICE

Straw mulches used on seedbeds over the winter are especially attractive to mice and other rodents, as are the weeds and grass along fence rows. Population of rodents can be greatly reduced by burning out and destroying this vegetation. Among the genera of mice which make depredations on recently sown seed are various species of the white-footed field mouse (*Peromyscus*), meadow mice (*Microtus*), and the small, brown, pocket mice (*Perognathus*). These do most of their damage by digging up the seed in the rows shortly after it has been sown. Very often more damage is done by exposing the seed in this way or covering it too deeply than in the amount eaten. These mice are most easily controlled by means of grain or other baits poisoned with strychnine or other toxic agents, but the methods used for the different species should be governed by the differences in their feeding habits.

¹⁸ The section on mammals and birds constitutes a revision and enlargement of a chapter on rodent control prepared by Harold Haecker and F. E. Garlough, of the then Bureau of Biological Survey, in the manual "Seed and Nursery Practice in the Shelterbelt Project" mimeographed by the Forest Service March 23, 1936.

For the various species of *Peromyscus* and for the *Perognathus*, an effective bait has the following ingredients:

Powdered borax.....	2 ounces.
Powdered dry glucose (corn sugar).....	1 ounce.
Wheat flour.....	1 ounce.
Strychnine alkaloid.....	1 ounce.
Glycerin.....	2 ounces.
Steamed rolled oats or groats.....	12 pounds.
Boiling water.....	$\frac{3}{4}$ pint.
Cold water.....	$\frac{1}{4}$ pint.

Dissolve the borax and glucose in the boiling water. Mix wheat flour and strychnine and add the cold water. When well mixed stir into the boiling solution and heat until a thin, smooth paste is obtained. Stir in the glycerin and pour mixture over oats or groats and stir until the grain is uniformly coated.

Another satisfactory strychnine bait for the mice may be prepared by treating wheat, oat groats, or canary seed with the following preparation:

Strychnine sulfate.....	1 ounce.
Grain.....	8 pounds.
Oil of anise.....	$\frac{1}{4}$ ounce.
Heavy molasses.....	4 ounces.
Hot water.....	8 ounces.

Dissolve the strychnine in the hot water and pour this solution while hot over the grain, stirring thoroughly meanwhile. Mix the anise and molasses and pour over poisoned grain. Stir until the grain is well coated and allow to dry before packaging.

There are two ways of exposing the bait. Where there is plenty of grass or other vegetative cover and the mice have distinct runways on the surface of the ground beneath the cover, place a teaspoonful of the bait directly in the runway and cover well with grass. This offers the least disturbance to their natural habitat and the acceptance is the best. There is no danger to birds if bait is properly covered.

In some locations, however, it may be necessary to use a container for the bait to give proper cover, not only to prevent birds from gaining access to it but also to enable the mouse to feel protected while eating the bait, which is a vital factor in aiding acceptance. A simple, inexpensive mouse-bait container is the 1-quart can used for distributing motor oil. As usually discarded at the filling station, this can already has the proper size hole cut in the top. The side of the can on which the hole at the end is located should be crimped slightly to prevent the bait from coming out or water getting into it.

Another more expensive type of shelter is made of 20-gage galvanized sheet iron. Cut pieces 6 by 7 inches and roll these so as to make a channel 6 inches long, about 2 inches high, and 3 inches wide at the open side. A square or round pan 3 inches across and $\frac{1}{2}$ inch deep will serve to hold the bait. Place this pan along a runway and invert the channel over it as a cover.

Since the bait molds quickly in boxes or cans, baiting must be done frequently enough to keep fresh bait available.

In locations where the meadow mice will not take the baits mentioned above, expose pieces of apple. If this bait is taken, dust $2\frac{1}{2}$ quarts of $\frac{1}{2}$ -inch cubes of apple with $\frac{1}{4}$ ounce of powdered strychnine alkaloid and expose as described, putting out one piece at a place.

GROUND SQUIRRELS

The three species of ground squirrels (*Citellus* sp.) that have caused some damage in nurseries in the prairie plains are the Richardson ground squirrel or flickertail, the thirteen-lined ground squirrel, and the Franklin ground squirrel. Ground squirrels eat some seed, but most of the damage caused by them is through the burying of seed or seedlings with soil deposited at the surface of their burrows.

These pests may be completely controlled on small areas by shooting or catching them at the mouth of the burrow in No. 0 steel traps. As a bait method of control on larger areas, poisoned oats are especially effective. For safety, the control area should cover a strip extending about 100 yards past the outer boundaries of the nursery.

A satisfactory strychnine bait may be prepared from the following:

Strychnine alkaloid.....	1 ounce.
Powdered borax.....	2 ounces.
Wheat flour.....	1 ounce.
Powdered dry glucose (corn sugar).....	1 ounce.
Water.....	1¼ pints.
Glycerin.....	2 ounces.
Whole re-cleaned oats.....	15 pounds.

Blend the first four dry materials. Paste the mixture with ½ pint of cold water. Bring to a boil ¾ pint of water and stir in the paste, heating until a smooth mixture is obtained. Now add the glycerin and mix well. Pour this while hot over the grain and stir until the grain is completely coated. Allow to dry before sacking.

MOLES

Several species of moles (*Scalopus*) occur in the prairie-plains and have occasionally caused some loss in recently sown beds or seed rows, chiefly through caving-in of the tunnels under seed rows or drying-out of seedlings above the runways. They can be controlled by use of any one of several types of common steel traps on the market, working on the spear, loop, or jaw principle

POCKET GOPHERS

Pocket gophers (*Geomys* and *Thomomys*) can do considerable harm in a nursery by covering up parts of the seedling rows and by feeding on the roots. Their tunnels are excavated below the ground surface at a depth varying from 4 to 12 inches or more and are easily located by probing in the vicinity of the numerous mounds of earth thrown up at distances of a few yards to several rods. The gophers live almost exclusively below ground and traps and poison baits must be placed accordingly. The animals may be caught best with a regular pocket gopher trap.

Pocket gopher workings have a main runway and many short lateral tunnels from 1 to 3 feet long through which soil is brought to the surface to form a mound. If a mound is carefully examined it will be noted that there is a depression on one side and that the lateral connecting the mound to the main runway is on this side. The runway leading to a fresh mound should be opened, and if the lateral is long enough, a trap should be set in it. If the lateral is short, set a trap each way in the main tunnel. Leave the hole open, or cover it

with a handful of grass. When it is possible to determine the several mounds belonging to the same gopher system, set traps at only two or three or them. Whenever a fresh mound appears, immediately set a trap at it.

Pocket gophers may also be poisoned with a grain bait prepared as described for ground squirrels, save that wheat may be substituted for oats, and in Texas, milo may be used. If the grain bait is ineffective, a vegetable bait, such as sweetpotatoes or carrots, may be prepared, by cutting 16 quarts of the vegetable into pieces $\frac{1}{2}$ by $\frac{1}{2}$ by $1\frac{1}{2}$ inches and dusting evenly with 1 ounce of powdered strychnine alkaloid in a shaker-top can.

With a regular pocket gopher probe, find the underground runway by probing first 6 or 8 inches away from the mound on the side that shows where it was plugged; then drop through the probe hole one piece of the vegetable bait or a teaspoonful of the grain bait. Close the hole with something, being careful that dirt does not fall in and cover the bait. Endeavor to treat each system in about three places. It is a good policy to level off the mounds and check for fresh ones to determine effectiveness of the work.

RABBITS

The most troublesome rabbits are several species of the jack rabbit (*Lepus*) and the cottontail (*Sylvilagus*). The snowshoe rabbit has caused some damage in North Dakota in nurseries close to heavy brush and timber cover. Rabbit damage, which occurs mostly in winter and late spring when other food is scarce, consists in girdling of the bark or cutting off the tops of the seedlings. In some nurseries it has been quite a serious problem.

Rabbit damage can be prevented or minimized by protecting the nursery and heel-in beds with woven-wire fence. In the Dakotas, however, fencing has not been especially successful in nurseries, since the snow drifting over the fences has allowed the rabbits free entrance.

Cottontails and snowshoe rabbits have been successfully reduced in numbers by snaring and trapping, especially in brushy or timbered areas adjoining the nursery, and in runways in the nursery itself. These two species have a rather small daily migration radius, often less than one-quarter to one-half mile, and if the area adjacent to the nursery can be rid of the pests occasionally by snaring, trapping, and hunting, not much damage will occur.

Jack rabbits have a daily migration radius of several miles, and if hunting is resorted to, a large area must be covered to get adequate protection for the nursery itself. Very often they are hunted in drives in which 50 to 100 men participate. Systematic hunting by a few men, however, will do much to keep the pests in control around a nursery.

A number of poison baits have been found effective in rabbit control.

In spring and summer, jack rabbits will take poisoned salt which is mixed in the proportion of 3 pounds of salt, 1 pound of alfalfa meal, and 1 ounce of strychnine alkaloid. The material is thoroughly mixed, dampened with water, and placed in a hole bored into a 4-inch length of 2 by 4, the hole being $1\frac{1}{2}$ inches in diameter and $\frac{3}{4}$ inch deep. When the poison mixture has hardened, the wood blocks are placed around the nursery and in the tree rows. Extreme care should be taken that livestock does not get at the salt.

It has been observed that the set can be made more effective if the salt blocks are placed on flat-topped mounds of soil 1 foot high and 2 to 3 feet across at the top. These small "knolls" apparently attract the rabbits. The salt block should be staked down with a piece of No. 9 wire inserted through a small hole in the block. The salt should be cleansed occasionally of any soil which accumulates on it. This control method is most effective when the vegetation is green and succulent.

A good control method in winter is to use as bait ears of corn or heads of maize which have been treated with a strychnine material. The bait is tied or wired near a lath which is pushed into the snow so that the bait is a foot above the snow level. Bait so placed is not as easily covered by drifting snow as when placed on the ground.

The bait is prepared by making a paste consisting of 4 ounces of standard poison mixture (2 ounces of strychnine alkaloid, 2 ounces baking soda) stirred into a hot starch solution. Stir 2 tablespoons of gloss starch into 1 pint of cold water, add it to 3 pints of boiling water, and heat until the starch is clear. The ears of corn or heads of maize are dipped into this hot paste and allowed to drain. The same quantity of the starch paste applied to 24 quarts of whole oats makes a fairly effective bait. This may be exposed by placing tablespoonfuls at bait spots in the rabbit trails.

Regardless of which bait method of control is used, care should be taken that livestock or other animals and birds do not get the bait. Further, the dead rabbits should be collected frequently and buried in a deep pit to keep dogs or pigs from getting them.

It must be borne in mind that food habits of the various animal pests vary from season to season and from one locality to the next. Only a trial-and-error method based on experience will teach which bait is most acceptable at any one season of the year.

Before any poison campaign is started the State laws should be studied to determine if the procedure is legal. In most cases, adequate control by other means should be tried first.

BIRDS

Birds are not generally a serious problem in deciduous nurseries and usually do more good than harm, especially if a considerable part of their diet consists of insects and weed seeds. Birds may cause damage before germination by scratching out the seed and eating it, but they are more likely to nip and break the seedlings at time of emergence from the soil.

One of the most feasible methods of reducing bird damage, in some instances, is to fall-sow the seed. This results in earlier germination and very often the germination is completed by the time the main flight of certain species of migratory birds reaches the locality in which the nursery is located. In other instances it may be found desirable to delay sowing until the birds have passed on their way North.

One of the most feasible methods of coping with the problem is to have one or several men patrol the nursery area during the sowing and germination period. They should be equipped with guns and blank cartridges or with some other type of noisemaking device.

Very often it will be necessary to do hand weeding in nursery sowings when the seedlings are just emerging from the soil. The foreman of a weeding crew can often deploy his men over a considerable part of the block in which the weeding is done, and the presence of the men will keep the birds away. This method has a disadvantage in that it may be difficult to supervise the men properly.

Protection of conifer beds in a North Dakota nursery by setting wind-operated propellers on posts around the nursery proved moderately successful. Shiny pieces of tin were nailed to the blade and a noisemaking device was added, consisting of loose pieces of tin tied to a tin vane. The propellers were 16 to 24 inches long, fashioned from scraps of 2 by 4 material. This idea suggests the possibility of a "scarecrow" whose arms could be moved by a wind-operated propeller.

Screening, although entirely feasible for conifer beds, is impractical in a big deciduous-tree nursery except on a few species which are grown in beds on a small and intensive scale.

Shooting of the birds should be limited strictly to those species which are not protected by State or Federal law and which are considered in the "pest" category. This would usually include English sparrows, crows, ravens, and starlings.

PATHOLOGY OF DECIDUOUS SEEDLINGS ¹⁹

Since the comparatively recent establishment of large, Federal, deciduous nurseries, the diseases of broadleaf tree and shrub species have assumed considerable importance in some instances. Previously little consideration had been given to losses caused by damping-off fungi. Leaf diseases occurring on but few species were relatively unimportant in commercial nurseries where undersized seedlings could be readily carried over from year to year. The overwinter storage of large numbers of seedlings has also emphasized the importance of certain pathological troubles, particularly root rots, and the handling of tons of seed in storage has likewise revealed unusual problems. It is evident that considerable time will be required for research before entirely satisfactory remedial measures can be obtained for these different problems. The information presented here summarizes investigations covering five seasons.

SELECTION OF NURSERY SITES

Pathological problems can sometimes be avoided by careful selection of nursery sites. If time is available, it is advisable to determine the damping-off potentialities of a given soil by greenhouse and other tests. The information obtained can be used in determining the best nurseries for growing susceptible species, or for the elimination of undesirable areas. Careful inspection of prospective sites is always advisable to avoid lands infested with serious root diseases or liable to chlorosis. For example, the cotton root-rot disease of the Southwest is caused by the soil-inhabiting fungus *Phymatotrichum omnivorum* (Shear) Duggar. It is found only a few miles north of the Red River in Oklahoma but is common in Texas and States further

¹⁹ Discussion of pathology is contributed by Ernest Wright, associate pathologist, Division of Forest Pathology, Bureau of Plant Industry.

west. Many deciduous tree seedlings are susceptible to the cotton root-rot fungus; in fact, only a few are resistant to the disease. Nurseries should be located only on root-rot-free land found by previous survey to be well isolated from root-rot areas. The determination of the presence or absence of cotton root rot can be accomplished through the use of plant indicators as reported by Peltier (29).

By careful examination of the vegetation present on prospective nursery sites, other root diseases may also be avoided such as that caused by the shoestring fungus (*Armillaria mellea* (Vahl.) Fr.).

Nematodes, commonly called "eelworms," also present a considerable problem especially on the southern plains. Soils severely infested with nematodes should be excluded from nursery sites whenever possible. Here again, careful inspection of the site prior to the selection of the nursery is advisable. In such inspections, the roots of cultivated crops or native plants can be examined for indications as to whether nematode galls are present to any extent. Since some 1,200 species of plants are susceptible to infestation by nematodes, plant indicators are generally available that can be used to determine the severity of the infestation.

DAMPING-OFF

Both preemergence and postemergence damping-off losses have been frequent for certain deciduous species. The bulk of these losses occur just prior to or within 3 to 4 weeks after emergence and are due to soil-inhabiting fungi. In preemergence losses the seedlings fail to appear. The fungi may attack the seed directly or infect the recently germinated parts, preventing in either case the emergence of the seedlings. In postemergence damping-off the seedlings may fall over or remain erect and dry up. Sometimes there is a constriction of the stem at the ground line where infection takes place. Examinations of recently damped-off seedlings will show that a portion of the roots and stems are decayed. Generally preemergence losses are greater, but postemergence losses are more readily detected. Preemergence losses frequently exceed 60 percent of the seed sown, while postemergence losses at times run higher than 50 percent of the emerged seedlings. Later in the season these losses appear as gaps in the rows and are commonly referred to by nurserymen as "failed spots." Other factors besides damping-off can also cause these gaps, such as excessive heat, drought, birds, poor seed viability, too deep sowing, and caked soil.

The broadleaf seedlings most severely infected with damping-off fungi are American elm (*Ulmus americana*), Siberian elm (*U. pumila*), black locust (*Robinia pseudoacacia*), desertwillow (*Chilopsis linearis*), and several other somewhat minor species, such as silver buffaloberry (*Shepherdia argentea*) and honeysuckle (*Lonicera* spp.). Isolations from recently damped-off seedlings together with pathogenicity tests have shown that the most common fungous parasites of deciduous species in the prairie States are *Corticium solani* and *Pythium ultimum*.²⁰ Other fungi, particularly *Fusarium* spp., have been isolated, but their importance has not been determined.

²⁰ WRIGHT, ERNEST. DECIDUOUS-SEEDLING DISEASES IN MIDWEST NURSERIES. U. S. Bur. Plant Indus. Plant Dis. Rptr. 21: 80-82. 1937. [Mimeographed.]

There is little apparent correlation between soil acidity and damping-off losses. A soil which is neutral or only slightly acid is generally favorable for growing most broadleaf seedlings. There are indications, however, that the types of previous crop cover is correlated to some degree with the incidence of damping-off. Rotation of seedling crops from year to year is advisable. None of the susceptible species named should follow the next year on land previously occupied by any of these species. Cereals in general are more favorable rotation crops than legumes. Rye, however, is undesirable.

A practice occasionally followed by some nurserymen has been to mark the rows where the deciduous seed is sown by mixing it with faster germinating truck crop seed. Lettuce, radish, and turnip seed have been used for this purpose. While this method is readily applicable to nursery procedure and does aid in locating the rows for cultivation and weeding prior to the emergence of the tree seedlings, the use of truck crops is questionable. Unfortunately, most truck crops are susceptible to the same damping-off fungi that commonly attack deciduous tree seedlings, and they may, therefore, increase the losses in the latter by building up the parasitic fungous population in the seed drills. If it is desirable to mark the rows in this way, both field and greenhouse tests indicate that wheat seed could be more safely used.

It is imperative to avoid injury to the cotyledons of the seedlings during cultivation or in crust-breaking operations just prior to emergence of the seedlings. Preliminary trials under controlled conditions indicate that injury to the cotyledons of emerging deciduous seedlings stunts the growth of the plants. Severe injury to the cotyledons frequently kills the seedlings. Any reduction in the vigor of the seedlings is always undesirable.

In general, too dense or overdeep sowing increases both preemergence and postemergence damping-off losses. Dense sowings may also aid in the rapid spread of fungi through the tops of the seedlings during wet weather.

So far it has not been necessary to artificially fertilize the soil in broadleaf nurseries, but no doubt this will be required in the near future. It has been reported that nitrates and ammonium salts increase the damping-off hazard of conifers (42, 14). A similar correlation may exist for broadleaf species. Fertilizers should therefore not be applied indiscriminately in broadleaf nurseries until it is determined what the effect will be on increasing damping-off and root rots. Preliminary tests, however, indicate that if the application of ammonium sulfate or ammonium nitrate is reduced to 100 pounds per acre, or if the application is delayed until the seedlings develop woody stems, the addition of fertilizing material does not increase damping-off losses.

Methods for controlling damping-off of deciduous tree seedlings necessarily must differ from those applied in coniferous nurseries, since broadleaf seedlings are usually grown in rows in open fields over extensive areas and are not confined to seedbeds. Many methods applicable to coniferous seedbeds therefore cannot be applied economically to deciduous seedling nurseries.

Prompt emergence is of importance in reducing preemergence losses. Presoaking the seed in water sometimes accelerates germi-

nation and may be helpful for some species in reducing damping-off losses.

It has been found that certain seed dusts are fairly effective in reducing preemergence damping-off. The most satisfactory dust so far used has been zinc oxide, applied at the rate of 2 ounces per pound of air-dried seed (not green or wet seed). The kind of zinc oxide is very important since not all sources have proved equally satisfactory. Further advice should be secured from plant pathologists before attempting extensive treatments. Copper oxide is also fairly effective in controlling preemergence damping-off losses, but broadleaf species have been found to be susceptible to injury by this dust. American elm is especially susceptible to injury, while Siberian elm is somewhat less detrimentally affected, perhaps because of its more rapid germination. Copper oxide appears to retard germination of desertwillow seed only slightly and has been found effective in controlling pre-emergence losses for this species in greenhouse tests. For desert-willow, however, commercial dry bordeaux mixture, applied at the rate of 2 ounces per pound of dry seed, is probably safer and is just as effective in controlling preemergence damping-off as copper oxide. Field trials in Texas have substantiated the greenhouse results. Formaldehyde seed dusts applied at time of sowing have proved unsatisfactory both in the greenhouse and in field tests. None of the seed dust treatments can be considered entirely satisfactory, since they fail to retard postemergence damping-off losses. Mixing the dusts directly with the soil is a more satisfactory treatment but is costly for large areas.

Formaldehyde soil treatments are quite effective on sandy soils in controlling both preemergence and postemergence damping-off losses but in general are too costly and cumbersome for the extensive operations of the present Federal deciduous seedling nurseries. For seedlings grown in small beds, commercial formaldehyde used at the strength of 1 part in 50 parts of water, applied at the rate of 1 pint per square foot 10 days prior to sowing, has given satisfactory results.

Taking all factors into consideration, such as cost, ease of application, and final results, it appears at this time that the most practical method of controlling preemergence damping-off losses of deciduous tree seedlings is by the use of zinc oxide as a seed dust. Desert-willow is an exception, and commercial bordeaux dust mixture is recommended for this species. No satisfactory method for controlling postemergence losses over large areas has yet been developed.

Root Rot

Some root rots (sometimes referred to as "late-damping-off") are difficult if not impossible to avoid, even by the most careful selection of nursery sites. The so-called late root-rotting fungi are referred to here. They are unusually widespread and do not necessarily infect indicator plants. Seedlings up to several months old are still subject to late root rot. In such cases the plants do not damp-off since the stems are now strengthened by the formation of woody tissues. Typical symptoms are indicated by a drying and curling-up of the leaves, usually followed eventually by a wilting of the tops and the death of the seedlings, although sometimes the plants survive but are badly stunted.

Late root rot so far has occurred in the Great Plains region only in northern nurseries on comparatively heavy soils. *Corticium solani* has been found in association with a late root rot of *Caragana arborescens*. The tips of the tap roots and many small lateral rootlets were rotted back and destroyed, resulting in a heavy mortality for seedlings several weeks old. At another nursery the roots of sumac (*Rhus trilobata*) showed similar symptoms, but a *Fusarium* was commonly isolated. At still another nursery, Siberian elm making unsatisfactory growth showed stem lesions at the ground line, but only apparent saprophytes could be isolated from the decaying parts.

No definite control measures are yet known, but it appears that the overabundance of organic matter and poor aeration are probably factors contributing to an increase of late root-rot infections.

LEAF DISEASES

Leaf diseases in general reduce the rate of growth and subsequently interfere with food reserves. In orchard trees, for example, it is known that where leaf spots have been severe the trees are frequently damaged by frost and drought. The impoverished fruit trees are unable to resist adverse conditions in the field as well as normal trees. In the nursery where the food-synthesizing activity of the leaves is retarded because of leaf diseases, the growth of the seedlings is frequently reduced so much that they do not reach usable size by the end of one growing season. When the seedlings do reach usable size the decreased food storage may limit the ability of the tree to produce roots after field planting. Leaf diseases are, therefore, of considerable economic importance and the nurseryman should not be misled by the fact that the plants do not appear to be seriously injured. Fortunately, not many broadleaf species have serious leaf diseases. Chokecherry, other species of *Prunus*, and species of ash are the most susceptible to leaf diseases in the Great Plains region.

Chokecherries (*Prunus virginiana* and *P. virginiana melanocarpa*) are commonly infected with a leaf spot disease caused by *Coccomyces lutescens* Higgins. This disease is referred to as shot hole. Infections first appear upon the foliage as small yellow or reddish circular spots which later turn brown. Eventually the dead brown spots may become separated from the surrounding leaf tissue and fall out, producing the typical shot hole. In severe stages, the disease causes a yellowing of the tissues between the lesions, giving the infected foliage a striking chlorotic appearance and causing the leaves to fall prematurely. The lower leaves usually fall first. Black cherry (*P. serotina*) is perhaps even more susceptible to shot hole than chokecherry, but American plum (*P. americana*) appears quite resistant.

The serious nature of the shot hole disease on species of *Prunus* necessitates from five to seven spray applications for control. Home-made bordeaux spray used as a 3-4-50 mixture²¹ appears to give satisfactory control when applied early in the season and repeated at frequent intervals of a week or 10 days²² in Midwest nurseries. For the concentrated bordeaux powders now on the market, directions

²¹ 3 pounds copper sulfate and 4 pounds rock lime to 50 gallons of water. For the rock lime, 5 pounds of the more generally available hydrated lime may be substituted.

²² YOUNG, GEORGE Y. SPRAYING AS A CONTROL OF LEAF DISEASES ON NURSERY STOCK OF FRAXINUS AND PRUNUS SPECIES IN THE UPPER MISSISSIPPI VALLEY. Soil Conserv. Serv. 1939. [Unpublished memorandum.]

given by the manufacturers to obtain a solution equal in strength to a 3-4-50 home-made mixture should be used. McNew and Bliss (25) in Iowa recommend a 4-6-50 mixture for commercial cherry varieties. It is essential in any case to spray as soon as the leaves appear and repeat the applications throughout the growing season, especially following rains. Spreaders are sometimes recommended for better coverage and adhesiveness. Whale-oil soap, casein, linseed oil, and a good grade of soap chips are sometimes used as spreaders. The first two are used at the rate of about 2 pints in 50 gallons of spray solution, while the last two require about 5 pints or pounds per 50 gallons. A good emulsion is required for best results. Skim milk used at the rate of 1 gallon in 50 gallons of spray solution is a cheap and effective spreader.²³

In other sections of the country it has been reported that the bordeaux concentrations advised above have caused severe burning of the foliage. It is likewise essential to maintain the vigor of the seedlings since there are some indications that the addition of nitrogenous fertilizers and adequate water appear to render the seedlings less susceptible to leaf diseases.

Spray applications made after the shot hole appears will not control the disease on infected leaves. Late spray applications appear to retard the infection of new leaves, but early and repeated applications are necessary for really satisfactory results.

It is known that the fungus overwinters on dead leaves and it is advisable, therefore, to dispose of the fallen leaves in the nursery by burning or by plowing the leaves under in the fall. Susceptible species should not be sown on the same ground the following year. It is also desirable to strip all leaves from the seedlings at time of bundling to prevent carrying the disease to the field where the seedlings are planted.

The rust *Tranzschelia punctata* has been observed on *P. americana* but only to a limited extent.

A leaf disease of green ash (*Fraxinus pennsylvanica lanceolata*) is quite common in the Midwest, especially in northern nurseries. This disease is referred to by nurserymen as leaf rust. It is not a true rust, however, since it is caused by *Marsonia* sp. It is most evident in mid to late summer when the upper surface of the leaves assume a rustlike appearance. By close examination small black spots will be found on the under surface of infected leaves. These are the fungus fruit bodies.

The disease causes premature defoliation resulting in decreased growth. This is very undesirable for green ash since it is not a rapid growing species in northern nurseries even under normal conditions.

So far, spraying with lime sulfur and bordeaux of various concentrations have given somewhat disappointing results in the control of this disease; however, spraying operations are rarely started early enough or repeated consistently enough for satisfactory results. Numerous applications of bordeaux spray, as suggested for choke-cherry above, probably will give satisfactory control.

It is further suggested that green ash seedlings should be grown in a portion of the nursery as far removed from older green ash trees as practicable. The amount of local infection can be reduced by

²³ DAVIS, W. C., YOUNG, G. Y., LATHAM, D. H., AND HARTLEY, CARL. DISEASES OF CONIFERS IN FOREST NURSERIES. U. S. BUR. OF PLANT INDUS. 1938. [MIMEOGRAPHED.]

cleaning up the fallen leaves underneath older trees nearby and in the nursery. The mixing of green ash with chokecherry within the same row or in alternate rows may also reduce the amount of the disease. Both species need to be sprayed and the mixing of the green ash and chokecherry reduces the facility of spread of the disease, since neither tree species is susceptible to the other's leaf disease. Good fertility and adequate watering also appear to reduce the amount of infection.

Puccinia periodermospora (Ellis. and Tr.) Arth., a true rust, occurs occasionally on green ash. Regular spraying of green ash and American plum with bordeaux should likewise aid in controlling true rusts which occur occasionally but generally are not serious in the Great Plains region.

The leaf disease of American elm, *Gnomonia ulmea* (Sacc.) Thuem., which is quite common in the Gulf region and Eastern States, has not been observed in Great Plains nurseries and need not be considered in detail here. The appearance of any sudden dying of American elm should be reported immediately, since this species is infected by several virulent parasites in other sections of the country (8).

TOP BLIGHTS AND WILTS

Under the dry climate of the Great Plains area where water is usually supplied by furrow irrigation, top infections of seedlings have not been as common as further east. Conditions of high humidity and excessive moisture may cause considerable loss. At North Platte, Nebr., in the spring of 1937, black locust and Osageorange seedlings were infected with a *Corticium* top blight following heavy rains. Typically, top blight leads to a rapid wilting of the seedlings. The serious seedling top infection of black locust caused by *Phytophthora parasitica* Dastur as reported by Lambert and Crandall (19) has not been observed in the Great Plains nurseries.

Top blights are difficult to control once infection takes place. Conditions which lead to poor aeration and high humidity should be avoided when possible. Less dense sowing and adequate soil drainage will reduce losses from top infections.

Mulberry blight demands special mention, as it sometimes causes much damage in the Southwest and has been observed as far north as Fremont, Nebr. Russian mulberry (*Morus alba tatarica*) seedlings and older trees are known to be infected with this bacterial blight, caused by *Phytomonas mori* (Boyer and Lamb.) Bergeye, et al. Young seedlings first show the disease by the appearance of water-soaked areas at the tips of the cotyledons which soon become withered and dried. Frequently the infection extends down the petioles into the stem, causing the seedlings to wilt over and die. The top of the stem at first becomes withered while the base and the roots remain healthy.

Black lesions are also formed on the leaf petioles and stems of older plants. These later develop into typical cankers which often split open and exude the bacteria in yellowish droplets. Old cankers sometimes become deep enough to expose the pith.²⁴

²⁴ Summary of unpublished report by Howard Lamb dated September 1935, Woodward, Okla.

The manner in which the disease is spread is not definitely known. In greenhouse tests at Lincoln, Nebr., no bacterial blight was observed on the seedlings grown from southern mulberry seed sown in different soils, including those from Oklahoma and Texas. The indications are that the bacterium is probably disseminated by wind and rain more commonly than by seed, but insects may also act as carriers. A combination of all four ways is possible. It has been observed, however, in the field that the heaviest infection of mulberry seedlings commonly occurs adjacent to older mulberry plantings, which tends to verify the statement that seed-borne dissemination of the disease is of minor importance. Seed should not be collected, however, from obviously diseased trees. It is advisable to locate the mulberry seedlings in a part of the nursery as far removed as practicable from older mulberry plantings.

The dusting of mulberry seed with bordeaux and zinc oxide dusts in field trials has failed to give satisfactory results. It appears advisable to spray the seedlings regularly with bordeaux of the 4-6-50 strength in nurseries where the disease has appeared. Spraying should be started just as soon as the cotyledons appear above the soil and should continue at intervals for several weeks. Spraying is especially desirable following rains. Reducing the density of the seedlings per unit area should aid in preventing a rapid spread of the disease from plant to plant.

MISCELLANEOUS DISEASES

Dodder (*Cuscuta* sp.) is not a fungus but a flowering plant related to the morning-glory family, nevertheless a true parasite of other plants. Dodder has caused some damage to tree seedlings and has been found growing on black locust, green ash, cottonwood and desertwillow in Midwest nurseries. It appears as a fine, yellow, vinelike growth, sometimes occurring so dense as to completely cover the tops of the seedlings. It spreads by seed or directly from seedling to seedling.

The embryonic *Cuscuta* plantlet, coiled up in the seed, pushes up through the ground in early spring, but makes little use of its cotyledons as a means of nourishment. No underground root system develops from the young rootlet which soon dies. The dodder seedling early develops into a long, thin filament, the free end of which is for contacting plants from which nourishment is obtained (37, pp. 189-190). A direct connection forms between the conducting vessels of the host and those of the parasite as the vine coils around the parasitized plant. The organs of connection are known as "haustoria." The sapping of water and nourishment from the host plant causes a stunted growth of infected seedlings, and heavy infection may kill the host plant.

Dodder can be removed from the seedlings with a rake similar to a currycomb which may be made by driving nails through a board to which a handle is fastened. Upon removal from the plants, the dodder should be destroyed by burning. Sometimes it spreads from native vegetation at the margins of a nursery. Cleaning away the native vegetation, creating a barren border around the nursery, would be good insurance against widespread infection. Dodder can also be introduced with rotation crop seed and care should be taken to use cleaned seed.

A condition generally referred to as "chlorosis" has been observed on some sites, where several broadleaf species have shown a characteristic yellowing or mottling of the leaves accompanied by a stunted growth. A rosettelike growth and a streaking of the leaves are also sometimes observed. This condition is commonly attributed to the lack or non-availability of iron, but it may be associated with a deficiency or an excess of any one of a number of elements such as nitrogen, phosphorus, manganese, zinc, or magnesium.

Hardy catalpa (*Catalpa speciosa*) and black locust appear to be especially susceptible to chlorosis, particularly on sandy soils. Several iron compounds have been used in periodic sprayings in an attempt to correct the chlorotic condition of these two species in an Oklahoma nursery. Ferric citrate, ferric tartrate, and ferrous sulfate were used as spray solutions and were applied at the strengths of 1, 3, 5, 7, and 10 percent. No noticeable changes were effected by the 1 and 3 percent sprays, while the 5 percent solution caused some slight improvement. The 7 and 10 percent sprays burned the catalpa leaves but did not appear to have either a detrimental or beneficial effect on the foliage of black locust. A soap spreader was used in these spray tests. Ferrous sulfate is ordinarily not as safe as ferric citrate or ferric tartrate, and even at 1-percent strength has been known to burn the leaves of some tree species.

In a northern nursery a chlorotic yellowing of American elm leaves was corrected by deep cultivation. This occurred on a heavy soil where apparently aeration was insufficient for normal growth.

The most satisfactory solution to the problem is to locate the species susceptible to chlorosis on areas where this condition is found to be uncommon. Soil acidification is also said to eliminate chlorosis but is generally not practical for large areas in the Great Plains region.

STORAGE PROBLEMS

One of the most difficult seedlings to handle under inside storage conditions is the Siberian elm. This is due to the fact that the Siberian elm roots are commonly affected by a black rot. The occurrence of this root rot in the Great Plains region was first reported in 1935 (18). The causal organism is *Chalaropsis thielavioides* Peyron. Original infections appear to take place in the seedbeds and spreads rapidly under improper storage conditions or during transit. A grayish white, moldlike growth is characteristically found at injuries or broken places on the roots. The outer root tissues become dark brown to black and are broken down to a slimy mass as the rot advances. The roots of the infected plants in the nursery row usually show only blackened, decayed areas.

A large number of chemical dips have been experimented with in an attempt to control the spread of this rot during inside storage. So far no completely satisfactory chemical control has been found, although sodium perborate at a concentration of 1-35 gave the best control of any of the dips used.

The most satisfactory means of controlling the root rot is to heel-in the seedlings in sand or sandy soil out of doors over winter, protecting the tops with a straw mulch when necessary. Heeling-in the seedlings in heavier soil has not proved satisfactory even when the roots have been previously dipped in chemical solutions. The advantage of sand

over soil is apparently due to better drainage than is obtainable in heavier soil types. Considering the danger of injury from some chemical dips and also the fact that the roots are more moist than normal after dipping, chemical dips used prior to heeling-in the seedlings in sand have been found unnecessary. Heel-in sites should be rotated from year to year. In the southern plains, Siberian elm seedlings can best be left in the nursery row over winter and lifted as needed.

It takes only a short time for the rot to spread rapidly under conditions favorable to its development, and special effort should be made to plant the Siberian elm seedlings as soon as possible after they have been removed from the heel-in beds in the spring. While this rot is not so active as to destroy the value of the seedlings, it has been found that it does retard early foliage development. The uninfected or slightly infected plants leaf out earlier than those which have severely rotted roots. This is of considerable importance because the most rapid root growth of the seedlings takes place early in the season, and delayed growth may interfere seriously with the winter hardiness or drought resistance of the trees, due to the lack of adequate food storage.

For overwinter storage of other broadleaf species, the seedlings can be heeled-in in sandy soil out of doors and the tops protected with straw as recommended for Siberian elm.

NURSERY COSTS

The cost of growing nursery stock depends on the size of the nursery, irrigation facilities, the number of species grown, and other variable factors such as seed costs, age class of stock, and grading standards.

Costs are invariably higher for species which are grown in small numbers, and lower for those nurseries in which the nurseryman can concentrate his efforts on maximum efficiency in large-scale production of a relatively few species. Disease, insects, and unfavorable climatic conditions are other factors which may increase cost in spite of all the nurseryman's efforts to keep losses at a minimum.

Experience has shown that nurseries in the plains region which are not protected by an irrigation system often suffer severe losses in drought years. Such losses occur either in the form of complete killing of the plants, or in very high nursery costs because of reduced growth rate of the stock to such an extent that 80 or 90 percent does not attain plantable size.

It has been argued, in some instances, that, regardless of the severity of drought, nursery stock for plains planting should be grown only under dry-land conditions without irrigation or watering, on the ground that trees that cannot survive in the nursery would certainly not survive in the field. This argument loses force when examined critically. In the first place, field-planted stock, because of a much wider spacing, has a maximum of anywhere from 24 to 96 square feet of growing space per plant, while in the nursery each seedling has only from $\frac{1}{3}$ to $\frac{1}{2}$ square foot of growing space per plant. Secondly, sturdy, well-rooted nursery stock planted on typical field sites for shelterbelts can root deeper by midsummer and consequently draw moisture from greater depths than small seedlings. It has been clearly demonstrated that field survival is closely correlated with the size of stock at time of planting. Again, if soil moisture content drops very low in the nursery owing to lack of irrigation, the stock produced will be much

smaller than normal, and a rather high cull percent will result. A low production of usable trees will result in an excessively high cost per thousand for the plantable trees. Consequently, an adequate irrigation system is a prime essential to uniform production of high quality nursery stock at minimum cost, and over a period of years will pay for itself many times.

In the Federal nurseries in the plains region, it has been found that the cost of 2-year-old stock is only about 25 percent higher than the cost of 1-year-old stock. This narrow margin is due largely to the fact that blocks of 2-year-old stock invariably run considerably higher in production of usable stock per acre.

The costs of seed and of 1-0 stock in several Federal nurseries in South Dakota and Nebraska are given in table 26.

TABLE 26.—Average seed and nursery costs in several nurseries in South Dakota and Nebraska

Species	Cost of clean seed per pound	Cost of 1-0 ² nursery stock per M	Species	Cost of clean seed per pound	Cost of 1-0 ² nursery stock per M
Green ash.....	\$0.37	\$5.38	Plum.....	\$0.76	\$7.82
American elm.....	.24	4.87	Russian-olive.....	.29	8.06
Chinese elm.....	¹ 2.44	6.65	Honeylocust.....	.49	6.75
Hackberry.....	.58	5.93	Bur oak.....	.07	10.64
Siberian pea-tree.....	¹ 1.89	4.94	Catalpa.....	1.06	3.67
Chokecherry.....	.78	11.11	Osageorange.....	1.02	5.52

¹ Collection costs abnormally high because of poor seed crop. Collection of seed in good years will cost not over 20 to 30 percent of the figures given.

² 1-year seedlings not transplanted before field planting.

These costs, of course, apply to actual costs as obtained for government nurseries and are not to be regarded as a yardstick for selling price of seed or nursery stock by commercial concerns, which have advertising and sales costs, local, State, and Federal taxes, and other costs to meet. Moreover, commercial nurserymen must also consider fluctuating market demands and make allowance for margin of profit.

The costs of stock given in table 26 include all expenses involved in growing, digging, and shipping the stock, such as cost of seed, labor, land rental, supervision, equipment operation and depreciation, supplies, and proportionate share of state and regional overhead. The costs of stock are considered good averages for normal conditions, except in the case of chokecherry, which is high because of loss due to the shot hole disease which is somewhat difficult to detect in time to apply effective remedial sprays.

The above costs are on the basis of production of usable seedlings, that is, stock which is at least $\frac{1}{32}$ -inch caliper at the root collar. Trees below that size, and not carried over in the nurseries for an additional year, were discarded, and consequently bear no part of the cost. The minimum acceptable specifications of nursery stock will markedly affect cost, because with the rigid grading specifications used by the Forest Service, the percent of cull in the average block of broadleaf nursery stock often runs from 20 to 50 percent. Any reduction in the grading standard cited above will result in lower cost per thousand, but cost of stock is not the most important consideration in successful shelterbelt planting. The goal of all Forest Service planting in the prairie-plains is to obtain a minimum cost per surviving

tree, and to obtain a consistently good growth and high survival of shelterbelts, even in periods of subnormal rainfall. Too much emphasis cannot be placed on attaining this goal, because nothing will stimulate more interest in planting and care of farmstead plantings and shelterbelts in the plains region than the presence in each county of a number of thrifty, well-planned belts of fast-growing trees planted with the best technical guidance that Federal and State agencies can give.

LITERATURE CITED

- (1) BATES, C. G.
1930. THE PRODUCTION, EXTRACTION, AND GERMINATION OF LODGEPOLE PINE SEED. U. S. Dept. Agr. Tech. Bul. 191, 92 pp., illus.
- (2) BOUYOUCOS, GEORGE JOHN.
1937. EVAPORATING THE WATER WITH BURNING ALCOHOL AS A RAPID MEANS OF DETERMINING MOISTURE CONTENT OF SOILS. Soil Sci. 44: 377-384, illus.
- (3) ———
1938. A RAPID METHOD FOR DETERMINING THE PERMANENT WILTING POINT AND FOR INDICATING UNDER FIELD CONDITIONS THE RELATION OF SOIL MOISTURE THERETO. Soil Sci. 45: 47-55, illus.
- (4) BRACKETT, E. E., AND LEWIS, E. B.
1933. PUMP IRRIGATION INVESTIGATIONS IN NEBRASKA. Nebr. Agr. Expt. Sta. Bul. 282, 31 pp., illus.
- (5) BREAZEALE, J. F.
1926. ALKALI TOLERANCE OF PLANTS CONSIDERED AS A PHENOMENON OF ADAPTATION. Ariz. Agr. Expt. Sta. Tech. Bul. 11, 19 pp., illus.
- (6) ——— and MCGEORGE, W. T.
1932. NUTRITIONAL DISORDERS IN ALKALINE SOILS AS CAUSED BY DEFICIENCY OF CARBON DIOXIDE. Univ. Ariz. Tech. Bul. 41, 153 pp., illus.
- (7) BRIGGS, LYMAN J., AND SHANTZ, H. L.
1912. THE WILTING COEFFICIENT FOR DIFFERENT PLANTS AND ITS INDIRECT DETERMINATION. U. S. Dept. Agr., Bur. Plant Indus. Bul. 230, 83 pp., illus.
- (8) CARTER, J. C.
1939. PROGRESS IN THE CONTROL OF ELM DISEASES IN NURSERIES. Ill. Nat. Hist. Survey, Biol. Notes 10, 19 pp.
- (9) CHAPMAN, A. G.
1936. SCARIFICATION OF BLACK LOCUST SEED TO INCREASE AND HASTEN GERMINATION. Jour. Forestry 34: 66-74, illus.
- (10) EWING, PAUL A.
1934. PUMPING FROM WELLS FOR IRRIGATION. U. S. Dept. Agr. Farmers' Bul. 1404, 28 pp., illus. (Revised.)
- (11) FLEMION, FLORENCE.
1938. A RAPID METHOD FOR DETERMINING THE VIABILITY OF DORMANT SEEDS. Boyce Thompson Inst. Contrib. 9: 339-351, illus.
- (12) GEORGE, ERNEST J.
1937. STORAGE AND DEWINGING OF AMERICAN ELM SEED. Jour. Forestry 35: 769-772.
- (13) GIERSBACH, JOHANNA, AND CROCKER, WILLIAM.
1932. GERMINATION AND STORAGE OF WILD PLUM SEEDS. Boyce Thompson Inst. Contrib. 4: 39-51, illus.
- (14) HARTLEY, CARL.
1921. DAMPING-OFF IN FOREST NURSERIES. U. S. Dept. Agr. Bul. 934, 99 pp., illus.
- (15) HAYES, F. A., AND STOECKELER, J. H.
1935. SOIL AND FOREST RELATIONSHIPS OF THE SHELTERBELT ZONE. U. S. Forest Serv., Possibilities of Shelterbelt Planting in the Plains Region, sect. 12, pp. 111-153, illus.
- (16) HILGARD, E. W.
1931. SOILS. . . . Rev. ed., 593 pp., illus. New York and London.
- (17) HURST, W. M., HUMPHRIES, W. R., AND MCKEE, ROLAND.
1935. BARREL AND DISK SEED SCARIFIERS. U. S. Dept. Agr. Cir. 345, 24 pp., illus.

- (18) LAMB, HOWARD, WRIGHT, ERNEST, AND DAVIDSON, ROSS W.
1935. A ROOT ROT OF CHINESE ELM. (Note) *Phytopathology* 25: 652-654.
- (19) LAMBERT, EDMUND B., AND CRANDALL, BOWEN S.
1936. A SEEDLING WILT OF BLACK LOCUST CAUSED BY *PHYTOPHTHORA PARASITICA*. *Jour. Agr. Res.* 53: 467-476, illus.
- (20) LAURIE, ALEX, AND CHADWICK, L. C.
1931. THE MODERN NURSERY, A GUIDE TO PLANT PROPAGATION, CULTURE AND HANDLING. 494 pp., illus. New York.
- (21) LIVINGSTON, BURTON E., AND KOKETSU, RICHIRO.
1920. THE WATER-SUPPLYING POWER OF THE SOIL AS RELATED TO THE WILTING OF PLANTS. (Abstract) *Soil Sci.* 9: 469-485.
- (22) ——— AND NOREM, W. LUTHER.
1937. WATER-SUPPLYING POWER AND WATER-ABSORBING POWER OF SOILS AS RELATED TO WILTING OF WHEAT AND COLEUS IN GREENHOUSE POT CULTURES. *Soil Sci.* 43: 177-204, illus.
- (23) McGEORGE, W. T.
1935. SOME ASPECTS OF CITRUS DECLINE IN ARIZONA. *Calif. Citro.* 20: 214-216.
- (24) McKEEVER, DONALD G.
1937. A NEW BLACK LOCUST SEED TREATMENT. (Note) *Jour. Forestry* 35: 500-501.
- (25) McNEW, GEORGE L., AND BLISS, DONALD E.
1935. CONTROL OF CHERRY YELLOW-LEAF ON NURSERY STOCK. *Iowa Agr. Expt. Sta. Bul.* 332: 155-184, illus.
- (26) MEGINNIS, H. G.
1937. SULPHURIC ACID TREATMENT TO INCREASE GERMINATION OF BLACK LOCUST SEED. *U. S. Dept. Agr. Cir.* 453, 35 pp., illus.
- (27) OLSON, D. S.
1930. GROWING TREES FOR FOREST PLANTING IN MONTANA AND IDAHO. *U. S. Dept. Agr. Cir.* 120, 92 pp., illus.
- (28) PARKER, JIM.
[1931.] HOW TO GROW FRUITS AND FLOWERS IN OKLAHOMA AND THE SOUTHWEST. . . . 216 pp., illus. Oklahoma City.
- (29) PELTIER, GEORGE L.
1937. DISTRIBUTION AND PREVALENCE OF OZONIUM ROOT ROT IN THE SHELTER-BELT ZONE OF TEXAS. *Phytopathology* 27: 145-158, illus.
- (30) PHILLIPS, GEORGE R.
1931. COLLECTION, CARE AND PLANTING OF TREE SEEDS. *Okla. Forest Serv. Pub.* 10, 16 pp., illus.
- (31) RIFFENBURG, H. B.
1925. CHEMICAL CHARACTER OF GROUND WATERS OF THE NORTHERN GREAT PLAINS. *U. S. Geol. Survey Water-Supply Paper* 560: 31-52, illus.
- (32) ROGERS, W. S.
1935. A SOIL MOISTURE METER DEPENDING ON THE "CAPILLARY PULL" OF THE SOIL. . . . *Jour. Agr. Sci.* 25: 326-343, illus.
- (33) SCOFIELD, CARL S.
1926. ALKALI IN IRRIGATED DISTRICTS. *U. S. Dept. Agr. Yearbook* 1926: 142-145.
- (34) STEINBAUER, C. E., AND STEINBAUER, G. P.
1931. THE EFFECTS OF TEMPERATURE AND DESICCATION DURING STORAGE ON GERMINATION OF SEEDS OF THE AMERICAN ELM (*ulmus americana* L.). *Amer. Soc. Hort. Sci. Proc.* 28: 441-443.
- (35) STEWART, GILBERT I.
1934. THE USE OF SHALLOW WELLS IN FOREST FIRE SUPPRESSION. *Mich. Dept. Conserv.*, 64 pp., illus.
- (36) STOECKELER, J. H., AND BASKIN, L. C.
1937. THE DENBIGH DISC SCARIFIER, A NEW METHOD OF SEED TREATMENT. *Jour. Forestry* 35: 396-398, illus.
- (37) STRASBURGER, EDUARD.
1921. STRASBURGER'S TEXT-BOOK OF BOTANY. Ed. 5, rev., 799 pp., illus. London.
- (38) TOUMEY, J. W[illiam].
1921. ON THE LIABILITY [VIABILITY] OF TREE SEEDS AFTER STORAGE FOR TEN YEARS. *Jour. Forestry* 19: 814.

- (39) VAN SLYKE, LUCIUS L.
1932. FERTILIZERS AND CROP PRODUCTION. 493 pp., illus. New York.
- (40) VOORHEES, EDWARD B., AND HASKELL, SIDNEY B.
1926. FERTILIZERS; THE SOURCE, CHARACTER AND COMPOSITION OF FERTILIZER MATERIALS . . . Ed. 2, rev., 310 pp., illus. New York.
- (41) YERKES, GUY E.
1932. PROPAGATION OF TREES AND SHRUBS. U. S. Dept. Agr. Farmers' Bul. 1567, 52 pp., illus. (Revised.)
- (42) YOUNG, GEO. Y., DAVIS, W. C., AND LATHAM, D. H.
1937. CONTROL OF DAMPING-OFF OF CONIFERS. (Abstract) Phytopathology 27: 144.

ADDITIONAL REFERENCES

- CHADWICK, L. C.
1936. IMPROVED PRACTICES IN PROPAGATION. [Reprinted from Amer. Nurseryman 62(8): [3]-4, (9): 5-6, (10): 7-8, (12): [3]-9. 1935.]
- DILLMAN, ARTHUR C.
1931. THE WATER REQUIREMENT OF CERTAIN CROP PLANTS AND WEEDS IN THE NORTHERN GREAT PLAINS. Jour. Agr. Res. 42: 187-238, illus.
- HOPPER, T. H., NESBITT, L. L., AND PINCKNEY, A. J.
1931. THE CHEMICAL COMPOSITION OF SOME CHERNOZEM-LIKE SOILS OF NORTH DAKOTA. N. Dak. Agr. Expt. Sta. Tech. Bul. 246, 72 pp., illus.
- LYON, T. LYTTLETON, FIPPIN, ELMER O., AND BUCKMAN, HARRY O.
1915. SOILS, THEIR PROPERTIES AND MANAGEMENT. 764 pp., illus. New York.
- RABER, ORAN.
1937. PRINCIPLES OF PLANT PHYSIOLOGY. Rev. ed., 432 pp., illus. New York.
- RAFN, JOHANNES.
1915. THE TESTING OF FOREST SEEDS DURING 25 YEARS, 1887-1912. 91 pp., illus. Copenhagen.
- SMITH, ERWIN F.
1920. AN INTRODUCTION TO BACTERIAL DISEASES OF PLANTS. 688 pp., illus. Philadelphia and London.
- STOECKELER, J. H.
1937. RELATION OF SIZE OF DECIDUOUS NURSERY STOCK TO FIELD SURVIVAL IN THE GREAT PLAINS. Jour. Forestry 35: 773-777, illus.
- TILLOTSON, C. R.
1932. GROWING AND PLANTING HARDWOOD SEEDLINGS ON THE FARM. U. S. Dept. Agr. Farmers' Bul. 1123, 28 pp., illus.
- TRUMBOWER, JOHN A.
1934. CONTROL OF ELM LEAF SPOTS IN NURSERIES. Phytopathology 24: 62-73, illus.
- WAHLENBERG, W. G.
1930. EXPERIMENTS IN THE USE OF FERTILIZERS IN GROWING FOREST PLANTING MATERIAL AT THE SAVENAC NURSERY. U. S. Dept. Agr. Cir. 125, 38 pp., illus.
- WEAKLY, HARRY E.
1932. PUMP IRRIGATION AND WATER TABLE STUDIES. Nebr. Agr. Expt. Sta. Bul. 271, 14 pp., illus.

REFERENCE LIST OF TREE AND SHRUB SPECIES

MEDIUM-TO-TALL DECIDUOUS TREES

Ailanthus (tree of heaven).....	<i>Ailanthus altissima.</i>
Ash, green.....	<i>Fraxinus pennsylvanica lanceolata.</i>
Ash, prairie.....	<i>F. campestris.</i>
Boxelder (ash-leaved maple).....	<i>Acer negundo.</i>
Catalpa, northern.....	<i>Catalpa speciosa.</i>
Coffeetree, Kentucky (coffeetree, coffee-bean).	<i>Gymnocladus dioicus.</i>
Cottonwood.....	<i>Populus deltoides</i> (and variants of west and south).
Elm, American (white elm).....	<i>Ulmus americana.</i>
Elm, Chinese (leatherleaf elm).....	<i>U. parvifolia.</i>
Elm, Siberian.....	<i>U. pumila.</i>
Hackberry.....	<i>Celtis occidentalis.</i>
Hackberry, netleaf (Palo blanco).....	<i>C. reticulata.</i>
Honeylocust.....	<i>Gleditsia triacanthos.</i>
Honeylocust, thornless.....	<i>G. triacanthos inermis.</i>
Locust, black.....	<i>Robinia pseudoacacia.</i>
Maple, silver.....	<i>Acer saccharinum.</i>
Mulberry, red.....	<i>Morus rubra.</i>
Mulberry, Russian.....	<i>M. alba tatarica.</i>
Oak, bur (mossycup oak).....	<i>Quercus macrocarpa.</i>
Osageorange (bois d'arc, bowwood).....	<i>Moclura pomifera.</i>
Pecan.....	<i>Hicoria pecan.</i>
Persimmon, common.....	<i>Diospyros virginiana.</i>
Soapberry, western (soapberry, wild China, chinaberry).	<i>Sapindus drummondii.</i>
Sycamore, American (buttonball).....	<i>Platanus occidentalis.</i>
Walnut, black.....	<i>Juglans nigra.</i>
Walnut, Texas (western walnut, little walnut).	<i>J. rupestris.</i>
Willow, white.....	<i>Salix alba.</i>
Willow, golden.....	<i>S. alba vitellina.</i>

CONIFERS

Cypress, Arizona.....	<i>Cupressus arizonica.</i>
Juniper, Rocky Mountain.....	<i>Juniperus scopulorum.</i>
Pine, Austrian.....	<i>Pinus nigra</i> (syn. <i>P. laricio</i> Poir, not Sari).
Pine, jack.....	<i>P. banksiana.</i>
Pine, ponderosa.....	<i>P. ponderosa.</i>
Pine, Scotch.....	<i>P. sylvestris.</i>
Redcedar, eastern.....	<i>Juniperus virginiana.</i>
Spruce, blue.....	<i>Picea pungens.</i>
Spruce, western white (Black Hills spruce).....	<i>P. glauca albertiana.</i>

SHORT TREES OR SHRUBS

Apricot (Russian apricot).....	<i>Prunus armeniaca.</i>
Bladder-senna.....	<i>Colutea arborescens.</i>
Buckthorn, Siberian.....	<i>Rhamnus dahurica.</i>
Buffaloberry, silver (bullberry, squawberry).....	<i>Shepherdia argentea.</i>
Chaste-tree, lilac.....	<i>Vitex agnus-castus.</i>
Chokecherry, common.....	<i>Prunus virginiana.</i>

Chokecherry, western	<i>P. virginiana melanocarpa.</i>
Crab, Siberian	<i>Malus baccata.</i>
Currant, golden (flowering currant)	<i>Ribes aureum.</i>
Desertwillow (flowering willow)	<i>Chilopsis linearis.</i>
Elder, American (sweet elderberry)	<i>Sambucus canadensis.</i>
Hawthorn (redhaw, thornapple)	<i>Crataegus spp.</i>
Honeysuckle, Tatarian	<i>Lonicera tatarica.</i>
Jujube	<i>Zizyphus jujuba.</i>
Lilac, common	<i>Syringa vulgaris.</i>
Lilac, Persian	<i>S. persica.</i>
Maple, Tatarian	<i>Acer tataricum.</i>
Nannyberry (sheepberry, blackhaw)	<i>Viburnum lentago.</i>
Pea-tree, Siberian (caragana)	<i>Caragana arborescens.</i>
Plum, Chickasaw	<i>Prunus angustifolia.</i>
Plum, sand	<i>P. angustifolia watsonii.</i>
Plum, American (wildplum)	<i>P. americana.</i>
Redbud, eastern (Judas-tree)	<i>Cercis canadensis.</i>
Russian-olive	<i>Elaeagnus angustifolia.</i>
Serviceberry, common (western juneberry)	<i>Amelanchier alnifolia.</i>
Skunkbush (skunk sumac, aromatic sumac)	<i>Rhus trilobata.</i>
Sumac, smooth	<i>R. glabra.</i>
Tamarix, French	<i>Tamarix gallica.</i>



Harriet



