

# Oceanus

Volume 22, Number 2, Summer 1979



# Oceanus<sup>®</sup>

The International Magazine of Marine Science

Volume 22, Number 2, Summer 1979

William H. MacLeish, *Editor*  
Paul R. Ryan, *Associate Editor*  
Deborah Annan, *Editorial Assistant*

## *Editorial Advisory Board*

Edward D. Goldberg, *Professor of Chemistry, Scripps Institution of Oceanography*  
Richard L. Haedrich, *Associate Scientist, Department of Biology, Woods Hole Oceanographic Institution*  
John A. Knauss, *Dean of the Graduate School of Oceanography, University of Rhode Island*  
Robert W. Morse, *Associate Director and Dean of Graduate Studies, Woods Hole Oceanographic Institution*  
Allan R. Robinson, *Gordon McKay Professor of Geophysical Fluid Dynamics, Harvard University*  
David A. Ross, *Associate Scientist, Department of Geology and Geophysics, Woods Hole Oceanographic Institution*  
John G. Sclater, *Associate Professor, Department of Earth and Planetary Sciences, Massachusetts Institute of Technology*  
Allyn C. Vine, *Senior Scientist, Department of Geology and Geophysics, Woods Hole Oceanographic Institution*

## *Published by Woods Hole Oceanographic Institution*

Charles F. Adams, *Chairman, Board of Trustees*  
Paul M. Fye, *President of the Corporation*  
Townsend Hornor, *President of the Associates*

John H. Steele, *Director of the Institution*

The views expressed in *Oceanus* are those of the authors and do not necessarily reflect those of Woods Hole Oceanographic Institution.

Editorial correspondence: *Oceanus*, Woods Hole Oceanographic Institution, Woods Hole, Massachusetts 02543. Telephone (617) 548-1400.

Subscription correspondence: All subscriptions, single copy orders, and change-of-address information should be addressed to *Oceanus* Subscription Department, 1172 Commonwealth Avenue, Boston, Mass. 02134. Urgent subscription matters should be referred to our editorial office, listed above. Please make checks payable to Woods Hole Oceanographic Institution. Subscription rates: one year, \$10; two years, \$18. Subscribers outside the U.S. or Canada please add \$2 per year handling charge; checks accompanying foreign orders must be payable in U.S. currency and drawn on a U.S. bank. Current copy price, \$2.75; forty percent discount on current copy orders of five or more. When sending change of address, please include mailing label. Claims for missing numbers will not be honored later than 3 months after publication; foreign claims, 5 months. For information on back issues, see page 60.

Postmaster: Please send Form 3579 to *Oceanus*, Woods Hole, Massachusetts 02543.

# Contents

**INITIAL FINDINGS OF A DEEP-SEA BIOLOGICAL QUEST**  
*Expedition Participants*  
to the Galápagos Rift area has found surprising forms of life that  
ists and other scientists the challenge of understanding a new  
re. **2**

**AD ECOLOGY OF FISH SCHOOLING**  
*ss and Evelyn Shaw*  
njoy a better chance of survival under a variety of environmental

**IEW OF PLANKTON BIOLOGY**  
*ison and Laurence P. Madin*  
observation of plankton behavior in the open ocean is yielding insights  
ditional net sampling. **18**

**WATERS OF THE CONTINENTAL SHELVES?**  
*l mixing processes indicates that any waste heat discharged nearshore from power*  
efficiently transferred to offshore waters and dissipated. **28**

**MARINE ENVIRONMENT**  
*n*  
serves as one of man's best disinfecting agents, there is growing evidence of its  
he marine environment. Development of an alternative biocide could be a

**DRUGS FROM THE SEA**  
*er*  
ts between university research groups and pharmaceutical companies offer the  
loping drugs from the sea. **44**

**MEXICO'S PACIFIC INSHORE FISHERIES**  
*lcGoodwin*  
by exporting less shrimp and increasing supplies to its own seafood

scientific worker Frederic P. (Ted) Fitts looking out bow chamber underwater  
board the Research Vessel Atlantis II, owned and operated by the Woods Hole  
stitution. Photo by Anita Brosius. © 1979. BACK COVER: Eurhamphea  
vexingera, an oceanic ctenophore (see article page 18). Photo by Laurence P. Madin.

Copyright © 1979 by Woods Hole Oceanographic Institution. Oceanus (ISSN 0029-8182) is  
published quarterly by Woods Hole Oceanographic Institution, Woods Hole, Massachusetts  
02543. Second-class postage paid at Falmouth, Massachusetts, and additional mailing points.

DON'T MISS  
THE BOAT



SUBSCRIBE  
NOW



# Oceanus<sup>®</sup>

The International Magazine of Marine Science

Volume 22, Number 2, Summer 1979

William H. MacLeish, *Editor*  
Paul R. Ryan, *Associate Editor*  
Deborah Annan, *Editorial Assistant*

#### Editorial Advisory Board

Edward D. Goldberg, *Professor of Chemistry, Scripps Institution of Oceanography*  
Richard L. Haedrich, *Associate Scientist, Department of Biology, Woods Hole*  
John A. Knauss, *Dean of the Graduate School of Oceanography, University of*  
Robert W. Morse, *Associate Director and Dean of Graduate Studies, Woods Hole*  
Allan R. Robinson, *Gordon McKay Professor of Geophysical Fluid Dynamics,*  
David A. Ross, *Associate Scientist, Department of Geology and Geophysics,*  
John G. Sclater, *Associate Professor, Department of Earth and Planetary Sciences*  
Allyn C. Vine, *Senior Scientist, Department of Geology and Geophysics, Woods Hole*

#### Published by Woods Hole Oceanographic Institution

Charles F. Adams, *Chairman, Board of Trustees*  
Paul M. Fye, *President of the Corporation*  
Townsend Hornor, *President of the Associates*

John H. Steele, *Director of the Institution*

The views expressed in *Oceanus* are those of the authors and do not necessarily represent those of Woods Hole Oceanographic Institution.

Editorial correspondence: *Oceanus*, Woods Hole Oceanographic Institution, Woods Hole, Massachusetts 02543. Telephone (617) 548-1400.

Subscription correspondence: All subscriptions, single copy orders, and change of address should be addressed to *Oceanus* Subscription Department, 1172 Commonwealth Avenue, Woods Hole, Massachusetts 02543. Urgent subscription matters should be referred to our editorial office, listed above. Please make checks payable to Woods Hole Oceanographic Institution. Subscription rates: one year, \$10; two years, \$18. Subscribers outside the U.S. or Canada please add \$2 per year handling charge; checks accompanying foreign orders must be payable in U.S. currency and drawn on a U.S. bank. Current copy price, \$2.75; forty percent discount on current copy orders of five or more. When sending change of address, please include mailing label. Claims for missing numbers will not be honored later than 3 months after publication; foreign claims, 5 months. For information on back issues, see page 60.

Postmaster: Please send Form 3579 to *Oceanus*, Woods Hole, Massachusetts 02543.

## HAVE THE SUBSCRIPTION COUPONS BEEN DETACHED?

If someone else has made use of the coupons attached to this card, you can still subscribe. Just send a check — \$10 for one year (four issues), \$18 for two, \$25 for three\* — to this address:

Woods Hole  
Oceanographic  
Institution  
Woods Hole, Mass.  
02543

Please make check  
payable to Woods  
Hole Oceanographic  
Institution



\*Outside U.S. and Canada, rates are \$12 for one year, \$22 for two, \$31 for three. Checks for foreign orders must be payable in U.S. dollars and drawn on a U.S. bank.

# Contents

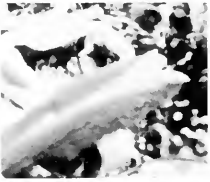

**GALÁPAGOS '79: INITIAL FINDINGS OF A DEEP-SEA BIOLOGICAL QUEST**  
by Galápagos Biology Expedition Participants  
*A return expedition to the Galápagos Rift area has found surprising forms of life that offer marine biologists and other scientists the challenge of understanding a new community structure.* **2**

**DEVELOPMENT AND ECOLOGY OF FISH SCHOOLING**  
by J. Wesley Burgess and Evelyn Shaw  
*Schooling fishes enjoy a better chance of survival under a variety of environmental pressures.* **11**



**DIVING – A NEW VIEW OF PLANKTON BIOLOGY**  
by G. Richard Harbison and Laurence P. Madin  
*Direct underwater observation of plankton behavior in the open ocean is yielding insights unattainable by traditional net sampling.* **18**



**WHAT DRIVES THE WATERS OF THE CONTINENTAL SHELVES?**  
By G. T. Csanady  
*Research on coastal mixing processes indicates that any waste heat discharged nearshore from power plants would be efficiently transferred to offshore waters and dissipated.* **28**

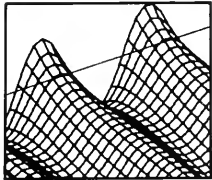

**CHLORINE IN THE MARINE ENVIRONMENT**  
by Joel C. Goldman  
*Although chlorine serves as one of man's best disinfecting agents, there is growing evidence of its harmful effects in the marine environment. Development of an alternative biocide could be a solution.* **36**



**THE SEARCH FOR DRUGS FROM THE SEA**  
by D. John Faulkner  
*Collaborative efforts between university research groups and pharmaceutical companies offer the best hope for developing drugs from the sea.* **44**

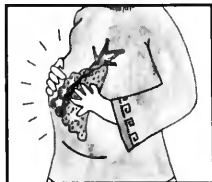

**THE DECLINE OF MEXICO'S PACIFIC INSHORE FISHERIES**  
by James Russell McGoodwin  
*Mexico might gain by exporting less shrimp and increasing supplies to its own seafood markets.* **51**



**COVER:** Volunteer scientific worker Frederic P. (Ted) Fitts looking out bow chamber underwater observation ports aboard the Research Vessel *Atlantis II*, owned and operated by the Woods Hole Oceanographic Institution. Photo by Anita Brosius. © 1979. **BACK COVER:** *Eurhamphea vexilligera*, an oceanic ctenophore (see article page 18). Photo by Laurence P. Madin.

Copyright © 1979 by Woods Hole Oceanographic Institution. *Oceanus* (ISSN 0029-8182) is published quarterly by Woods Hole Oceanographic Institution, Woods Hole, Massachusetts 02543. Second-class postage paid at Falmouth, Massachusetts, and additional mailing points.

**Galápagos '79:**

**Initial Findings of a  
Deep-Sea Biological Quest**



#### Galapagos Rift Expedition Participants\*

Scientists who are looking to outer space for the origin of life, a self-contained community of organisms has been discovered deep within the ocean. These animals have been found living at depths of 2,500 to 2,700 meters, in an area just over 100 kilometers from the Galapagos Islands, evoking the memory of Charles Darwin and *The Origin of Species*. The filter-feeding animals — limpets, serpulid worms, enormous clams and mussels, to name a few — are living in and around hot water

---

\*J. F. Grassle, Woods Hole Oceanographic Institution (WHOI); C. J. Berg, Harvard University; J. J. Childress, University of California at Santa Barbara (UCSB); J. P. Grassle, Marine Biological Laboratory; R. R. Hessler, Scripps Institution of Oceanography (SIO); H. J. Jannasch, WHOI; D. M. Karl, University of Hawaii; R. A. Lutz, Yale University; T. J. Mickel, UCSB; D. C. Rhoads, Yale University; H. L. Sanders, WHOI; K. L. Smith, SIO; C. N. Somero, SIO; R. D. Turner, Harvard University; J. H. Tuttle, University of Texas; P. J. Walsh, SIO; A. J. Williams, WHOI.



*Alvin pilot Dudley Foster talking to surface controller on the underwater telephone. The observer, Fred Grassle, holds the control box for the pumping system. (Photo by Al Giddings. © 1979 National Geographic Society)*

vents in what is known as the Galápagos Rift area, an active zone of sea-floor spreading (see *Oceanus*, Winter 1974). Most of the normally sparse life found at these depths live off particles that settle to the bottom from surface waters, where they have been created through the processes of photosynthesis and decomposition. These recently discovered animal colonies, however, are using as their ultimate food source the products of chemical synthesis — that is, the upwelling of minerals (mostly sulfur compounds) from the earth's molten interior that support a population of bacteria subsisting on hydrogen sulfide and carbon dioxide.

The exploration of sea-floor spreading centers that gave rise to the present discoveries began in 1974 with dives by submersibles on the Mid-Atlantic Ridge. Later, the Cayman Trough near Cuba was explored. But it was not until early in 1977 that the existence of these unusual colonies of marine animals became known. At that time, a third major geological expedition, part of the International Decade of Ocean Exploration sponsored by the National Science Foundation, departed for the Galápagos Rift area, some 380 kilometers northwest of the islands and 1,000 kilometers west of Ecuador.

Since the initial discovery of the unusual forms of life was made by geologists and chemists (see *Oceanus*, Vol. 20, Number 3, Summer 1977), a team of biologists joined the next Galápagos Rift expedition (January 14 to February 26 of this year). The objectives of the biology program — there also was integrated geology and chemistry work going on — were to study the distribution and structure of the communities; to learn how the newly discovered animals adapt to their unusual chemical and thermal regime; and to determine if a

self-sustaining group of microorganisms was responsible for the concentration of life at the hydrothermal vents. Included were studies of microorganisms; the growth, distribution, and life histories of organisms comprising the unusual hot springs communities; genetics; biochemistry; and in situ and laboratory physiological studies of mussels and crabs.

Our detailed observations of the behavior and habits of organisms at the Galápagos vents were made possible through use of a new television system developed specially for the cruise. A CCD (charged coupled device) camera was developed by the Radio Corporation of America in conjunction with the National Geographic Society (which sent a photography team to participate in the expedition), and Robert Ballard, a geologist and engineer at Woods Hole Oceanographic Institution. The camera, instead of having a regular Vidicon television tube, houses a solid state system that allows it to be miniaturized. It is about 20 centimeters long and can be equipped with a macrolens that permits zoom capability, recording images on a 2.5-centimeter tape.

Another advance in underwater technology connected with the expedition concerned Angus (Acoustically navigated underwater system). Angus is an unmanned two-ton sled that is towed across the bottom terrain. It can take some 3,000 colored pictures of the bottom in a 15- to 16-hour period. Previously it had been towed at about 3.6 meters from the bottom, giving pictures of a relatively small area. With a new lighting system, Angus can "fly" at about 18 meters from the bottom, increasing the picture range by a factor of seven. It can now provide pictures covering a half acre — or 1,765 square meters — in one frame. This system was



used to search for the vents — a patch of bottom 50 meters in diameter, 380 kilometers from land.

### The Biology Program

The biology team was assigned 10 dives out of a total of 30 on the expedition. Participating vessels included the submersible *Alvin*, operated by Woods Hole Oceanographic Institution; the submarine's mother ship, the *R/V Lulu*; and the *R/V Gilliss*, owned by the U.S. Navy and operated by the University of Miami. J. Frederick Grassle, an Associate Scientist in the Biology Department at Woods Hole Oceanographic Institution, was the chief scientist for the biology portion of the cruise, heading a group of scientists from Harvard University, Scripps Institution of Oceanography, Yale University, the University of California at Santa Barbara, the University of Texas, the University of Hawaii, the Marine Biological Laboratory, and Woods Hole Oceanographic Institution. Ballard led the geology program and John Edmond of the Massachusetts Institute of Technology led the geochemistry study.

Typically, *Alvin's* front basket was cluttered with a vast array of gear that included a stereo camera with thermistor probe, insulated containers, a slurp gun, sterile microbial samplers, two kinds of in situ microbiology experiments, scrapers, corers, exclusion cages, fish traps, amphipod traps, larvae traps, plankton nets, collecting plates for studying colonization, two kinds of current meters, a recording thermistor string, and in situ respirometers. A new pumping system was devised for obtaining water samples and filtered samples of varying particle size. The filter samples will be used for studies of microorganisms and particulate organic material.

*Gilliss* was delayed in Panama and arrived late at the diving site, which meant that the first two dives in *Alvin* had to be made without the results from the Angus sled and a network of navigational transponders. The first dive was made in a region of hydrothermally deposited sediment mounds 20 kilometers south of the ridge axis. These structures are so common that precise navigation was not needed to locate them. High water temperatures were detected at the crest of the mounds where thick crusts of manganese and iron oxides are formed (Corliss, and others, 1979). Later examination of box core samples taken on and around the mounds indicated a rich infaunal community on the slopes and areas surrounding the mounds. The rarely seen flower-like xenophyophorian protozoan is common in the sediment of this area.

On the second dive to the general area of hydrothermal vents, white webs of worms, dubbed "spaghetti," and occasional large dead clams were observed. These were similar to the specimens collected on the 1977 expedition. The specially

## Larger Colonies of Life Found

*The Galápagos Rift is part of a global mid-oceanic ridge system in which the crust of the earth is separating as a result of what are thought to be convective processes. Similar regions include the Mid-Atlantic Ridge and the East Pacific Rise; the latter is an area south of the Gulf of California and west of Puerto Vallarta, Mexico. In late April and early May of this year, a joint French-American-Mexican expedition to the Rise reported further interesting discoveries, including chimney-like volcanic vents where water temperatures may exceed 300 degrees Celsius (570 degrees Fahrenheit).*

*The eruptions from the volcanic structures have carpeted the region with deposits of copper, iron, zinc, cobalt, lead, silver, and cadmium — often combined with sulfur. It is believed to be the first time such mineral deposits have been found in the open ocean. In addition, the scientists — diving in the research submarine *Alvin*, operated by Woods Hole Oceanographic Institution — discovered new colonies of life covering areas more than twice the size of the Galápagos Rift communities. The participating American scientists on this expedition were from Woods Hole and Scripps Institution of Oceanography.*

designed slurp gun vacuumed the spaghetti off the rocks. Later, on deck, we finally solved the mystery of their identity: they were enteropneusts, worm-like relatives of the early ancestors of vertebrates, normally found living in sediments. Yellowish balls suspended just above the bottom — previously called "dandelions" by geochemists — also were collected with the slurp gun, but fragmented in surface waters. An intact specimen was collected on a later dive. It is a benthic siphonophore (a relative of the Portuguese man-of-war) belonging to the family Rhodaliidae. Although members of this group were first collected during the Challenger Expedition (1872-76), they have seldom been collected whole and have been assumed to occur in the water column above the bottom. By the end of the second dive, two promising vent sites had been located from Angus film processed on board the *Gilliss*.

On the third dive, an active vent with live communities was located near Clambake I (an area explored on the 1977 dives) and named Mussel Bed. The major portion of the dive was spent placing testing equipment on the bottom, including slides for studies of microbial colonization. In addition,

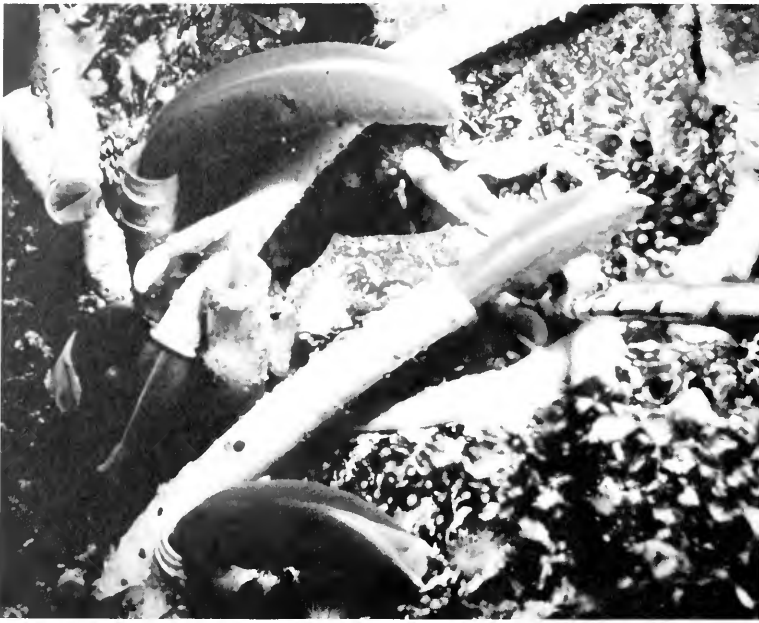

*Vestimentiferan worms with brilliant red plumes extend from tough flexible tubes. Limpets and anemones are common, and a single crab is visible. (Photo by R. Hessler)*



*Originally called "spaghetti" because of their appearance, these worms have been identified as enteropneusts. (Photo by J. J. Childress)*

mussels were sampled and vent water filtered. With so many tasks to accomplish, our studies were limited to Mussel Bed and the Garden of Eden area (also explored in '77) 3 kilometers to the east. Meanwhile, collections and photographs were made by the geologists in a new area called Rose Garden, which was named after dense beds of red-tipped vestimentiferan worms living in white tubes up to 3 meters long.

The stereo camera, mounted on a mechanical manipulator outside *Alvin*, was used to study the distribution of organisms with respect to temperature. A temperature probe gave a distance reference and provided a continuous recording of temperature on a data log inside the submersible. Detailed photogrammetric analysis of these stereo photos will enable us to accurately measure size and distance in three dimensions.

By using the slurp gun and carefully picking

animals from clumps of mussels and rocks, numerous smaller animals were obtained, many of which promise to be as interesting as the larger specimens collected. One, a small shrimp-like Leptostracan crustacean, has comb-like structures at the end of its eyestalks where eyes would normally be. This sort of eyestalk modification has never been observed in other crustaceans. The combs are probably used to scrape microorganisms (food) from the hard rock and mussel surfaces.

Collecting and observing large numbers of animals was necessary to answer some of the questions posed by these new discoveries. For example: To what extent is each area an island? How do rates of growth and metabolism there compare to other areas of the deep sea, where relatively low rates have been recorded (see *Oceanus*, Vol. 21, Number 1, Winter)? How do temperature, pressure, and food supply relate to metabolic rates?

Live brachyuran crabs were recovered from the vents, and a number were kept alive for almost three months after the expedition. Studies of their metabolic rates at different temperatures and pressures indicate they need pressures of at least 125 atmospheres to survive and are killed at about 400 atmospheres. Their metabolic rates appear to be somewhat lower than those of shallow-living crabs at comparable temperatures. The Galápagos crabs are able to remove oxygen from water at very low partial pressures, so they probably rely largely on aerobic (oxygen-dependent) metabolism in the vent waters. The upper temperature limit for the crabs is greater than 22 degrees Celsius at in situ pressures.

More than 100 mussels were collected from each of two areas for studies of genetic differentiation between populations at the vents. Analysis of enzyme variants will determine the differences between vent populations. In addition to the studies of mussels on the surface, rates of oxygen uptake were compared using respirometers



*Galatheid crabs perched on the top of pillow lavas. The dense field of mussels, some with their siphons out, are close to the source of hot water. (Photo by R. R. Hessler)*

in situ. By comparing respiration in mussels living at 2 degrees Celsius in the central and peripheral areas of the vents, it may be possible to determine how food supply relates to metabolic rate.

Many shells of the large white clam were found around dead vents. Living specimens, meanwhile, were observed nestled among the large mussels surrounding live vents, but they were never abundant. Of the material collected thus far, the size of the clams ranges from 130 to 264 millimeters in length. The anatomy of the large clam places it in the family Vesicomidae, genus *Calyptogena*. Unlike most bivalves, it has red blood and a meaty odor. These features have not yet been analyzed. Karl Turekian and colleagues at Yale University have used thorium-228/radium-228 activity ratios to estimate the age of a 22-centimeter-long clam to be less than 10 years.

The very abundant mussels clustered in the vicinity of active vents were hosts for polynoid polychaetes. At some vents almost all mussels contained polychaete symbionts in the mantle cavity, whereas at other vents they were rarely found. Like their shallow-water counterparts, the mussels are capable of forming lustrous pearls (a few small ones were found).

From studies of the larval shell morphology on juvenile specimens, it appears that these animals have a long planktonic larval life. Abyssal currents may transport the larval stage hundreds of kilometers. Since the hot water supply is not likely to be constant, a long-lived dispersal stage would be needed to locate new sources of water. The mussels are thought to be a new genus in the family Mytilidae.

The large red vestimentiferan worms mentioned earlier were collected on the eighth dive. Smaller relatives were discovered several years ago during dives with the submersible *Deepstar 400* at 1,125 meters off California. These were assigned to the phylum Pogonophora (Webb, 1969). More recent studies indicate that these

should be classified as a major taxon distinct from the Pogonophora (Van der Land and Norrevang, 1977). Forty-five to 76-centimeter specimens were collected in 1977 in the Galápagos Rift area. The specimens from the 1979 expedition are larger, with tubes as long as 2.4 to 3 meters. The largest animal collected had a tube more than 2.4 meters long and a body length, after preservation, of 1.5 meters, with a diameter measuring about 5 centimeters. Juvenile specimens less than 15 centimeters in length clustered around the base of the large tube also were recovered. The creature has a brilliant red tip, the color deriving from oxygenated hemoglobin in the blood. The animals have no gut and are thought to live on dissolved organic material in the water.

For reasons not clearly understood, each species occurs at a different distance from the vents. The pillow lava formations farthest from the vents are largely barren, with occasional corals, anemones, or sea cucumbers. As the vent is approached, crabs, enteropneusts, and dandelions appear — the enteropneusts found draped on rocks at the edge of the zone and the dandelions in protected low spots closer to the vents. The clam beds, mussels, serpulid worms, and large numbers of small anemones are located at intermediate distances. Although the distribution of mussels and crabs extends into the supply of warm water, most of the animals are living at the ambient water temperature of 2 degrees Celsius. The tops of pillow lava formations adjacent to the vents are covered with serpulid worms, their feathery plumes enabling them to filter particles from the water. Galatheid crabs — the females carrying large numbers of eggs — are common on the tops of pillow lava formations. These relatively active animals crawled into the frame of *Alvin* and many were "collected" when the submersible surfaced.

The vestimentiferan worms live only in the supply of warm water — ranging in number from a dense field spread along a 50-meter fissure at Rose Garden to only two or three small individuals in the

narrow vent openings at Mussel Bed. The rock walls of the vents are densely covered by a species of light-colored, filter-feeding limpet, which also is found scattered along the tubes of the vestimentiferan worms. The warm-water flow from the vents is the preferred place for a pink brotulid fish, often seen with its head nestled down in the vent, where it probably feeds.

### The Collection of Microorganisms

“Milky-bluish” water flows from the most active hydrothermal vents, suggesting that bacterial oxidation of hydrogen sulfide to elementary sulfur and sulfate could produce the basic food source for the entire community in the form of bacterial cells. Chemosynthetic bacteria use the energy from this chemical oxidation for the fixation of carbon dioxide into organic matter, similar to the way photosynthetic organisms use sunlight as their energy source. Other compounds that can be chemosynthetically oxidized are elementary sulfur and thiosulfate, as well as hydrogen, ammonia, nitrite, iron, and manganese. Iron and manganese crusts are prevalent in the vent area, indicating that the oxidation of materials other than sulfur compounds may contribute to the amount of carbon dioxide fixed.

The shimmering water approximately one meter above the vents contained  $10^5$  to  $10^6$  bacterial cells per milliliter as measured by direct counts with an epifluorescence microscope. These counts indicate a high bacterial output at the vents, considering that there is strong mixing with ambient water in this stratum as revealed by temperature fluctuations. The cells in these water samples (Figure 1) displayed morphological uniformity, as well as a relatively low fraction of amorphous material, both of which were unexpected. Dense clumps (mostly 12 to 100 microns in diameter) of bacterial cells were common (Figure 2).

Scanning electron microscope studies of a number of different surfaces collected near the vents disclosed some unusual forms of organisms (Figure 3). Pieces of mussel surface were rusty brown in appearance. Instead of a deposit of amorphous material, dense layers of cells or nodule-like structures were found, some apparently heavily encrusted with metal oxides (unidentified at this time). A network of filamentous structures appears to relate to prosthecate (stalked) bacteria.

Some 200 isolates of sulfur oxidizers are now under investigation. Their growth on a large variety of different enrichment media indicates an unusual diversity of metabolic types. Depending on their specific oxidation products, the growth media after incubation varies in pH from 5.1 to 8.6. Most strains prefer reduced concentrations of oxygen. Many grow well in the absence of an added nitrogen source, but only one strain has been found to

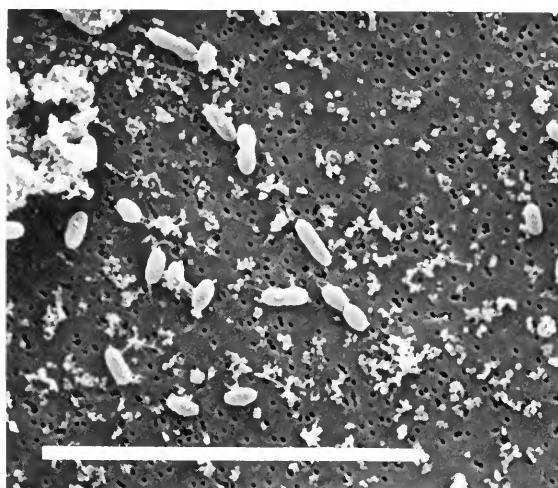

Figure 1. Water samples collected several feet above an active vent on a Nucleopore filter (pore size 0.22 micron). Bacterial cells of rather uniform appearance show division stages, indicating active growth. Magnification 5,000x (bar=10 microns).

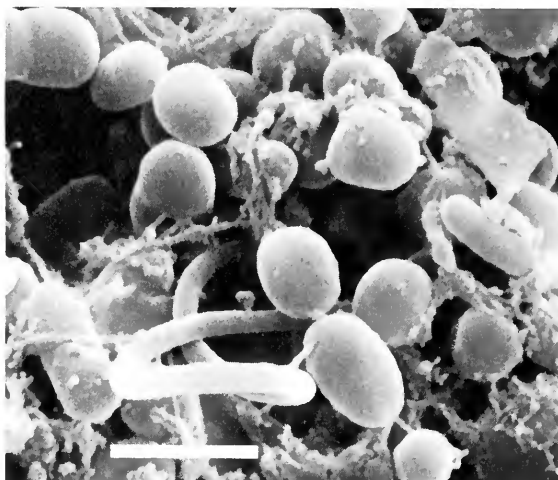

Figure 2. Representative sample of bacterial clump and amorphous matter, probably elemental sulfur. Magnification 20,000x (bar=1 micron).

exhibit enzymatic nitrogen fixation. Spirilla strains that can oxidize thiosulfate but prefer an organic substrate have been cultured. Anaerobic bacteria, which grow in the absence of oxygen and reduce sulfur compounds, also have been found. Prosthecate bacteria are in the process of being isolated. A free-living spirochaete (an elongated, spirally twisted, unicellular bacteria that moved by the contraction of flagella-like filaments) has been isolated.

Preliminary measurements of in situ carbon dioxide fixation indicate much higher bacterial activities compared with previous measurements at other marine oxic/anoxic interfaces. The analysis of ATP (adenosine triphosphate) as an indirect measure of active bacterial biomass showed values two to four times higher than in local productive surface waters, and a hundred to a thousand times

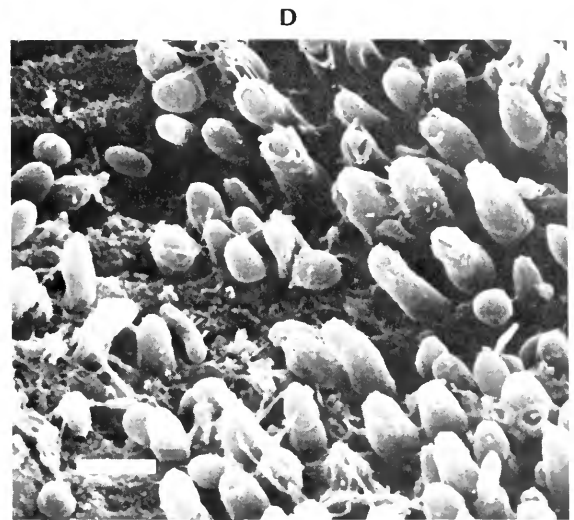
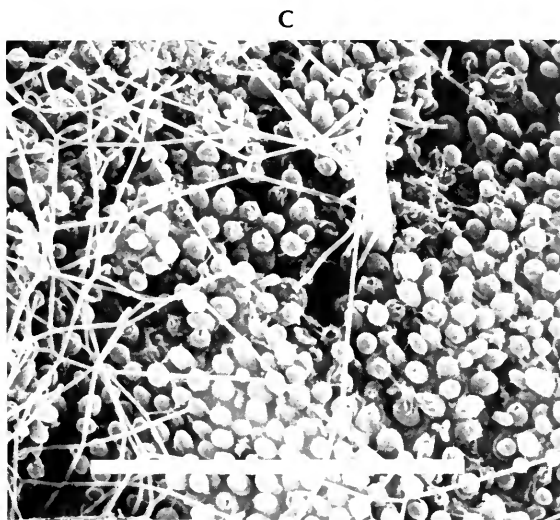
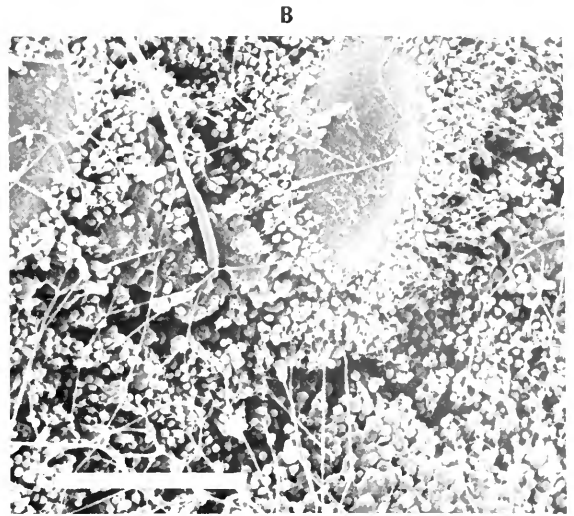
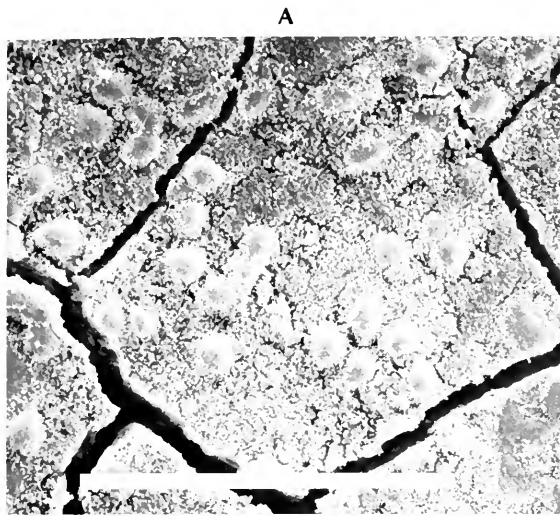

Figure 3. (A): Surface of a piece of a mussel shell collected near the Mussel Bed vent. Cracks are due to critical point drying during preparation of the specimen. Magnification 500x (bar=100 microns). (B) and (C): same preparation; network of stalks from prosthecae-like bacteria and sessile forms, apparently related to heavy mineral deposits. Magnification 2,500 and 5,000x, respectively (bar=10 microns). (D): closeup of attached and some non-attached forms, some of which appear to have an outer coating. Magnification 10,000x (bar=1 micron).

higher than in a control sample taken at some distance from the vents. This observation — along with the high bacterial content of the vent water, the extraordinary metabolic diversity, and the carbon dioxide fixation by pure cultures — appears to confirm that bacterial chemosynthesis, largely through oxidation of hydrogen sulfide, is the basic food source for the vent community (Rau and Hedges, 1979). The major bacterial production probably takes place within subsurface “growth chambers,” with a large percentage becoming diluted by ambient water before reaching consumers. Because of the complexity of the vents, it will be difficult to obtain a realistic quantification of bacterial production and efficiency.

### The Work Is Just Beginning

The hydrothermal vents contain a combination of unusual factors, such as elevated temperatures (animals in the vents experience 10- to 15-degree

Celsius temperatures, and occasionally higher ones), high pressures, and a unique chemical environment that supports a rich concentration of active sulfur bacteria. Growth and metabolic rates are high compared with other deep-sea regions. In contrast to other deep-sea habitats, the changeable environment and rich food supply favor species with rapid growth and a relatively short life span. The large areas containing dead clams may indicate the ephemeral nature of the food supply. At least some species have long-lived planktonic larvae, which enable them to colonize other areas along the ridge axis.

Despite the unusual composition of the communities, initial findings suggest that diversity — the number of species in a given population — is low. Although the communities are not directly comparable, this finding differs from the large number of species that are found in individual sediment samples in the deep sea.

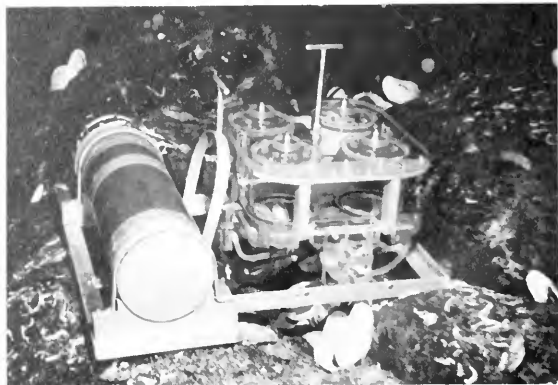

Respirometer used to measure oxygen uptake of mussels *in situ*. (Photo by R. D. Turner)

The vent food chains appear to be relatively simple, with the bulk of the organisms dependent on bacteria for food by taking up released dissolved organic material, filtering particles out of the water, or scraping material off hard surfaces. Less understood are the secondary consumers, such as scavengers and predators. The most obvious members of this group are rattail fish, an undetermined species of crab, and small amphipods — all attracted to bait.

The vent areas are more extensive than first believed. The individual concentrations of animals are part of a larger community that may extend for hundreds of miles along the axial ridge of the Galápagos Rift. The discoveries of large colonies of animals along the East Pacific Rise lend support to this view.

The greater part of the work from the Galápagos '79 expedition has only started. The biological work still to be done includes: photogrammetry; analyzing proteins for genetic information; studying the thermodynamic properties of enzymes; sorting out the numerous strains of bacteria; sectioning tissues for studies of reproduction; determining gut contents; and performing a variety of morphological studies.



Trap to catch larvae released from the bottom. Panels in background are for studies of larval settlement. (Photo by H. L. Sanders)

Another biological expedition to the Galápagos is scheduled for this November. More organisms will be collected, and a number of long-term experiments will be picked up that were placed on the bottom in January. It is expected that the experimental plates and glass slides will be colonized by rich growths of organisms, which will allow a comparison of growth rates with other areas of the deep sea. Thus these hydrothermal vents at major oceanic spreading centers will considerably advance our knowledge of deep-sea processes, but may also provide us with perplexing questions that will take some time to answer.

This article is contribution Number 3 of the Galápagos Rift Biology Expedition, supported by the National Science Foundation.

#### References

- Corliss, J. B., J. Dymond, L. I. Gordon, J. M. Edmond, R. P. von Hezen, R. D. Ballard, K. Green, D. Williams, A. Bainbridge, K. Crane, and T. H. van Andel. 1979. Submarine thermal springs on the Galápagos Rift. *Science* 203:1073-1083.
- Rau, G. H., and J. I. Hedges. 1979. Carbon-13 depletion in a hydrothermal vent mussel: suggestion of a chemosynthetic food source. *Science* 203:648-49.
- Van der Land, J., and A. Norrevang. 1977. Structure and relationships of *Lamellibrachia* (Annelida, Vestimentifera). *Det Kongelige Danske Videnskabernes Selskab, Biologiske Skrifter* 21(3): 1-155.
- Webb, M. 1969. *Lamellibrachia barhami*, gen. nov., sp. nov. (Pogonophora), from the northeast Pacific. *Bull. Mar. Sci.* 19:18-47.

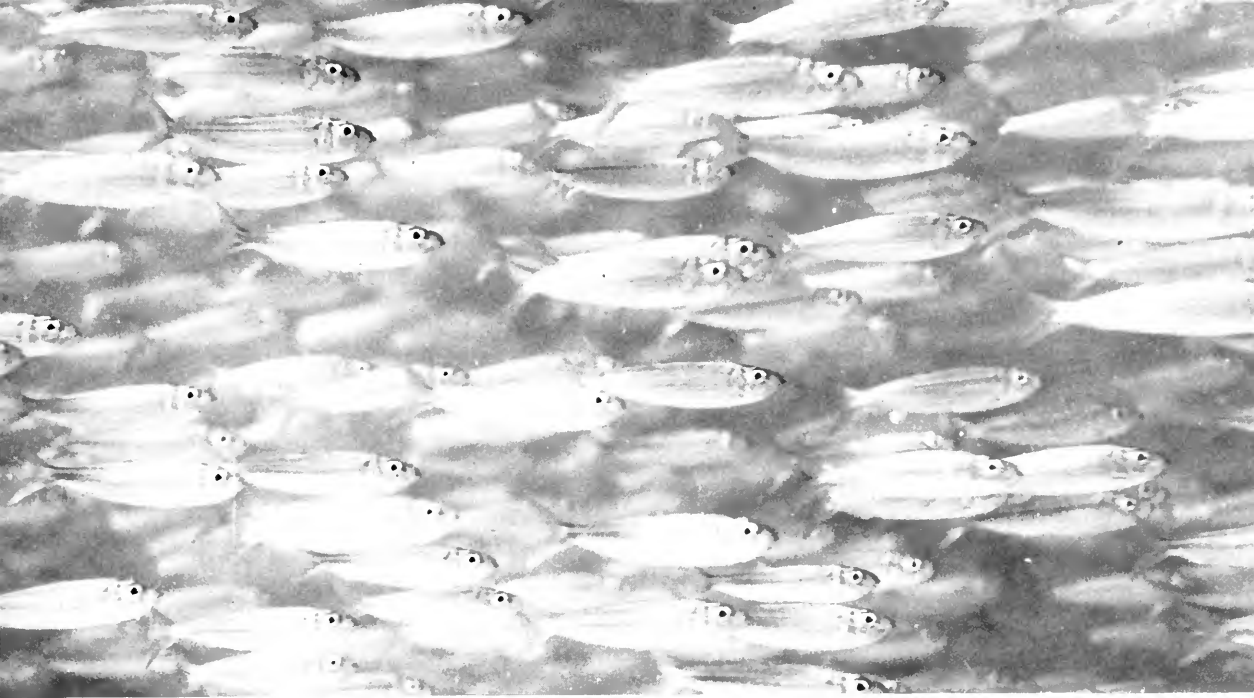

# Development and Ecology of Fish Schooling

by J. Wesley Burgess and Evelyn Shaw

The phenomenon of schooling in fishes has captured the attention of marine scientists and amateur fish observers for generations — indeed, Aristotle discussed this behavior about 2,400 years ago. There are several good reasons why schooling has provoked this interest. First, schooling fish are the foundation of major worldwide fishing industries. Fishes — such as mackerel, herring, cod, and tuna — live and swim together in large schools. They also meet their deaths together in the seines of fishermen. Second, schooling is a very prevalent behavior. About 80 percent of the approximately 20,000 known fish species exhibit a schooling phase during their life cycle. Finally, to the scientist, the behavior of schooling fish poses many biological questions that only can be answered through experimentation.

As a rule, schools are composed of many fish of the same species, moving in synchrony. Individuals tend to arrange themselves in certain configurations, maintaining predictable distances and orientations to each other (Figure 1). How this behavior is established in marine fish, what adaptive advantages schooling provides, and how schooling may have evolved are questions this article will address.

## The Development of Schooling

A schooling fish spends the first part of its life imprisoned in a transparent egg shell called the chorion. Upon hatching, the young of some species are very immature, burdened by a large yolk sac and incapable of locomotion. Other species at hatching are more advanced, being capable of feeding and sustained swimming. Most of the studies of early schooling have examined fish of the latter type.

Although schooling is not found in fish that have just hatched, it is manifested gradually during a period of social interaction. Silversides fry, *Menidia menidia*, *M. beryllina*, and *Atherina mochon*, begin their interactions by repeatedly approaching each other and then veering sharply away. At this early stage, preschooling fish often approach each other head-on, or at right angles, but as they mature, head-to-tail approaches become predominant. Finally, fish begin to swim together, at first in pairs and then in larger groups, until parallel, synchronized schooling is established.

---

Above, a school of herring, *Herklotsichthys punctatus*, in the Central Pacific. (Photo by Edmund Hobson, NMFS)

Overall, the normal development of schooling seems to be an ordered, gradual process that is preceded by well-formed, simpler behaviors.

Experiments have revealed more details about the developmental process. Some following behavior is exhibited by young fish before they are old enough to school. One way of measuring this response is to place fish of different ages into an optomotor apparatus, which consists of a round aquarium surrounded by a slowly revolving drum. The drum can be lined with alternating black and white stripes or other patterns to test the response of the fishes to moving stimuli. When tested in this apparatus, many fishes, including both schooling and nonschooling species, orient to and move at the same speed as the rotating pattern. In a 1967 study, one of the authors (E. Shaw) and B. D. Sachs compared the following responses of the silversides (*M. menidia*) prior to schooling age (fry 5 to 7 millimeters in length), or while schooling was being established (fry 8 to 10 millimeters), and after its onset (fry 11 to 12 millimeters). A well-developed following response was found in both the older and the younger fish. In 1975, Shaw tested preschooling and schooling silversides, *M. menidia* and *A. mochon*, to determine their response to different types of patterns. Preschooling fry followed fewer patterns than the older fish, and their following responses were poorly organized and more erratic. It is easy to imagine the utility of such a response, even for young fish that have just hatched. By orienting toward and following their neighbors, even tiny larvae can manage to stay together, thus avoiding dispersion in the vast ocean. These early grouping mechanisms may provide the proper environment for the later development of schooling.

What conditions are necessary for schooling to develop? To find out if early experience with other speciesmates is "essential for the formation of schooling," M. M. Williams and Shaw reared silversides, *M. menidia*, in groups of 20 fish or singly under complete isolation. When isolate-reared fry were placed together with other speciesmates, they showed obvious schooling behavior. However, schooling among the isolates was of shorter duration and the schools appeared to be less regular than group-reared fish. The same results were obtained in a later study by Williams when fish were reared in isolation, but were given visual contact with one other speciesmate. These studies indicate that schooling behavior is resistant to extreme manipulation, but early experience can produce qualitative differences in later life.

The first appearance of schools may depend on the maturation of sensory systems in young fishes. Different senses become operational at different stages of early development. Fish have the usual complement of vertebrate sense organs. The visual system, for example, is functional

immediately after hatching, allowing fish to feed before schooling. Fish eyes are especially sensitive to lateral movements, and thus may be useful in schooling. Fish also have another sensory system that is peculiar to fishes and some amphibians: the acoustico-lateralis system, commonly known as the lateral-line system. The lateral line contains sensory structures called neuromast cells that are sensitive to the movement and displacement of water. Since fish in schools swim close to the flanks of their schoolmates, it has been suggested that the lateral line might function in schooling. For example, in the perch and the ruff, clustering in close groups occurs only after the canal mast cells are formed. In young silversides, *M. menidia* and *M. beryllina*, prolonged parallel swimming and stable schooling first appear at the same time neural connections to mast cells are formed; approach behavior and occasional parallel orientation appear before this time. In these species, establishment of mature schooling patterns appears to be dependent on the presence of a functional lateral-line system.

### The Senses of Schooling

We have seen the importance of the lateral-line sensory system for the onset of schooling. However, in the adult fish neither the lateral line nor any other single sense appears to be solely responsible for maintaining coherent schools. Even when certain senses are absent, many experienced fish continue to show some facets of schooling behavior. For example, without lateral line and olfactory stimuli, single jacks oriented to schools behind a solid plexiglas partition, presumably by using visual cues. Furthermore, when saithe were

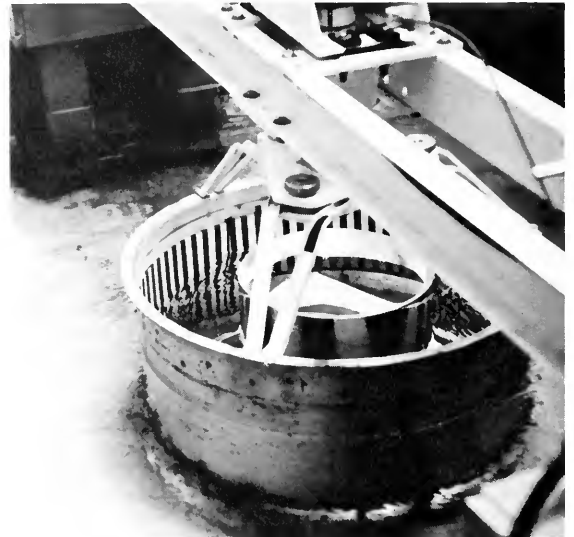

Optomotor apparatus. Drum is lined with alternating black and white stripes to test the response of fishes to moving stimuli.



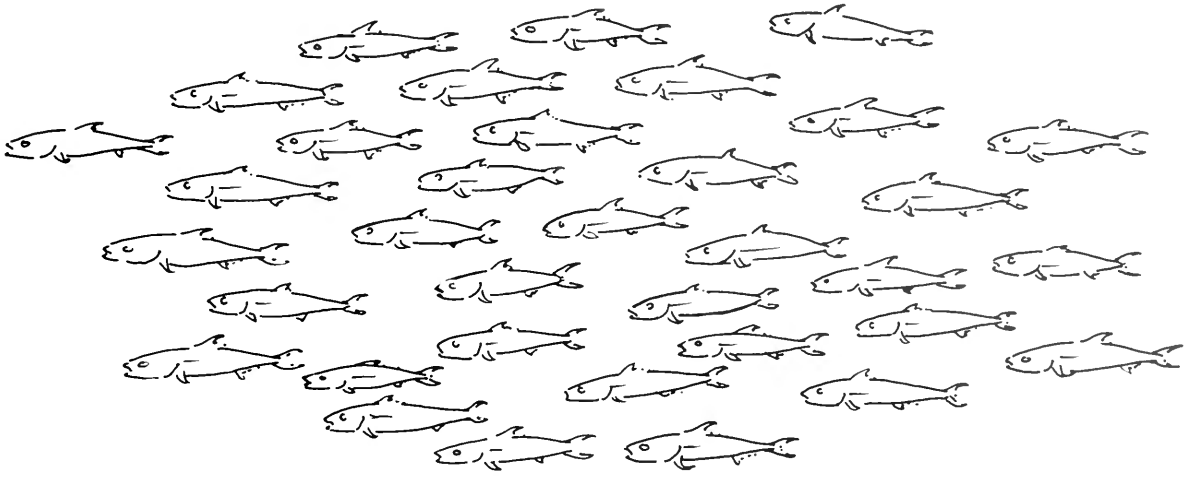

Figure 1. A small pelagic school, showing a characteristic spatial pattern. Schoolmates maintain parallel orientation and move in synchrony. Note that the fish are of the same species and are of similar size.

kept in groups of 25 in large tanks that permitted constant movement, even bilaterally blinded fish could be made to school. However, schooling could be prevented by both blinding and severing the fishes' lateral lines. So to a point, deficits in one sensory system can be compensated for by using the other, intact senses. This flexibility in the sensory control of adult schooling could insure that injured fish or groups in adverse environments (like silty water permitting low visibility) still would be able to school. For schooling to have evolved such strong resistance to outside interference, we would expect that this behavior has considerable adaptive value.

### Ecological Advantages of Schooling

While considering the various advantages that have been proposed for schooling, it is useful to imagine what optimal school form, organization, and structure would best satisfy each advantage. Eventually, the behavior of a schooling species must aid individuals' survival under a variety of environmental pressures, and might not be explainable by any single constraint.

Fish may gain immediate benefits just by traveling in a group. For example, when a fish swims, the oscillating movement of its tail produces small currents in the water called vortices. By swimming in staggered checkerboard rows, each individual theoretically can use the vortices of surrounding fish to reduce its own swimming friction, perhaps by as much as a fifth. Some evidence (Zulev and Belyayev, 1969) supports this claim, and the three-dimensional structure of some fish schools does show the checkerboard pattern that would be optimal for reducing drag, and hence reducing energy output. Increased ease of

locomotion might also result from swimming in water that has flowed over other schoolmates. In 1970 and 1971 studies, Rosen and Cornford found that the polysaccharide "slime" that is secreted on the bodies of many fishes could reduce the fluid friction of moving through the water. By swimming in the wake of schoolmates, each individual fish may use the flow of dissolved slime to further save energy. When menhaden, *Brevoortia patronus*, schools were subjected to a synthetic polysaccharide similar to natural slime, which was slowly added to the water, C. M. Breder found that individuals did, in fact, swim faster.

In addition to the immediate benefits of energy conservation, fish may receive some selective advantages by traveling in schools. By examining such advantages, we can try to understand the process of evolution through which schooling originated. Schooling is probably an ancestral behavior, because it is found in so many divergent species. As mentioned previously, about 80 percent of the approximately 20,000 known species of fishes school as juveniles, and 20 percent continue to school as adults. Because so many species in different orders have adopted this behavior, it is likely that there are considerable survival advantages for populations of schooling fishes, especially during juvenile stages.

The major ecological advantages of schooling can be divided into two categories: behaviors that help species avoid predators, and behaviors that contribute to the competitive success of a species. In the first category, V. E. Brock and R. H. Riffenburgh demonstrated in a geometric analysis published in 1960 that a predator searching at random has a more difficult time finding prey that are spaced close together in a school (Figure 2).

(2A)

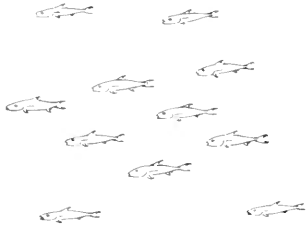

(2B)

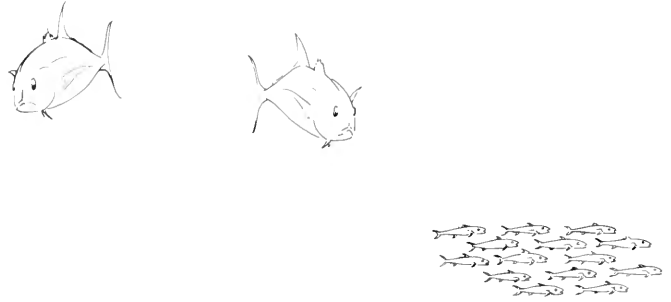

Figure 2. Advantages of schooling as a defense against predation. A solitary predator fish searches for prey among equal-sized populations of evenly-spaced territorial fish (A) or clumped, schooling fish (B). A larger area must be searched to find the prey in schools. Even when a predator finds the school, improved detection, group maneuverability, the confusion effect, and predator satiation can protect individuals.

Certainly in any population, a close-schooling species will leave more vacant territory for predators to search in vain than a species that is dispersed uniformly. In this way, the distribution pattern of a school within the ocean may deter predation.

Within a school, there truly may be safety in numbers. As several investigators have realized, a predator cannot consume unlimited quantities of prey at one meal. When a predator becomes satiated, the other fish in the school are safe. One example of predator satiation is seen in the prey fish *Pempheris ovalensis*, an inhabitant of coral reefs. These fish rest during the day in caves and crevices, forming schools of hundreds to thousands of individuals. Although they regularly encounter territorial predators residing in their hiding places, the predator fishes can eat only a few individuals at a time, and the bulk of the schooling fish benefit from the protection of their surroundings. The use of schooling for increased protection during resting periods has been observed in various other reef fishes.

There are several reasons why schooling may be especially advantageous for juvenile fishes. Many adult fishes spawn at the same time, often in areas where larval food is plentiful. The resulting concentrations of tiny, newly hatched fry become especially vulnerable targets for marine predators. Just like adults in resting schools, juveniles may find a survival advantage in staying close together in large numbers in order to swamp potential predators. For example, D. V. Radakov found in a 1973 study that horse mackerel in a 300-liter aquarium quickly eat as many as 59 young silversides if presented one at a time. When the prey fish were presented in groups, they either were consumed less rapidly or escaped from the horse mackerel. If schooling is advantageous for juvenile fish (as these results suggest), it explains why so

many species have evolved juvenile schooling.

Another insight is derived from studies of birds. Instead of laying eggs throughout the breeding season, many bird species synchronize their reproduction so that many young hatch at the same time. This is called the Fraser Darling effect. The resulting brief oversupply of prey is difficult for predators to utilize and may serve the same ecological function as group spawning and juvenile schooling in fishes — concentrating age classes in space and time in order to decrease the effects of predation on juveniles.

Even before a predator reaches satiation, fish may be able to hide behind other schoolmates and avoid being caught. The notion that animals band together to screen themselves from predators (the “selfish herd,” W. D. Hamilton, 1971) has been applied to many animals that live in groups. G. C. Williams has suggested that schools serve as a form of cover and that schooling may be little more than an attempt by fish to hide behind their schoolmates for protection. However, the cinematographic observations of Radakov do not confirm that schooling fish try to swim behind others in the group, even when alarmed by the appearance of a predator. Predators can be confused by the rush of swimming fish that pass in a school. Without having to hide behind their schoolmates, the confusion effected by a mass of alternating colors and shapes may increase predators’ difficulty in isolating and catching individuals.

Another way fishes can foil predators is to use the combined watchfulness of their other schoolmates to detect harmful intruders. It is known that fish can respond rapidly to changes in the swimming speed of neighbors in a school. After detecting a predator, schools can execute quick turns and synchronized escape maneuvers. For example, P. F. Major in a 1977 study found that single jacks could readily approach and catch

anchovies swimming alone, but were less successful at preying on anchovies in schools. In the oceans, the increased scanning of the environment and increased group maneuverability combine to give schooling prey a survival advantage over solitary predators.

Thus the increased difficulty of searching for fishes in schools, coupled with the ability to satiate, confuse, detect, and outmaneuver predators all contribute to the anti-predator value of schooling. All or many of these specialized strategies appear to be employed by diverse fish species whose schooling patterns are basically similar. It may be the combination of different survival advantages that makes schooling flexible enough to serve as a successful lifestyle for so many fishes.

Schooling also can help fishes to be successful competitors, facilitating a wide variety of feeding strategies, including plankton-feeding, omnivorous, and predation. For example, tiny animals fed upon by planktivorous fishes do not appear to be uniformly distributed throughout the ocean, but are concentrated in patches. Where plankton are clumped, fishes that swim close together in schools have an advantage, since this "bonanza strategy" allows many individuals to search for food clusters that will feed the entire school.

Adult omnivores also can use schooling to their advantage, especially when competing with territorial fishes. In the parrot fish *Scarus croicensus*, for example, individuals either can defend territories, or swim in schools. When available territories are depleted by a competing damselfish species, the remaining parrot fish form schools where individuals feed more often and suffer fewer attacks than their territorial speciesmates.

Predator fishes, on the other hand, can use schooling to aid in the capture of food fish. Although solitary predators are less successful with schooling prey, predators that travel in groups actually have an advantage in finding and catching schooling prey fish (Figure 3). For example, Major found that schools of jack were more efficient at capturing anchovies from schools than a jack working alone.

Schools of predatory fish may be able to use specialized tactics to make food capture more effective. Predatory schools are commonly observed encircling all or part of a school of food fish. Maneuvers such as circling may help counter the confusion effect and reduce the maneuverability of prey fish schools.

### Structure of Fish Schools

Although schooling has been studied for some time, the form and structure of schools are only now beginning to be understood. One reason for this is that the required studies of schooling individuals'

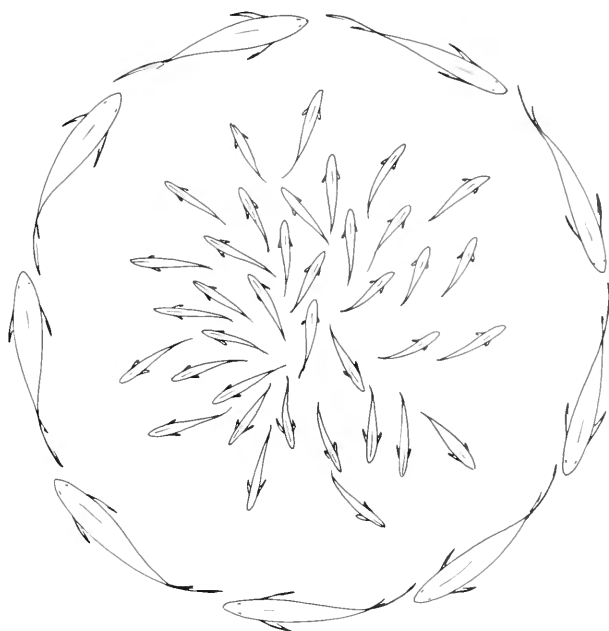

Figure 3. Schooling predators encircling a school of prey fish. This is one way predators can utilize the advantages of schooling. In pursuing clumped resources, school members benefit from the combined searching abilities of their schoolmates. Predatory schooling maneuvers like this help circumvent prey schools' antipredator tactics, such as confusion, predator satiation, and synchronized escape swimming.

movement, orientation, and interdistances are rigorous and time consuming, usually requiring frame-by-frame analysis of photographs of a school. Such analyses have been performed by several behavioral scientists. All found that fish in schools stayed close together, maintaining positions 0.18 to 1.0 body lengths apart from their nearest neighbors. Actual distances depended on the age and species of the fish in the school and the experimenter's measurement techniques. Fish in schools synchronized their swimming speeds and stayed in predominantly parallel orientation without touching. When J. C. Van Olst and J. R. Hunter in a 1970 study compared orientation angles within schools of Pacific mackerel, jack mackerel, northern anchovy, jack smelt, and topsmelt, all species were found to follow their schoolmates in front and behind more than their neighbors to the sides. Schooling pilchards, *Harengula* sp., were arranged in diagonal rows like a checkerboard, with animals distributed in equal density on all planes.

We know only a few factors that affect the structure of a school. Disturbances or the appearance of a predator can cause schools to draw together. In jack mackerel, food deprivation also can cause changes in interdistances and less compact schools. S. A. Moss and W. M. McFarland

found in a 1970 study that anchovy schools respond to short-lived, abrupt changes in dissolved oxygen and acidity by abruptly altering their swimming speed. Inside mullet schools there occurred areas where oxygen concentration and acidity were significantly less than in the surrounding water. Fish in these areas moved at a higher rate and maintained more uniform orientation. What function these internal chemical variations might have under natural conditions is not known.

Many behavioral variables have been measured in fish schools: for example, tendencies for aggregation, uniform distances, parallel orientation, group alarm responses, and synchronized swimming maneuvers. Unfortunately, we know little about how these behaviors interact or what causes the variations in schooling that we observe in nature. As we continue to study schooling, we will have an opportunity to learn more about the relationship between the behaviors we observe and their ecological value.

### Evolution of Schooling

It is impossible to be sure how or when schooling first began. We could infer evolutionary steps by using our understanding of the development and ecology of schooling in contemporary species to reconstruct the most direct ancestral route to this behavior. We would expect to find the roots of schooling in the previously existing behavior patterns of many species. Although serving other functions, these so-called “preadaptations” could act as stepping stones for the evolution of new behaviors like schooling. For example, synchronized adult spawning would initially result in clumps of newly hatched juveniles. Young fishes that had good lateral eyesight, a lateral-line system for detecting nearby water movements, and an early tendency to orient toward and follow moving patterns would possess many of the behavioral prerequisites for schooling. In several species, an immediate facility for swimming results from following speciesmate’s vortices and swimming in the wake of their drag-reducing slime. This behavior might have been sufficient for some ancestral juveniles to have begun swimming close together.

We also would expect the same environmental pressures — namely, to avoid predation and to increase competitive ability that favor modern schooling fishes — to increase the survival rate of ancestral juveniles swimming in groups. The more solitary juveniles might have been selected against by predators or they may have been out-competed for limited resources, such as food, shelter, or territory. Thus we would expect ecological factors to have selected for genetically programmed schooling patterns.

Once a pattern of schooling becomes established in juveniles, the general schooling behavior seen in many mature fishes can be

explained by selection pressures acting on the timing of development or certain behaviors. For example, the onset of avoidance or aggressive behaviors may gradually have been delayed or lost in maturing schoolers. Juvenile behaviors, such as interattraction and following, that had adaptive value in groups might have been retained in maturing individuals through neoteny (delayed development). Selection operating on each species of generalized schoolers then could have favored specialized mechanisms to control the synchrony and structure of schools, leading to different strategies for finding food and avoiding predators. Of course, this is what we find today: a constellation of generalized schooling behaviors similar in many fishes, along with specialized patterns that serve the divergent lifestyles of each separate species.

In summary, we have seen in juvenile fish the gradual, ordered unfolding of schooling that is highly resistant to changes in early social environment and the loss of sensory input. The simple behaviors of juveniles are elaborated in adults to form specialized schooling adaptations that aid fishes with diverse lifestyles to feed and avoid becoming food for others. Thus schooling provides fishes with not one, but a whole complex of ecologically adaptive advantages. A better understanding of the form and biological function of fish schooling will help us to use, protect, and appreciate a resource that supports our fishing industries, supplying the world with high-protein food and valuable by-products. Beyond these practical considerations, it is certain that the grace and beauty of great schools of ocean fish will continue to stimulate and intrigue the minds of men and women for generations to come.

*J. Wesley Burgess is a postdoctoral researcher on fish schooling in the laboratory of Evelyn Shaw at Stanford University. Evelyn Shaw is an Adjunct Professor in the Department of Biological Sciences.*

## References

- Baylor, E. R., and E. Shaw. 1962. Refractive error and vision in fishes. *Science* 136: 157-158.
- Belyayev, V. V., and G. V. Zuyev. 1969. Hydrodynamic hypothesis of school formation in fishes. *Journal of Ichthyology* 9: 578-584.
- Breder, C. M., Jr. 1954. Equations descriptive of fish schools and other animal aggregations. *Ecology* 35: 361-370.
- — —. 1967. On the survival value of fish schools. *Zoologica* 52: 25-40.
- — —. 1976. Fish schools as operational structures. *Fishery Bull.* 74: 471-502.
- Brock, V. E., and R. H. Riffenburgh. 1960. Fish schooling: a possible factor in reducing predation. *J. Conseil Perm. Internat. Explor. Mer.* 25: 307-317.
- Cahn, P. H., E. H. Atz, and E. Shaw. 1965. Lateral-line nerve differentiation correlated with schooling in the marine fish *Menidia*. *Amer. Zool.* 5: 142.
- Cahn, P. H., E. Shaw, and E. H. Atz. 1968. Lateral-line histology as related to the development of schooling in the atherinid fish *Menidia*. *Bull. of Marine Sci.* 18: 660-670.
- Coulson, J. C., and E. White. 1956. A study of the colonies of the kittiwake *Rissa tridactyla* (L.). *Ibis* 98: 63-79.
- Cullen, J. M., E. Shaw, and H. A. Baldwin. 1965. Methods for measuring the three-dimensional structure of fish schools. *Anim. Behav.* 13: 534-543.
- Cushing, D. H., and F. R. Harden-Jones. 1968. Why do fish school? *Nature* 218: 918-920.
- Darling, F. F. 1938. *Bird flocks and the breeding cycle: A contribution to the study of avian sociality*. Cambridge, Mass.: Cambridge Univ. Press.
- Disler, N. N. 1950. Development of the sense organs of the lateral line system of the perch and ruff. *Trudy Inst. Morfol. Zhirol. Imen. A. N. Severtsova, Vyn.* 2: 85-139.
- Eggers, D. M. 1976. Theoretical effect of schooling by planktivorous fish predators on rate of prey consumption. *J. Fisheries Res. Board of Canada* 33: 1964-1971.
- Eibl-Eibesfeldt, I. 1962. Freiwasserbeobachtungen zur Deutung des Schwarmverhaltens verschiedener fische. *Zeitschrift Tierpsychologie* 19: 165-182.
- Fishelson, L., D. Popper, and N. Gunderman. 1971. Diurnal cyclic behavior of *Pempheris oualensis* Cuv. & Val. (Pempheridae: Teleostei). *J. of Natur. Hist.* 5: 503-506.
- Hamilton, W. D. 1971. Geometry for the selfish herd. *J. of Theor. Biol.* 31: 295-311.
- Healey, M. C., and R. Prieston. 1973. The interrelationships between individuals in a fish school. *Fisheries Res. Board of Canada Tech. Reports* 389: 1-15.
- Hobson, E. 1968. Predatory behavior of some shore fishes in the Gulf of California. *U.S. Bureau of Sport Fisheries and Wildlife Res. Reports* 73: 1-92.
- Hunter, J. R. 1968. Effects of light on schooling and feeding of jack mackerel *Trachurus symmetricus*. *J. Fisheries Res. Board of Canada* 25: 393-407.
- — —. 1972. Swimming and feeding behavior of larval anchovy *Engraulis mordax*. *Fisheries Bull.* 70: 821-838.
- Jorné-Safriel, O., and E. Shaw. 1966. The development of schooling in the atherinid fish *Atherina mochon* (Cuvier). *Pubbl. Staz. Zool. Napoli* 35: 76-88.
- McFarland, W. N., and S. A. Moss. 1967. Internal behavior in fish schools. *Science* 156: 260-262.
- Magnuson, J. J., and J. H. Prescott. 1966. Courtship, locomotion, feeding and miscellaneous behaviors of Pacific bonito (*Sarda chiliensis*). *Anim. Behav.* 14: 54-67.
- Major, P. F. 1977. Predator-prey interactions in schooling fishes during periods of twilight: A study of the silverside *Pranesus isularum* in Hawaii. *Fisheries Bull.* 75: 415-426.
- Manteifel', B. P., and D. V. Radakov. 1960. The adaptive significance of school behavior in fishes. *Russian Rev. of Biol.* 50: 338-45.
- Moss, S. A., and W. N. McFarland. 1970. The influence of dissolved oxygen and carbon dioxide on fish schooling behavior. *J. Mar. Biol.* 5: 100-107.
- O'Connell, C. P., and C. P. Raymond. 1970. The effect of food density on survival and growth of early post yolk-sac larvae of the northern anchovy (*Engraulis mordax* Girard) in the laboratory. *J. Exper. Mar. Biol. and Ecol.* 5: 187-197.
- Ogden, J. C., and P. R. Ehrlich. 1977. The behavior of heterotypic resting schools of juvenile grunts (Pomadasyidae). *J. Mar. Biol.* 10: 273-280.
- Olson, F. C. W. 1964. The survival value of fish schooling. *J. Conseil Perm. Internat. Explor. Mer.* 29: 115-116.
- Orfeev, Yu-V. 1963. The adaptive role of schooling behavior. *Doklady Akademiyi Nauk USSR* 152(4).
- Pitcher, T. J. 1973. The three-dimensional structure of schools in the minnow, *Phoxinus phoxinus*. *L. Anim. Behav.* 21: 673-686.
- Radakov, D. V. 1973. *Schooling in the ecology of fish*. New York: John Wiley and Sons. (translated from Russian)
- Robertson, D. R., E. A. Fletcher, M. G. Cleland, and H. P. A. Sweetman. 1976. Schooling as a mechanism for circumventing territoriality of competitors. *Ecology* 57: 1208-1220.
- Rosen, M. W., and N. E. Cornford. 1970. Fluid friction of the slime of aquatic animals. *Nav. Undersea Res. Dev. Center Tech. Publ. N.U.C.T.P.* 193: 1-45.
- — —. 1971. Fluid friction of fish slimes. *Nature (London)* 234: 49-51.
- Shaw, E. 1960. The development of schooling behavior in fishes. *Physiol. Zool.* 32: 79-86.
- — —. 1961. The development of schooling in fishes II. *Physiol. Zool.* 34: 263-272.
- — —. 1969. The duration of schooling among fish separated and those not separated by barriers. *Amer. Mus. Novitates* 2373: 1-13.
- — —. 1970. Schooling in fishes: critique and review, pp. 452-480. In *Development and evolution of behavior*, ed. by L. R. Aronson, E. Tobach, D. S. Lehrman and J. S. Rosenblatt. San Francisco: W. H. Freeman and Co.
- — —. 1975a. Fish in schools. *Natur. Hist.* October: 40-46.
- — —. 1975b. Various visual patterns and the optomotor reactions of atherinid fish *Menidia menidia* and *Atherina mochon* during their preschooling and schooling phases. *Pubbl. Staz. Zool. Napoli* 39: 187-200.
- — —. 1978. Schooling fishes. *Amer. Sci.* 66(2): 166-175.
- Shaw, E., and B. D. Sachs. 1967. Development of the optomotor response in the schooling fish *Menidia menidia*. *J. Comp. and Physiol. Psych.* 63: 385-388.
- Symons, P. E. K. 1971. Spacing and density in schooling threespine stickleback (*Gasterosteus aculeatus*) and mummichog (*Fundulus heteroclitus*). *J. Fisheries Res. Board of Canada* 28: 999-1004.
- Van Olst, J. C., and J. R. Hunter. 1970. Some aspects of the organization of fish schools. *J. Fisheries Res. Board of Canada* 27: 1225-1238.
- Verheijen, F. J. 1956. Transmission of a flight reaction amongst a school of fish and the underlying sensory mechanisms. *Experientia* 12: 202-204.
- Welty, J. C. 1934. Experiments in group behavior of fishes. *Physiol. Zool.* 7: 85-128.
- Williams, G. C. 1964. Measurement of consociation among fishes and comments on the evolution of schooling. *Publ. of the Museum, Michigan State Univ.* 2: 349-384.
- — —. 1966. *Adaptation and natural selection*. Princeton, N.J.: Princeton Univ. Press.
- Williams, M. M. 1976. Rearing environments and their effects on schooling of fishes. *Pubbl. Staz. Zool. Napoli* 40: 238-254.
- Williams, M. M., and E. Shaw. 1971. Modifiability of schooling behavior in fishes: the role of early experience. *Amer. Mus. Novitates* 2448: 1-19.
- Wilson, E. O. 1975. *Sociobiology*. Cambridge, Mass.: Harvard Univ. Press.
- Zuyev, G. V., and V. V. Belyayev. 1970. An experimental study of the swimming of fish in groups as exemplified by the horse mackerel *Trachurus mediterraneus ponticus* Aleev. *J. Ichthyology* 10: 545-549.

# Diving - A New View



# of Plankton Biology



by G. Richard Harbison  
and Laurence P. Madin

The principal research tool in plankton biology — the study of freely drifting organisms — is the towed net. It has provided the basic data for most of our knowledge on the distribution, diversity, productivity, and behavior of zooplankton. In the last 10 years, an alternative method for studying these animals has been developed — direct underwater observation and collection of animals by divers. The results obtained using this approach often differ greatly from those derived from net samples. In situ studies have shown that a great deal of essential information about the lives of planktonic animals cannot be learned by collecting the animals with a net. Diving studies also have limitations, however, and further progress in plankton biology will depend on a careful synthesis of the two methods.

Research by the authors on the natural history and behavior of large, gelatinous zooplankton has stressed the importance of in situ work. Our results, obtained at Woods Hole Oceanographic Institution, and those of others elsewhere, have changed the conception of how

---

*Divers connected by tether lines collecting plankton in North Atlantic. (Photo by Anita Brosius. © 1979)*



*Setting out for a dive to observe plankton in the open ocean. (Photo by Vicki McAlister)*

many planktonic animals live. This new perspective is essential to understanding the place of pelagic animals in the open ocean — one of the largest and least known of all environments on earth.

It is a very still place. A planktonic animal that lives in the open sea is generally free from mechanical stress, such as tidal rips, currents, and turbulence associated with nearshore environments. In contrast to many marine environments, the water of the open ocean is very clear. Nutrients are dilute, so the plant life is dilute, and the silt and detritus found close to shore have settled out long before reaching the open sea.

Another characteristic of this environment is stability. The great mass of water in the ocean basins acts as a buffer against rapid changes in physical properties. For an animal living there, such environmental parameters as temperature, salinity, and oxygen concentration are stable and predictable. Animals often can seek preferred conditions simply by swimming up or down in the water column.

These general environmental characteristics provide both possibilities and restrictions for the

plankton. The lack of mechanical stress means that many oceanic animals are much more delicate than their nearshore relatives. The transparency of the water makes vision an important sense to many pelagic animals. The diluteness of the algae, the primary food source, forces grazing animals to develop ingenious and efficient methods of gathering phytoplankton. Filter-feeding animals in the open sea must be able to process large volumes of water, or have sensory means of locating dense concentrations of food. Since the concentration of the primary producers is low, the number of grazing animals per unit volume also is low, and the carnivores that prey on them (or on one another) must also develop effective mechanisms for collecting or locating their prey.

Without some simplifying assumptions, the study of the distribution and abundance of plankton in the open ocean is nearly impossible. One of the first of these suppositions was formulated in 1885 by the German oceanographer Victor Hensen, who stated that “. . . in the ocean the plankton must be regularly distributed; . . . from a few catches very safe estimates can be made upon the conditions of

*Meter net tow used to sample plankton. The distance across the face of the net is 1 meter.*





very great areas of the sea." Clearly, if this is a false assumption, any truly quantitative study of plankton is impossible. This central axiom has guided the course of plankton research to the present day. A second important assumption is that plankton nets, if used correctly, can sample representative fractions of all the different types of animals that make up the plankton.

But as the technology of plankton sampling progressed, new techniques and equipment raised questions about these assumptions. The Hardy Plankton Recorder\* unequivocally demonstrated that the distribution of plankton is patchy and not regular. As larger nets that could be towed faster through the water were built, it became apparent that some animals had not been caught before — those that were too fast or too wary. Other forms were being caught, but escaped through the meshes or were destroyed by preservatives. Various statistical procedures and mathematical models were developed to try to deal with the problems of patchiness and avoidance.

Thanks to quantitative sampling methodology, oceanographers know much more about planktonic animals than they did 100 years ago. Plankton nets have taught us about the diversity of planktonic organisms, their abundance on local scales, and their global distribution. From net samples, we have been able to deduce or calculate primary and secondary productivity, life cycles, migration patterns, and effects of grazing or predation. Sampling systems are increasingly sophisticated, and the samples obtained are ever more precise and well defined. Within the limits of its underlying assumptions, sampling technology is an advanced art.

However, the problem with this precision and sophistication is that it tells us almost nothing about what individual animals are doing. In fact, it can indirectly paint a convincing but erroneous picture of plankton behavior. From assemblages of dead organisms, samplers seek to reconstruct patterns of life. The biology of a population is inferred from statistics and analogy, with the behavior of individual animals drawn from these results. As field ecologists we work in a different way, using in situ observation and specific experiments to discover how organisms function — what they eat, how they grow, when they reproduce, how they respond to the stimuli of the

surroundings. From this information, we are constructing a mosaic of the pelagic ecosystem.

Because it had to await suitable technology, in situ research in marine environments is a relatively recent pursuit. Nevertheless, it already has contributed many significant advances to marine biology. The study of coral reef ecology has been revolutionized by scuba diving; it is now unusual to study reefs in any other way. And manned submersibles have revealed enough about life on the ocean floor to render dredges and grabs nearly obsolete. In situ study of zooplankton is the most recent innovation.

The need for this new approach is apparent when one considers gelatinous zooplankton — a mixed group of organisms from many different phyla that have diffuse, watery bodies. In situ research, however, can be applied to other planktonic organisms and phenomena as well. To illustrate the applications and advantages of such field work, we will consider two examples from our own research.

### Ctenophores and Amphipods

Ctenophores constitute an entire phylum of gelatinous animals, most of them planktonic. They propel themselves through the water by bands of tiny paddles. All are carnivores. The phylum contains 25 genera of pelagic forms. About six of these commonly are found close to shore; and a great deal of what is known about ctenophores comes from the study of three or four of these genera. Anyone who has spent time on the coast is likely to have seen *Pleurobrachia*, the sea-gooseberry. Marine biologists have known for some time that these can occur in great numbers, often with significant effects on the rest of the plankton. But there have been only scattered reports of the other 19 genera, and almost never a mention of ctenophores in the open ocean.

When we began looking at the upper waters of the open ocean on dives, we noticed a great diversity and abundance of ctenophores. We have found that 12 genera commonly occur in the oceanic environment. It is clear why ctenophores were hitherto unreported from the open sea — almost every species is so delicate that it is torn to unrecognizable shreds by a plankton net.

The most fragile of these, and the ctenophore that differs most from the typical sea-gooseberry, is the "Venus Girdle," *Cestum veneris*. This animal has a flat, belt-like body that is up to 2 meters long, but only a few millimeters thick. The stomach sits crosswise in the middle of the band; rows of paddles run down one long edge, and rows of fine sticky tentacles down the other. Seen underwater, *Cestum* is like a wing, moving slowly forward under the power of its paddles. The sticky tentacles lie back along the flat sides of the body, forming a sort of flypaper for small

---

\*A collection device developed in the 1930s by Sir Alister Hardy. It can be towed for long distances and traps a sample of plankton on a continually moving strip of gauze, providing a sort of "tape-recording" of changes in plankton abundance over the length of the tow. The sampler thus indicates horizontal distribution or "patchiness" in plankton populations.

# Gelatinous Planktonic

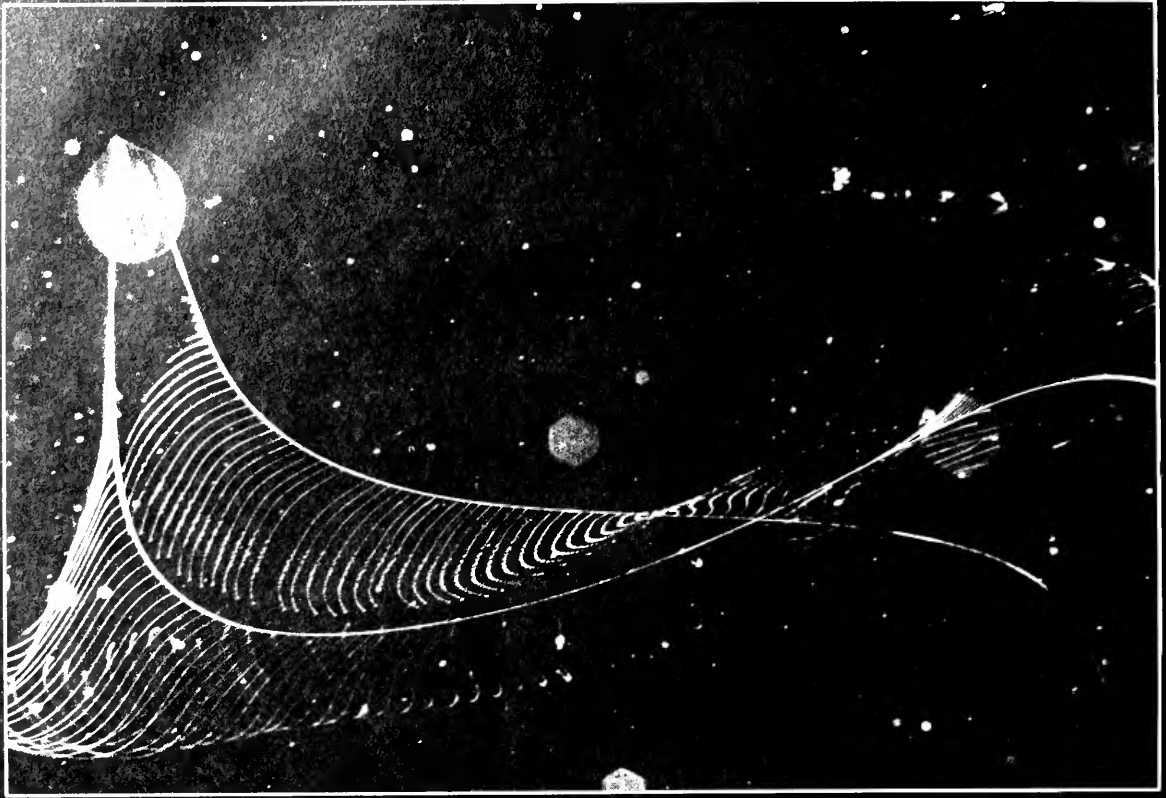

*Pleurobrachia*, the common nearshore sea-gooseberry. (Photo by Laurence Madin)



*Mnemiopsis mccradyi*, a ctenophore restricted to the central and southern Atlantic coast. (Photo by Neil Swanberg)



*Eurhamphea vexilligera*, an oceanic ctenophore of the lobate group. (Photo by Laurence Madin)

# Creatures of the Ocean



*The widely spread lobes of Leucothea multicornis trap small crustaceans. (Photo by Laurence Madin)*

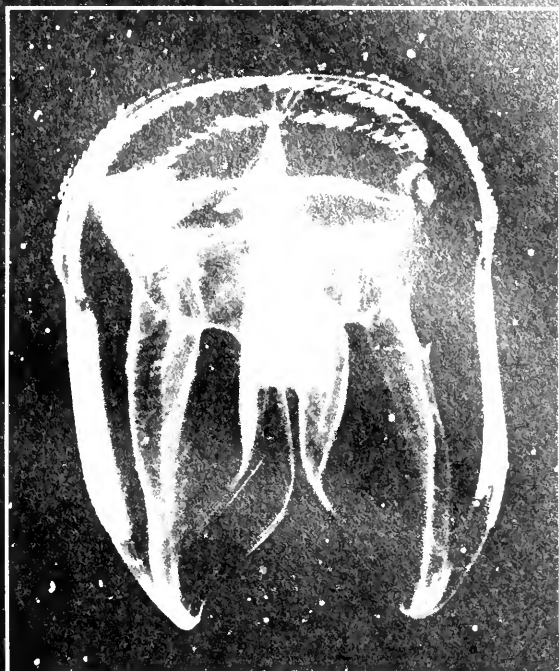

*Ocyropsis crystallina swims and catches prey with strong muscular lobes. (Photo by Laurence Madin)*



*Feeding only on salps, Lampea pancerina attaches to and slowly digests prey that are too large to engulf. (Photo by Laurence Madin)*

crustaceans to adhere to when they swim into the ctenophore. The essence of the feeding mechanism of *Cestum* is silent running, but if disturbed it switches to a rapid wriggling motion and swims away. We have found *Cestum* to be the most common species in the North Atlantic. It was present on 178 of 445 dives made from 1974 through 1978. In comparison with ctenophores found close to shore, *Cestum veneris* is indeed a bizarre creature, but from the perspective of large-scale distribution, it is the *typical* ctenophore.

Other ctenophores catch their food in different ways. *Leucothea*, a large member of the lobate group, extends its filmy lobes to form a sticky trap up to 20 centimeters in diameter. Copepods and even larger crustaceans swim into parts of the lobe, which folds over them and prevents their escape while fine tentacles draw the prey to the mouth. In *Ocyropsis*, the lobes are muscular, grasping the prey and moving it to the mouth in seconds. This feeding mechanism enables *Ocyropsis* to catch larger and more active prey such as euphausiids, salps, and small fish.

The large sticky surfaces of *Leucothea* and *Cestum* make food capture and ingestion a continuous, conveyor-belt process. In contrast, many smaller ctenophores hang their tentacles out in the water and catch one prey at a time. Often their food consists of small crustaceans, but the genus *Lampea* has specialized in feeding on salps — gelatinous tunicates that often are larger than the ctenophore itself. The body of *Lampea* is capable of great extension and can engulf a salp in a matter of minutes. If the prey is much too large, the ctenophore fastens to the salp's body and rides along as a parasite.

Oceanic ctenophores constitute an important component of the zooplankton, interacting with other organisms in many different ways. Indeed, the diversity of form and function in oceanic ctenophores is so much greater than that found in any other part of the ocean that we believe most of the evolution of the phylum occurred in the open sea.

Scuba diving as a tool for plankton research can be criticized for its lack of quantitative precision, compared to plankton nets. Yet in the case of ctenophores, the precision of a plankton net is totally misleading. Our crude methods have already uncovered four times as many genera of ctenophores in the open ocean as all the net samples combined. More importantly, observation and collection by diving have made it possible to learn how these animals feed, escape predators, and interact with other organisms.

This elucidation of behavior is best illustrated by another aspect of our research — the biology of hyperiid amphipods. These animals are usually the third or fourth most abundant crustaceans found during plankton tows in the open ocean. One of our earliest underwater observations confirmed earlier speculation that amphipods live on different gelatinous organisms — medusae, siphonophores, ctenophores, and salps. The number and variety of amphipods we saw doing this was striking. During eight years of observations, we found that nearly all the surface living species, and 31 of a total 72 genera in the sub-order, are associated with gelatinous animals. As with ctenophores, the diversity of feeding behavior nearly matches the diversity of species.



Checking plankton samples aboard ship after diving expedition. (Photo by Anita Brosius. © 1979)



Attaining a meter or more in length, the belt-like *Cestum veneris* may be the commonest ctenophore in the Atlantic. (Photo by Laurence Madin)

Some genera are rather generalized predators. *Oxycephalus*, for example, is a large, fast swimming amphipod that tears ctenophores to pieces when feeding. But when a female *Oxycephalus* is ready to release her juveniles from the brood pouch, she does so on a large ctenophore that she herself leaves untouched, using it only to support her young.

Amphipods in the genus *Vibilia* are associated exclusively with salps, and live by stealing food. Sitting near the salp's esophagus, *Vibilia* uses its first pair of legs to divert part of the food collected by its filter-feeding host. Juvenile and female amphipods spend all their lives doing this inside salps; only the adult males are free-swimming, visiting females. Another genus restricted to salps is *Lycaea*. At least two species in this group have highly specific associations with particular species of salps. Unlike *Vibilia*, individual *Lycaea* commonly feed on the tissues of their hosts.

Several other hyperiid families specialize on siphonophores. *Eupronoe* juveniles are enclosed totally in the swimming bells (pulsating chambers) of *Forskalia*; their legs are so small in relation to their bodies that they cannot move. The closely related amphipod *Sympronoe* walks around on a very different siphonophore, *Rosacea*. Some of the species associated with medusae are immune to the stinging cells of their hosts, and even eat them; but others, on siphonophores, can be stung and killed if they are careless. Among the smallest hyperiid amphipods are the species of *Hyperietta*, which occur only in radiolarian colonies (gelatinous masses of microscopic protozoans with symbiotic algae).

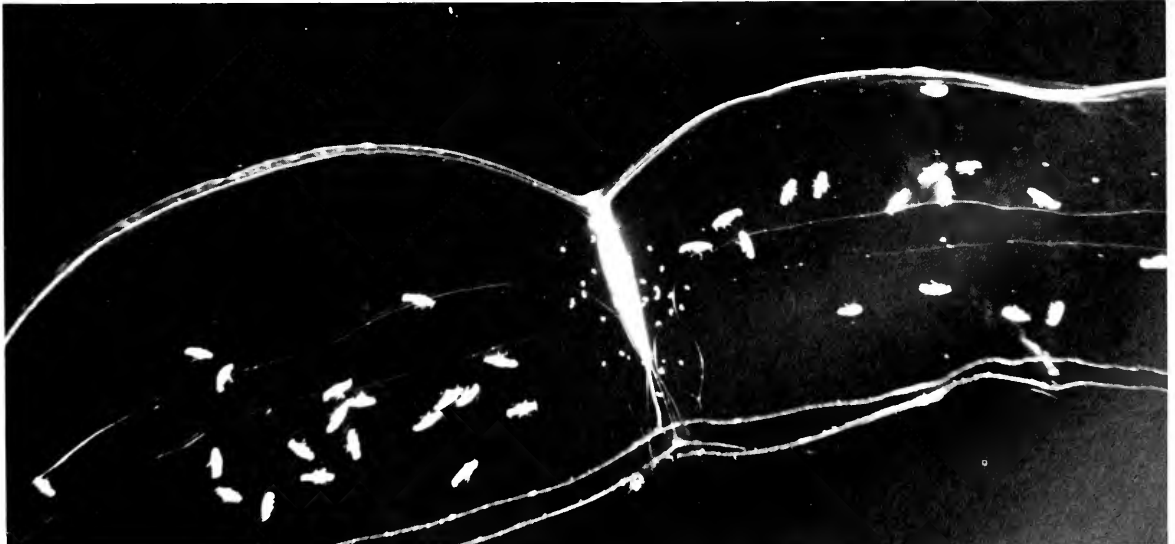

Juvenile amphipods, like these *Oxycephalus clausi*, often grow up on the body of a gelatinous host, here a *Cestum veneris*. (Photo by Douglas Biggs)



*Beroë cucumis* preys on other ctenophores. The holes were made by the amphipod *Hyperoche* (upper right). (Photo by Laurence Madin)

The relationship of hyperiid amphipods to their hosts is an aquatic parallel to the interactions among plants and plant-eating insects on land, exhibiting specificity, diversity, and, probably, a history of coevolution. The amphipods certainly are not typical free-swimming plankton, though they still are treated as such by some plankton ecologists. Although net samples can be analyzed in such a way as to provide information about amphipod associations, it is tedious and uncertain. Direct in situ observation and collection make the biology of these animals immediately clear.

Other researchers studying plankton in the field have learned a number of things that could never be discovered from net collections or shipboard experiments alone. For example, Ronald Gilmer, while a student at the University of California, observed that certain species of planktonic molluscs called pteropods feed with an external web of mucus that resembles a spider's web. The web may be as large as 2 meters across, and cannot be re-created in a laboratory tank. Other researchers have described in detail how amorphous organic aggregates (marine snow) are formed, and how they function as microcosms for a great variety of supposedly planktonic plants and animals. William Hamner, who developed the use of in situ methods for the study of plankton while at the University of California, has recently shown that

planktonic shrimp can follow scent trails in the water to locate food, and has investigated the swarming behavior of copepods.

#### A Look Ahead

Field studies of plankton are beginning to fundamentally alter our conception of animal life in the open ocean. Direct observation has disclosed a vast variety of interactions among planktonic animals. We have learned that there are many ways to survive in the pelagic environment, with organisms sometimes behaving differently than we had thought. Just as importantly, in situ plankton studies are another step in man's exploration of the earth, reminding us that remote sensing and robot devices cannot take the place of the scientist in the field until we know what it is we want to sense. For many purposes, it is still cheaper and more effective for a scientist to don a diving tank and take to the water.

Although plankton nets and remote devices will continue to be important in studying plankton, their design and use can be increasingly directed by the kind of data that divers gather. For example, even though we have found that most ctenophores are not retrieved by nets, we know that their



Immune to the stings and digestive enzymes of their host, these *Brachyscelus* roam at will over the medusa *Aequorea*. (Photo by Laurence Madin)

Casting a mucus web into the water around it, the pteropod *Gleba cordata* catches and eats small particles, living and dead. (Photo by Laurence Madin)



amphipod parasites can be collected, serving as an index to the presence of the hosts. Similarly, if we know predatory relationships, collecting the predator in a net can suggest the presence of its prey in the water. Specific elements of an organism's behavior, once known, can be the basis of design for sampling methods directed at that animal. As more is learned about the natural history of individual plankton, blind sampling can be replaced by specific and efficient sampling.

For the study of deep-living plankton, we believe that manned submersibles — equipped for lock-out diving and on-board experimental work — will provide the best opportunities to find out what is really happening in deep waters. The potential for exciting new research is enormous. Vertical migrators — squid, mid-water fishes, and bioluminescent organisms — are only a few of the animals that could be studied from such a vessel.

Experimental work on behavior, feeding biology, and sensory physiology could be guided and tested by field observations.

A great deal of what plankton biologists presently believe about the animals that inhabit the open sea is based on catch statistics, laboratory observations, computer simulation, or analogies with better known environments. New field studies are showing that many of the conclusions derived from these sources are in error. As more and more plankton biologists begin working underwater, rather than from the decks of ships, new areas of research will open up. The next decade of work in the open sea promises new and exciting discoveries.

*G. Richard Harbison is an Associate Scientist in the Biology Department of the Woods Hole Oceanographic Institution. Laurence P. Madin is an Assistant Scientist in the same department.*

#### Selected Readings

- Allredge, A. L. 1976. Discarded appendicularian houses as sources of food, surface habitats, and particulate organic matter in planktonic environments. *Limnol. and Oceanog.* 21: 14-23.
- Gilmer, R. W. 1972. Free-floating mucus webs: a novel feeding adaptation in the open ocean. *Science* 176: 1239-40.
- Hamner, P. P., and W. M. Hamner. 1977. Chemosensory tracking of scent trails by the planktonic shrimp *Acetes sibogae australis*. *Science* 195: 886-88.
- Hamner, W. M., L. P. Madin, A. L. Allredge, R. W. Gilmer, and P. P. Hamner. 1975. Underwater observations of gelatinous zooplankton: sampling problems, feeding biology, and behavior. *Limnol. and Oceanog.* 20: 907-17.
- Hamner, W. M. 1977. Observations at sea of live, tropical zooplankton. Proceedings of the Symposium on Warm Water Zooplankton. Goa, India, Oct. 14-19, 1976. Published by National Institute of Oceanography, Goa, India.
- Harbison, G. R., D. C. Biggs, and L. P. Madin. 1977. The associations of amphipoda hyperiidea with gelatinous zooplankton — II. Associations with cnidaria, ctenophora and radiolaria. *Deep-Sea Res.* 24: 465-88.
- Harbison, G. R., L. P. Madin, and N. R. Swanberg. 1978. On the natural history and distribution of oceanic ctenophores. *Deep-Sea Res.* 25: 233-56.
- Hardy, A. C. 1965. *The open sea: its natural history*. Boston, MA: Houghton Mifflin.
- Madin, L. P., and G. R. Harbison. 1977. The associations of amphipoda hyperiidea with gelatinous zooplankton — I. Associations with salpidae. *Deep-Sea Res.* 24: 449-63.
- Trent, J. D., A. L. Shanks, and M. W. Silver. 1978. In situ and laboratory measurements on macroscopic aggregates in Monterey Bay, California. *Limnol. and Oceanog.* 23: 626-35.

# What Drives the Waters of

by G. T. Csanady

An issue of considerable public interest at present is the construction of nuclear power plants. One of the many concerns voiced by opponents of nuclear power is the environmental impact of such plants. Under fire from the antinuclear lobby, the two main regulatory agencies involved — the Nuclear Regulatory Commission (NRC) and the Environmental Protection Agency (EPA) — have been forced to take positions sometimes leading to a distortion of priorities. One of the most serious has been the tendency to prohibit waste heat rejection into the Great Lakes or the coastal ocean and instead force utility companies to build cooling towers, where the waste heat resulting from power

generation escapes to the atmosphere rather than into large bodies of water. Because cooling towers are costly to build and operate, this has a general dampening effect on new power plant construction (nuclear or conventional). However, apart from the extra cost of electricity, cooling tower operation results in reduced sunlight due to clouds and fog in the vicinity of large installations, and severe icing of roads on a far greater number of days than normal in any given area.

Significant harmful effects attributable to waste heat rejected into open coastal waters have not been found anywhere. In fact, many conventional (non-nuclear) power stations in





# the Continental Shelves?

coastal locations around the world operate apparently without problems. However, there have been no detailed studies of the structure and climatology of coastal currents and mixing processes. Therefore in recent debates on the siting of nuclear power stations, extravagant claims regarding the long-term buildup of water temperature in the neighborhood of a projected cooling water discharge could not be easily refuted. Meanwhile, the regulatory agencies began requiring open-ended oceanographic studies of any such projected discharge, without a clear guideline as to how the results would be judged. How much research is enough research? What are better or worse sites for oceanic heat disposal? How is the environmental impact of an oceanic heat discharge to be estimated and compared with the rather serious consequences of cooling tower construction? For regulatory agencies to make informed licensing decisions, the properties of the coastal ocean should be thoroughly understood from a quantitative perspective.

The Woods Hole Oceanographic Institution has been involved in coastal waters research since its inception in 1930. In 1974, with financial support from the Department of Energy, it undertook a project to build the necessary conceptual framework for the understanding and prediction of water movements and mixing processes in the coastal ocean. Joint experimental work with Brookhaven National Laboratory (BNL) was carried out off Tiana Beach, Long Island, New York, to document the flow properties of the coastal boundary layer. This layer consists of a band of water adjacent to an open coast, some 10 kilometers wide, where motions are strongly influenced by the presence of the coast and differ in many significant respects from motions further offshore. This also is the region of the coastal ocean directly involved in arguments relating to environmental impact.

In addition to the Long Island experiment, Woods Hole carried out basic research on the large-scale oceanic setting of the coastal boundary layer, the hydrodynamics of the continental

shelves. This has led to some important general insights that help place the environmental impact question in perspective.

## Trapped Pressure Fields

One of the early ideas in coastal oceanography was that a "mound" of water generated off a straight open coast could not persist for very long because surface level disturbances propagate very rapidly upcoast and downcoast, if not out to sea. High tides, for example, are mounds of water that come and go, propagating with speeds approaching 100 kilometers an hour. A few years ago, it was universally thought that when winds — for example,



---

*Cooling tower, right, dwarfs the Davis-Besse Nuclear Power Station in Ohio. The tower was designed to dissipate 98 percent of the waste heat from the plant to the atmosphere by means of evaporative cooling. The remaining 2 percent was to be discharged to Lake Erie. (Photo courtesy Department of Energy)*

*Left, the Atlantic off the Long Island coast. (Photo by Peter Gavin, PR)*

during a hurricane — pile up the water against a local coast, the disturbance propagated away rapidly. We now know that this is not so. A coastal mound or hollow of water, if accompanied by an appropriate distribution of currents, can be quite persistent. Key factors contributing to the persistence of mounds or hollows on the surface of the coastal ocean are, in addition to the wind, the rotation of the earth, and the changing depth of shelf and slope regions with distance from shore.

From the physical oceanographer's point of view, mounds and hollows on the surface represent a field of pressure in the water below, much the same as highs and lows on a weather map. In the region between a high and a low, the water is being pushed more on the high side than on the low side, and tends to flow "downhill" from the mound toward the hollow. However, on a rotating earth, the relatively small pressure differences in atmospheric or oceanic highs and lows produce flow nearly parallel to the high and low contours in a condition known technically as geostrophic balance. The rotation of the earth results in a deflecting force on any moving object, including moving particles of air or water, known as the Coriolis force. This force causes moving particles to be deflected to the right in the Northern Hemisphere and to the left in the Southern Hemisphere; the deflection is proportional to the speed of the moving particle, and to the sine of geographic latitude. Geostrophic balance is a state of equilibrium between the Coriolis force and the push of the water from a region of high to low pressure.

In a coastal region of variable depth, the establishment of geostrophic equilibrium is

constrained by continuity. When water flows from a deeper to a shallower region, the same rate of flow must be accommodated in a reduced cross section, so that the speed increases correspondingly. However, increased speed also means increased Coriolis force, which requires increased pressure differences for geostrophic balance, such as steeper mounds and hollows near the coast. Thus mounds and hollows, if they are to persist, must have rather special shapes to satisfy the various constraints placed upon them.

Using simple coastal zone models, it is possible to calculate the distribution of highs and lows that may persist indefinitely with a given distribution of surface wind. Consider, for example, the coastline of the Mid-Atlantic Bight (Figure 1). Average winds in this region are west-north westerlies, which point more or less directly offshore in New Jersey, but are more parallel to the coast off Long Island. The most effective part of the wind force exerted on the surface of coastal waters is its projection parallel to the coast, which can cause relatively unhindered flow. This component of the wind force is seen to vary from place to place according to the orientation of the coastline: the mean wind indicated in Figure 1 has a large longshore projection off Long Island, a small one off New Jersey.

The curvature of the coastline — or of the constant depth contours that are more or less parallel to the coast — has little influence on the motions induced by wind or other factors, so that mathematical models of open coastal regions can be straight, for the sake of simplicity. The details of how the depth varies with distance from shore are more important, but the main physical effect is

Figure 1. Portions of the coastline of the Mid-Atlantic Bight near New York, showing forces driving the circulation over a typical ocean continental shelf. These include the wind force, freshwater inflow, and an alongshore sea-level slope. Inflow and outflow across open boundaries of a chosen shelf region complicate the mathematical modelling of these phenomena.

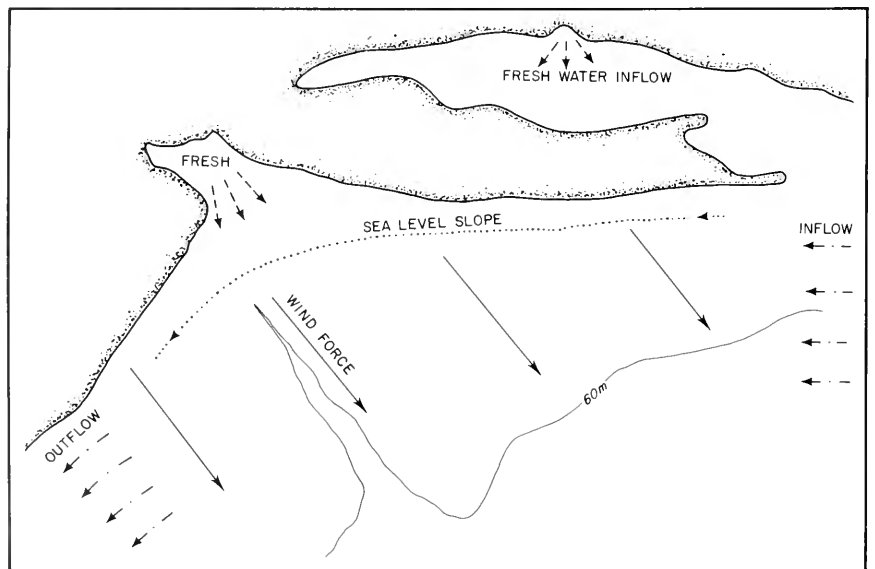

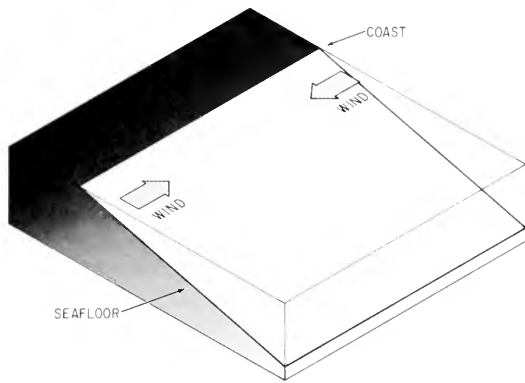

Figure 2. Idealized straight coast and inclined plane beach, subject to variable longshore wind.

captured by a sloping plane beach model (Figure 2). The variability of the longshore wind-stress projection is simply modelled by a sine wave — the wind blowing upcoast in some regions, downcoast in others, with smooth variation in between. Upcoast is taken to be the direction with the coast to the left, the ocean to the right — for example, northeastward along the east coast.

The calculated sea level distribution for a straight, sloping beach under variable longshore wind is shown in Figure 3, which illustrates a series of mounds and hollows elongated in a direction at a small angle to the coast. The elevation or depression of the surface becomes negligible at some distance from the coast; or, in common theoretical terminology, the pressure field is coastally “trapped.” This peculiar distribution of surface levels results from the combined effect of earth rotation, bottom slope, and friction: delete any one of these, and the trapped field disappears. On the other hand, changing the magnitude of the bottom slope, or of friction, merely changes the width of the trapped field. Therefore, one can be fairly sure that in the more complex natural geometry of the coastal waters similar trapped fields also occur.

Model calculations yield a streamline picture of the flow field that accompanies the pressure field (Figure 4). Very close to shore the flow is downwind everywhere: it is upcoast where the wind blows upcoast, downcoast where the wind blows downcoast. Far from shore, on the other hand, the flow is perpendicular to the wind — offshore where the wind blows upcoast, onshore where the wind blows downcoast, but always to the *right* of the wind. This type of flow is known as Ekman drift in honor of Walfrid Ekman, the Norwegian theoretical oceanographer who first explained it. The function of the coastally trapped pressure field is to bring about a transition between the downwind flow at the coast and the Ekman drift far offshore.

Given the physical characteristics of the continental shelf in the Mid-Atlantic Bight, the width of the coastally trapped pressure field (beyond which the elevation disturbance becomes small) is typically 30 kilometers. Wind effects, with their localized mounds and hollows tied to the orientation of the coastline, are therefore strongly felt within the first 10 kilometers from the coast, in the coastal boundary layer. Studies of coastal sea levels, and of level differences between tide gauges separated by a few hundred kilometers, sometimes demonstrate such effects with particular clarity. Bradford Butman, in his Ph.D. thesis (prepared in the Massachusetts Institute of Technology — Woods Hole Oceanographic Institution Joint Program in Oceanography), has contributed the illustrations reproduced as Figures 5 and 6.

Coastally trapped pressure fields also occur in response to other factors. The offshore wind component is somewhat less effective in this regard (surprisingly, perhaps), but nevertheless important. Figures 7 and 8 show three illustrations of mounds and hollows caused by a variable offshore wind. The influx of freshwater, especially from such massive sources as the St. Lawrence estuary, also generates a local mound, somewhat downcoast of the discharge. The St. Lawrence mound apparently extends over the entire shelf off Nova Scotia and even portions of the Gulf of Maine. All of these effects are confined essentially to the vicinity of an

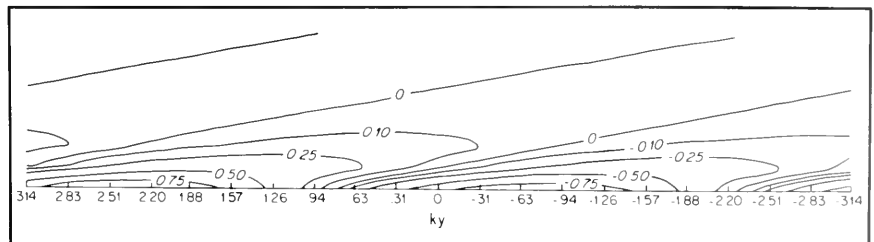

Figure 3. Contours of constant sea level elevation calculated from model, with idealizations as illustrated in Figure 2. A full “wave” of the wind is shown from  $ky = -\pi$  to  $+\pi$ . At  $y=0$ , the wind blows with maximum strength to the left. The  $y$  axis is the coastline. Significant elevations are confined to a narrow nearshore band.

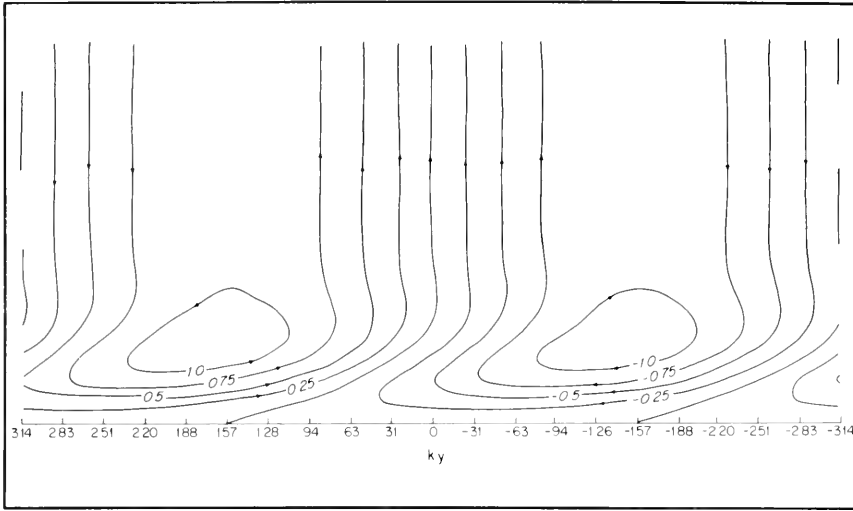

Figure 4. Streamline picture of steady flow associated with elevation pattern of Figure 3.

open coastline, or to pronounced embayments such as Long Island Sound and the Gulf of Maine.

### Shelf Circulation

As one turns one's attention from local influences, such as coastline orientation or river inflow, to the larger picture of circulation over major portions of the continental shelf, one discovers a nearly uniform mean flow pattern. Along the east coast of North America, for example, the shelf waters move generally northeastward from Miami to Cape Hatteras, and southwestward from the Grand Banks of Newfoundland to Cape Hatteras. Using various types of drifting objects, Dean Bumpus of the Woods Hole Oceanographic Institution and others have shown that the southwestward drift north of Cape Hatteras encompasses the entire continental shelf with the exception of embayments and nearshore waters, and indeed extends beyond the shelf-break — the line where the depth begins to increase more abruptly at the edge of the North American continental plate. In recent years, Robert

Beardsley of the Woods Hole Oceanographic Institution and other investigators, utilizing the newly developed moored current meter, confirmed that such relatively uniform mean flow patterns extended over large areas.

The proximate cause of the southwestward drift north of Cape Hatteras is a sloping down of the sea surface southwestward. Geodetic levelling carried out in North America in the 1930s, which at that time was thought to be quite precise, showed such a sea level slope. Later work led scientists to question the accuracy of geodetic levelling and to reject the result relating to coastal sea level slope. However, more recent studies on shelf circulation, including those already mentioned, helped reestablish the reality of the sea level slope. One argument is that the water moving toward the southwest must be running downhill against the opposing eastward forces of bottom friction and wind because there is no other plausible force that could drive it.

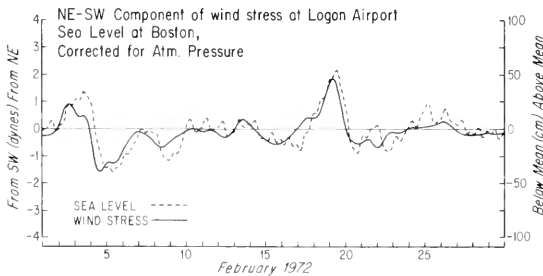

Figure 5. Smoothed history of sea level at Boston for February 1972, compared with cross-shore component of wind force as measured at Logan Airport. (From Ph.D. thesis of Bradford Butman)

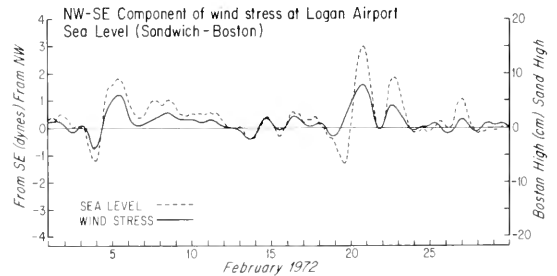

Figure 6. Sea-level difference between Sandwich (on Cape Cod) and Boston, compared with component of wind force that points alongshore on this region of coast. (From Ph.D. thesis of Bradford Butman)

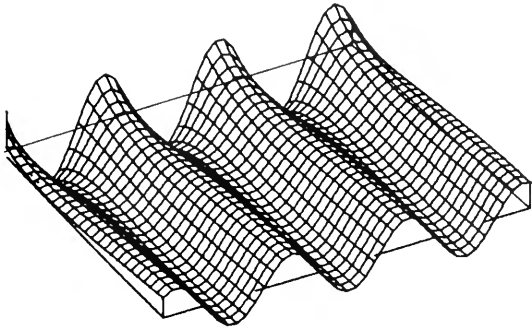

Figure 7. Hills and valleys on sea surface (greatly exaggerated vertically) generated by offshore wind varying sinusoidally alongshore.

There are, however, more subtle clues to the presence of a longshore sea level slope. If such a slope is indeed present, and if it is *not* trapped within a narrow coastal band as in the models discussed earlier, but is more or less the same at increasing distances from shore, then its influence should be stronger as the water gets deeper, because the force of gravity there acts on a larger water mass. The larger total gravity force should drive the deep water faster. Current meter studies have shown precisely such behavior. Furthermore, in deeper water — 100 meters or so — the middle of the water column is outside the direct influence of wind force or bottom friction and the flow should be in the geostrophic balance condition described earlier. This means that where the sea surface slopes southwestward, an *onshore* component of the flow should be superimposed on the southwestward drift. This again is found to be present not only over the shelf, but also well beyond the shelf-break. The result shows not only that a southwestward slope is present, but also that it extends, more or less undiminished, a long distance from shore, quite unlike the trapped fields discussed previously.

A final, rather intriguing clue to the mean longshore sea level slope is the line of divergence of bottom drift discovered by Bumpus. The wind force over the continental shelf from Cape Hatteras to the Grand Banks of Newfoundland is generally eastward, tending to cause strong offshore flow at the surface, with a return flow in the interior of the water column, including the layer directly above the sea floor. Freshwater influx adds to the offshore surface drift, with some compensating onshore flow near the bottom. A southwestward sea level slope, on the other hand, induces onshore flow both near the surface and in the middle of the water column, with a compensating offshore flow near the sea floor. The flow that results above the sea floor depends on the relative strength of these

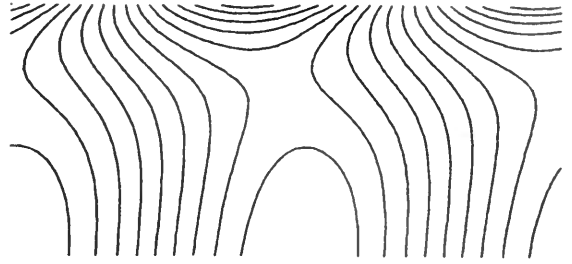

Figure 8. Contours of hills and valleys in Figure 7 in an illustration similar to Figure 3. The skewness of the contours does not show up well on the three-dimensional drawing.

factors. The wind force and freshwater influence act in much the same way everywhere. The gravity force associated with the sloping level, on the other hand, depends on depth, being weak in shallow water and strong where the water is relatively deep. Therefore the wind and freshwater influx “win” in shallow water nearshore and cause onshore bottom drift. At about the 60-meter depth line, the relationship changes and the sea level slope begins to win, so that the bottom drift is seaward further offshore. A line of divergence thus occurs in bottom drift near the 60-meter isobath, as was inferred by Bumpus from the motion of mushroom-like bottom drifters that hop over the seabed when dragged along by bottom currents.

A sea level slope over large regions of the continental shelf and slope is a much larger-scale phenomenon than the trapped fields discussed previously. It is plausible that pressure fields of such scale relate to deepwater oceanic gyres (basin-wide circulation of large bodies of water). If a mathematical model of shelf circulation is constructed, based on principles similar to the trapped field, but having the longshore slope impressed at the seaward edge of the shelf, the observed features of shelf circulation are reproduced with remarkable accuracy. In a manner of speaking, the deepwater gyre drives the larger-scale shelf circulation; or, more accurately, shelf circulation is a component (what hydrodynamicists describe as a boundary-layer component) of a deepwater gyre.

Different regions of the continental shelves of the world ocean are affected by different deepwater gyres. Off the east coast, the Gulf Stream affects the flow from Miami to Cape Hatteras, and generates a northwestward slope. A narrow, counterclockwise gyre between the Gulf Stream and the continental margin generates the southwestward sea level slope north of Cape Hatteras. The physical factors responsible for this latter gyre are not well known (surprisingly perhaps,

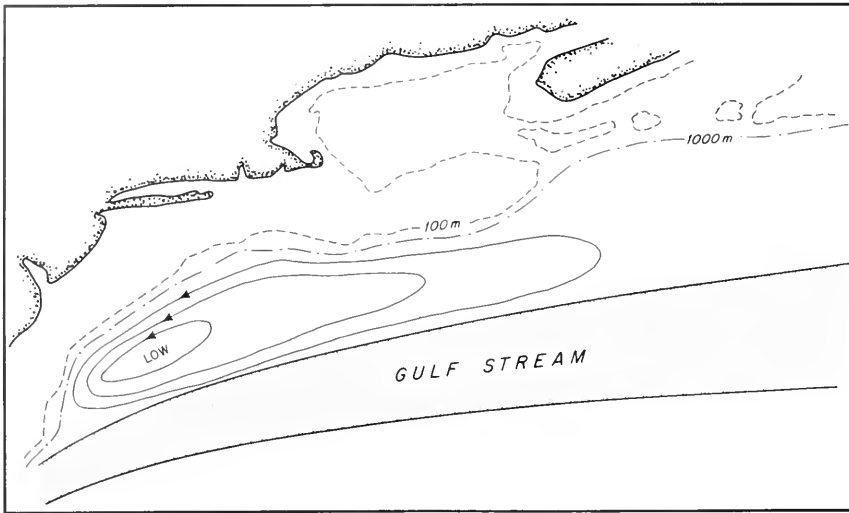

Figure 9.  
Counterclockwise gyre  
between the Gulf Stream  
and the North American  
continent.

in view of its proximity to large North American population centers) but some reasonable speculations can be made.

One major factor is the variation of wind force with distance from shore. Over the warm waters of the Gulf Stream, the air rises and stirs up the atmosphere, bringing the faster-moving air layers above (the jet stream and its surroundings) into closer contact with the water surface. The result is a particularly strong eastward wind force over the Gulf Stream, which has been dramatically illustrated in charts of the wind force by Andrew Bunker and L. Valentine Worthington of the Woods Hole Oceanographic Institution. The Ekman drift, which the wind sets up in the oceanic surface layer, is much stronger over the Gulf Stream than closer to shore. The direction of the Ekman drift is generally offshore in this region, and the sudden increase in its intensity over the Gulf Stream has the effect of depleting the surface waters just to its north. A trough or surface low tends to be generated between the Stream and the mainland. Low-pressure regions in the ocean generally migrate spontaneously westward, leading to a "westward intensification" of currents, a principle elucidated by Henry Stommel of Woods Hole some 30 years ago. If the same effect operates in the narrow region between the Gulf Stream and the mainland, it should produce a low with its center shifted close to Cape Hatteras (Figure 9). Northwest of the low center, the sea surface slopes down in a generally southward direction and presumably produces the effects on the shelf previously discussed.

This conceptual model lacks many details. It is necessary to investigate what other contributing factors might be involved in the generation of the counterclockwise gyre north of the Gulf Stream. Whatever the outcome of future investigations, we

know today that the leg of this gyre over the shelf and continental slope transports a large quantity of water southwestward, about 10 million cubic meters per second. A small fraction of it — 2 to 3 percent — passes over the continental shelf proper, depending on precisely where one places the shelf boundary. This large-scale, counterclockwise gyre is not a local effect, but is produced by the action of the atmosphere on the ocean, exerted over many thousands of square kilometers. Thus this is a massive natural phenomenon, presumably changeable over time spans of climatic variations.

### A Summing Up

What can one learn from these newly gained insights into the mechanics of shelf circulation in terms of such practical matters as power plant siting? One general result is the awesome scale of the counterclockwise deepwater gyre north of the Gulf Stream, which is actually small by oceanic standards. Its total longshore transport ( $10^7 \text{ m}^3 \text{ sec}^{-1}$ ) is equal to the discharge of 500 Mississippi rivers, all flowing within some 200 kilometers of the shore. The waste heat of a thousand large power plants (1,000 megawatts each) would only heat up this stream by 0.3 degrees Fahrenheit — if, that is, the radiation of this heat into space could be prevented somehow.

The only legitimate remaining question is whether waste heat discharged nearshore can be efficiently transferred to the vast and dynamically active offshore mass of water. Local circulations of the kind we have discussed in connection with trapped pressure fields are particularly effective in promoting such exchange. So are differences in onshore-offshore motions between various parts of the water column. Direct evidence of the efficiency of onshore-offshore mixing processes is the rapid

disappearance of the freshwater runoff: in an open coastal region, even very close to land, it is hard to find freshwater diluted less than thirty-fold. Coastal lagoons discharge heated water on the ebb-cycle of a summer day into the coastal ocean. As it happens, the heat emptied on an ebb cycle into the ocean during a summer day by a medium-sized lagoon is comparable to the daily waste heat output of a large power station. The warm plumes flowing out from such lagoons are quickly dissipated, their heat being distributed over a large coastal water mass. This, in turn, is effectively mixed with the massive shelf-slope current, and ultimately with the mass of the world ocean.

Evaluation of the observations recently carried out in the coastal boundary layer off Long Island will provide the quantitative background necessary for making more specific estimates of the exchange rates between nearshore and offshore waters. These are expected to be important in predicting such matters as the concentration in nearshore waters of heavy metals and of other undesirable constituents of municipal waste. It also will be possible to know precisely what degree of temperature buildup is likely to occur in the vicinity of any waste heat discharge, even if such a buildup, in light of the facts presented, is unimportant. Although legitimate environmental issues exist in connection with power plant siting (see page 36), it would appear that waste heat disposal in an open coastal environment may not be one of them.

*G. T. Csanady is a Senior Scientist in the Physical Oceanography Department of the Woods Hole Oceanographic Institution.*

#### References

- Beardsley, R. C., W. C. Boicourt, and D. V. Hansen. 1976. Physical oceanography of the mid-Atlantic bight. Special symposia, Vol. 2, pp. 20-34. Amer. Soc. Limnology and Oceanography.
- Bumpus, D. F. 1973. A description of the circulation on the continental shelf of the east coast of the United States. *Progr. Oceanogr.* 6: 111-57.
- Csanady, G. T. 1978. The arrested topographic wave. *J. Phys. Oceanogr.* 8: 47-62.
- — —. In press. The pressure field on the western margin of the north Atlantic. *J. Geophys. Res.*

# Chlorine in the





# Marine Environment

by Joel C. Goldman

Of the many hazardous chemicals being introduced into the marine environment, chlorine has one of the most paradoxical histories. This chemical is a powerful oxidizing agent, and its uses have ranged from the most hideous — it was one of the many poison gases of World War I — to the common household cleanser, bleach. Attainment of the very high standards of public health enjoyed in the United States, to a large degree, has been possible through the continuous application of small doses of chlorine to drinking water supplies. For example, until the turn of the century, waterborne outbreaks of two of the deadly killers of mankind, typhoid fever and cholera, were common throughout the United States. With the introduction of chlorine as a disinfecting agent in municipal water supplies in 1908, the death rate in the United States from waterborne diseases dropped dramatically. This result is demonstrated by the sharp decrease in the incidence of typhoid fever soon after chlorination was started in one major American city, Detroit, which receives its drinking water from a nearby lake (Figure 1).

Today chlorination of municipal water supplies is a common practice throughout the United States and in many other parts of the world. The taste that we sometimes notice in tap water is the chlorine residual, which is the small excess of chlorine added to maintain high-level disinfection of the water supply all the way to the end of the pipeline at our home or business. In addition, industrial and other public service uses of chlorine are extensive. As of 1975, more than 10 million tons of this chemical were manufactured in the United States, of which more than 95 percent was used exclusively for various industrial applications. The rest, about 400,000 tons, was used for biocidal functions, such as disinfection of swimming pools, public water supplies, and wastewaters, and for the control of fouling in cooling water systems.

## Environmental Impact on Man

In recent years, there has been a growing awareness among environmentalists and members of the health professions that the tremendously positive role chlorine plays in preventing the outbreak of

*The San Francisco Bay-delta waterway, one of the largest estuarine systems in the United States. One of the most serious threats to marine life in this area is the residual chlorine present in domestic wastewaters being discharged directly into the bay. (Photo courtesy U.S. Army Corps of Engineers)*

waterborne diseases may be offset by an insidious, but as yet poorly understood, threat it poses to man and his environment.

Because of its great oxidizing power, chlorine is highly reactive and thus combines in a variety of ways with both inorganic and organic compounds. Based on recent evidence, it is now confirmed that chlorination of waters, such as rivers and lakes containing relatively large quantities of organics, can result in the formation of numerous chlorinated organic compounds, including the trihalomethanes (most notably chloroform). These latter compounds, along with a growing list of other chlorinated organics (Table 1), are known or suspected carcinogens and mutagens. Through an elaborate nationwide surveillance program to identify and quantify these compounds, the United States Environmental Protection Agency has found significant levels of these chlorinated organics in numerous water supply systems throughout the country.

Public concern over the widespread presence of carcinogens in drinking water stems from the results of two recent epidemiologic studies in the United States that were popularized by the news media. It was found that the incidence rate of gastrointestinal cancers in test populations in Louisiana and Ohio was significantly higher for those who drank water originating from surface water supplies than for those serviced by

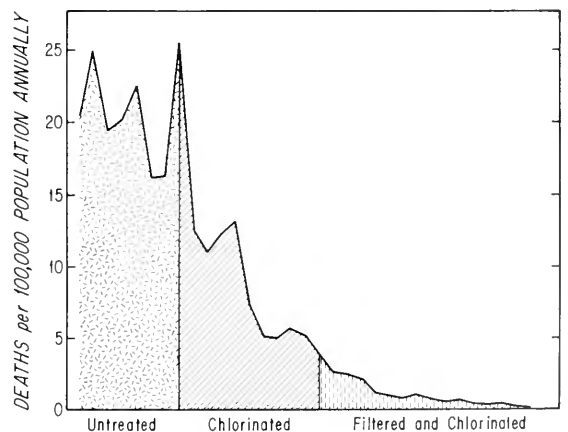

Figure 1. The effect of chlorination and filtration on the death rate from typhoid fever in a typical American city — Detroit, Michigan — that started chlorination of the public water supply soon after 1900.

**Table 1. Major halogenated compounds found in water supplies suspected of posing serious health hazards to man.**

**Chloro-esters**

- Bis (2-chloroethyl) ether
- Bis (2-chloroisopropyl) ether

**Halobenzenes**

- Chlorobenzenes
- Bromobenzenes
- Chloro-bromo-benzenes

**Haloforms**

- Chloroform
- Bromodichloromethane
- Dibromochloromethane
- Bromoform

groundwater systems. Although chlorinated organics were not pinpointed as the causative agents, surface waters tend to contain much greater organics and require more extensive treatment, including chlorination, than groundwaters. For example, the Mississippi River is both the source of drinking water and the wastewater repository for numerous communities along its banks, including New Orleans, where one of the studies was performed. By the time the flow reaches New Orleans, very large inputs of organics have occurred, and the water has been recycled and chlorinated repeatedly. These facts, together with the available epidemiologic evidence, make for a strong cause-effect relationship between chlorination and increased risks of gastrointestinal cancer.

**Chlorine in the Marine Environment**

Our main concern with chlorine in the marine environment is the potential damage it may do to the biota, particularly its possible disruption of the food chain, leading to both aesthetic deterioration of the coastal environment, and economic hardship to those who depend on the sea for their income.

Chlorine finds its way into the marine environment by numerous paths (Figure 2). Because of its reactivity, uncombined or "free chlorine" does not exist for long in natural fresh and marine waters. But, when it combines to form chlorinated organic compounds, it may persist for extremely long periods, because many of these compounds are highly resistant to biological or chemical oxidation. In a recent study, Robert Jolley, at the Oak Ridge National Laboratory, identified more than 50 chlorinated organic compounds formed upon chlorination of wastewater. According to his estimates, potentially more than 5,000 tons of these compounds are released annually into the aquatic environment. And, because more than a third of our population lives in

coastal areas, mostly in urban centers, a great deal of this chlorinated organic waste load eventually finds its way into the coastal marine environment.

Little is known about the effects of these compounds on various marine species, mainly because the seriousness of the problem has been only recently identified. However, it is reasonable to assume that the potential effects of these compounds are similar to those of the commercially prepared chlorinated organics, such as DDT and PCBs. The main threat is that these compounds are resistant to degradation so that they are taken up by organisms and accumulated in biomass (biomagnified) as smaller marine species are fed upon by larger organisms. Off the coast of Southern California, for example, there are numerous ocean outfalls discharging chlorinated wastewater into the coastal environment. Recent studies have uncovered that bottom-dwelling and other fish species in these areas — such as queenfish, flounder, kelp bass, and black perch — tend to accumulate at very high levels such major identified chlorinated organics in discharged wastewaters as DDT, PCBs, and chlorinated benzenes. During the spring of 1976, a large number of captive birds in the Los Angeles City Zoo that suddenly died were found to exhibit pesticide poisoning. Subsequently, it was determined that the source of this poison was



*Section of outfall pipe near discharge outlet in Santa Monica Bay, California. Area is nearly five miles from shore. The white (colonial) animals on top of pipe are Metridium senile. Fish are various Sebastes. (Photo courtesy William Bascom, Southern California Coastal Water Research Project)*

Figure 2. Sources of uncombined chlorine and chlorinated organics in the coastal marine environment. The buildup of chlorinated organics in rivers occurs as communities downriver recycle water with successively more chlorine added. The coastal environment is the final repository for the chlorinated organics formed during transport down the river.

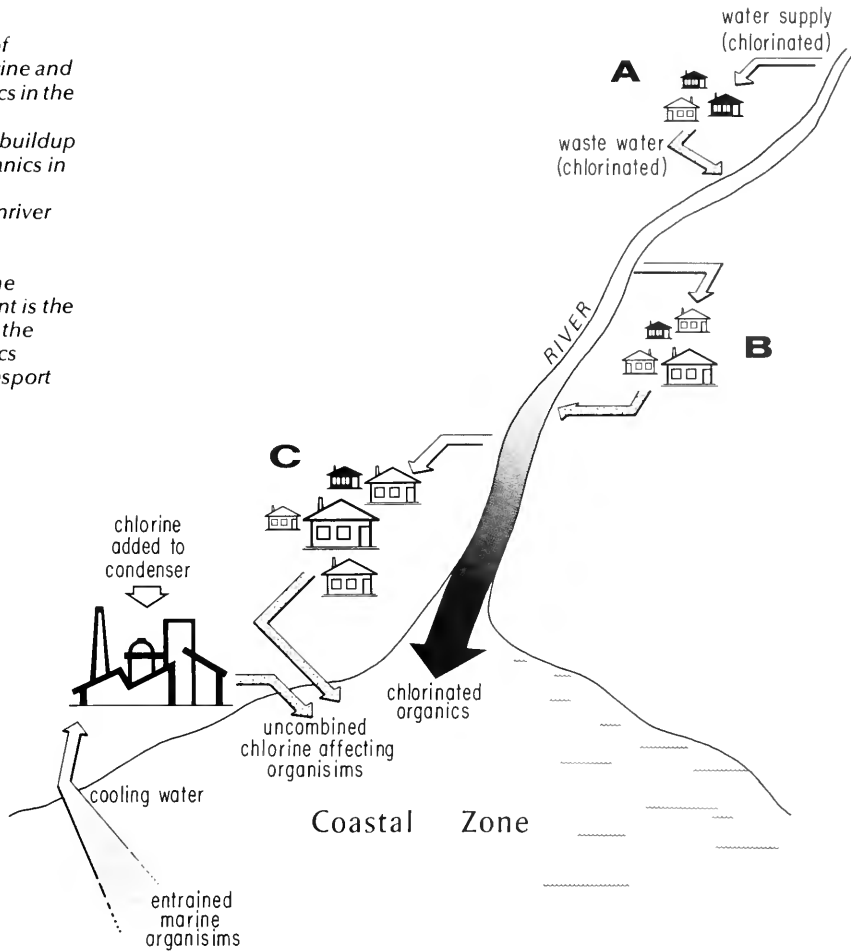

accumulated DDT in the bird's food — queenfish caught in the vicinity of the ocean wastewater outfalls. In another recent study, it was shown that two chlorinated compounds associated with wastewaters, 4-chlororesorcinol and 5-chlororesorcinol, in concentrations as low as 1 microgram per liter, could cause reductions in the hatching of carp eggs. Clearly, a major research effort is needed to identify and quantify these compounds, determine their modes of transport in the marine environment, and assess their effects on marine biota.

In contrast to the poorly defined impact of naturally formed chlorinated organics in the marine environment, considerably more is known about the destructive capacity of reactive chlorine. Reactive chlorine is chemically unstable. It may combine with ammonium ions to form chloramines, which are somewhat more stable but have less biocidal power than free chlorine; but none of the reactive chlorine compounds persist for long in the marine environment.

The chemistry of chlorine in seawater is exceedingly complex. It is now well established that

chlorine reacts with bromide, a conservative constituent of seawater, to form bromine compounds. It is these latter halogens that act as biocides in the marine environment. The relative biocidal action of chlorine versus bromine is not well understood, but both sets of compounds have great destructive power. When chlorine is added to seawater, two events occur. First, there is a rapid loss that is associated with the oxidation of organics present. Second, there is a slower, but persistent loss that cannot be attributed to any oxidative reactions. This loss, as measured by any of several standard analytical techniques, does not appear to have a saturation limit. Because nothing is known about the chemistry of this loss and because it is unique to seawater, the unrecoverable chlorine (in whatever form) must remain suspect as a potential biocide. This result presents a serious dilemma to biologists and environmental scientists because there is 1) no way of knowing what the fate of the "lost chlorine" is, and 2) no way of assessing the environmental impact of a particular chlorine application.

Reactive chlorine enters the coastal

environment primarily in two ways: through chlorination of wastewaters being discharged directly into marine or estuarine waters, and through chlorination of entrained waters used for cooling in coastal power plants (Figure 2). To gauge the potential impact of these two sources on marine biota, it is instructive to examine the results of two recent environmental studies on the subject.

### Wastewater Chlorination

The San Francisco bay-delta waterway is one of the largest estuarine systems in the United States. More than five million people live in bordering communities, and by 2020, the population is expected to reach 16 million. The bay-delta system plays a vital role in the affairs of the community and it is imperative that high standards of water quality be maintained. To this end, several major investigations have been undertaken during the last 20 years by state and university organizations. Recently, scientists at the University of California at Berkeley carried out an extensive study to determine the sources of toxic material entering the bay-delta, and the impact of the material on marine life in that area. In this study, all sources of toxic material were considered, including industrial, domestic, and agricultural wastewaters. Through fish bioassay experiments with elaborate continuous-flow systems, it was found that one of the most serious threats to marine life in the bay-delta was the residue of chlorine present in domestic wastewaters being discharged directly into the bay. By simply dechlorinating the

wastewaters through additions of strong reducing chemicals, such as sodium bisulfide, the toxicity was completely eliminated. Corroborative evidence for this finding came from a related study in which a strong correlation between increased chlorination of wastewaters discharged into the bay and reductions in landings of the dungeness crab, once a commercially important indigenous species, was found.

By the year 2020, more than two billion gallons per day of domestic and industrial wastewaters are expected to be discharged into the bay-delta. Certain areas, particularly the south bay where the city of Oakland is located, have minimal circulation, but nevertheless contribute a sizeable fraction of the waste load to the waterway. For obvious public health reasons, disinfection of the discharged wastewater is required. To control the releases of pathogenic bacteria into the bay, while at the same time protecting marine biota from chlorine toxicity, it has become a standard practice among municipal wastewater dischargers to the bay to remove chlorine residuals before final discharge. Today, most of the chlorinated wastewaters in California are dechlorinated prior to discharge.

### Power Plant Chlorination

Power plants require tremendous quantities of cooling water to dissipate unused heat energy. It is estimated that by 1985 almost 700 million gallons per day of cooling water will be required in the United States for nuclear-fueled plants located in marine settings. Water entrained for cooling purposes contains a variety of marine organisms — from the

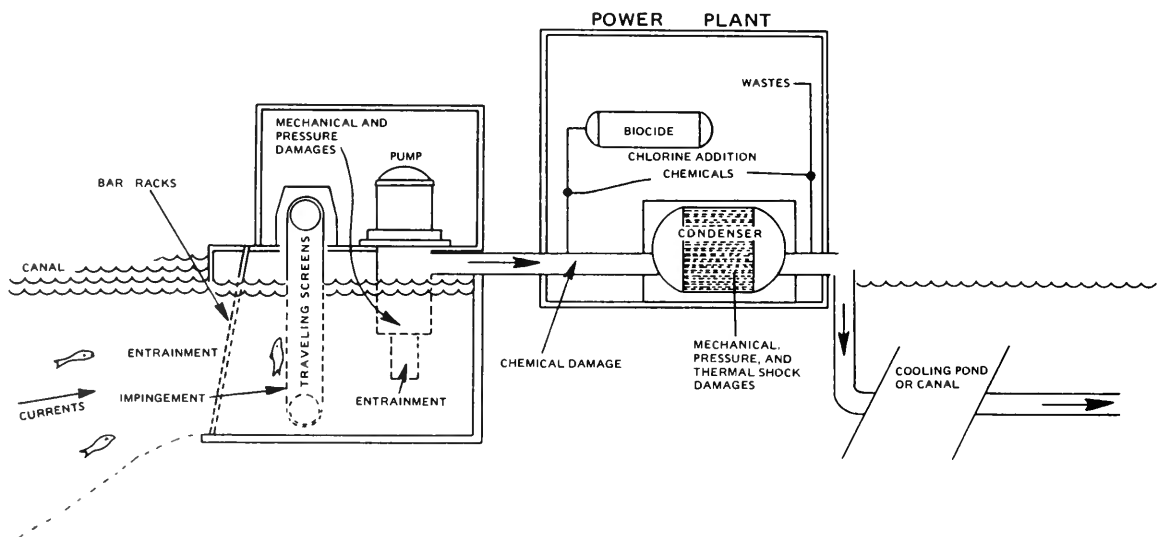

Figure 3. A condenser cooling system and sources of potential biological damage. (Courtesy John Clark, American Littoral Society)

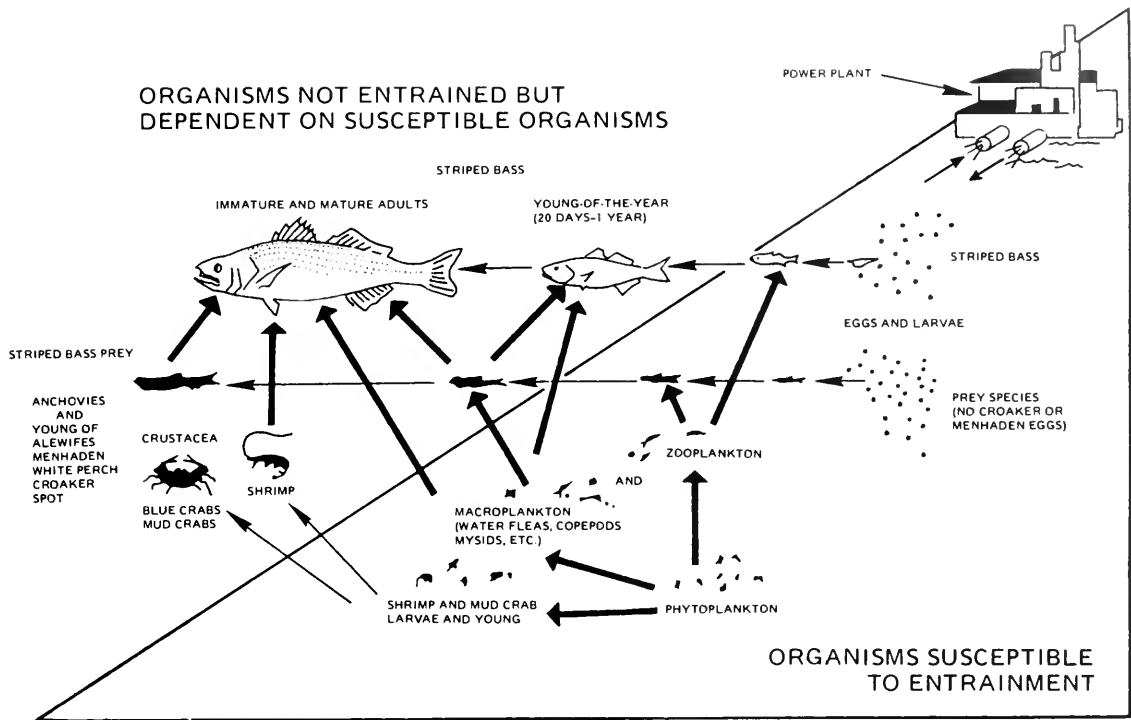

Figure 4. Damage done in an estuarine ecosystem to organisms susceptible to entrainment can affect young-of-the-year and adult striped bass. (Courtesy John Clark, American Littoral Society)

smallest bacteria to large zooplankton, and even small fish. Screening devices are usually installed to prevent entrainment of larger organisms.

To control fouling caused by bacterial slimes and nuisance larvae, such as barnacles and mussels, within the condenser system and connecting pipelines, chlorine is added as a biocide. In American power plants, chlorine is applied intermittently, usually for 20- to 30-minute periods, two to three times daily, whereas in Great Britain continuous low-level chlorination is practiced.

In the United States chlorination is practiced in more than 90 percent of the power plants, representing an annual usage rate of more than 100,000 tons. Hence, the environmental impact of power plant chlorination is a two-fold problem. First, entrained organisms are exposed to a shock dose of chlorine when the biocide is applied (Figure 3); and second, any chlorine remaining when the cooling water is returned to the receiving water can affect organisms in the area. Generally, the entrainment problem is the more serious of the two (Figure 4). This is because the easily entrained plankton and small fish are fragile and, hence, experience the most severe stresses during power plant operation. Not only are these organisms exposed to chlorine, but they suffer severely from mechanical damage and from heat shock during entrainment. Edward J. Carpenter, formerly of the Woods Hole Oceanographic Institution and now at the State University of New York at Stony Brook, has

outlined in detail the problems associated with power plant entrainments (see *Oceanus*, Vol. 18, No. 1, page 35, 1974).

In a recent three-year study at the Woods Hole Oceanographic Institution, the effect of chlorine on marine plankton was examined. The study involved bioassay experiments with phytoplankton, zooplankton, larval invertebrates, and juvenile fish. Because entrained organisms are exposed to the combined effects of chlorine and heat shock, any meaningful bioassay must simulate to some degree these stresses. To meet these criteria, bioassay systems were developed with the common features of continuous-flow, short-term toxicant exposure, and/or heat rise, rapid elimination of these stresses, and subsequent long-term observation of the test organisms. Thus the history of a test species was simulated as it might pass through an entrainment and enter a receiving water.

During the three-year study period, a wide variety of marine species were examined (Table 2). The results, summarized in Figure 5, revealed several important trends. There appeared to be a general pattern of differences in the modes of chlorine toxicity affecting marine invertebrates and vertebrates. Juvenile fish responded in a step or threshold fashion: that is, there were no deaths up to a certain toxicant level and then all died beyond that level. On the other hand, the various invertebrate species responded in a classical

**Table 2. Marine planktonic species tested for response to chlorine toxicity in bioassay experiments at the Woods Hole Oceanographic Institution.**

**Phytoplankton**

Test diatom (*Phaeodactylum tricoratum*)  
 Natural assemblages from power plant entrainments.

**Zooplankton**

Copepods (*Acartia tonsa*)  
 Rotifers (*Brachionus plicatilis*)  
 Natural assemblages from power plant entrainments.

**Larval invertebrates**

Lobster-stage I and IV (*Homarus americanus*)  
 Oysters — 7 days old (*Crassostrea virginica*)

**Juvenile fish**

Winter flounder (*Pseudopleuronectes americanus*)  
 Common scup (*Stenotomus versicolor*)  
 Killifish (*Fundulus heteroclitus*)

fashion: a more gradual increase in mortality with increases in added chlorine. The mode of action of chlorine on the test organisms appeared to be some form of metabolic inhibition, but the mechanisms are still unknown.

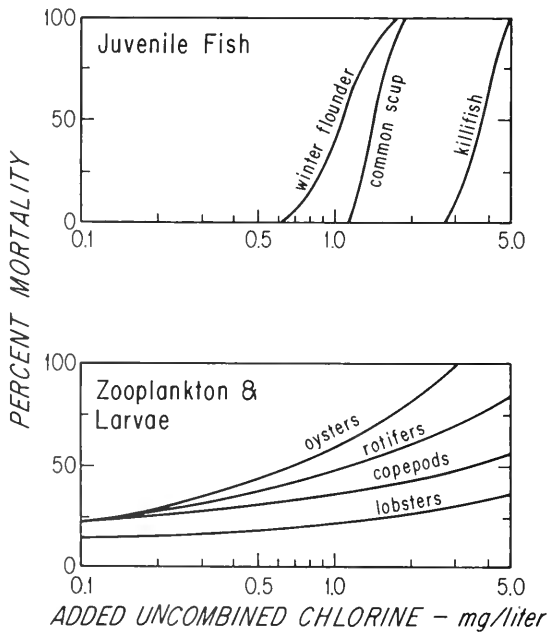

Figure 5. Survival of test species of juvenile fish, zooplankton, and larvae 48 hours after exposure to varying concentrations of uncombined chlorine. Experiments were performed by Dr. Judith Capuzzo at the Woods Hole Oceanographic Institution.

In addition, it was found that phytoplankton and zooplankton, organisms low on the food chain and with relatively short generation periods, probably are not threatened seriously by power plant chlorination. This is because only a small fraction of the natural population of these organisms are entrained and exposed to chlorine. In addition, the surviving organisms, once returned to their natural environment where chlorine is absent, are capable of renewed growth.

In contrast, the effects of short-term chlorination on larval species and small fish are potentially catastrophic. The larval species show considerable sensitivity to chlorine, measured as reductions in metabolic rates, at very low concentrations — for example, less than 0.01 milligram per liter. Even if these organisms survive entrainment, their subsequent chances for survival in the receiving water are diminished because they become more susceptible to predation. Many of the larval species that display this sensitivity to chlorine are important marine food resources, such as lobsters, oysters, clams, and flounder. All of these organisms spawn intermittently in coastal waters. Thus, if a significant portion of the larvae of these species were destroyed by entrainment, there would be potential for a corresponding reduction in the adult populations over time. Eventually, various stocks of commercially important species could become depleted in coastal spawning grounds near power plants.

**Future Prospects**

The hazardous effects of chlorine are slowly but surely being understood; we know that it poses serious threats to our health, both through direct exposure and indirectly by altering aquatic food chains. In recent years, two major conferences on the environmental impact and health effects of water chlorination have been held at the Oak Ridge National Laboratory, bringing together scientists, engineers, and health specialists to study these problems. A third conference is planned for this fall. Thus research activity in this area is intense.

Hopefully, solutions to the problems mentioned in this article will be at hand in the near future. Requirements for dechlorination, such as already practiced at wastewater treatment plants in California, would help immensely. But to simply ban the use of chlorine, before an effective but less harmful alternative biocide is found, clearly would be a poor solution. For we would then have to ask, what would the consequences be? Would we be willing to turn back to the 19th century, when waterborne diseases such as typhoid fever and cholera decimated entire communities? Would we be willing to accept major reductions in the supply of electric power because power plant operating efficiencies were reduced due to fouling problems?



Fisherman trying his luck for trout near chlorinated discharge outlet (circle) from Waterville Valley, New Hampshire, waste treatment plant. (Photo courtesy EPA, Boston)

Clearly, the answer is no. Ideally, a simple solution would be to find an alternative disinfectant with the same biocidal power as chlorine, but without the potential for forming carcinogenic compounds. Unfortunately, virtually all effective biocides have side properties similar to chlorine. Hence, it is a sad reality of our modern life that the chemicals that serve us so well today, hold many hidden dangers for future generations.

Joel C. Goldman is an Associate Scientist in the Biology Department of the Woods Hole Oceanographic Institution.

#### Selected Readings

- Brungs, W. A. 1976. Effects of wastewater and cooling water chlorination on aquatic life. Environmental Protection Agency Ecological Research Series Report EPA-600/3-76-098. Springfield, VA.: National Technical Information Service.
- Capuzzo, J. M., J. C. Goldman, J. A. Davidson, and S. A. Lawrence. 1977. Chlorinated cooling waters in the marine environment: development of effluent guidelines. *Mar. Pollut.* 8: 161-63.
- Esvelt, L. A., W. J. Kaufmann, and R. E. Selleck. 1973. Toxicity assessment of treated municipal wastewaters. *Jour. Water Pollut. Contr. Fed.* 45: 1558-72.
- Goldman, J. C., H. L. Quinby, and J. M. Capuzzo. 1979. Chlorine disappearance in sea-water. *Water Res.* 13: 315-23.
- Jolley, R. L., ed. 1977. *Water chlorination: environmental impact and health effects*. Vol. 1. Ann-Arbor, Mich.: Ann Arbor Science.
- Jolley, R. L., H. Gorchev, and D. H. Hamilton, eds. 1978. *Water chlorination: environmental impact and health effects*. Vol. 2. Ann-Arbor, Mich.: Ann Arbor Science.
- White, G. C. 1972. *Handbook of chlorination*. New York, N.Y.: Van Nostrand Reinhold.



*The sponge Callyspongia plicifera, surrounded by gorgonian corals. (Photo by M. D. Higgs)*

# The Search for Drugs from the Sea

by D. John Faulkner

At the 1967 conference on "Drugs from the Sea" there were confident predictions that new miracle drugs could be obtained from marine organisms within a relatively short period of time. It was suggested that because of their greater numbers and variety, marine organisms could yield even more drugs than terrestrial plants and microorganisms, which are the source of approximately half the pharmaceuticals in use.\* However, no new drugs have resulted from systematic studies of marine organisms. Today even the most enthusiastic supporters of this research seem disillusioned, for the proceedings of the 1978 conference were published under the title "Food-Drugs from the Sea — Myth or Reality?" The author does not share this disenchantment.

In retrospect, it appears that those who expected early success in finding new drugs from marine organisms did not understand the process of creating a new drug. Most people regard a drug as a compound prescribed by a physician to cure or alleviate distress accompanying an illness. They expect the finished product, which only the pharmaceutical industry can supply. Yet there is only one pharmaceutical company that has the full facilities required to develop a new drug from marine sources — the Roche Research Institute for Marine Pharmacology, established in 1974 at Dee Why, Australia. If studies there prove successful, other companies will no doubt commit themselves to marine research. Meanwhile, collaborative efforts between university research groups and pharmaceutical companies offer the best hope for developing drugs from the sea.

---

\*The other half are synthetic drugs.



Table 1. Steps in the development of a new drug from a marine organism.

<b>UNIVERSITY</b> Collection of biological material. Bioassays on crude extracts (optional). Chemical studies to isolate and identify pure compounds. Pharmacological screening of pure compounds. <b>DISCOVERY OF PURE COMPOUNDS WITH DESIRABLE PHARMACOLOGICAL PROPERTIES</b>
<b>PHARMACY</b> Chemical synthesis of the compound and close relatives. Large-scale synthesis and synthesis of radioactive material. Determination of physical properties and <i>in vivo</i> stability. Pharmacological screening of all derivatives. Extended pharmacology in more sophisticated test systems. Determination of the mode of action. Metabolic studies.
<b>INDUSTRY</b> Toxicology. Formulation. Clinical studies. Legal studies, market research, etc. <b>PRODUCTION OF A NEW DRUG</b>

Analysis of the stages involved in developing a drug from a marine organism (Table 1) led researchers at the University of California to define their goal as "the discovery of pure compounds with desirable pharmacological properties." The university researchers can provide sufficient screening data on pure marine products to allow the pharmaceutical company to decide whether the compound should be studied in-house. The company then can embark on the long and expensive process of transforming a physiologically active compound into a useful pharmaceutical agent. It has been estimated that the development of a new drug takes at least 10 years and costs more than \$50 million, provided all goes well.

In a typical drug development program, both the natural compound and a large number of slightly modified compounds called analogues are synthesized. Through pharmacological testing, the analogues are compared with the natural material, in the hope that they will prove to be more effective than the natural product, since they are easier to patent. Even if the natural material is selected, developing a synthetic product would probably be cheaper and certainly more reliable than extracting the same compound from most marine organisms. The pharmacological screening program, which is based on a few general screens, must become more

and more sophisticated until the mode of action of the drug can be determined. The compound must be synthesized into a radioactive form to be used in metabolic studies. The toxicity of the compound and all its metabolites must be determined according to government regulations. Finally, after determining the best method of administering the drug, it must be subjected to stringent clinical trials. Many compounds have interesting pharmacological activity but few will be used in medicine.

#### A Collaborative Effort

The discovery of marine natural products with interesting pharmacological properties requires a close collaboration between chemists and pharmacologists. Unfortunately, such activity is discouraged in academia because it runs counter to the requirement of independent creative research. Our program at the University of California cannot be modelled after an industrial one since we must be independent researchers working toward a common goal. Our collaborating pharmacologist, Dr. Robert Jacobs of the University of California at Santa Barbara, must perform routine assays as part of the undergraduate and graduate teaching program, while allowing graduate students to pursue in-depth pharmacological studies for their

thesis research. Fortunately, he found that some marine natural products can be used as probes to study the basic principles of pharmacology. By allowing undergraduates to screen marine natural products, the service aspect of this research has become a valuable and exciting educational experience. Although the screening performed by Jacobs and his co-workers might be considered modest by pharmaceutical company standards, the results have been substantial.

The chemists participating in the program — Dr. Phillip Crews of the University of California at Santa Cruz, and Dr. William Fenical and this author at Scripps Institution of Oceanography — have the task of supplying the interesting compounds for pharmacological screening. To preserve independent areas of research, Dr. Fenical and the author have undertaken to study marine plants and marine invertebrates, respectively. This simple division of interests gives us ample opportunity to make original contributions to basic research in marine natural products chemistry, while participating in an applied research project.

There are many thousands of marine invertebrates from which we must choose a very small number to study. Due to the high cost of collecting marine organisms, we must devise strategies to obtain a greater percentage of animals that produce physiologically active compounds than would be found in a random collection. During our research, we have used two such strategies that we refer to as the screening and ecological approaches.

The screening approach requires that the investigator select in advance the pharmacological activity that he wishes to study. He establishes an assay, and then screens solvent extracts from hundreds or even thousands of marine organisms to find those having that particular pharmacological activity. The extract then must be separated into its chemical constituents, following the pharmacological activity by performing the assay after each step of the separation process, until pure active compounds have been isolated. Success depends upon the sophistication of the bioassay and the length of time required to obtain it. The bioassay for antimicrobial activity, which requires no sophisticated equipment and can be performed overnight, has proven to be an ideal basis for the screening approach. Unfortunately, the usual bioassays for potential anti-cancer and cardiovascular drugs require sophisticated equipment or animal-care facilities and often take days or even weeks to obtain results. Using the screening approach for discovering new pharmaceuticals has the advantage of being methodical, which makes it unlikely to overlook potential drugs. The disadvantages of this method are evident in the program to find new anti-cancer

drugs from marine organisms, which has identified hundreds of active extracts but few, if any, pure compounds that might be used for the treatment of cancer.

One of the major problems encountered by those who use the screening approach requiring a complicated laboratory-based bioassay is that of recollecting the active organisms in the quantities needed for a "bioassay-directed" chemical purification. Let us suppose that an investigator makes a random collection of 100 algae and 100 sponges. If he finds that four seaweeds and 10 sponges give extracts that show activity in the chosen bioassay, he must then re-collect enough material (up to 10 kilograms) to ensure that he is able to isolate and identify the active chemicals. He may be fortunate and find that the seaweed is large, easily located, and can be collected by hand in the intertidal zone at low tide. On the other hand, most of the sponges can only be collected by scuba diving. The reduced underwater visibility and time constraints might make re-collection slow or even impractical, especially when the collection site is not adjacent to diving facilities. In this situation a research vessel becomes invaluable.

We began our research on antibiotics from marine organisms in 1970 aboard *R/V Dolphin*, a privately owned motor yacht. Although its laboratory was compact in comparison with laboratories ashore, it was ideal for performing antimicrobial assays in the field. At each collecting site, we obtained small samples of the most abundant organisms, homogenized each one in ethanol, and screened each extract against a variety of test microorganisms. Since the screening was an overnight operation, we were able to re-collect larger quantities of the active organisms the next day before moving to a new collection site. This procedure not only made the most efficient use of the limited storage space aboard, but it also caused the least ecological impact since only active organisms were collected.

Our most recent collections were made during a research cruise on *R/V Alpha Helix* to Glover and Lighthouse Reefs in the Caribbean off the coast of Belize. These coral reefs were selected because the steep reef slopes are an ideal habitat for sponges. The vessel had almost everything that was required for our research, with laboratories well equipped for both chemical and microbiological studies. The ship was used as a floating laboratory and remained in a sheltered anchorage while collections of marine organisms were made by teams of scuba divers operating from small boats. After each collecting trip, the organisms were sorted, photographed, and stored either in ethanol or in the ship's large freezer. A portion of each sample was homogenized for antimicrobial screening against six representative

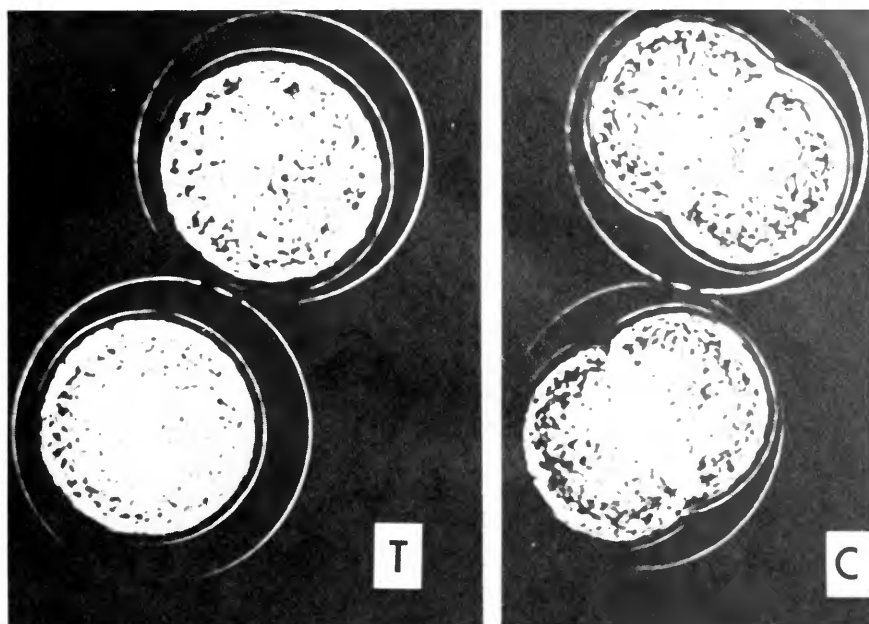

Inhibition of cell division in fertilized sea urchin eggs. C=control (normal division), T=treated with active material (no division). (Photo by R. Jacobs)

microorganisms and for a simple chemical screen using thin-layer chromatography. We collected more than 100 sponge samples and found that higher than 50 percent contained chemicals that inhibited the growth of one or more of the test microorganisms (Table 2). It was fortunate that we were able to freeze sponge samples, for we found that many antimicrobial compounds decomposed when stored in ethanol for a month or more.

Since screening is most successful when it is performed at the collecting site, we must now develop new bioassays that do not require the use

of rats, mice, and other small mammals. (Imagine the reaction of the ship's cook when he sees mice being brought aboard!) Toxicity assays can be performed on small fish instead of mammals, but may be of limited value since we do not yet know enough about fish physiology to determine the cause of death or mode of action. Dr. Jacobs is developing a promising bioassay that may enable us to screen for cytotoxic compounds aboard a research vessel. The assay consists of adding extracts of marine organisms to seawater containing fertilized sea urchin eggs. If the extract is inactive,

Table 2. Antibacterial screening data summary: Lighthouse Reef and Glover Reef, Belize.

Samples	Total number screened	Test Microorganisms							
		(1) S. aur.	(2) E. coli	(3) C. alb.	(4) B-392	(5) V. ang.	(6) E. aero.	(7) P. aeru.	(8) B. sub.
Sponge	107	58	19	35	23	26	14	12	46
Algae	7	3	0	1	0	0	0	0	2
Mollusc	1	0	0	0	0	0	0	0	0
Gorgonian	15	0	0	0	0	0	0	0	4
Tunicate	3	1	0	0	0	0	0	0	2
Zooanthids	2	0	0	0	0	0	0	0	0
Tube Worms	1	0	0	0	0	0	0	0	0
Phylum ?	1	0	0	0	0	0	0	0	0
<b>Total</b>	<b>137</b>	<b>62</b>	<b>19</b>	<b>36</b>	<b>23</b>	<b>26</b>	<b>14</b>	<b>12</b>	<b>54</b>

Key to Test Microorganisms: (1) *Staphylococcus aureus*, (2) *Escherichia coli*, (3) *Candida albicans*, (4) B-392 (marine bacterium), (5) *Vibrio anguillarum*, (6) *Enterobacter aerogenes*, (7) *Pseudomonas aeruginosa*, (8) *Bacillus subtilis*.

the eggs will undergo synchronous cell division within 2 to 4 hours; if active, it will inhibit cell division in the eggs. The potential pharmaceutical significance of this assay is unknown, since it is difficult to correlate activity in an invertebrate system with corresponding activity in a mammalian system. However, many of the compounds used in cancer chemotherapy also inhibit cell division in the sea urchin assay. This rapid assay might be used to locate cytotoxic compounds that then could be sent for the more rigorous and time-consuming screening in mammalian systems.

The results of the large screening programs have provided a statistical basis as evidence that there may be many undiscovered pharmaceutical agents in marine organisms. For example, Dr. A. J. Weinheimer of the University of Houston and co-workers at the University of Oklahoma have shown that more than 10 percent of marine organisms contain cytotoxic compounds, compared to 2 to 3 percent of terrestrial species. His data indicated that cytotoxic compounds are more likely to be found in marine invertebrates than marine algae, in sessile rather than mobile invertebrates, and in tropical rather than temperate or cold-water environments. These data support arguments that form the basis of the ecological approach.

The ecological approach to the discovery of potential drugs from marine organisms is based on observing the behavior and interactions of marine invertebrates in a natural environment. The organisms that contain interesting chemical structures are purified and identified prior to pharmacological screening. We have searched the literature for clues to the presence of physiologically active molecules in marine animals. The most helpful were the reports of toxicity, many of which had been thoroughly studied previously. Marine toxins generally are not very good drugs because their physiological activities usually are too powerful and dangerous, but they are used frequently in the study of biochemical mechanisms. Tetrodotoxin is a toxin that is occasionally responsible for the deaths of those who eat improperly prepared puffer fish. Despite the fact that it is used effectively in neurophysiological studies, tetrodotoxin is too toxic for use as a pharmaceutical agent.

We have focused our attention on reports of behavior modification occurring in one organism caused by chemicals released from a second organism; of apparently defenseless animals that lack predators; of organisms that overgrow or prevent the growth of their neighbors; and of organisms that live in symbiotic relationships. We now are able to recognize some of these situations in the field.

Some of the most striking examples of behavior modification are the effects of starfish

exudate on various animals. When exposed to the exudate, limpets and abalone attempt to escape from the area instead of exhibiting their normal reaction to disturbance, which is to attach themselves even more firmly to the substrate. We and others found that the escape response was caused by complex mixtures of surfactant compounds (similar to detergents) called saponins, which were very difficult to study chemically. With modern advances in separation science, it is now possible to obtain pure compounds from the complex mixtures and to screen them for pharmacological activity.

There are several groups of marine organisms that appear defenseless, but have few predators: soft-bodied sessile invertebrates, such as tunicates, soft corals and sponges that lack spicules, and the shell-less molluscs (opisthobranchs), which, though mobile, are too slow to escape from potential predators. Sea hares are opisthobranch molluscs that always have had an unsavory reputation. They owe this reputation and their survival to eating habits. These organisms have a chemical defense mechanism that uses the noxious or even toxic halogenated chemicals produced by certain red algae. They eat the algae, digesting normal chemicals, but storing the noxious halogenated chemicals in a special organ known as the digestive gland. The noxious chemicals then are transported to the skin of the sea hare, where they are released in a mucus. The mucus, which contains the noxious algal metabolites, gives the sea hares an unpleasant taste and thus discourages predators. The chemicals stored in the digestive gland of the sea hare comprise the most interesting ones that can be obtained from the red algae. In effect, the sea hares concentrate the compounds that are of most interest to the chemist and pharmacologist. The colorful nudibranchs use the same mechanism to derive a defensive secretion, using chemicals from their diet of sponges.

The sessile invertebrates, such as sponges, tunicates, and soft corals, have a special problem of survival for they are literally sitting targets. Some sponges manage to hide in crevices or under rocks while others have sharp spicules of silica built into a tough dermal layer, but many sponges appear to have no physical defense mechanism. These sponges, along with similarly unprotected tunicates and soft corals, have provided many of the antibiotics and other pharmacologically active compounds that have been evaluated by Dr. Jacobs and his colleagues. Large sponges without spicules appear to be the most prolific sources of interesting, pharmacologically active compounds.

Unusual growth patterns of sessile organisms also can indicate the production of physiologically active compounds. Where two organisms compete for the same substrate, one organism may defeat the other by exuding a mucus containing a toxic

chemical. We have studied a sponge that burrows into coral heads. To prevent overgrowth by the coral or by epiphytes, the sponge maintains a clean area around its oscular opening by exuding a mucus. The sponge contains a highly active antimicrobial compound, which is probably in the mucus and is responsible for its chemical defense.

The study of symbiosis is still in its infancy. It is recognized that gorgonian corals containing algal symbionts produce many physiologically active compounds, including prostaglandins, whereas gorgonians without symbionts rarely contain large quantities of secondary metabolites. This suggests that the production of physiologically active compounds may be closely linked to the maintenance of the symbiotic relationships.

Perhaps the most interesting and bizarre source of antimicrobial compounds was a marine bacterium that seemed intent on suicide. The bacterium was difficult to culture in the laboratory because it died after 2 to 4 days. The marine bacterium, accustomed to the infinite dilution of the ocean, produced antimicrobial compounds for its protection. However, when grown in an enriched culture medium, the bacterium produced enough antimicrobial compounds to inhibit its own growth, providing an example of autotoxicity. We isolated the antimicrobial agent and found that it was as active as the most effective antibiotics available, but the compound is quite useless as a drug since it is too toxic to be administered to an animal.

In case the author has persuaded any reader that his research is always carefully planned and methodically executed, he must now confess that the most unusual chemicals encountered by his team were isolated from a dried sponge sent in by a biologist who was working on an unrelated project at Arno Atoll in the mid-Pacific. This was a rewarding example of a truly random collection!

### Looking Ahead

It is far too early to predict whether the University of California project will provide the inspiration for new medicinal agents. We believe it is wrong to make premature claims based on pharmacological assays in animals, for we consider a drug to be an agent that is effective in the treatment of human illness. Our stance is one of cautious optimism.

We have isolated and identified many marine natural products with very unusual chemical structures, including more than 50 compounds having antimicrobial activity *in vitro*. When we began our research, we predicted that we would have greater success screening pure compounds than crude extracts. Screening results obtained during the first year support this prediction: 22 of 41 pure compounds have shown interesting pharmacological activity, whereas 6 of 24 extracts

*The sea hare Aplysia parvula. (Photo by author)*



So deadly is the force of this poison that it poisons not only those who took it in by mouth, but also those who touched or looked at it, as Pliny reports, and if a pregnant woman sees it or even comes near it, especially if this happens to be a young woman, she immediately feels pain in the belly and nausea and then she has an abortion



*The unsavory reputation of the sea hare is captured in this cartoon by Jeanne Carleton. The quotation above is taken from *Poisonous and Venomous Marine Animals of the World*, Vol. 1, 1965, by Bruce W. Halstead.*



The sponge *Haliclona cinerea*. (Photo by J. Thompson)



An antimicrobial assay. An extract from the sponge *Verongia* inhibits the growth of two marine bacteria isolated from the surface of the same sponge. (Photo by author)

showed sufficient activity to warrant isolation of the active constituents using bioassay-directed purification methods. These results are far better than those to be expected from the random screening approach. We now know that marine plants and animals produce many unusual pharmacologically active compounds, but we also are aware that only the pharmaceutical industry can convert these research results into drugs from the sea.

*D. John Faulkner is an Associate Professor of Marine Chemistry at Scripps Institution of Oceanography, University of California at San Diego.*

#### Further Reading

- Baslow, M. H. 1977. *Marine pharmacology*. Huntington, N.Y.: Krieger.
- Faulkner, D. J., and W. F. Fenical, eds. 1977. *Marine natural products chemistry*. N.Y.: Plenum Press.
- Freudenthal, H. D., ed. 1968. *Drugs from the sea*. Washington, D.C.: Marine Technology Society.
- Kaul, P. N., ed. 1979. *Food-drugs from the sea — myth or reality?* Norman, Okla.: University of Oklahoma Press.
- Ruggieri, G. D., ed. 1976. *Food-drugs from the sea*. Washington, D.C.: Marine Technology Society.
- Worthen, L. R., ed. 1973. *Food-drugs from the sea*. Washington, D.C.: Marine Technology Society.
- Youngken, H. W., Jr., ed. 1970. *Food-drugs from the sea*. Washington, D.C.: Marine Technology Society.

### Special Student Rate!

We remind you that students at all levels can enter or renew subscriptions at the rate of \$8 for one year, a saving of \$2. This special rate is available only through application to: *Oceanus*, Woods Hole Oceanographic Institution, Woods Hole, Mass. 02543.

### Attention Teachers!

We offer a 40 percent discount on bulk orders of five or more copies of each current issue — or only \$1.65 a copy. The same discount applies to one-year subscriptions for class adoption (\$6 per subscription). Teachers' orders should be sent to our editorial office at the address listed at left, accompanied by a check payable to Woods Hole Oceanographic Institution.

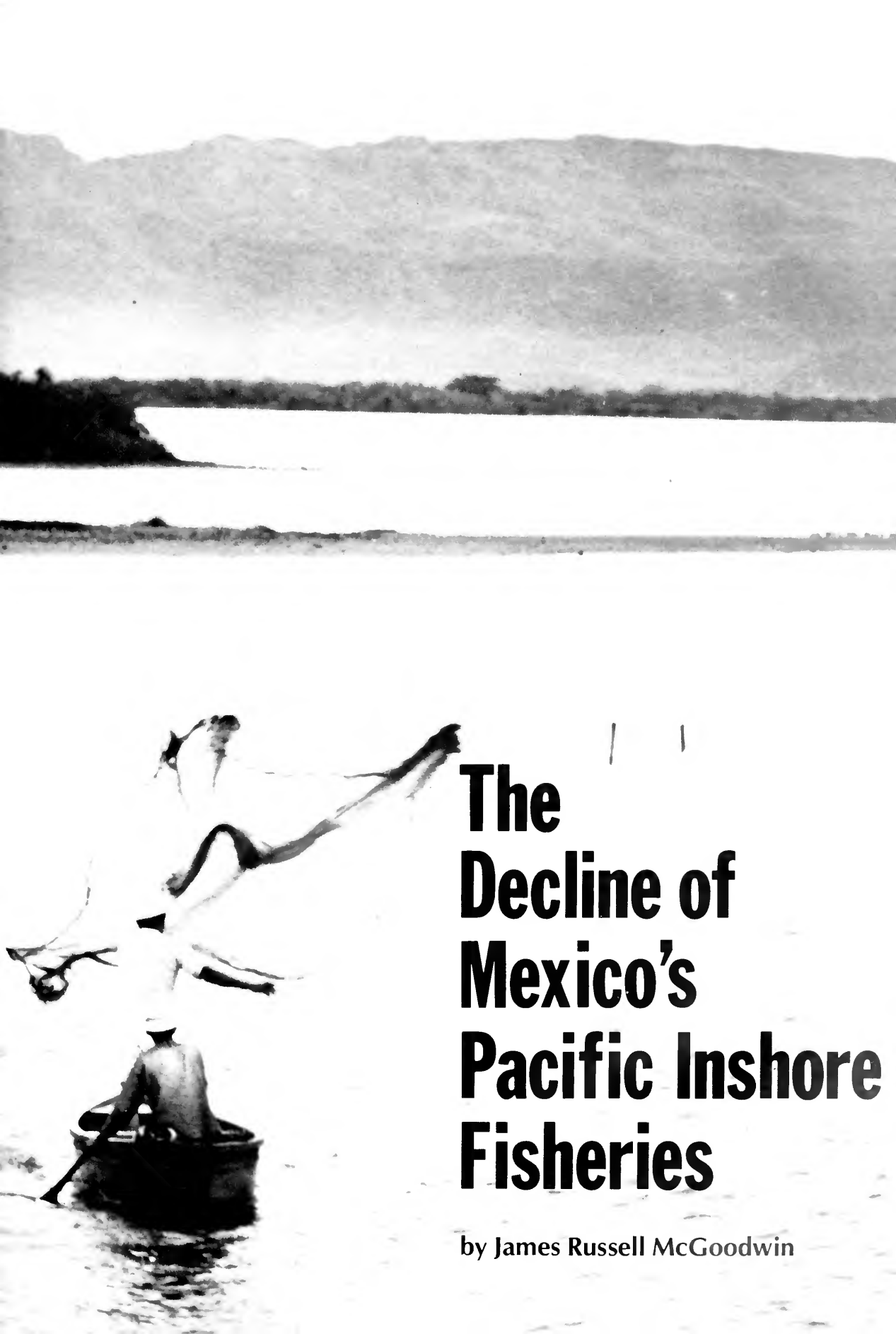

# The Decline of Mexico's Pacific Inshore Fisheries

by James Russell McGoodwin

Now that most of the less-developed countries have extended their jurisdictional claims over ocean resources out to 200 nautical miles, there is great enthusiasm among them for promoting new maritime developments. Many of these nations — struggling with domestic food shortages and scarce capital for development — look to their fisheries as a source of protein-rich foods, and substantial export income. But before these countries surge ahead with development of their fisheries, they should consider the possible consequences of the strategies available to them, benefiting from the past experiences of other nations.

Mexico's shrimp industry on the Pacific coast provides an instructive case. The growth of its export trade has been extraordinary, especially with regard to the income it has generated (Figure 1). Today the state-instituted, urban-based industry boasts seven trawler fleets with more than 450 vessels; 10 freezing, packing, and canning plants; two fisheries-research institutions; one shipyard; and two Mexican-owned importing corporations (chartered in the United States and located in San Diego, California). More than 94 percent of the industry's shrimp catch is sent abroad — some 30,000 metric tons last year, which brought nearly \$80 million in the international marketplace. Crustaceans are Mexico's leading primary commodity export: 47 percent of the total value of all such exports, according to the 1972 Food and Agriculture Organization Trade Yearbook.

### South Sinaloa: A Case in Point

Map 1 shows a number of coastal lagoons, salt marshes, and estuaries along Mexico's Pacific coast. These regions are the major inshore fisheries and the main rearing grounds for commercially important species of shrimp. In former times, they also produced great quantities of other seafoods, particularly oysters and fish.

Although the focus of this article is on the rural fisheries in the *municipio* (like a county in the United States) of Escuinapa, south Sinaloa state, the situation described is applicable to all of Mexico's Pacific rural-coastal fisheries. South Sinaloa is where today's shrimp-export industry had its beginnings, and where the social, economic, and political problems accompanying the growth of the industry have reached their point of greatest strain. Northward along the lagoons and estuaries of Sonora, for example, the rural population is relatively less dense, whereas southward — in the

### OVERLEAF

*Subsistence fishermen (pescadores libres) shrimp fishing in the Laguna Los Cañales, south Sinaloa. Such activity is discouraged by regulations, which reserve production of exportable marine species for the inshore fishing cooperatives. (Photo by author)*

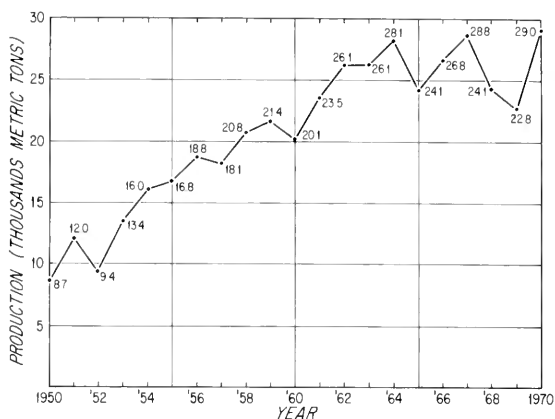

Figure 1. Annual offshore shrimp production for Mexico's Pacific coast, 1950-1970. Source: Instituto de Pesca, Mexico, D.F.

rural regions of the Gulf of Tehuantepec — the impact of the shrimp-export industry has been less severe. Nevertheless, living conditions are distressing in all of Mexico's Pacific rural-coastal regions.

### A Brief History of South Sinaloa

South Sinaloa's inshore fisheries were not always underdeveloped, nor were their inhabitants as cut off from marine resources as they are today. Indeed, people have relied upon this region's rich coastal resources for at least 8,000 years — perhaps longer. Evidence of this extensive maritime history is apparent to even a casual observer.

The coastal region contains numerous shell mounds, some more than three kilometers long and 180 meters wide, with peaks reaching nearly 11 meters. Not far from Escuinapa, *cabecera* (head town) of the *municipio* by that same name, archeologists recently discovered a particularly large shell mound — a protopyramid, perhaps — 21 meters high, quadrilateral in shape, and flat on top. Radiocarbon dating indicates that this structure was built about 2,000 years ago, suggesting the existence of coastal chiefdoms, and perhaps even nascent states, which subsisted on the region's seafoods 16 centuries before the arrival of the Spanish conquerors.

Estimates of the pre-Columbian population vary and are highly speculative, but some historians suggest that a relatively dense population inhabited the coastal plain at the time of the Spanish conquest (early 16th century). From all indications, these people were part of the Mesoamerican culture tradition, the same as the Aztec and Maya. They built platform mounds and ball courts on the higher ground behind the coastal zone; decorated their pottery in the Mesoamerican style; grew corn, beans, and squash along the river courses; and



## Sonora - Sinaloa

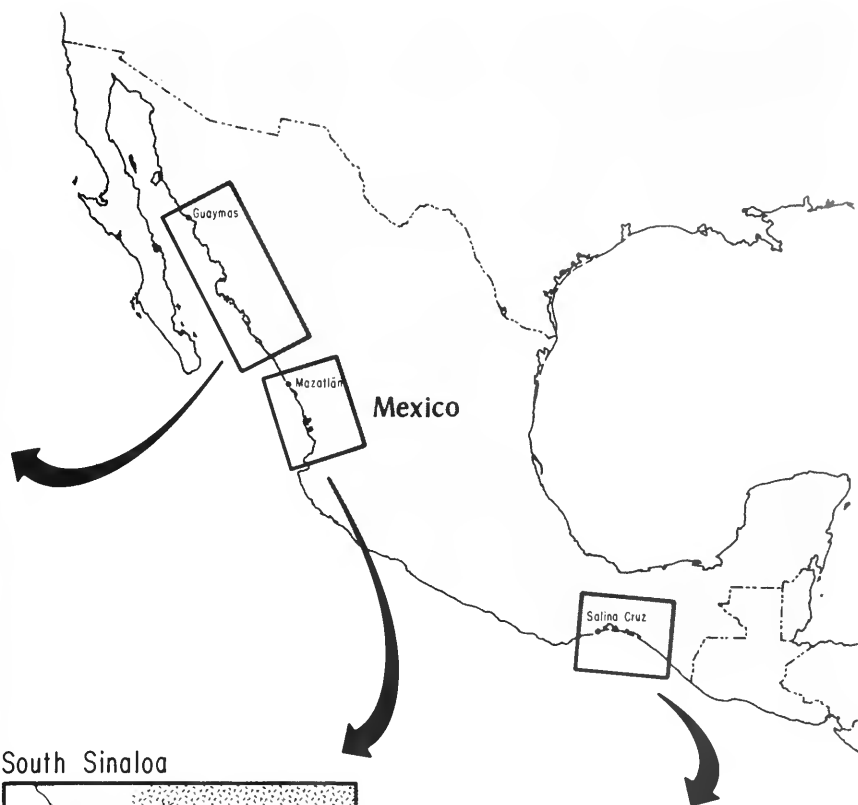
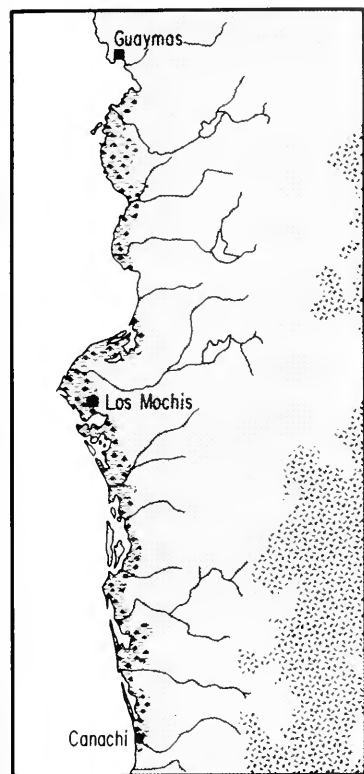

## South Sinaloa

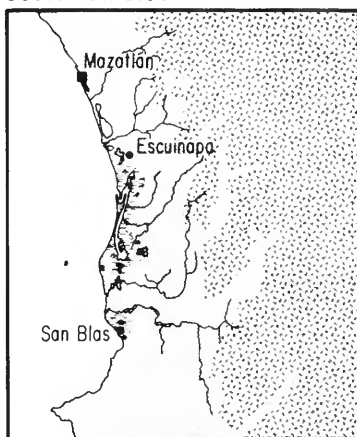

## Gulf of Tehuantepec

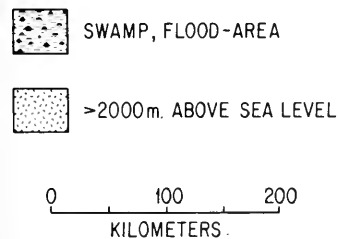
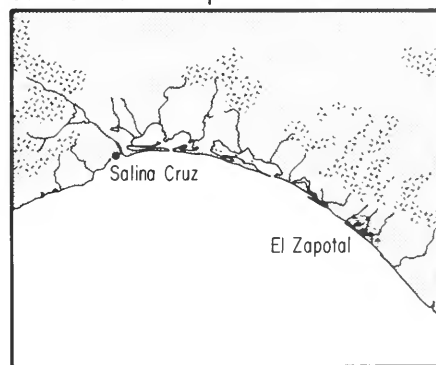

Map 1. Major shrimp fishery regions along Mexico's Pacific coast.

harvested and traded great quantities of seafoods from the estuaries and lagoons.

The conquest of south Sinaloa brought the destruction of the aboriginal population. The Indians were victims of various diseases introduced by the Spaniards, and their ranks were further reduced by a number of factors that were either non-existent, or at least not as severe, in other parts of conquest-era Mexico. They had the misfortune of being conquered initially by Nuño de Guzmán, one of the era's most genocidal *conquistadores*. Later many were taken as slaves for the mines in the Sierra

Madre Occidental and for Cuba's sugar plantations. The scattered few who remained were pushed out of the region, displaced by the lords of cattle-raising *haciendas*. Indeed, the region was effectively depopulated of indigenous peoples by the 1750s, and today none inhabit the coastal zone.

For about three centuries the region was nearly empty of inhabitants, so its abundant marine resources went unexploited. Then, in the early to middle 19th century, a trickle of new settlers arrived — mestizo immigrants from other parts of Mexico. They settled the coastal lands that became available



*Aboriginal shell mound near Venadillo, south Sinaloa. Shell accumulations — some more than 3 kilometers long and 180 meters wide, with peaks reaching 11 meters — indicate the reliance of ancient populations on the marine resources in this area. (Photo by author)*

after Mexico's independence from Spain in 1821. Still more immigrants came after the French occupation in 1867. These new arrivals were quick to recognize the potential of the region's marine resources for subsistence and commerce, and soon south Sinaloa's smoked oysters and salted shrimp were carried by muleteers across the Sierra to Durango, and southward toward Guadalajara and Mexico City.

The landmark event for these fisheries occurred in the early 1870s when Chinese immigrants from Mazatlán visited the region around Escuinapa, bought large quantities of shrimp and oysters, and began to sell them to buyers from the United States, China, and Japan. In this manner, south Sinaloa's inshore fisheries made their debut in the international marketplace.

By the outbreak of the Revolution in 1910, serious conflicts had arisen regarding the region's marine resources. The Diaz administration granted

exclusive fishing rights to a number of small companies, and limited subsistence fishing by regional fishermen not employed by the companies. During the Revolution, the brief Madero administration declared that subsistence fishing activities would be "free," and not subject to regulation. Today subsistence fishermen are still identified as *pescadores libres*, but now the term has a negative connotation because fishing industry officials use it when referring to fishermen who are not members of the state-sanctioned rural fishing cooperatives. Theoretically, subsistence fishing is still "free," but in actual practice it is greatly encumbered by various regulations that forbid shrimp harvesting for most of the year, or that prohibit such fishing in territories exclusively reserved for the cooperatives.

By the end of the Revolution, vessels from Japan and the United States were actively shrimp trawling along Mexico's Pacific coast. Mexico was powerless to prevent such incursions at that time, nor did it have sufficient capital with which to finance the construction of its own vessels. Instead, it attempted to regulate and tax the foreigners fishing offshore, while developing its own shrimp export industry in its inshore fisheries.

Offshore, the Japanese eventually gained preeminence in the international shrimp market, driving competitors from Mexico's Pacific coast by the middle 1930s. However, on the eve of World War II in 1939, Japan abruptly withdrew its fleets from the area. Mexico finally had decisive control over all of its Pacific shrimp fisheries; at this juncture, it began to develop its own offshore fleets.

Mexico already had developed a system of State-instituted, inshore fishing cooperatives and central packing plants. Shortly after the Revolution, the Pacific inshore fisheries were declared federal territories. Then, with passage of the *Ley General de Cooperativas* in 1933, the nation undertook development of the various "enterprises of State participation." Cooperatives were established in the rural areas, along with a number of central packing plants for export operations. The rural fishing cooperatives of south Sinaloa and the packing plant at Escuinapa were the first of their kind on the Pacific coast.

Nearly all the capital available for these enterprises went toward the construction of the regional packing plants. Development of the rural inshore fishing cooperatives involved little more than granting exclusive fishing territories and the recruitment of rural fishermen. The rural cooperatives required only rudimentary and fairly inexpensive weirs, which were made of mangrove posts and erected across tidal channels.

The rural cooperatives were inextricably bound to the regional packing plants by the terms of their charters. They were required to turn over all of



*Shrimp trawlers with freezing and packing plant in background, Guaymas, Sonora. (Photo by author)*

their exportable harvest at prices established annually by the federal government. Only in the conduct of their own internal affairs were they allowed to act as autonomous entities. Initially, this was not a handicap to the rural *cooperativistas*: marine resources were plentiful, the new organizations accepted nearly all rural fishermen wishing to join, and prices were such that most fishermen increased their incomes.

It was the era of the establishment of the nation's agrarian *ejidos* (communal, community farms). The fishing cooperatives similarly were hailed as important socio-economic reforms. Proponents claimed that they would raise the standard of living of rural-coastal inhabitants and encourage wide participation in the fishing industry — that the entire nation would benefit from the production of vitally needed foodstuffs and the generation of export income. In retrospect, however, it appears that the generation of export income was the main reason why fishing cooperatives were founded, as the reform-oriented goals soon eroded.

As economic entities, the rural cooperatives were fairly successful from the time of their inception through the middle 1960s when Mexico's

offshore shrimp-trawling industry finally overshadowed them. But long before that they had begun to suffer from serious problems.

Probably the most severe of these was corruption, or *caciquismo* (corrupt, political-economic bossism). During the Alemán administration, 1946-1952, *caciquismo* became widespread in the cooperatives. In many cases, corrupt men undertook to run them for their own personal gain, relegating the *cooperativistas* to the status of mere shift laborers. During that period, analogous situations arose on the nation's *ejidos*, particularly those producing export items.

Other serious problems surfaced. While the federal government appropriated lands and redistributed them to impoverished *campesinos* (peasants) — many of whom were resettling in Sinaloa from other parts of the nation — south Sinaloa's rural-coastal population boomed (from about 8,000 persons in 1935 to nearly 35,000 by 1975). This resulted in increased competition for local marine resources. Eventually, the rural fishing cooperatives became entrenched economic entities, serving only a minority of the rural-coastal population. They also suffered the effects of population growth from within; today most of



*Rural houses around Teacapán, south Sinaloa. Homes in this region lack running water and modern sanitary facilities. The inhabitants suffer a high incidence of nutritional, infectious, and parasitic diseases. (Photo by author)*

south Sinaloa's cooperatives have more members than they need, with the result that many must share their dwindling incomes with marginally productive members.

Thus by the early 1950s south Sinaloa's rural-coastal population began to suffer serious strains. This situation was greatly aggravated by the introduction of outboard motors and nylon nets. The use of these motors with large dugout canoes eased the transport of large nylon nets, which, because they are nearly invisible underwater, proved tremendously effective in catching fish.

By then, most of the region's shrimp and oyster harvest was being sent abroad, so fish that were abundant in the estuaries and lagoons — snappers, snook, drumfish, mullet, and others — became the new mainstays of domestic consumption. However, the technological introductions quickly decimated the inshore fish stocks, reducing them to very low levels within only a few years. Rural fishermen speak of former times, before the introduction of motors and nets, when the surface waters of the lagoons sometimes appeared red from the large numbers of snappers congregated there. This is no longer seen, however.

Continued fishing pressure has prevented the recovery of these resources, and net fishermen now rely on secondary species — so called trash fish — which are converted into fish meal, a high-protein dietary supplement for poultry and livestock.

Other factors also contributed to the rapid decline of south Sinaloa's inshore fisheries. Natural catastrophes, for example, played a part. In 1967, during the fall rainy season, a particularly severe flood buried the region's oyster beds under tons of silt, causing an almost total loss of that resource. Floods have occurred previously in the region, sometimes with devastating consequences — in about 1300 A.D., one similarly destroyed the region's oyster beds, forcing the fishery to be partially abandoned for a number of years thereafter. Following the flood in 1967, the federal government imposed a moratorium on oyster harvesting and attempted to reestablish the beds, but these efforts were only partly successful. The reduced oyster stocks have been under heavy pressure by rural *campesinos*, who illegally harvest them in order to provide food for their families. The stocks also have been damaged by contaminants — mainly chemical pesticides — used in the region's



A weir (called a tapo) on the Estero El Mezcal, south Sinaloa. This weir, which belongs to an inshore fishing cooperative, is not in production. Its fencing has been rolled up and placed on the shore (foreground) so it will not rot. (Photo by author)

agricultural sector and reaching the beds mostly by runoff processes.

Overshadowing all these disasters, however, was the development of offshore trawling, which brought about a corresponding decline in inshore fisheries. To understand why, the life cycle of Mexico's commercially important Pacific species of shrimp, all members of the *Penaeid* family, must be examined.

In simplest terms, the shrimp are hatched from fertilized eggs in the open sea, and then, in the form of microscopically small larvae, they migrate up coastal estuaries and into briny lagoons. In those delicate environments, they spend several months, growing to what would be recognizable as subadult shrimp. Finally, they migrate back to sea, reach their maximal size, and eventually spawn, thus completing their life cycle. Their seaward migration is particularly intense during the fall rainy season when the influx of freshwater greatly reduces the salinity of the lagoons. It is this movement that inshore fishermen have relied upon for millennia.

From the perspective of Mexico's offshore shrimp industry and the marine biologists and fisheries managers who advise it, harvesting shrimp while they inhabit the inshore waters is regarded as poor practice. Inshore harvesting takes the shrimp out of the ecosystem before they have a chance to spawn, which potentially threatens the ability of the resource to recover rapidly. Also, by removing shrimp before they reach adult size, the ecosystem's maximum potential shrimp biomass is not produced. Furthermore, the large shrimp

caught offshore command higher prices per unit of weight in the international marketplace. Finally, harvesting shrimp with trawlers is less costly and far more productive than the low-yield, labor-intensive methods employed by inshore fishermen.

Thus, as Mexico pursued the development of its shrimp export trade in this century, it progressively curtailed the inshore shrimp harvest, dissociating the rural population from a resource that had been central to subsistence and commerce (Figure 2). Today the government discourages fishing by subsistence-oriented *pescadores libres*, and permits south Sinaloa's rural cooperatives to

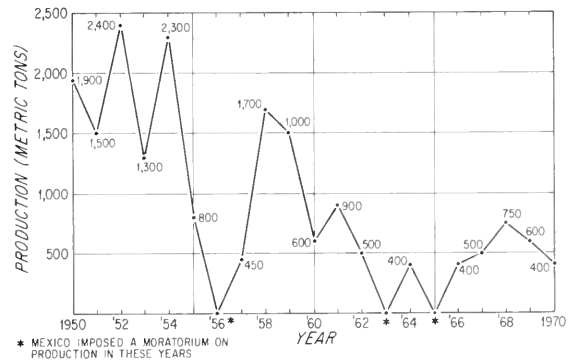
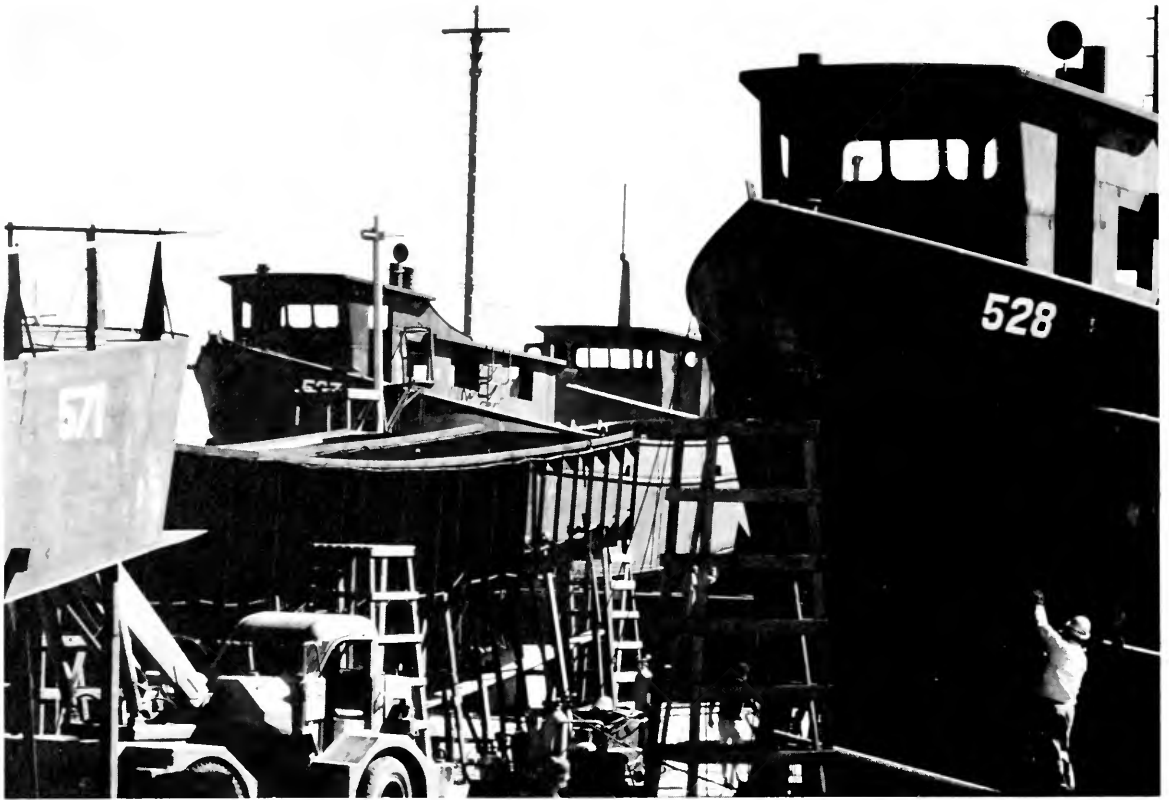

Figure 2. Annual shrimp production of south Sinaloa's major inshore fishing cooperative, 1950-1970. Source: Mendoza von Borstel, Xavier, Mem. IV Congr. Nac. Oceanografía (Mexico); 407-418, 1972.



*Trawlers being constructed at Astilleros del Pacifico (Shipyards of the Pacific), Mazatlán, Sinaloa. Mexico continues to develop its shrimp-export industry despite evidence that the industry has reached the limits of its growth. (Photo by author)*

harvest shrimp for only 10 to 12 weeks per year, whereas the offshore trawlers are permitted 35 to 40 weeks of production annually.

South Sinaloa's rural fishermen are aware of the political events that have marginalized their traditional way of life. Often, in discussions with this writer concerning the development of the offshore trawling industry, they have exclaimed: "*Camarón que duerme se la lleva la marea*" (a shrimp that sleeps is taken by the tide). It is a statement pregnant with irony, through which they self-consciously acknowledge their powerlessness to stem the tide of events that has impoverished them.

#### **Policy Reconsideration Needed**

It would be glib to conclude that the development of Mexico's Pacific fisheries could have been otherwise. Hindsight is always clearer than foresight. When the shrimp export industry was first organized, the nation badly needed capital to finance its reconstruction, and, at least initially, the rural fishing cooperatives did elevate the standard of living in their areas. In 1933, the post-revolutionary leaders could not have foreseen the great population growth to come, and, given the nation's

preoccupation with its agricultural sector at that time, its reformers should not be blamed for overemphasizing the development of shrimp exports.

However, Mexico is now experiencing acute and widespread food shortages, rising infant mortality rates, and an exodus of rural poor to the crowded cities and to the United States. On the problem of malnutrition in rural Mexico, Dr. Adolfo Chávez, director of the National Nutrition Institute in Mexico City, was recently quoted as having said, "... we see infant mortality rising again. In some really depressed rural communities, few children born since 1974 have survived. We have what we call 'generational holes'." Nevertheless, the federal government continues to announce further development of the shrimp export industry, despite evidence that the industry already has reached the limits of its growth (shrimp stocks have been declining for a number of years). A few industry officials question the evidence, pointing out steady production increases over the last decade, but their own fisheries biologists state that such increases only reflect the annual addition of new trawlers to the fleets. Various methods for increasing shrimp

stocks are still being tried; the most important are dredging projects that would facilitate shrimp migrations between offshore and inshore waters, but these do not promise to make much difference overall.

Furthermore, the industry's dependency on the international market often places it in a precarious economic position. In 1971, for example, the United States unilaterally imposed a 10-percent surcharge on import tariffs, which precipitated an economic crisis throughout Mexico's shrimp industry. President Echeverría responded by courting other foreign buyers for Mexican shrimp, particularly the Japanese, promising to "weaken the embrace of the North," but such actions were futile. The United States still purchases most of Mexico's shrimp exports, and the industry is still highly vulnerable to the vagaries of the international marketplace.

Mexico needs to reconsider its policy for the management and development of its Pacific-coastal fisheries. It should stress revitalization of the inshore fisheries, encourage the resurgence of fish stocks, and relax its restrictions on the activities of individual subsistence fishermen, or *pescadores libres*. Everything possible should be done to increase supplies to the nation's *domestic* seafood markets.

Such a change of policy would not be as radical as it might first seem, especially considering the nation's anticipation of great increases in export income from development of petroleum resources on the Campeche Banks. With so much potential income from petroleum, Mexico should not have to rely as heavily as it has in the past on the export of foodstuffs.

Of course, few of the less-developed countries are fortunate enough to have large underdeveloped reserves of energy resources, but a great deal still can be learned from studying the development of Mexico's shrimp export industry. The Philippines, for example, has both rich shrimp resources and a large artisanal rural fishing population, and is now developing its offshore shrimp fisheries.

Fishing is a small part of the Gross National Product of most nations. Even in Japan, a nation well known for its fisheries and maritime traditions, the value of agricultural output exceeds that of fishing by 50 times. Thus fishing often is not well understood as a socio-economic phenomenon. This sometimes leads national economic planners to group various forms of fishing under one rubric, thereby failing to distinguish between crucial differences, such as subsistence versus commercial fishing, or inshore versus offshore fishing. Moreover, many nations may not be aware — because they lack the appropriate information — that increased income from fisheries' exports may, in some cases, be more than offset by the consequent social and economic costs among artisanal fishermen in rural-coastal zones.

*James Russell McGoodwin is a Fellow in the Marine Policy and Ocean Management Program, Woods Hole Oceanographic Institution, and Assistant Professor of Anthropology (on leave) at the University of Colorado. He has conducted research in Mexico since 1971.*

#### Selected References

- Beals, Ralph L. 1932. The comparative ethnology of northern Mexico before 1750. *Ibero Americana* (monograph) 2. Berkeley, Ca.: University of California Press.
- Chevalier, François. 1970. *Land and society in colonial Mexico: The great hacienda*. Berkeley, Ca.: The University of California Press.
- Cordell, John C. 1973. Modernization and marginality. *Oceanus* 5(17):28-33.
- Firth, Raymond. 1965. *Malay fishermen: Their peasant economy*. London: Routledge and Kegan Paul.
- Fraser, Thomas M. 1966. *Fishermen of South Thailand*. New York, N.Y.: Holt, Rinehart, and Winston.
- Hubbs, Carl I., and Gunnar I. Roden. 1964. Oceanography and marine life along the Pacific coast of Middle America. In *Handbook of Middle American Indians*, Vol. 1, ed. by Robert C. West. Austin, Tx.: The University of Texas Press.
- Kelly, Charles, and Howard D. Winters. 1960. A revision of the archaeological sequence in Sinaloa, Mexico. *American Antiquity* 25 (December).
- Nishimura, Asahitaro. 1973. A preliminary report on current trends in marine anthropology. *Occasional Papers of the Center of Marine Ethnology* 1. Tokyo: Waseda University.
- Sauer, Carl, and Donald Brand. 1932. *Aztlán. Ibero Americana* (monograph) 1. Berkeley, Ca.: The University of California Press.
- Scott, Stuart D. et al. 1972. *Archeological reconnaissances and excavations in the marismas nacionales, Sinaloa and Nayarit, Mexico, 1967-1972*. Buffalo, N.Y.: Department of Anthropology, State University of New York at Buffalo.
- Spicer, Edward H. 1969. Northwest Mexico. In *Handbook of Middle American Indians*, Volume 8, ed. by Evon Z. Vogt. Austin, Tx.: The University of Texas Press.



# Oceanus Back Issues

Limited quantities of back issues are available at prices indicated; a 25 percent discount is offered on orders of five or more. PLEASE select alternatives for those in *very limited supply*. We accept only prepaid orders. Checks should be made payable to Woods Hole Oceanographic Institution; checks accompanying foreign orders must be payable in U.S. currency and drawn on a U.S. bank. Address orders to: Oceanus Back Issues, 1172 Commonwealth Ave., Boston, MA 02134.

**ENERGY AND THE SEA**, Vol. 17:5, Summer 1974 — One of our most popular issues. There is extractable energy in the tides, currents, and temperature differences; in the winds that blow over them; in the very waters themselves. Eight articles discuss these topics as well as the likelihood of finding oil under the deep ocean floor and of locating nuclear plants offshore. **\$4.00**

**MARINE POLLUTION**, Vol. 18:1, Fall 1974 — Popular controversies, such as the one over whether or not the seas are “dying,” tend to obscure responsible scientific effort to determine what substances we flush into the ocean, in what amounts, and with what effects. Some progress is being made in the investigation of radioactive wastes, DDT and PCB, heavy metals, plastics and petroleum. Eleven authors discuss this work as well as economic and regulatory aspects of marine pollution. **\$4.00**

**FOOD FROM THE SEA**, Vol. 18:2, Winter 1975 — Fisheries biologists and managers are dealing with the hard realities of dwindling stocks and increasing international competition for what is left. Seven articles deal with these problems and point to ways in which harvests can be increased through mariculture, utilization of unconventional species, and other approaches. **\$4.00**

**DEEP-SEA PHOTOGRAPHY**, Vol. 18:3, Spring 1975 — A good deal has been written about the use of hand-held cameras along reefs and in shallow seas. Here eight professionals look at what the camera has done and can do in the abyssal depths. Topics include the early history of underwater photography, present equipment and techniques, biological applications, TV in deep-ocean surveys, the role of photography aboard the submersible *Alvin* along the Mid-Atlantic Ridge, and future developments in deep-sea imaging. **\$4.00**

**MARINE BIOMEDICINE**, Vol. 19:2, Winter 1976 — Marine organisms offer exciting advantages as models for the study of how cells and tissues work under both normal and pathological conditions — study leading to better understanding of disease processes. Vision research is being aided by the skate; neural investigation, by the squid; work on gout, by the dogfish. Eight articles discuss these developments, as well as experimentation involving egg-sperm interactions, bioluminescence, microtubules, and diving mammals. **\$3.00**

**ESTUARIES**, Vol. 19:5, Fall 1976 — Of great societal importance, estuaries are complex environments increasingly subject to stress. The issue deals with their hydrodynamics, nutrient flows, and pollution patterns, as well as plant and animal life — and the constitutional issues posed by estuarine management. **\$4.00**

**OIL IN COASTAL WATERS**, Vol. 20:4, Fall 1977 — *Very limited supply*. **\$3.00**





**GENERAL ISSUE, Vol. 21:3, Summer 1978**— The lead article looks at the future of deep-ocean drilling, which is at a critical juncture in its development. Another piece— heavily illustrated with sharp, clear micrographs— describes the role of the scanning electron microscope in marine science. Rounding out the issue are articles on helium isotopes, seagrasses, red tide and paralytic shellfish poisoning, and the green sea turtle of the Cayman Islands. **\$3.00**

# Oceanus

The Illustrated Magazine  
of Marine Science  
Published by Woods Hole  
Oceanographic Institution

## SUBSCRIPTION ORDER FORM

Please make checks payable to Woods Hole Oceanographic Institution.  
Checks accompanying foreign orders must be payable in U.S. currency and drawn on a U.S. bank.  
(Outside U.S., Possessions, and Canada add \$2 per year to domestic rates.)

Please enter my subscription to OCEANUS for

- one year at \$10.00  
 two years at \$18.00

- payment enclosed.  
(we request prepayment)  
 bill me

Please send MY Subscription to:

Please send a GIFT Subscription to:

Name \_\_\_\_\_ (please print)  
Street address \_\_\_\_\_  
City \_\_\_\_\_ State \_\_\_\_\_ Zip \_\_\_\_\_

Name \_\_\_\_\_ (please print)  
Street address \_\_\_\_\_  
City \_\_\_\_\_ State \_\_\_\_\_ Zip \_\_\_\_\_  
Donor's Name \_\_\_\_\_  
Address \_\_\_\_\_

# Oceanus

The Illustrated Magazine  
of Marine Science  
Published by Woods Hole  
Oceanographic Institution

## SUBSCRIPTION ORDER FORM

Please make checks payable to Woods Hole Oceanographic Institution.  
Checks accompanying foreign orders must be payable in U.S. currency and drawn on a U.S. bank.  
(Outside U.S., Possessions, and Canada add \$2 per year to domestic rates.)

Please enter my subscription to OCEANUS for

- one year at \$10.00  
 two years at \$18.00

- payment enclosed.  
(we request prepayment)  
 bill me

Please send MY Subscription to:

Please send a GIFT Subscription to:

Name \_\_\_\_\_ (please print)  
Street address \_\_\_\_\_  
City \_\_\_\_\_ State \_\_\_\_\_ Zip \_\_\_\_\_

Name \_\_\_\_\_ (please print)  
Street address \_\_\_\_\_  
City \_\_\_\_\_ State \_\_\_\_\_ Zip \_\_\_\_\_  
Donor's Name \_\_\_\_\_  
Address \_\_\_\_\_

**MARINE MAMMALS, Vol. 21:2, Spring 1978**— Attitudes toward marine mammals are changing worldwide. This phenomenon is appraised in the issue along with articles on the bowhead whale, the sea otter's interaction with man, behavioral aspects of the tuna/porpoise problem, strandings, a radio tag for big whales, and strategies for protecting habitats. **\$2.00**

The 25% discount granted on orders of five or more back copies does not apply to these special sale issues.

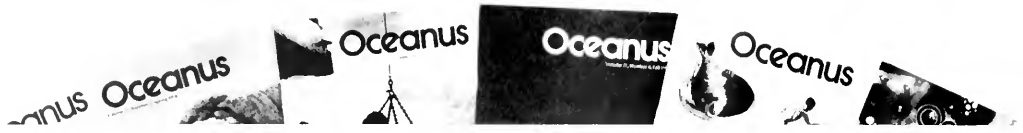

PLACE  
STAMP  
HERE

# Oceanus

Woods Hole Oceanographic Institution  
Woods Hole, Mass. 02543

PLACE  
STAMP  
HERE

# Oceanus

Woods Hole Oceanographic Institution  
Woods Hole, Mass. 02543

increasingly subject to stress. The issue deals with their hydrodynamics, nutrient flows, and pollution patterns, as well as plant and animal life — and the constitutional issues posed by estuarine management. \$4.00

OIL IN COASTAL WATERS, Vol. 20:4, Fall 1977 — *Very limited supply.* \$3.00



**GENERAL ISSUE**, Vol. 21:3, Summer 1978 — The lead article looks at the future of deep-ocean drilling, which is at a critical juncture in its development. Another piece — heavily illustrated with sharp, clear micrographs — describes the role of the scanning electron microscope in marine science. Rounding out the issue are articles on helium isotopes, seagrasses, red tide and paralytic shellfish poisoning, and the green sea turtle of the Cayman Islands. **\$3.00**

**OCEANS AND CLIMATE**, Vol. 21:4, Fall 1978 — This issue examines how the oceans interact with the atmosphere to affect our climate. Articles deal with the numerous problems involved in climate research, the El Niño phenomenon, past ice ages, how the ocean heat balance is determined, and the roles of carbon dioxide, ocean temperatures, and sea ice. **\$4.00 (Reissue price).**

**HARVESTING THE SEA**, Vol. 22:1, Spring 1979 — Although there will be two billion more mouths to feed in the year 2000, it is doubtful that the global fish harvest will increase much beyond present yields. Nevertheless, third world countries are looking to more accessible vessel and fishery technology to meet their protein needs. These topics and others — the effects of the new law of the sea regime, postharvest fish losses, long-range fisheries, and krill harvesting — are discussed in this issue. Also included are articles on aquaculture in China, the dangers of introducing exotic species into aquatic ecosystems, and cultural deterrents to eating fish. **\$3.00**

**OUT OF PRINT**

**SEA-FLOOR SPREADING**, Vol. 17:3, Winter 1974

**AIR-SEA INTERACTION**, Vol. 17:4, Spring 1974

**THE SOUTHERN OCEAN**, Vol. 18:4, Summer 1975

**SEAWARD EXPANSION**, Vol. 19:1, Fall 1975

**OCEAN EDDIES**, Vol. 19:3, Spring 1976

**GENERAL ISSUE**, Vol. 19:4, Summer 1976

**HIGH-LEVEL NUCLEAR WASTES IN THE SEABED?** Vol. 20:1, Winter 1977

## Special Back Issue Sale!

*For a limited time only, we are offering the following issues at a reduced rate:*

**SOUND IN THE SEA**, Vol. 20:2, Spring 1977 — Beginning with a chronicle of man's use of ocean acoustics, this issue covers the use of acoustics in navigation, probing the ocean, penetrating the bottom, studying the behavior of whales, and in marine fisheries. In addition, there is an article on the military uses of acoustics in the era of nuclear submarines. **\$2.00**

**GENERAL ISSUE**, Vol. 20:3, Summer 1977 — The controversial 200-mile limit constitutes a mini-theme in this issue, including its effect on U.S. fisheries, management plans within regional councils, and the complex boundary disputes between the U.S. and Canada. Other articles deal with the electric and magnetic sense of sharks, the effects of tritium on ocean dynamics, nitrogen fixation in salt marshes, and the discovery during a recent Galápagos Rift expedition of marine animal colonies existing on what was thought to be a barren ocean floor. **\$2.00**

**THE DEEP SEA**, Vol. 21:1, Winter 1978 — Over the last decade, scientists have become increasingly interested in the deep waters and sediments of the abyss. Articles in this issue discuss manganese nodules, the rain of particles from surface waters, sediment transport, population dynamics, mixing of sediments by organisms, deep-sea microbiology — and the possible threat to freedom of this kind of research posed by international negotiations. **\$2.00**

**MARINE MAMMALS**, Vol. 21:2, Spring 1978 — Attitudes toward marine mammals are changing worldwide. This phenomenon is appraised in the issue along with articles on the bowhead whale, the sea otter's interaction with man, behavioral aspects of the tuna/porpoise problem, strandings, a radio tag for big whales, and strategies for protecting habitats. **\$2.00**

The 25% discount granted on orders of five or more back copies does not apply to these special sale issues.

# Oceanus

(ISSN 0029-8182)

WOODS HOLE  
OCEANOGRAPHIC  
INSTITUTION

Woods Hole, MA 02543

Postmaster: Please Send  
Form 3579 to Above Address

SECOND-CLASS  
POSTAGE PAID  
AT FALMOUTH, MASS.,  
AND ADDITIONAL  
MAILING POINTS



Woods Hole Oceanographic Institution  
P.O. Box 243  
Woods Hole, MA 02543