





THE LIBRARY
OF
THE UNIVERSITY
OF CALIFORNIA
LOS ANGELES

GIFT

Dr. M. H. ...

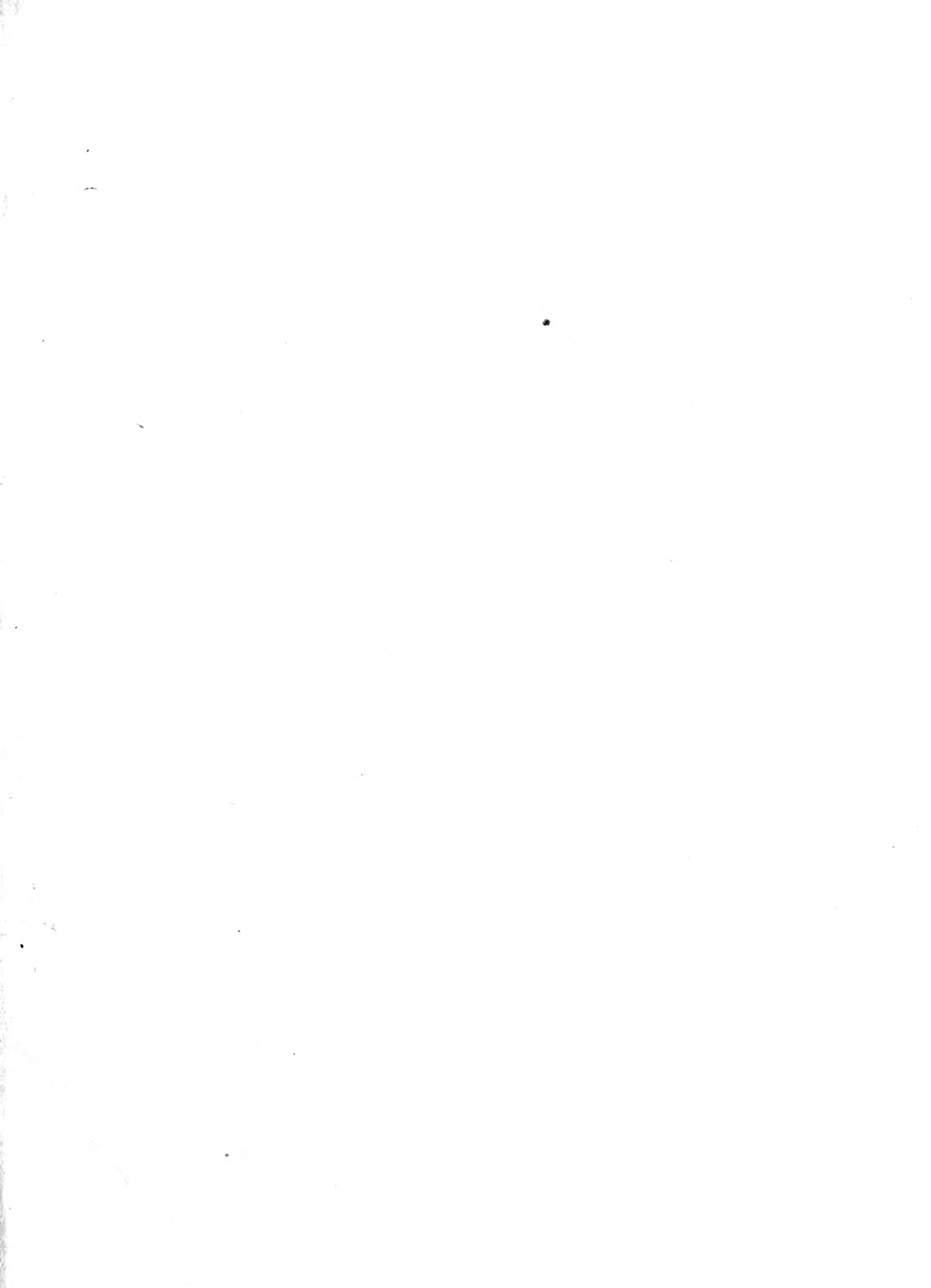

Bened

AC

?

B37

1971

177

1973

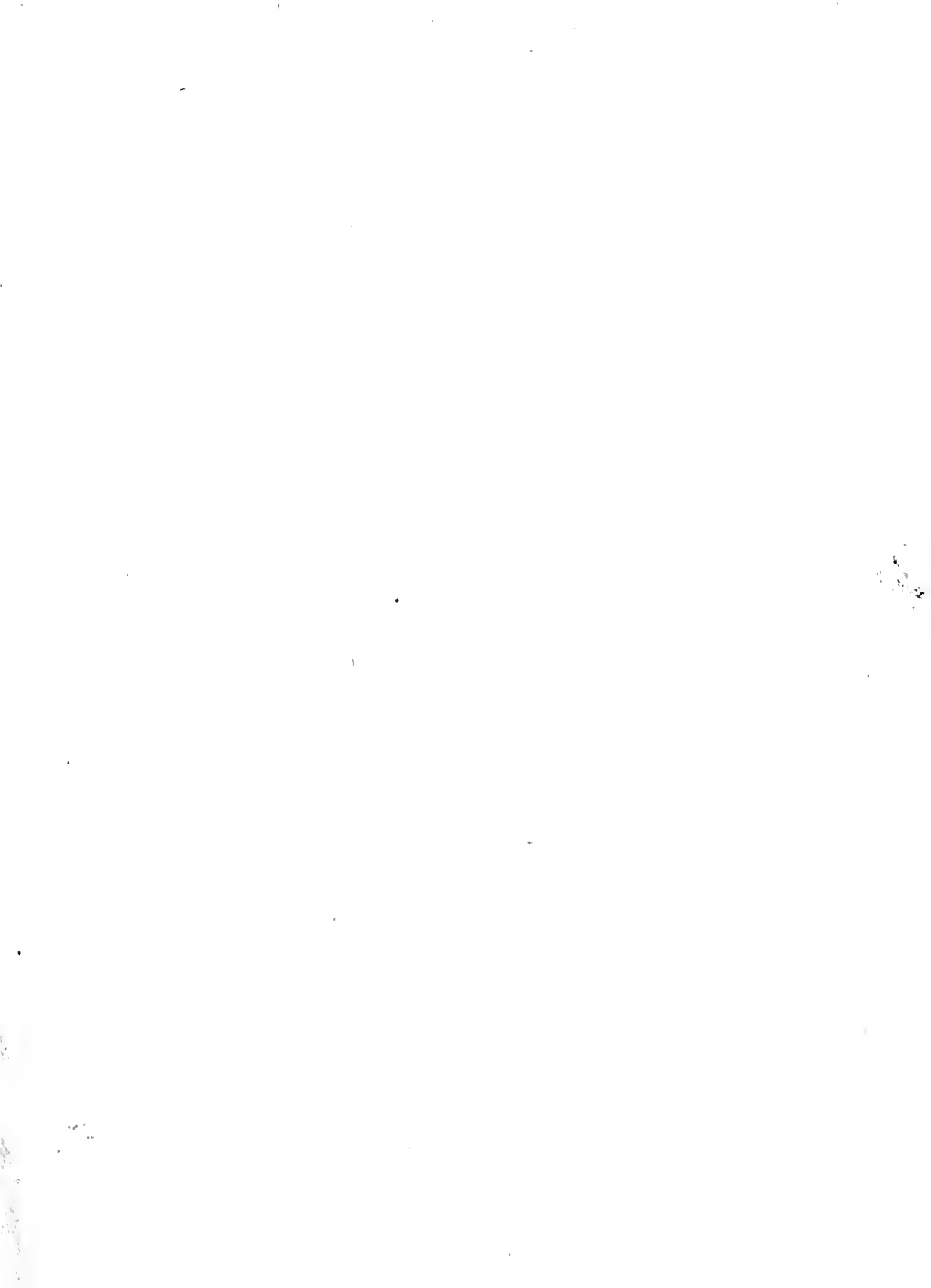



Isaacus Newton Ep. Dur.

Nulli in Pax!

F. plene sicut

OPTICKS:

OR, A

TREATISE

OF THE

REFLEXIONS, REFRACTIONS,
INFLEXIONS and COLOURS

OF

L I G H T.

ALSO

TWO TREATISES

OF THE

SPECIES and MAGNITUDE

OF

Curvilinear Figures.



LONDON,

Printed for *JAM. SMITH*, and *GEN. WALKER*:

Printers to the Royal Society, at the *Printers Arms* in
St. Paul's Church-yard. MDCCIV.

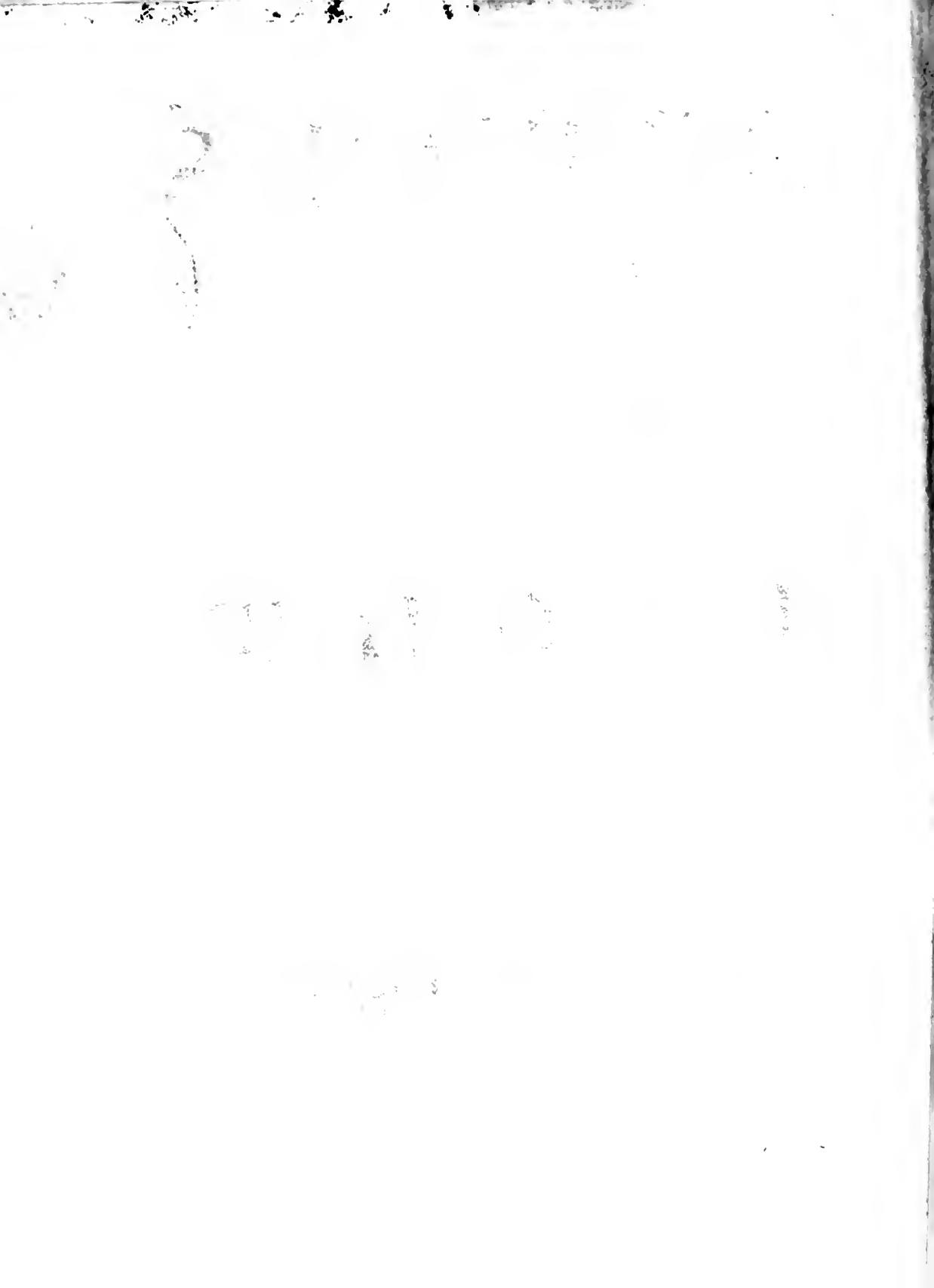

ADVERTISEMENT.

PArt of the ensuing *Discourse about Light* was written at the desire of some Gentlemen of the Royal Society, in the Year 1675. and then sent to their Secretary, and read at their Meetings, and the rest was added about Twelve Years after to complete the Theory; except the Third Book, and the last Proposition of the Second, which were since put together out of scattered Papers. To avoid being engaged in Disputes about these Matters, I have hitherto delayed the Printing, and should still have delayed it, had not the importunity of Friends prevailed upon me. If any other Papers writ on this Subject are got out of my Hands they are imperfect, and were perhaps written before I had tried all the Experiments here set down, and fully satisfied my self about the Laws of Refractions and Composition of Colours. I have here Published what I think proper to come abroad, wishing that it may not be Translated into another Language without my Consent.

The Crowns of Colours, which sometimes appear about the Sun and Moon, I have endeavoured to give an Account of; but for want of sufficient Observations leave that Matter to be further examined. The Subject of the Third Book I have also left imperfect, not having tried all the Expe-

Blurred
AC
8
B37
N484o
1704
RARE

Experiments which I intended when I was about these Matters, nor repeated some of those which I did try, until I had satisfied my self about all their Circumstances. To communicate what I have tried, and leave the rest to others for further Enquiry, is all my Design in publishing these Papers.

In a Letter written to Mr. Leibnitz in the Year 1676. and published by Dr. Wallis, I mentioned a Method by which I had found some general Theorems about squaring Curvilinear Figures, or comparing them with the Conic Sections, or other the simplest Figures with which they may be compared. And some Years ago I lent out a Manuscript containing such Theorems, and having since met with some Things copied out of it, I have on this Occasion made it publick, prefixing to it an Introduction and subjoyning a Scholium concerning that Method. And I have joined with it another small Tract concerning the Curvilinear Figures of the Second Kind, which was also written many Years ago, and made known to some Friends, who have solicited the making it publick.

The FIRST BOOK OF OPTICKS.

PART I.

MY Design in this Book is not to explain the Properties of Light by Hypotheses, but to propose and prove them by Reason and Experiments: In order to which, I shall premise the following Definitions and Axioms.

DEFINITIONS.

DEFIN. I.

B*Y the Rays of Light I understand its least Parts, and those as well Successive in the same Lines as Contemporary in several Lines.* For it is manifest that Light consists of parts both Successive and Contemporary; because in the same place you may stop that which comes one moment, and let pass that which comes presently after; and in the same time you may stop it in any one place, and let it pass in any other. For that part of Light which is stopt cannot be the same with that which is let pass. The least Light or part of Light, which may be stopt alone without the rest of the Light, or propagated alone, or do or suffer any
A
thing

thing alone, which the rest of the Light doth not or suffers not, I call a Ray of Light.

D E F I N. II.

Refrangibility of the Rays of Light, is their Disposition to be refracted or turned out of their Way in passing out of one transparent Body or Medium into another. And a greater or less Refrangibility of Rays, is their Disposition to be turned more or less out of their Way in like Incidences on the same Medium. Mathematicians usually consider the Rays of Light to be Lines reaching from the luminous Body to the body illuminated, and the refraction of those Rays to be the bending or breaking of those Lines in their passing out of one Medium into another. And thus may Rays and Refractions be considered, if Light be propagated in an instant. But by an Argument taken from the \AE quations of the times of the Eclipses of *Jupiter's Satellites* it seems that Light is propagated in time, spending in its passage from the Sun to us about Seven Minutes of time : And therefore I have chosen to define Rays and Refractions in such general terms as may agree to Light in both cases.

D E F I N. III.

Reflexibility of Rays, is their Disposition to be turned back into the same Medium from any other Medium upon whose Surface they fall. And Rays are more or less reflexible, which are returned back more or less easily. As if Light pass out of Glass into Air, and by being inclined more and more to the common Surface of the Glass and Air, begins at length to be totally reflected by that Surface ; those sorts of Rays which at like Incidences are reflected most copiously, or by inclining the Rays begin soonest to be totally reflected, are most reflexible.

D E-

D E F I N. IV.

The Angle of Incidence, is that Angle which the Line described by the incident Ray contains with the Perpendicular to the reflecting or refracting Surface at the Point of Incidence.

D E F I N. V.

The Angle of Reflexion or Refraction, is the Angle which the Line described by the reflected or refracted Ray containeth with the Perpendicular to the reflecting or refracting Surface at the Point of Incidence.

D E F I N. VI.

The Sines of Incidence, Reflexion, and Refraction, are the Sines of the Angles of Incidence, Reflexion, and Refraction.

D E F I N. VII.

The Light whose Rays are all alike Refrangible, I call Simple, Homogeneous and Similar; and that whose Rays are some more Refrangible than others, I call Compound, Heterogeneous and Dissimilar. The former Light I call Homogeneous, not because I would affirm it so in all respects; but because the Rays which agree in Refrangibility, agree at least in all those their other Properties. Which I consider in the following Discourse.

D E F I N. VIII.

The Colours of Homogeneous Lights, I call Primary, Homogeneous and Simple; and those of Heterogeneous Lights, Heterogeneous and Compound. For these are always compounded of the colours of Homogeneous Lights; as will appear in the following Discourse.

A X I O M S.

A X. I.

THE Angles of Incidence, Reflexion, and Refraction, lye in one and the same Plane.

A X. II.

The Angle of Reflexion is equal to the Angle of Incidence.

A X. III.

If the refracted Ray be returned directly back to the Point of Incidence, it shall be refracted into the Line before described by the incident Ray.

A X. IV.

Refraction out of the rarer Medium into the denser, is made towards the Perpendicular; that is, so that the Angle of Refraction be less than the Angle of Incidence.

A X. V.

The Sine of Incidence, is either accurately or very nearly in a given Ratio to the Sine of Refraction.

Whence if that Proportion be known in any one Inclination of the incident Ray, 'tis known in all the Inclinations, and thereby the Refraction in all cases of Incidence on the same refracting Body may be determined. Thus if the Refraction be made out of Air into Water, the Sine of Incidence of the red Light is to the Sine of its Refraction as 4. to 3. If out of Air into Glass, the Sines are

as

as 17 to 11. In Light of other Colours the Sines have other Proportions : but the difference is so little that it need seldom be considered.

Suppose therefore, that RS represents the Surface of stagnating Water, and C is the point of Incidence in which any Ray coming in the Air from A in the Line AC is reflected or refracted, and I would know whether this Ray shall go after Reflexion or Refraction : I erect upon the Surface of the Water from the point of Incidence the Perpendicular CP and produce it downwards to Q , and conclude by the first Axiom, that the Ray after Reflexion and Refraction, shall be found somewhere in the Plane of the Angle of Incidence ACP produced. I let fall therefore upon the Perpendicular CP the Sine of Incidence AD , and if the reflected Ray be desired, I produce AD to B so that DB be equal to AD , and draw CB . For this Line CB shall be the reflected Ray; the Angle of Reflexion BCP and its Sine BD being equal to the Angle and Sine of Incidence, as they ought to be by the second Axiom. But if the refracted Ray be desired, I produce AD to H , so that DH may be to AD as the Sine of Refraction to the Sine of Incidence, that is as 3 to 4; and about the Center C and in the Plane ACP with the Radius CA describing a Circle ABE I draw Parallel to the Perpendicular CPQ , the Line HE cutting the circumference in E , and joyning CE , this Line CE shall be the Line of the refracted Ray. For if EF be let fall perpendicularly on the Line PQ , this Line EF shall be the Sine of Refraction of the Ray CE , the Angle of Refraction being ECQ ; and this Sine EF is equal to DH , and consequently in Proportion to the Sine of Incidence AD as 3 to 4.

In like manner, if there be a Prism of Glafs (that is a Glafs bounded with two Equal and Parallel Triangular ends, and three plane and well polished Sides, which meet in three Parallel Lines running from the three Angles of one end to the three Angles of the other end) and if the Refraction of the Light in passing thro' this Prism be desired: Let ACB represent a Plane cutting this Prism transversly to its three Parallel lines or edges there where the Light passeth through it, and let dE be the Ray incident upon the first side of the Prism AC where the Light goes into the Glafs; And by putting the Proportion of the Sine of Incidence to the Sine of Refraction as 17 to 11 find EF the first refracted Ray. Then taking this Ray for the Incident Ray upon the second side of the Glafs BC where the Light goes out, find the next refracted Ray FG by putting the Proportion of the Sine of Incidence to the Sine of Refraction as 11 to 17. For if the Sine of Incidence out of Air into Glafs be to the Sine of Refraction as 17 to 11, the Sine of Incidence out of Glafs into Air must on the contrary be to the Sine of Refraction as 11 to 17, by the third Axiom.

Fig. 3. Much after the same manner, if $ACBD$ represent a Glafs spherically Convex on both sides (usually called a *Lens*, such as is a Burning-glass, or Spectacle-glass, or an Object-glass of a Telescope) and it be required to know how Light falling upon it from any lucid point Q shall be refracted, let QM represent a Ray falling upon any point M of its first spherical Surface ACB , and by erecting a Perpendicular to the Glafs at the point M , find the first refracted Ray MN by the Proportion of the Sines 17 to 11. Let that Ray in going out of the Glafs be incident upon N , and then find the second refracted Ray Nq by the Proportion of the Sines 11 to 17. And after the same

same manner may the Refraction be found when the Lens is Convex on one side and Plane or Concave on the other, or Concave on both Sides.

A X. VI.

Homogeneous Rays which flow from several Points of any Object, and fall almost Perpendicularly on any reflecting or refracting Plane or Spherical Surface, shall afterwards diverge from so many other Points, or be Parallel to so many other Lines, or converge to so many other Points, either accurately or without any sensible Error. And the same thing will happen, if the Rays be reflected or refracted successively by two or three or more Plane or spherical Surfaces.

The Point from which Rays diverge or to which they converge may be called their *Focus*. And the Focus of the incident Rays being given, that of the reflected or refracted ones may be found by finding the Refraction of any two Rays, as above; or more readily thus.

Cas. 1. Let ACB be a reflecting or refracting Plane, *Fig. 4.* and Q the Focus of the incident Rays, and QqC a perpendicular to that Plane. And if this perpendicular be produced to q , so that qC be equal to QC , the point q shall be the Focus of the reflected Rays. Or if qC be taken on the same side of the Plane with QC and in Proportion to QC as the Sine of Incidence to the Sine of Refraction, the point q shall be the Focus of the refracted Rays.

Cas. 2. Let ACB be the reflecting Surface of any *Fig. 5.* Sphere whose Center is E . Bisect any Radius thereof (suppose EC) in T , and if in that Radius on the same side the point T you take the Points Q and q , so that TQ , TE , and Tq be continual Proportionals, and the point Q be
the

the Focus of the incident Rays, the point q shall be the Focus of the reflected ones.

Fig. 6. *Caf. 3.* Let ACB be the refracting Surface of any Sphere whose Center is E . In any Radius thereof EC produced both ways take ET and Ct severally in such Proportion to that Radius as the lesser of the Sines of Incidence and Refraction hath to the difference of those Sines. And then if in the same Line you find any two Points Q and q , so that TQ be to ET as Et to tq , taking tq the contrary way from t which TQ lieth from T , and if the Point Q be the Focus of any incident Rays, the Point q shall be the Focus of the refracted ones.

And by the same means the Focus of the Rays after two or more Reflexions or Refractions may be found.

Fig. 7. *Caf. 4.* Let $ACBD$ be any refracting Lens, spherically Convex or Concave or Plane on either side, and let CD be its Axis (that is the Line which cuts both its Surfaces perpendicularly, and passes through the Centers of the Spheres,) and in this Axis let F and f be the Foci of the refracted Rays found as above, when the incident Rays on both sides the Lens are Parallel to the same Axis; and upon the Diameter Ff bisected in E , describe a Circle. Suppose now that any Point Q be the Focus of any incident Rays. Draw QE cutting the said Circle in T and t , and therein take tq in such Proportion to tE as tE or TE hath to TQ . Let tq lye the contrary way from t which TQ doth from T , and q shall be the Focus of the refracted Rays without any sensible Error, provided the Point Q be not so remote from the Axis, nor the Lens so broad as to make any of the Rays fall too obliquely on the refracting Surfaces.

And by the like Operations may the reflecting or refracting Surfaces be found when the two Foci are given,
and

and thereby a Lens be formed, which shall make the Rays flow towards or from what place you please.

So then the meaning of this Axiom is, that if Rays fall upon any Plane or Spherical Surface or Lens, and before their Incidence flow from or towards any Point Q , they shall after Reflexion or Refraction flow from or towards the Point q found by the foregoing Rules. And if the incident Rays flow from or towards several points Q , the reflected or refracted Rays shall flow from or towards so many other Points q found by the same Rules. Whether the reflected and refracted Rays flow from or towards the Point q is easily known by the situation of that Point. For if that Point be on the same side of the reflecting or refracting Surface or Lens with the Point Q , and the incident Rays flow from the Point Q , the reflected flow towards the Point q and the refracted from it; and if the incident Rays flow towards Q , the reflected flow from q , and the refracted towards it. And the contrary happens when q is on the other side of that Surface.

A X. VII.

Wherever the Rays which come from all the Points of any Object meet again in so many Points after they have been made to converge by Reflexion or Refraction, there they will make a Picture of the Object upon any white Body on which they fall.

So if PR represent any Object without Doors, and AB Fig. 3. be a Lens placed at a hole in the Window-shut of a dark Chamber, whereby the Rays that come from any Point Q of that Object are made to converge and meet again in the Point q ; and if a Sheet of white Paper be held at q for the Light there to fall upon it: the Picture of that Object PR will appear upon the Paper in its proper Shape

B and

and Colours. For as the Light which comes from the Point Q goes to the Point *q*, so the Light which comes from other Points P and R of the Object, will go to so many other correspondent Points *p* and *r* (as is manifest by the sixth Axiom;) so that every Point of the Object shall illuminate a correspondent Point of the Picture, and thereby make a Picture like the Object in Shape and Colour, this only excepted that the Picture shall be inverted. And this is the reason of that Vulgar Experiment of casting the Species of Objects from abroad upon a Wall or Sheet of white Paper in a dark Room.

Fig. 8.

In like manner when a Man views any Object P Q R, the Light which comes from the several Points of the Object is so refracted by the transparent skins and humours of the Eye, (that is by the outward coat EFG called the *Tunica Cornea*, and by the crystalline humour AB which is beyond the Pupil *m k*) as to converge and meet again at so many Points in the bottom of the Eye, and there to paint the Picture of the Object upon that skin (called the *Tunica Retina*) with which the bottom of the Eye is covered. For Anatomists when they have taken off from the bottom of the Eye that outward and most thick Coat called the *Dura Mater*, can then see through the thinner Coats the Pictures of Objects lively painted thereon. And these Pictures propagated by Motion along the Fibres of the Optick Nerves into the Brain, are the cause of Vision. For accordingly as these Pictures are perfect or imperfect, the Object is seen perfectly or imperfectly. If the Eye be tinged with any colour (as in the Disease of the *Jaundise*) so as to tinge the Pictures in the bottom of the Eye with that Colour, then all Objects appear tinged with the same Colour. If the humours of the Eye by old Age decay, so as by shrinking to make the *Cornea* and Coat of the *Crystalline*

Stalline humour grow flatter than before, the Light will not be refracted enough, and for want of a sufficient Refraction will not converge to the bottom of the Eye but to some place beyond it, and by consequence paint in the bottom of the Eye a confused Picture, and according to the indistinctness of this Picture the Object will appear confused. This is the reason of the decay of Sight in old Men, and shews why their Sight is mended by Spectacles. For those Convex-glasses supply the defect of plumpness in the Eye, and by encreasing the Refraction make the Rays converge sooner so as to convene distinctly at the bottom of the Eye if the Glass have a due degree of convexity. And the contrary happens in short-sighted Men whose Eyes are too plump. For the Refraction being now too great, the Rays converge and convene in the Eyes before they come at the bottom; and therefore the Picture made in the bottom and the Vision caused thereby will not be distinct, unless the Object be brought so near the Eye as that the place where the converging Rays convene may be removed to the bottom, or that the plumpness of the Eye be taken off and the Refractions diminished by a Concave-glass of a due degree of Concavity, or lastly that by Age the Eye grow flatter till it come to a due Figure: For short-sighted Men see remote Objects best in Old Age, and therefore they are accounted to have the most lasting Eyes.

A X. VIII.

An Object seen by Reflexion or Refraction, appears in that place from whence the Rays after their last Reflexion or Refraction diverge in falling on the Spectator's Eye.

If the Object A be seen by Reflexion of a Looking-glass *m n*, it shall appear, not in it's proper place A, but
B 2
behind
Fig. 9.

behind the Glas at *a*, from whence any Rays *AB*, *AC*, *AD*, which flow from one and the same Point of the Object, do after their Reflexion made in the Points *B*, *C*, *D*, diverge in going from the Glas to *E*, *F*, *G*, where they are incident on the Spectator's Eyes. For these Rays do make the same Picture in the bottom of the Eyes as if they had come from the Object really placed at *a* without the interposition of the Looking-glass; and all Vision is made according to the place and shape of that Picture.

Fig. 2. In like manner the Object *D* seen through a Prism appears not in its proper place *D*, but is thence translated to some other place *d* situated in the last refracted Ray *FG* drawn backward from *F* to *d*.

Fig. 10. And so the Object *Q* seen through the Lens *AB*, appears at the place *q* from whence the Rays diverge in passing from the Lens to the Eye. Now it is to be noted, that the Image of the Object at *q* is so much bigger or lesser than the Object it self at *Q*, as the distance of the Image at *q* from the Lens *AB* is bigger or less than the distance of the Object at *Q* from the same Lens. And if the Object be seen through two or more such Convex or Concave-glasses, every Glas shall make a new Image, and the Object shall appear in the place and of the bigness of the last Image. Which consideration unfolds the Theory of Microscopes and Telescopes. For that Theory consists in almost nothing else than the describing such Glasses as shall make the last Image of any Object as distinct and large and luminous as it can conveniently be made.

I have now given in Axioms and their Explications the summ of what hath hitherto been treated of in Opticks. For what hath been generally agreed on I content my self to assume under the notion of Principles, in order to what I have further to write. And this may suffice for an

Intro-

Introduction to Readers of quick Wit and good Understanding not yet versed in Opticks: Although those who are already acquainted with this Science, and have handled Glasses, will more readily apprehend what followeth.

P R O P O S I T I O N S.

P R O P. I. Theor. I.

LIGHTS which differ in Colour, differ also in Degrees of Refrangibility.

The Proof by Experiments.

Exper. 1. I took a black oblong stiff Paper terminated by Parallel Sides, and with a Perpendicular right Line drawn cross from one Side to the other, distinguished it into two equal Parts. One of these Parts I painted with a red Colour and the other with a blew. The Paper was very black, and the Colours intense and thickly laid on, that the Phænomenon might be more conspicuous. This Paper I viewed through a Prism of solid Glass, whose two Sides through which the Light passed to the Eye were plane and well polished, and contained an Angle of about Sixty Degrees: which Angle I call the refracting Angle of the Prism. And whilst I viewed it, I held it before a Window in such manner that the Sides of the Paper were parallel to the Prism, and both those Sides and the Prism parallel to the Horizon, and the cross Line perpendicular to it; and that the Light which fell from the Window
upon

upon the Paper made an Angle with the Paper, equal to that Angle which was made with the same Paper by the Light reflected from it to the Eye. Beyond the Prism was the Wall of the Chamber under the Window covered over with black Cloth, and the Cloth was involved in Darkness that no Light might be reflected from thence, which in passing by the edges of the Paper to the Eye, might mingle it self with the Light of the Paper and obscure the Phænomenon thereof. These things being thus ordered, I found that if the refracting Angle of the Prism be turned upwards, so that the Paper may seem to be lifted upwards by the Refraction, its blew half will be lifted higher by the Refraction than its red half. But if the refracting Angle of the Prism be turned downward, so that the Paper may seem to be carried lower by the Refraction, its blew half will be carried something lower thereby than its red half. Wherefore in both cases the Light which comes from the blew half of the Paper through the Prism to the Eye, does in like Circumstances suffer a greater Refraction than the Light which comes from the red half, and by consequence is more refrangible.

Fig. 11. Illustration. In the Eleventh Figure, *M N* represents the Window, and *D E* the Paper terminated with parallel Sides *D J* and *H E*, and by the transverse Line *F G* distinguished into two halves, the one *D G* of an intensely blew Colour, the other *F E* of an intensely red. And *B A C c a b* represents the Prism whose refracting Planes *A B b a* and *A C c a* meet in the edge of the refracting Angle *A a*. This edge *A a* being upward, is parallel both to the Horizon and to the parallel edges of the Paper *D J* and *H E*. And *d e* represents the Image of the Paper seen by Refraction upwards in such manner that the blew half *D G* is carried higher to *d g* than the red half *F E* is to *f e*, and therefore suffers

suffers a greater Refraction. If the edge of the refracting Angle be turned downward, the Image of the Paper will be refracted downward suppose to $\delta\epsilon$, and the blew half will be refracted lower to $\delta\gamma$ than the red half is to $\phi\epsilon$.

Exper. 2. About the aforesaid Paper, whose two halves were painted over with red and blew, and which was stiff like thin Pastboard, I lapped several times a slender thred of very black Silk, in such manner that the several parts of the thred might appear upon the Colours like so many black Lines drawn over them, or like long and slender dark Shadows cast upon them. I might have drawn black Lines with a Pen, but the threds were smaller and better defined. This Paper thus coloured and lined I set against a Wall perpendicularly to the Horizon, so that one of the Colours might stand to the right hand and the other to the left. Close before the Paper at the confine of the Colours below I placed a Candle to illuminate the Paper strongly: For the Experiment was tried in the Night. The flame of the Candle reached up to the lower edge of the Paper, or a very little higher. Then at the distance of Six Feet and one or two Inches from the Paper upon the Floor I erected a glass Lens four Inches and a quarter broad, which might collect the Rays coming from the several Points of the Paper, and make them converge towards so many other Points at the same distance of six Feet and one or two Inches on the other side of the Lens, and so form the Image of the coloured Paper upon a white Paper placed there; after the same manner that a Lens at a hole in a Window casts the Images of Objects abroad upon a Sheet of white Paper in a dark Room. The aforesaid white Paper, erected perpendicular to the Horizon and to the Rays which fell upon it from the Lens, I moved sometimes towards the Lens, sometimes from it, to find the

the places where the Images of the blew and red parts of the coloured Paper appeared most distinct. Those places I easily knew by the Images of the black Lines which I had made by winding the Silk about the Paper. For the Images of those fine and slender Lines (which by reason of their blackness were like Shadows on the Colours) were confused and scarce visible, unless when the Colours on either side of each Line were terminated most distinctly. Noting therefore, as diligently as I could, the places where the Images of the red and blew halves of the coloured Paper appeared most distinct, I found that where the red half of the Paper appeared distinct, the blew half appeared confused, so that the black Lines drawn upon it could scarce be seen; and on the contrary where the blew half appeared most distinct the red half appeared confused, so that the black Lines upon it were scarce visible. And between the two places where these Images appeared distinct there was the distance of an Inch and a half: the distance of the white Paper from the Lens, when the Image of the red half of the coloured Paper appeared most distinct, being greater by an Inch and an half than the distance of the same white Paper from the Lens when the Image of the blew half appeared most distinct. In like Incidences therefore of the blew and red upon the Lens, the blew was refracted more by the Lens than the red, so as to converge sooner by an Inch and an half, and therefore is more refrangible.

Fig. 12. *Illustration.* In the Twelfth Figure, DE signifies the coloured Paper, DG the blew half, FE the red half, MN the Lens, HJ the white Paper in that place where the red half with its black Lines appeared distinct, and *hi* the same Paper in that place where the blew half appeared distinct. The place *hi* was nearer to the Lens MN than the place HJ by an Inch and an half. *Scholium.*

Scholium. The same things succeed notwithstanding that some of the Circumstances be varied : as in the first Experiment when the Prism and Paper are any ways inclined to the Horizon , and in both when coloured Lines are drawn upon very black Paper. But in the Description of these Experiments , I have set down such Circumstances by which either the Phænomenon might be rendered more conspicuous, or a Novice might more easily try them, or by which I did try them only. The same thing I have often done in the following Experiments : Concerning all which this one Admonition may suffice. Now from these Experiments it follows not that all the Light of the blew is more Refrangible than all the Light of the red ; For both Lights are mixed of Rays differently Refrangible, So that in the red there are some Rays not less Refrangible than those of the blew , and in the blew there are some Rays not more Refrangible than those of the red ; But these Rays in Proportion to the whole Light are but few, and serve to diminish the Event of the Experiment , but are not able to destroy it. For if the red and blew Colours were more dilute and weak, the distance of the Images would be less than an Inch and an half ; and if they were more intense and full, that distance would be greater, as will appear hereafter. These Experiments may suffice for the Colours of Natural Bodies. For in the Colours made by the Refraction of Prisms this Proposition will appear by the Experiments which are now to follow in the next Proposition.

P R O P. II. Theor. II.

The Light of the Sun consists of Rays differently Refrangible.

The Proof by Experiments.

Exper. 3. **I**N a very dark Chamber at a round hole about one third part of an Inch broad made in the Shut of a Window I placed a Glass Prism, whereby the beam of the Sun's Light which came in at that hole might be refracted upwards toward the opposite Wall of the Chamber, and there form a coloured Image of the Sun. The Axis of the Prism (that is the Line passing through the middle of the Prism from one end of it to the other end Parallel to the edge of the Refracting Angle) was in this and the following Experiments perpendicular to the incident Rays. About this Axis I turned the Prism slowly, and saw the refracted Light on the Wall or coloured Image of the Sun first to descend and then to ascend. Between the Descent and Ascent when the Image seemed Stationary, I stopt the Prism, and fixt it in that Posture, that it should be moved no more. For in that posture the Refractions of the Light at the two sides of the Refracting Angle, that is at the entrance of the Rays into the Prism and at their going out of it, were equal to one another. So also in other Experiments as often as I would have the Refractions on both sides the Prism to be equal to one another, I noted the place where the Image of the Sun formed by the refracted Light stood still between its two contrary Motions, in the common Period of its progress and egress; and when the Image fell upon that place, I made fast the Prism. And in this posture, as the

the most convenient, it is to be understood that all the Prisms are placed in the following Experiments, unless where some other posture is described. The Prism therefore being placed in this posture, I let the refracted Light fall perpendicularly upon a Sheet of white Paper at the opposite Wall of the Chamber, and observed the Figure and Dimensions of the Solar Image formed on the Paper by that Light. This Image was Oblong and not Oval, but terminated with two Rectilinear and Parallel Sides, and two Semi-circular Ends. On its Sides it was bounded pretty distinctly, but on its Ends very confusedly and indistinctly, the Light there decaying and vanishing by degrees. The breadth of this Image answered to the Sun's Diameter, and was about two Inches and the eighth part of an Inch, including the Penumbra. For the Image was eighteen Feet and an half distant from the Prism, and at this distance that breadth if diminished by the Diameter of the hole in the Window-shut, that is by a quarter of an Inch, subtended an Angle at the Prism of about half a Degree, which is the Sun's apparent Diameter. But the length of the Image was about ten Inches and a quarter, and the length of the Rectilinear Sides about eight Inches; And the refracting Angle of the Prism whereby so great a length was made, was 64 degr. With a less Angle the length of the Image was less, the breadth remaining the same. If the Prism was turned about its Axis that way which made the Rays emerge more obliquely out of the second refracting Surface of the Prism, the Image soon became an Inch or two longer, or more; and if the Prism was turned about the contrary way, so as to make the Rays fall more obliquely on the first refracting Surface, the Image soon became an Inch or two shorter. And therefore in trying this Experiment, I was as curious as I could be in placing the Prism by the above-mentioned Rule exactly in

such a posture that the Refractions of the Rays at their emergence out of the Prism might be equal to that at their incidence on it. This Prism had some Veins running along within the Glass from one end to the other, which scattered some of the Sun's Light irregularly, but had no sensible effect in encreasing the length of the coloured Spectrum. For I tried the same Experiment with other Prisms with the same Success. And particularly with a Prism which seemed free from such Veins, and whose refracting Angle was $62\frac{1}{2}$ Degrees, I found the length of the Image $9\frac{3}{4}$ or 10 Inches at the distance of $18\frac{1}{2}$ Feet from the Prism, the breadth of the hole in the Window-shut being $\frac{1}{4}$ of an Inch as before. And because it is easie to commit a mistake in placing the Prism in its due posture, I repeated the Experiment four or five times, and always found the length of the Image that which is set down above. With another Prism of clearer Glass and better Polish, which seemed free from Veins and whose refracting Angle was $63\frac{1}{2}$ Degrees, the length of this Image at the same distance of $18\frac{1}{2}$ Feet was also about 10 Inches, or $10\frac{1}{8}$. Beyond these Measures for about $\frac{1}{4}$ or $\frac{1}{3}$ of an Inch at either end of the Spectrum the Light of the Clouds seemed to be a little tinged with red and violet, but so very faintly that I suspected that tincture might either wholly or in great measure arise from some Rays of the Spectrum scattered irregularly by some inequalities in the Substance and Polish of the Glass, and therefore I did not include it in these Measures. Now the different Magnitude of the hole in the Window-shut, and different thickness of the Prism where the Rays passed through it, and different inclinations of the Prism to the Horizon, made no sensible changes in the length of the Image. Neither did the different matter of
the

the Prisms make any : for in a Vessel made of polished Plates of Glass cemented together in the shape of a Prism and filled with Water, there is the like Success of the Experiment according to the quantity of the Refraction. It is further to be observed, that the Rays went on in right Lines from the Prism to the Image, and therefore at their very going out of the Prism had all that Inclination to one another from which the length of the Image proceeded, that is the Inclination of more than two Degrees and an half. And yet according to the Laws of Opticks vulgarly received, they could not possibly be so much inclined to one another. For let $E G$ represent the Window-*Fig. 13.* shut, F the hole made therein through which a beam of the Sun's Light was transmitted into the darkned Chamber, and $A B C$ a Triangular Imaginary Plane whereby the Prism is feigned to be cut transversly through the middle of the Light. Or if you please, let $A B C$ represent the Prism it self, looking directly towards the Spectator's Eye with its nearer end : And let $X Y$ be the Sun, $M N$ the Paper upon which the Solar Image or Spectrum is cast, and $P T$ the Image it self whose sides towards V and W are Rectilinear and Parallel, and ends towards P and T Semicircular. $Y K H P$ and $X L J T$ are the two Rays, the first of which comes from the lower part of the Sun to the higher part of the Image, and is refracted in the Prism at K and H , and the latter comes from the higher part of the Sun to the lower part of the Image, and is refracted at L and J . Since the Refractions on both sides the Prism are equal to one another, that is the Refraction at K equal to the Refraction at J , and the Refraction at L equal to the Refraction at H , so that the Refractions of the incident Rays at K and L taken together are equal to the Refractions of the emergent Rays at H and J taken together :

ther : it follows by adding equal things to equal things, that the Refractions at K and H taken together, are equal to the Refractions at J and L taken together, and therefore the two Rays being equally refracted have the same Inclination to one another after Refraction which they had before, that is the Inclination of half a Degree answering to the Sun's Diameter. For so great was the Inclination of the Rays to one another before Refraction. So then, the length of the Image P T would by the Rules of Vulgar Opticks subtend an Angle of half a Degree at the Prism, and by consequence be equal to the breadth νw ; and therefore the Image would be round. Thus it would be were the two Rays X L J T and Y K H P and all the rest which form the Image P w T ν , alike Refrangible. And therefore seeing by Experience it is found that the Image is not round but about five times longer than broad, the Rays which going to the upper end P of the Image suffer the greatest Refraction, must be more Refrangible than those which go to the lower end T, unless the inequality of Refraction be casual.

This Image or Spectrum P T was coloured, being red at its least refracted end T, and violet at its most refracted end P, and yellow green and blew in the intermediate spaces. Which agrees with the first Proposition, that Lights which differ in Colour do also differ in Refrangibility. The length of the Image in the foregoing Experiments I measured from the faintest and outmost red at one end, to the faintest and outmost blew at the other end.

Exper. 4. In the Sun's beam which was propagated into the Room through the hole in the Window-shut, at the distance of some Feet from the hole, I held the Prism in such a posture that its Axis might be perpendicular to that beam. Then I looked through the Prism upon the hole,

hole, and turning the Prism to and fro about its Axis to make the Image of the hole ascend and descend, when between its two contrary Motions it seemed stationary, I stopt the Prism that the Refractions on both sides of the refracting Angle might be equal to each other as in the former Experiment. In this Situation of the Prism viewing through it the said hole, I observed the length of its refracted Image to be many times greater than its breadth, and that the most refracted part thereof appeared violet, the least refracted red, the middle parts blew green and yellow in order. The same thing happened when I removed the Prism out of the Sun's Light, and looked through it upon the hole shining by the Light of the Clouds beyond it. And yet if the Refraction were done regularly according to one certain Proportion of the Sines of Incidence and Refraction as is vulgarly supposed, the refracted Image ought to have appeared round.

So then, by these two Experiments it appears that in equal Incidences there is a considerable inequality of Refractions: But whence this inequality arises, whether it be that some of the incident Rays are refracted more and others less, constantly or by chance, or that one and the same Ray is by Refraction disturbed, shattered, dilated, and as it were split and spread into many diverging Rays, as *Grimaldo* supposes, does not yet appear by these Experiments, but will appear by those that follow.

Exper. 5. Considering therefore, that if in the third Experiment the Image of the Sun should be drawn out into an oblong form, either by a Dilatation of every Ray, or by any other casual inequality of the Refractions, the same oblong Image would by a second Refraction made Sideways be drawn out as much in breadth by the like Dilatation of the Rays or other casual inequality of the Refractions

fractions Sideways, I tried what would be the Effects of such a second Refraction. For this end I ordered all things as in the third Experiment, and then placed a second Prism immediately after the first in a cross Position to it, that it might again refract the beam of the Sun's Light which came to it through the first Prism. In the first Prism this beam was refracted upwards, and in the second Sideways. And I found that by the Refraction of the second Prism the breadth of the Image was not increased, but its superior part which in the first Prism suffered the greater Refraction and appeared violet and blew, did again in the second Prism suffer a greater Refraction than its inferior part, which appeared red and yellow, and this without any Dilation of the Image in breadth.

Fig. 14. *Illustration.* Let S represent the Sun, F the hole in the Window, A B C the first Prism, D H the second Prism, Y the round Image of the Sun made by a direct beam of Light when the Prisms are taken away, P T the oblong Image of the Sun made by that beam passing through the first Prism alone when the second Prism is taken away, and *pt* the Image made by the cross Refractions of both Prisms together. Now if the Rays which tend towards the several Points of the round Image Y were dilated and spread by the Refraction of the first Prism, so that they should not any longer go in single Lines to single Points, but that every Ray being split, shattered, and changed from a Linear Ray to a Superficies of Rays diverging from the Point of Refraction, and lying in the Plane of the Angles of Incidence and Refraction, they should go in those Planes to so many Lines reaching almost from one end of the Image P T to the other, and if that Image should thence become oblong: those Rays and their several parts tending towards the several Points of
the

the Image $P T$ ought to be again dilated and spread Side-ways by the transverse Refraction of the second Prism, so as to compose a foursquare Image, such as is represented at $\pi 1$. For the better understanding of which, let the Image $P T$ be distinguished into five equal Parts $P Q K$, $K Q R L$, $L R S M$, $M S V N$, $N V T$. And by the same irregularity that the Orbicular Light Y is by the Refraction of the first Prism dilated and drawn out into a long Image $P T$, the the Light $P Q K$ which takes up a space of the same length and breadth with the Light Y ought to be by the Refraction of the second Prism dilated and drawn out into the long Image $\pi q k p$, and the Light $K Q R L$ into the long Image $k q r l$, and the Lights $L R S M$, $M S V N$, $N V T$ into so many other long Images $l r s m$, $m s v n$, $n v t 1$; and all these long Images would compose the foursquare Image $\pi 1$. Thus it ought to be were every Ray dilated by Refraction, and spread into a triangular Superficies of Rays diverging from the Point of Refraction. For the second Refraction would spread the Rays one way as much as the first doth another, and so dilate the Image in breadth as much as the first doth in length. And the same thing ought to happen, were some Rays casually refracted more than others. But the Event is otherwise. The Image $P T$ was not made broader by the Refraction of the second Prism, but only became oblique, as 'tis represented at $p t$, its upper end P being by the Refraction translated to a greater distance than its lower end T . So then the Light which went towards the upper end P of the Image, was (at equal Incidences) more refracted in the second Prism than the Light which tended towards the lower end T , that is the blew and violet, than the red and yellow; and therefore was more Refrangible. The same Light was by the Refraction of the first Prism translated further from the

place Y to which it tended before Refraction; and therefore suffered as well in the first Prism as in the second a greater Refraction than the rest of the Light, and by consequence was more Refrangible than the rest, even before its incidence on the first Prism.

Sometimes I placed a third Prism after the second, and sometimes also a fourth after the third, by all which the Image might be often refracted sideways: but the Rays which were more refracted than the rest in the first Prism were also more refracted in all the rest, and that without any Dilatation of the Image sideways: and therefore those Rays for their constancy of a greater Refraction are deservedly reputed more Refrangible.

Fig. 15. But that the meaning of this Experiment may more clearly appear, it is to be considered that the Rays which are equally Refrangible do fall upon a circle answering to the Sun's Disque. For this was proved in the third Experiment. By a circle I understand not here a perfect Geometrical Circle, but any Orbicular Figure whose length is equal to its breadth, and which, as to sense, may seem circular. Let therefore A G represent the circle which all the most Refrangible Rays propagated from the whole Disque of the Sun, would illuminate and paint upon the opposite Wall if they were alone; E L the circle which all the least Refrangible Rays would in like manner illuminate and paint if they were alone; B H, C J, D K, the circles which so many intermediate sorts of Rays would successively paint upon the Wall, if they were singly propagated from the Sun in successive Order, the rest being always intercepted; And conceive that there are other intermediate Circles without number which innumerable other intermediate sorts of Rays would successively paint upon the Wall if the Sun should successively emit every sort apart.

And

And seeing the Sun emits all these sorts at once, they must all together illuminate and paint innumerable equal circles, of all which, being according to their degrees of Refrangibility placed in order in a continual series, that oblong Spectrum $P T$ is composed which I described in the third Experiment. Now if the Sun's circular Image Y which is made by an unrefracted beam of Light was by any dilatation of the single Rays, or by any other irregularity in the Refraction of the first Prism, converted into the Oblong Spectrum, $P T$: then ought every circle $A G$, $B H$, $C J$, &c. in that Spectrum, by the cross Refraction of the second Prism again dilating or otherwise scattering the Rays as before, to be in like manner drawn out and transformed into an Oblong Figure, and thereby the breadth of the Image $P T$ would be now as much augmented as the length of the Image Y was before by the Refraction of the first Prism ; and thus by the Refractions of both Prisms together would be formed a foursquare Figure $p \pi t l$ as I described above. Wherefore since the breadth of the Spectrum $P T$ is not increased by the Refraction sideways, it is certain that the Rays are not split or dilated, or otherways irregularly scattered by that Refraction, but that every circle is by a regular and uniform Refraction translated entire into another place, as the circle $A G$ by the greatest Refraction into the place ag , the circle $B H$ by a less Refraction into the place bh , the circle $C J$ by a Refraction still less into the place ci , and so of the rest ; by which means a new Spectrum pt inclined to the former $P T$ is in like manner composed of circles lying in a right Line ; and these circles must be of the same bigness with the former, because the breadths of all the Spectrums Y , $P T$ and pt at equal distances from the Prisms are equal.

I considered further that by the breadth of the hole F through which the Light enters into the Dark Chamber, there is a Penumbra made in the circuit of the Spectrum Y, and that Penumbra remains in the rectilinear Sides of the Spectrums P T and *pt*. I placed therefore at that hole a Lens or Object-glass of a Telescope which might cast the Image of the Sun distinctly on Y without any Penumbra at all, and found that the Penumbra of the Rectilinear Sides of the oblong Spectrums P T and *pt* was also thereby taken away, so that those Sides appeared as distinctly defined as did the Circumference of the first Image Y. Thus it happens if the Glass of the Prisms be free from veins, and their Sides be accurately plane and well polished without those numberless waves or curls which usually arise from Sand-holes a little smoothed in polishing with Putty. If the Glass be only well polished and free from veins and the Sides not accurately plane but a little Convex or Concave, as it frequently happens; yet may the three Spectrums Y, P T and *pt* want Penumbras, but not in equal distances from the Prisms. Now from this want of Penumbras, I knew more certainly that every one of the circles was refracted according to some most regular, uniform, and constant law. For if there were any irregularity in the Refraction, the right Lines A E and G L which all the circles in the Spectrum P T do touch, could not by that Refraction be translated into the Lines *ae* and *gl* as distinct and straight as they were before, but there would arise in those translated Lines some Penumbra or crookedness or undulation, or other sensible Perturbation contrary to what is found by Experience. Whatsoever Penumbra or Perturbation should be made in the circles by the cross Refraction of the second Prism, all that Penumbra or Perturbation would be conspicuous in the

the

the right Lines ae and gl which touch those circles. And therefore since there is no such Penumbra or Perturbation in those right Lines there must be none in the circles. Since the distance between those Tangents or breadth of the Spectrum is not increased by the Refractions, the Diameters of the circles are not increased thereby. Since those Tangents continue to be right Lines, every circle which in the first Prism is more or less refracted, is exactly in the same Proportion more or less refracted in the second. And seeing all these things continue to succeed after the same manner when the Rays are again in a third Prism, and again in a fourth refracted Sideways, it is evident that the Rays of one and the same circle as to their degree of Refrangibility continue always Uniform and Homogeneous to one another, and that those of several circles do differ in degree of Refrangibility, and that in some certain and constant Proportion. Which is the thing I was to prove.

There is yet another Circumstance or two of this Ex-*Fig. 16.* periment by which it becomes still more plain and convincing. Let the second Prism DH be placed not immediately after the first, but at some distance from it; Suppose in the mid-way between it and the Wall on which the oblong Spectrum PT is cast, so that the Light from the first Prism may fall upon it in the form of an oblong Spectrum, $\pi 1$ Parallel to this second Prism, and be refracted Sideways to form the oblong Spectrum pt upon the Wall. And you will find as before, that this Spectrum pt is inclined to that Spectrum PT , which the first Prism forms alone without the second; the blew ends P and p being further distant from one another than the red ones T and t , and by consequence that the Rays which go to the blew end π of the Image $\pi 1$ and which therefore suffer the greatest Refraction in the first Prism, are again in the second Prism more refracted than the rest. The

Fig. 17. The same thing I try'd also by letting the Sun's Light into a dark Room through two little round holes F and ρ made in the Window, and with two Parallel Prisms ABC and $\alpha\beta\gamma$ placed at those holes (one at each) refracting those two beams of Light to the opposite Wall of the Chamber, in such manner that the two colour'd Images $P T$ and $m n$ which they there painted were joyned end to end and lay in one straight Line, the red end T of the one touching the blew end m of the other. For if these two refracted beams were again by a third Prism DH placed crost to the two first, refracted Sideways, and the Spectrums thereby translated to some other part of the Wall of the Chamber, suppose the Spectrum $P T$ to $p t$ and the Spectrum $M N$ to $m n$, these translated Spectrums $p t$ and $m n$ would not lie in one straight Line with their ends contiguous as before, but be broken off from one another and become Parallel, the blew end of the Image $m n$ being by a greater Refraction translated farther from its former place $M T$, than the red end t of the other Image $p t$ from the same place $M T$ which puts the Proposition past dispute. And this happens whether the third Prism DH be placed immediately after the two first or at a great distance from them, so that the Light refracted in the two first Prisms be either white and circular, or coloured and oblong when it falls on the third.

Exper. 6. In the middle of two thin Boards I made round holes a third part of an Inch in Diameter, and in the Window-shut a much broader hole, being made to let into my darkned Chamber a large beam of the Sun's Light; I placed a Prism behind the Shut in that beam to refract it towards the opposite Wall, and close behind the Prism I fixed one of the Boards, in such manner that the middle of the refracted Light might pass through the hole
made

made in it, and the rest be intercepted by the Board. Then at the distance of about twelve Feet from the first Board I fixed the other Board, in such manner that the middle of the refracted Light which came through the hole in the first Board and fell upon the opposite Wall might pass through the hole in this other Board, and the rest being intercepted by the Board might paint upon it the coloured Spectrum of the Sun. And close behind this Board I fixed another Prism to refract the Light which came through the hole. Then I returned speedily to the first Prism, and by turning it slowly to and fro about its Axis, I caused the Image which fell upon the second Board to move up and down upon that Board, that all its parts might successively pass through the hole in that Board and fall upon the Prism behind it. And in the mean time, I noted the places on the opposite Wall to which that Light after its Refraction in the second Prism did pass; and by the difference of the places I found that the Light which being most refracted in the first Prism did go to the blue end of the Image, was again more refracted in the second Prism than the Light which went to the red end of that Image, which proves as well the first Proposition as the second. And this happened whether the Axis of the two Prisms were parallel, or inclined to one another and to the Horizon in any given Angles.

Illustration. Let F be the wide hole in the Window-shut, *Fig. 18.* through which the Sun shines upon the first Prism A B C, and let the refracted Light fall upon the middle of the Board D E, and the middle part of that Light upon the hole G made in the middle of that Board. Let this trajected part of the Light fall again upon the middle of the second Board *d e* and there paint such an oblong coloured Image of the Sun as was described in the third Experiment.

By

By turning the Prism $A B C$ slowly to and fro about its Axis this Image will be made to move up and down the Board $d e$, and by this means all its parts from one end to the other may be made to pass successively through the hole g which is made in the middle of that Board. In the mean while another Prism $a b c$ is to be fixed next after that hole g to refract the trajected Light a second time. And these things being thus ordered, I marked the places M and N of the opposite Wall upon which the refracted Light fell, and found that whilst the two Boards and second Prism remained unmoved, those places by turning the first Prism about its Axis were changed perpetually. For when the lower part of the Light which fell upon the second Board $d e$ was cast through the hole g it went to a lower place M on the Wall, and when the higher part of that Light was cast through the same hole g , it went to a higher place N on the Wall, and when any intermediate part of the Light was cast through that hole it went to some place on the Wall between M and N . The unchanged Position of the holes in the Boards, made the Incidence of the Rays upon the second Prism to be the same in all cases. And yet in that common Incidence some of the Rays were more refracted and others less. And those were more refracted in this Prism which by a greater Refraction in the first Prism were more turned out of the way, and therefore for their constancy of being more refracted are deservedly called more Refrangible.

Exper. 7. At two holes made near one another in my Window-shut I placed two Prisms, one at each, which might cast upon the opposite Wall (after the manner of the third Experiment) two oblong coloured Images of the Sun. And at a little distance from the Wall I placed a long slender Paper with straight and parallel edges, and
ordered

ordered the Prisms and Paper so, that the red Colour of one Image might fall directly upon one half of the Paper, and the violet colour of the other Image upon the other half of the same Paper; so that the Paper appeared of two Colours, red and violet, much after the manner of the painted Paper in the first and second Experiments. Then with a black Cloth I covered the Wall behind the Paper, that no Light might be reflected from it to disturb the Experiment, and viewing the Paper through a third Prism held parallel to it, I saw that half of it which was illuminated by the Violet-light to be divided from the other half by a greater Refraction, especially when I went a good way off from the Paper. For when I viewed it too near at hand, the two halves of the Paper did not appear fully divided from one another, but seemed contiguous at one of their Angles like the painted Paper in the first Experiment. Which also happened when the Paper was too broad.

Sometimes instead of the Paper I used a white Thred, and this appeared through the Prism divided into two Parallel Threds as is represented in the 19th Figure, where *Fig. 19.* *D G* denotes the Thred illuminated with violet Light from *D* to *E* and with red Light from *F* to *G*, and *d e f g* are the parts of the Thred seen by Refraction. If one half of the Thred be constantly illuminated with red, and the other half be illuminated with all the Colours successively, (which may be done by causing one of the Prisms to be turned about its Axis whilst the other remains unmoved) this other half in viewing the Thred through the Prism, will appear in a continued right Line with the first half when illuminated with red, and begin to be a little divided from it when illuminated with Orange, and remove further from it when illuminated with Yellow, and still
E
further

further when with Green, and further when with Blew, and go yet further off when illuminated with Indigo, and furthest when with deep Violet. Which plainly shews, that the Lights of several Colours are more and more Refrangible one than another, in this order of their Colours, Red, Orange, Yellow, Green, Blew, Indigo, deep Violet ; and so proves as well the first Proposition as the second.

Fig. 17. I caused also the coloured Spectrums P T and M N made in a dark Chamber by the Refractions of two Prisms to lye in a right Line end to end, as was described above in the fifth Experiment, and viewing them through a third Prism held Parallel to their length, they appeared no longer in a right Line, but became broken from one another, as they are represented at *p t* and *m n*, the violet end *m* of the Spectrum *m n* being by a greater Refraction translated further from its former place M T than the red end *t* of the other Spectrum *p t*.

Fig. 20. I further caused those two Spectrums P T and M N to become co-incident in an inverted order of their Colours, the red end of each falling on the violet end of the other, as they are represented in the oblong Figure P T M N ; and then viewing them through a Prism D H held Parallel to their length, they appeared not co-incident as when viewed with the naked Eye, but in the form of two distinct Spectrums *p t* and *m n* crossing one another in the middle after the manner of the letter X. Which shews that the red of the one Spectrum and violet of the other, which were co-incident at P N and M T, being parted from one another by a greater Refraction of the violet to *p* and *m* than of the red to *n* and *t*, do differ in degrees of Refrangibility.

I illuminated also a little circular piece of white Paper all over with the Lights of both Prisms intermixed, and
when

when it was illuminated with the red of one Spectrum and deep violet of the other, so as by the mixture of those Colours to appear all over purple, I viewed the Paper, first at a less distance, and then at a greater, through a third Prism; and as I went from the Paper, the refracted Image thereof became more and more divided by the unequal Refraction of the two mixed Colours, and at length parted into two distinct Images, a red one and a violet one, whereof the violet was furthest from the Paper, and therefore suffered the greatest Refraction. And when that Prism at the Window which cast the violet on the Paper was taken away, the violet Image disappeared; but when the other Prism was taken away the red vanished: which shews that these two Images were nothing else than the Lights of the two Prisms which had been intermixed on the purple Paper, but were parted again by their unequal Refractions made in the third Prism through which the Paper was viewed. This also was observable that if one of the Prisms at the Window, suppose that which cast the violet on the Paper, was turned about its Axis to make all the Colours in this order, Violet, Indigo, Blew, Green, Yellow, Orange, Red, fall successively on the Paper from that Prism, the violet Image changed Colour accordingly, and in changing Colour came nearer to the red one, until when it was also red they both became fully co-incident.

I placed also two paper circles very near one another, the one in the red Light of one Prism, and the other in the violet Light of the other. The circles were each of them an Inch in Diameter, and behind them the Wall was dark that the Experiment might not be disturbed by any Light coming from thence. These circles thus illuminated, I viewed through a Prism so held that the Refraction might be made towards the red circle, and as I went from them

they came nearer and nearer together, and at length became co-incident; and afterwards when I went still further off, they parted again in a contrary order, the violet by a greater Refraction being carried beyond the red.

Exper. 8. In Summer when the Sun's Light uses to be strongest, I placed a Prism at the hole of the Window-shut, as in the third Experiment, yet so that its Axis might be Parallel to the Axis of the World, and at the opposite Wall in the Sun's refracted Light, I placed an open Book. Then going Six Feet and two Inches from the Book, I placed there the abovementioned Lens, by which the Light reflected from the Book might be made to converge and meet again at the distance of six Feet and two Inches behind the Lens, and there paint the Species of the Book upon a sheet of white Paper much after the manner of the second Experiment. The Book and Lens being made fast, I noted the place where the Paper was, when the Letters of the Book, illuminated by the fullest red Light of the Solar Image falling upon it, did cast their Species on that Paper most distinctly; And then I stay'd till by the Motion of the Sun and consequent Motion of his Image on the Book, all the Colours from that red to the middle of the blew pass'd over those Letters; and when those Letters were illuminated by that blew, I noted again the place of the Paper when they cast their Species most distinctly upon it: And I found that this last place of the Paper was nearer to the Lens than its former place by about two Inches and an half, or two and three quarters. So much sooner therefore did the Light in the violet end of the Image by a greater Refraction converge and meet, than the Light in the red end. But in trying this the Chamber was as dark as I could make it. For if these Colours be diluted and weakened by the mixture of any adventitious Light, the distance between

between the places of the Paper will not be so great. This distance in the second Experiment where the Colours of natural Bodies were made use of, was but an Inch and a half, by reason of the imperfection of those Colours. Here in the Colours of the Prism, which are manifestly more full, intense, and lively than those of natural Bodies, the distance is two Inches and three quarters. And were the Colours still more full, I question not but that the distance would be considerably greater. For the coloured Light of the Prism, by the interfering of the Circles described in the 11th Figure of the fifth Experiment, and also by the Light of the very bright Clouds next the Sun's Body intermixing with these Colours, and by the Light scattered by the inequalities in the polish of the Prism, was so very much compounded, that the Species which those faint and dark Colours, the Indigo and Violet, cast upon the Paper were not distinct enough to be well observed.

Exper. 9. A Prism, whose two Angles at its Base were equal to one another and half right ones, and the third a right one, I placed in a beam of the Sun's Light let into a dark Chamber through a hole in the Window-shut as in the third Experiment. And turning the Prism slowly about its Axis until all the Light which went through one of its Angles and was refracted by it began to be reflected by its Base, at which till then it went out of the Glass, I observed that those Rays which had suffered the greatest Refraction were sooner reflected than the rest. I conceived therefore that those Rays of the reflected Light, which were most Refrangible, did first of all by a total Reflexion become more copious in that Light than the rest, and that afterwards the rest also, by a total Reflexion, became as copious as these. To try this, I made the reflected Light pass through another Prism, and being refracted

cted by it to fall afterwards upon a sheet of white Paper placed at some distance behind it, and there by that Refraction to paint the usual Colours of the Prism. And then causing the first Prism to be turned about its Axis as above, I observed that when those Rays which in this Prism had suffered the greatest Refraction and appeared of a blew and violet Colour began to be totally reflected, the blew and violet Light on the Paper which was most refracted in the second Prism received a sensible increase above that of the red and yellow, which was least refracted; and afterwards when the rest of the Light which was green, yellow and red began to be totally reflected in the first Prism, the light of those Colours on the Paper received as great an increase as the violet and blew had done before. Whence 'tis manifest, that the beam of Light reflected by the Base of the Prism, being augmented first by the more Refrangible Rays and afterwards by the less Refrangible ones, is compounded of Rays differently Refrangible. And that all such reflected Light is of the same Nature with the Sun's Light, before its Incidence on the Base of the Prism, no Man ever doubted: it being generally allowed, that Light by such Reflexions suffers no Alteration in its Modifications and Properties. I do not here take notice of any Refractions made in the Sides of the first Prism, because the Light enters it perpendicularly at the first Side, and goes out perpendicularly at the second Side, and therefore suffers none. So then, the Sun's incident Light being of the same temper and constitution with his emergent Light, and the last being compounded of Rays differently Refrangible, the first must be in like manner compounded.

Fig. 21. *Illustration.* In the 21th Figure, A B C is the first Prism, B C its Base, B and C its equal Angles at the Base, each
of

of 45 degrees, A its Rectangular Vertex, F M a beam of the Sun's Light let into a dark Room through a hole F one third part of an Inch broad, M its Incidence on the Base of the Prism, M G a less refracted Ray, M H a more refracted Ray, M N the beam of Light reflected from the Base, V X Y the second Prism by which this beam in passing through it is refracted, N t the less refracted Light of this beam, and N p the more refracted part thereof. When the first Prism A B C is turned about its Axis according to the order of the Letters A B C, the Rays M H emerge more and more obliquely out of that Prism, and at length after their most oblique Emergence are reflected towards N, and going on to p do increase the number of the Rays N p. Afterwards by continuing the motion of the first Prism, the Rays M G are also reflected to N and increase the number of the Rays N t. And therefore the Light M N admits into its Composition, first the more Refrangible Rays, and then the less Refrangible Rays, and yet after this Composition is of the same Nature with the Sun's immediate Light F M, the Reflexion of the specular Base B C causing no Alteration therein.

Exper. 10. Two Prisms, which were alike in shape, I tied so together, that their Axes and opposite Sides being Parallel, they composed a Parallelopiped. And, the Sun shining into my dark Chamber through a little hole in the Window-shut, I placed that Parallelopiped in his beam at some distance from the hole, in such a posture that the Axes of the Prisms might be perpendicular to the incident Rays, and that those Rays being incident upon the first Side of one Prism, might go on through the two contiguous Sides of both Prisms, and emerge out of the last Side of the second Prism. This Side being Parallel to the first Side of the first Prism, caused the emerging Light to be Parallel
to

to the Incident. Then, beyond these two Prisms I placed a third, which might refract that emergent Light, and by that Refraction cast the usual Colours of the Prism upon the opposite Wall, or upon a sheet of white Paper held at a convenient distance behind the Prism for that refracted Light to fall upon it. After this I turned the Parallelopiped about its Axis, and found that when the contiguous Sides of the two Prisms became so oblique to the incident Rays that those Rays began all of them to be reflected, those Rays which in the third Prism had suffered the greatest Refraction and painted the Paper with violet and blew, were first of all by a total Reflexion taken out of the transmitted Light, the rest remaining and on the Paper painting their Colours of Green, Yellow, Orange, and Red as before; and afterwards by continuing the motion of the two Prisms, the rest of the Rays also by a total Reflexion vanished in order, according to their degrees of Refrangibility. The Light therefore which emerged out of the two Prisms is compounded of Rays differently Refrangible, seeing the more Refrangible Rays may be taken out of it while the less Refrangible remain. But this Light being trajected only through the Parallel Superficies of the two Prisms, if it suffered any change by the Refraction of one Superficies it lost that impression by the contrary Refraction of the other Superficies, and so being restored to its pristine constitution became of the same nature and condition as at first before its Incidence on those Prisms; and therefore, before its Incidence, was as much compounded of Rays differently Refrangible as afterwards.

Fig. 22. *Illustration.* In the 22th Figure A B C and B C D are the two Prisms tied together in the form of a Parallelopiped, their Sides B C and C B being contiguous, and their Sides A B and C D Parallel. And H J K is the third Prism,

Prism, by which the Sun's Light propagated through the hole F into the dark Chamber, and there passing through those sides of the Prisms AB, BC, CB and CD, is refracted at O to the white Paper PT, falling there partly upon P by a greater Refraction, partly upon T by a less Refraction, and partly upon R and other intermediate places by intermediate Refractions. By turning the Parallelopiped ACBD about its Axis, according to the order of the Letters A, C, D, B, at length when the contiguous Planes BC and CB become sufficiently oblique to the Rays FM, which are incident upon them at M, there will vanish totally out of the refracted Light OPT, first of all the most refracted Rays OP, (the rest OR and OT remaining as before) then the Rays OR and other intermediate ones, and lastly, the least refracted Rays OT. For when the Plane BC becomes sufficiently oblique to the Rays incident upon it, those Rays will begin to be totally reflected by it towards N; and first the most Refrangible Rays will be totally reflected (as was explained in the preceding experiment) and by consequence must first disappear at P, and afterwards the rest as they are in order totally reflected to N, they must disappear in the same order at R and T. So then the Rays which at O suffer the greatest Refraction, may be taken out of the Light MO whilst the rest of the Rays remain in it, and therefore that Light MO is Compounded of Rays differently Refrangible. And because the Planes AB and CD are parallel, and therefore by equal and contrary Refractions destroy one anothers Effects, the incident Light FM must be of the same kind and nature with the emergent Light MO, and therefore doth also consist of Rays differently Refrangible. These two Lights FM and MO, before the most refrangible Rays are separated out of the emergent Light MO agree in Co-

F

lour,

lour, and in all other properties so far as my observation reaches, and therefore are deservedly reputed of the same Nature and Constitution, and by consequence the one is compounded as well as the other. But after the most Refrangible Rays begin to be totally reflected, and thereby separated out of the emergent Light MO, that Light changes its Colour from white to a dilute and faint yellow, a pretty good orange, a very full red successively and then totally vanishes. For after the most Refrangible Rays which paint the Paper at P with a Purple Colour, are by a total reflexion taken out of the Beam of light MO, the rest of the Colours which appear on the Paper at R and T being mixed in the light MO compound there a faint yellow, and after the blue and part of the green which appear on the Paper between P and R are taken away, the rest which appear between R and T (that is the Yellow, Orange, Red and a little Green) being mixed in the Beam MO compound there an Orange; and when all the Rays are by reflexion taken out of the Beam MO, except the least Refrangible, which at T appear of a full Red, their Colour is the same in that Beam MO as afterwards at T, the Refraction of the Prism HJK serving only to separate the differently Refrangible Rays, without making any alteration in their Colours, as shall be more fully proved hereafter. All which confirms as well the first Proposition as the second.

Scholium. If this Experiment and the former be conjoyned and made one, by applying a fourth Prism VXY to refract the reflected Beam MN towards tp , the conclusion will be clearer. For then the light Np which in the 4th Prism is more refracted, will become fuller and stronger when the Light OP, which in the third Prism HJK is more refracted, vanishes at P; and afterwards when the less refracted

refracted Light OT vanishes at T , the less refracted Light Nt will become increased whilst the more refracted Light at p receives no further increase. And as the trajected Beam MO in vanishing is always of such a Colour as ought to result from the mixture of the Colours which fall upon the Paper PT , so is the reflected Beam MN always of such a Colour as ought to result from the mixture of the Colours which fall upon the Paper pt . For when the most refrangible Rays are by a total Reflexion taken out of the Beam MO , and leave that Beam of an Orange Colour, the excess of those Rays in the reflected Light, does not only make the Violet, Indigo and Blue at p more full, but also makes the Beam MN change from the yellowish Colour of the Sun's Light, to a pale white inclining to blue, and afterward recover its yellowish Colour again, so soon as all the rest of the transmitted light MOT is reflected.

Now seeing that in all this variety of Experiments, whether the trial be made in Light reflected, and that either from natural Bodies, as in the first and second Experiment, or Specular, as in the Ninth; or in Light refracted, and that either before the unequally refracted Rays are by diverging separated from one another, and losing their whiteness which they have altogether, appear severally of several Colours, as in the fifth Experiment; or after they are separated from one another, and appear Coloured as in the sixth, seventh, and eighth Experiments; or in Light trajected through Parallel superficies, destroying each others Effects as in the 10th Experiment; there are always found Rays, which at equal Incidences on the same Medium suffer unequal Refractions, and that without any splitting or dilating of single Rays, or contingency in the inequality of the Refractions, as is proved in the fifth and sixth Experiments;

periments; and seeing the Rays which differ in Refrangibility may be parted and sorted from one another, and that either by Refraction as in the third Experiment, or by Reflexion as in the tenth, and then the several sorts apart at equal Incidences suffer unequal Refractions, and those sorts are more refracted than others after separation, which were more refracted before it, as in the sixth and following Experiments, and if the Sun's Light be trajected through three or more cross Prisms successively, those Rays which in the first Prism are refracted more than others are in all the following Prisms, refracted more then others in the same rate and proportion, as appears by the fifth Experiment; it's manifest that the Sun's Light is an Heterogeneous mixture of Rays, some of which are constantly more Refrangible then others, as was to be propos'd.

P R O P. III. Theor. III.

The Sun's Light consists of Rays differing in Reflexibility, and those Rays are more Reflexible than others which are more Refrangible.

THIS is manifest by the ninth and tenth Experiments: For in the ninth Experiment, by turning the Prism about its Axis, until the Rays within it which in going out into the Air were refracted by its Base, became so oblique to that Base, as to begin to be totally reflected thereby; those Rays became first of all totally reflected, which before at equal Incidences with the rest had suffered the greatest Refraction. And the same thing happens in the Reflexion made by the common Base of the two Prisms in the tenth Experiment.

PROP. IV. Prob. I.

To separate from one another the Heterogeneous Rays of Compound Light.

THE Heterogeneous Rays are in some measure separated from one another by the Refraction of the Prism in the third Experiment, and in the fifth Experiment by taking away the Penumbra from the Rectilinear sides of the Coloured Image, that separation in those very Rectilinear sides or straight edges of the Image becomes perfect. But in all places between those rectilinear edges, those innumerable Circles there described, which are severally illuminated by Homogeneous Rays, by interfering with one another, and being every where commixt, do render the Light sufficiently Compound. But if these Circles, whilst their Centers keep their distances and positions, could be made less in Diameter, their interfering one with another and by consequence the mixture of the Heterogeneous Rays would be proportionally diminished. In the 23th *Fig. 23.* Figure let AG, BH, CJ, DK, EL, FM be the Circles which so many sorts of Rays flowing from the same Disque of the Sun, do in the third Experiment illuminate; of all which and innumerable other intermediate ones lying in a continual Series between the two Rectilinear and Parallel edges of the Sun's oblong Image PT , that Image is composed as was explained in the fifth Experiment. And let ag, bh, ci, dk, el, fm be so many less Circles lying in a like continual Series between two Parallel right Lines af and gm with the same distances between their Centers, and illuminated by the same sorts of Rays, that is the Circle ag with the same sort by which the corresponding Circle

Circle *A G* was illuminated, and the Circle *bb* with the same sort by which the corresponding Circle *BH* was illuminated, and the rest of the Circles *ci*, *dk*, *el*, *fm* respectively, with the same sorts of Rays by which the several corresponding Circles *CJ*, *DK*, *EL*, *FM* were illuminated. In the Figure *P T* composed of the greater Circles, three of those Circles *A G*, *BH*, *CJ*, are so expanded into one another, that the three sorts of Rays by which those Circles are illuminated, together with other innumerable sorts of intermediate Rays, are mixed at *QR* in the middle of the Circle *BH*. And the like mixture happens throughout almost the whole length of the Figure *P T*. But in the Figure *pt* composed of the less Circles, the three less Circles *ag*, *bh*, *ci*, which answer to those three greater, do not extend into one another; nor are there any where mingled so much as any two of the three sorts of Rays by which those Circles are illuminated, and which in the Figure *P T* are all of them intermingled at *BH*.

Now he that shall thus consider it, will easily understand that the mixture is diminished in the same Proportion with the Diameters of the Circles. If the Diameters of the Circles whilst their Centers remain the same, be made three times less than before, the mixture will be also three times less; if ten times less, the mixture will be ten times less, and so of other Proportions. That is, the mixture of the Rays in the greater Figure *P T* will be to their mixture in the less *pt*, as the Latitude of the greater Figure is to the Latitude of the less. For the Latitudes of these Figures are equal to the Diameters of their Circles. And hence it easily follows, that the mixture of the Rays in the refracted Spectrum *pt* is to the mixture of the Rays in the direct and immediate Light of the Sun, as the breadth of that Spectrum is to the difference between the length and breadth of the same Spectrum. So

So then, if we would diminish the mixture of the Rays, we are to diminish the Diameters of the Circles. Now these would be diminished if the Sun's Diameter to which they answer could be made less than it is, or (which comes to the same purpose) if without Doors, at a great distance from the Prism towards the Sun, some opake body were placed, with a round hole in the middle of it, to intercept all the Sun's Light, excepting so much as coming from the middle of his Body could pass through that hole to the Prism. For so the Circles A G, B H and the rest, would not any longer answer to the whole Disque of the Sun, but only to that part of it which could be seen from the Prism through that hole, that is to the apparent magnitude of that hole viewed from the Prism. But that these Circles may answer more distinctly to that hole a Lens is to be placed by the Prism to cast the Image of the hole, (that is, every one of the Circles A G, B H, &c.) distinctly upon the Paper at P T, after such a manner as by a Lens placed at a Window the Species of Objects abroad are cast distinctly upon a Paper within the Room, and the Rectilinear Sides of the oblong solar Image in the fifth Experiment became distinct without any Penumbra. If this be done it will not be necessary to place that hole very far off, no not beyond the Window. And therefore instead of that hole, I used the hole in the Window-shut as follows.

Exper. 11. In the Sun's Light let into my darkned Chamber through a small round hole in my Window-shut, at about 10 or 12 Feet from the Window, I placed a Lens, by which the Image of the hole might be distinctly cast upon a sheet of white Paper, placed at the distance of six, eight, ten or twelve Feet from the Lens. For according to the difference of the Lenses I used various distances,

distances, which I think not worth the while to describe. Then immediately after the Lens I placed a Prism, by which the trajected Light might be refracted either upwards or sideways, and thereby the round Image which the Lens alone did cast upon the Paper might be drawn out into a long one with Parallel Sides, as in the third Experiment. This oblong Image I let fall upon another Paper at about the same distance from the Prism as before, moving the Paper either towards the Prism or from it, until I found the just distance where the Rectilinear Sides of the Image became most distinct. For in this case the circular Images of the hole which compose that Image after the same manner that the Circles *ag*, *bh*, *ci*, &c. do

Fig. 23. the Figure *pt*, were terminated most distinctly without any Penumbra, and therefore extended into one another the least that they could, and by consequence the mixture of the Heterogeneous Rays was now the least of all. By this
Fig. 23, means I used to form an oblong Image (such as is *pt*) of
and 24. circular Images of the hole (such as are *ag*, *bh*, *ci*, &c.) and by using a greater or less hole in the Window-shut, I made the circular Images *ag*, *bh*, *ci*, &c. of which it was formed, to become greater or less at pleasure, and thereby the mixture of the Rays in the Image *pt* to be as much or as little as I desired.

Fig. 24. *Illustration.* In the 24th Figure, F represents the circular hole in the Window-shut, MN the Lens whereby the Image or Species of that hole is cast distinctly upon a Paper at J, A B C the Prism whereby the Rays are at their emerging out of the Lens refracted from J towards another Paper at *pt*, and the round Image at J is turned into an oblong Image *pt* falling on that other Paper. This Image *pt* consists of Circles placed one after another in a Rectilinear order, as was sufficiently explained in the fifth Experiment;

Experiment; and these Circles are equal to the Circle I, and consequently answer in Magnitude to the hole F; and therefore by diminishing that hole they may be at pleasure diminished, whilst their Centers remain in their places. By this means I made the breadth of the Image pt to be forty times, and sometimes sixty or seventy times less than its length. As for instance, if the breadth of the hole F be $\frac{1}{10}$ of an Inch, and MF the distance of the Lens from the hole be 12 Feet; and if pB or pM the distance of the Image pt from the Prism or Lens be 10 Feet, and the refracting Angle of the Prism be 62 degrees, the breadth of the Image pt will be $\frac{1}{12}$ of an Inch and the length about six Inches, and therefore the length to the breadth as 72 to 1, and by consequence the Light of this Image 71 times less compound than the Sun's direct Light. And Light thus far Simple and Homogeneous, is sufficient for trying all the Experiments in this Book about simple Light. For the composition of Heterogeneous Rays is in this Light so little that it is scarce to be discovered and perceived by sense, except perhaps in the Indigo and Violet; for these being dark Colours, do easily suffer a sensible alloy by that little scattering Light which uses to be refracted irregularly by the inequalities of the Prism.

Yet instead of the circular hole F, 'tis better to substitute an oblong hole shaped like a long Parallelogram with its length Parallel to the Prism ABC. For if this hole be an Inch or two long, and but a tenth or twentieth part of an Inch broad or narrower: the Light of the Image pt will be as Simple as before or simpler, and the Image will become much broader, and therefore more fit to have Experiments tried in its Light than before.

Instead of this Parallelogram-hole may be substituted a Triangular one of equal Sides, whose Base for instance is

about the tenth part of an Inch, and its height an Inch or more. For by this means, if the Axis of the Prism be Parallel to the Perpendicular of the Triangle, the Image *pt* will now be formed of Equicrural Triangles *ag*, *bh*, *ci*, *dk*, *el*, *fm*, &c. and innumerable other intermediate ones answering to the Triangular hole in shape and bigness, and lying one after another in a continual Series between two Parallel Lines *af* and *gm*. These Triangles are a little intermingled at their Bases but not at their Vertices, and therefore the Light on the brighter side *af* of the Image where the Bases of the Triangles are is a little compounded, but on the darker side *gm* is altogether uncompounded, and in all places between the sides the Composition is Proportional to the distances of the places from that obscurer side *gm*. And having a Spectrum *pt* of such a Composition, we may try Experiments either in its stronger and less simple Light near the side *af*, or in its weaker and simpler Light near the other side *lm*, as it shall seem most convenient.

But in making Experiments of this kind the Chamber ought to be made as dark as can be, least any foreign Light mingle it self with the Light of the Spectrum *pt*, and render it compound; especially if we would try Experiments in the more simple Light next the side *gm* of the Spectrum; which being fainter, will have a less Proportion to the foreign Light, and so by the mixture of that Light be more troubled and made more compound. The Lens also ought to be good, such as may serve for Optical Uses, and the Prism ought to have a large Angle, suppose of 70 degrees, and to be well wrought, being made of Glass free from Bubbles and Veins, with its sides not a little Convex or Concave as usually happens but truly Plane, and its polish elaborate, as in working Optick-glasses,

glasses, and not such as is usually wrought with Putty, whereby the edges of the Sand-holes being worn away, there are left all over the Glass a numberless company of very little Convex polite risings like Waves. The edges also of the Prism and Lens so far as they may make any irregular Refraction, must be covered with a black Paper glewed on. And all the Light of the Sun's beam let into the Chamber which is usefess and unprofitable to the Experiment, ought to be intercepted with black Paper or other black Obstacles. For otherwise the usefess Light being reflected every way in the Chamber, will mix with the oblong Spectrum and help to disturb it. In trying these things so much Diligence is not altogether necessary, but it will promote the success of the Experiments, and by a very scrupulous Examiner of things deserves to be applied. It's difficult to get glass Prisms fit for this purpose, and and therefore I used sometimes Prismatick Vessels made with pieces of broken Looking-glasses, and filled with rain Water. And to increase the Refraction, I sometimes impregnated the Water strongly with *Saccharum Saturni*.

P R O P. V. Theor. IV.

Homogeneal Light is refracted regularly without any Dilatation Splitting or Shattering of the Rays, and the confused Vision of Objects seen through Refracting Bodies by Heterogeneal Light arises from the different Refrangibility of several sorts of Rays.

THE first Part of this Proposition has been already sufficiently proved in the fifth Experiment, and will further appear by the Experiments which follow.

Exper. 12. In the middle of a black Paper I made a round hole about a fifth or sixth part of an Inch in Diameter. Upon this Paper I caused the Spectrum of Homogeneous Light described in the former Proposition, so to fall, that some part of the Light might pass through the hole of the Paper. This transmitted part of the Light I refracted with a Prism placed behind the Paper, and letting this refracted Light fall perpendicularly upon a white Paper two or three Feet distant from the Prism, I found that the Spectrum formed on the Paper by this Light was not oblong, as when 'tis made (in the third Experiment) by Refracting the Sun's compound Light, but was (so far as I could judge by my Eye) perfectly circular, the length being no greater than the breadth. Which shews that this Light is refracted regularly without any Dilatation of the Rays.

Exper. 13. In the Homogeneous Light I placed a Circle of $\frac{1}{4}$ of an Inch in Diameter, and in the Sun's unrefracted Heterogeneous white Light I placed another Paper Circle of the same bigness. And going from the Papers to the distance of some Feet, I viewed both Circles through a Prism. The Circle illuminated by the Sun's Heterogeneous Light appeared very oblong as in the fourth Experiment, the length being many times greater than the breadth: but the other Circle illuminated with Homogeneous Light appeared Circular and distinctly defined as when 'tis viewed with the naked Eye. Which proves the whole Proposition.

Exper. 14. In the Homogeneous Light I placed Flies and such like Minute Objects, and viewing them through a Prism, I saw their Parts as distinctly defined as if I had viewed them with the naked Eye. The same Objects placed in the Sun's unrefracted Heterogeneous Light which was white I viewed also through a Prism, and saw them most confusedly

confusedly defined, so that I could not distinguish their smaller Parts from one another. I placed also the Letters of a small Print one while in the Homogeneous Light and then in the Heterogeneous, and viewing them through a Prism, they appeared in the latter case so confused and indistinct that I could not read them; but in the former they appeared so distinct that I could read readily, and thought I saw them as distinct as when I viewed them with my naked Eye. In both cases I viewed the same Objects through the same Prism at the same distance from me and in the same Situation. There was no difference but in the Light by which the Objects were illuminated, and which in one case was Simple and in the other Compound, and therefore the distinct Vision in the former case and confused in the latter could arise from nothing else than from that difference of the Lights. Which proves the whole Proposition.

And in these three Experiments it is further very remarkable, that the Colour of Homogeneous Light was never changed by the Refraction.

P R O P. VI. Theor. V.

The Sine of Incidence of every Ray considered apart, is to its Sine of Refraction in a given Ratio.

THAT every Ray considered apart is constant to it self in some certain degree of Refrangibility, is sufficiently manifest out of what has been said. Those Rays which in the first Refraction are at equal Incidences most refracted, are also in the following Refractions at equal Incidences most refracted; and so of the least Refrangible, and the rest which have any mean degree of Refran-

Refrangibility, as is manifest by the 5th, 6th, 7th, 8th, and 9th Experiments. And those which the first time at like Incidences are equally refracted, are again at like Incidences equally and uniformly refracted, and that whether they be refracted before they be separated from one another as in the 5th Experiment, or whether they be refracted apart, as in the 12th, 13th and 14th Experiments. The Refraction therefore of every Ray apart is regular, and what Rule that Refraction observes we are now to shew.

The late Writers in Opticks teach, that the Sines of Incidence are in a given Proportion to the Sines of Refraction, as was explained in the 5th Axiom; and some by Instruments fitted for measuring Refractions, or otherwise experimentally examining this Proportion, do acquaint us that they have found it accurate. But whilst they, not understanding the different Refrangibility of several Rays, conceived them all to be refracted according to one and the same Proportion, 'tis to be presumed that they adapted their Measures only to the middle of the refracted Light; so that from their Measures we may conclude only that the Rays which have a mean degree of Refrangibility, that is those which when separated from the rest appear green, are refracted according to a given Proportion of their Sines. And therefore we are now to shew that the like given Proportions obtain in all the rest. That it should be so is very reasonable, Nature being ever conformable to her self: but an experimental Proof is desired. And such a Proof will be had if we can shew that the Sines of Refraction of Rays differently Refrangible are one to another in a given Proportion when their Sines of Incidence are equal. For if the Sines of Refraction of all the Rays are in given Proportions to the Sine of Refraction
of

of a Ray which has a mean degree of Refrangibility, and this Sine is in a given Proportion to the equal Sines of Incidence, those other Sines of Refraction will also be in given Proportions to the equal Sines of Incidence. Now when the Sines of Incidence are equal, it will appear by the following Experiment that the Sines of Refraction are in a given Proportion to one another.

Exper. 15. The Sun shining into a dark Chamber through a little round hole in the Window-shut, let S re-*Fig. 26.*
 present his round white Image painted on the opposite Wall by his direct Light, P T his oblong coloured Image made by refracting that Light with a Prism placed at the Window; and *pt*, or *2p 2t*, or *3p 3t*, his oblong coloured Image made by refracting again the same Light sideways with a second Prism placed immediately after the first in a cross Position to it, as was explained in the fifth Experiment: that is to say, *pt* when the Refraction of the second Prism is small, *2p 2t* when its Refraction is greater, and *3p 3t* when it is greatest. For such will be the diversity of the Refractions if the refracting Angle of the second Prism be of various Magnitudes; suppose of fifteen or twenty degrees to make the Image *pt*, of thirty or forty to make the Image *2p 2t*, and of sixty to make the Image *3p 3t*. But for want of solid Glass Prisms with Angles of convenient bignesses, there may be Vessels made of polished Plates of Glass cemented together in the form of Prisms and filled with Water. These things being thus ordered, I observed that all the solar Images or coloured Spectrums P T, *pt*, *2p 2t*, *3p 3t* did very nearly converge to the place S on which the direct Light of the Sun fell and painted his white round Image when the Prisms were taken away. The Axis of the Spectrum P T, that is the Line drawn through the middle of it Parallel to
 its

its Rectilinear Sides, did when produced pass exactly through the middle of that white round Image S. And when the Refraction of the second Prism was equal to the Refraction of the first, the refracting Angles of them both being about 60 degrees, the Axis of the Spectrum $z p z t$ made by that Refraction, did when produced pass also through the middle of the same white round Image S. But when the Refraction of the second Prism was less than that of the first, the produced Axes of the Spectrums $t p$ or $2 t 2 p$ made by that Refraction did cut the produced Axis of the Spectrum $T P$ in the Points m and n , a little beyond the Center of that white round Image S. Whence the Proportion of the Line $z t T$ to the Line $z p P$ was a little greater than the Proportion of $2 t T$ to $2 p P$, and this Proportion a little greater than that of $t T$ to $p P$. Now when the Light of the Spectrum $P T$ falls perpendicularly upon the Wall, those Lines $z t T$, $z p P$, and $2 t T$, $2 p P$ and $t T$, $p P$, are the Tangents of the Refractions; and therefore by this Experiment the Proportions of the Tangents of the Refractions are obtained, from whence the Proportions of the Sines being derived, they come out equal, so far as by viewing the Spectrums and using some Mathematical reasoning I could Estimate. For I did not make an Accurate Computation. So then the Proposition holds true in every Ray apart, so far as appears by Experiment. And that it is accurately true may be demonstrated upon this Supposition, *That Bodies refract Light by acting upon its Rays in Lines Perpendicular to their Surfaces.* But in order to this Demonstration, I must distinguish the Motion of every Ray into two Motions, the one Perpendicular to the refracting Surface, the other Parallel to it, and concerning the Perpendicular Motion lay down the following Proposition.

If any Motion or moving thing whatsoever be incident with any velocity on any broad and thin Space terminated on both sides by two Parallel Planes, and in its passage through that space be urged perpendicularly towards the further Plane by any force which at given distances from the Plane is of given quantities ; the perpendicular Velocity of that Motion or Thing, at its emerging out of that space, shall be always equal to the Square Root of the Summ of the Square of the perpendicular Velocity of that Motion or Thing at its Incidence on that space ; and of the Square of the perpendicular Velocity which that Motion or Thing would have at its Emergence, if at its Incidence its perpendicular Velocity was infinitely little.

And the same Proposition holds true of any Motion or Thing perpendicularly retarded in its passage through that space, if instead of the Summ of the two Squares you take their difference. The Demonstration Mathematicians will easily find out, and therefore I shall not trouble the Reader with it.

Suppose now that a Ray coming most obliquely in the Line MC be refracted at C by the Plane RS into the Line CN, and if it be required to find the Line CE into which any other Ray AC shall be refracted ; let MC, AD, be the Sines of incidence of the two Rays, and NG, EF, their Sines of Refraction, and let the equal Motions of the Incident Rays be represented by the equal Lines M C and AC, and the Motion MC being considered as parallel to the refracting Plane, let the other Motion AC be distinguished into two Motions AD and DC, one of which AD is parallel, and the other DC perpendicular to the refracting Surface. In like manner, let the Motions of the emerging Rays be distinguish'd into two, whereof the perpendicular

H

Fig. 1.

perpendicular ones are $\frac{MC}{NG}$ CG and $\frac{AD}{EF}$ CF. And if the force of the refracting Plane begins to act upon the Rays either in that Plane or at a certain distance from it on the one side, and ends at a certain distance from it on the other side, and in all places between those two Limits acts upon the Rays in Lines perpendicular to that refracting Plane, and the Actions upon the Rays at equal distances from the refracting Plane be equal, and at unequal ones either equal or unequal according to any rate whatever; that motion of the Ray which is Parallel to the refracting Plane will suffer no alteration by that force; and that motion which is perpendicular to it will be altered according to the rule of the foregoing Proposition. If therefore for the perpendicular Velocity of the emerging Ray CN you write $\frac{MC}{NG}$ CG as above, then the perpendicular Velocity of any other emerging Ray CE which was $\frac{AD}{EF}$ CF, will be equal to the square Root of $CDq + \frac{MCq}{NGq}$ CGq. And by squaring these equals, and adding to them the Equals ADq and MCq --- CDq, and dividing the Summs by the Equals CFq + EFq and CGq + NGq, you will have $\frac{ADq}{EFq}$ equal to $\frac{MCq}{NGq}$. Whence AD, the Sine of Incidence, is to EF the Sine of Refraction, as MC to NG, that is, in a given *ratio*. And this Demonstration being general, without determining what Light is, or by what kind of force it is refracted, or assuming any thing further than that the refracting Body acts upon the Rays in Lines perpendicular to its Surface; I take it to be a very convincing Argument of the full Truth of this Proposition.

So then, if the *ratio* of the Sines of Incidence and Refraction of any sort of Rays be found in any one Case, 'tis given in all Cases; and this may be readily found by the Method in the following Proposition.

P R O P. VII. Theor. VI.

The Perfection of Telescopes is impeded by the different Refrangibility of the Rays of Light.

THE imperfection of Telescopes is vulgarly attributed to the spherical Figures of the Glasses, and therefore Mathematicians have propounded to Figure them by the Conical Sections. To shew that they are mistaken, I have inserted this Proposition; the truth of which will appear by the measures of the Refractions of the several sorts of Rays; and these measures I thus determine.

In the third experiment of the first Book, where the refracting Angle of the Prism was $62\frac{1}{2}$ degrees, the half of that Angle 31 deg. 15 min. is the Angle of Incidence of the Rays at their going out of the Glass into the Air; and the Sine of this Angle is 5188 , the Radius being 10000 . When the Axis of this Prism was parallel to the Horizon, and the Refraction of the Rays at their Incidence on this Prism equal to that at their Emergence out of it, I observed with a Quadrant the Angle which the mean refrangible Rays (that is, those which went to the middle of the Sun's coloured Image) made with the Horizon and by this Angle and the Sun's altitude observed at the same time, I found the Angle which the emergent Rays contained with the incident to be 44 deg. and 40 min. and the half of this Angle added to the Angle of Incidence 31 deg. 15 min. makes the

H 2 Angle

Angle of Refraction, which is therefore 53 deg. 35 min. and its Sine 8047. These are the Sines of Incidence and Refraction of the mean refrangible Rays, and their proportion in round numbers is 20 to 31. This Glass was of a colour inclining to green. The last of the Prisms mentioned in the third Experiment was of clear white Glass. Its refracting Angle $63\frac{1}{2}$ degrees. The Angle which the emergent Rays contained, with the incident 45 deg. 50 min. The Sine of half the first Angle 5262. The Sine of half the Summ of the Angles 8157. And their proportion in round numbers 20 to 31 as before.

From the Length of the Image, which was about $9\frac{3}{4}$ or 10 Inches, subduct its Breadth, which was $2\frac{1}{8}$ Inches, and the Remainder $7\frac{3}{4}$ Inches would be the length of the Image were the Sun but a point, and therefore subtends the Angle which the most and least refrangible Rays, when incident on the Prism in the same Lines, do contain with one another after their Emergence. Whence this Angle is 2 deg. 0. 7." For the distance between the Image and the Prism where this Angle is made, was $18\frac{1}{2}$ Feet, and at that distance the Chord $7\frac{3}{4}$ Inches subtends an Angle of 2 deg. 0. 7." Now half this Angle is the Angle which these emergent Rays contain with the emergent mean refrangible Rays, and a quarter thereof, that is 30. 2." may be accounted the Angle which they would contain which the same emergent mean refrangible Rays, were they co-incident to them within the Glass and suffered no other Refraction then that at their Emergence. For if two equal Refractions, the one at the incidence of the Rays on the Prism, the other at their Emergence, make half the Angle 2 deg. 0. 7." then one of those Refractions will make about a quarter of that Angle, and this quarter added to
and.

and subducted from the Angle of Refraction of the mean refrangible Rays, which was 53 deg. 35', gives the Angles of Refraction of the most and least refrangible Rays 54 deg. 5' 2", and 53 deg. 4' 58", whose Sines are 8099 and 7995, the common Angle of Incidence being 31 deg. 15' and its Sine 5188; and these Sines in the least round numbers are in proportion to one another as 78 and 77 to 50.

Now if you subduct the common Sine of Incidence 50 from the Sines of Refraction 77 and 78, the remainders 27 and 28 shew that in small Refractions the Refraction of the least refrangible Rays is to the Refraction of the most refrangible ones as 27 to 28 very nearly, and that the difference of the Refractions of the least refrangible and most refrangible Rays is about the $27\frac{1}{2}$ th part of the whole Refraction of the mean refrangible Rays.

Whence they that are skilled in Opticks will easily understand, that the breadth of the least circular space into which Object-Glasses of Telescopes can collect all sorts of Parallel Rays, is about the $27\frac{1}{2}$ th part of half the aperture of the Glass, or 55th part of the whole aperture; and that the Focus of the most refrangible Rays is nearer to the Object-Glass than the Focus of the least refrangible ones, by about the $27\frac{1}{2}$ th part of the distance between the Object-Glass and the Focus of the mean refrangible ones.

And if Rays of all sorts, flowing from any one lucid point in the Axis of any convex Lens, be made by the Refraction of the Lens to converge to points not too remote from the Lens, the Focus of the most refrangible Rays shall be nearer to the Lens than the Focus of the least refrangible ones, by a distance which is to the $27\frac{1}{2}$ th part of the distance of the Focus of the mean refrangible Rays from the Lens as the distance between that Focus and the lucid point

point from whence the Rays flow is to the distance between that lucid point and the Lens very nearly.

Now to examine whether the difference between the Refractions which the most refrangible and the least refrangible Rays flowing from the same point suffer in the Object-Glasses of Telescopes and such like Glasses, be so great as is here described, I contrived the following Experiment.

Exper. 16. The Lens which I used in the second and eighth Experiments, being placed six Feet and an Inch distant from any Object, collected the Species of that Object by the mean refrangible Rays at the distance of six Feet and an Inch from the Lens on the other side. And therefore by the foregoing Rule it ought to collect the Species of that Object by the least refrangible Rays at the distance of six Feet and $3\frac{2}{3}$ Inches from the Lens, and by the most refrangible ones at the distance of five Feet and $10\frac{2}{3}$ Inches from it: So that between the two Places where these least and most refrangible Rays collect the Species, there may be the distance of about $5\frac{1}{3}$ Inches. For by that Rule, as six Feet and an Inch (the distance of the Lens from the lucid Object) is to twelve Feet and two Inches (the distance of the lucid Object from the Focus of the mean refrangible Rays) that is, as one is to two, so is the $27\frac{1}{2}$ th part of six Feet and an Inch (the distance between the Lens and the same Focus) to the distance between the Focus of the most refrangible Rays and the Focus of the least refrangible ones, which is therefore $5\frac{17}{55}$ Inches, that is very nearly $5\frac{1}{3}$ Inches. Now to know whether this measure was true, I repeated the second and eighth Experiment of this Book with coloured Light, which was less compounded than that I there made use of: For I now separated the hetero-

heterogeneous Rays from one another by the Method I described in the 11th Experiment, so as to make a coloured Spectrum about twelve or fifteen times longer than broad. This Spectrum I cast on a printed book, and placing the above-mentioned Lens at the distance of six Feet and an Inch from this Spectrum to collect the Species of the illuminated Letters at the same distance on the other side, I found that the Species of the Letters illuminated with Blue were nearer to the Lens than those illuminated with deep Red by about three Inches or three and a quarter: but the Species of the Letters illuminated with Indigo and Violet appeared so confused and indistinct, that I could not read them: Whereupon viewing the Prism, I found it was full of Veins running from one end of the Glass to the other; so that the Refraction could not be regular. I took another Prism therefore which was free from Veins, and instead of the Letters I used two or three Parallel black Lines a little broader than the strokes of the Letters, and casting the Colours upon these Lines in such manner that the Lines ran along the Colours from one end of the Spectrum to the other, I found that the Focus where the Indigo, or confine of this colour and Violet cast the Species of the black Lines most distinctly, to be about 4 Inches or 4 $\frac{1}{2}$ nearer to the Lens than the Focus where the deepest Red cast the Species of the same black Lines most distinctly. The violet was so faint and dark, that I could not discern the Species of the Lines distinctly by that Colour; and therefore considering that the Prism was made of a dark coloured Glass inclining to Green, I took another Prism of clear white Glass; but the Spectrum of Colours which this Prism made had long white Streams of faint Light shooting out from both ends of the Colours, which made me conclude that something was amiss; and view-
ing

ing the Prism, I found two or three little Bubbles in the Glas which refracted the Light irregularly. Wherefore I covered that part of the Glas with black Paper, and letting the Light pass through another part of it which was free from such Bubbles, the Spectrum of Colours became free from those irregular Streams of Light, and was now such as I desired. But still I found the Violet so dark and faint, that I could scarce see the Species of the Lines by the Violet, and not at all by the deepest part of it, which was next the end of the Spectrum. I suspected therefore that this faint and dark Colour might be allayed by that scattering Light which was refracted, and reflected irregularly partly by some very small Bubbles in the Glasses and partly by the inequalities of their Polish: which Light, tho' it was but little, yet it being of a White Colour, might suffice to affect the Sense so strongly as to disturb the Phænomena of that weak and dark Colour the Violet, and therefore I tried, as in the 12th, 13th, 14th Experiments, whether the Light of this Colour did not consist of a sensible mixture of heterogeneous Rays, but found it did not. Nor did the Refractions cause any other sensible Colour than Violet to emerge out of this Light, as they would have done out of White Light, and by consequence out of this Violet Light had it been sensibly compounded with White Light. And therefore I concluded, that the reason why I could not see the Species of the Lines distinctly by this Colour, was only the darkness of this Colour and Thinness of its Light, and its distance from the Axis of the Lens; I divided therefore those Parallel Black Lines into equal Parts, by which I might readily know the distances of the Colours in the Spectrum from one another, and noted the distances of the Lens from the Foci of such Colours as cast the Species of the
 Lines

Lines distinctly, and then considered whether the difference of those distances bear such proportion to $5\frac{1}{3}$ Inches, the greatest difference of the distances which the Foci of the deepest Red and Violet ought to have from the Lens, as the distance of the observed Colours from one another in the Spectrum bear to the like distance of the deepest Red and Violet measured in the rectilinear sides of the Spectrum, that is, to the length of those sides or excess of the length of the Spectrum above its breadth. And my Observations were as follows.

When I observed and compared the deepest sensible Red, and the Colour in the confine of Green and Blue, which at that rectilinear sides of the Spectrum was distant from it half the length of those sides, the Focus where the confine of Green and Blue cast the Species of the Lines distinctly on the Paper, was nearer to the Lens than the Focus where the Red cast those Lines distinctly on it by about $2\frac{1}{2}$ or $2\frac{3}{4}$ Inches. For sometimes the Measures were a little greater, sometimes a little less, but seldom varied from one another above $\frac{1}{3}$ of an Inch. For it was very difficult to define the Places of the Foci, without some little Errors. Now if the Colours distant half the length of the Image, (measured at its rectilinear sides) give $2\frac{1}{2}$ or $2\frac{3}{4}$ difference of the distances of their Foci from the Lens, then the Colours distant the whole length ought to give 5 or $5\frac{1}{2}$ Inches difference of those distances.

But here it's to be noted, that I could not see the Red to the full End of the Spectrum, but only to the Center of the Semicircle which bounded that End, or a little farther; and therefore I compared this Red not with that Colour which was exactly in the middle of the Spectrum, or confine of Green and Blue, but with that which verged a little more to the Blue than to the Green : And as I reckoned

oned the whole length of the Colours not to be the whole length of the Spectrum, but the length of its rectilinear sides; so completing the Semicircular Ends into Circles, when either of the observed Colours fell within those Circles, I measured the distance of that Colour from the End of the Spectrum, and subducting half the distance from the measured distance of the Colours, I took the remainder for their corrected distance; and in these Observations set down this corrected distance for the difference of their distances from the Lens. For as the length of the rectilinear sides of the Spectrum would be the whole length of all the Colours, were the Circles of which (as we shewed) that Spectrum consists contracted and reduced to Physical Points, so in that Case this corrected distance would be the real distance of the observed Colours.

When therefore I further observed the deepest sensible Red, and that Blue whose corrected distance from it was $\frac{7}{12}$ parts of the length of the rectilinear sides of the Spectrum, the difference of the distances of their Foci from the Lens was about $3\frac{1}{4}$ Inches, and as 7 to 12 so is $3\frac{1}{4}$ to $5\frac{4}{7}$.

When I observed the deepest sensible Red, and that Indigo whose corrected distance was $\frac{8}{12}$ or $\frac{2}{3}$ of the length of the rectilinear sides of the Spectrum, the difference of the distances of their Foci from the Lens, was about $3\frac{2}{3}$ Inches, and as 2 to 3 so is $3\frac{2}{3}$ to $5\frac{1}{2}$.

When I observed the deepest sensible Red, and that deep Indigo whose corrected distance from one another was $\frac{9}{12}$ or $\frac{3}{4}$ of the length of the rectilinear sides of the Spectrum, the difference of the distances of their Foci from the Lens was about 4 Inches; and as 3 to 4 so is 4 to $5\frac{1}{3}$.

When I observed the deepest sensible Red, and that part of the Violet next the Indigo whose corrected distance from the Red was $\frac{10}{12}$ or $\frac{5}{6}$ of the length of the rectilinear sides of the

the.

the Spectrum, the difference of the distances of their Foci from the Lens was about $4\frac{1}{2}$ Inches; and as 5 to 6, so is $4\frac{1}{2}$ to $5\frac{2}{5}$. For sometimes when the Lens was advantageously placed, so that its Axis respected the Blue, and all things else were well ordered, and the Sun shone clear, and I held my Eye very near to the Paper on which the Lens cast the Species of the Lines, I could see pretty distinctly the Species of those Lines by that part of the Violet which was next the Indigo; and sometimes I could see them by above half the Violet. For in making these Experiments I had observed, that the Species of those Colours only appeared distinct which were in or near the Axis of the Lens: So that if the Blue or Indigo were in the Axis, I could see their Species distinctly; and then the Red appeared much less distinct than before. Wherefore I contrived to make the Spectrum of Colours shorter than before, so that both its Ends might be nearer to the Axis of the Lens. And now its length was about $2\frac{1}{2}$ Inches and breadth about $\frac{1}{5}$ or $\frac{1}{6}$ of an Inch. Also instead of the black Lines on which the Spectrum was cast, I made one black Line broader than those, that I might see its Species more easily; and this Line I divided by short cross Lines into equal Parts, for measuring the distances of the observed Colours. And now I could sometimes see the Species of this Line with its divisions almost as far as the Centers of the Semicircular Violet End of the Spectrum, and made these further Observations.

When I observed the deepest sensible Red, and that part of the Violet whose corrected distance from it was about $\frac{8}{9}$ Parts of the rectilinear sides of the Spectrum the difference of the distances of the Foci of those Colours from the Lens, was one time $4\frac{2}{3}$, another time $4\frac{3}{4}$, another time $4\frac{7}{8}$, Inches, and as 8 to 9, so are $4\frac{2}{3}$, $4\frac{3}{4}$, $4\frac{7}{8}$, to $5\frac{1}{4}$, $5\frac{11}{32}$, $5\frac{31}{64}$ respectively.

When I observed the deepest sensible Red, and deepest sensible Violet, (the corrected distance of which Colours when all things were ordered to the best advantage, and the Sun shone very clear, was about $\frac{11}{12}$ or $\frac{15}{16}$ parts of the length of the rectilinear sides of the coloured Spectrum,) I found the difference of the distances of their Foci from the Lens sometimes $4\frac{3}{4}$ sometimes $5\frac{1}{4}$, and for the most part 5 Inches or thereabouts: and as 11 to 12 or 15 to 26, so is five Inches to $5\frac{1}{2}$ or $5\frac{2}{3}$ Inches.

And by this progression of Experiments I satisfied myself, that had the light at the very Ends of the Spectrum been strong enough to make the Species of the black Lines appear plainly on the Paper, the Focus of the deepest Violet would have been found nearer to the Lens, than the Focus of the deepest Red, by about $5\frac{1}{3}$ Inches at least. And this is a further Evidence, that the Sines of Incidence and Refraction of the several sorts of Rays, hold the same proportion to one another in the smallest Refractions which they do in the greatest.

My progress in making this nice and troublesome Experiment I have set down more at large, that they that shall try it after me may be aware of the Circumspection requisite to make it succeed well. And if they cannot make it succeed so well as I did, they may notwithstanding collect by the Proportion of the distance of the Colours in the Spectrum, to the difference of the distances of their Foci from the Lens, what would be the success in the more distant Colours by a better Trial. And yet if they use a broader Lens than I did, and fix it to a long straight Staff by means of which it may be readily and truly directed to the Colour whose Focus is desired, I question not but the Experiment will succeed better with them than it did with me. For I directed the Axis as nearly as I could to the middle.

middle of the Colours, and then the faint Ends of the Spectrum being remote from the Axis, cast their Species less distinctly on the Paper than they would have done had the Axis been successively directed to them.

Now by what has been said its certain, that the Rays which differ in refrangibility do not converge to the same Focus, but if they flow from a lucid point, as far from the Lens on one side as their Foci are one the other, the Focus of the most refrangible Rays shall be nearer to the Lens than that of the least refrangible, by above the fourteenth part of the whole distance: and if they flow from a lucid point, so very remote from the Lens that before their Incidence they may be accounted Parallel, the Focus of the most refrangible Rays shall be nearer to the Lens than the Focus of the least refrangible, by about the 27th or 28th part of their whole distance from it. And the Diameter of the Circle in the middle space between those two Foci which they illuminate when they fall there on any Plane, perpendicular to the Axis (which Circle is the least into which they can all be gathered) is about the 55th part of the Diameter of the aperture of the Glass. So that 'tis a wonder that Telescopes represent Objects so distinct as they do. But were all the Rays of Light equally refrangible, the Error arising only from the sphericalness of the Figures of Glasses would be many hundred times less. For if the Object-Glass of a Telescope be Plano-convex, and the Plane side be turned towards the Object, and the Diameter of the Sphere whereof this Glass is a segment, be called D , and the Semidiameter of the aperture of the Glass be called S , and the Sine of Incidence out of Glass into Air, be to the Sine of Refraction as I to R : the Rays which come Parallel to the Axis of the Glass, shall in the Place where the Image of the Object is most distinctly made, be scattered all over a little Circle.

Circle whose Diameter is $\frac{R}{I} \times \frac{S \text{ cub.}}{D \text{ quad.}}$ very nearly, as I gather by computing the Errors of the Rays by the method of infinite Series, and rejecting the Terms whose quantities are inconsiderable. As for instance, if the Sine of Incidence I, be to the Sine of Refraction R, as 20 to 31, and if D the Diameter of the Sphere to which the Convex side of the Glass is ground, be 100 Feet or 1200 Inches, and S the Semidiameter of the aperture be two Inches, the Diameter of the little Circle (that is $\frac{R \times S \text{ cub.}}{I \times D \text{ quad.}}$) will be $\frac{31 \times 8}{20 \times 1200 \times 1200}$ (or $\frac{31}{3600000}$) parts of an Inch. But the Diameter of the little Circle through which these Rays are scattered by unequal refrangibility, will be about the 55th part of the aperture of the Object-Glass which here is four Inches. And therefore the Error arising from the spherical Figure of the Glass, is to the Error arising from the different Refrangibility of the Rays, as $\frac{31}{3600000}$ to $\frac{4}{55}$ that is as 1 to 8151 : and therefore being in Comparison so very little, deserves not to be considered.

But you will say, if the Errors caused by the different refrangibility be so very great, how comes it to pass that Objects appear through Telescopes so distinct as they do? I answer, 'tis because the erring Rays are not scattered uniformly over all that circular space, but collected infinitely more densly in the Center than in any other part of the Circle, and in the way from the Center to the Circumference grow continually rarer and rarer, so as at the Circumference to become infinitely rare; and by reason of their rarity are not strong enough to be visible, unless in the Center and very near it. Let ADE represent one of those Circles described with the Center C and Semidiameter AC, and let BFG be a smaller Circle concentric to the former, cutting

Fig. 27.

with

with its Circumference the Diameter AC in B, and besect AC in N, and by my reckoning the density of the Light in any place B will be to its density in N, as AB to BC; and the whole Light within the lesser Circle BFG, will be to the whole Light within the greater AED, as the Excess of the Square of AC above the Square of AB, is to the Square of AC. As if BC be the fifth part of AC, the Light will be four times denser in B than in N, and the whole Light within the less Circle, will be to the whole Light within the greater, as nine to twenty five. Whence it's evident that the Light within the less Circle, must strike the sense much more strongly, than that faint and dilated light round about between it and the Circumference of the greater.

But its further to be noted, that the most luminous of the prismatick Colours are the Yellow and Orange. These affect the Senses more strongly than all the rest together, and next to these in strength are the Red and Green. The Blue compared with these is a faint and dark Colour, and the Indigo and Violet are much darker and fainter, so that these compared with the stronger Colours are little to be regarded. The Images of Objects are therefore to be placed, not in the Focus of the mean refrangible Rays which are in the confine of Green and Blue, but in the Focus of those Rays which are in the middle of the Orange and Yellow; there where the Colour is most luminous and fulgent, that is in the brightest Yellow, that Yellow which inclines more to Orange than to Green. And by the Refraction of these Rays (whose Sines of Incidence and Refraction in Glass are as 17 and 11) the Refraction of Glass and Crystal for optical uses is to be measured. Let us therefore place the Image of the Object in the Focus of these Rays, and all the Yellow and Orange will fall within a Circle, whose Diameter is about the 25th part of the Diameter of the aperture

ture

ture of the Glas. And if you add the brighter half of the Red, (that half which is next the Orange, and the brighter half of the Green, (that half which is next the Yellow,) about three fifth parts of the Light of these two Colours will fall within the same Circle, and two fifth parts will fall without it round about ; and that which falls without will be spread through almost as much more space as that which falls within, and so in the gross be almost three times rarer. Of the other half of the Red and Green, (that is of the deep dark Red and Willow Green) about one quarter will fall within this Circle, and three quarters without, and that which falls without will be spread through about four or five times more space than that which fall within ; and so in the gross be rarer, and if compared with the whole Light within it, will be about 25 times rarer than all that taken in the gross ; or rather more than 30 or 40 times rarer, because the deep red in the end of the Spectrum of Colours made by a Prism is very thin and rare, and the Willow Green is something rarer than the Orange and Yellow. The Light of these Colours therefore bring so very much rarer than that within the Circle, will scarce affect the Sense especially since the deep Red and Willow Green of this Light, are much darker Colours then the rest. And for the same reason the Blue and Violet being much darker Colours than these, and much more rarified, may be neglected. For the dense and bright Light of the Circle, will obscure the rare and weak Light of these dark Colours round about it, and render them almost insensible. The sensible Image of a lucid point is therefore scarce broader than a Circle whose Diameter is the 250th part of the diameter of the aperture of the Object Glas of a good Telescope, or not much broader, if you except a faint and dark misty light round about it, which a Spectator will scarce regard. And therefore in a Telescope whose
whose

whose aperture is four Inches, and length an hundred Feet; it exceeds not 2" 45", or 3". And in a Telescope whose aperture is two Inches, and length 20 or 30 Feet, it may be 5" or 6" and scarce above. And this Answers well to Experience: For some Astronomers have found the Diameters of the fixt Stars, in Telescopes of between twenty and sixty Feet in length, to be about 4" or 5" or at most 6" in Diameter. But if the Eye-Glass be tinted faintly with the smoke of a Lamp or Torch, to obscure the Light of the Star, the fainter Light in the circumference of the Star ceases to be visible, and the Star (if the Glass be sufficiently soiled with smoke) appears something more like a Mathematical Point. And for the same reason, the enormous part of the Light in the Circumference of every lucid Point ought to be less discernable in shorter Telescopes than in longer, because the shorter transmit less Light to the Eye.

Now if we suppose the sensible Image of a lucid point, to be even 250 times narrower than the aperture of the Glass: yet were it not for the different refrangibility of the Rays, its breadth in an 100 Foot Telescope whose aperture is 4 Inches would be but $\frac{31}{3600000}$ parts of an Inch, as is manifest by the foregoing Computation. And therefore in this Case the greatest Errors arising from the spherical Figure of the Glass, would be to the greatest sensible Errors arising from the different refrangibility of the Rays as $\frac{31}{3600000}$ to $\frac{4}{250}$ at most, that is only as 1 to 1826. And this sufficiently shews that it is not the spherical Figures of Glasses but the different refrangibility of the Rays which hinders the perfection of Telescopes.

There is another Argument by which it may appear that the different refrangibility of Rays, is the true Cause of the imperfection of Telescopes. For the Errors of the Rays arising from the spherical Figures of Object-Glasses, are as

the Cubes of the apertures of the Object-Glasses; and thence to make Telescopes of various lengths, magnify with equal distinctness, the apertures of the Object-Glasses, and the Charges or magnifying Powers, ought to be as the Cubes of the square Roots of their lengths; which doth not answer to Experience. But the errors of the Rays arising from the different refrangibility, are as the apertures of the Object-Glasses, and thence to make Telescopes of various lengths, magnify with equal distinctness, their apertures and charges ought to be as the square Roots of their lengths; and this answers to experience as is well known. For instance, a Telescope of 64 Feet in length, with an aperture of $2\frac{2}{3}$ Inches, magnifies about 120 times, with as much distinctness as one of a Foot in length, with $\frac{1}{3}$ of an Inch aperture, magnifies 15 times.

Now were it not for this different refrangibility of Rays, Telescopes might be brought to a greater Perfection than we have yet described, by composing the Object-Glass of two Glasses with Water between them. Let *ADFC* represent the Object-Glass composed of two Glasses *ABED* and *BEFC*, alike convex on the outsides *AGD* and *CHF*, and alike concave on the insides *BME*, *BNE*, with Water in the concavity *BMEN*. Let the Sine of Incidence out of Glass into Air be as *I* to *R* and out of Water into Air as *K* to *R*, and by consequence out of Glass into Water, as *I* to *K*: and let the Diameter of the Sphere to which the convex sides *AGD* and *CHF* are ground be *D*, and the Diameter of the Sphere to which the concave sides *BME* and *BNE* are ground be to *D*, as the Cube Root of *KK—KI* to the Cube Root of *RK—RI*: and the Refractions on the concave sides of the Glasses, will very much correct the Errors of the Refractions on the convex sides, so far as they arise from the sphericalness of the Figure. And by this means might

might Telescopes be brought to sufficient perfection, were it not for the different refrangibility of several sorts of Rays. But by reason of this different refrangibility, I do not yet see any other means of improving Telescopes by Refractions alone than that of increasing their lengths, for which end the late contrivance of *Hugenius* seems well accommodated. For very long Tubes are cumbersome, and scarce to be readily managed, and by reason of their length are very apt to bend, and shake by bending so as to cause a continual trembling in the Objects, whereby it becomes difficult to see them distinctly: whereas by his contrivance the Glasses are readily manageable, and the Object-Glass being fixt upon a strong upright Pole becomes more steady.

Seeing therefore the improvement of Telescopes of given lengths by Refractions is desperate; I contrived heretofore a Perspective by reflexion, using instead of an Object Glass a concave Metal. The diameter of the Sphere to which the Metal was ground concave was about 25 English Inches, and by consequence the length of the Instrument about six Inches and a quarter. The Eye-Glass was plano-convex, and the Diameter of the Sphere to which the convex side was ground was about $\frac{1}{3}$ of an Inch, or a little less, and by consequence it magnified between 30 and 40 times. By another way of measuring I found that it magnified about 35 times. The Concave Metal bore an aperture of an Inch and a third part; but the aperture was limited not by an opaque Circle, covering the Limb of the Metal round about, but by an opaque circle placed between the Eye-Glass and the Eye, and perforated in the middle with a little round hole for the Rays to pass through to the Eye. For this Circle by being placed here, stopp'd much of the erroneous Light, which otherwise would have disturbed the Vision. By comparing it with a pretty good Perspective of four Feet in

length, made with a concave Eye-Glass, I could read at a greater distance with my own Instrument than with the Glass. Yet Objects appeared much darker in it than in the Glass, and that partly because more Light was lost by reflexion in the Metal, then by refraction in the Glass, and partly because my Instrument was overcharged. Had it magnified but 30 or 25 times it would have made the Object appear more brisk and pleasant. Two of these I made about 16 Years ago, and have one of them still by me by which I can prove the truth of what I write. Yet it is not so good as at the first. For the concave has been divers times tarnished and cleared again, by rubbing it with very soft Leather. When I made these, an Artist in *London* undertook to imitate it; but using another way of polishing them than I did, he fell much short of what I had attained to, as I afterwards understood by discoursing the under-Workman he had employed. The Polish I used was on this manner. I had two round Copper Plates each six Inches in Diameter, the one convex the other concave, ground very true to one another. On the convex I ground the Object-Metal or concave which was to be polish'd, till it had taken the Figure of the convex and was ready for a Polish. Then I pitched over the convex very thinly, by dropping melted pitch upon it and warming it to keep the pitch soft, whilst I ground it with the concave Copper wetted to make it spread evenly all over the convex. Thus by working it well I made it as thin as a Groat, and after the convex was cold I ground it again to give it as true a Figure as I could. Then I took Putty which I had made very fine by washing it from all its grosser Particles, and laying a little of this upon the pitch, I ground it upon the Pitch with the concave Copper till it had done making a noise; and then upon the Pitch I ground the Object-Metal with a brisk

Motion

Motion, for about two or three Minutes of time, leaning hard upon it. Then I put fresh Putty upon the Pitch and ground it again till it had done making a noise, and afterwards ground the Object Metal upon it as before. And this Work I repeated till the Metal was polished, grinding it the last time with all my strength for a good while together, and frequently breathing upon the Pitch to keep it moist without laying on any more fresh Putty. The Object-Metal was two Inches broad and about one third part of an Inch thick, to keep it from bending. I had two of these Metals, and when I had polished them both I tried which was best, and ground the other again to see if I could make it better than that which I kept. And thus by many Trials I learnt the way of polishing, till I made those two reflecting Pesppectives I spake of above. For this Art of polishing will be better learnt by repeated Practice than by my description. Before I ground the Object Metal on the Pitch, I always ground the Putty on it with the concave Copper till it had done making a noise, because if the Particles of the Putty were not by this means made to stick fast in the Pitch, they would by rolling up and down grate and fret the Object Metal and fill it full of little holes.

But because Metal is more difficult to polish than Glass and is afterwards very apt to be spoiled by tarnishing, and reflects not so much Light as Glass quick-silvered over does: I would propound to use instead of the Metal, a Glass ground concave on the foreside, and as much convex on the backside, and quick-silvered over on the convex side. The Glass must be every where of the same thickness exactly. Otherwise it will make Objects look coloured and indistinct. By such a Glass I tried about five or six Years ago to make a reflecting Telescope of four Feet in length to magnify about 150 times, and I satisfied my self that there wants nothing

thing but a good Artift to bring the design to Perfection. For the Glas being wrought by one of our *London* Artifts after fuch a manner as they grind Glaffes for Telescopes, tho it feemed as well wrought as the Object Glaffes ufe to be, yet when it was quick-filvered, the reflexion difcovered innumerable Inequalities all over the Glas. And by reason of thefe Inequalities, Objects appeared indiftinét in this Inftument. For the Errors of reflected Rays caufed by any Inequality of the Glas, are about fix times greater than the Errors of refracted Rays caufed by the like Inequalities. Yet by this Experiment I fatisfied my felf that the reflexion on the concave fide of the Glas, which I feared would disturb the vifion, did no fenfible prejudice to it, and by confequence that nothing is wanting to perfect thefe Telescopes, but good Workmen who can grind and polifh Glaffes truly fpherical. An Object-Glas of a fourteen Foot Telescope, made by one of our *London* Artificers, I once mended confiderably, by grinding it on Pitch with Putty, and leaning very eafily on it in the grinding, left the Putty fhould scratch it. Whether this way may not do well enough for polifhing thefe reflecting Glaffes, I have not yet tried. But he that fhall try either this or any other way of polifhing which he may think better, may do well to make his Glaffes ready for polifhing by grinding them without that violence, wherewith our *London* Workmen prefs their Glaffes in grinding. For by fuch violent preffure, Glaffes are apt to bend a little in the grinding, and fuch bending will certainly fpoil their Figure. To recommend therefore the confideration of thefe reflecting Glaffes, to fuch Artifts as are curious in figuring Glaffes, I fhall describe this Optical Inftument in the following Propofition.

PROP. VII. Prob. II.

To shorten Telescopes.

LET ABDC represent a Glass spherically concave on the foreside AB, and as much convex on the backside CD, so that it be every where of an equal thickness. Let it not be thicker on one side than on the other, lest it make Objects appear coloured and indistinct, and let it be very truly wrought and quick-silvered over on the backside; and set in the Tube VXYZ which must be very black within. Let EFG represent a Prism of Glass or Crystal placed near the other end of the Tube, in the middle of it, by means of a handle of Brass or Iron FGK, to the end of which made flat it is cemented. Let this Prism be rectangular at E, and let the other two Angles at F and G be accurately equal to each other, and by consequence equal to half right ones, and let the plane sides FE and GE be square, and by consequence the third side FG a rectangular parallelogram, whose length is to its breadth in a subduplicate proportion of two to one. Let it be so placed in the Tube, that the Axis of the Speculum may pass through the middle of the square side EF perpendicularly, and by consequence through the middle of the side FG at an Angle of 45 degrees, and let the side EF be turned towards the Speculum, and the distance of this Prism from the Speculum be such that the Rays of the light PQ, RS, &c. which are incident upon the Speculum in Lines Parallel to the Axis thereof, may enter the Prism at the side EF, and be reflected by the side FG, and thence go out of it through the side GE, to the point T which must be the common Focus of the Speculum ABDC, and of a Plano-convex Eye-Glass H, through which those Rays must pass to the Eye. And let the Rays at their coming out

Fig. 29.

out of the Glass pass through a small round hole, or aperture made in a little Plate of Lead, Brass, or Silver, where-with the Glass is to be covered, which hole must be no bigger than is necessary for light enough to pass through. For so it will render the Object distinct, the Plate in which 'tis made intercepting all the erroneous part of the Light which comes from the Verges of the Speculum AB. Such an Instrument well made if it be 6 Foot long, (reckoning the length from the Speculum to the Prism, and thence to the Focus T) will bear an aperture of 6 Inches at the Speculum, and magnify between two and three hundred times. But the hole H here limits the aperture with more advantage, then if the aperture was placed at the Speculum. If the Instrument be made longer or shorter, the aperture must be in proportion as the Cube of the square Root of the length, and the magnifying as the aperture. But its convenient that the Speculum be an Inch or two broader than the aperture at the least, and that the Glass of the Speculum be thick, that it bend not in the working. The Prism EFG must be no bigger than is necessary, and its back side FG must not be quick-silvered over. For without quick-silver it will reflect all the Light incident on it from the Speculum.

In this Instrument the Object will be inverted, but may be erected by making the square sides EF and EG of the Prism EFG not plane but spherically convex, that the Rays may cross as well before they come at it as afterwards between it and the Eye-Glass. If it be desired that the Instrument bear a larger aperture, that may be also done by composing the Speculum of two Glasses with Water between them.



Fig. 1.

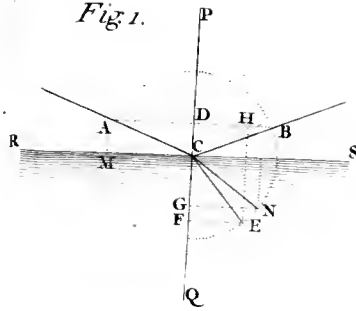

Fig. 2.

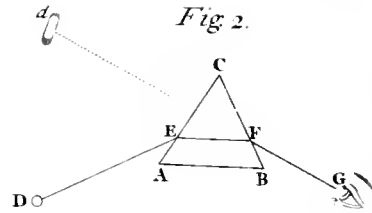

Fig. 3.

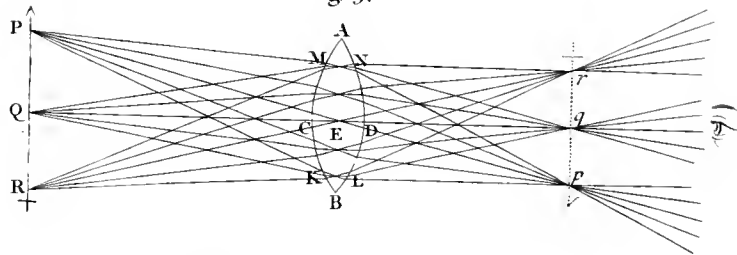

Fig. 4.

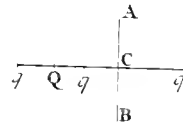

Fig. 5.

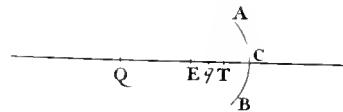

Fig. 6.

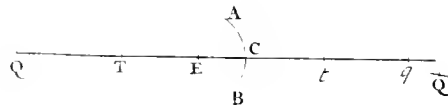
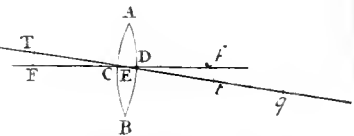
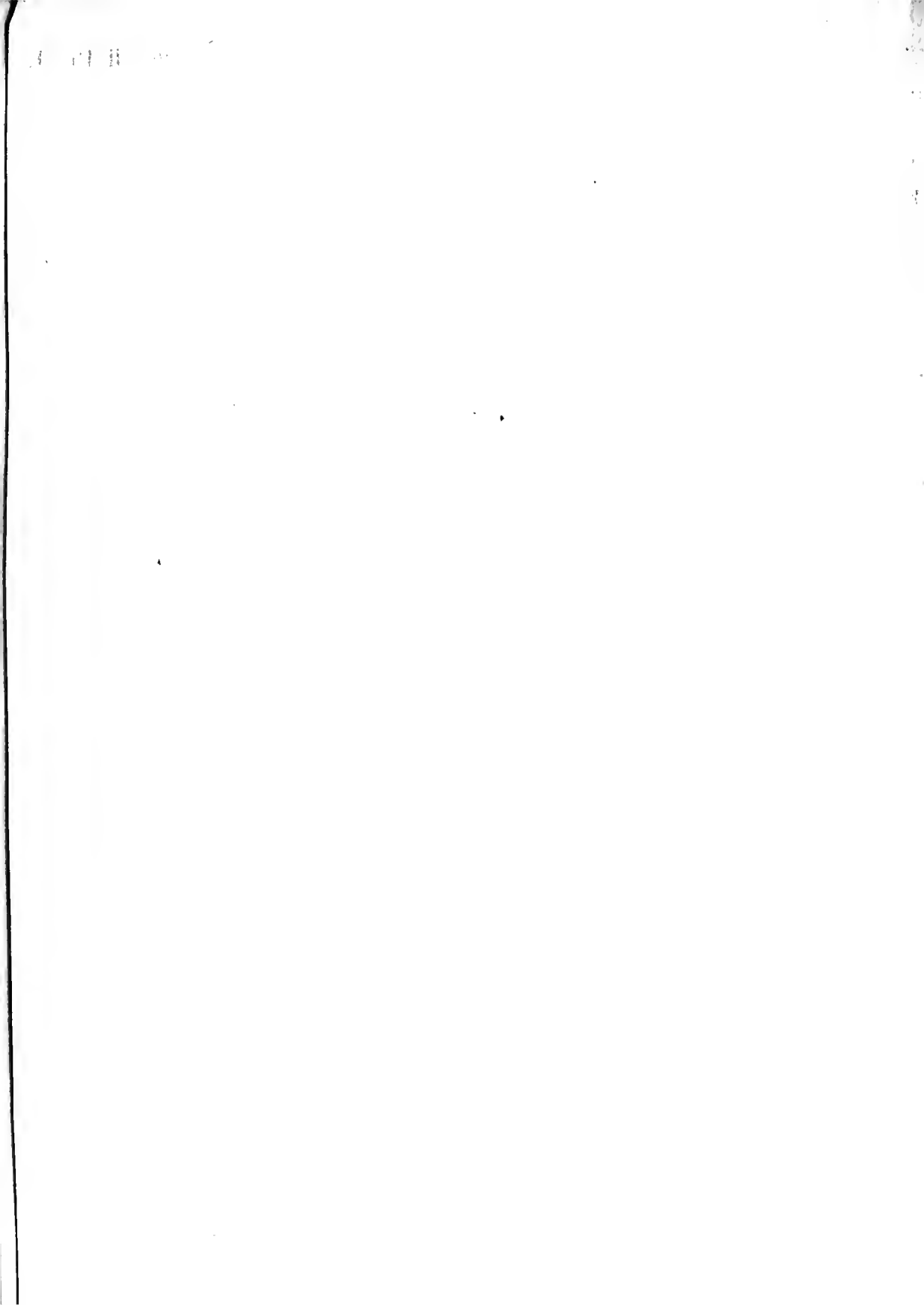

Fig. 7.





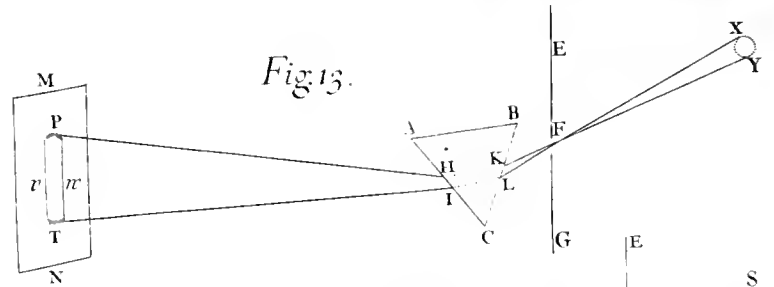

Fig. 13.

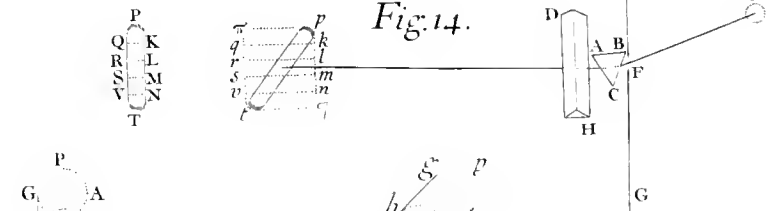

Fig. 14.

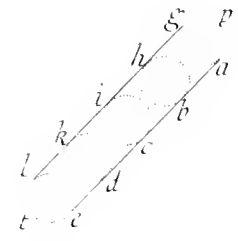
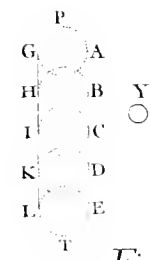

Fig. 15.

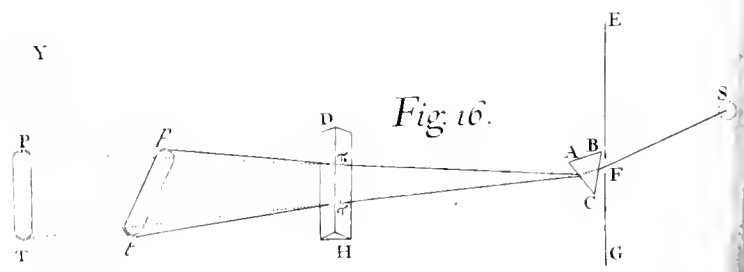

Fig. 16.



Fig. 17.

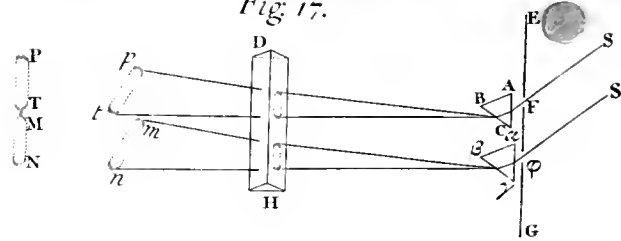

Fig. 18.

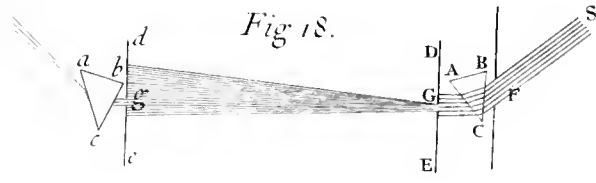

Fig. 19.

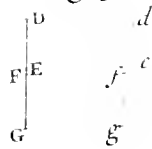

Fig. 20.

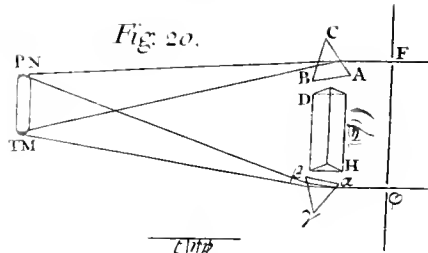

Fig. 21.

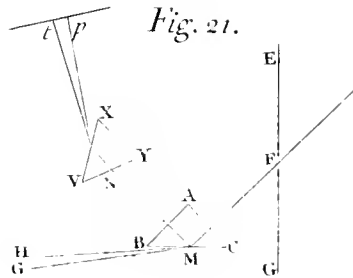
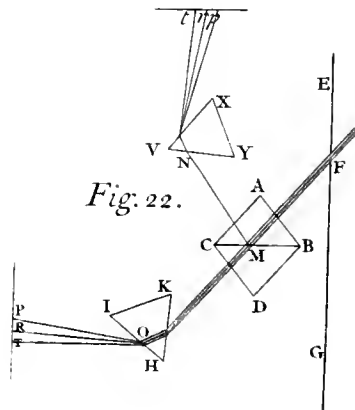
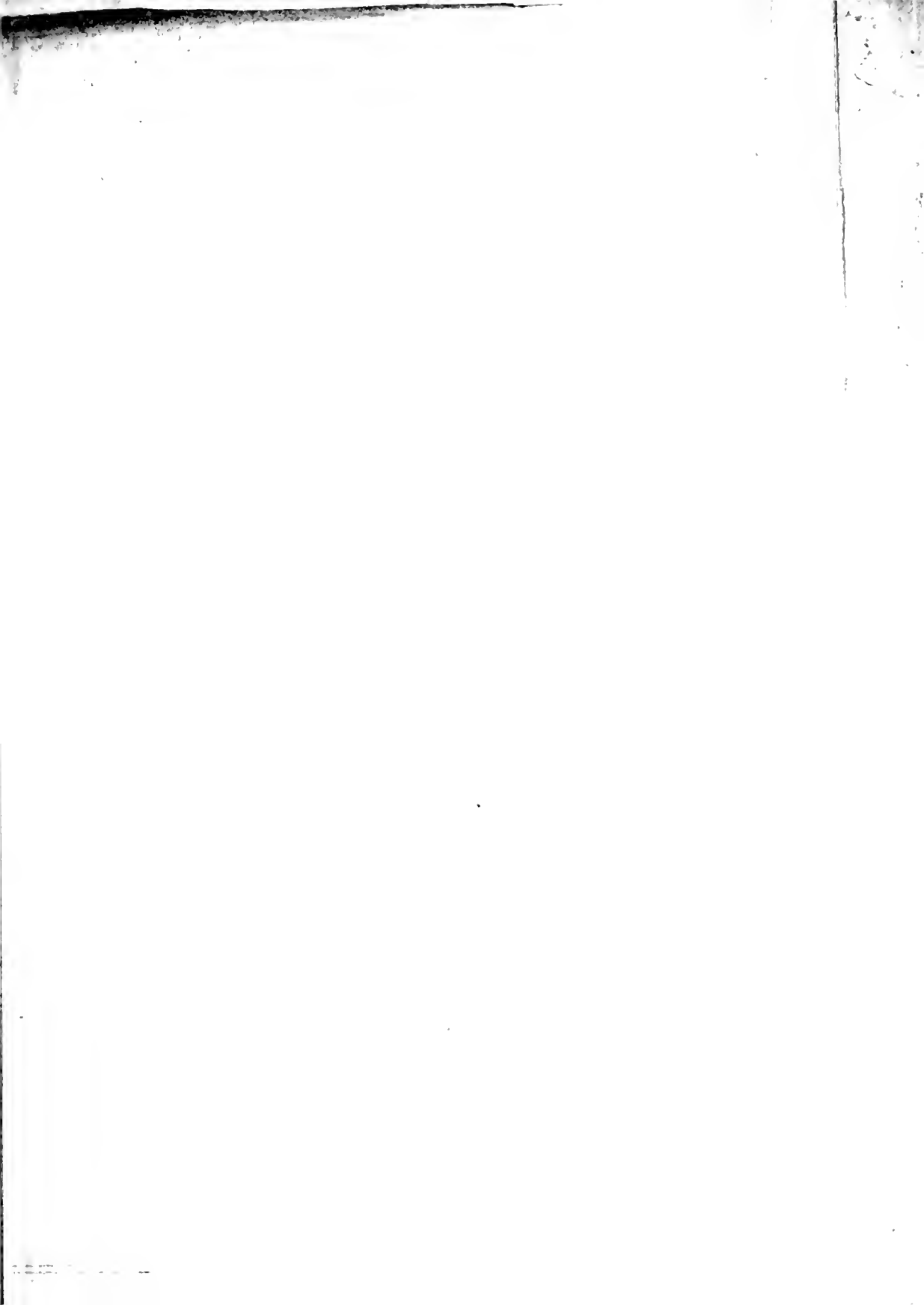

Fig. 22.





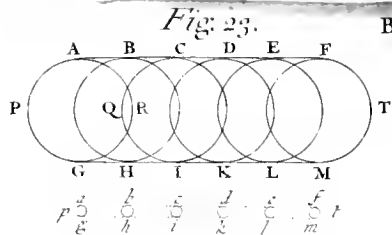

Fig. 24.

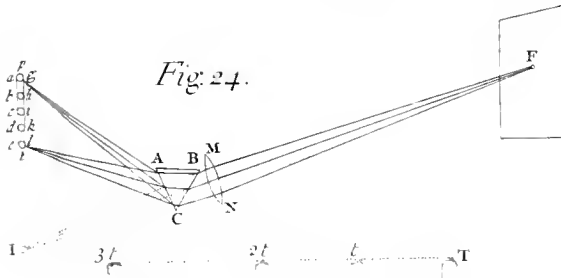

Fig. 25.

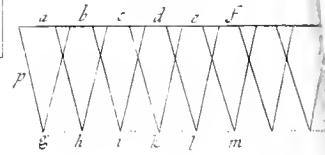

Fig. 26.



Fig. 27.

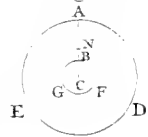
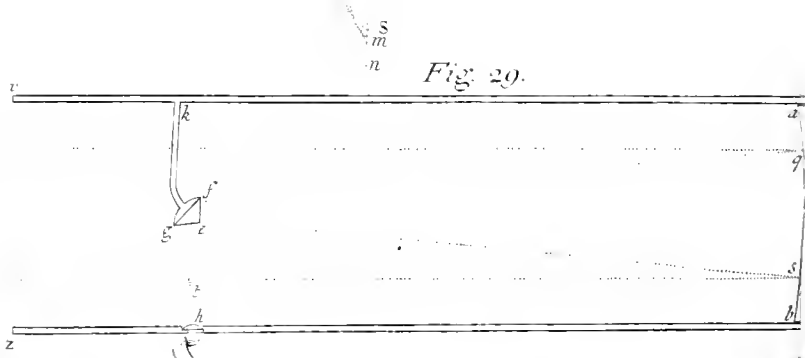

Fig. 28.



Fig. 29.



T H E

F I R S T B O O K

O F

O P T I C K S.

P A R T II.

P R O P. I. T H E O R. I.

The Phenomena of Colours in refracted or reflected Light are not caused by new modifications of the Light variously imprest, according to the various terminations of the Light and Shadow.

The Proof by Experiments.

E X P E R. I.

FOR if the Sun shine into a very dark Chamber *Fig. 1.* through an oblong Hole F, whose breadth is the sixth or eighth part of an Inch, or something less; and his Beam FH do afterwards pass first through a very large Prism ABC, distant about 20 Feet from the
L Hole,

Hole, and parallel to it, and then (with its white part) through an oblong Hole H, whose breadth is about the fortieth or sixtieth part of an Inch, and which is made in a black opake Body G I, and placed at the distance of two or three Feet from the Prism, in a parallel situation both to the Prism and to the former Hole, and if this white Light thus transmitted through the Hole H, fall afterwards upon a white Paper pt, placed after that Hole H, at the distance of three or four Feet from it, and there paint the usual Colours of the Prism, suppose red at t, yellow at s, green at r, blue at q, and violet at p; you may with an iron Wire, or any such like slender opake Body, whose breadth is about the tenth part of an Inch, by intercepting the rays at k, l, m, n or o, take away any one of the Colours at t, s, r, q or p, whilst the other Colours remain upon the Paper as before; or with an obstacle something bigger you may take away any two, or three, or four Colours together, the rest remaining: So that any one of the Colours as well as violet may become outmost in the confine of the shadow towards p, and any one of them as well as red may become outmost in the confine of the shadow towards t, and any one of them may also border upon the shadow made within the Colours by the obstacle R intercepting some intermediate part of the Light; and, lastly, any one of them by being left alone may border upon the shadow on either hand. All the Colours have themselves indifferently to any confines of shadow, and therefore the differences of these Colours from one another, do not arise from the different confines of shadow, whereby Light is variously modified as has hitherto been the Opinion of Philosophers.

phers. In trying these things 'tis to be observed, that by how much the Holes F and H are narrower, and the intervals between them, and the Prism greater, and the Chamber darker, by so much the better doth the Experiment succeed; provided the Light be not so far diminished, but that the Colours at pt be sufficiently visible. To procure a Prism of solid Glass large enough for this Experiment will be difficult, and therefore a prismatick Vessel must be made of polished Glass-plates cemented together, and filled with Water.

E X P E R. 11.

The Sun's Light let into a dark Chamber through *Fig. 2.* the round Hole F, half an Inch wide, passed first through the Prism ABC placed at the Hole, and then through a Lens PT something more than four Inches broad, and about eight Feet distant from the Prism, and thence converged to O the Focus of the Lens distant from it about three Feet, and there fell upon a white Paper DE. If that Paper was perpendicular to that Light incident upon it, as 'tis represented in the posture DE, all the Colours upon it at O appeared white. But if the Paper being turned about an Axis parallel to the Prism, became very much inclined to the Light as 'tis represented in the positions *de* and *de*; the same Light in the one case appeared yellow and red, in the other blue. Here one and the same part of the Light in one and the same place, according to the various inclinations of the Paper, appeared in one case white, in another yellow or red, in a third blue, whilst the confine of Light and
L 2 Shadow,

Shadow, and the refractions of the Prism in all these cases remained the same.

E X P E R. III.

Fig. 3. Such another Experiment may be more easily tried as follows. Let a broad beam of the Sun's Light coming into a dark Chamber through a Hole in the Window shut be refracted by a large Prism ABC, whose refracting Angle C is more than 60 degrees, and so soon as it comes out of the Prism let it fall upon the white Paper DE glewed upon a stiff plane, and this Light, when the Paper is perpendicular to it, as 'tis represented in DE, will appear perfectly white upon the Paper, but when the Paper is very much inclined to it in such a manner as to keep always parallel to the Axis of the Prism, the whiteness of the whole Light upon the Paper will according to the inclination of the Paper this way, or that way, change either into yellow and red, as in the posture *de*, or into blue and violet, as in the posture *d'e*. And if the Light before it fall upon the Paper be twice refracted the same way by two parallel Prisms, these Colours will become the more conspicuous. Here all the middle parts of the broad beam of white Light which fell upon the Paper, did without any confine of shadow to modify it, become coloured all over with one uniform Colour, the Colour being always the same in the middle of the Paper as at the edges, and this Colour changed according the various obliquity of the reflecting Paper, without any change in the refractions or shadow, or in the Light which fell upon the Paper. And therefore these Colours are
to.

to be derived from some other cause than the new modifications of Light by refractions and shadows.

If it be asked, What then is their cause? I answer, That the Paper in the posture *de*, being more oblique to the more refrangible rays than to the less refrangible ones, is more strongly illuminated by the latter than by the former, and therefore the less refrangible rays are predominant in the reflected Light. And wherever they are predominant in any Light they tinge it with red or yellow, as may in some measure appear by the first Proposition of the first Book, and will more fully appear hereafter. And the contrary happens in the posture of the Paper *e*, the more refrangible rays being then predominant which always tinge Light with blues and violets.

EXPER. IV.

The Colours of Bubbles with which Children play are various, and change their situation variously, without any respect to any confine of shadow. If such a Bubble be covered with a concave Glass, to keep it from being agitated by any wind or motion of the Air, the Colours will slowly and regularly change their situation, even whilst the Eye, and the Bubble, and all Bodies which emit any Light, or cast any shadow, remain unmoved. And therefore their Colours arise from some regular cause which depends not on any confine of shadow. What this cause is will be shewed in the next Book.

To

To these Experiments may be added the tenth Experiment of the first Book, where the Sun's Light in a dark Room being trajected through the parallel superficies of two Prisms tied together in the form of a Parallelepiped, became totally of one uniform yellow or red Colour, at its emerging out of the Prisms. Here, in the production of these Colours, the confine of shadow can have nothing to do. For the Light changes from white to yellow, orange and red successively, without any alteration of the confine of shadow: And at both edges of the emerging Light where the contrary confines of shadow ought to produce different effects, the Colour is one and the same, whether it be white, yellow, orange or red: And in the middle of the emerging Light, where there is no confine of shadow at all, the Colour is the very same as at the edges, the whole Light at its very first emergence being of one uniform Colour, whether white, yellow, orange or red, and going on thence perpetually without any change of Colour, such as the confine of shadow is vulgarly supposed to work in refracted Light after its emergence. Neither can these Colours arise from any new modifications of the Light by refractions, because they change successively from white to yellow, orange and red, while the refractions remain the same, and also because the refractions are made contrary ways by parallel superficies which destroy one anothers effects. They arise not therefore from any modifications of Light made by refractions and shadows, but have some other cause. What that cause is we shewed above in this tenth Experiment, and need not here repeat it.

There

There is yet another material circumstance of this Experiment. For this emerging Light being by a third Prism HIK refracted towards the Paper PT, and there painting the usual Colours of the Prism, red, yellow, green, blue, violet: If these Colours arose from the refractions of that Prism modifying the Light, they would not be in the Light before its incidence on that Prism. And yet in that Experiment we found that when by turning the two first Prisms about their common Axis all the Colours were made to vanish but the red; the Light which makes that red being left alone, appeared of the very same red Colour before its incidence on the third Prism. And in general we find by other Experiments that when the rays which differ in refrangibility are separated from one another, and any one sort of them is considered apart, the Colour of the Light which they compose cannot be changed by any refraction or reflexion whatever, as it ought to be were Colours nothing else than modifications of Light caused by refractions, and reflexions, and shadows. This unchangeableness of Colour I am now to describe in the following Proposition.

P R O P. II. T H E O R. II.

All homogeneal Light has its proper Colour answering to its degree of refrangibility, and that Colour cannot be changed by reflexions and refractions.

In the Experiments of the 4th Proposition of the first Book, when I had separated the heterogeneous rays from one another, the Spectrum pt formed by the separated

rated rays, did in the progress from its end p, on which the most refrangible rays fell, unto its other end t, on which the least refrangible rays fell, appear tinged with this Series of Colours, violet, indico, blue, green, yellow, orange, red, together with all their intermediate degrees in a continual succession perpetually varying: So that there appeared as many degrees of Colours, as there were sorts of rays differing in refrangibility.

E X P E R. V.

Now that these Colours could not be changed by refraction, I knew by refracting with a Prism sometimes one very little part of this Light, sometimes another very little part, as is described in the 12th Experiment of the first Book. For by this refraction the Colour of the Light was never changed in the least. If any part of the red Light was refracted, it remained totally of the same red Colour as before. No orange, no yellow, no green, or blue, no other new Colour was produced by that refraction. Neither did the Colour any ways change by repeated refractions, but continued always the same red entirely as at first. The like constancy and immutability I found also in the blue, green, and other Colours. So also if I looked through a Prism upon any body illuminated with any part of this homogeneous Light, as in the 14th Experiment of the first Book is described; I could not perceive any new Colour generated this way. All Bodies illuminated with compound Light appear through Prisms confused (as was said above) and tinged with various new Colours, but those illuminated with homogeneous Light appeared
through

through Prisms neither less distinct, nor otherwise coloured, than when viewed with the naked Eyes. Their Colours were not in the least changed by the refraction of the interposed Prism. I speak here of a sensible change of Colour : For the Light which I here call homogeneous, being not absolutely homogeneous, there ought to arise some little change of Colour from its heterogeneity. But if that heterogeneity was so little as it might be made, by the said Experiments of the fourth Proposition, that change was not sensible, and therefore, in Experiments where sense is judge, ought to be accounted none at all.

E X P E R. VI.

And as these Colours were not changeable by refractions, so neither were they by reflexions. For all white, grey, red, yellow, green, blue, violet Bodies, as Paper, Ashes, red Lead, Orpiment, Indico, Bise, Gold, Silver, Copper, Grass, blue Flowers, Violets, Bubbles of Water tinged with various Colours, Peacock's Feathers, the tincture of *Lignum Nephriticum*, and such like, in red homogeneous Light appeared totally red, in blue Light totally blue, in green Light totally green, and so of other Colours. In the homogeneous Light of of any Colour they all appeared totally of that same Colour, with this only difference, that some of them reflected that Light more strongly, others more faintly. I never yet found any Body which by reflecting homogeneous Light could sensibly change its Colour.

From all which it is manifest, that if the Sun's Light consisted of but one sort of rays, there would be but one Colour in the whole World, nor would it be possible to produce any new Colour by reflexions and refractions, and by consequence that the variety of Colours depends upon the composition of Light.

DEFINITION.

The homogeneal light and rays which appear red, or rather make Objects appear so, I call rubrific or red-making; those which make Objects appear yellow, green, blue and violet, I call yellow-making, green-making, blue-making, violet-making, and so of the rest. And if at any time I speak of light and rays as coloured or endued with Colours, I would be understood to speak not philosophically and properly, but grossly, and according to such conceptions as vulgar People in seeing all these Experiments would be apt to frame. For the rays to speak properly are not coloured. In them there is nothing else than a certain power and disposition to stir up a sensation of this or that Colour. For as sound in a Bell or musical String, or other sounding Body, is nothing but a trembling Motion, and in the Air nothing but that Motion propagated from the Object, and in the Sensorium 'tis a sense of that Motion under the form of sound; so Colours in the Object are nothing but a disposition to reflect this or that sort of rays more copiously than the rest; in the rays they are nothing but their dispositions to propagate

gate this or that Motion into the Sensorium, and in the Sensorium they are sensations of those Motions under the forms of Colours.

PROP. III. PROB. I.

To define the refrangibility of the several sorts of homogeneous Light answering to the several Colours.

For determining this Problem I made the following Experiment.

EXPER. VII.

When I had caused the rectilinear line sides AF , GM , *Fig. 4.* of the Spectrum of Colours made by the Prism to be distinctly defined, as in the fifth Experiment of the first Book is described, there were found in it all the homogeneous Colours in the same order and situation one among another as in the Spectrum of simple Light, described in the fourth Experiment of that Book. For the Circles of which the Spectrum of compound Light PT is composed, and which in the middle parts of the Spectrum interfere and are intermixt with one another, are not intermixt in their outmost parts where they touch those rectilinear sides AF and GM . And therefore in those rectilinear sides when distinctly defined, there is no new Colour generated by refraction. I observed also, that if any where between the two outmost Circles TMF and PGA a right line, as γ^d , was cross to the Spectrum, so as at both ends to fall perpendicularly upon its rectilinear sides, there appeared

one and the same Colour and degree of Colour from one end of this line to the other. I delineated therefore in a Paper the perimeter of the Spectrum $FAPGMT$, and in trying the third Experiment of the first Book, I held the Paper so that the Spectrum might fall upon this delineated Figure, and agree with it exactly, whilst an Assistant whose Eyes for distinguishing Colours were more critical than mine, did by right lines $\alpha\beta, \gamma\delta, \epsilon\zeta, \eta\theta$ drawn cross the Spectrum, note the confines of the Colours that is of the red $M\alpha\beta F$ of the orange $\alpha\gamma\delta\beta$, of the yellow $\gamma\epsilon\zeta\delta$, of the green $\epsilon\eta\theta\zeta$, of the blue $\eta\iota\theta$, of the indico $\iota\lambda\mu\kappa$, and of the violet $\lambda GA\mu$. And this operation being divers times repeated both in the same and in several Papers, I found that the Observations agreed well enough with one another, and that the rectilinear sides MG and FA were by the said cross lines divided after the manner of a musical Chord. Let GM be produced to X , that MX may be equal to GM , and conceive $G X, \lambda X, \iota X, \eta X, \epsilon X, \gamma X, \alpha X, MX$, to be in proportion to one another, as the numbers $1, \frac{8}{9}, \frac{5}{6}, \frac{3}{4}, \frac{2}{3}, \frac{3}{5}, \frac{9}{10}, \frac{1}{2}$, and so to represent the Chords of the Key, and of a Tone, a third Minor, a fourth, a fifth, a sixth Major, a seventh, and an eighth above that Key: And the intervals $M\alpha, \alpha\gamma, \gamma\epsilon, \epsilon\eta, \eta\iota, \iota\lambda$, and λG , will be the spaces which the several Colours (red, orange, yellow, green, blue, indico, violet) take up.

Now these intervals or spaces subtending the differences of the refractions of the rays going to the limits of those Colours, that is, to the points $M, \alpha, \gamma, \epsilon, \eta, \iota, \lambda, G$, may without any sensible Error be accounted proportional to the differences of the lines of refraction of those rays

rays having one common sine of incidence, and therefore since the common sine of incidence of the most and least refrangible rays out of Glass into Air was, (by a method described above) found in proportion to their sines of refraction, as 50 to 77 and 78, divide the difference between the sines of refraction 77 and 78, as the line GM is divided by those intervals, you will have $77, 77\frac{1}{8}, 77\frac{1}{3}, 77\frac{1}{3}, 77\frac{1}{2}, 77\frac{2}{3}, 77\frac{7}{9}, 78$, the sines of refraction of those rays out of Glass into Air, their common sine of incidence being 50. So then the sines of the incidences of all the red-making rays out of Glass into Air, were to the sines of their refractions, not greater than 50 to 77, nor less than 50 to $77\frac{1}{8}$, but varied from one another according to all intermediate Proportions. And the sines of the incidences of the green-making rays were to the sines of their refractions in all proportions from that of 50 to $77\frac{1}{3}$, unto that of 50 to $77\frac{1}{2}$. And by the like limits above-mentioned were the refractions of the rays belonging to the rest of the Colours defined, the sines of the red-making rays extending from 77 to $77\frac{1}{8}$, those of the orange-making from $77\frac{1}{8}$ to $77\frac{1}{3}$, those of the yellow-making from $77\frac{1}{3}$ to $77\frac{1}{3}$, those of the green-making from $77\frac{1}{3}$ to $77\frac{1}{2}$, those of the blue-making from $77\frac{1}{2}$ to $77\frac{2}{3}$, those of the indico-making from $77\frac{2}{3}$ to $77\frac{7}{9}$, and those of the violet from $77\frac{7}{9}$ to 78.

These are the Laws of the refractions made out of Glass into Air, and thence by the three Axioms of the first Book the Laws of the refractions made out of Air into Glass are easily derived.

EXPER.

EXPER. VIII.

I found moreover that when Light goes out of Air through several contiguous refracting Mediums as through Water and Glafs, and thence goes out again into Air, whether the refracting superficies be parallel or inclined to one another, that Light as often as by contrary refractions 'tis so corrected, that it emergeth in lines parallel to those in which it was incident, continues ever after to be white. But if the emergent rays be inclined to the incident, the whiteness of the emerging Light will by degrees in passing on from the place of emergence, become tinged in its edges with Colours. This I tryed by refracting Light with Prisms of Glafs within a prismatick Vessel of Water. Now those Colours argue a diverging and separation of the heterogeneous rays from one another by means of their unequal refractions, as in what follows will more fully appear. And, on the contrary, the permanent whiteness argues, that in like incidences of the rays there is no such separation of the emerging rays, and by consequence no inequality of their whole refractions. Whence I seem to gether the two following Theorems.

1. The Excesses of the sines of refraction of several sorts of rays above their common sine of incidence when the refractions are made out of divers denser mediums immediately into one and the same rarer medium, are to one another in a given Proportion.

2. The

2. The Proportion of the sine of incidence to the sine of refraction of one and the same sort of rays out of one medium into another, is composed of the Proportion of the sine of incidence to the sine of refraction out of the first medium into any third medium, and of the Proportion of the sine of incidence to the sine of refraction out of that third medium into the second medium.

By the first Theorem the refractions of the rays of every sort made out of any medium into Air are known by having the refraction of the rays of any one sort. As for instance, if the refractions of the rays of every sort out of Rain-water into Air be desired, let the common sine of incidence out of Glass into Air be subducted from the sines of refraction, and the Excesses will be 27, $27\frac{1}{8}$, $27\frac{1}{5}$, $27\frac{1}{3}$, $27\frac{1}{2}$, $27\frac{2}{3}$, $27\frac{7}{9}$, 28. Suppose now that the sine of incidence of the least refrangible rays be to their sine of refraction out of Rain-water into Air as three to four, and say as 1 the difference of those sines is to 3 the sine of incidence, so is 27 the least of the Excesses above-mentioned to a fourth number 81 ; and 81 will be the common sign of incidence out of Rain-water into Air, to which sine if you add all the above-mentioned Excesses you will have the desired sines of the refractions 108, $108\frac{1}{8}$, $108\frac{1}{5}$, $108\frac{1}{3}$, $108\frac{1}{2}$, $108\frac{2}{3}$, $108\frac{7}{9}$, 109.

By the latter Theorem the refraction out of one medium into another is gathered as often as you have the refractions out of them both into any third medium. As if the sine of incidence of any ray out of Glass into Air be to its sine of refraction as 20 to 31, and the sine of incidence of the same ray out of Air into Water, be
to

to its sine of refraction as four to three; the sine of incidence of that ray out of Glass into Water will be to its sine of refraction as 20 to 31 and 4 to 3 jointly, that is, as the Factum of 20 and 4 to the Factum of 31 and 3, or as 80 to 93.

And these Theorems being admitted into Opticks, there would be scope enough of handling that Science voluminously after a new manner; not only by teaching those things which tend to the perfection of vision, but also by determining mathematically all kinds of Phenomena of Colours which could be produced by refractions. For to do this, there is nothing else requisite than to find out the separations of heterogeneous rays, and their various mixtures and proportions in every mixture. By this way of arguing I invented almost all the Phenomena described in these Books, beside some others less necessary to the Argument; and by the successes I met with in the tryals, I dare promise, that to him who shall argue truly, and then try all things with good Glasses and sufficient circumspection, the expected event will not be wanting. But he is first to know what Colours will arise from any others mixt in any assigned Proportion.

PROP. IV. THEOR. III.

Colours may be produced by composition which shall be like to the Colours of homogeneous Light as to the appearance of Colour, but not as to the immutability of Colour and constitution of Light. And those Colours by how much they are more compounded by so much are they less full and intense, and by too much composition they may be diluted

diluted and weakened till they cease. There may be also Colours produced by composition, which are not fully like any of the Colours of homogeneous Light.

For a mixture of homogeneous red and yellow compounds an orange, like in appearance of Colour to that orange which in the series of unmixed prismatic Colours lies between them; but the Light of one orange is homogeneous as to refrangibility, that of the other is heterogeneous, and the Colour of the one, if viewed through a Prism, remains unchanged, that of the other is changed and resolved into its component Colours red and yellow. And after the same manner other neighbouring homogeneous Colours may compound new Colours, like the intermediate homogeneous ones, as yellow and green, the Colour between them both, and afterwards, if blue be added, there will be made a green the middle Colour of the three which enter the composition. For the yellow and blue on either hand, if they are equal in quantity they draw the intermediate green equally towards themselves in composition, and so keep it as it were in equilibrio, that it verge not more to the yellow on the one hand, than to the blue on the other, but by their mixt actions remain still a middle Colour. To this mixed green there may be further added some red and violet, and yet the green will not presently cease but only grow less full and vivid, and by increasing the red and violet it will grow more and more dilute, until by the prevalence of the added Colours it be overcome and turned into whiteness, or some other Colour. So if to the Colour of any homogeneous Light, the Sun's white Light composed of all sorts of rays be

N

added,

added, that Colour will not vanish or change its species but be diluted, and by adding more and more white it will be diluted more and more perpetually. Lastly, if red and violet be mingled, there will be generated according to their various Proportions various Purples, such as are not like in appearance to the Colour of any homogeneal Light, and of these Purples mixt with yellow and blue may be made other new Colours.

PROP. V. THEOR. IV.

Whiteness and all grey Colours between white and black, may be compounded of Colours, and the whiteness of the Sun's Light is compounded of all the primary Colours mixt in a due proportion.

The Proof by Experiments.

EXPER. IX.

Fig. 5. The Sun shining into a dark Chamber through a little round Hole in the Window shut, and his Light being there refracted by a Prism to cast his coloured Image PT upon the opposite Wall: I held a white Paper V to that Image in such manner that it might be illuminated by the coloured Light reflected from thence, and yet not intercept any part of that Light in its passage from the Prism to the Spectrum. And I found that when the Paper was held nearer to any Colour than to the rest, it appeared of that Colour to which it approached nearest; but when it was equally or almost equally

equally distant from all the Colours, so that it might be equally illuminated by them all it appeared white. And in this last situation of the Paper, if some Colours were intercepted, the Paper lost its white Colour, and appeared of the Colour of the rest of the Light which was not intercepted. So then the Paper was illuminated with Lights of various Colours, namely, red, yellow, green, blue and violet, and every part of the Light retained its proper Colour, until it was incident on the Paper, and became reflected thence to the Eye ; so that if it had been either alone (the rest of the Light being intercepted) or if it had abounded most and been predominant in the Light reflected from the Paper, it would have tinged the Paper with its own Colour ; and yet being mixed with the rest of the Colours in a due proportion, it made the Paper look white, and therefore by a composition with the rest produced that Colour. The several parts of the coloured Light reflected from the Spectrum, whilst they are propagated from thence thro' the Air, do perpetually retain their proper Colours, because wherever they fall upon the Eyes of any Spectator, they make the several parts of the Spectrum to appear under their proper Colours. They retain therefore their proper Colours when they fall upon the Paper V, and so by the confusion and perfect mixture of those Colours compound the whiteness of the Light reflected from thence.

E X P E R. X.

Let that Spectrum or solar Image P T fall now upon *Fig. 6.*
 the Lens M N above four Inches broad, and about six
N 2
Feet

Feet distant from the Prism ABC, and so figured that it may cause the coloured Light which divergeth from the Prism to converge and meet again at its Focus G, about six or eight Feet distant from the Lens, and there to fall perpendicularly upon a white Paper DE. And if you move this Paper to and fro, you will perceive that near the Lens, as at *de*, the whole solar Image (suppose at *pt*) will appear upon it intensely coloured after the manner above-explained, and that by receding from the Lens those Colours will perpetually come towards one another, and by mixing more and more dilute one another continually, until at length the Paper come to the Focus G, where by a perfect mixture they will wholly vanish and be converted into whiteness, the whole Light appearing now upon the Paper like a little white Circle. And afterwards by receding further from the Lens, the rays which before converged will now cross one another in the Focus G, and diverge from thence, and thereby make the Colours to appear again, but yet in a contrary order; suppose at *de*, where the red *t* is now above which before was below, and the violet *p* is below which before was above.

Let us now stop the Paper at the Focus G where the Light appears totally white and circular, and let us consider its whiteness. I say, that this is composed of the converging Colours. For if any of those Colours be intercepted at the Lens, the whiteness will cease and degenerate into that Colour which ariseth from the composition of the other Colours which are not intercepted. And then if the intercepted Colours be let pass and fall upon that compound Colour, they mix with it, and by their mixture restore the whiteness.

So.

So if the violet, blue and green be intercepted, the remaining yellow, orange and red will compound upon the Paper an orange, and then if the intercepted Colours be let pass they will fall upon this compounded orange, and together with it decompound a white. So also if the red and violet be intercepted, the remaining yellow, green and blue, will compound a green upon the Paper, and then the red and violet being let pass will fall upon this green, and together with it decompound a white. And that in this composition of white the several rays do not suffer any change in their colorific qualities by acting upon one another, but are only mixed, and by a mixture of their Colours produce white, may further appear by these Arguments.

If the Paper be placed beyond the Focus G , suppose at a , and then the red Colour at the Lens be alternately intercepted, and let pass again, the violet Colour on the Paper will not suffer any change thereby, as it ought to do if the several sorts of rays acted upon one another in the Focus G , where they cross. Neither will the red upon the Paper be changed by any alternate stopping, and letting pass the violet which crosseth it.

And if the Paper be placed at the Focus G , and the white round Image at G be viewed through the Prism HIK , and by the refraction of that Prism be translated to the place rv , and there appear tinged with various Colours, namely, the violet at v and red at r , and others between, and then the red Colour at the Lens be often stopt and let pass by turns, the red at r will accordingly disappear and return as often, but the violet at v will not thereby suffer any change. And so by stopping and letting pass alternately the blue at the
 Lens,

Lens, the blue at r will accordingly disappear and return, without any change made in the red at r. The red therefore depends on one sort of rays, and the blue on another sort, which in the Focus G where they are commixt do not act on one another. And there is the same reason of the other Colours.

I considered further, that when the most refrangible rays P p, and the least refrangible ones T t, are by converging inclined to one another, the Paper, if held very oblique to those rays in the Focus G, might reflect one sort of them more copiously than the other sort, and by that means the reflected Light would be tinged in that Focus with the Colour of the predominant rays, provided those rays severally retained their Colours or colorific qualities in the composition of white made by them in that Focus. But if they did not retain them in that white, but became all of them severally endued there with a disposition to strike the sense with the perception of white, then they could never lose their whiteness by such reflexions. I inclined therefore the Paper to the rays very obliquely, as in the second Experiment of this Book, that the most refrangible rays might be more copiously reflected than the rest, and the whiteness at length changed successively into blue, indico and violet. Then I inclined it the contrary way, that the most refrangible rays might be more copious in the reflected Light than the rest, and the whiteness turned successively to yellow, orange and red.

Lastly, I made an Instrument XY in fashion of a Comb, whose Teeth being in number sixteen were about an Inch and an half broad, and the intervals of the Teeth about two Inches wide. Then by interposing suc-

successively the Teeth of this Instrument near the Lens, I intercepted part of the Colours by the interposed Tooth, whilst the rest of them went on through the interval of the Teeth to the Paper D E, and there painted a round solar Image. But the Paper I had first placed so, that the Image might appear white as often as the Comb was taken away; and then the Comb being as was said interposed, that whiteness by reason of the intercepted part of the Colours at the Lens did always change into the Colour compounded of those Colours which were not intercepted, and that Colour was by the motion of the Comb perpetually varied so, that in the passing of every Tooth over the Lens all these Colours red, yellow, green, blue and purple, did always succeed one another. I caused therefore all the Teeth to pass successively over the Lens, and when the motion was slow, there appeared a perpetual succession of the Colours upon the Paper: But if I so much accelerated the motion, that the Colours by reason of their quick succession could not be distinguished from one another, the appearance of the single Colours ceased. There was no red, no yellow, no green, no blue, nor purple to be seen any longer, but from a confusion of them all there arose one uniform white Colour. Of the Light which now by the mixture of all the Colours appeared white, there was no part really white. One part was red, another yellow, a third green, a fourth blue, a fifth purple, and every part retains its proper Colour till it strike the Sensorium. If the impressions follow one another slowly, so that they may be severally perceived, there is made a distinct sensation of all the Colours one after another in a continual succession.

But

But if the impressions follow one another so quickly that they cannot be severally perceived, there ariseth out of them all one common sensation, which is neither of this Colour alone nor of that alone, but hath it self indifferently to 'em all, and this is a sensation of whiteness. By the quickness of the successions the impressions of the several Colours are confounded in the Sensorium, and out of that confusion ariseth a mixt sensation. If a burning Coal be nimbly moved round in a Circle with Gyration continually repeated, the whole Circle will appear like fire; the reason of which is, that the sensation of the Coal in the several places of that Circle remains impress'd on the Sensorium, until the Coal return again to the same place. And so in a quick consecution of the Colours the impression of every Colour remains in the Sensorium, until a revolution of all the Colours be compleated, and that first Colour return again. The impressions therefore of all the successive Colours are at once in the Sensorium, and joyntly stir up a sensation of them all; and so it is manifest by this Experiment, that the commixt impressions of all the Colours do stir up and beget a sensation of white, that is, that whiteness is compounded of all the Colours.

And if the Comb be now taken away, that all the Colours may at once pass from the Lens to the Paper, and be there intermixed, and together reflected thence to the Spectators Eyes; their impressions on the Sensorium being now more subtilly and perfectly commixed there, ought much more to stir up a sensation of whiteness.

You

You may instead of the Lens use two Prisms *HIK* and *LMN*, which by refracting the coloured Light the contrary way to that of the first refraction, may make the diverging rays converge and meet again in *G*, as you see it represented in the seventh Figure. For *Fig. 7.* where they meet and mix they will compose a white Light as when a Lens is used.

E X P E R. XI.

Let the Sun's coloured Image *PT* fall upon the Wall *Fig. 8.* of a dark Chamber, as in the third Experiment of the first Book, and let the same be viewed through a Prism *abc*, held parallel to the Prism *ABC*, by whose refraction that Image was made, and let it now appear lower than before, suppose in the place *S* over against the red colour *T*. And if you go near to the Image *PT*, the Spectrum *S* will appear oblong and coloured like the Image *PT*; but if you recede from it, the Colours of the Spectrum *S* will be contracted more and more, and at length vanish, that Spectrum *S* becoming perfectly round and white; and if you recede yet further, the Colours will emerge again, but in a contrary order. Now that Spectrum *S* appears white in that case when the rays of several sorts which converge from the several parts of the Image *PT*, to the Prism *abc*, are so refracted unequally by it, that in their passage from the Prism to the Eye they may diverge from one and the same point of the Spectrum *S*, and so fall afterwards upon one and the same point in the bottom of the Eye, and there be mingled.

O

And

And further, if the Comb be here made use of, by whose Teeth the Colours at the Image PT may be successively intercepted ; the Spectrum S when the Comb is moved slowly will be perpetually tinged with successive Colours : But when by accelerating the motion of the Comb, the succession of the Colours is so quick that they cannot be severally seen, that Spectrum S, by a confused and mixt sensation of them all, will appear white.

E X P E R. XII.

Fig. 9. The Sun shining through a large Prism ABC upon a Comb XY, placed immediately behind the Prism, his Light which passed through the interstices of the Teeth fell upon a white Paper DE. The breadths of the Teeth were equal to their interstices, and seven Teeth together with their interstices took up an Inch in breadth. Now when the Paper was about two or three Inches distant from the Comb, the Light which passed through its several interstices painted so many ranges of Colours kl, mn, op, qr, &c. which were parallel to one another and contiguous, and without any mixture of white. And these ranges of Colours, if the Comb was moved continually up and down with a reciprocal motion, ascended and descended in the Paper, and when the motion of the Comb was so quick, that the Colours could not be distinguished from one another, the whole Paper by their confusion and mixture in the Sensorium appeared white.

Let

Let the Comb now rest, and let the Paper be removed further from the Prism, and the several ranges of Colours will be dilated and expanded into one another more and more, and by mixing their Colours will dilute one another, and at length, when the distance of the Paper from the Comb is about a Foot, or a little more (suppose in the place $\alpha D \alpha E$) they will so far dilute one another as to become white.

With any Obstacle let all the Light be now stopt which passes through any one interval of the Teeth, so that the range of Colours which comes from thence may be taken away, and you will see the Light of the rest of the ranges to be expanded into the place of the range taken away, and there to be coloured. Let the intercepted range pass on as before, and its Colours falling upon the Colours of the other ranges, and mixing with them, will restore the whiteness.

Let the Paper $\alpha D \alpha E$ be now very much inclined to the rays, so that the most refrangible rays may be more copiously reflected than the rest, and the white Colour of the Paper through the excess of those rays will be changed into blue and violet. Let the Paper be as much inclined the contrary way, that the least refrangible rays may be now more copiously reflected than the rest, and by their excess the whiteness will be changed into yellow and red. The several rays therefore in that white Light do retain their colorific qualities, by which those of any sort, when-ever they become more copious than the rest, do by their excess and predominance cause their proper Colour to appear.

And by the same way of arguing, applied to the third Experiment of this Book, it may be concluded, that the white Colour of all refracted Light at its very first emergence, where it appears as white as before its incidence, is compounded of various Colours.

EXPER. XIII.

In the foregoing Experiment the several intervals of the Teeth of the Comb do the office of so many Prisms, every interval producing the Phænomenon of one Prism. Whence instead of those intervals using several Prisms, I try'd to compound whiteness by mixing their Colours, and did it by using only three Prisms, as also by using only two as follows. Let two Prisms ABC and abc , whose refracting Angles B and b are equal, be so placed parallel to one another, that the refracting Angle B of the one may touch the Angle c at the base of the other, and their planes CB and cb , at which the rays emerge, may lye in directum. Then let the Light trajected through them fall upon the Paper MN , distant about 8 or 12 Inches from the Prisms. And the Colours generated by the interior limits B and c of the two Prisms, will be mingled at PT , and there compound white. For if either Prism be taken away, the Colours made by the other will appear in that place PT , and when the Prism is restored to its place again, so that its Colours may there fall upon the Colours of the other, the mixture of them both will restore the whiteness.

This

This Experiment succeeds also, as I have tryed, when the Angle b of the lower Prism, is a little greater than the Angle B of the upper, and between the interior Angles B and c , there intercedes some space Bc , as is represented in the Figure, and the refracting planes BC and bc , are neither in directum, nor parallel to one another. For there is nothing more requisite to the success of this Experiment, than that the rays of all sorts may be uniformly mixed upon the Paper in the place PT . If the most refrangible rays coming from the superior Prism take up all the space from M to P , the rays of the same sort which come from the inferior Prism ought to begin at P , and take up all the rest of the space from thence towards N . If the least refrangible rays coming from the superior Prism take up the space MT , the rays of the same kind which come from the other Prism ought to begin at T , and take up the remaining space TN . If one sort of the rays which have intermediate degrees of refrangibility, and come from the superior Prism be extended through the space MQ , and another sort of those rays through the space MR , and a third sort of them through the space MS , the same sorts of rays coming from the lower Prism, ought to illuminate the remaining spaces QN , RN , SN respectively. And the same is to be understood of all the other sorts of rays. For thus the rays of every sort will be scattered uniformly and evenly through the whole space MN , and so being every where mixt in the same proportion, they must every where produce the same Colour. And therefore since by this mixture they produce white in the exterior spaces MP and TN , they must also produce white in the interior space PT . This

is.

is the reason of the composition by which whiteness was produced in this Experiment, and by what other way soever I made the like composition the result was whiteness.

Lastly, If with the Teeth of a Comb of a due size, the coloured Lights of the two Prisms which fall upon the space P T be alternately intercepted, that space P T, when the motion of the Comb is slow, will always appear coloured, but by accelerating the motion of the Comb so much, that the successive Colours cannot be distinguished from one another, it will appear white.

E X P E R. XIV.

Hitherto I have produced whiteness by mixing the Colours of Prisms. If now the Colours of natural Bodies are to be mingled, let Water a little thickned with Soap be agitated to raise a froth, and after that froth has stood a little, there will appear to one that shall view it intently various Colours every where in the surfaces of the several Bubbles; but to one that shall go so far off that he cannot distinguish the Colours from one another, the whole froth will grow white with a perfect whiteness.

E X P E R. XV.

Lastly, in attempting to compound a white by mixing the coloured Powders which Painters use, I considered that all coloured Powders do suppress and stop in them a very considerable part of the Light by which they

they are illuminated. For they become coloured by reflecting the Light of their own Colours more copiously, and that of all other Colours more sparingly, and yet they do not reflect the Light of their own Colours so copiously as white Bodies do. If red Lead, for instance, and a white Paper, be placed in the red Light of the coloured Spectrum made in a dark Chamber by the refraction of a Prism, as is described in the third Experiment of the first Book ; the Paper will appear more lucid than the red Lead, and therefore reflects the red-making rays more copiously than red Lead doth. And if they be held in the Light of any other Colour, the Light reflected by the Paper will exceed the Light reflected by the red Lead in a much greater proportion. And the like happens in Powders of other Colours. And therefore by mixing such Powders we are not to expect a strong and full white, such as is that of Paper, but some dusky obscure one, such as might arise from a mixture of light and darkneis, or from white and black, that is, a grey, or dun, or russet brown, such as are the Colours of a Man's Nail, of a Mouse, of Ashes, of ordinary Stones, of Mortar, of Dust and Dirt in Highways, and the like. And such a dark white I have often produced by mixing coloured Powders. For thus one part of red Lead, and five parts of *Viride Æris*, composed a dun Colour like that of a Mouse. For these two Colours were severally so compounded of others, that in both together were a mixture of all Colours ; and there was less red Lead used than *Viride Æris*, because of the fulness of its Colour. Again, one part of red Lead, and four parts of blue Bise, composed a dun Colour verging a little to purple, and by adding to this a certain

certain mixture of Orpiment and *Viridi Æris* in a due proportion, the mixture lost its purple tincture, and became perfectly dun. But the Experiment succeeded best without Minium thus. To Orpiment I added by little and little a certain full bright purple, which Painters use until the Orpiment ceased to be yellow, and became of a pale red. Then I diluted that red by adding a little *Viride Æris*, and a little more blue Bisse than *Viridi Æris*, until it became of such a grey or pale white, as verged to no one of the Colours more than to another. For thus it became of a Colour equal in whiteness to that of Ashes or of Wood newly cut, or of a Man's Skin. The Orpiment reflected more Light than did any other of the Powders, and therefore conduced more to the whiteness of the compounded Colour than they. To assign the proportions accurately may be difficult, by reason of the different goodness of Powders of the same kind. Accordingly as the Colour of any Powder is more or less full and luminous, it ought to be used in a less or greater proportion.

Now considering that these grey and dun Colours may be also produced by mixing whites and blacks, and by consequence differ from perfect whites not in Species of Colours but only in degree of luminousness, it is manifest that there is nothing more requisite to make them perfectly white than to increase their Light sufficiently; and, on the contrary, if by increasing their Light they can be brought to perfect whiteness, it will thence also follow, that they are of the same Species of Colour with the best whites, and differ from them only in the quantity of Light. And this I tryed as follows. I took the third of the above-mentioned grey mixtures (that

(that which was compounded of Orpiment, Purple, Bise and *Viride Aëris*) and rubbed it thickly upon the floor of my Chamber, where the Sun shone upon it through the opened Casement ; and by it, in the shadow, I laid a piece of white Paper of the same bigness. Then going from them to the distance of 12 or 18 Feet, so that I could not discern the unevenness of the surface of the Powder, nor the little shadows let fall from the gritty particles thereof ; the Powder appeared intently white, so as to transcend even the Paper it self in whiteness, especially if the Paper were a little shaded from the Light of the Clouds, and then the Paper compared with the Powder appeared of such a grey Colour as the Powder had done before. But by laying the Paper where the Sun shines through the Glass of the Window, or by shutting the Window that the Sun might shine through the Glass upon the Powder, and by such other fit means of increasing or decreasing the Lights wherewith the Powder and Paper were illuminated, the Light wherewith the Powder is illuminated may be made stronger in such a due proportion than the Light wherewith the Paper is illuminated, that they shall both appear exactly alike in whiteness. For when I was trying this, a Friend coming to visit me, I stopt him at the door, and before I told him what the Colours were, or what I was doing ; I askt him, Which of the two whites were the best, and wherein they differed ? And after he had at that distance viewed them well, he answered, That they were both good whites, and that he could not say which was best, nor wherein their Colours differed. Now if you consider, that this white of the Powder in the Sun-shine was compounded of the

Colours which the component Powders (Orpiment, Purple, Bife, and *Viride Æris*) have in the fame Sun-
shine, you must acknowledge by this Experiment, as
well as by the former, that perfect whiteness may be
compounded of Colours.

From what has been said it is also evident, that the
whiteness of the Sun's Light is compounded of all the
Colours wherewith the several sorts of rays whereof
that Light consists, when by their several refrangibili-
ties they are separated from one another, do tinge Paper
or any other white Body whereon they fall. For those
Colours by Prop. 2. are unchangeable, and whenever
all those rays with those their Colours are mixt again,
they reproduce the same white Light as before.

P R O P. VI. P R O B. II.

*In a mixture of primary Colours, the quantity and quality
of each being given, to know the Colour of the com-
pound.*

Fig. 11. With the Center O and Radius OD describe a Circle
ADF, and distinguish its circumference into seven parts
DE, EF, FG, GA, AB, BC, CD, proportional to
the seven musical Tones or Intervals of the eight Sounds,
Sol, la, fa, sol, la, mi, fa, sol, contained in an Eight,
that is, proportional to the numbers $\frac{1}{9}$, $\frac{1}{10}$, $\frac{1}{10}$, $\frac{1}{9}$, $\frac{1}{10}$, $\frac{1}{10}$,
 $\frac{1}{9}$. Let the first part DE represent a red Colour, the
second EF orange, the third FG yellow, the fourth
GH green, the fifth AB blue, the sixth BC indico,
and the seventh CD violet. And conceive that these
are all the Colours of uncompounded Light gradually
passing

passing into one another, as they do when made by Prisms ; the circumference $DEFGABCD$, representing the whole series of Colours from one end of the Sun's coloured Image to the other, so that from D to E be all degrees of red, at E the mean Colour between red and orange, from E to F all degrees of orange, at F the mean between orange and yellow, from F to G all degrees of yellow, and so on. Let p be the center of gravity of the Arch DE , and q, r, s, t, v, x , the centers of gravity of the Arches EF, FG, GA, AB, BC and CD respectively, and about those centers of gravity let Circles proportional to the number of rays of each Colour in the given mixture be described ; that is, the circle p proportional to the number of the red-making rays in the mixture, the Circle q proportional to the number of the orange-making rays in the mixture, and so of the rest. Find the common center of gravity of all those Circles p, q, r, s, t, v, x . Let that center be Z ; and from the center of the Circle ADF , through Z to the circumference, drawing the right line OY , the place of the point Y in the circumference shall shew the Colour arising from the composition of all the Colours in the given mixture, and the line OZ shall be proportional to the fulness or intenseness of the Colour, that is, to its distance from whiteness. As if Y fall in the middle between F and G , the compounded Colour shall be the best yellow ; if Y verge from the middle towards F or G , the compounded Colour shall accordingly be a yellow, verging towards orange or green. If Z fall upon the circumference the Colour shall be intense and florid in the highest degree ; if it fall in the midway between the circumference and center, it shall be

but half so intense, that is, it shall be such a Colour as would be made by diluting the intensest yellow with an equal quantity of whiteness; and if it fall upon the center O, the Colour shall have lost all its intenseness, and become a white. But it is to be noted, That if the point Z fall in or near the line OD, the main ingredients being the red and violet, the Colour compounded shall not be any of the prismatic Colours, but a purple, inclining to red or violet, accordingly as the point Z lieth on the side of the line DO towards E or towards C, and in general the compounded violet is more bright and more fiery than the uncompounded. Also if only two of the primary Colours which in the Circle are opposite to one another be mixed in an equal proportion, the point Z shall fall upon the center O, and yet the Colour compounded of those two shall not be perfectly white, but some faint anonymous Colour. For I could never yet by mixing only two primary Colours produce a perfect white. Whether it may be compounded of a mixture of three taken at equal distances in the circumference I do not know, but of four or five I do not much question but it may. But these are curiosities of little or no moment to the understanding the Phænomena of nature. For in all whites produced by nature, there uses to be a mixture of all sorts of rays, and by consequence a composition of all Colours.

To give an instance of this Rule; suppose a Colour is compounded of these homogeneous Colours, of violet 1 part, of indico 1 part, of blue 2 parts, of green 3 parts, of yellow 5 parts, of orange 6 parts, and of red 10 parts. Proportional to these parts I describe the Circles x, v, t, s, r, q, p respectively, that is, so that if the Circle x
be

be 1, the Circle v may be 1, the Circle t 2, the Circle s 3, and the Circles r, q and p, 5, 6 and 10. Then I find Z the common center of gravity of these Circles, and through Z drawing the line OY, the point Y falls upon the circumference between E and F, some thing nearer to E than to F, and thence I conclude, that the Colour compounded of these ingredients will be an orange, verging a little more to red than to yellow. Also I find that OZ is a little less than one half of OY, and thence I conclude, that this orange hath a little less than half the fulness or intenseness of an uncompounded orange; that is to say, that it is such an orange as may be made by mixing an homogeneal orange with a good white in the proportion of the line OZ to the line ZY, this proportion being not of the quantities of mixed orange and white powders, but of the quantities of the lights reflected from them.

This Rule I conceive accurate enough for practise, though not mathematically accurate; and the truth of it may be sufficiently proved to sense, by stopping any of the Colours at the Lens in the tenth Experiment of this Book. For the rest of the Colours which are not stopped, but pass on to the Focus of the Lens, will there compound either accurately or very nearly such a Colour as by this Rule ought to result from their mixture.

PROP. VII. THEOR. V.

All the Colours in the Universe which are made by Light, and depend not on the power of imagination, are either the Colours of homogeneous Lights, or compounded of these and that either accurately or very nearly, according to the Rule of the foregoing Problem.

For it has been proved (in Prop.1. *Lib.*2.) that the changes of Colours made by refractions do not arise from any new modifications of the rays impressed by those refractions, and by the various terminations of light and shadow, as has been the constant and general opinion of Philosophers. It has also been proved that the several Colours of the homogeneous rays do constantly answer to their degrees of refrangibility, (Prop.1. *Lib.*1. and Prop.2. *Lib.*2.) and that their degrees of refrangibility cannot be changed by refractions and reflexions, (Prop.2. *Lib.*1.) and by consequence that those their Colours are likewise immutable. It has also been proved directly by refracting and reflecting homogeneous Lights apart, that their Colours cannot be changed, (Prop.2. *Lib.*2.) It has been proved also, that when the several sorts of rays are mixed, and in crossing pass through the same space, they do not act on one another so as to change each others colorifick qualities, (Exper. 10. *Lib.*2.) but by mixing their actions in the Sensorium beget a sensation differing from what either would do apart, that is a sensation of a mean Colour between their proper Colours ; and particularly when by the concurrence and mixtures of all sorts of rays, a white Colour

Colour is produced, the white is a mixture of all the Colours which the rays would have apart, (Prop. 5. *Lib.* 2.) The rays in that mixture do not lose or alter their several colorifick qualities, but by all their various kinds of actions mixt in the Sensorium, beget a sensation of a middling Colour between all their Colours which is whiteness. For whiteness is a mean between all Colours, having it self indifferently to them all, so as with equal facility to be tinged with any of them. A red Powder mixed with a little blue, or a blue with a little red, doth not presently lose its Colour, but a white Powder mixed with any Colour is presently tinged with that Colour, and is equally capable of being tinged with any Colour what-ever. It has been shewed also, that as the Sun's Light is mixed of all sorts of rays, so its whiteness is a mixture of the Colours of all sorts of rays; those rays having from the beginning their several colorific qualities as well as their several refrangibilities, and retaining them perpetually unchang'd notwithstanding any refractions or reflexions they may at any time suffer, and that when-ever any sort of the Sun's rays is by any means (as by reflexion in *Exper.* 9 and 10. *Lib.* 1. or by refraction as happens in all refractions) separated from the rest, they then manifest their proper Colours. These things have been proved; and the sum of all this amounts to the Proposition here to be proved. For if the Sun's Light is mixed of several sorts of rays, each of which have originally their several refrangibilities and colorifick qualities, and notwithstanding their refractions and reflections, and their various separations or mixtures, keep those their original properties perpetually the same without alteration;

tion ; then all the Colours in the World must be such as constantly ought to arise from the original colorific qualities of the rays whereof the Lights consist by which those Colours are seen. And therefore if the reason of any Colour what-ever be required, we have nothing else to do then to consider how the rays in the Sun's Light have by reflexions or refractions, or other causes been parted from one another, or mixed together ; or otherwise to find out what sorts of rays are in the Light by which that Colour is made, and in what proportion ; and then by the last Problem to learn the Colour which ought to arise by mixing those rays (or their Colours) in that proportion. I speak here of Colours so far as they arise from Light. For they appear sometimes by other causes, as when by the power of phantasy we see Colours in a Dream, or a mad Man sees things before him which are not there ; or when we see Fire by striking the Eye, or see Colours like the Eye of a Peacock's Feather, by pressing our Eyes in either corner whilst we look the other way. Where these and such like causes interpose not, the Colour always answers to the sort or sorts of the rays whereof the Light consists, as I have constantly found in what-ever Phenomena of Colours I have hitherto been able to examin. I shall in the following Propositions give instances of this in the Phenomena of chiefest note.

P R O P.

PROP. VIII. PROB. III.

By the discovered Properties of Light to explain the Colours made by Prisms.

Let ABC represent a Prism refracting the Light of *Fig. 12.*
the Sun, which comes into a dark Chamber through a Hole F ϕ almost as broad as the Prism, and let MN represent a white Paper on which the refracted Light is cast, and suppose the most refrangible or deepest violet making rays fall upon the space P π , the least refrangible or deepest red-making rays upon the space T η , the middle sort between the Indico-making and blue-making rays upon the space Q χ , the middle sort of the green-making rays upon the space R ϵ , the middle sort between the yellow-making and orange-making rays upon the space S σ , and other intermediate sorts upon intermediate spaces. For so the spaces upon which the several sorts adequately fall will by reason of the different refrangibility of those sorts be one lower than another. Now if the Paper MN be so near the Prism that the spaces P T and $\pi\eta$ do not interfere with one another, the distance between them T π will be illuminated by all the sorts of rays in that proportion to one another which they have at their very first coming out of the Prism, and consequently be white. But the spaces P T and $\pi\eta$ on either hand, will not be illuminated by them all, and therefore will appear coloured. And particularly at P, where the outmost violet-making rays fall alone, the Colour must be the deepest violet. At Q where the violet-making and indico-making rays are mixed, it
Q must

must be a violet inclining much to indico. At R where the violet-making, indico-making, blue-making, and one half of the green-making rays are mixed, their Colours must (by the construction of the second Problem) compound a middle Colour between indico and blue. At S where all the rays are mixed except the red-making and orange-making, their Colours ought by the same Rule to compound a faint blue, verging more to green than indie. And in the progress from S to T, this blue will grow more and more faint and dilute, till at T, where all the Colours begin to be mixed, it end in whiteness.

— So again, on the other side of the white at T, where the least refrangible or utmost red-making rays are alone the Colour must be the deepest red. At σ the mixture of red and orange will compound a red inclining to orange. At ρ the mixture of red, orange, yellow, and one half of the green must compound a middle Colour between orange and yellow. At χ the mixture of all Colours but violet and indico will compound a faint yellow, verging more to green than to orange. And this yellow will grow more faint and dilute continually in its progress from χ to π , where by a mixture of all sorts of rays it will become white.

These Colours ought to appear were the Sun's Light perfectly white: But because it inclines to yellow, the excess of the yellow-making rays whereby 'tis tinged with that Colour, being mixed with the faint blue between S and T, will draw it to a faint green. And so the Colours in order from P to T ought to be violet, indico, blue, very faint green, white, faint yellow, orange, red. Thus it is by the computation: And they that please to
view

view the Colours made by a Prism will find it so in Nature.

These are the Colours on both sides the white when the Paper is held between the Prism, and the point X where the Colours meet, and the interjacent white vanishes. For if the Paper be held still farther off from the Prism, the most refrangible and least refrangible rays will be wanting in the middle of the Light, and the rest of the rays which are found there, will by mixture produce a fuller green than before. Also the yellow and blue will now become less compounded, and by consequence more intense than before. And this also agrees with experience.

And if one look through a Prism upon a white Object encompassed with blackness or darkness, the reason of the Colours arising on the edges is much the same, as will appear to one that shall a little consider it. If a black Object be encompassed with a white one, the Colours which appear through the Prism are to be derived from the Light of the white one, spreading into the Regions of the black, and therefore they appear in a contrary order to that, in which they appear when a white Object is surrounded with black. And the same is to be understood when an Object is viewed, whose parts are some of them less luminous than others. For in the borders of the more and less luminous parts, Colours ought always by the same Principles to arise from the excess of the Light of the more luminous, and to be of the same kind as if the darker parts were black, but yet to be more faint and dilute.

What is said of Colours made by Prisms may be easily applied to Colours made by the Glasses of Telescopes or Microscopes, or by the humours of the Eye. For if the Object-glass of a Telescope be thicker on one side than on the other, or if one half of the Glass, or on half of the Pupil of the Eye be covered with any opaque substance: the Object-glass, or that part of it or of the Eye which is not covered, may be considered as a Wedge with crooked sides, and every Wedge of Glass, or other pellucid substance, has the effect of a Prism in refracting the Light which passes through it.

How the Colours in the 9th and 10th Experiment of the first Part arise from the different reflexibility of Light, is evident by what was there said. But it is observable in the 9th Experiment, that whilst the Sun's direct Light is yellow, the excess of the blue-making rays in the reflected Beam of Light MN, suffices only to bring that yellow to a pale white inclining to blue and not to tinge it with a manifestly blue Colour. To obtain therefore a better blue, I used instead of the yellow Light of the Sun the white Light of the Clouds, by varying a little the Experiment as follows.

E X P E R. XVI.

Fig. 13. Let HFG represent a Prism in the open Air, and S the Eye of the Spectator, viewing the Clouds by their Light coming into the Prism at the plane side FIGK and reflected in it by its base HEIG, and thence going out through its plain side HEFK to the Eye. And when the Prism and Eye are conveniently placed, so that the Angles of incidence and reflexion at the base may

may be about 40 degrees, the Spectator will see a Bow MN of a blue Colour, running from one end of the base to the other, with the concave side towards him, and the part of the base IMNG beyond this Bow will be brighter than the other part EMNH on the other side of it. This blue Colour MN being made by nothing else than by reflexion of a specular superficies, seems so odd a Phænomenon, and so unaccountable for by the vulgar Hypothesis of Philosophers, that I could not but think it deserved to be taken notice of. Now for understanding the reason of it, suppose the plane ABC to cut the plane sides and base of the Prism perpendicularly. From the Eye to the line BC, wherein that plane cuts the base, draw the lines Sp and St, in the Angles Spc 50 degr. $\frac{1}{2}$, and Stc 49 degr. $\frac{1}{28}$, and the point p will be the limit beyond which none of the most refrangible rays can pass through the base of the Prism, and be refracted, whose incidence is such that they may be reflected to the Eye; and the point t will be the like limit for the least refrangible rays, that is, beyond which none of them can pass through the base, whose incidence is such that by reflexion they may come to the Eye. And the point r taken in the middle way between p and t, will be the like limit for the meanly refrangible rays. And therefore all the refrangible rays which fall upon the base beyond t, that is, between t and B, and can come from thence to the Eye will be reflected thither: But on this side t, that is, between t and c, many of these rays will be transmitted through the base. And all the most refrangible rays which fall upon the base beyond p, that is, between p and B, and can by reflexion come from thence to the Eye, will be reflected thither,

thither, but every where between t and c , many of these rays will get through the base and be refracted; and the same is to be understood of the meanly refrangible rays on either side of the point r . Whence it follows, that the base of the Prism must every where between t and B , by a total reflexion of all sorts of rays to the Eye, look white and bright. And every where between p and C , by reason of the transmission of many rays of every sort, look more pale, obscure and dark. But at r , and in other places between p and t , where all the more refrangible rays are reflected to the Eye, and many of the less refrangible are transmitted, the excess of the most refrangible in the reflected Light will tinge that Light with their Colour, which is violet and blue. And this happens by taking the line Cpr tB any where between the ends of the Prism HG and EI .

P R O P. IX. P R O B. IV.

By the discovered Properties of Light to explain the Colours of the Rain-bow.

This Bow never appears but where it Rains in the Sun-shine, and may be made artificially by spouting up Water which may break aloft, and scatter into Drops, and fall down like Rain. For the Sun shining upon these Drops certainly causes the Bow to appear to a Spectator standing in a due position to the Rain and Sun. And hence it is now agreed upon, that this Bow is made by refraction of the Sun's Light in Drops of falling Rain. This was understood by some of the Ancients, and of late more fully discovered and explained by the Famous
Antonius

Antonius de Dominis Archbishop of *Spilato*, in his Book *De Radiis Visus & Lucis*, published by his Friend *Bar-tolus* at *Venice*, in the Year 1611, and written above twenty Years before. For he teaches there how the interior Bow is made in round Drops of Rain by two refractions of the Sun's Light, and one reflexion between them, and the exterior by two refractions and two sorts of reflexions between them in each Drop of Water, and proves his Explications by Experiments made with a Phial full of Water, and with Globes of Glass filled with Water, and placed in the Sun to make the Colours of the two Bows appear in them. The same Explication *Des-Cartes* hath pursued in his *Meteors*, and mended that of the exterior Bow. But whilst they understood not the true origin of Colours, it's necessary to pursue it here a little further. For understanding therefore how the Bow is made, let a Drop of Rain or any other spherical transparent Body be represented by the Sphere $BNFG$, described with the Center C , and *Fig. 14.* Semi-diameter CN . And let AN be one of the Sun's rays incident upon it at N , and thence refracted to F , where let it either go out of the Sphere by refraction towards V , or be reflected to G ; and at G let it either go out by refraction to R , or be reflected to H ; and at H let it go out by refraction towards S , cutting the incident ray in Y ; produce AN and RG , till they meet in X , and upon AX and NF let fall the perpendiculars CD and CE , and produce CD till it fall upon the circumference at L . Parallel to the incident ray AN draw the Diameter BQ , and let the sine of incidence out of Air into Water be to the sine of refraction as I to R . Now if you suppose the point of incidence N to
 move

move from the point B, continually till it come to L, the Arch QF will first increase and then decrease, and so will the Angle AXR which the rays AN and GR contain; and the Arch QF and Angle AXR will be biggest when ND is to CN as $\sphericalangle \overline{\text{II-RR}}$ to $\sphericalangle 3 \text{ RR}$, in which case NE will be to ND as 2 R to I. Also the Angle AYS which the rays AN and HS contain will first decrease, and then increase and grow least when ND is to CN as $\sphericalangle \overline{\text{II-RR}}$ to $\sphericalangle 8 \text{ RR}$, in which case NE will be to ND as 3 R to I. And so the Angle which the next emergent ray (that is, the emergent ray after three reflexions) contains with the incident ray AN will come to its limit when ND is to CN as $\sphericalangle \overline{\text{II-RR}}$ to $\sphericalangle 15 \text{ RR}$, in which case NE will be to ND as 4 R to I, and the Angle which the ray next after that emergent, that is, the ray emergent after four reflexions, contains with the incident will come to its limit, when ND is to CN as $\sphericalangle \overline{\text{II-RR}}$ to $\sphericalangle 24 \text{ RR}$, in which case NE will be to ND as 5 R to I; and so on infinitely, the numbers 3, 8, 15, 24, &c. being gathered by continual addition of the terms of the arithmetical progression 3, 5, 7, 9, &c. The truth of all this Mathematicians will easily examine.

Now it is to be observed, that as when the Sun comes to his Tropicks, days increase and decrease but a very little for a great while together; so when by increasing the distance CD, these Angles come to their limits, they vary their quantity but very little for some time together, and therefore a far greater number of the rays which fall upon all the points N in the Quadrant BL, shall emerge in the limits of these Angles, then in any other inclinations. And further it is

to be observed, that the rays which differ in refrangibility will have different limits of their Angles of emergence, and by consequence according to their different degrees of refrangibility emerge most copiously in different Angles, and being separated from one another appear each in their proper Colours. And what those Angles are may be easily gathered from the foregoing Theorem by computation.

For in the least refrangible rays the sines I and R (as was found above) are 108 and 81, and thence by computation the greatest Angle AXR will be found 42 degrees and 2 minutes, and the least Angle AYS, 50 degr. and 57 minutes. And in the most refrangible rays the sines I and R are 109 and 81, and thence by computation the greatest Angle AXR will be found 40 degrees and 17 minutes, and the least Angle AYS 54 degrees and 7 minutes.

Suppose now that O is the Spectator's Eye, and OP a line *Fig. 15.* drawn parallel to the Sun's rays, and let POE, POF, POG, POH, be Angles of 40 degr. 17 min. 42 degr. 2 min. 50 degr. 57 min. and 54 degr. 7 min. respectively, and these Angles turned about their common side OP, shall with their other sides OE, OF; OG, OH describe the verges of two Rain-bows AFBE and CHDG. For if E, F, G, H, be Drops placed any where in the conical superficies described by OE, OF, OG, OH, and be illuminated by the Sun's rays SE, SF, SG, SH; the Angle SEO being equal to the Angle POE or 40 degr. 17 min. shall be the greatest Angle in which the most refrangible rays can after one reflexion be refracted to the Eye, and therefore all the Drops in the line OE shall send the most refrangible
R rays

rays most copiously to the Eye, and thereby strike the senses with the deepest violet Colour in that region. And in like manner the Angle SFO being equal to the Angle POF, or 42 deg. 2 min. shall be the greatest in which the least refrangible rays after one reflexion can emerge out of the Drops, and therefore those rays shall come most copiously to the Eye from the Drops in the line OF, and strike the senses with the deepest red Colour in that region. And by the same argument, the rays which have intermediate degrees of refrangibility shall come most copiously from Drops between E and F, and strike the senses with the intermediate Colours in the order which their degrees of refrangibility require, that is, in the progress from E to F, or from the inside of the Bow to the outside in this order, violet, indico, blue, green, yellow, orange, red. But the violet, by the mixture of the white Light of the Clouds, will appear faint and incline to purple.

Again, the Angle SGO being equal to Angle POG, or 50 gr. 51 min. shall be the least Angle in which the least refrangible rays can after two reflexions emerge out of the Drops, and therefore the least refrangible rays shall come most copiously to the Eye from the Drops in the line OG, and strike the sense with the deepest red in that region. And the Angle SHO being equal to the Angle POH or 54 gr. 7 min. shall be the least Angle in which the most refrangible rays after two reflections can emerge out of the Drops, and therefore those rays shall come most copiously to the Eye from the Drops in the line OH, and strike the senses with the deepest violet in that region. And by the same argument, the Drops in the regions between G and H shall strike the sense with
the

the intermediate Colours in the order which their degrees of refrangibility require, that is, in the progress from G to H, or from the inside of the Bow to the outside in this order, red, orange, yellow, green, blue, indico, violet. And since these four lines OE, OF, OG, OH, may be situated any where in the above-mentioned conical superficies, what is said of the Drops and Colours in these lines is to be understood of the Drops and Colours every where in those superficies.

Thus shall there be made two Bows of Colours, an interior and stronger, by one reflexion in the Drops, and an exterior and fainter by two; for the Light becomes fainter by every reflexion. And their Colours shall ly in a contrary order to one another, the red of both Bows bordering upon the space GF which is between the Bows. The breadth of the interior Bow EOF measured cross the Colours shall be 1 degr. 45 min. and the breadth of the exterior GOH shall be 3 degr. 10 min. and the distance between them GOF shall be 8 gr. 55 min. the greatest Semi-diameter of the innermost, that is, the Angle POF being 42 gr. 2 min. and the least Semi-diameter of the outermost POG, being 50 gr. 57 min. These are the measures of the Bows, as they would be were the Sun but a point; for by the breadth of his Body the breadth of the Bows will be increased and their distance decreased by half a degree, and so the breadth of the interior Iris will be 2 degr. 15 min. that of the exterior 3 degr. 40 min. their distance 8 degr. 25 min. the greatest Semi-diameter of the interior Bow 42 degr. 17 min. and the least of the exterior 50 degr. 42 min. And such are the dimensions of the Bows in the Heavens found to be very nearly,

when their Colours appear strong and perfect. For once, by such means as I then had, I measured the greatest Semi-diameter of the interior Iris about 42 degrees, the breadth of the red, yellow and green in that Iris 63 or 64 minutes, besides the outmost faint red obscured by brightness of the Clouds, for which we may allow 3 or 4 minutes more. The breadth of the blue was about 40 minutes more besides the violet, which was so much obscured by the brightness of the Clouds, that I could not measure its breadth. But supposing the breadth of the blue and violet together to equal that of the red, yellow and green together, the whole breadth of this Iris will be about $2\frac{1}{4}$ degrees as above. The least distance between this Iris and the exterior Iris was about 8 degrees and 30 minutes. The exterior Iris was broader than the interior, but so faint, especially on the blue side, that I could not measure its breadth distinctly. At another time when both Bows appeared more distinct, I measured the breadth of the interior Iris 2 gr. 10', and the breadth of the red, yellow and green in the exterior Iris, was to the breadth of the same Colours in the interior as 3 to 2.

This Explication of the Rain-bow is yet further confirmed by the known Experiment (made by *Antonius de Dominis* and *Des-Cartes*) of hanging up any where in the Sun-shine a Glass-Globe filled with Water, and viewing it in such a posture that the rays which come from the Globe to the Eye may contain with the Sun's rays an Angle of either 42 or 50 degrees. For if the Angle be about 42 or 43 degrees, the Spectator (suppose at O) shall see a full red Colour in that side of the Globe opposed to the Sun as 'tis represented at F, and
if

if that Angle become less (suppose by depressing the Globe to E) there will appear other Colours, yellow, green and blue successively in the same side of the Globe. But if the Angle be made about 50 degrees (suppose by lifting up the Globe to G) there will appear a red Colour in that side of the Globe towards the Sun, and if the Angle be made greater (suppose by lifting up the Globe to H) the red will turn successively to the other Colours yellow, green and blue. The same thing I have tried by letting a Globe rest, and raising or depressing the Eye, or otherwise moving it to make the Angle of a just magnitude.

I have heard it represented, that if the Light of a Candle be refracted by a Prism to the Eye; when the blue Colour falls upon the Eye the Spectator shall see red in the Prism, and when the red falls upon the Eye he shall see blue; and if this were certain, the Colours of the Globe and Rain-bow ought to appear in a contrary order to what we find. But the Colours of the Candle being very faint, the mistake seems to arise from the difficulty of discerning what Colours fall on the Eye. For, on the contrary, I have sometimes had occasion to observe in the Sun's Light refracted by a Prism, that the Spectator always sees that Colour in the Prism which falls upon his Eye. And the same I have found true also in Candle-Light. For when the Prism is moved slowly from the line which is drawn directly from the Candle to the Eye, the red appears first in the Prism and then the blue, and therefore each of them is seen when it falls upon the Eye. For the red passes over the Eye first, and then the blue.

The

The Light which comes through Drops of Rain by two refractions without any reflexion, ought to appear strongest at the distance of about 26 degrees from the Sun, and to decay gradually both ways as the distance from him increaseth and decreaseth. And the same is to be understood of Light transmitted through spherical Hail-stones. And if the Hail be a little flattened, as it often is, the Light transmitted may grow so strong at a little less distance than that of 26 degrees, as to form a Halo about the Sun or Moon; which Halo, as often as the Hail-stones are duly figured may be coloured, and then it must be red within by the least refrangible rays, and blue without by the most refrangible ones, especially if the Hail-stones have opaque Globules of Snow in their center to intercept the Light within the Halo (as *Hugenius* has observed) and make the inside thereof more distinctly defined than it would otherwise be. For such Hail-stones, though spherical, by terminating the Light by the Snow, may make a Halo red within and colourless without, and darker in the red than without, as Halos use to be. For of those rays which pass close by the Snow the rubriform will be least refracted, and so come to the Eye in the directest lines.

The Light which passes through a Drop of rain after two refractions, and three or more reflexions, is scarce strong enough to cause a sensible Bow; but in those Cylinders of Ice by which *Hugenius* explains the *Parhelia*, it may perhaps be sensible.

PROP. X. PROB. V.

By the discovered Properties of Light to explain the permanent Colours of natural Bodies.

These Colours arise from hence, that some natural Bodies reflect some sorts of rays, others other sorts more copiously than the rest. Minium reflects the least refrangible or red-making rays most copiously, and thence appears red. Violets reflect the most refrangible, most copiously, and thence have their Colour, and so of other Bodies. Every Body reflects the rays of its own Colour more copiously than the rest, and from their excess and predominance in the reflected Light has its Colour.

EXPER. XVII.

For if the homogeneal Lights obtained by the solution of the Problem proposed in the 4th Proposition of the first Book you place Bodies of several Colours, you will find, as I have done, that every Body looks most splendid and luminous in the Light of its own Colour. Cinnaber in the homogeneal red Light is most resplendent, in the green Light it is manifestly less resplendent, and in the blue Light still less. Indico in the violet blue Light is most resplendent, and its splendor is gradually diminished as it is removed thence by degrees through the green and yellow Light to the red. By a LEEK the green Light, and next that the blue and yellow which compound green, are more strongly reflected.

flected than the other Colours red and violet, and so of the rest. But to make these Experiments the more manifest, such Bodies ought to be chosen as have the fullest and most vivid Colours, and two of those Bodies are to be compared together. Thus, for instance, if Cinnaber and *ultra* marine blue, or some other full blue be held together in the homogeneous Light, they will both appear red, but the Cinnaber will appear of a strongly luminous and resplendent red, and the *ultra* marine blue of a faint obscure and dark red; and if they be held together in the blue homogeneous Light they will both appear blue, but the *ultra* marine will appear of a strongly luminous and resplendent blue, and the Cinnaber of a faint and dark blue. Which puts it out of dispute, that the Cinnaber reflects the red Light much more copiously than the *ultra* marine doth, and the *ultra* marine reflects the blue Light much more copiously than the Cinnaber doth. The same Experiment may be tryed successfully with red Lead and Indico, or with any other two coloured Bodies, if due allowance be made for the different strength or weakness of their Colour and Light.

And as the reason of the Colours of natural Bodies is evident by these Experiments, so it is further confirmed and put past dispute by the two first Experiments of the first Book, whereby 'twas proved in such Bodies that the reflected Light which differ in Colours do differ also in degrees of refrangibility. For thence it's certain, that some Bodies reflect the more refrangible, others the less refrangible rays more copiously.

And

And that this is not only a true reason of these Colours, but even the only reason may appear further from this consideration, that the Colour of homogeneous Light cannot be changed by the reflexion of natural Bodies.

For if Bodies by reflexion cannot in the least change the Colour of any one sort of rays, they cannot appear coloured by any other means than by reflecting those which either are of their own Colour, or which by mixture must produce it.

But in trying Experiments of this kind care must be had that the Light be sufficiently homogeneous. For if Bodies be illuminated by the ordinary prismatic Colours, they will appear neither of their own day-light Colours, nor of the Colour of the Light cast on them, but of some middle Colour between both, as I have found by Experience. Thus red Lead (for instance) illuminated with the ordinary prismatic green will not appear either red or green, but orange or yellow, or between yellow and green accordingly, as the green Light by which 'tis illuminated is more or less compounded. For because red Lead appears red when illuminated with white Light, wherein all sorts of rays are equally mixed, and in the green Light all sorts of rays are not equally mixed, the excess of the yellow-making, green-making and blue-making rays in the incident green Light, will cause those rays to abound so much in the reflected Light as to draw the Colour from red towards their Colour. And because the red Lead reflects the red-making rays most copiously in proportion to their number, and next after them the orange-making and yellow-making rays; these rays in
S
the

the reflected Light will be more in proportion to the Light than they were in the incident green Light, and thereby will draw the reflected Light from green towards their Colour. And therefore the red Lead will appear neither red nor green, but of a Colour between both.

In transparently coloured Liquors 'tis observable, that their Colour uses to vary with their thickness. Thus, for instance, a red Liquor in a conical Glass held between the Light and the Eye, looks of a pale and dilute yellow at the bottom where 'tis thin, and a little higher where 'tis thicker grows orange, and where 'tis still thicker becomes red, and where 'tis thickest the red is deepest and darkest. For it is to be conceived that such a Liquor stops the indico-making and violet-making rays most easily, the blue-making rays more difficultly, the green-making rays still more difficultly, and the red-making most difficultly: And that if the thickness of the Liquor be only so much as suffices to stop a competent number of the violet-making and indico-making rays, without diminishing much the number of the rest, the rest must (by Prop. 6. *Lib. 2.*) compound a pale yellow. But if the Liquor be so much thicker as to stop also a great number of the blue-making rays, and some of the green-making, the rest must compound an orange; and where it is so thick as to stop also a great number of the green-making and a considerable number of the yellow-making, the rest must begin to compound a red, and this red must grow deeper and darker as the yellow making and orange-making rays are more and more stopt by increasing the thickness of the Liquor, so that few rays besides the red-making can get through.

Of this kind is an Experiment lately related to me by Mr. *Halley*, who, in diving deep into the Sea, found in a clear Sun-shine day, that when he was sunk many Fathoms deep into the Water, the upper part of his Hand in which the Sun shone directly through the Water looked of a red Colour, and the under part of his Hand illuminated by Light reflected from the Water below looked green. For thence it may be gathered, that the Sea-water reflects back the violet and blue-making rays most easily, and lets the red-making rays pass most freely and copiously to great depths. For thereby the Sun's direct Light at all great depths, by reason of the predominating red-making rays, must appear red; and the greater the depth is, the fuller and intenser must that red be. And at such depths as the violet-making rays scarce penetrate unto, the blue-making, green-making and yellow-making rays being reflected from below more copiously than the red-making ones, must compound a green.

Now if there be two Liquors of full Colours, suppose a red and a blue, and both of them so thick as suffices to make their Colours sufficiently full; though either Liquor be sufficiently transparent apart, yet will you not be able to see through both together. For if only the red-making rays pass through one Liquor, and only the blue-making through the other, no rays can pass through both. This Mr. *Hook* tried casually with Glass-wedges filled with red and blue Liquors, and was surprized at the unexpected event, the reason of it being then unknown; which makes me trust the more to his Experiment, though I have not tryed it my self. But he that would repeat it, must take care the Liquors be of very good and full Colours.

Now whilst Bodies become coloured by reflecting or transmitting this or that sort of rays more copiously than the rest, it is to be conceived that they stop and stifle in themselves the rays which they do not reflect or transmit. For if Gold be foliated and held between your Eye and the Light, the Light looks blue, and therefore massy Gold lets into its Body the blue-making rays to be reflected to and fro within it till they be stopt and stifled, whilst it reflects the yellow-making outwards, and thereby looks yellow. And much after the same manner that Leaf-gold is yellow by reflected, and blue by transmitted Light, and massy Gold is yellow in all positions of the Eye; there are some Liquors as the tincture of *Lignum Nepbriticum*, and some sorts of Glass which transmit one sort of Light most copiously, and reflect another sort, and thereby look of several Colours, according to the position of the Eye to the Light. But if these Liquors or Glasses were so thick and massy that no Light could get through them, I question not but that they would like all other opake Bodies appear of one and the same Colour in all positions of the Eye, though this I cannot yet affirm by experience. For all coloured Bodies, so far as my Observation reaches, may be seen through if made sufficiently thin, and therefore are in some measure transparent, and differ only in degrees of transparency from tinged transparent Liquors; these Liquors, as well as those Bodies, by a sufficient thickness becoming opake. A transparent Body which looks of any Colour by transmitted Light, may also look of the same Colour by reflected Light, the Light of that Colour being reflected by the further surface of the Body, or by the Air beyond it. And then the reflected Colour will be diminished, and perhaps cease, by
making.

making the Body very thick, and pitching it on the back-side to diminish the reflexion of its further surface, so that the Light reflected from the tinging particles may predominate. In such cases, the Colour of the reflected Light will be apt to vary from that of the Light transmitted. But whence it is that tinged Bodies and Liquors reflect some sort of rays, and intromit or transmit other sorts, shall be said in the next Book. In this Proposition I content my self to have put it past dispute, that Bodies have such Properties, and thence appear coloured.

PROP. XI. PROB. VI.

By mixing coloured Lights to compound a Beam of Light of the same Colour and Nature with a Beam of the Sun's direct Light, and therein to experience the truth of the foregoing Propositions.

Let ABCabc represent a Prism by which the Sun's *Fig. 16.* Light let into a dark Chamber through the Hole F, may be refracted towards the Lens MN, and paint upon it at p, q, r, s and t, the usual Colours violet, blue, green, yellow and red, and let the diverging rays by the refraction of this Lens converge again towards X, and there, by the mixture of all those their Colours, compound a white according to what was shewn above. Then let another Prism DEGdeg, parallel to the former, be placed at X, to refract that white Light upwards towards Y. Let the refracting Angles of the Prisms, and their distances from the Lens be equal, so that the rays which converged from the Lens towards X, and without refraction, would there have crossed and diverged again, may by the refraction of the second Prism be reduced.

reduced into Parallelism and diverge no more. For then those rays will recombine a Beam of white Light X Y. If the refracting Angle of either Prism be the bigger, that Prism must be so much the nearer to the Lens. You will know when the Prisms and the Lens are well set together by observing if the Beam of Light X Y which comes out of the second Prism be perfectly white to the very edges of the Light, and at all distances from the Prism continue perfectly and totally white like a Beam of the Sun's Light. For till this happens, the position of the Prisms and Lens to one another must be corrected, and then if by the help of a long Beam of Wood, as is represented in the Figure, or by a Tube, or some other such instrument made for that purpose, they be made fast in that situation, you may try all the same Experiments in this compounded Beam of Light X Y, which in the foregoing Experiments have been made in the Sun's direct Light. For this compounded Beam of Light has the same appearance, and is endowed with all the same Properties with a direct Beam of the Sun's Light, so far as my Observation reaches. And in trying Experiments in this Beam you may by stopping any of the Colours p, q, r, s and t, at the Lens, see how the Colours produced in the Experiments are no other than those which the rays had at the Lens before they entered the composition of this Beam: And by consequence that they arise not from any new modifications of the Light by refractions and reflexions, but from the various separations and mixtures of the rays originally endowed with their colour-making qualities.

So, for instance, having with a Lens $4\frac{1}{4}$ Inches broad, and two Prisms on either Hand $6\frac{1}{4}$ Feet distant from the Lens, made such a Beam of compounded Light: to
 examin

examin the reason of the Colours made by Prisms, I refracted this compounded Beam of Light XY with another Prism HIK kh, and thereby cast the usual prismatick Colours PQRS T upon the Paper LV placed behind. And then by stopping any of the Colours p, q, r, s, t, at the Lens, I found that the same Colour would vanish at the Paper. So if the purple P was stopped at the Lens, the purple P upon the Paper would vanish, and the rest of the Colours would remain unaltered, unless perhaps the blue, so far as some purple latent in it at the Lens might be separated from it by the following refractions. And so by intercepting the green upon the Lens, the green R upon the Paper would vanish, and so of the rest; which plainly shews, that as the white Beam of Light XY was compounded of several Lights variously coloured at the Lens, so the Colours which afterwards emerge out of it by new refractions are no other than those of which its whiteness was compounded. The refraction of the Prism HIK kh generates the Colours PQRS T upon the Paper, not by changing the colorific qualities of the rays, but by separating the rays which had the very same colorific qualities before they entered the composition of the refracted Beam white of Light XY. For otherwise the rays which were of one Colour at the Lens might be of another upon the Paper, contrary to what we find.

So again, to examin the reason of the Colours of natural Bodies, I placed such Bodies in the Beam of Light XY, and found that they all appeared there of those their own Colours which they have in Day-light, and that those Colours depend upon the rays which had the same Colours at the Lens before they entred the composition

tion of that Beam. Thus, for instance, Cinnaber illuminated by this Beam appears of the same red Colour as in Day-light ; and if at the Lens you intercept the green-making and blue-making rays, its redness will become more full and lively : But if you there intercept the red-making rays, it will not any longer appear red, but become yellow or green, or of some other Colour, according to the sorts of rays which you do not intercept. So Gold in this Light X Y appears of the same yellow Colour as in Day-light, but by intercepting at the Lens a due quantity of the yellow-making rays it will appear white like Silver (as I have tryed) which shews that its yellowness arises from the excess of the intercepted rays tinging that whiteness with their Colour when they are let pass. So the infusion of *Lignum Nephriticum* (as I have also tryed) when held in this Beam of Light X Y, looks blue by the reflected part of the Light, and yellow by the transmitted part of it, as when 'tis viewed in Day-light, but if you intercept the blue at the Lens the infusion will lose its reflected blue Colour, whilst its transmitted red remains perfect and by the loss of some blue-making rays wherewith it was allayed becomes more intense and full. And, on the contrary, if the red and orange-making rays be intercepted at Lens, the infusion will lose its transmitted red, whilst its blue will remain and become more full and perfect. Which shews, that the infusion does not tinge the rays with blue and yellow, but only transmit those most copiously which were red-making before, and reflects those most copiously which were blue-making before. And after the same manner may the reasons of other Phænomena be examined, by trying them in this artificial Beam of Light X Y.

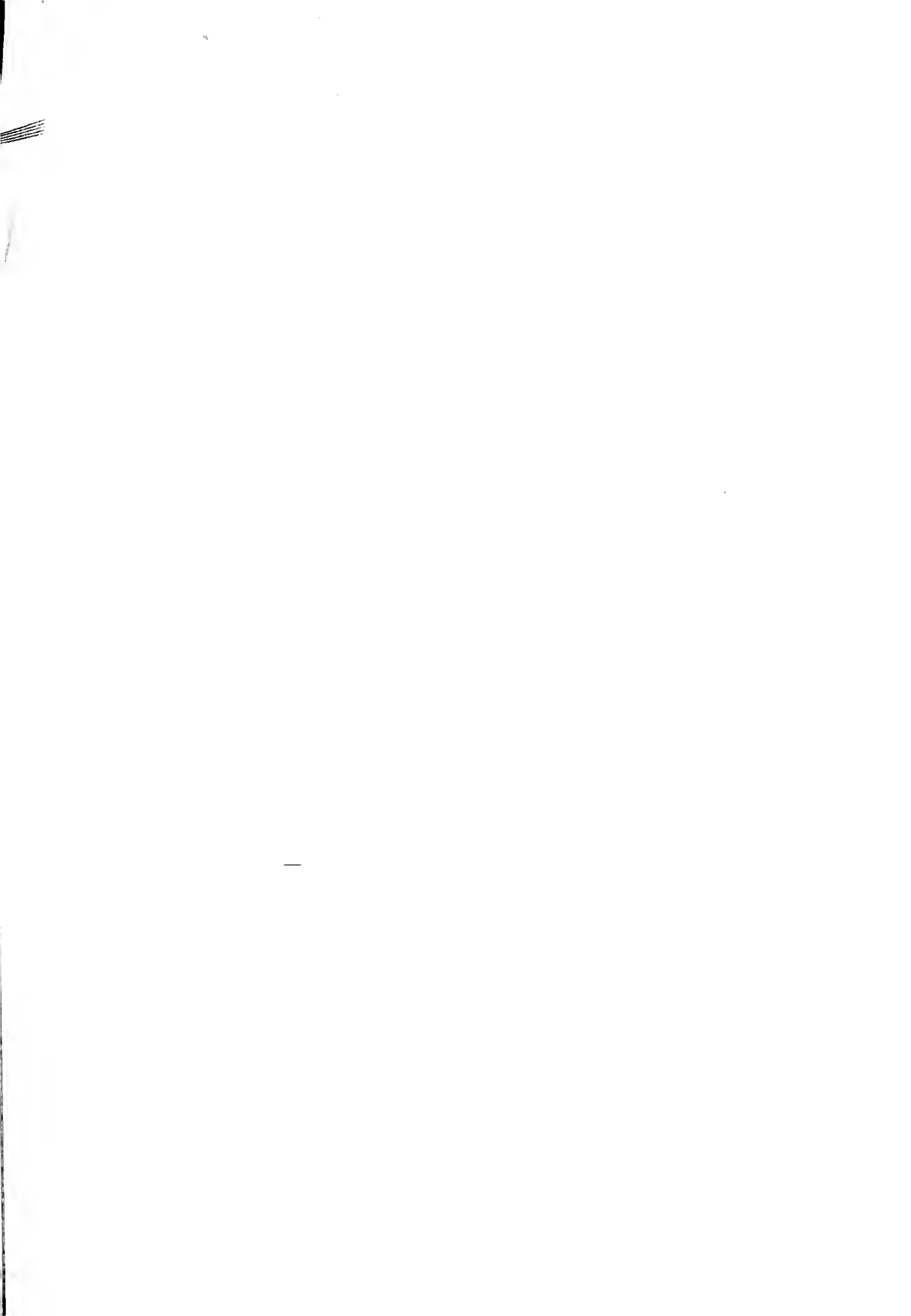

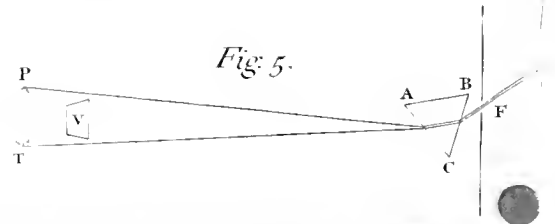
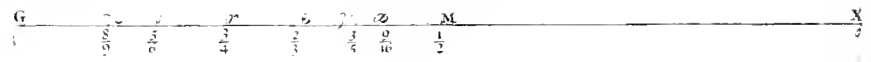
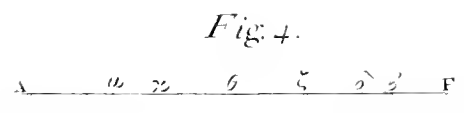
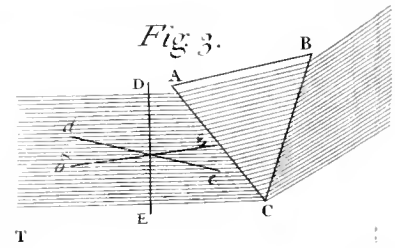
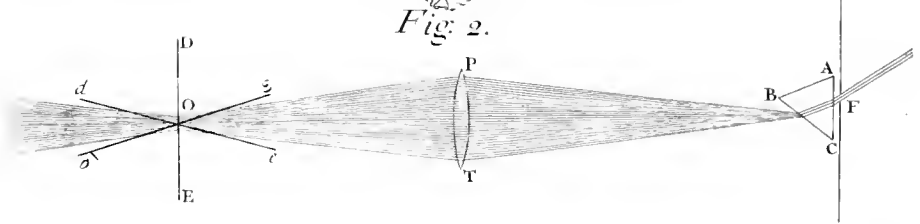
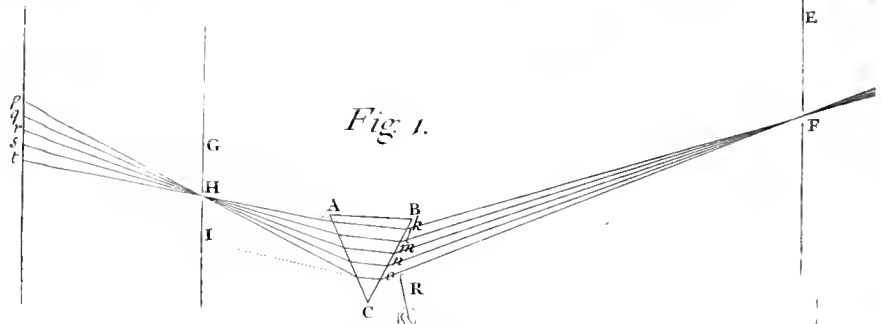



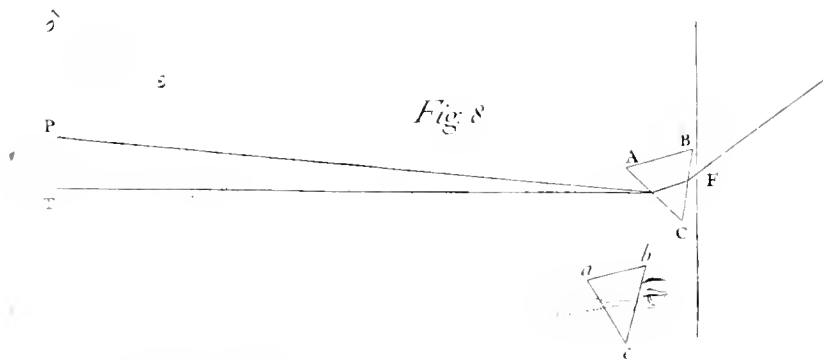
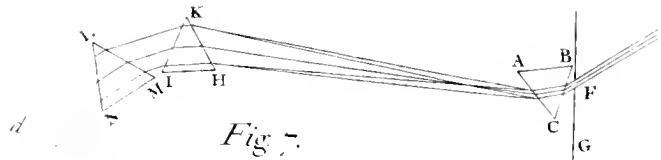
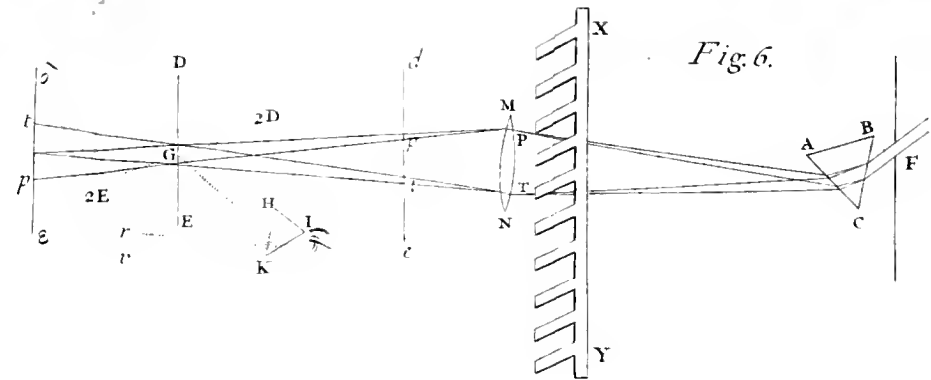

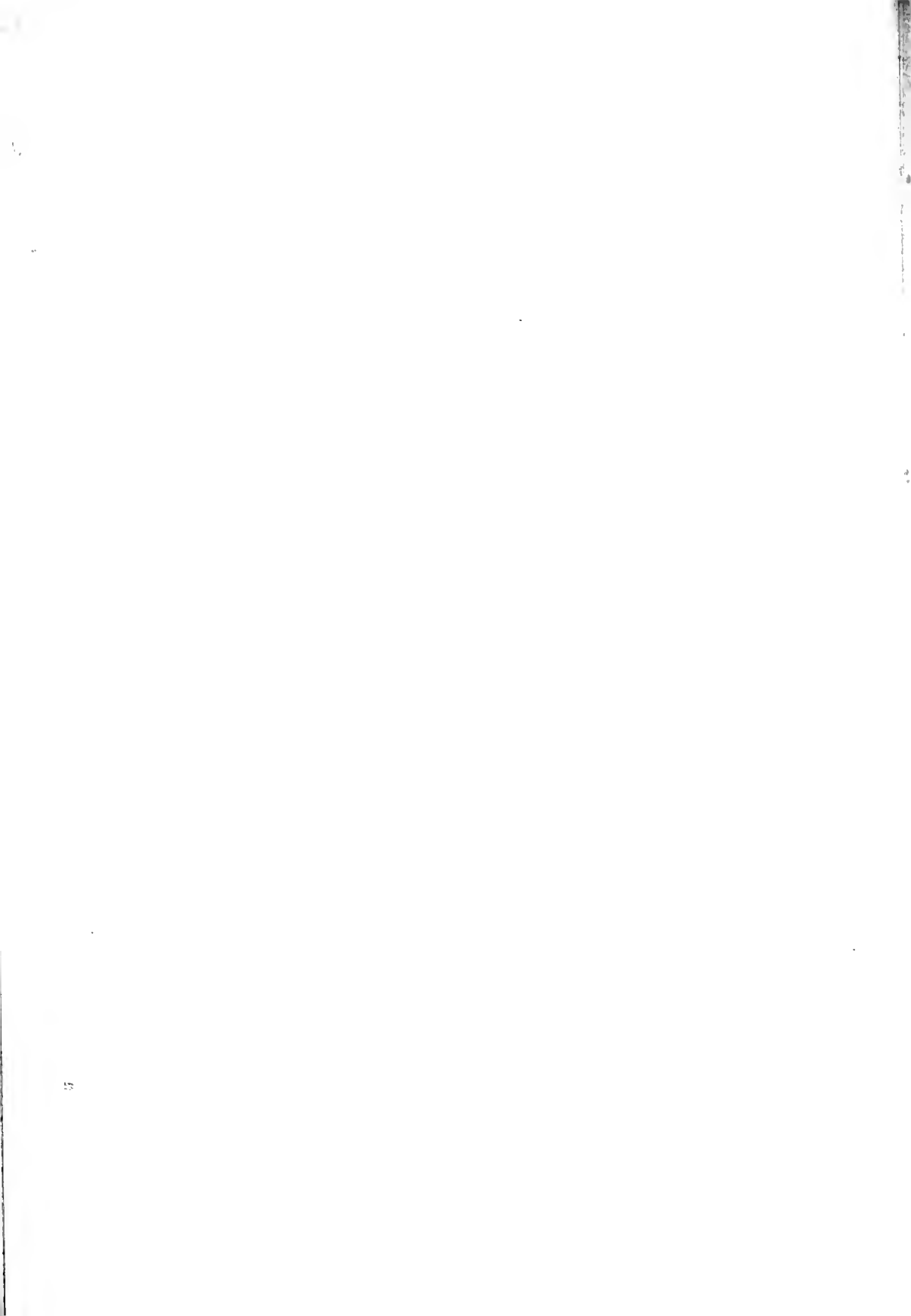



Fig. 9.

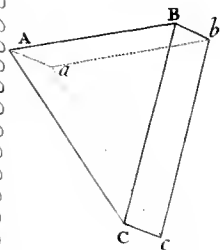
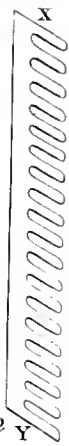
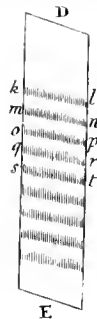

Fig. 10.

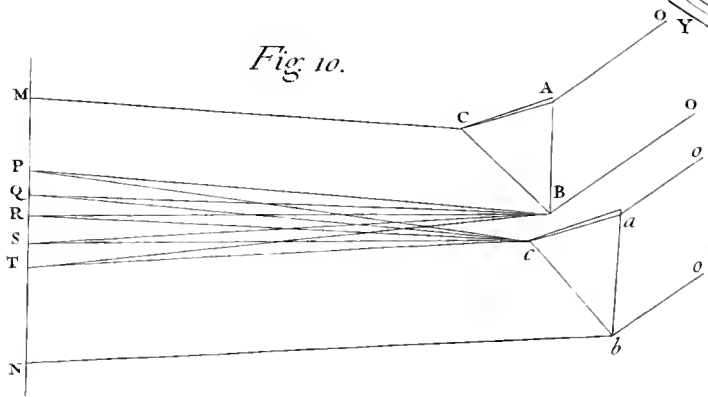

Fig. 11.

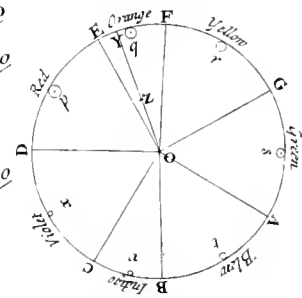
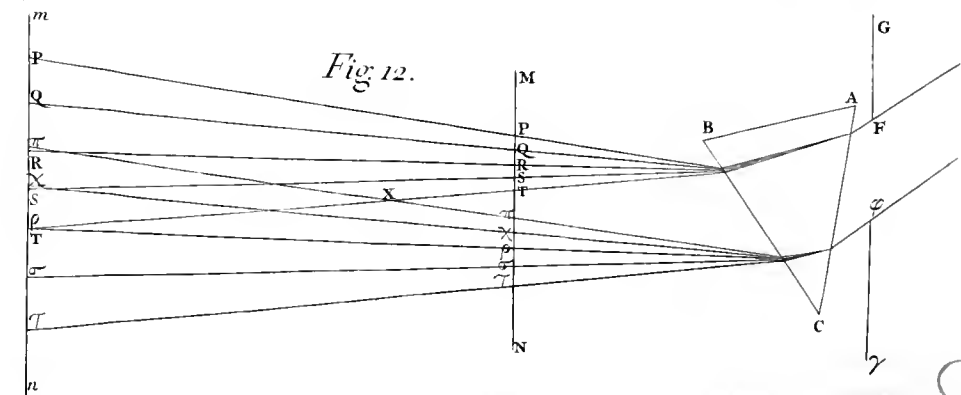

Fig. 12.





[1]

T H E

SECOND BOOK

O F

O P T I C K S.

P A R T I.

Observations concerning the Reflexions, Refractions, and Colours of thin transparent Bodies.

IT has been observed by others that transparent Substances, as Glass, Water, Air, &c. when made very thin by being blown into Bubbles, or otherwise formed into Plates, do exhibit various Colours according to their various thinness, although at a greater thickness they appear very clear and colourless. In the former Book I forbore to treat of these Colours, because they seemed of a more difficult consideration, and were not necessary for establishing the Properties of Light there discoursed of. But because they may conduce to further discoveries for completing the Theory of Light, especially as to the constitution of the parts of natural Bodies, on which their Colours or Transparency depend; I have here set down an account of them. To render this Discourse short and distinct, I have first described the principal of my

A a

Obser-

Observations, and then considered and made use of them. The Observations are these.

O B S. I.

Compressing two Prisms hard together that their Sides (which by chance were a very little convex) might somewhere touch one another: I found the place in which they touched to become absolutely transparent, as if they had there been one continued piece of Glass. For when the Light fell so obliquely on the Air, which in other places was between them, as to be all reflected; it seemed in that place of contact to be wholly transmitted, insomuch that when looked upon, it appeared like a black or dark Spot, by reason that little or no sensible Light was reflected from thence, as from other places; and when looked through it seemed (as it were) a hole in that Air which was formed into a thin Plate, by being compressed between the Glasses. And through this hole Objects that were beyond might be seen distinctly, which could not at all be seen through other parts of the Glasses where the Air was interjacent. Although the Glasses were a little convex, yet this transparent Spot was of a considerable breadth, which breadth seemed principally to proceed from the yielding inwards of the parts of the Glasses, by reason of their mutual pressure. For by pressing them very hard together it would become much broader than otherwise.

O B S. II.

When the Plate of Air, by turning the Prisms about their common Axis, became so little inclined to the incident Rays, that some of them began to be transmitted, there arose in it many slender Arcs of Colours which at first were shaped almost like the Conchoid, as you see them delineated in the first Figure. And *Fig. 1.* by continuing the motion of the Prisms, these Arcs increased and bended more and more about the said transparent Spot, till they were completed into Circles or Rings incompassing it, and afterwards continually grew more and more contracted.

These Arcs at their first appearance were of a violet and blue Colour, and between them were white Arcs of Circles, which presently by continuing the motion of the Prisms became a little tinged in their inward Limbs with red and yellow, and to their outward Limbs the blue was adjacent. So that the order of these Colours from the central dark Spot, was at that time white, blue, violet; black; red, orange, yellow, white, blue, violet, &c. But the yellow and red were much fainter than the blue and violet.

The motion of the Prisms about their Axis being continued, these Colours contracted more and more, shrinking towards the whiteness on either side of it, until they totally vanished into it. And then the Circles in those parts appeared black and white, without any other Colours intermixed. But by further moving the Prisms about, the Colours again emerged out of the whiteness, the violet and blue as its inward Limb, and at its out-

ward Limb the red and yellow. So that now their order from the central Spot was white, yellow, red ; black ; violet, blue, white, yellow, red, &c. contrary to what it was before.

O B S. III.

When the Rings or some parts of them appeared only black and white, they were very distinct and well defined, and the backness seemed as intense as that of the central Spot. Also in the borders of the Rings, where the Colours began to emerge out of the whiteness, they were pretty distinct, which made them visible to a very great Multitude. I have sometimes numbered above thirty Successions (reckoning every black and white Ring for one Succession) and seen more of them, which by reason of their smallness I could not number. But in other Positions of the Prisms, at which the Rings appeared of many Colours, I could not distinguish above eight or nine of them, and the exterior of those were very confused and dilute.

In these two Observations to see the Rings distinct, and without any other Colour than black and white, I found it necessary to hold my Eye at a good distance from them. For by approaching nearer, although in the same inclination of my Eye to the plane of the Rings, there emerged a blueish Colour out of the white, which by dilating it self more and more into the black rendered the Circles less distinct, and left the white a little tinged with red and yellow. I found also by looking through a slit or oblong hole, which was narrower than the Pupil of my Eye, and held close to
it.

it parallel to the Prisms, I could see the Circles much distincter and visible to a far greater number than otherwise.

O B S. IV.

To observe more nicely by the order of the Colours which arose out of the white Circles as the Rays became less and less inclined to the plate of Air; I took two Object Glasses, the one a Plano-convex for a fourteen-foot Telescope, and the other a large double convex for one of about fifty-foot; and upon this, laying the other with its its plane-side downwards, I pressed them slowly together, to make the Colours successively emerge in the middle of the Circles, and then slowly lifted the upper Glass from the lower to make them successively vanish again in the same place. The Colour, which by pressing the Glasses together emerged last in the middle of the other Colours, would upon its first appearance look like a Circle of a Colour almost uniform from the circumference to the center, and by compressing the Glasses still more, grow continually broader until a new Colour emerged in its center, and thereby it became a Ring encompassing that new Colour. And by compressing the Glasses still more, the Diameter of this Ring would encrease, and the breadth of its Orbit or Perimeter decrease until another new Colour emerged in the center of the last: And so on until a third, a fourth, a fifth, and other following new Colours successively emerged there, and became Rings encompassing the innermost Colour, the last of which was the black Spot. And, on the contrary, by
lifting

lifting up the upper Glafs from the lower, the diameter of the Rings would decrease, and the breadth of their Orbit encrease, until their Colours reached successively to the center ; and then they being of a considerable breadth, I could more easily discern and distinguish their Species than before. And by this means I observed their Succession and Quantity to be as followeth.

Next, to the pellucid central Spot made by the contact of the Glasses succeeded blue, white, yellow, and red, the blue was so little in quantity that I could not discern it in the circles made by the Prisms, nor could I well distinguish any violet in it, but the yellow and red were pretty copious, and seemed about as much in extent as the white, and four or five times more than the blue. The next Circuit in order of Colours immediately encompassing these were violet, blue, green, yellow, and red, and these were all of them copious and vivid, excepting the green, which was very little in quantity, and seemed much more faint and dilute than the other Colours. Of the other four, the violet was the least in extent, and the blue less than the yellow or red. The third Circuit or Order was purple, blue, green, yellow, and red ; in which the purple seemed more reddish than the violet in the former Circuit, and the green was much more conspicuous, being as brisk and copious as any of the other Colours, except the yellow ; but the red began to be a little faded, inclining very much to purple. After this succeeded the fourth Circuit of green and red. The green was very copious and lively, inclining on the one side to blue, and on the other side to yellow. But in
this

this fourth Circuit there was neither violet, blue, nor yellow, and the red was very imperfect and dirty. Also the succeeding Colours became more and more imperfect and dilute, till after three or four Revolutions they ended in perfect whiteness. Their Form, when the Glasses were most compressed so as to make the black Spot appear in the Center, is delineated in the Second Figure; where $a, b, c, d, e : f, g, h, i, k : l, m, n, o, p : q, r :$ *Fig. 2.*
 $s, t : v, x : y$ denote the Colours reck'ned in order from the center, black, blue, white, yellow, red : violet, blue, green, yellow, red : purple, blue, green, yellow, red : green, red : greenish blue, red : greenish blue, pale red : greenish blue, reddish white.

O B S. V.

To determine the interval of the Glasses, or thickness of the interjacent Air, by which each Colour was produced, I measured the Diameters of the first six Rings at the most lucid part of their Orbits, and squaring them, I found their Squares to be in the Arithmetical Progression of the odd Numbers, 1. 3. 5. 7. 9. 11. And since one of these Glasses was Plain, and the other Spherical, their Intervals at those Rings must be in the same Progression. I measured also the Diameters of the dark or faint Rings between the more lucid Colours, and found their Squares to be in the Arithmetical Progression of the even Numbers, 2. 4. 6. 8. 10. 12. And it being very nice and difficult to take these measures exactly; I repeated them at divers times at divers parts of the Glasses, that by their Agreement I might be confirmed in them. And the same Method I used in deter-

determining some others of the following Observations.

O B S. V I.

The Diameter of the sixth Ring at the most lucid part of its Orbit was $\frac{28}{100}$ parts of an Inch, and the Diameter of the Sphere on which the double convex Object-Glass was ground was about 102 Feet, and hence I gathered the thickness of the Air or Aereal Interval of the Glasses at that Ring. But some time after, suspecting that in making this Observation I had not determined the Diameter of the Sphere with sufficient accurateness, and being uncertain whether the Plano-convex Glass was truly plain, and not something concave or convex on that side which I accounted plain; and whether I had not pressed the Glasses together, as I often did, to make them touch (for by pressing such Glasses together their parts easily yield inwards, and the Rings thereby become sensibly broader than they would be, did the Glasses keep their Figures) I repeated the Experiment, and found the Diameter of the sixth lucid Ring about $\frac{25}{100}$ parts of an Inch. I repeated the Experiment also with such an Object-Glass of another Telescope as I had at hand. This was a double convex ground on both sides to one and the same Sphere, and its Focus was distant from it $83\frac{2}{3}$ Inches. And thence, if the Sines of incidence and refraction of the bright yellow Light be assumed in proportion as 11 to 17, the Diameter of the Sphere to which the Glass was figured will by computation be found 182 Inches. This Glass I laid upon a flat one, so that the
black

black Spot appeared in the middle of the Rings of Colours without any other pressure than that of the weight of the Glafs. And now measuring the Diameter of the fifth dark Circle as accurately as I could, I found it the fifth part of an Inch precisely. This measure was taken with the points of a pair of Compasses on the upper surface on the upper Glafs, and my Eye was about eight or nine Inches distance from the Glafs, almost perpendicularly over it, and the Glafs was $\frac{1}{2}$ of an Inch thick, and thence it is easy to collect that the true Diameter of the Ring between the Glasses was greater than its measured Diameter above the Glasses in the proportion of 80 to 79 or thereabouts, and by consequence equal to $\frac{16}{79}$ parts of an Inch, and its true Semi-diameter equal to $\frac{8}{79}$ parts. Now as the Diameter of the Sphere (182 Inches) is to the Semi-diameter of this fifth dark Ring ($\frac{8}{79}$ parts of an Inch) so is this Semi-diameter to the thickness of the Air at this fifth dark Ring; which is therefore $\frac{32}{57931}$ or $\frac{10}{1774534}$ parts of an Inch, and the fifth part thereof; *viz.* the $\frac{1}{88727}$ th part of an Inch, is the thickness of the Air at the first of these dark Rings.

The same Experiment I repeated with another double convex Object-glass ground on both sides to one and the same Sphere. Its Focus was distant from it $168\frac{1}{2}$ Inches, and therefore the Diameter of that Sphere was 184 Inches. This Glafs being laid upon the same plain Glafs, the Diameter of the fifth of the dark Rings, when the black Spot in their center appeared plainly without pressing the Glasses, was by the measure of the Compasses upon the upper Glafs $\frac{121}{600}$ parts of an Inch, and by consequence between the Glasses it was $\frac{1221}{6003}$. For the upper Glafs was $\frac{1}{2}$ of an Inch thick,

B b

and

and my Eye was distant from it 8 Inches. And a third proportional to half this from the Diameter of the Sphere is $\frac{5}{88850}$ parts of an Inch. This is therefore the thickness of the Air at this Ring, and a fifth part thereof, *viz.* the $\frac{1}{88850}$ th part of an Inch is the thickness thereof at the first of the Rings as above.

I tryed the same thing by laying these Object-Glasses upon flat pieces of a broken Looking-glass, and found the same measures of the Rings: Which makes me rely upon them till they can be determined more accurately by Glasses ground to larger Spheres, though in such Glasses greater care must be taken of a true plain.

These Dimensions were taken when my Eye was placed almost perpendicularly over the Glasses, being about an Inch, or an Inch and a quarter, distant from the incident rays, and eight Inches distant from the Glass; so that the rays were inclined to the Glass in an Angle of about 4 degrees. Whence by the following Observation you will understand, that had the rays been perpendicular to the Glasses, the thickness of the Air at these Rings would have been less in the proportion of the Radius to the secant of 4 degrees, that is of 10000. Let the thicknesses found be therefore diminished in this proportion, and they will become $\frac{1}{88940}$ and $\frac{1}{89003}$, or (to use the nearest round number) the $\frac{1}{89000}$ th part of an Inch. This is the thickness of the Air at the darkest part of the first dark Ring made by perpendicular rays, and half this thickness multiplied by the progression, 1, 3, 5, 7, 9, 11, &c. gives the thicknesses of the Air at the most luminous parts of all the brightest Rings, *viz.* $\frac{1}{178000}$, $\frac{3}{178000}$, $\frac{5}{178000}$, $\frac{7}{178000}$, &c. their arithmetical means

means $\frac{2}{178000}$, $\frac{4}{178000}$, $\frac{6}{178000}$, &c. being its thickneſſes at the darkeſt parts of all the dark ones.

O B S. VII.

The Rings were leaſt when my Eye was placed perpendicularly over the Glaſſes in the Axis of the Rings : And when I viewed them obliquely they became bigger, continually ſwelling as I removed my Eye further from the Axis. And partly by meaſuring the Diameter of the ſame Circle at ſeveral obliquities of my Eye, partly by other means, as alſo by making uſe of the two Priſms for very great obliquities. I found its Diameter, and conſequently the thickneſs of the Air at its perimeter in all thoſe obliquities to be very nearly in the proportions expreſſed in this Table.

<i>Angle of Incidence on the Air.</i>		<i>Angle of Refraction into the Air.</i>		<i>Diameter of the Ring.</i>	<i>Thickneſs of the Air.</i>
deg.	min.				
00	00	00	00	10	10
06	26	10	00	$10\frac{1}{13}$	$10\frac{2}{13}$
12	45	20	00	$10\frac{2}{3}$	$10\frac{2}{3}$
18	49	30	00	$10\frac{2}{4}$	$11\frac{1}{2}$
24	30	40	00	$11\frac{2}{5}$	13
29	37	50	00	$12\frac{1}{2}$	$15\frac{1}{2}$
33	58	60	00	14	20
35	47	65	00	$15\frac{1}{4}$	$23\frac{1}{4}$
37	19	70	00	$16\frac{4}{5}$	$28\frac{1}{4}$
38	33	75	00	$19\frac{1}{4}$	37
39	27	80	00	$22\frac{6}{7}$	$52\frac{1}{4}$
40	00	85	00	29	$84\frac{1}{10}$
40	11	90	00	35	$122\frac{1}{2}$

In the two first Columns are expressed the obliquities of the incident and emergent rays to the plate of the Air, that is, their angles of incidence and refraction. In the third Column the Diameter of any coloured Ring at those obliquities is expressed in parts, of which ten constitute that Diameter when the rays are perpendicular. And in the fourth Column the thickness of the Air at the circumference of that Ring is expressed in parts of which also ten constitute that thickness when the rays are perpendicular.

And from these measures I seem to gather this Rule : That the thickness of the Air is proportional to the secant of an angle, whose Sine is a certain mean proportional between the Sines of incidence and refraction. And that mean proportional, so far as by these measures I can determine it, is the first of an hundred and six arithmetical mean proportionals between those Sines counted from the Sine of refraction when the refraction is made out of the Glass into the plate of Air, or from the Sine of incidence when the refraction is made out of the plate of Air into the Glass.

O B S. VIII.

The dark Spot in the middle of the Rings increased also by the obliquation of the Eye, although almost insensibly. But if instead of the Object-Glasses the Prisms were made use of, its increase was more manifest when viewed so obliquely that no Colours appeared about it. It was least when the rays were incident most obliquely on the interjacent Air, and as the obliquity decreased it increased more and more until the coloured Rings appeared,

peared, and then decreased again, but not so much as it increased before. And hence it is evident, that the transparency was not only at the absolute contact of the Glasses, but also where they had some little interval. I have sometimes observed the Diameter of that Spot to be between half and two fifth parts of the Diameter of the exterior circumference of the red in the first circuit or revolution of Colours when viewed almost perpendicularly; whereas when viewed obliquely it hath wholly vanished and become opaque and white like the other parts of the Glass; whence it may be collected that the Glasses did then scarcely, or not at all, touch one another, and that their interval at the perimeter of that Spot when viewed perpendicularly was about a fifth or sixth part of their interval at the circumference of the said red.

O B S. IX.

By looking through the two contiguous Object-Glasses, I found that the interjacent Air exhibited Rings of Colours, as well by transmitting Light as by reflecting it. The central Spot was now white, and from it the order of the Colours were yellowish red; black; violet, blue, white, yellow, red; violet, blue, green, yellow, red, &c. But these Colours were very faint and dilute unless when the Light was trajected very obliquely through the Glasses: For by that means they became pretty vivid. Only the first yellowish red, like the blue in the fourth Observation, was so little and faint as scarcely to be discerned. Comparing the coloured Rings made by reflexion, with these made by trans-

transmission of the Light ; I found that white was opposite to black, red to blue, yellow to violet, and green to a compound of red and violet. That is, those parts of the Glafs were black when looked through, which when looked upon appeared white, and on the contrary. And so those which in one case exhibited blue, did in the other case exhibit red. And the like of the other Colours. The manner you have represented in the third Figure, where AB, CD, are the surfaces of the Glasses contiguous at E, and the black lines between them are their distances in arithmetical progression, and the Colours written above are seen by reflected Light, and those below by Light transmitted.

Fig. 3.

O B S. X.

Wetting the Object-Glasses a little at their edges, the water crept in slowly between them, and the Circles thereby became less and the Colours more faint : Infomuch that as the water crept along one half of them at which it first arrived would appear broken off from the other half, and contracted into a less room. By measuring them I found the proportions of their Diameters to the Diameters of the like Circles made by Air to be about seven to eight, and consequently the intervals of the Glasses at like Circles, caused by those two mediums Water and Air, are as about three to four. Perhaps it may be a general Rule, That if any other medium more or less dense than water be compressed between the Glasses, their intervals at the Rings caused thereby will be to their intervals caused by interjacent
Air,

Air, as the Sines are which measure the refraction made out of that medium into Air.

O B S. XI.

When the water was between the Glasses, if I pressed the upper Glass variously at its edges to make the Rings move nimbly from one place to another, a little white Spot would immediately follow the center of them, which upon creeping in of the ambient water into that place would presently vanish. Its appearance was such as interjacent Air would have caused, and it exhibited the same Colours. But it was not Air, for where any bubbles of Air were in the water they would not vanish. The reflexion must have rather been caused by a subtiler medium, which could recede through the Glasses at the creeping in of the water.

O B S. XII.

These Observations were made in the open Air. But further to examin the effects of coloured Light falling on the Glasses, I darkened the Room, and viewed them by reflexion of the Colours of a Prism cast on a Sheet of white Paper, my Eye being so placed that I could see the coloured Paper by reflexion in the Glasses, as in a Looking-glass. And by this means the Rings became distincter and visible to a far greater number than in the open Air. I have sometimes seen more than twenty of them, whereas in the open Air I could not discern above eight or nine.

O B S.

O B S. XIII.

Appointing an assistant to move the Prism to and fro about its Axis, that all the Colours might successively fall on that part of the Paper which I saw by reflexion from that part of the Glasses, where the Circles appeared, so that all the Colours might be successively reflected from the Circles to my Eye whilst I held it immovable, I found the Circles which the red Light made to be manifestly bigger than those which were made by the blue and violet. And it was very pleasant to see them gradually swell or contract according as the Colour of the Light was changed. The interval of the Glasses at any of the Rings when they were made by the utmost red Light, was to their interval at the same Ring when made by the utmost violet, greater than as 3 to 2, and less than as 13 to 8, by the most of my Observations it was as 14 to 9. And this proportion seemed very nearly the same in all obliquities of my Eye; unless when two Prisms were made use of instead of the Object-Glasses. For then at a certain great obliquity of my Eye, the Rings made by the several Colours seemed equal, and at a greater obliquity those made by the violet would be greater than the same Rings made by the red. The refraction of the Prism in this case causing the most refrangible rays to fall more obliquely on that plate of the Air than the least refrangible ones. Thus the Experiment succeeded in the coloured Light, which was sufficiently strong and copious to make the Rings sensible. And thence it may be gathered, that if the most refrangible and least refran-

refrangible rays had been copious enough to make the Rings sensible without the mixture of other rays, the proportion which here was 14 to 9 would have been a little greater, suppose $14\frac{1}{4}$ or $14\frac{1}{2}$ to 9.

O B S. XIV.

Whilst the Prism was turn'd about its Axis with an uniform motion, to make all the several Colours fall successively upon the Object-Glasses, and thereby to make the Rings contract and dilate: The contraction or dilation of each Ring thus made by the variation of its Colour was swiftest in the red, and slowest in the violet, and in the intermediate Colours it had intermediate degrees of celerity. Comparing the quantity of contraction and dilation made by all the degrees of each Colour, I found that it was greatest in the red; less in the yellow, still less in the blue, and least in the violet. And to make as just an estimation as I could of the proportions of their contractions or dilations, I observed that the whole contraction or dilation of the Diameter of any Ring made by all the degrees of red, was to that of the Diameter of the same Ring made by all the degrees of violet, as about four to three, or five to four, and that when the Light was of the middle Colour between yellow and green, the Diameter of the Ring was very nearly an arithmetical mean between the greatest Diameter of the same Ring made by the outmost red, and the least Diameter thereof made by the outmost violet: Contrary to what happens in the Colours of the oblong Spectrum made by the refraction of a Prism, where the red is most contracted, the violet most expanded, and

D d in

in the midst of all the Colours is the confine of green and blue. And hence I seem to collect that the thickneses of the Air between the Glasses there, where the Ring is successively made by the limits of the five principal Colours (red, yellow, green, blue, violet) in order (that is, by the extreme red, by the limit of red and yellow in the middle of the orange, by the limit of yellow and green, by the limit of green and blue, by the limit of blue and violet in the middle of the indigo, and by the extreme violet) are to one another very nearly as the six lengths of a Chord which found the notes in a sixth Major, *sol, la, mi, fa, sol, la*. But it agrees something better with the Observation to say, that the thickneses of the Air between the Glasses there, where the Rings are successively made by the limits of the seven Colours, red, orange, yellow, green, blue, indigo, violet in order, are to one another as the Cube-roots of the Squares of the eight lengths of a Chord, which found the notes in an eighth, *sol, la, fa, sol, la, mi, fa, sol*; that is, as the Cube-roots of the Squares of the Numbers, $1, \frac{8}{9}, \frac{5}{6}, \frac{3}{4}, \frac{2}{3}, \frac{3}{5}, \frac{9}{16}, \frac{1}{2}$.

O B S. XV.

These Rings were not of various Colours like those made in the open Air, but appeared all over of that prismatic Colour only with which they were illuminated. And by projecting the prismatic Colours immediately upon the Glasses, I found that the Light which fell on the dark Spaces which were between the coloured Rings, was transmitted through the Glasses without any variation of Colour. For on a
white

white Paper placed behind, it would paint Rings of the same Colour with those which were reflected, and of the bigness of their immediate Spaces. And from thence the origin of these Rings is manifest; namely, That the Air between the Glasses, according to its various thickness, is disposed in some places to reflect, and in others to transmit the Light of any one Colour (as you may see represented in the fourth Figure) *Fig. 4.* and in the same place to reflect that of one Colour where it transmits that of another.

O B S. XVI.

The Squares of the Diameters of these Rings made by any prismatic Colour were in arithmetical progression as in the fifth Observation. And the Diameter of the sixth Circle, when made by the citrine yellow, and viewed almost perpendicularly, was about $\frac{58}{100}$ parts of an Inch, or a little less, agreeable to the sixth Observation.

The precedent Observations were made with a rarer thin medium, terminated by a denser, such as was Air or Water compressed between two Glasses. In those that follow are set down the appearances of a denser medium thin'd within a rarer, such as are plates of Muscovy-glass, Bubbles of Water, and some other thin substances terminated on all sides with Air.

O B S. XVII.

If a Bubble be blown with Water first made tenacious by dissolving a little Soap in it, 'tis a common Observation, that after a while it will appear tinged with a great variety of Colours. To defend these Bubbles from being agitated by the external Air (whereby their Colours are irregularly moved one among another, so that no accurate Observation can be made of them,) as soon as I had blown any of them I covered it with a clear Glass, and by that means its Colours emerged in a very regular order, like so many concentrick Rings incompassing the top of the Bubble. And as the Bubble grew thinner by the continual subsiding of the Water, these Rings dilated slowly and over-spread the whole Bubble, descending in order to the bottom of it, where they vanished successively. In the mean while, after all the Colours were emerged at the top, there grew in the Center of the Rings a small round black Spot, like that in the first Observation, which continually dilated it self till it became sometimes more than $\frac{1}{2}$ or $\frac{3}{4}$ of an Inch in breadth before the Bubble broke. At first I thought there had been no Light reflected from the Water in that place, but observing it more curiously, I saw within it several smaller round Spots, which appeared much blacker and darker than the rest, whereby I knew that there was some reflexion at the other places which were not so dark as those Spots. And by further tryal I found that I could see the Images of some things (as of a Candle or the Sun) very faintly reflected, not only from the great black Spot, but also

also from the little darker Spots which were within it.

Besides the aforesaid coloured Rings there would often appear small Spots of Colours, ascending and descending up and down the sides of the Bubble, by reason of some inequalities in the subsiding of the Water. And sometimes small black Spots generated at the sides would ascend up to the larger black Spot at the top of the Bubble, and unite with it.

O B S. XVIII.

Because the Colours of these Bubbles were more extended and lively than those of the Air thin'd between two Glasses, and so more easy to be distinguished, I shall here give you a further description of their order, as they were observed in viewing them, by reflexion of the Skies when of a white Colour, whilst a black Substance was placed behind the Bubble. And they were these, red, blue; red, blue; red, blue; red, green; red, yellow, green, blue, purple; red, yellow, green, blue, violet; red, yellow, white, blue, black.

The three first Successions of red and blue were very dilute and dirty, especially the first, where the red seemed in a manner to be white. Among these there was scarce any other Colour sensible besides red and blue, only the blues (and principally the second blue) inclined a little to green.

The fourth red was also dilute and dirty, but not so much as the former three; after that succeeded little or no yellow, but a copious green, which at first inclined a little to yellow, and then became a pretty brisque
and

and good willow green, and afterwards changed to a bluish Colour; but there succeeded neither blue nor violet.

The fifth red at first inclined very much to purple, and afterwards became more bright and brisk, but yet not very pure. This was succeeded with a very bright and intense yellow, which was but little in quantity, and soon changed to green: But that green was copious and something more pure, deep and lively, than the former green. After that followed an excellent blue of a bright sky-colour, and then a purple, which was less in quantity than the blue, and much inclined to red.

The sixth Red was at first of a very fair and lively Scarlet, and soon after of a brighter Colour, being very pure and brisk, and the best of all the reds. Then after a lively orange followed an intense bright and copious yellow, which was also the best of all the yellows, and this changed first to a greenish yellow, and then to a greenish blue; but the green between the yellow and the blue, was very little and dilute, seeming rather a greenish white than a green. The blue which succeeded became very good, and of a very fair bright sky-colour, but yet something inferior to the former blue; and the violet was intense and deep with little or no redness in it. And less in quantity than the blue.

In the last red appeared a tincture of scarlet next to violet, which soon changed to a brighter Colour, inclining to an orange; and the yellow which followed was at first pretty good and lively, but afterwards it grew more dilute, until by degrees it ended in perfect
white-

whiteneſs. And this whiteneſs, if the Water was very tenacious and well-tempered, would ſlowly ſpread and dilate it ſelf over the greater part of the Bubble ; continually growing paler at the top, where at length it would crack in many places, and thoſe cracks, as they dilated, would appear of a pretty good, but yet obſcure and dark ſky-colour ; the white between the blue Spots diminiſhing, until it reſembled the threds of an irregular Net-work, and ſoon after vaniſhed and left all the upper part of the Bubble of the ſaid dark blue Colour. And this Colour, after the aforeſaid manner, dilated it ſelf downwards, until ſometimes it hath overſpread the whole Bubble. In the mean while at the top, which was of a darker blue than the bottom, and appeared alſo full of many round blue Spots, ſomething darker than the reſt, there would emerge one or more very black Spots, and within thoſe other Spots of an intenſer blackneſs, which I mentioned in the former Obſervation ; and theſe continually dilated themſelves until the Bubble broke.

If the Water was not very tenacious the black Spots would break forth in the white, without any ſenſible intervention of the blue. And ſometimes they would break forth within the precedent yellow, or red, or perhaps within the blue of the ſecond order, before the intermediate Colours had time to diſplay themſelves.

By this deſcription you may perceive how great an affinity theſe Colours have with thoſe of Air deſcribed in the fourth Obſervation, although ſet down in a contrary order, by reaſon that they begin to appear when the Bubble is thickeſt, and are moſt conveniently

niently reckoned from the lowest and thickest part of the Bubble upwards.

O B S. XIX.

Viewing in several oblique positions of my Eye the Rings of Colours emerging on the top of the Bubble, I found that they were sensibly dilated by increasing the obliquity, but yet not so much by far as those made by thin'd Air in the seventh Observation. For there they were dilated so much as, when viewed most obliquely, to arrive at a part of the plate more than twelve times thicker than that where they appeared when viewed perpendicularly; whereas in this case the thickness of the Water, at which they arrived when viewed most obliquely, was to that thickness which exhibited them by perpendicular rays, something less than as 8 to 5. By the best of my Observations it was between 15 and $15\frac{1}{2}$ to 10 , an increase about 24 times less than in the other case.

Sometimes the Bubble would become of an uniform thickness all over, except at the top of it near the black Spot, as I knew, because it would exhibit the same appearance of Colours in all positions of the Eye. And then the Colours which were seen at its apparent circumference by the obliquest rays, would be different from those that were seen in other places, by rays less oblique to it. And divers Spectators might see the same part of it of differing Colours, by viewing it at very differing obliquities. Now observing how much the Colours at the same places of the Bubble, or at divers places of equal thickness, were varied by the several

several obliquities of the rays ; by the assistance of the 4th, 14th, 16th and 18th Observations, as they are hereafter explained, I collect the thickness of the Water requisite to exhibit any one and the same Colour, at several obliquities, to be very nearly in the proportion expressed in this Table.

<i>Incidence on the Water.</i>		<i>Refraction in- to the Water.</i>		<i>Thickness of the Water.</i>
deg.	min.	deg.	min.	
00	00	00	00	10
15	00	11	11	$10\frac{1}{4}$
30	00	22	1	$10\frac{4}{5}$
45	00	32	2	$11\frac{4}{5}$
60	00	40	30	13
75	00	46	25	$14\frac{1}{2}$
90	00	48	35	$15\frac{1}{5}$

In the two first Columns are expressed the obliquities of the rays to the superficies of the Water, that is, their Angles of incidence and refraction. Where I suppose that the Sines which measure them are in round numbers as 3 to 4, though probably the dissolution of Soap in the Water, may a little alter its refractive Vertue. In the third Column the thickness of the Bubble, at which any one Colour is exhibited in those several obliquities, is expressed in parts, of which ten constitute that thickness when the rays are perpendicular.

I have sometimes observed, that the Colours which arise on polished Steel by heating it, or on Bell-metal, and some other metalline substances, when melted and

E e

poured

poured on the ground, where they may cool in the open Air, have, like the Colours of Water-bubbles, been a little changed by viewing them at divers obliquities, and particularly that a deep blue, or violet, when viewed very obliquely, hath been changed to a deep red. But the changes of these Colours are not so great and sensible as of those made by Water. For the Scoria or vitrified part of the Metal, which most Metals when heated or melted do continually protrude, and send out to their surface, and which by covering the Metals in form of a thin glassy skin, causes these Colours, is much denser than Water; and I find that the change made by the obliquation of the Eye is least in Colours of the densest thin substances.

O B S. XX.

As in the ninth Observation, so here, the Bubble, by transmitted Light, appeared of a contrary Colour to that which it exhibited by reflexion. Thus when the Bubble being looked on by the Light of the Clouds reflected from it, seemed red at its apparent circumference, if the Clouds at the same time, or immediately after, were viewed through it, the Colour at its circumference would be blue. And, on the contrary, when by reflected Light it appeared blue, it would appear red by transmitted Light.

O B S. XXI.

By wetting very thin plates of Muscovy-glass, whose thinness made the like Colours appear, the Colours became

became more faint and languid ; especially by wetting the plates on that side opposite to the Eye : But I could not perceive any variation of their species. So then the thickness of a plate requisite to produce any Colour, depends only on the density of the plate, and not on that of the ambient medium : And hence, by the 10th and 16th Observations, may be known the thickness which Bubbles of Water, or Plates of Muscovy-glass, or other substances, have at any Colour produced by them.

O B S. XXII.

A thin transparent Body, which is denser than its ambient medium, exhibits more brisk and vivid Colours than that which is so much rarer ; as I have particularly observed in the Air and Glass. For blowing Glass very thin at a Lamp-furnace, those plates encompassed with Air did exhibit Colours much more vivid than those of Air made thin between two Glasses.

O B S. XXIII.

Comparing the quantity of Light reflected from the several Rings, I found that it was most copious from the first or inmost, and in the exterior Rings became gradually less and less. Also the whiteness of the first Ring was stronger than that reflected from those parts of the thinner medium which were without the Rings ; as I could manifestly perceive by viewing at a distance the Rings made by the two Object-

Glasses; or by comparing two Bubbles of Water blown at distant times, in the first of which the whiteness appeared, which succeeded all the Colours, and in the other, the whiteness which preceded them all.

O B S. XXIV.

When the two Object-Glasses were lay'd upon one another, so as to make the Rings of the Colours appear, though with my naked Eye I could not discern above 8 or 9 of those Rings, yet by viewing them through a Prism I have seen a far greater multitude, insomuch that I could number more than forty, besides many others, that were so very small and close together, that I could not keep my Eye steady on them severally so as to number them, but by their extent I have sometimes estimated them to be more than a hundred. And I believe the Experiment may be improved to the discovery of far greater numbers. For they seem to be really unlimited, though visible only so far as they can be separated by the refraction, as I shall hereafter explain.

But it was but one side of these Rings, namely, that towards which the refraction was made, which by that refraction was rendered distinct, and the other side became more confused than when viewed by the naked Eye, insomuch that there I could not discern above one or two, and sometimes none of those Rings, of which I could discern eight or nine with my naked Eye. And their Segments or Arcs, which on the other side appeared so numerous, for the most part exceeded

exceeded not the third part of a Circle. If the Refraction was very great, or the Prism very distant from the Object-Glasses, the middle part of those Arcs became also confused, so as to disappear and constitute an even whiteness, whilst on either side their ends, as also the whole Arcs furthest from the center, became distincter than before, appearing in the form as you see them designed in the fifth Figure.

Fig. 5.

The Arcs, where they seemed distinctest, were only white and black successively, without any other Colours intermixed. But in other places there appeared Colours, whose order was inverted by the refraction in such manner, that if I first held the Prism very near the Object-Glasses, and then gradually removed it further off towards my Eye, the Colours of the 2d, 3d, 4th, and following Rings shrank towards the white that emerged between them, until they wholly vanished into it at the middle of the Arcs, and afterwards emerged again in a contrary order. But at the ends of the Arcs they retained their order unchanged.

I have sometimes so lay'd one Object-Glass upon the other, that to the naked Eye they have all over seemed uniformly white, without the least appearance of any of the coloured Rings; and yet by viewing them through a Prism, great multitudes of those Rings have discovered themselves. And in like manner plates of Muscovy-glass, and Bubbles of Glass blown at a Lamp-furnace, which were not so thin as to exhibit any Colours to the naked Eye, have through the Prism exhibited a great variety of them ranged irregularly up and down in the form of waves. And so
Bubbles

Bubbles of Water, before they began to exhibit their Colours to the naked Eye of a By-stander, have appeared through a Prism, girded about with many parallel and horizontal Rings; to produce which effect, it was necessary to hold the Prism parallel, or very nearly parallel to the Horizon, and to dispose it so that the rays might be refracted upwards.

THE

THE

SECOND BOOK

O F

OPTICKS.

PART II.

Remarks upon the foregoing Observations.

HAVING given my Observations of these Colours, before I make use of them to unfold the Causes of the Colours of natural Bodies, it is convenient that by the simplest of them, such as are the 2d, 3d, 4th, 9th, 12th, 18th, 20th, and 24th, I first explain the more expounded. And first to shew how the Colours in the fourth and eighteenth Observations are produced, let there be taken in any right line from the point Y, the lengths YA, YB, YC, YD, YE, YF, YG, YH, in proportion to one another, as the Cube-roots of the Squares of the numbers, $\frac{1}{2}$, $\frac{2}{16}$, $\frac{3}{27}$, $\frac{4}{64}$, $\frac{5}{125}$, $\frac{8}{64}$, 1, whereby the lengths of a musical Chord to sound all the Notes in an Eighth are represented; that is, in the proportion of the numbers 6300, 6814, 7114, 7631, 8255, 8855, 9243, 10000. And at the points A, B, C, D, E, F,

E, F, G, H, let perpendiculars $A_2, B_3, \&c.$ be erected, by whose intervals the extent of the several Colours set underneath against them, is to be represented. Then divide the line A_2 in such proportion as the numbers 1, 2, 3, 5, 6, 7, 9, 10, 11, $\&c.$ set at the points of division denote. And through those divisions from Y draw lines 1 I, 2 K, 3 L, 5 M, 6 N, 7 O, $\&c.$

Now if A_2 be supposed to represent the thickness of any thin transparent Body, at which the outmost violet is most copiously reflected in the first Ring, or Series of Colours, then by the 13th Observation H K, will represent its thickness, at which the utmost red is most copiously reflected in the same Series. Also by the 5th and 16th Observations, A_6 and H N will denote the thicknesses at which those extreme Colours are most copiously reflected in the second Series, and A_{10} and H Q the thicknesses, at which they are most copiously reflected in the third Series, and so on. And the thickness at which any of the intermediate Colours are reflected most copiously, will, according to the 14th Observation, be defined by the distance of the line A H from the intermediate parts of the lines 2 K, 6 N, 10 Q, $\&c.$ against which the names of those Colours are written below.

But further, to define the latitude of these Colours in each Ring or Series, let A_1 design the least thickness, and A_3 the greatest thickness, at which the extreme violet in the first Series is reflected, and let H I, and H L, design the like limits for the extreme red, and let the intermediate Colours be limited by the intermediate parts of the lines 1 I, and 3 L, against which the names of those Colours are written, and so on: But
yet

yet with this caution, that the reflections be supposed strongest at the intermediate Spaces, 2 K, 6 N, 10 Q, &c. and from thence to decrease gradually towards these limits, 1 I, 3 L, 5 M, 7 O, &c. on either side; where you must not conceive them to be precisely limited, but to decay indefinitely. And whereas I have assigned the same latitude to every Series, I did it, because although the Colours in the first Series seem to be a little broader than the rest, by reason of a stronger reflexion there, yet that inequality is so insensible as scarcely to be determined by Observation.

Now according to this description, conceiving that the rays originally of several Colours are by turns reflected at the Spaces 1 I L 3, 5 M O 7, 9 P R 11, &c. and transmitted at the Spaces A H I 1, 3 L M 5, 7 O P 9, &c. it is easy to know what Colour must in the open Air be exhibited at any thickness of a transparent thin body. For if a Ruler be applied parallel to A H, at that distance from it by which the thickness of the body is represented, the alternate Spaces 1 I L 3, 5 M O 7, &c. which it crosseth will denote the reflected original Colours, of which the Colour exhibited in the open Air is compounded. Thus if the constitution of the green in the third Series of Colours be desired, apply the Ruler as you see at $\pi \epsilon \sigma \phi$, and by its passing through some of the blue at π and yellow at σ , as well as through the green at ϵ , you may conclude that the green exhibited at that thickness of the body is principally constituted of original green, but not without a mixture of some blue and yellow.

By this means you may know how the Colours from the center of the Rings outward ought to succeed in order as they were described in the 4th and 18th Observations. For if you move the Ruler gradually from AH through all distances, having past over the first space which denotes little or no reflexion to be made by thinnest substances, it will first arrive at 1 the violet, and then very quickly at the blue and green, which together with that violet compound blue, and then at the yellow and red, by whose further addition that blue is converted into whiteness, which whiteness continues during the transit of the edge of the Ruler from I to 3, and after that by the successive deficiency of its component Colours, turns first to compound yellow, and then to red, and last of all the red ceaseth at L. Then begin the Colours of the second Series, which succeed in order during the transit of the edge of the Ruler from 5 to O, and are more lively than before, because more expanded and severed. And for the same reason, instead of the former white there intercedes between the blue and yellow a mixture of orange, yellow, green, blue and indico, all which together ought to exhibit a dilute and imperfect green. So the Colours of the third Series all succeed in order; first, the violet, which a little interferes with the red of the second order, and is thereby inclined to a reddish purple; then the blue and green, which are less mixed with other Colours, and consequently more lively than before, especially the green: Then follows the yellow, some of which towards the green is distinct and good, but that part of it towards the succeeding red, as also that red is mixed with the violet and blue of the fourth Series,

ries, whereby various degrees of red very much inclining to purple are compounded. This violet and blue, which should succeed this red, being mixed with, and hidden in it, there succeeds a green. And this at first is much inclined to blue, but soon becomes a good green, the only unmixed and lively Colour in this fourth Series. For as it verges towards the yellow, it begins to interfere with the Colours of the fifth Series, by whose mixture the succeeding yellow and red are very much diluted and made dirty, especially the yellow, which being the weaker Colour is scarce able to shew it self. After this the several Series interfere more and more, and their Colours become more and more intermixed, till after three or four more revolutions (in which the red and blue predominate by turns) all sorts of Colours are in all places pretty equally bended, and compound an even whiteness.

And since by the 15th Observation the rays indued with one Colour are transmitted, where those of another Colour are reflected, the reason of the Colours made by the transmitted Light in the 9th and 20th Observations is from hence evident.

If not only the order and species of these Colours, but also the precise thickness of the plate, or thin body at which they are exhibited, be desired in parts of an Inch, that may be also obtained by assistance of the 6th or 16th Observations. For according to those Observations the thickness of the thinned Air, which between two Glasses exhibited the most luminous parts of the first six Rings were $\frac{1}{178000}$, $\frac{3}{178000}$, $\frac{5}{178000}$, $\frac{7}{178000}$, $\frac{9}{178000}$, $\frac{11}{178000}$ parts of an Inch. Suppose the Light reflected most copiously at these thicknesses be the bright citrine yellow, or con-

fine of yellow and orange, and these thickneses will be $G\mu$, $G\nu$, $G\xi$, $G\sigma$, $G\gamma$. And this being known, it is easy to determine what thicknes of Air is represented by $G\tau$, or by any other distance of the ruler from A H.

But further, since by the 10th Observation the thicknes of Air was to the thicknes of Water, which between the same Glasse exhibited the same Colour, as 4 to 3, and by the 21th Observation the Colours of thin bodies are not varied by varying the ambient medium; the thicknes of a Bubble of Water, exhibiting any Colour, will be $\frac{3}{4}$ of the thicknes of Air producing the same Colour. And so according to the same 10th and 21th Observations the thicknes of a plate of Glasse, whose refraction of the mean refrangible ray, is measured by the proportion of the Sines 31 to 20, may be $\frac{20}{31}$ of the thicknes of Air producing the same Colours; and the like of other mediums. I do not affirm, that this proportion of 20 to 31, holds in all the rays; for the Sines of other sorts of rays have other proportions. But the differences of those proportions are so little that I do not here consider them. On these Grounds I have composed the following Table, wherein the thicknes of Air, Water, and Glasse, at which each Colour is most intense and specifick, is expressed in parts of an Inch divided into Ten hundred thousand equal parts.

The thickness of coloured Plates and Particles of

		Air.	Water.	Glass.
Their Colours of the first Order,	Very Black	$\frac{1}{2}$	$\frac{3}{8}$	$\frac{1}{3} \frac{1}{1}$
	Black	1	$\frac{1}{4}$	$\frac{2}{3} \frac{1}{1}$
	Beginning of Black	2	$1 \frac{1}{2}$	$1 \frac{2}{7}$
	Blue	$2 \frac{2}{5}$	$1 \frac{4}{5}$	$1 \frac{1}{2} \frac{1}{0}$
	White	$5 \frac{1}{4}$	$3 \frac{2}{8}$	$3 \frac{2}{5}$
	Yellow	$7 \frac{1}{9}$	$5 \frac{1}{3}$	$4 \frac{1}{5} \frac{1}{0}$
	Orange	8	6	$5 \frac{1}{6}$
	Red	9	$6 \frac{1}{4}$	$5 \frac{4}{5}$
	Of the second Order,	Violet	$11 \frac{1}{6}$	$8 \frac{1}{8}$
Indico		$12 \frac{1}{6}$	$9 \frac{1}{8}$	$8 \frac{1}{1} \frac{1}{1}$
Blue		14	$10 \frac{1}{2}$	9
Green		$15 \frac{1}{8}$	$11 \frac{1}{3}$	$9 \frac{1}{7}$
Yellow		$16 \frac{2}{7}$	$12 \frac{1}{5}$	$10 \frac{2}{5}$
Orange		$17 \frac{2}{9}$	13	$11 \frac{1}{9}$
Bright Red		$18 \frac{1}{3}$	$13 \frac{1}{4}$	$11 \frac{1}{6}$
Scarlet		$19 \frac{2}{3}$	$14 \frac{1}{4}$	$12 \frac{1}{3}$
Of the third Order,		Purple	21	$15 \frac{1}{4}$
	Indico	$22 \frac{1}{10}$	$16 \frac{1}{7}$	$14 \frac{1}{4}$
	Blue	$23 \frac{2}{5}$	$17 \frac{1}{2} \frac{1}{0}$	$15 \frac{1}{7} \frac{1}{0}$
	Green	$25 \frac{1}{5}$	$18 \frac{9}{10}$	$16 \frac{1}{4}$
	Yellow	$27 \frac{1}{7}$	$20 \frac{1}{3}$	$17 \frac{1}{2}$
	Red	29	$21 \frac{1}{4}$	$18 \frac{1}{7}$
	Bluish Red	32	24	$20 \frac{2}{3}$
Of the fourth Order,	Bluish Green	34	$25 \frac{1}{2}$	22
	Green	$35 \frac{2}{7}$	$26 \frac{1}{2}$	$22 \frac{1}{4}$
	Yellowish Green	36	27	$23 \frac{2}{9}$
	Red	$40 \frac{1}{3}$	$30 \frac{1}{4}$	26
Of the fifth Order,	Greenish Blue	46	$34 \frac{1}{2}$	$29 \frac{2}{3}$
	Red	$52 \frac{1}{2}$	$39 \frac{2}{6}$	34
Of the sixth Order,	Greenish Blue	$58 \frac{3}{4}$	44	38
	Red	65	$48 \frac{3}{4}$	42
Of the seventh Order,	Greenish Blue	71	$53 \frac{1}{4}$	$45 \frac{1}{2}$
	Ruddy White	77	$57 \frac{3}{4}$	$49 \frac{1}{3}$

Now.

Now if this Table be compared with the 6th Scheme, you will there see the constitution of each Colour, as to its Ingredients, or the original Colours of which it is compounded, and thence be enabled to judge of its intenseness or imperfection; which may suffice in explication of the 4th and 18th Observations, unless it be further desired to delineate the manner how the Colours appear, when the two Object-Glasses are lay'd upon one another. To do which, let there be described a large Arc of a Circle, and a streight Line which may touch that Arc, and parallel to that Tangent several occult Lines, at such distances from it, as the numbers set against the several Colours in the Table denote. For the Arc, and its Tangent, will represent the superficies of the Glasses terminating the interjacent Air; and the places where the occult Lines cut the Arc will shew at what distances from the Center, or Point of contact, each Colour is reflected.

There are also other uses of this Table: For by its assistance the thickness of the Bubble in the 19th Observation was determined by the Colours which it exhibited. And so the bigness of the parts of natural Bodies may be conjectured by their Colours, as shall be hereafter shewn. Also, if two or more very thin plates be lay'd one upon another, so as to compose one plate equalling them all in thickness, the resulting Colour may be hereby determined. For instance, Mr. *Hook* in his *Miscrographia* observes, that a faint yellow plate of Muscovy-glass lay'd upon a blue one, constituted a very deep purple. The yellow of the first Order is a faint one, and the thickness of the plate exhibiting it, according to the Table is $4\frac{3}{4}$, to which add 9, the thickness

ness exhibiting blue of the second Order, and the sum will be $13\frac{2}{5}$, which is the thickness exhibiting the purple of the third Order.

To explain, in the next place, the Circumstances of the 2d and 3d Observations; that is, how the Rings of the Colours may (by turning the Prisms about their common Axis the contrary way to that expressed in those Observations) be converted into white and black Rings, and afterwards into Rings of Colours again, the Colours of each Ring lying now in an inverted order; it must be remembered, that those Rings of Colours are dilated by the obliquation of the rays to the Air which intercedes the Glasses, and that according to the Table in the 7th Observation, their dilatation or increase of their Diameter is most manifest and speedy when they are obliquest. Now the rays of yellow being more refracted by the first superficies of the said Air than those of red, are thereby made more oblique to the second superficies, at which they are reflected to produce the coloured Rings, and consequently the yellow Circle in each Ring will be more dilated than the red; and the excess of its dilatation will be so much the greater, by how much the greater is the obliquity of the rays, until at last it become of equal extent with the red of the same Ring. And for the same reason the green, blue and violet, will be also so much dilated by the still greater obliquity of their rays, as to become all very nearly of equal extent with the red, that is, equally distant from the center of the Rings. And then all the Colours of the same Ring must be coincident, and by their mixture exhibit a white Ring. And these white Rings must have black and dark Rings between them, because they do not spread

spread and interfere with one another as before. And for that reason also they must become distinct and visible to far greater Numbers. But yet the violet being obliquest will be something more dilated in proportion to its extent than the other Colours, and so very apt to appear at the exterior verges of the white.

Afterwards, by a greater obliquity of the rays, the violet and blue become more sensibly dilated than the red and yellow, and so being further removed from the center of the Rings, the Colours must emerge out of the white in an order contrary to that which they had before, the violet and blue at the exterior limbs of each Ring, and the red and yellow at the interior. And the violet, by reason of the greatest obliquity of its rays, being in proportion most of all expanded, will soonest appear at the exterior limb of each white Ring, and become more conspicuous than the rest. And the several Series of Colours belonging to the several Rings, will, by their unfolding and spreading, begin again to interfere, and thereby render the Rings less distinct, and not visible to so great numbers.

If instead of the Prisms the Object-glasses be made use of, the Rings which they exhibit become not white and distinct by the obliquity of the Eye, by reason that the rays in their passage through that Air which intercedes the Glasses are very nearly parallel to those Lines in which they were first incident on the Glasses, and consequently the rays indued with several Colours are not inclined one more than another to that Air, as it happens in the Prisms.

There is yet another circumstance of these Experiments to be considered, and that is why the black and white Rings

Rings which when viewed at a distance appear distinct, should not only become confus'd by viewing them near at hand, but also yield a violet Colour at both the edges of every white Ring. And the reason is, that the rays which enter the Eye at several parts of the Pupil, have several obliquities to the Glasses, and those which are most oblique, if consider'd apart, would represent the Rings bigger than those which are the least oblique. Whence the breadth of the perimeter of every white Ring is expanded outwards by the obliquest rays, and inwards by the least oblique. And this expansion is so much the greater by how much the greater is the difference of the obliquity; that is, by how much the Pupil is wider, or the Eye nearer to the Glasses. And the breadth of the violet must be most expanded, because the rays apt to excite a sensation of that Colour are most oblique to a second, or further superficies of the thin'd Air at which they are reflect'd, and have also the greatest variation of obliquity, which makes that Colour soonest emerge out of the edges of the white. And as the breadth of every Ring is thus augmented, the dark intervals must be diminished, until the neighbouring Rings become continuous, and are blended, the exterior first, and then those nearer the Center, so that they can no longer be distinguish'd apart, but seem to constitute an even and uniform whiteness.

Among all the Observations there is none accompanied with so odd circumstances as the 24th. Of those the principal are, that in thin plates, which to the naked Eye seem of an even and uniform transparent,

whiteness, without any terminations of shadows, the refraction of a Prism should make Rings of Colours appear, whereas it usually makes Objects appear coloured only there where they are terminated with shadows, or have parts unequally luminous; and that it should make those Rings exceedingly distinct and white, although it usually renders Objects confused and coloured. The cause of these things you will understand by considering, that all the Rings of Colours are really in the plate, when viewed with the naked Eye, although by reason of the great breadth of their circumferences they so much interfere and are blended together, that they seem to constitute an even whiteness. But when the rays pass through the Prism to the Eye, the orbits of the several Colours in every Ring are refracted, some more than others, according to their degrees of refrangibility: By which means the Colours on one side of the Ring (that is on one side of its Center) become more unfolded and dilated, and those on the other side more complicated and contracted. And where by a due refraction they are so much contracted, that the several Rings become narrower than to interfere with one another, they must appear distinct, and also white, if the constituent Colours be so much contracted as to be wholly coincident. But, on the other side, where the orbit of every Ring is made broader by the further unfolding of its Colours, it must interfere more with other Rings than before, and so become less distinct.

Fig. 7. To explain this a little further, suppose the concentric Circles A V, and B X, represent the red and violet of any order, which, together with the intermediate Colours,

Colours, constitute any one of these Rings. Now these being viewed through a Prism, the violet Circle $B X$, will by a greater refraction be further translated from its place than the red $A V$, and so approach nearer to it on that side, towards which the refractions are made. For instance, if the red be translated to av , the violet may be translated to $b x$, so as to approach nearer to it at x than before, and if the red be further translated to $a v$, the violet may be so much further translated to $b x$ as to convene with it at x , and if the red be yet further translated to αr , the violet may be still so much further translated to $\beta \xi$ as to pass beyond it at ξ , and convene with it at e and f . And this being understood not only of the red and violet, but of all the other intermediate Colours, and also of every revolution of those Colours, you will easily perceive how those of the same revolution or order, by their nearness at $x v$ and $r \xi$, and their coincidence at $x v$, e and f , ought to constitute pretty distinct Arcs of Circles, especially at $x v$, or at e and f , and that they will appear severally at $x v$, and at $x v$ exhibit whiteness by their coincidence; and again appear several at $r \xi$, but yet in a contrary order to that which they had before, and still retain beyond e and f . But, on the other side, at $a b$, $a b$, or $\alpha \beta$, these Colours must become much more confused by being dilated and spread so, as to interfere with those of other Orders. And the same confusion will happen at $r \xi$ between e and f , if the refraction be very great, or the Prism very distant from the Object-Glasses: In which case no parts of the Rings will be seen, save only two little Arcs at e and f , whose distance from one

another will be augmented by removing the Prism still further from the Object-Glasses: And these little Arcs must be distinctest and whitest at their middle, and at their ends, where they begin to grow confused they must be coloured. And the Colours at one end of every Arc must be in a contrary order to those at the other end, by reason that they cross in the intermediate white; namely their ends, which verge towards $r \xi$, will be red and yellow on that side next the Center, and blue and violet on the other side. But their other ends which verge from $r \xi$ will on the contrary be blue and violet on that side towards the Center, and on the other side red and yellow.

Now as all these things follow from the Properties of Light by a mathematical way of reasoning, so the truth of them may be manifested by Experiments. For in a dark room, by viewing these Rings through a Prism, by reflexion of the several prismatic Colours, which an assistant causes to move to and fro upon a Wall or Paper from whence they are reflected, whilst the Spectator's Eye, the Prism and the Object-Glasses (as in the 13th Observation) are placed steady: the position of the Circles made successively by the several Colours, will be found such, in respect of one another, as I have described in the Figures $abxv$, or $abxv$, or $\alpha \beta \xi \gamma$. And by the same method the truth of the Explications of other Observations may be examined.

By what hath been said the like Phænomena of Water, and thin plates of Glass may be understood. But in small fragments of those plates, there is this
further

further observable, that where they lye flat upon a Table and are turned about their Centers whilst they are viewed through a Prism, they will in some postures exhibit waves of various Colours, and some of them exhibit these waves in one or two positions only, but the most of them do in all positions exhibit them, and make them for the most part appear almost all over the plates. The reason is, that the superficies of such plates are not even, but have many cavities and swellings, which how shallow soever do a little vary the thickness of the plate. For at the several sides of those cavities, for the reasons newly described, there ought to be produced waves in several postures of the Prism. Now though it be but some very small, and narrower parts of the Glass, by which these waves for the most part are caused, yet they may seem to extend themselves over the whole Glass, because from the narrowest of those parts there are Colours of several Orders that is of several Rings, confusedly reflected, which by refraction of the Prism are unfolded, separated, and according to their degrees of refraction, dispersed to several places, so as to constitute so many several waves, as there were divers orders of Colours promiscuously reflected from that part of the Glass.

These are the principal Phænomena of thin Plates or Bubbles, whose explications depend on the properties of Light, which I have heretofore delivered. And these you see do necessarily follow from them, and agree with them, even to their very least circumstances; and not only so, but do very much tend to their proof: Thus, by the 24th Observation, it appears, that the
rays

rays of several Colours made as well by thin Plates or Bubbles, as by refractions of a Prism, have several degrees of refrangibility, whereby those of each order, which at their reflexion from the Plate or Bubble are intermixed with those of other orders, are separated from them by refraction, and associated together so as to become visible by themselves like Arcs of Circles. For if the rays were all alike refrangible, 'tis impossible that the whiteness, which to the naked sense appears uniform, should by refraction have its parts transposed and ranged into those black and white Arcs.

It appears also that the unequal refractions of different rays proceed not from any contingent irregularities; such as are veins, an uneven polish, or fortuitous position of the pores of Glass; unequal and casual motions in the Air or Æther; the spreading, breaking, or dividing the same ray into many diverging parts, or the like. For, admitting any such irregularities, it would be impossible for refractions to render those Rings so very distinct, and well defined, as they do in the 24th Observation. It is necessary therefore that every ray have its proper and constant degree of refrangibility connate with it, according to which its refraction is ever justly and regularly performed, and that several rays have several of those degrees.

And what is said of their refrangibility may be also understood of their reflexibility, that is of their dispositions to be reflected some at a greater, and others at a less thickness, of thin Plates or Bubbles, namely, that those dispositions are also connate with the rays, and immutable; as may appear by the 13th, 14th, and
15th

15th Observations compared with the fourth and eighth.

By the precedent Observations it appears also, that whiteness is a dissimilar mixture of all Colours, and that Light is a mixture of rays indued with all those Colours. For considering the multitude of the Rings of Colours, in the 3d, 12th and 24th Observations, it is manifest that although in the 4th and 18th Observations there appear no more than eight or nine of those Rings, yet there are really a far greater number, which so much interfere and mingle with one another, as after those eight or nine revolutions to dilute one another wholly, and constitute an even and sensibly uniform whiteness. And consequently that whiteness must be allowed a mixture of all Colours, and the Light which conveys it to the Eye must be a mixture of rays indued with all those Colours.

But further, by the 24th Observation, it appears, that there is a constant relation between Colours and Refrangibility, the most refrangible rays being violet, the least refrangible red, and those of intermediate Colours having proportionably intermediate degrees of refrangibility. And by the 13th, 14th and 15th Observations, compared with the 4th or 18th, there appears to be the same constant relation between Colour and Reflexibility, the violet being in like circumstances reflected at least thicknesses of any thin Plate or Bubble, the red at greatest thicknesses, and the intermediate Colours at intermediate thicknesses. Whence it follows, that the colorifique dispositions of rays are also connate with them and immutable, and by consequence that

that all the productions and appearances of Colours in the World are derived not from any physical change caused in Light by refraction or reflexion, but only from the various mixtures or separations of rays, by virtue of their different Refrangibility or Reflexibility. And in this respect the Science of Colours becomes a Speculation as truly mathematical as any other part of Optiques. I mean so far as they depend on the nature of Light, and are not produced or altered by the power of imagination, or by striking or pressing the Eyes.

THE

T H E

SECOND BOOK

O F

O P T I C K S.

P A R T III.

Of the permanent Colours of natural Bodies, and the Analogy between them and the Colours of thin transparent Plates.

I Am now come to another part of this Design, which is to consider how the Phænomena of thin transparent Plates stand related to those of all other natural Bodies. Of these Bodies I have already told you that they appear of divers Colours, accordingly as they are disposed to reflect most copiously the rays originally indued with those Colours. But their Constitutions, whereby they reflect some rays more copiously than others, remains to be discovered, and these I shall endeavour to manifest in the following Propositions.

H h

PROP.

P R O P. I.

Those superficies of transparent Bodies reflect the greatest quantity of Light, which have the greatest refracting power; that is, which intercede mediums that differ most in their refractive densities. And in the confines of equally refracting mediums there is no reflexion.

The Analogy between reflexion and refraction will appear by considering, that when Light passeth obliquely out of one medium into another which refracts from the perpendicular, the greater is difference of their refractive density, the less obliquity is requisite to cause a total reflexion. For as the Sines are which measure the refraction, so is the Sine of incidence at which the total reflexion begins, to the radius of the Circle, and consequently that incidence is least where there is the greatest difference of the Sines. Thus in the passing of Light out of Water into Air, where the refraction is measured by the Ratio of the Sines 3 to 4, the total reflexion begins when the Angle of incidence is about 48 degrees 35 minutes. In passing out of Glass into Air, where the refraction is measured by the Ratio of the Sines 20 to 31, the total reflexion begins when the Angle of incidence is 40 deg. 10 min. and so in passing out of crystal, or more strongly refracting mediums into Air, there is still a less obliquity requisite to cause a total reflexion. Superficies therefore which refract most do soonest reflect all the Light which is incident on them, and so must be allowed most strongly reflexive.

But

But the truth of this Proposition will further appear by observing, that in the superficies interceding two transparent mediums, such as are (Air, Water, Oyl, Common-Glass, Crystal, Metalline-Glasses, Island-Glasses, white transparent Arfnick, Diamonds, &c.) the reflexion is stronger or weaker accordingly, as the superficies hath a greater or less refracting power. For in the confine of Air and Sal-gemm 'tis stronger than in the confine of Air and Water, and still stronger in the confine of Air and Common-Glass or Crystal, and stronger in the confine of Air and a Diamond. If any of these, and such like transparent Solids, be immersed in Water, its reflexion becomes much weaker than before, and still weaker if they be immersed in the more strongly refracting Liquors of well-rectified oyl of Vitriol or Spirit of Turpentine. If Water be distinguished into two parts, by any imaginary surface, the reflexion in the confine of those two parts is none at all. In the confine of Water and Ice 'tis very little, in that of Water and Oyl 'tis something greater, in that of Water and Sal-gemm still greater, and in that of Water and Glass, or Crystal, or other denser substances still greater, accordingly as those mediums differ more or less in their refracting powers. Hence in the confine of Common-Glass and Crystal, there ought to be a weak reflexion, and a stronger reflexion in the confine of Common and Metalline-Glass, though I have not yet tried this. But, in the confine of two Glasses of equal density, there is not any sensible reflexion, as was shewn in the first Observation. And the same may be understood of the superficies interceding two Crystals, or two Liquors, or any other Substances in which no refraction is caused. So then the

reason why uniform pellucid mediums, (such as Water, Glafs, or Crystal) have no sensible reflexion but in their external superficies, where they are adjacent to other mediums of a different density, is because all their contiguous parts have one and the same degree of density.

P R O P. II.

The least parts of almost all natural Bodies are in some measure transparent: And the opacity of those Bodies ariseth from the multitude of reflexions caused in their internal Parts.

That this is so has been observed by others, and will easily be granted by them that have been conversant with Microscopes. And it may be also tryed by applying any substance to a Hole through which some Light is immitted into a dark room. For how opaque soever that substance may seem in the open Air, it will by that means appear very manifestly transparent, if it be of a sufficient thinness. Only white metalline Bodies must be excepted, which by reason of their excessive density seem to reflect almost all the Light incident on their first superficies, unless by solution in menstruums they be reduced into very small particles, and then they become transparent.

P R O P. III.

Between the parts of opaque and coloured Bodies are many spaces, either empty or replenished, with mediums of other densities; as Water between the tinging corpuscles wherewith any Liquor is impregnated, Air between the
aqueous

aqueous globules that constitute Clouds or Mists ; and for the most part spaces void of both Air and Water, but yet perhaps not wholly void of all substance, between the parts of hard Bodies.

The truth of this is evinced by the two precedent Propositions : For by the second Proposition there are many reflexions made by the internal parts of Bodies, which, by the first Proposition, would not happen if the parts of those Bodies were continued without any such interstices between them, because reflexions are caused only in superficies, which intercede mediums of a differing density by Prop. 1.

But further, that this discontinuity of parts is the principal cause of the opacity of Bodies, will appear by considering, that opaque substances become transparent by filling their pores with any substance of equal or almost equal density with their parts. Thus Paper dipped in Water or Oyl, the *Oculus mundi* Stone steep'd in Water, Linnen-cloth oyled or varnished, and many other substances soaked in such Liquors as will intimately pervade their little pores, become by that means more transparent than otherwise ; so, on the contrary, the most transparent substances may by evacuating their pores, or separating their parts, be rendred sufficiently opaque, as Salts or wet Paper, or the *Oculus mundi* Stone by being dried, Horn by being scraped, Glass by being reduced to powder, or otherwise flawed, Turpentine by being stirred about with Water till they mix imperfectly, and Water by being formed into many small Bubbles, either alone in the form of froth, or by shaking it together with Oyl of Turpentine, or with some other convenient Liquor, with which it will
not

not perfectly incorporate. And to the increase of the opacity of these Bodies it conduces something, that by the 23th Observation the reflexions of very thin transparent substances are considerably stronger than those made by the same substances of a greater thickness.

P R O P. IV.

The parts of Bodies and their Interstices must not be less than of some definite bigness, to render them opake and coloured.

For the opakest Bodies, if their parts be subtilly divided, (as Metals by being dissolved in acid menstruums, &c.) become perfectly transparent. And you may also remember, that in the eighth Observation there was no sensible reflexion at the superficies of the Object-Glasses where they were very near one another, though they did not absolutely touch. And in the 17th Observation the reflexion of the Water-bubble where it became thinnest was almost insensible, so as to cause very black Spots to appear on the top of the Bubble by the want of reflected Light.

On these grounds I perceive it is that Water, Salt, Glass, Stones, and such like substances, are transparent. For, upon divers considerations, they seem to be as full of pores or interstices between their parts as other Bodies are, but yet their parts and interstices to be too small to cause reflexions in their common surfaces.

P R O P.

P R O P. V.

The transparent parts of Bodies according to their several sizes must reflect rays of one Colour, and transmit those of another, on the same grounds that thin Plates or Bubbles do reflect or transmit those rays. And this I take to be the ground of all their Colours.

For if a thin'd or plated Body, which being of an even thickness, appears all over of one uniform Colour, should be slit into threds, or broken into fragments, of the same thickness with the plate; I see no reason why every thred or fragment should not keep its Colour, and by consequence why a heap of those threds or fragments should not constitute a mass or powder of the same Colour, which the plate exhibited before it was broken. And the parts of all natural Bodies being like so many fragments of a Plate, must on the same grounds exhibit the same Colours.

Now that they do so, will appear by the affinity of their properties. The finely coloured Feathers of some Birds, and particularly those of Peacocks Tails, do in the very same part of the Feather appear of several Colours in several positions of the Eye, after the very same manner that thin Plates were found to do in the 7th and 19th Observations, and therefore arise from the thinness of the transparent parts of the Feathers; that is, from the slenderness of the very fine Hairs, or *Capillamenta*, which grow out of the sides of the grosser lateral branches or fibres of those Feathers. And to the same purpose it is, that the Webs of some Spiders by
being

being spun very fine have appeared coloured, as some have observed, and that the coloured fibres of some silks by varying the position of the Eye do vary their Colour. Also the Colours of silks, cloths, and other substances, which Water or Oyl can intimately penetrate, become more faint and obscure by being immerged in those liquors, and recover their vigor again by being dried, much after the manner declared of thin Bodies in the 10th and 21th Observations. Leaf-gold, some sorts of painted Glass, the infusion of *Lignum Nephriticum*, and some other substances reflect one Colour, and transmit another, like thin Bodies in the 9th and 20th Observations. And some of those coloured powders which Painters use, may have their Colours a little changed, by being very elaborately and finely ground. Where I see not what can be justly pretended for those changes, besides the breaking of their parts into less parts by that contrition after the same manner that the Colour of a thin Plate is changed by varying its thickness. For which reason also it is that the coloured flowers of Plants and Vegetables by being bruised usually become more transparent than before, or at least in some degree or other change their Colours. Nor is it much less to my purpose, that by mixing divers liquors very odd and remarkable productions and changes of Colours may be effected, of which no cause can be more obvious and rational than that the saline corpuscles of one liquor do variously act upon or unite with the tinging corpuscles of another, so as to make them swell, or shrink (whereby not only their bulk but their density also may be changed) or to divide them into smaller corpuscles, (whereby a coloured liquor may be-
come

come transparent) or to make many of them associate into one cluster, whereby two transparent liquors may compose a coloured one. For we see how apt those saline menstrua are to penetrate and dissolve substances to which they are applied, and some of them to precipitate what others dissolve. In like manner, if we consider the various Phænomena of the Atmosphære, we may observe, that when Vapors are first raised, they hinder not the transparency of the Air, being divided into parts too small to cause any reflexion in their superficies. But when in order to compose drops of rain they begin to coalesce and constitute globules of all intermediate sizes, those globules when they become of a convenient size to reflect some Colours and transmit others, may constitute Clouds of various Colours according to their sizes. And I see not what can be rationally conceived in so transparent a substance as Water for the production of these Colours, besides the various sizes of its fluid and globular parcels.

P R O P. VI.

The parts of Bodies on which their Colours depend, are denser than the medium, which pervades their interstices.

This will appear by considering, that the Colour of a Body depends not only on the rays which are incident perpendicularly on its parts, but on those also which are incident at all other Angles. And that according to the 7th Observation, a very little variation of obliquity will change the reflected Colour where the thin body or small particle is rarer than the ambient

I i

medium,

medium, infomuch that fuch a fmall particle will at diversly oblique incidences reflect all forts of Colours, in fo great a variety that the Colour refulting from them all, confufedly reflected from a heap of fuch particles, muft rather be a white or grey than any other Colour, or at beft it muft be but a very imperfect and dirty Colour. Whereas if the thin body or fmall particle be much denfer than the ambient medium, the Colours according to the 19th Obfervation are fo little changed by the variation of obliquity, that the rays which are reflected leaft obliquely may predominate over the reft fo much as to caufe a heap of fuch particles to appear very intenfly of their Colour.

It conduces alfo fomething to the confirmation of this Propofition, that, according to the 22th Obfervation, the Colours exhibited by the denfer thin body within the rarer, are more brifque than thofe exhibited by the rarer within the denfer.

P R O P. VII.

The bignefs of the component parts of natural Bodies may be conjectured by their Colours.

For fince the parts of thefe Bodies by Prop. 5. do moft probably exhibit the fame Colours with a Plate of equal thicknefs, provided they have the fame refractive denfity; and fince their parts feem for the moft part to have much the fame denfity with Water or Glafs, as by many circumftances is obvious to collect; to determine the fizes of thofe parts you need only have recourfe to the precedent Tables, in which the thicknefs of Water or Glafs exhibiting any Colour is expreffed. Thus
if

if it be desired to know the Diameter of a corpuscle, which being of equal density with Glass shall reflect green of the third order; the number $16\frac{1}{4}$ shews it to be $\frac{16\frac{1}{4}}{100000}$ parts of an Inch.

The greatest difficulty is here to know of what order the Colour of any Body is. And for this end we must have recourse to the 4th and 18th Observations, from whence may be collected these particulars.

Scarlets, and other *reds*, *oranges* and *yellows*, if they be pure and intense are most probably of the second order. Those of the first and third order also may be pretty good, only the yellow of the first order is faint, and the orange and red of the third order have a great mixture of violet and blue.

There may be good *greens* of the fourth order, but the purest are of the third. And of this order the green of all vegetables seem to be, partly by reason of the intenseness of their Colours, and partly because when they wither some of them turn to a greenish yellow, and others to a more perfect yellow or orange, or perhaps to red, passing first through all the aforesaid intermediate Colours. Which changes seem to be effected by the exhaling of the moisture which may leave the tinging corpuscles more dense, and something augmented by the accretion of the oily and earthy part of that moisture. Now the green without doubt is of the same order with those Colours into which it changeth, because the changes are gradual, and those Colours, though usually not very full, yet are often too full and lively to be of the fourth order.

Blues and *purples* may be either of the second or third order, but the best are of the third. Thus the Colour of violets seems to be of that order, because their Syrup by acid Liquors turns red, and by urinous and alcalizale turns green. For since it is of the nature of Acids to dissolve or attenuate, and of Alcalies to precipitate or incrassate, if the purple Colour of the Syrup was of the second order, an acid Liquor by attenuating its tinging corpuscles would change it to a red of the first order, and an Alcaly by incrassating them would change it to a green of the second order; which red and green, especially the green, seem too imperfect to be the Colours produced by these changes. But if the said purple be supposed of the third order, its change to red of the second, and green of the third, may without any inconvenience be allowed.

If there be found any Body of a deeper and less reddish purple than that of the violets, its Colour most probably is of the second order. But yet their being no Body commonly known whose Colour is constantly more deep than theirs, I have made use of their name to denote the deepest and least reddish purples, such as manifestly transcend their Colour in purity.

The *blue* of the first order, though very faint and little, may possibly be the Colour of some substances; and particularly the azure Colour of the Skys seems to be of this order. For all vapours when they begin to condense and coalesce into small parcels, become first of that bigness whereby such an Azure must be reflected before they can constitute Clouds of other Colours. And so this being the first Colour which vapors begin to reflect, it ought to be the Colour of the finest and most trans-

transparent Skys in which vapors are not arrived to that grossness requisite to reflect other Colours, as we find it is by experience.

Whiteness, if most intense and luminous, is that of the first order, if less strong and luminous a mixture of the Colours of several orders. Of this last kind is the whiteness of Froth, Paper, Linnen, and most white substances; of the former I reckon that of white metals to be. For whilst the densest of metals, Gold, if foliated is transparent, and all metals become transparent if dissolved in menstruums or vitrified, the opacity of white metals ariseth not from their density alone. They being less dense than Gold would be more transparent than it, did not some other cause concur with their density to make them opaque. And this cause I take to be such a bigness of their particles as fits them to reflect the white of the first order. For if they be of other thickneses they may reflect other Colours, as is manifest by the Colours which appear upon hot Steel in tempering it, and sometimes upon the surface of melted metals in the Skin or Scoria which arises upon them in their cooling. And as the white of the first order is the strongest which can be made by Plates of transparent substances, so it ought to be stronger in the denser substances of metals than in the rarer of Air, Water and Glass. Nor do I see but that metallic substances of such a thickness as may fit them to reflect the white of the first order, may, by reason of their great density (according to the tenour of the first of these Propositions) reflect all the Light incident upon them, and so be as opaque and splendid as its possible for any Body to be. Gold, or Copper mixed with less than half their weight
of

of Silver, or Tin, or Regulus of Antimony, in fusion or amalgamed with a very little Mercury become white; which shews both that the particles of white metals have much more superficies, and so are smaller, than those of Gold and Copper, and also that they are so opaque as not to suffer the particles of Gold or Copper to shine through them. Now it is scarce to be doubted, but that the Colours of Gold and Copper are of the second or third order, and therefore the particles of white metals cannot be much bigger than is requisite to make them reflect the white of the first order. The volatility of Mercury argues that they are not much bigger, nor may they be much less, lest they lose their opacity, and become either transparent as they do when attenuated by vitrification, or by solution in menstruums, or black as they do when ground smaller, by rubbing Silver, or Tin, or Lead, upon other substances to draw black Lines. The first and only Colour which white metals take by grinding their particles smaller is black, and therefore their white ought to be that which borders upon the black Spot in the center of the Rings of Colours, that is, the white of the first order. But if you would hence gather the bigness of metallic particles, you must allow for their density. For were Mercury transparent, its density is such that the Sine of incidence upon it (by my computation) would be to the sine of its refraction, as 71 to 20, or 7 to 2. And therefore the thickness of its particles, that they may exhibit the same Colours with those of Bubbles of Water, ought to be less than the thickness of the Skin of those Bubbles in the proportion of 2 to 7. Whence its possible that the particles of Mercury may be as little

as the particles of some transparent and volatile fluids, and yet reflect the white of the first order.

Lastly, for the production of *black*, the corpuscles must be less than any of those which exhibit Colours. For at all greater sizes there is too much Light reflected to constitute this Colour. But if they be supposed a little less than is requisite to reflect the white and very faint blue of the first order, they will, according to the 4th, 8th, 17th and 18th Observations, reflect so very little as to appear intensely black, and yet may perhaps variously refract it to and fro within themselves so long, until it happen to be stifled and lost, by which means they will appear black in all positions of the Eye without any transparency. And from hence may be understood why Fire, and the more subtile dissolver Putrefaction, by dividing the particles of substances, turn them to black, why small quantities of black substances impart their Colour very freely and intensely to other substances to which they are applied; the minute particles of these, by reason of their very great number, easily overspreading the gross particles of others; why Glass ground very elaborately with Sand on a copper Plate, 'till it be well polished, makes the Sand, together with what is worn off from the Glass and Copper, become very black: why black substances do soonest of all others become hot in the Sun's Light and burn, (which effect may proceed partly from the multitude of refractions in a little room, and partly from the easy commotion of so very small corpuscles;) and why blacks are usually a little inclined to a bluish Colour. For that they are so may be seen by illuminating white Paper by Light reflected from black substances.

stances. For the Paper will usually appear of a bluish white; and the reason is, that black borders on the obscure blue of the first order described in the 18th Observation, and therefore reflects more rays of that Colour than of any other.

In these Descriptions I have been the more particular, because it is not impossible but that Microscopes may at length be improved to the discovery of the particles of Bodies on which their Colours depend, if they are not already in some measure arrived to that degree of perfection. For if those Instruments are or can be so far improved as with sufficient distinctness to represent Objects five or six hundred times bigger than at a Foot distance they appear to our naked Eyes, I should hope that we might be able to discover some of the greatest of those corpuscles. And by one that would magnify three or four thousand times perhaps they might all be discovered, but those which produce blackness. In the mean while I see nothing material in this Discourse that may rationally be doubted of excepting this Position, That transparent corpuscles of the same thickness and density with a Plate, do exhibit the same Colour. And this I would have understood not without some latitude, as well because those corpuscles may be of irregular Figures, and many rays must be obliquely incident on them, and so have a shorter way through them than the length of their Diameters, as because the straitness of the medium pent in on all sides within such corpuscles may a little alter its motions or other qualities on which the reflexion depends. But yet I cannot much suspect the last, because I have observed of some small Plates of Muscovy-Glass which were of an
even

even thickness, that through a Microscope they have appeared of the same Colour at their edges and corners where the included medium was terminated, which they appeared of in other places. However it will add much to our satisfaction, if those corpuscles could be discovered with Microscopes; which if we shall at length attain to, I fear it will be the utmost improvement of this sense. For it seems impossible to see the more secret and noble works of nature within the corpuscles by reason of their transparency.

P R O P. VIII.

The cause of Reflexion is not the impinging of Light on the solid or impervious parts of Bodies, as is commonly believed.

This will appear by the following Considerations. First, That in the passage of Light out of Glass into Air there is a reflexion as strong as in its passage out of Air into Glass, or rather a little stronger, and by many degrees stronger than in its passage out of Glass into Water. And it seems not probable that Air should have more reflecting parts than Water or Glass. But if that should possibly be supposed, yet it will avail nothing; for the reflexion is as strong or stronger when the Air is drawn away from the Glass, (suppose in the Air-pump invented by Mr. Boyle) as when it is adjacent to it. Secondly, If Light in its passage out of Glass into Air be incident more obliquely than at an Angle of 40 or 41 degrees it is wholly reflected, if less obliquely it is in great measure transmitted. Now it is not to be imagined that Light at one degree of obliquity should meet

with pores enough in the Air to transmit the greater part of it, and at another degree of obliquity should meet with nothing but parts to reflect it wholly, especially considering that in its passage out of Air into Glafs, how oblique soever be its incidence, it finds pores enough in the Glafs to transmit the greatest part of it. If any Man suppose that it is not reflected by the Air, but by the outmost superficial parts of the Glafs, there is still the same difficulty: Besides, that such a Supposition is unintelligible, and will also appear to be false by applying Water behind some part of the Glafs instead of Air. For so in a convenient obliquity of the rays suppose of 45 or 46 degrees, at which they are all reflected where the Air is adjacent to the Glafs, they shall be in great measure transmitted where the Water is adjacent to it; which argues, that their reflexion or transmission depends on the constitution of the Air and Water behind the Glafs, and not on the striking off the rays upon the parts of the Glafs. Thirdly, If the Colours made by a Prism placed at the entrance of a beam of Light into a darkened room be successively cast on a second Prism placed at a greater distance from the former, in such manner that they are all alike incident upon it, the second Prism may be so inclined to the incident rays, that those which are of a blue Colour shall be all reflected by it, and yet those of a red Colour pretty copiously transmitted. Now if the reflexion be caused by the parts of Air or Glafs, I would ask, why at the same obliquity of incidence the blue should wholly impinge on those parts so as to be all reflected, and yet the red find pores enough to be in great measure transmitted. Fourthly, where two Glasses touch one another,

another, there is no sensible reflexion as was declared in the first Observation ; and yet I see no reason why the rays should not impinge on the parts of Glafs as much when contiguous to other Glafs as when contiguous to Air. Fifthly, When the top of a Water-bubble (in the 17th Observation) by the continual subsiding and exhaling of the Water grew very thin, there was such a little and almost insensible quantity of Light reflected from it, that it appeared intently black ; whereas round about that black Spot, where the Water was thicker, the reflexion was so strong as to make the Water seem very white. Nor is it only at the least thickness of thin Plates or Bubbles, that there is no manifest reflexion, but at many other thicknesses continually greater and greater. For in the 15th Observation the rays of the same Colour were by turns transmitted at one thickness, and reflected at another thickness, for an indeterminate number of successions. And yet in the superficies of the thinned Body, where it is of any one thickness, there are as many parts for the rays to impinge on, as where it is of any other thickness. Sixthly, If reflexion were caused by the parts of reflecting Bodies, it would be impossible for thin Plates or Bubbles at the same place to reflect the rays of one Colour and transmit those of another, as they do according to the 13th and 15th Observations. For it is not to be imagined that at one place the rays which for instance exhibit a blue Colour, should have the fortune to dash upon the parts, and those which exhibit a red to hit upon the pores of the Body ; and then at another place, where the Body is either a little thicker, or a little thinner, that on the contrary the blue should

hit upon its pores, and the red upon its parts. Lastly, were the rays of Light reflected by impinging on the solid parts of Bodies, their reflexions from polished Bodies could not be so regular as they are. For in polishing Glafs with Sand, Putty or Tripoly, it is not to be imagined that those substances can by grating and fretting the Glafs bring all its least particles to an accurate polish; so that all their surfaces shall be truly plain or truly spherical, and look all the same way, so as together to compose one even surface. The smaller the particles of those substances are, the smaller will be the scratches by which they continually fret and wear away the Glafs until it be polished, but be they never so small they can wear away the Glafs no otherwise than by grating and scratching it, and breaking the protuberances, and therefore polish it no otherwise than by bringing its roughness to a very fine Grain, so that the scratches and frettings of the surface become too small to be visible. And therefore if Light were reflected by impinging upon the solid parts of the Glafs, it would be scattered as much by the most polished Glafs as by the roughest. So then it remains a Problem, how Glafs polished by fretting substances can reflect Light so regularly as it does. And this Problem is scarce otherwise to be solved than by saying, that the reflexion of a ray is effected, not by a single point of the reflecting Body, but by some power of the Body which is evenly diffused all over its surface, and by which it acts upon the ray without immediate contact. For that the parts of Bodies do act upon Light at a distance shall be shewn hereafter.

Now

Now if Light be reflected not by impinging on the solid parts of Bodies, but by some other principle ; its probable that as many of its rays as impinge on the solid parts of Bodies are not reflected but stifled and lost in the Bodies. For otherwise we must allow two sorts of reflexions. Should all the rays be reflected which impinge on the internal parts of clear Water or Crystal, those substances would rather have a cloudy Colour than a clear transparency. To make Bodies look black, its necessary that many rays be stopt, retained and lost in them, and it seems not probable that any rays can be stopt and stifled in them which do not impinge on their parts.

And hence we may understand that Bodies are much more rare and porous than is commonly believed. Water is 19 times lighter, and by consequence 19 times rarer than Gold, and Gold is so rare as very readily and without the least opposition to transmit the magnetick Effluvia, and easily to admit Quick-silver into its pores, and to let Water pass through it. For a concave Sphere of Gold filled with Water, and sodered up, has upon pressing the Sphere with great force, let the Water squeeze through it, and stand all over its outside in multitudes of small Drops, like dew, without bursting or cracking the Body of the Gold as I have been informed by an Eye-witness. From all which we may conclude, that Gold has more pores than solid parts, and by consequence that Water has above forty-times more pores than parts. And he that shall find out an Hypothesis, by which Water may be so rare, and yet not be capable of compression by force, may doubtless by the same Hypothesis make Gold and Water, and all
other

other Bodies as much rarer as he pleases, so that Light may find a ready passage through transparent substances.

P R O P. IX.

Bodies reflect and refract Light by one and the same power variously exercised in various circumstances.

This appears by several Considerations. First, Because when Light goes out of Glass into Air, as obliquely as it can possibly do, if its incidence be made still more oblique, it becomes totally reflected. For the power of the Glass after it has refracted the Light as obliquely as is possible if the incidence be still made more oblique, becomes too strong to let any of its rays go through, and by consequence causes total reflexions. Secondly, Because Light is alternately reflected and transmitted by thin Plates of Glass for many successions accordingly, as the thickness of the Plate increases in an arithmetical Progression. For here the thickness of the Glass determines whether that power by which Glass acts upon Light shall cause it to be reflected, or suffer it to be transmitted. And, Thirdly, because those surfaces of transparent Bodies which have the greatest refracting power, reflect the greatest quantity of Light, as was shewed in the first Proposition.

P R O P. X.

If Light be swifter in Bodies than in Vacuo in the proportion of the Sines which measure the refraction of the Bodies, the forces of the Bodies to reflect and refract Light,
are

are very nearly proportional to the densities of the same Bodies, excepting that unctuous and sulphureous Bodies refract more than others of this same density.

Let A B represent the refracting plane surface of any Body, and I C a ray incident very obliquely upon the

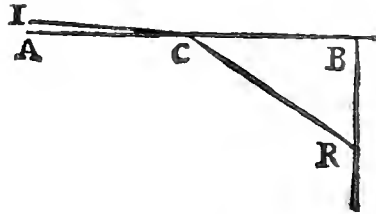

Body in C, so that the Angle ACI may be infinitely little, and let CR be the refracted ray. From a given point B perpendicular to the refracting surface erect BR meeting with the refracted ray CR in R, and if CR represent the motion of the refracted ray, and this motion be distinguished into two motions CB and BR, whereof CB is a parallel to the refracting plane, and BR perpendicular to it: CB shall represent the motion of the incident ray, and BR the motion generated by the refraction, as Opticians have of late explained.

Now if any body or thing in moving through any space of a giving breadth terminated on both sides by two parallel plains, be urged forward in all parts of that space by forces tending directly forwards towards the last plain, and before its incidence on the first plane, had no motion towards it, or but an infinitely little one; and if the forces in all parts of that space, between the planes be at equal distances from the planes equal to one another, but at several distances be bigger or less in any given proportion, the motion generated by the forces in the whole passage of the body or thing through

through that space shall be in a subduplicate proportion of the forces, as Mathematicians will easily understand. And therefore if the space of activity of the refracting superficies of the Body be considered as such a space, the motion of the ray generated by the refracting force of the Body, during its passage through that space that is the motion BR must be in a subduplicate proportion of that refracting force : I say therefore that the square of the Line BR, and by consequence the refracting force of the Body is very nearly as the density of the same Body. For this will appear by the following Table, wherein the proportion of the Sines which measure the refraxions of several Bodies, the square of BR supposing CB an unite, the densities of the Bodies estimated by their specifick gravities, and their refractive power in respect of their densities are set down in several Columns.

The

The refracting Bodies.	The Proportion of the Sines of incidence and refraction of yellow Light.	The Square of BR, to which the refracting force of the Body is proportionate.	The density and specific gravity of the Body.	The refractive power of the Body in respect of its density.
A Pseudo-Topazius, being a natural, pellucid, brittle, hairy Stone, of a yellow Colour	23 to 14	1'699	4'27	3979
Air	3851 to 3850	0'00052	0'00125	4160
Glass of Antimony	17 to 9	2'568	5'28	4864
A Selenitis	61 to 41	1'213	2'252	5386
Glass vulgar	31 to 20	1'4025	2'58	5436
Crystal of the Rock	25 to 16	1'445	2'65	5450
Island Crystal	5 to 3	1'778	2'72	6536
Sal Gemma	17 to 11	1'388	2'143	6477
Alume	35 to 24	1'1267	1'714	6570
Borax	22 to 15	1'1511	1'714	6716
Niter	32 to 21	1'345	1'9	7079
Dantzick Vitriol	303 to 200	1'295	1'715	7551
Oyl of Vitriol	10 to 7	1'041	1'7	6124
Rain Water	529 to 396	0'7845	1.	7845
Gumm Arabic	31 to 21	1'179	1'375	8574
Spirit of Wine well rectified	100 to 73	0'8765	0'866	10121
Camphire	3 to 2	1'25	0'996	12551
Oyl Olive	22 to 15	1'1511	0'913	12607
Lintseed Oyl	40 to 27	1'1948	0'932	12819
Spirit of Turpentine	25 to 17	1'1626	0'874	13222
Ambar	14 to 9	1'42	1'04	13654
A Diamond	100 to 41	4'949	3'4	14556

The refraction of the Air in this Table is determined by that of the Atmosphere observed by Astronomers. For if Light pass through many refracting substances or mediums gradually denser and denser, and terminated

with parallel surfaces, the sum of all the refractions will be equal to the single refraction which it would have suffered in passing immediately out of the first medium into the last. And this holds true, though the number of the refracting substances be increased to infinity, and the distances from one another as much decreased, so that the Light may be refracted in every point of its passage, and by continual refractions bent into a curve Line. And therefore the whole refraction of Light in passing through the Atmosphere from the highest and rarest part thereof down to the lowest and densest part, must be equal to the refraction which it would suffer in passing at like obliquity out of a Vacuum immediately into Air of equal density with that in the lowest part of the Atmosphere.

Now, by this Table, the refractions of a Pseudo-Topaz, a Selenitis, Rock Crystal, Island Crystal, Vulgar Glass (that is, Sand melted together) and Glass of Antimony, which are terrestrial stony alcalizate concretes, and Air which probably arises from such substances by fermentation, though these be substances very differing from one another in density, yet they have their refractive powers almost in the same proportion to one another as their densities are, excepting that the refraction of that strange substance Island-Crystal is a little bigger than the rest. And particularly Air, which is 3400 times rarer than the Pseudo-Topaz, and 4200 times rarer than Glass of Antimony, has notwithstanding its rarity the same refractive power in respect of its density which those two very dense substances have in respect of theirs, excepting so far as those two differ from one another.

Again,

Again, the refraction of Camphire, Oyl-Olive, Lintseed Oyl, Spirit of Turpentine and Amber, which are fat sulphureous unctuous Bodies, and a Diamond, which probably is an unctuous substance coagulated, have their refractive powers in proportion to one another as their densities without any considerable variation. But the refractive power of these unctuous substances is two or three times greater in respect of their densities than the refractive powers of the former substances in respect of theirs.

Water has a refractive power in a middle degree between those two sorts of substances, and probably is of a middle nature. For out of it grow all vegetable and animal substances, which consist as well of sulphureous fat and inflammable parts, as of earthy lean and alkali-zate ones.

Salts and Vitriols have refractive powers in a middle degree between those of earthy substances and Water, and accordingly are composed of those two sorts of substances. For by distillation and rectification of their Spirits a great part of them goes into Water, and a great part remains behind in the form of a dry fixt earth capable of vitrification.

Spirit of Wine has a refractive power in a middle degree between those of Water and oily substances, and accordingly seems to be composed of both, united by fermentation; the Water, by means of some saline Spirits with which 'tis impregnated, dissolving the Oyl, and volatizing it by the action. For Spirit of Wine is inflammable by means of its oily parts, and being distilled often from Salt of Tartar, grows by every distillation more and more aqueous and flegmatick. And

Chymists observe, that Vegetables (as Lavender, Rue, Marjoram, &c.) distilled *per se*, before fermentation yield Oyls without any burning Spirits, but after fermentation yield ardent Spirits without Oyls: Which shews, that their Oyl is by fermentation converted into Spirit. They find also, that if Oyls be poured in small quantity upon fermentating Vegetables, they distil over after fermentation in the form of Spirits.

So then, by the foregoing Table, all Bodies seem to have their refractive powers proportional to their densities, (or very nearly;) excepting so far as they partake more or less of sulphurous oily particles, and thereby have their refractive power made greater or less. Whence it seems rational to attribute the refractive power of all Bodies chiefly, if not wholly, to the sulphurous parts with which they abound. For it's probable that all Bodies abound more or less with Sulphurs. And as Light congregated by a Burning-glass acts most upon sulphurous Bodies, to turn them into fire and flame; so, since all action is mutual, Sulphurs ought to act most upon Light. For that the action between Light and Bodies is mutual, may appear from this Consideration, That the densest Bodies which refract and reflect Light most strongly grow hottest in the Summer-Sun, by the action of the refracted or reflected Light.

I have hitherto explained the power of Bodies to reflect and refract, and shewed, that thin transparent plates, fibres and particles do, according to their several thicknesses and densities, reflect several sorts of rays, and thereby appear of several Colours, and by consequence that nothing more is requisite for producing all the
the

the Colours of natural Bodies than the several sizes and densities of their transparent particles. But whence it is that these plates, fibres and particles do, according to their several thickneses and densities, reflect several sorts of rays, I have not yet explained. To give some insight into this matter, and make way for understanding the next Part of this Book, I shall conclude this Part with a few more Propositions. Those which preceded respect the nature of Bodies, these the nature of Light : For both must be understood before the reason of their actions upon one another can be known. And because the last Proposition depended upon the velocity of Light, I will begin with a Proposition of that kind.

P R O P. XI.

Light is propagated from luminous Bodies in time, and spends about seven or eight minutes of an hour in passing from the Sun to the Earth.

This was observed first by *Romer*, and then by others, by means of the Eclipses of the Satellites of *Jupiter*. For these Eclipses, when the Earth is between the Sun and *Jupiter*, happen about seven or eight minutes sooner than they ought to do by the Tables, and when the Earth is beyond the Sun they happen about seven or eight minutes later than they ought to do ; the reason being, that the Light of the Satellites has farther to go in the latter case than in the former by the Diameter of the Earth's Orbit. Some inequalities of time may arise from the excentricities of the Orbs of the Satellites ; but those cannot answer in all the Satellites, and at all times
to

to the position and distance of the Earth from the Sun. The mean motions of *Jupiter's* Satellites is also swifter in his descent from his Aphelium to his Perihelium, than in his ascent in the other half of his Orb : But this inequality has no respect to the position of the Earth, and in the three interior Satellites is insensible, as I find by computation from the Theory of their gravity.

P R O P. XII.

Every ray of Light in its passage through any refracting surface is put into a certain transient constitution or state, which in the progress of the ray returns at equal intervals, and disposes the ray at every return to be easily transmitted through the next refracting surface, and between the returns to be easily reflected by it.

This is manifest by the 5th, 9th, 12th and 15th Observations. For by those Observations it appears, that one and the same sort of rays at equal Angles of incidence on any thin transparent plate, is alternately reflected and transmitted for many successions accordingly, as the thickness of the plate increases in arithmetical progression of the numbers 0, 1, 2, 3, 4, 5, 6, 7, 8, &c. so that if the first reflexion (that which makes the first or innermost of the Rings of Colours there described) be made at the thickness 1, the rays shall be transmitted at the thicknesses 0, 2, 4, 6, 8, 10, 12, &c. and thereby make the central Spot and Rings of Light, which appear by transmission, and be reflected at the thickness 1, 3, 5, 7, 9, 11, &c. and thereby make the Rings which appear

appear by reflexion. And this alternate reflexion and transmission, as I gather by the 24th Observation, continues for above an hundred vicissitudes, and by the the Observations in the next part of this Book, for many thousands, being propagated from one surface of a Glass-plate to the other, though the thickness of the plate be a quarter of an Inch or above : So that this alternation seems to be propagated from every refracting surface to all distances without end or limitation.

This alternate reflexion and refraction depends on both the surfaces of every thin plate, because it depends on their distance. By the 21th Observation, if either surface of a thin plate of Muscovy-Glass be wetted, the Colours caused by the alternate reflexion and refraction grow faint, and therefore it depends on them both.

It is therefore performed at the second surface, for if it were performed at the first, before the rays arrive at the second, it would not depend on the second.

It is also influenced by some action or disposition, propagated from the first to the second, because otherwise at the second it would not depend on the first. And this action or disposition, in its propagation, intermits and returns by equal intervals, because in all its progress it inclines the ray at one distance from the first surface to be reflected by the second, at another to be transmitted by it, and that by equal intervals for innumerable vicissitudes. And because the ray is disposed to reflexion at the distances 1, 3, 5, 7, 9, &c. and to transmission at the distances 0, 2, 4, 6, 8, 10, &c, (for its transmission through the first surface, is at the distance

stance 0, and it is transmitted through both together, if their distance be infinitely little or much less than 1) the disposition to be transmitted at the distances 2, 4, 6, 8, 10, &c. is to be accounted a return of the same disposition which the ray first had at the distance 0, that is at its transmission through the first refracting surface. All which is the thing I would prove.

What kind of action or disposition this is? Whether it consist in a circulating or a vibrating motion of the ray, or of the medium, or something else? I do not here enquire. Those that are averse from assenting to any new discoveries, but such as they can explain by an Hypothesis, may for the present suppose, that as Stones by falling upon Water put the Water into an undulating motion, and all Bodies by percussive excite vibrations in the Air; so the rays of Light, by impinging on any refracting or reflecting surface, excite vibrations in the refracting or reflecting medium or substance, and by exciting them agitate the solid parts of the refracting or reflecting Body, and by agitating them cause the Body to grow warm or hot; that the vibrations thus excited are propagated in the refracting or reflecting medium or substance, much after the manner that vibrations are propagated in the Air for causing sound, and move faster than the rays so as to overtake them; and that when any ray is in that part of the vibration which conspires with its motion, it easily breaks through a refracting surface, but when it is in the contrary part of the vibration which impedes its motion, it is easily reflected; and, by consequence, that every ray is successively disposed to be easily reflected, or easily transmitted, by every vibration which overtakes it. But
whether

whether this Hypothesis be true or false I do not here consider. I content my self with the bare discovery, that the rays of Light are by some cause or other alternately disposed to be reflected or refracted for many vicissitudes.

DEFINITION.

The returns of the disposition of any ray to be reflected I will call its Fits of easy reflexion, and those of its disposition to be transmitted its Fits of easy transmission, and the space it passes between every return and the next return, the Interval of its Fits.

PROP. XIII.

The reason why the surfaces of all thick transparent Bodies reflect part of the Light incident on them, and refract the rest, is, that some rays at their incidence are in Fits of easy reflexion, and others in Fits of easy transmission.

This may be gathered from the 24th Observation, where the Light reflected by thin plates of Air and Glass, which to the naked Eye appeared evenly white all over the plate, did through a Prism appear waved with many successions of Light and Darkneis made by alternate fits of easy reflexion and easy transmission, the Prism severing and distinguishing the waves of which the white reflected Light was composed, as was explained above.

And hence Light is in fits of easy reflexion and easy transmissiſſion, before its incidence on transparent Bodies. And probably it is put into ſuch fits at its firſt emission from luminous Bodies, and continues in them during all its progreſs. For theſe fits are of a laſting Nature, as will appear by the next part of this Book.

In this Propoſition I ſuppoſe the transparent Bodies to be thick, becauſe if the thickneſs of the Body be much leſs than the interval of the fits of easy reflexion and transmiſſion of the rays, the Body loſeth its reflecting power. For if the rays, which at their entering into the Body are put into fits of easy transmiſſion, arrive at the furtheſt ſurface of the Body before they be out of thoſe fits they muſt be transmiſſed. And this is the reaſon why Bubbles of Water loſe their reflecting power when they grow very thin, and why all opaque Bodies when reduced into very ſmall parts become transparent.

P R O P. XIV.

Thoſe ſurfaces of transparent Bodies, which if the ray be in a fit of refraction do refract it moſt ſtrongly, if the ray be in a fit of reflexion do reflect it moſt eaſily.

For we ſhewed above in Prop. 8. that the cauſe of reflexion is not the impinging of Light on the ſolid impervious parts of Bodies, but ſome other power by which thoſe ſolid parts act on Light at a diſtance. We ſhewed alſo in Prop. 9. that Bodies reflect and refract Light by one and the ſame power variously exerciſed in various circumſtances, and in Prop. 1. that the moſt ſtrongly refracting ſurfaces reflect the moſt Light: All
which

which compared together evince and ratify both this and the last Proposition.

P R O P. XV.

In any one and the same sort of rays emerging in any Angle out of any refracting surface into one and the same medium, the interval of the following fits of easy reflexion and transmission are either accurately or very nearly, as the Rectangle of the secant of the Angle of refraction, and of the secant of another Angle, whose sine is the first of 106 arithmetical mean proportionals, between the sines of incidence and refraction counted from the sine of refraction.

This is manifest by the 7th Observation.

P R O P. XVI.

In several sorts of rays emerging in equal Angles out of any refracting surface into the same medium, the intervals of the following fits of easy reflexion and easy transmission are either accurately, or very nearly, as the Cube-roots of the Squares of the lengths of a Chord, which sound the notes in an Eight, sol, la, fa, sol, la, mi, fa, sol, with all their intermediate degrees answering to the Colours of those rays, according to the Analogy described in the seventh Experiment of the second Book.

This is manifest by the 13th and 14th Observations.

P R O P. XVII.

If rays of any one sort pass perpendicularly into several mediums, the intervals of the fits of easy reflexion and transmission in any one medium, is to those intervals in any other as the sine of incidence to the sine of refraction, when the rays pass out of the first of those two mediums into the second.

This is manifest by the 10th Observation.

P R O P. XVIII.

If the rays which paint the Colour in the confine of yellow and orange pass perpendicularly out of any medium into Air, the intervals of their fits of easy reflexion are the $\frac{1}{89000}$ th part of an Inch. And of the same length are the intervals of their fits of easy transmission.

This is manifest by the 6th Observation.

From these Propositions it is easy to collect the intervals of the fits of easy reflexion and easy transmission of any sort of rays refracted in any Angle into any medium, and thence to know, whether the rays shall be reflected or transmitted at their subsequent incidence upon any other pellucid medium. Which thing being useful for understanding, the next part of this Book was here to be set down. And for the same reason I add the two following Propositions.

PROP.

P R O P. XIX.

If any sort of rays falling on the polite surface of any pellucid medium be reflected back, the fits of easy reflexion which they have at the point of reflexion, shall still continue to return, and the returns shall be at distances from the point of reflexion in the arithmetical progression of the numbers 2, 4, 6, 8, 10, 12, &c. and between these fits the rays shall be in fits of easy transmission.

For since the fits of easy reflexion and easy transmission are of a returning nature, there is no reason why these fits, which continued till the ray arrived at the reflecting medium, and there inclined the ray to reflexion, should there cease. And if the ray at the point of reflexion was in a fit of easy reflexion, the progression of the distances of these fits from that point must begin from 0, and so be of the numbers 0, 2, 4, 6, 8, &c. And therefore the progression of the distances of the intermediate fits of easy transmission reckoned from the same point, must be in the progression of the odd numbers 1, 3, 5, 7, 9, &c. contrary to what happens when the fits are propagated from points of refraction.

P R O P. XX.

The intervals of the fits of easy reflexion and easy transmission, propagated from points of reflexion into any medium, are equal to the intervals of the like fits which the same rays would have, if refracted into the same medium

medium in Angles of refraction equal to their Angles of reflexion.

For when Light is reflected by the second surface of thin plates, it goes out afterwards freely at the first surface to make the Rings of Colours which appear by reflexion, and by the freedom of its egress, makes the Colours of these Rings more vivid and strong than those which appear on the other side of the plates by the transmitted Light. The reflected rays are therefore in fits of easy transmission at their egress; which would not always happen, if the intervals of the fits within the plate after reflexion were not equal both in length and number to their intervals before it. And this confirms also the proportions set down in the former Proposition. For if the rays both in going in and out at the first surface be in fits of easy transmission, and the intervals and numbers of those fits between the first and second surface, before and after reflexion, be equal; the distances of the fits of easy transmission from either surface, must be in the same progression after reflexion as before; that is, from the first surface which transmitted them, in the progression of the even numbers 0, 2, 4, 6, 8, &c. and from the second which reflected them, in that of the odd numbers 1, 3, 5, 7, &c. But these two Propositions will become much more evident by the Observations in the following part of this Book.

T H E

S E C O N D B O O K

O F

O P T I C K S.

P A R T I V.

*Observations concerning the Reflexions and Colours of
thick transparent polished Plates.*

THere is no Glafs or Speculum how well soever polished, but, besides the Light which it refracts or reflects regularly, scatters every way irregularly a faint Light, by means of which the polished surface, when illuminated in a dark Room by a beam of the Sun's Light, may be easily seen in all positions of the Eye. There are certain Phænomena of this scattered Light, which when I first observed them, seemed very strange and surprizing to me. My Observations were as follows.

O B S.

O B S. I.

The Sun shining into my darkened Chamber through a Hole $\frac{1}{3}$ of an Inch wide, I let the intromitted beam of Light fall perpendicularly upon a Glasſ Speculum ground concave on one ſide and convex on the other, to a Sphere of five Feet and eleven Inches Radius, and quick-filtered over on the convex ſide. And holding a white opake Chart, or a Quire of Paper at the Center of the Spheres to which the Speculum was ground, that is, at the diſtance of about five Feet and eleven Inches from the Speculum, in ſuch manner, that the beam of Light might paſs through a little Hole made in the middle of the Chart to the Speculum, and thence be reflected back to the ſame Hole : I obſerved upon the Chart four or five concentric Irifes or Rings of Colours, like Rain-bows, encompassing the Hole much after the manner that thoſe, which in the fourth and following Obſervations of the firſt part of this third Book appeared between the Object-Glaſſes, encompassed the black Spot, but yet larger and fainter than thoſe. Theſe Rings as they grew larger and larger became diluter and fainter, ſo that the fifth was ſcarce viſible. Yet ſometimes, when the Sun ſhone very clear, there appeared faint Lineaments of a ſixth and ſeventh. If the diſtance of the Chart from the Speculum was much greater or much leſs than that of ſix Feet, the Rings became dilute and vaniſhed. And if the diſtance of the Speculum from the Window was much greater than that of ſix Feet, the reflected beam of Light would be ſo broad at the diſtance of ſix Feet from the Speculum where the Rings appeared,

appeared, as to obscure one or two of the innermost Rings. And therefore I usually placed the Speculum at about six Feet from the Window ; so that its Focus might there fall in with the center of its concavity at the Rings upon the Chart. And this posture is always to be understood in the following Observations where no other is expressd.

O B S. II.

The Colours of these Rain-bows succeeded one another from the center outwards, in the same form and order with those which were made in the ninth Observation of the first Part of this Book by Light not reflected, but transmitted through the two Object-Glasses. For, first, there was in their common center a white round Spot of faint Light, something broader than the reflected beam of Light ; which beam sometimes fell upon the middle of the Spot, and sometimes by a little inclination of the Speculum receded from the middle, and left the Spot white to the center.

This white Spot was immediately encompassed with a dark grey or russet, and that darkness with the Colours of the first Iris, which were on the inside next the darkness a little violet and indico, and next to that a blue, which on the outside grew pale, and then succeeded a little greenish yellow, and after that a brighter yellow, and then on the outward edge of the Iris a red which on the outside inclined to purple.

This Iris was immediately encompassed with a second, whose Colours were in order from the inside

N n

out-

outwards, purple, blue, green, yellow, light red, a red mixed with purple.

Then immediately followed the Colours of the third Iris, which were in order outwards a green inclining to purple, a good green, and a red more bright than that of the former Iris.

The fourth and fifth Iris seemed of a bluish green within, and red without, but so faintly that it was difficult to discern the Colours.

O B S. III.

Measuring the Diameters of these Rings upon the Chart as accurately as I could, I found them also in the same proportion to one another with the Rings made by Light transmitted through the two Object-Glasses. For the Diameters of the four first of the bright Rings measured between the brightest parts of their orbits, at the distance of six Feet from the Speculum were $1\frac{11}{16}$, $2\frac{3}{8}$, $2\frac{11}{12}$, $3\frac{3}{8}$ Inches, whose squares are in arithmetical progression of the numbers 1, 2, 3, 4. If the white circular Spot in the middle be reckoned amongst the Rings, and its central Light, where it seems to be most luminous, be put equipollent to an infinitely little Ring; the squares of the Diameters of the Rings will be in the progression 0, 1, 2, 3, 4, &c. I measured also the Diameters of the dark Circles between these luminous ones, and found their squares in the progression of the numbers $\frac{1}{2}$, $1\frac{1}{4}$, $2\frac{1}{2}$, $3\frac{1}{2}$, &c. the Diameters of the first four at the distance of six Feet from the Speculum, being $1\frac{3}{16}$, $2\frac{1}{16}$, $2\frac{2}{3}$, $3\frac{3}{25}$ Inches. If the distance of the Chart from the Speculum was increased

creased or diminished, the Diameters of the Circles were increased or diminished proportionally.

O B S. IV.

By the analogy between these Rings and those described in the Observations of the first Part of this Book, I suspected that there were many more of them which spread into one another, and by interfering mixed their Colours, and diluted one another so that they could not be seen apart. I viewed them therefore through a Prism, as I did those in the 24th Observation of the first Part of this Book. And when the Prism was so placed as by refracting the Light of their mixed Colours to separate them, and distinguish the Rings from one another, as it did those in that Observation, I could then see them distincter than before, and easily number eight or nine of them, and sometimes twelve or thirteen. And had not their Light been so very faint, I question not but that I might have seen many more.

O B S. V.

Placing a Prism at the Window to refract the intro-mitted beam of Light, and cast the oblong Spectrum of Colours on the Speculum: I covered the Speculum with a black Paper which had in the middle of it a Hole to let any one of the Colours pass through to the Speculum, whilst the rest were intercepted by the Paper. And now I found Rings of that Colour only which fell upon the Speculum. If the Speculum was illuminated with red the Rings were totally red with dark inter-

vals, if with blue they were totally blue, and so of the other Colours. And when they were illuminated with any one Colour, the Squares of their Diameters measured between their most luminous parts, were in the arithmetical progression of the numbers 0, 1, 2, 3, 4, and the Squares of the Diameters of their dark intervals in the progression of the intermediate numbers $\frac{1}{2}$, $1\frac{1}{2}$, $2\frac{1}{2}$, $3\frac{1}{2}$: But if the Colour was varied they varied their magnitude. In the red they were largest, in the indico and violet least, and in the intermediate Colours yellow, green and blue; they were of several intermediate big-nesses answering to the Colour, that is, greater in yellow than in green, and greater in green than in blue. And hence I knew that when the Speculum was illuminated with white Light, the red and yellow on the outside of the Rings were produced by the least refrangible rays, and the blue and violet by the most refrangible, and that the Colours of each Ring spread into the Colours of the neighbouring Rings on either side, after the manner explained in the first and second Part of this Book, and by mixing diluted one another so that they could not be distinguished, unless near the center where they were least mixed. For in this Observation I could see the Rings more distinctly, and to a greater number than before, being able in the yellow Light to number eight or nine of them, besides a faint shadow of a tenth. To satisfy my self how much the Colours of the several Rings spread into one another, I measured the Diameters of the second and third Rings, and found them when made by the confine of the red and orange to be the same Diameters when made by the confine of blue and indico, as 9 to 8, or thereabouts. For it was hard

to determine this proportion accurately. Also the Circles made successively by the red, yellow and green, differed more from one another than those made successively by the green, blue and indico. For the Circle made by the violet was too dark to be seen. To carry on the computation, Let us therefore suppose that the differences of the Diameters of the Circles made by the outmost red, the confine of red and orange, the confine of orange and yellow, the confine of yellow and green, the confine of green and blue, the confine of blue and indico, the confine of indico and violet, and outmost violet, are in proportion as the differences of the lengths of a Monochord which sound the tones in an Eight; *sol, la, fa, sol, la, mi, fa, sol*, that is, as the numbers $\frac{1}{9}, \frac{1}{18}, \frac{1}{12}, \frac{1}{27}, \frac{1}{27}, \frac{1}{27}, \frac{1}{18}$. And if the Diameter of the Circle made by the confine of red and orange be 9 A, and that of the Circle made by the confine of blue and indico be 8 A as above, their difference 9 A ---- 8 A will be to the difference of the Diameters of the Circles made by the outmost red, and by the confine of red and orange, as $\frac{1}{18} + \frac{1}{12} + \frac{1}{27} + \frac{1}{27}$ to $\frac{1}{9}$, that is as $\frac{8}{27}$ to $\frac{1}{9}$ or 8 to 3, and to the difference of the Circles made by the outmost violet, and by the confine of blue and indico, as $\frac{1}{18} + \frac{1}{12} + \frac{1}{27} + \frac{1}{27}$ to $\frac{1}{27} + \frac{1}{18}$, that is, as $\frac{8}{27}$ to $\frac{5}{54}$, or as 16 to 5. And therefore these differences will be $\frac{1}{3}$ A and $\frac{1}{6}$ A. Add the first to 9 A and subduct the last from 8 A, and you will have the Diameters of the Circles made by the least and most refrangible rays $\frac{25}{3}$ A and $\frac{61}{6}$ A. These Diameters are therefore to one another as 75 to 61 $\frac{1}{2}$ or 50 to 41, and their Squares as 2500 to 1681, that is, as 3 to 2 very nearly. Which proportion differs not much from the proportion of the Diameters of the Circles.

Circles made by the outmost red and outmost violet in the 13th Observation of the first part of this Book.

O B S. VI.

Placing my Eye where these Rings appeared plainest, I saw the Speculum tinged all over with waves of Colours (red, yellow, green, blue ;) like those which in the Observations of the first Part of this Book appeared between the Object-Glasses and upon Bubbles of Water, but much larger. And after the manner of those, they were of various magnitudes in various positions of the Eye, swelling and shrinking as I moved my Eye this way and that way. They were formed like Arcs of concentrick Circles as those were, and when my Eye was over against the center of the concavity of the Speculum (that is, 5 Feet and 10 Inches distance from the Speculum) their common center was in a right Line with that center of concavity, and with the Hole in the Window. But in other postures of my Eye their center had other positions. They appeared by the Light of the Clouds propagated to the Speculum through the Hole in the Window, and when the Sun shone through that Hole upon the Speculum, his Light upon it was of the Colour of the Ring whereon it fell, but by its splendor obscured the Rings made by the Light of the Clouds, unless when the Speculum was removed to a great distance from the Window, so that his Light upon it might be broad and faint. By varying the position of my Eye, and moving it nearer to or farther from the direct beam of the Sun's Light, the Colour of the Sun's reflected Light constantly varied upon the Speculum,

as it did upon my Eye, the same Colour always appearing to a By-stander upon my Eye which to me appeared upon the Speculum. And thence I knew that the Rings of Colours upon the Chart were made by these reflected Colours propagated thither from the Speculum in several Angles, and that their production depended not upon the termination of Light and Shadow.

O B S. VII.

By the Analogy of all these Phænomena with those of the like Rings of Colours described in the first Part of this Book, it seemed to me that these Colours were produced by this thick plate of Glafs, much after the manner that those were produced by very thin plates. For, upon tryal, I found that if the Quick-silver were rubbed off from the back-side of the Speculum, the Glafs alone would cause the same Rings of Colours, but much more faint than before ; and therefore the Phænomenon depends not upon the Quick-silver, unless so far as the Quick-silver by the increasing the reflexion of the back-side of the Glafs increases the Light of the Rings of Colours. I found also that a Speculum of metal without Glafs made some years since for optical uses, and very well wrought, produced none of those Rings ; and thence I understood that these Rings arise not from one specular surface alone, but depend upon the two surfaces of the plate of Glafs whereof the Speculum was made, and upon the thickness of the Glafs between them. For as in the 7th and 19th Observations of the first Part of this Book a thin plate
of

of Air, Water, or Glafs of an even thicknefs appeared of one Colour when the rays were perpendicular to it, of another when they were a little oblique, of another when more oblique, of another when ftill more oblique, and fo on ; fo here, in the fixth Obfervation, the Light which emerged out of the Glafs in feveral obliquities, made the Glafs appear of feveral Colours, and being propagated in thofe obliquities to the Chart, there painted Rings of thofe Colours. And as the reafon why a thin plate appeared of feveral Colours in feveral obliquities of the rays, was, that the rays of one and the fame fort are reflected by the thin plate at one obliquity and tranfmitted at another, and thofe of other forts tranfmitted where thefe are reflected, and reflected where thefe are tranfmitted : So the reafon why the thick plate of Glafs whereof the Speculum was made did appear of various Colours in various obliquities, and in thofe obliquities propagated thofe Colours to the Chart, was, that the rays of one and the fame fort did at one obliquity emerge out of the Glafs, at another did not emerge but were reflected back towards the Quick-filver by the hither furface of the Glafs, and accordingly as the obliquity became greater and greater emerged and were reflected alternately for many fucceffions, and that in one and the fame obliquity the rays of one fort were reflected, and thofe of another tranfmitted. This is manifefl by the firft Obfervation of this Book : For in that Obfervation, when the Speculum was illuminated by any one of the prifmatick Colours, that Light made many Rings of the fame Colour upon the Chart with dark intervals, and therefore at its emergence out of the Speculum was alternately tranfmitted, and not tranf-

transmitted from the Speculum to the Chart for many successions, according to the various obliquities of its emergence. And when the Colour cast on the Speculum by the Prism was varied, the Rings became of the Colour cast on it, and varied their bigness with their Colour, and therefore the Light was now alternately transmitted and not transmitted from the Speculum to the Lens at other obliquities than before. It seemed to me therefore that these Rings were of one and the same original with those of thin plates, but yet with this difference that those of thin plates are made by the alternate reflexions and transmissions of the rays at the second surface of the plate after one passage through it: But here the rays go twice through the plate before they are alternately reflected and transmitted; first, they go through it from the first surface to the Quick-silver, and then return through it from the Quick-silver to the first surface, and there are either transmitted to the Chart or reflected back to the Quick-silver, accordingly as they are in their fits of easie reflexion or transmission when they arrive at that surface. For the intervals of the fits of the rays which fall perpendicularly on the Speculum, and are reflected back in the same perpendicular Lines, by reason of the equality of these Angles and Lines, are of the same length and number within the Glass after reflexion as before by the 19th Proposition of the third Part of this Book. And therefore since all the rays that enter through the first surface are in their fits of easy transmission at their entrance, and as many of these as are reflected by the second are in their fits of easy reflexion there, all these must be again in their fits of easy transmission at their

return to the first, and by consequence there go out of the Glass to the Chart, and form upon it the white Spot of Light in the center of the Rings. For the reason holds good in all sorts of rays, and therefore all sorts must go out promiscuously to that Spot, and by their mixture cause it to be white. But the intervals of the fits of those rays which are reflected more obliquely than they enter, must be greater after reflexion than before by the 15th and 20th Prop. And thence it may happen that the rays at their return to the first surface, may in certain obliquities be in fits of easy reflexion, and return back to the Quick-silver, and in other intermediate obliquities be again in fits of easy transmission, and so go out to the Chart, and paint on it the Rings of Colours about the white Spot. And because the intervals of the fits at equal obliquities are greater and fewer in the less refrangible rays, and less and more numerous in the more refrangible, therefore the less refrangible at equal obliquities shall make fewer Rings than the more refrangible, and the Rings made by those shall be larger than the like number of Rings made by these; that is, the red Rings shall be larger than the yellow, the yellow than the green, the green than the blue, and the blue than the violet, as they were really found to be in the 5th Observation. And therefore the first Ring of all Colours incompassing the white Spot of Light shall be red without and violet within, and yellow, and green, and blue in the middle, as it was found in the second Observation; and these Colours in the second Ring, and those that follow shall be more expanded till they spread into one another, and blend one another by interfering.

These

These seem to be the reasons of these Rings in general, and this put me upon observing the thickness of the Glass, and considering whether the dimensions and proportions of the Rings may be truly derived from it by computation.

O B S. VIII.

I measured therefore the thickness of this concavo-convex plate of Glass, and found it every-where $\frac{1}{4}$ of an Inch precisely. Now, by the 6th Observation of the first Part of this Book, a thin plate of Air transmits the brightest Light of the first Ring, that is the bright yellow, when its thickness is the $\frac{1}{83000}$ th part of an Inch, and by the 10th Observation of the same part, a thin plate of Glass transmits the same Light of the same Ring when its thickness is less in proportion of the sine of refraction to the sine of incidence, that is, when its thickness is the $\frac{11}{1513000}$ th or $\frac{1}{137545}$ th part of an Inch, supposing the sines are as 11 to 17. And if this thickness be doubled it transmits the same bright Light of the second Ring, if tripled it transmits that of the third, and so on, the bright yellow Light in all these cases being in its fits of transmission. And therefore if its thickness be multiplied 34386 times so as to become $\frac{1}{4}$ of an Inch it transmits the same bright Light of the 34386th Ring. Suppose this be the bright yellow Light transmitted perpendicularly from the reflecting convex side of the Glass through the concave side to the white Spot in the center of the Rings of Colours on the Chart : And by a rule in the seventh Observation in the first Part of the first Book, and by the 15th and 20th Propositions

of the third Part of this Book, if the rays be made oblique to the Glafs, the thickness of the Glafs requisite to transmit the same bright Light of the same Ring in any obliquity is to this thickness of $\frac{1}{4}$ of an Inch, as the secant of an Angle whose sine is the first of an hundred and six arithmetical means between the sines of incidence and refraction, counted from the sine of incidence when the refraction is made out of any plated Body into any medium incompassing it, that is, in this case, out of Glafs into Air. Now if the thickness of the Glafs be increased by degrees, so as to bear to its first thickness, (*viz.* that of a quarter of an Inch) the proportions which 34386 (the number of fits of the perpendicular rays in going through the Glafs towards the white Spot in the center of the Rings,) hath to 34385, 34384, 34383 and 34382 (the numbers of the fits of the oblique rays in going through the Glafs towards the first, second, third and fourth Rings of Colours,) and if the first thickness be divided into 100000000 equal parts, the increased thicknesses will be 100002908, 100005816, 100008725 and 100011633, and the Angles of which these thicknesses are secants will be 26' 13", 37' 5", 45' 6" and 52' 26", the Radius being 100000000; and the sines of these Angles are 762, 1079, 1321 and 1525, and the proportional sines of refraction 1172, 1659, 2031 and 2345, the Radius being 100000. For since the sines of incidence out of Glafs into Air are to the sines of refraction as 11 to 17, and to the above-mentioned secants as 11 to the first of 106 arithmetical means between 11 and 17, that is as 11 to $11\frac{6}{106}$, those secants will be to the sines of refraction as $11\frac{6}{106}$ to 17, and by this Analogy will give these sines. So then

if

if the obliquities of the rays to the concave surface of the Glafs be such that the fines of their refraction in passing out of the Glafs through that surface into the Air be 1172, 1659, 2031, 2345, the bright Light of the 34386th Ring shall emerge at the thickneses of the Glafs which are to $\frac{1}{4}$ of an Inch as 34386 to 34385, 34384, 34383, 34382, respectively. And therefore if the thicknes in all these cases be $\frac{1}{4}$ of an Inch (as it is in the Glafs of which the Speculum was made) the bright Light of the 34385th Ring shall emerge where the sine of refraction is 1172, and that of the 34384th, 34383th and 34382th Ring where the sine is 1659, 2031, and 2345 respectively. And in these Angles of refraction the Light of these Rings shall be propagated from the Speculum to the Chart, and there paint Rings about the white central round Spot of Light which we said was the Light of the 34386th Ring. And the Semidiameters of these Rings shall subtend the Angles of refraction made at the concave surface of the Speculum, and by consequence their Diameters shall be to the distance of the Chart from the Speculum as those sines of refraction doubled are to the Radius that is as 1172, 1659, 2031, and 2345, doubled are to 100000. And therefore if the distance of the Chart from the concave surface of the Speculum be six Feet (as it was in the third of these Observations) the Diameters of the Rings of this bright yellow Light upon the Chart shall be 1'688, 2'389, 2'925, 3'375 Inches: For these Diameters are to 6 Feet as the above-mentioned sines doubled are to the Radius. Now these Diameters of the bright yellow Rings, thus found by computation are the very same with those found in the third of these Observations by measuring them,

them, (*viz.* with $1\frac{11}{16}$, $2\frac{3}{8}$, $2\frac{11}{12}$, and $3\frac{3}{8}$ Inches, and therefore the Theory of deriving these Rings from the thickness of the plate of Glass of which the Speculum was made, and from the obliquity of the emerging rays agrees with the Observation. In this computation I have equalled the Diameters of the bright Rings made by Light of all Colours, to the Diameters of the Rings made by the bright yellow. For this yellow makes the brightest part of the Rings of all Colours. If you desire the Diameters of the Rings made by the Light of any other unmixed Colour, you may find them readily by putting them to the Diameters of the bright yellow ones in a subduplicate proportion of the intervals of the fits of the rays of those Colours when equally inclined to the refracting or reflecting surface which caused those fits, that is, by putting the Diameters of the Rings made by the rays in the extremities and limits of the seven Colours, red, orange, yellow, green, blue, indico, violet, proportional the Cube-roots of the numbers, $1, \frac{8}{9}, \frac{5}{6}, \frac{3}{4}, \frac{2}{3}, \frac{3}{5}, \frac{9}{16}, \frac{1}{2}$, which express the lengths of a Monochord founding the notes in an Eighth: For by this means the Diameter of the Rings of these Colours will be found pretty nearly in the same proportion to one another, which they ought to have by the fifth of these Observations.

And thus I satisfied my self that these Rings were of the same kind and original with those of thin plates, and by consequence that the fits or alternate dispositions of the rays to be reflected and transmitted are propagated to great distances from every reflecting and refracting surface. But yet to put the matter out of doubt I added the following Observation.

O B S.

O B S. IX.

If these Rings thus depend on the thickness of the plate of Glass their Diameters at equal distances from several Speculums made of such concavo-convex plates of Glass as are ground on the same Sphere, ought to be reciprocally in a subduplicate proportion of the thicknesses of the plates of Glass. And if this proportion be found true by experience it will amount to a demonstration that these Rings (like those formed in thin plates) do depend on the thickness of the Glass. I procured therefore another concavo-convex plate of Glass ground on both sides to the same Sphere with the former plate: Its thickness was $\frac{5}{6}$ parts of an Inch; and the Diameters of the three first bright Rings measured between the brightest parts of their orbits at the distance of 6 Feet from the Glass were $3. 4\frac{1}{6}. 5\frac{1}{3}$ Inches. Now the thickness of the other Glass being $\frac{1}{4}$ of an Inch was to thickness of this Glass as $\frac{1}{4}$ to $\frac{5}{6}$, that is as 31 to 10, or 310000000 to 100000000, and the roots of these numbers are 17607 and 10000, & in the proportion of the first of these roots to the second are the Diameters of the bright Rings made in this Observation by the thinner Glass, $3. 4\frac{1}{6}. 5\frac{1}{3}$ to the Diameters of the same Rings made in the third of these Observations by the thicker Glass $1\frac{11}{16}. 2\frac{3}{8}. 2\frac{11}{12}$, that is, the Diameters of the Rings are reciprocally in a subduplicate proportion of thicknesses of the plates of Glass.

So then in plates of Glass which are alike concave on one side, and alike convex on the other side, and alike quick-silvered on the convex sides, and differ in nothing, but

but their thickness, the Diameters of the Rings are reciprocally in a subduplicate proportion of the thicknesses of the plates. And this shews sufficiently that the Rings depend on both the surfaces of the Glafs. They depend on the convex surface because they are more luminous when that surface is quick-silvered over than when it is without Quick-silver. They depend also upon the concave surface, because without that surface a Speculum makes them not. They depend on both surfaces and on the distances between them, because their bigness is varied by varying only that distance. And this dependance is of the same kind with that which the Colours of thin plates have on the distance of the surfaces of those plates, because the bigness of the Rings and their proportion to one another, and the variation of their bigness arising from the variation of the thickness of the Glafs, and the orders of their Colours, is such as ought to result from the Propositions in the end of the third Part of this Book, derived from the the Phænomena of the Colours of thin plates set down in the first Part.

There are yet other Phænomena of these Rings of Colours but such as follow from the same Propositions, and therefore confirm both the truth of those Propositions, and the Analogy between these Rings and the Rings of Colours made by very thin plates. I shall subjoyn some of them.

O B S. X.

When the beam of the Sun's Light was reflected back from the Speculum not directly to the Hole in the Window, but to a place a little distant from it, the common center of that Spot, and of all the Rings of Colours fell in the middle way between the beam of the incident Light, and the beam of the reflected Light, and by consequence in the center of the spherical concavity of the Speculum, whenever the Chart on which the Rings of Colours fell was placed at that center. And as the beam of reflected Light by inclining the Speculum receded more and more from the beam of incident Light and from the common center of the coloured Rings between them, those Rings grew bigger and bigger, and so also did the white round Spot, and new Rings of Colours emerged successively out of their common center, and the white Spot became a white Ring encompassing them; and the incident and reflected beams of Light always fell upon the opposite parts of this Ring, illuminating its perimeter like two mock Suns in the opposite parts of an Iris. So then the Diameter of this Ring, measured from the middle of its Light on one side to the middle of its Light on the other side, was always equal to the distance between the middle of the incident beam of Light, and the middle of the reflected beam measured at the Chart on which the Rings appeared: And the rays which formed this Ring were reflected by the Speculum in Angles equal to their Angles of incidence, and by consequence to their Angles of refraction at their entrance into the Glass, but yet their Angles of

P p reflexion

reflexion were not in the same planes with their Angles of incidence.

O B S. XI.

The Colours of the new Rings were in a contrary order to those of the former, and arose after this manner. The white round Spot of Light in the middle of the Rings continued white to the center till the distance of the incident and reflected beams at the chart was about $\frac{7}{8}$ parts of an Inch, and then it began to grow dark in the middle. And when that distance was about $1\frac{1}{16}$ of an Inch, the white Spot was become a Ring encompassing a dark round Spot which in the middle inclined to violet and indico. And the luminous Rings incompassing it were grown equal to those dark ones which in the four first Observations encompassed them, that is to say, the white Spot was grown a white Ring equal to the first of those dark Rings, and the first of those luminous Rings was now grown equal to the second of those dark ones, and the second of those luminous ones to the third of those dark ones, and so on. For the Diameters of the luminous Rings were now $1\frac{1}{16}$, $2\frac{1}{16}$, $2\frac{2}{3}$, $3\frac{2}{20}$, &c. Inches.

When the distance between the incident and reflected beams of Light became a little bigger, there emerged out of the middle of the dark Spot after the indico a blue, and then out of that blue a pale green, and soon after a yellow and red. And when the Colour at the center was brightest, being between yellow and red, the bright Rings were grown equal to those Rings which in the four first Observations next encompassed them; that

that is to say, the white Spot in the middle of those Rings was now become a white Ring equal to the first of those bright Rings, and the first of those bright ones was now become equal to the second of those, and so on. For the Diameters of the white Rings, and of the other luminous Rings incompassing it, were now $1\frac{1}{8}$, $2\frac{1}{8}$, $2\frac{1}{2}$, $3\frac{1}{8}$, &c. or thereabouts.

When the distance of the two beams of Light at the Chart was a little more increased, there emerged out of the middle in order after the red, a purple, a blue, a green, a yellow, and a red inclining much to purple, and when the Colour was brightest being between yellow and red, the former indico, blue, green, yellow and red, were become an Iris or Ring of Colours equal to the first of those luminous Rings which appeared in the four first Observations, and the white Ring which was now become the second of the luminous Rings was grown equal to the second of those, and the first of those which was now become the third Ring was become the third of those, and so on. For their Diameters were $1\frac{1}{8}$, $2\frac{3}{8}$, $2\frac{1}{2}$, $3\frac{1}{8}$ Inches, the distance of the two beams of Light, and the Diameter of the white Ring being $2\frac{2}{5}$ Inches.

When these two beams became more distant there emerged out of the middle of the purplish red, first a darker round Spot, and then out of the middle of that Spot a brighter. And now the former Colours (purple, blue, green, yellow, and purplish red) were become a Ring equal to the first of the bright Rings mentioned in the four first Observations, and the Ring about this Ring were grown equal to the Rings about that respectively; the distance between the two beams of

Light and the Diameter of the white Ring (which was now become the third Ring) being about 3 Inches.

The Colours of the Rings in the middle began now to grow very dilute, and if the distance between the two beams was increased half an Inch, or an Inch more, they vanished whilst the white Ring, with one or two of the Rings next it on either side, continued still visible. But if the distance of the two beams of Light was still more increased these also vanished : For the Light which coming from several parts of the Hole in the Window fell upon the Speculum in several Angles of incidence made Rings of several bignesses, which diluted and blotted out one another, as I knew by intercepting some part of that Light. For if I intercepted that part which was nearest to the Axis of the Speculum the Rings would be less, if the other part which was remotest from it they would be bigger.

O B S. XII.

When the Colours of the Prism were cast successively on the Speculum, that Ring which in the two last Observations was white, was of the same bigness in all the Colours, but the Rings without it were greater in the green than in the blue, and still greater in the yellow, and greatest in the red. And, on the contrary, the Rings within that white Circle were less in the green than in the blue, and still less in the yellow, and least in the red. For the Angles of reflexion of those rays which made this Ring being equal to their Angles of incidence, the fits of every reflected ray within the Glass
after

after reflexion are equal in length and number to the fits of the same ray within the Glass before its incidence on the reflecting surface; and therefore since all the rays of all sorts at their entrance into the Glass were in a fit of transmission, they were also in a fit of transmission at their returning to the same surface after reflexion; and by consequence were transmitted and went out to the white Ring on the Chart. This is the reason why that Ring was of the same bigness in all the Colours, and why in a mixture of all it appears white. But in rays which are reflected in other Angles, the intervals of the fits of the least refrangible being greatest, make the Rings of their Colour in their progress from this white Ring, either outwards or inwards, increase or decrease by the greatest steps; so that the Rings of this Colour without are greatest, and within least. And this is the reason why in the last Observation, when the Speculum was illuminated with white Light, the exterior Rings made by all Colours appeared red without and blue within, and the interior blue without and red within.

These are the Phænomena of thick convexo-concave plates of Glass, which are every where of the same thickness. There are yet other Phænomena when these plates are a little thicker on one side than on the other, and others when the plates are more or less concave than convex, or plano-convex, or double-convex. For in all these cases the plates make Rings of Colours, but after various manners; all which, so far as I have yet observed, follow from the Propositions in the end of the third part of this Book, and so conspire to confirm the truth of those Propositions. But the Phæno-

mena

mena are too various, and the Calculations whereby they follow from those Propositions too intricate to be here prosecuted. I content my self with having prosecuted this kind of Phænomena so far as to discover their cause, and by discovering it to ratify the Propositions in the third Part of this Book.

O B S. XIII.

As Light reflected by a Lens quick-silvered on the back-side makes the Rings of Colours above described, so it ought to make the like Rings of Colours in passing through a drop of Water. At the first reflexion of the rays within the drop, some Colours ought to be transmitted, as in the case of a Lens, and others to be reflected back to the Eye. For instance, if the Diameter of a small drop or globule of Water be about the 500th part of an Inch, so that a red-making ray in passing through the middle of this globule has 250 fits of easy transmission within the globule, and that all the red-making rays which are at a certain distance from this middle ray round about it have 249 fits within the globule, and all the like rays at a certain further distance round about it have 248 fits, and all those at a certain further distance 247 fits, and so on; these concentrick Circles of rays after their transmission, falling on a white Paper, will make concentrick rings of red upon the Paper, supposing the Light which passes through one single globule strong enough to be sensible. And, in like manner, the rays of other Colours will make Rings of other Colours. Suppose now that in a fair day the Sun shines through a thin Cloud of such globules

globules of Water or Hail, and that the globules are all of the same bigness, and the Sun seen through this Cloud shall appear incompass'd with the like concentrick Rings of Colours, and the Diameter of the first Ring of red shall be $7\frac{1}{4}$ degrees, that of the second $10\frac{1}{2}$ degrees, that of the third 12 degrees 33 minutes. And accordingly as the globules of Water are bigger or less, the Rings shall be less or bigger. This is the Theory, and experience answers it. For in *June* 1692. I saw by reflexion in a Vessel of stagnating Water three Halos Crowns or Rings of Colours about the Sun, like three little Rainbows, concentrick to his Body. The Colours of the first or innermost Crown were blue next the Sun, red without, and white in the middle between the blue and red. Those of the second Crown were purple and blue within, and pale red without, and green in the middle. And those of the third were pale blue within, and pale red without; these Crowns inclosed one another immediately, so that their Colours proceeded in this continual order from the Sun outward: blue, white, red; purple, blue, green, pale yellow and red; pale blue, pale red. The Diameter of the second Crown measured from the middle of the yellow and red on one side of the Sun, to the middle of the same Colour on the other side was $9\frac{1}{2}$ degrees, or thereabouts. The Diameters of the first and third I had not time to measure, but that of the first seemed to be about five or six degrees, and that of the third about twelve. The like Crowns appear sometimes about the Moon; for in the beginning of the year 1664, *Febr.* 19th at night, I saw two such Crowns about her. The Diameter of the first or innermost was about three degrees, and that of the
second

second about five degrees and an half. Next about the Moon was a Circle of white, and next about that the inner Crown which was of a bluish green within next the white, and of a yellow and red without, and next about these Colours were blue and green on the inside of the outward Crown, and red on the outside of it. At the same time there appeared a Halo about 22 degrees 35' distant from the center of the Moon. It was Elliptical, and its long Diameter was perpendicular to the Horizon verging below farthest from the Moon. I am told that the Moon has sometimes three or more concentrick Crowns of Colours incompassing one another next about her Body. The more equal the globules of Water or Ice are to one another, the more Crowns of Colours will appear, and the Colours will be the more lively. The Halo at the distance of $22\frac{1}{2}$ degrees from the Moon is of another sort. By its being oval and remoter from the Moon below than above, I conclude, that it was made by refraction in some sort of Hail or Snow floating in the Air in an horizontal Posture, the refracting Angle being about 58 or 60 degrees.

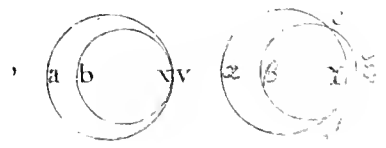
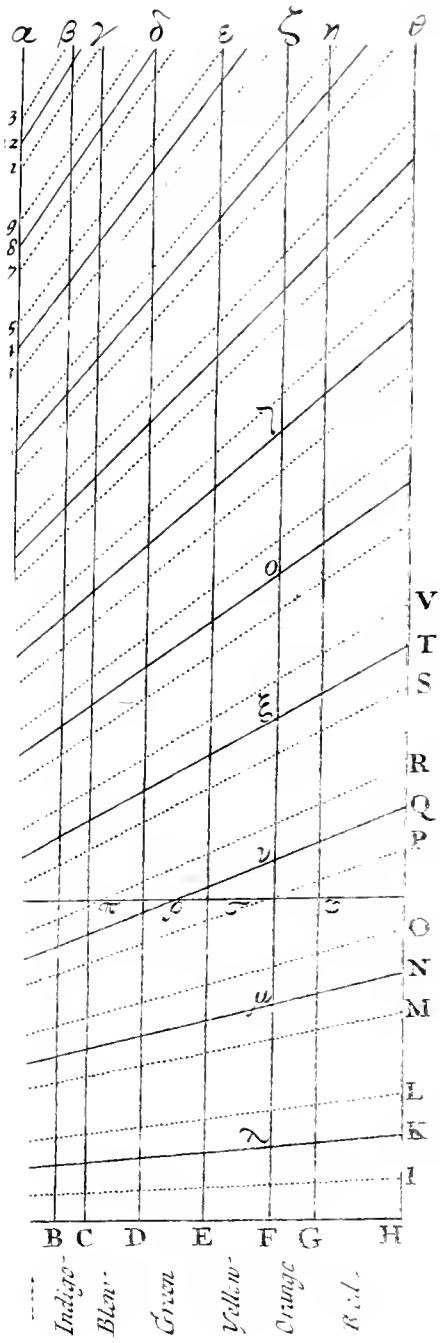

Fig. 5.



Fig. 6.

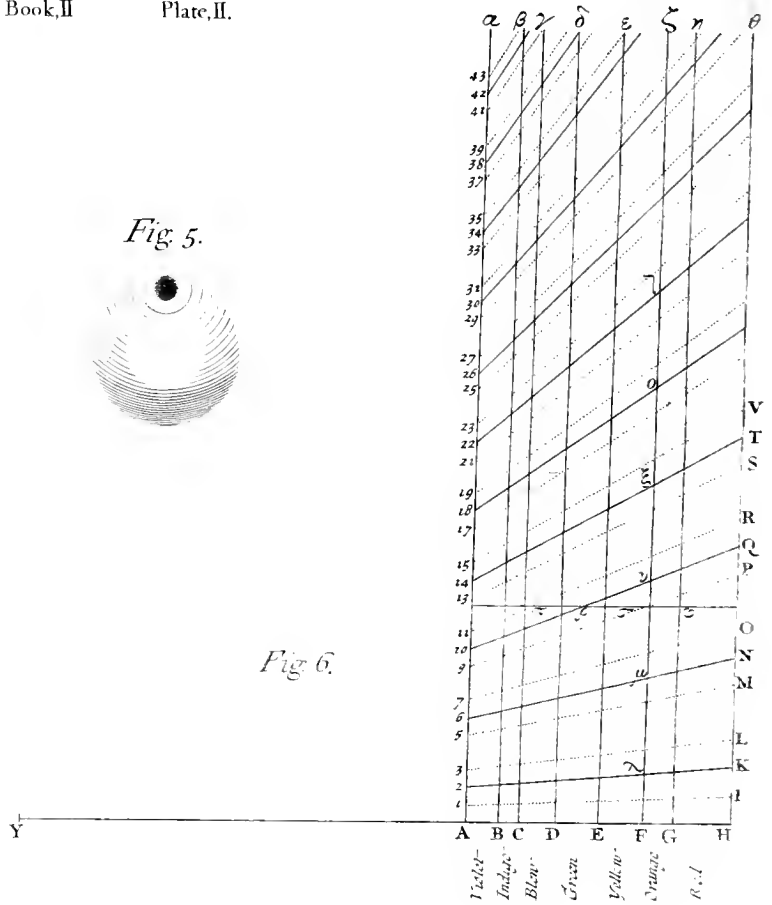
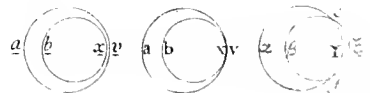

Fig. 7.



T H E

T H I R D B O O K

O F

O P T I C K S.

*Observations concerning the Inflexions of the rays of Light,
and the Colours made thereby.*

G *Rimaldo* has informed us, that if a beam of the Sun's Light be let into a dark Room through a very small Hole, the shadows of things in this Light will be larger than they ought to be if the rays went on by the Bodies in streight Lines, and that these shadows have three parallel fringes, bands or ranks of coloured Light adjacent to them. But if the Hole be enlarged the fringes grow broad and run into one another, so that they cannot be distinguished. These broad shadows and fringes have been reckoned by some to proceed from the ordinary refraction of the Air, but without due examination of the matter. For the circumstances of the Phænomenon, so far as I have observed them, are as follows.

Q q

O B S.

O B S. I.

I made in a piece of Lead a small Hole with a Pin, whose breadth was the 42th part of an Inch. For 21 of those Pins laid together took up the breadth of half an Inch. Through this Hole I let into my darkened Chamber a beam of the Sun's Light, and found that the shadows of Hairs, Thred, Pins, Straws, and such like slender substances placed in this beam of Light, were considerably broader than they ought to be, if the rays of Light passed on by these Bodies in right Lines. And particularly a Hair of a Man's Head, whose breadth was but the 280th part of an Inch, being held in this Light, at the distance of about twelve Feet from the Hole, did cast a shadow which at the distance of four Inches from the Hair was the sixtieth part of an Inch broad, that is, above four times broader than the Hair, and at the distance of two Feet from the Hair was about the eight and twentieth part of an Inch broad, that is, ten times broader than the Hair, and at the distance of ten Feet was the eighth part of an Inch broad, that is 35 times broader.

Nor is it material whether the Hair be incompassed with Air, or with any other pellucid substance. For I wetted a polished plate of Glafs, and laid the Hair in the Water upon the Glafs, and then laying another polished plate of Glafs upon it, so that the Water might fill up the space between the Glasses, I held them in the aforesaid beam of Light, so that the Light might pass through them perpendicularly, and the shadow of the Hair was at the same distances as big as before.

The

The shadows of scratches made in polished plates of Glass were also much broader than they ought to be, and the Veins in polished plates of Glass did also cast the like broad shadows. And therefore the great breadth of these shadows proceeds from some other cause than the refraction of the Air.

Let the Circle X represent the middle of the Hair; *Fig. 1.*
 ADG, BEH, CFI, three rays passing by one side of the Hair at several distances; KNQ, LOR, MPS, three other rays passing by the other side of the Hair at the like distances; D, E, F and N, O, P, the places where the rays are bent in their passage by the Hair; G, H, I and Q, R, S, the places where the rays fall on a Paper GQ; IS the breadth of the shadow of the Hair cast on the Paper, and TI, VS, two rays passing to the points I and S without bending when the Hair is taken away. And it's manifest that all the Light between these two rays AI and VS is bent in passing by the Hair, and turned aside from the shadow IS, because if any part of this Light were not bent it would fall on the Paper within the shadow, and there illuminate the Paper contrary to experience. And because when the Paper is at a great distance from the Hair, the shadow is broad, and therefore the rays TI and VS are at a great distance from one another, it follows that the Hair acts upon the rays of Light at a good distance in their passing by it. But the action is strongest on the rays which pass by at least distances, and grows weaker and weaker accordingly as the rays pass by at distances greater and greater, as is represented in the Scheme: For thence it comes to pass, that the shadow of the Hair is much broader in proportion to the distance of

Q q 2

the

the Paper from the Hair, when the Paper is nearer the Hair than when it is at a great distance from it.

O B S. II.

The shadows of all Bodies (Metals, Stones, Glafs, Wood, Horn, Ice, &c.) in this Light were bordered with three parallel fringes or bands of coloured Light, whereof that which was contiguous to the shadow was broadest and most luminous, and that which was remotest from it was narrowest, and so faint, as not easily to be visible. It was difficult to distinguish the Colours unless when the Light fell very obliquely upon a smooth Paper, or some other smooth vvhite Body, so as to make them appear much broader than they vould otherwise do. And then the Colours were plainly visible in this order : The first or innermost fringe was violet and deep blue next the shadow, and then light blue, green and yellow in the middle, and red vvithout. The second fringe vvas almost contiguous to the first, and the third to the second, and both vvere blue vvithin and yellow and red vvithout, but their Colours vvere very faint especially those of the third. The Colours therefore proceeded in this order from the shadow, violet, indico, pale blue, green, yellow, red ; blue, yellow, red ; pale blue, pale yellow and red. The shadows made by scratches and bubbles in polished plates of Glafs vvere bordered vvith the like fringes of coloured Light. And if plates of Looking-glafs sloop'd off near the edges vvith a Diamond cut, be held in the same beam of Light, the Light which passes through the parallel planes of the Glafs will be bordered with the like fringes of Colours

lours where those Planes meet with the Diamond cut, and by this means there will sometimes appear four or five fringes of Colours. Let AB, CD represent the parallel planes of a Looking-glass, and BD the plane of the Diamond-cut, making at B a very obtuse Angle with the plane AB. And let all the Light between the rays ENI and FBM pass directly through the parallel planes of the Glass, and fall upon the Paper between I and M, and all the Light between the rays GO and HD be refracted by the oblique plane of the Diamond cut BD, and fall upon the Paper between K and L; and the Light which passes directly through the parallel planes of the Glass, and falls upon the Paper between I and M, will be bordered with three or more fringes at M. Fig. 2.

O B S. III.

When the Hair was twelve Feet distant from the Hole, and its shadow fell obliquely upon a flat white scale of Inches and parts of an Inch placed half a Foot beyond it, and also when the shadow fell perpendicularly upon the same scale placed nine Feet beyond it; I measured the breadth of the shadow and fringes as accurately as I could, and found them in parts of an Inch as follows.

The

	<i>At the distance of</i>	<i>half a</i> <i>Foot.</i>	<i>nine</i> <i>Feet.</i>
The breadth of the Shadow		$\frac{1}{54}$	$\frac{1}{9}$
The breadth between the middles of the brightest Light of the innermost fringes on either side the shadow		$\frac{1}{33}$ or $\frac{1}{37}$	$\frac{7}{50}$
The breadth between the middles of the brightest Light of the middlemost fringes on either side the shadow		$\frac{1}{23\frac{1}{2}}$	$\frac{4}{17}$
The breadth between the middles of the brightest Light of the outmost fringes on either side the shadow		$\frac{1}{18}$ or $\frac{1}{18\frac{1}{2}}$	$\frac{3}{10}$
The distance between the middles of the brightest Light of the first and second fringes		$\frac{1}{120}$	$\frac{1}{21}$
The distance between the middles of the brightest Light of the second and third fringes		$\frac{1}{170}$	$\frac{1}{31}$
The breadth of the luminous part (green, white, yellow and red) of the first fringe		$\frac{1}{170}$	$\frac{1}{32}$
The breadth of the darker space between the first and second fringes.		$\frac{1}{240}$	$\frac{1}{45}$
The breadth of the luminous part of the second fringe		$\frac{1}{270}$	$\frac{1}{55}$
The breadth of the darker space between the second and third fringes.		$\frac{1}{310}$	$\frac{1}{63}$

These

These measures I took by letting the shadow of the Hair at half a Foot distance fall so obliquely on the scale as to appear twelve times broader than vwhen it fell perpendicularly on it at the same distance, and setting down in this Table the twelfth part of the measures I then took.

O B S. I V.

When the shadow and fringes vvere cast obliquely upon a smooth vvhite Body, and that Body was removed further and further from the Hair, the first fringe began to appear and look brighter than the rest of the Light at the distance of less than a quarter of an Inch from the Hair, and the dark line or shadow between that and the second fringe began to appear at a less distance from the Hair than that of the third part of an Inch. The second fringe began to appear at a distance from the Hair of less than half an Inch, and the shadow between that and the third fringe at a distance less than an Inch, and the third fringe at a distance less than three Inches. At greater distances they became much more sensible, but kept very nearly the same proportion of their breadths and intervals which they had at their first appearing. For the distance between the middle of the first and middle of the second fringe, was to the distance between the middle of the second and middle of the third fringe, as three to two, or ten to seven. And the last of these two distances vvas equal to the breadth of the bright Light or luminous part of the first fringe. And this breadth vvas to the breadth of the bright Light of the second fringe as seven to four, and to the dark interval

interval of the first and second fringe as three to two, and to the like dark interval between the second and third as two to one. For the breadths of the fringes seemed to be in the progression of the numbers 1, $\sqrt{\frac{1}{3}}$, $\sqrt{\frac{1}{5}}$ and their intervals to be in the same progression with them; that is, the fringes and their intervals together to be in the continual progression of the numbers 1, $\sqrt{\frac{1}{2}}$, $\sqrt{\frac{1}{3}}$, $\sqrt{\frac{1}{4}}$, $\sqrt{\frac{1}{5}}$, or thereabouts. And these proportions held the same very nearly at all distances from the Hair; the dark Intervals of the fringes being as broad in proportion to the fringes at their first appearance as afterwards at great distances from the Hair, though not so dark and distinct.

O B S. V.

The Sun shining into my darkened Chamber through a Hole a quarter of an Inch broad; I placed at the distance of two or three Feet from the Hole a Sheet of Past-board, which was black'd all over on both sides, and in the middle of it had a Hole about three quarters of an Inch square for the Light to pass through. And behind the Hole I fastened to the Past-board with Pitch the blade of a sharp Knife, to intercept some part of the Light which passed through the Hole. The planes of the Past-board and blade of the Knife were parallel to one another, and perpendicular to the rays. And when they were so placed that none of the Sun's Light fell on the Past-board, but all of it passed through the Hole to the Knife, and there part of it fell upon the blade of the Knife, and part of it passed by its edge: I let this part of the Light which passed by, fall on a
white

white Paper two or three Feet beyond the Knife, and there saw two streams of faint Light shoot out both ways from the beam of Light into the shadow like the tails of Comets. But because the Sun's direct Light by its brightness upon the Paper obscured these faint streams, so that I could scarce see them, I made a little Hole in the midst of the Paper for that Light to pass through and fall on a black cloth behind it; and then I saw the two streams plainly. They were like one another, and pretty nearly equal in length and breadth, and quantity of Light. Their Light at that end next the Sun's direct Light was pretty strong for the space of about a quarter of an Inch, or half an Inch, and in all its progress from that direct Light decreased gradually till it became insensible. The whole length of either of these streams measured upon the Paper at the distance of three Feet from the Knife was about six or eight Inches; so that it subtended an Angle at the edge of the Knife of about 10 or 12, or at most 14 degrees. Yet sometimes I thought I saw it shoot three or four degrees further, but with a Light so very faint that I could scarce perceive it, and suspected it might (in some measure at least) arise from some other cause than the two streams did. For placing my Eye in that Light beyond the end of that stream which was behind the Knife, and looking towards the Knife, I could see a line of Light upon its edge, and that not only when my Eye was in the line of the streams, but also when it was without that line either towards the point of the Knife, or towards the handle. This line of Light appeared contiguous to the edge of the Knife, and was narrower than the Light of the innermost fringe, and

narrowest when my Eye was furthest from the direct Light, and therefore seemed to pass between the Light of that fringe and the edge of the Knife, and that which passed nearest the edge to be most bent, though not all of it.

O B S. VI.

I placed another Knife by this so that their edges might be parallel and look towards one another, and that the beam of Light might fall upon both the Knives, and some part of it pass between their edges. And when the distance of their edges was about the 400th part of an Inch the stream parted in the middle, and left a shadow between the two parts. This shadow was so black and dark that all the Light which passed between the Knives seemed to be bent, and turned aside to the one hand or to the other. And as the Knives still approached one another the shadow grew broader, and the streams shorter at their inward ends which were next the shadow, until upon the contact of the Knives the whole Light vanished leaving its place to the shadow.

And hence I gather that the Light which is least bent, and goes to the inward ends of the streams, passes by the edges of the Knives at the greatest distance, and this distance when the shadow begins to appear between the streams is about the eight-hundredth part of an Inch. And the Light which passes by the edges of the Knives at distances still less and less is more and more bent, and goes to those parts of the streams which are further and further from the direct Light, because
when

when the Knives approach one another till they touch, those parts of the streams vanish last which are furthest from the direct Light.

O B S. VII.

In the fifth Observation the fringes did not appear, but by reason of the breadth of the Hole in the Window became so broad as to run into one another, and by joyning make one continued Light in the beginning of the streams. But in the sixth, as the Knives approached one another, a little before the shadow appeared between the two streams, the fringes began to appear on the inner ends of the streams on either side of the direct Light, three on one side made by the edge of one Knife, and three on the other side made by the edge of the other Knife. They were distinctest when the Knives were placed at the greatest distance from the Hole in the Window, and still became more distinct by making the Hole less, insomuch that I could sometimes see a faint lineament of a fourth fringe beyond the three above-mentioned. And as the Knives continually approached one another, the fringes grew distincter and larger until they vanished. The outmost fringe vanished first, and the middlemost next, and the innermost last. And after they were all vanished, and the line of Light which was in the middle between them was grown very broad, enlarging it self on both sides into the streams of Light described in the fifth Observation, the above-mentioned shadow began to appear in the middle of this line, and divide it along the middle into two lines of Light, and increased until the whole

Light vanished. This enlargement of the fringes was so great that the rays which go to the innermost fringe seemed to be bent above twenty times more when this fringe was ready to vanish, than when one of the Knives was taken away.

And from this and the former Observation compared, I gather, that the Light of the first fringe passed by the edge of the Knife at a distance greater than the eight-hundredth part of an Inch, and the Light of the second fringe passed by the edge of the Knife at a greater distance than the Light of the first fringe did, and that of the third at a greater distance than that of the second, and that of the streams of Light described in the fifth and sixth Observations passed by the edges of the Knives at less distances than that of any of the fringes.

O B S. VIII.

I caused the edges of two Knives to be ground truly streight, and pricking their points into a board so that their edges might look towards one another, and meeting near their points contain a rectilinear Angle, I fastened their handles together with Pitch to make this Angle invariable. The distance of the edges of the Knives from one another at the distance of four Inches from the angular point, where the edges of the Knives met, was the eighth part of an Inch, and therefore the Angle contained by the edges was about 1 degr. 54'. The Knives thus fixed together I placed in a beam of the Sun's Light, let into my darkened Chamber through a Hole the 42th part of an Inch wide, at the distance
of

of ten or fifteen Feet from the Hole, and let the Light which passed between their edges fall very obliquely upon a smooth white Ruler at the distance of half an Inch, or an Inch from the Knives, and there saw the fringes made by the two edges of the Knives run along the edges of the shadows of the Knives in lines parallel to those edges without growing sensibly broader, till they met in Angles equal to the Angle contained by the edges of the Knives, and where they met and joyned they ended without crossing one another. But if the Ruler was held at a much greater distance from the Paper, the fringes became something broader and broader as they approached one another, and after they met they crossed one another, and then became much broader than before.

Whence I gather that the distances at which the fringes pass by the Knives are not increased nor altered by the approach of the Knives, but the Angles in which the rays are there bent are much increased by that approach; and that the Knife which is nearest any ray determines which way the ray shall be bent, and the other Knife increases the bent.

O B S. IX.

When the rays fell very obliquely upon the Ruler at the distance of the third part of an Inch from the Knives, the dark line between the first and second fringe of the shadow of one Knife, and the dark line between the first and second fringe of the shadow of the other Knife met with one another, at the distance of the fifth part of an Inch from the end of the Light which passed between
 between

tween the Knives at the concurrence of their edges. And therefore the distance of the edges of the Knives at the meeting of these dark lines was the 160th part of an Inch. For as four Inches to the eighth part of an Inch, so is any length of the edges of the Knives measured from the point of their concurrence to the distance of the edges of the Knives at the end of that length, and so is the fifth part of an Inch to the 160th part. So then the dark lines above-mentioned meet in the middle of the Light which passes between the Knives where they are distant the 160th part of an Inch, and the one half of that Light passes by the edge of one Knife at a distance not greater than the 320th part of an Inch, and falling upon the Paper makes the fringes of the shadow of that Knife, and the other half passes by the edge of the other Knife, at a distance not greater than the 320th part of an Inch, and falling upon the Paper makes the fringes of the shadow of the other Knife. But if the Paper be held at a distance from the Knives greater than the third part of an Inch, the dark lines above-mentioned meet at a greater distance than the fifth part of an Inch from the end of the Light which passed between the Knives at the concurrence of their edges; and therefore the Light which falls upon the Paper where those dark lines meet passes between the Knives where their edges are distant above the 160th part of an Inch.

For at another time when the two Knives were distant eight Feet and five Inches from the little Hole in the Window, made with a small Pin as above, the Light which fell upon the Paper where the aforesaid dark lines met. passed between the Knives, where the distance

stance between their edges was as in the following Table, when the distance of the Paper from the Knives was also as follows.

<i>Distances of the Paper from the Knives in Inches.</i>	<i>Distances between the edges of the Knives in millimal parts of an Inch.</i>
$1\frac{1}{2}$.	0'012.
$3\frac{1}{3}$.	0'020.
$8\frac{2}{5}$.	0'034.
32.	0'057.
96.	0'081.
131.	0'087.

And hence I gather that the Light which makes the fringes upon the Paper is not the same Light at all distances of the Paper from the Knives, but when the Paper is held near the Knives, the fringes are made by Light which passes by the edges of the Knives at a less distance, and is more bent than when the Paper is held at a greater distance from the Knives.

O B S. X.

When the fringes of the shadows of the Knives fell perpendicularly upon a Paper at a great distance from the Knives, they were in the form of Hyperbolas, and their dimensions were as follows. Let CA, CB represent lines drawn upon the Paper parallel to the edges of the Knives, and between which all the Light would fall, if it passed between the edges of the Knives without inflexion; DE a right line drawn through C making the

the Angles ACD , BCE , equal to one another, and terminating all the Light which falls upon the Paper from the point where the edges of the Knives meet; eis , $fk t$, and glv , three hyperbolical lines representing the terminus of the shadow of one of the Knives, the dark line between the first and second fringes of that shadow, and the dark line between the second and third fringes of the same shadow; xip , ykq and zlr , three other Hyperbolical lines representing the terminus of the shadow of the other Knife, the dark line between the first and second fringes of that shadow, and the dark line between the second and third fringes of the same shadow. And conceive that these three Hyperbolas are like and equal to the former three, and cross them in the points i , k and l , and that the shadows of the Knives are terminated and distinguished from the first luminous fringes by the lines eis and xip , until the meeting and crossing of the fringes, and then those lines cross the fringes in the form of dark lines, terminating the first luminous fringes within side, and distinguishing them from another Light which begins to appear at i , and illuminates all the triangular space $ipDEs$ comprehended by these dark lines, and the right line DE . Of these Hyperbolas one Asymptote is the line DE , and their other Asymptotes are parallel to the lines CA and CB . Let rv represent a line drawn any where upon the Paper parallel to the Asymptote DE , and let this line cross the right lines AC in m and BC in n , and the six dark hyperbolical lines in p , q , r ; s , t , v ; and by measuring the distances ps , qt , rv , and thence collecting the the lengths of the ordinates np , nq , nr or ms , mt , mv , and doing this at several distances of the line rv ,
from

from the Asymptote DE you may find as many points of these Hyperbolas as you please, and thereby know that these curve lines are Hyperbolas differing little from the conical Hyperbola. And by measuring the lines Ci, Ck, Cl, you may find other points of these Curves.

For instance, when the Knives were distant from the Hole in the Window ten Feet, and the Paper from the Knives 9 Feet, and the Angle contained by the edges of the Knives to which the Angle ACB is equal, was subtended by a chord which was to the Radius as 1 to 32, and the distance of the line rv from the Asymptote DE was half an Inch: I measured the lines ps, qt, rv, and found them 0'35, 0'65, 0'98 Inches respectively, and by adding to their halves the line $\frac{1}{2}$ mn (which here was the 128th part of an Inch, or 0'0078 Inches) the sums np, nq, nr, were 0'1828, 0'3328, 0'4978 Inches. I measured also the distances of the brightest parts of the fringes which run between pq and st, qr and tv, and next beyond r and v, and found them 0'5, 0'8, and 1'17 Inches.

O B S. XI.

The Sun shining into my darkened Room through a small round Hole made in a plate of Lead with a slender Pin as above; I placed at the Hole a Prism to refract the Light, and form on the opposite Wall the Spectrum of Colours, described in the third Experiment of the first Book. And then I found that the shadows of all Bodies held in the coloured Light between the Prism and the Wall, were bordered with fringes of the Colour

S s

of

of that Light in which they were held. In the full red Light they were totally red without any sensible blue or violet, and in the deep blue Light they were totally blue without any sensible red or yellow ; and so in the green Light they were totally green, excepting a little yellow and blue, which were mixed in the green Light of the Prism. And comparing the fringes made in the several coloured Lights, I found that those made in the red Light were largest, those made in the violet were least, and those made in the green were of a middle bigness. For the fringes with which the shadow of a Man's Hair were bordered, being measured cross the shadow at the distance of six Inches from the Hair ; the distance between the middle and most luminous part of the first or innermost fringe on one side of the shadow, and that of the like fringe on the other side of the shadow, was in the full red Light $\frac{1}{37\frac{1}{2}}$ of an Inch, and in the full violet $\frac{1}{46}$. And the like distance between the middle and most luminous parts of the second fringes on either side the shadow was in the full red Light $\frac{1}{22}$, and in the violet $\frac{1}{27}$ of an Inch. And these distances of the fringes held the same proportion at all distances from the Hair without any sensible variation.

So then the rays which made these fringes in the red Light passed by the Hair at a greater distance than those did which made the like fringes in the violet ; and therefore the Hair in causing these fringes acted alike upon the red Light or least refrangible rays at a greater distance, and upon the violet or most refrangible rays at a less distance, and by those actions disposed the red Light into larger fringes, and the violet into smaller, and the Lights of intermediate Colours into fringes of inter-

intermediate bignesses without changing the Colour of of any sort of Light.

When therefore the Hair in the first and second of these Observations was held in the white beam of the Sun's Light, and cast a shadow which was bordered with three fringes of coloured Light, those Colours arose not from any new modifications impressed upon the rays of Light by the Hair, but only from the various inflections whereby the several sorts of rays were separated from one another, which before separation by the mixture of all their Colours, composed the white beam of the Sun's Light, but whenever separated compose Lights of the several Colours which they are originally disposed to exhibit. In this 13th Observation, where the Colours are separated before the Light passes by the Hair, the least refrangible rays, which when separated from the rest make red, were inflected at a greater distance from the Hair, so as to make three red fringes at a greater distance from the middle of the shadow of the Hair; and the most refrangible rays which when separated make violet, were inflected at a less distance from the Hair, so as to make three violet fringes at a less distance from the middle of the shadow of the Hair. And other rays of intermediate degrees of refrangibility were inflected at intermediate distances from the Hair, so as to make fringes of intermediate Colours at intermediate distances from the middle of the shadow of the Hair. And in the second Observation, where all the Colours are mixed in the white Light which passes by the Hair, these Colours are separated by the various inflexions of the rays, and the fringes which they make appear all together, and the innermost

S s 2

fringes

fringes being contiguous make one broad fringe composed of all the Colours in due order, the violet lying on the inside of the fringe next the shadow, the red on the outside furthest from the shadow, and the blue, green and yellow, in the middle. And, in like manner, the middlemost fringes of all the Colours lying in order, and being contiguous, make another broad fringe composed of all the Colours; and the outmost fringes of all the Colours lying in order, and being contiguous, make a third broad fringe composed of all the Colours. These are the three fringes of coloured Light with which the shadows of all Bodies are bordered in the second Observation.

When I made the foregoing Observations, I designed to repeat most of them with more care and exactness, and to make some new ones for determining the manner how the rays of Light are bent in their passage by Bodies for making the fringes of Colours with the dark lines between them. But I was then interrupted, and cannot now think of taking these things into further consideration. And since I have not finished this part of my Design, I shall conclude, with proposing only some Queries in order to a further search to be made by others.

Query 1. Do not Bodies act upon Light at a distance, and by their action bend its rays, and is not this action (*cæteris paribus*) strongest at the least distance?

Qu. 2. Do not the rays which differ in refrangibility differ also in flexibility, and are they not by their different inflexions separated from one another, so as after separation to make the Colours in the three fringes.
above

above described? And after what manner are they inflected to make those fringes?

Qu. 3. Are not the rays of Light in passing by the edges and sides of Bodies, bent several times backwards and forwards, with a motion like that of an Eel? And do not the three fringes of coloured Light above-mentioned, arise from three such bendings?

Qu. 4. Do not the rays of Light which fall upon Bodies, and are reflected or refracted, begin to bend before they arrive at the Bodies; and are they not reflected, refracted and inflected by one and the same Principle, acting variously in various circumstances?

Qu. 5. Do not Bodies and Light act mutually upon one another, that is to say, Bodies upon Light in emitting, reflecting, refracting and inflecting it, and Light upon Bodies for heating them, and putting their parts into a vibrating motion wherein heat consists?

Qu. 6. Do not black Bodies conceive heat more easily from Light than those of other Colours do, by reason that the Light falling on them is not reflected outwards, but enters the Bodies, and is often reflected and refracted within them, until it be stifled and lost?

Qu. 7. Is not the strength and vigor of the action between Light and sulphureous Bodies observed above, one reason why sulphureous Bodies take fire more readily, and burn more vehemently, than other Bodies do?

Qu. 8. Do not all fixt Bodies when heated beyond a certain degree, emit Light and shine, and is not this emission performed by the vibrating motions of their parts?

Qu. 9.

Qu. 9. Is not fire a Body heated ſo hot as to emit Light copiouſly? For what elſe is a red hot Iron than fire? And what elſe is a burning Coal than red hot Wood?

Qu. 10. Is not flame a vapour, fume or exhalation heated red hot, that is, ſo hot as to ſhine? For Bodies do not flame without emitting a copious fume, and this fume burns in the flame. The *Ignis Fatuus* is a vapour ſhining without heat, and is there not the ſame difference between this vapour and flame, as between rotten Wood ſhining without heat and burning Coals of fire? In diſtilling hot Spirits, if the head of the ſtill be taken off, the vapour which aſcends out of the Still will take fire at the flame of a Candle, and turn into flame, and the flame will run along the vapour from the Candle to the Still. Some Bodies heated by motion or fermentation, if the heat grow intense fume copiouſly, and if the heat be great enough the fumes will ſhine and become flame. Metals in fuſion do not flame for want of a copious fume, except Spelter which fumes copiouſly, and thereby flames. All flaming Bodies, as Oyl, Tallow, Wax, Wood, foſſil Coals, Pitch, Sulphur, by flaming waſte and vaniſh into burning ſmoke, which ſmoke, if the flame be put out, is very thick and viſible, and ſometimes ſmells ſtrongly, but in the flame loſes its ſmell by burning, and according to the nature of the ſmoke the flame is of ſeveral Colours, as that of Sulphur blue, that of Copper opened with Sublimate green, that of Tallow yellow. Smoke paſſing through flame cannot but grow red hot, and red hot ſmoke can have no other appearance than that of flame.

Qu. 11. Do not great Bodies conſerve their heat the longeſt, their parts heating one another, and may not great denſe and fix'd Bodies, when heated beyond a certain degree, emit Light ſo copiouſly, as by the emission and reaction of its Light, and the reflexions and refractions of its rays within its pores to grow ſtill hotter, till it comes to a certain period of heat, ſuch as is that of the Sun? And are not the Sun and fix'd Stars great Earths vehemently hot, whoſe heat is conſerved by the greatneſs of the Bodies, and the mutual action and reaction between them, and the Light which they emit, and whoſe parts are kept from fuming away, not only by their fixity, but alſo by the vaſt weight and denſity of the Atmospheres incumbent upon them, and very ſtrongly compréſſing them, and condenſing the vapours and exhalations which ariſe from them?

Qu. 12. Do not the rays of Light in falling upon the bottom of the Eye excite vibrations in the *Tunica retina*? Which vibrations, being propagated along the ſolid fibres of the optick Nerves into the Brain, cauſe the ſenſe of ſeeing. For becauſe denſe Bodies conſerve their heat a long time, and the denſeſt Bodies conſerve their heat the longeſt, the vibrations of their parts are of a laſting nature, and therefore may be propagated along ſolid fibres of uniform denſe matter to a great diſtance, for conveying into the Brain the impreſſions made upon all the Organs of ſenſe. For that motion which can continue long in one and the ſame part of a Body, can be propagated a long way from one part to another, ſuppoſing the Body homogeneous, ſo that the motion may not be reflected, refracted, interrupted or diſordered by any unevenneſs of the Body.

Qu. 13.

Qu. 13. Do not several sort of rays make vibrations of several bignesses, which according to their bignesses excite sensations of several Colours, much after the manner that the vibrations of the Air, according to their several bignesses excite sensations of several sounds? And particularly do not the most refrangible rays excite the shortest vibrations for making a sensation of deep violet, the least refrangible the largest for making a sensation of deep red, and the several intermediate sorts of rays, vibrations of several intermediate bignesses to make sensations of the several intermediate Colours?

Qu. 14. May not the harmony and discord of Colours arise from the proportions of the vibrations propagated through the fibres of the optick Nerves into the Brain, as the harmony and discord of sounds arises from the proportions of the vibrations of the Air? For some Colours are agreeable, as those of Gold and Indico, and others disagree.

Qu. 15. Are not the Species of Objects seen with both Eyes united where the optick Nerves meet before they come into the Brain, the fibres on the right side of both Nerves uniting there, and after union going thence into the Brain in the Nerve which is on the right side of the Head, and the fibres on the left side of both Nerves uniting in the same place, and after union going into the Brain in the Nerve which is on the left side of the Head, and these two Nerves meeting in the Brain in such a manner that their fibres make but one entire Species or Picture, half of which on the right side of the Sensorium comes from the right side of both Eyes through the right side of both

both optick Nerves to the place where the Nerves meet, and from thence on the right side of the Head into the Brain, and the other half on the left side of the Sensorium comes in like manner from the left side of both Eyes. For the optick Nerves of such Animals as look the same way with both Eyes (as of Men, Dogs, Sheep, Oxen, &c.) meet before they come into the Brain, but the optick Nerves of such Animals as do not look the same way with both Eyes (as of Fishes and of the Chameleon) do not meet, if I am rightly informed.

Qu. 16. When a Man in the dark presses either corner of his Eye with his Finger, and turns his Eye away from his Finger, he will see a Circle of Colours like those in the Feather of a Peacock's Tail? Do not these Colours arise from such motions excited in the bottom of the Eye by the pressure of the Finger, as at other times are excited there by Light for causing Vision? And when a Man by a stroke upon his Eye sees a Flash of Light, are not the like Motions excited in the *Retina* by the stroke?

ENUMERATIO

LINEARUM

TERTII ORDINIS.

E N U M E R A T I O

L I N E A R U M

T E R T I I O R D I N I S .

Lineæ Geometricæ secundum numerum dimensionum æquationis qua relatio inter Ordinatas & Abscissas definitur, vel (quod perinde est) secundum numerum punctorum in quibus a linea recta secari possunt, optimè distinguuntur in Ordines. Qua ratione linea primi Ordinis erit Recta sola, eæ secundi sive quadratici ordinis erunt sectiones Conicæ & Circulus, & eæ tertii sive cubici Ordinis Parabola Cubica, Parabola Neiliana, Cissois veterum & reliquæ quas hic enumerare suscepimus. Curva autem primi generis, (siquidem recta inter Curvas non est numeranda) eadem est cum Linea secundi Ordinis, & Curva secundi generis eadem cum Linea Ordinis tertii. Et Linea Ordinis infinitesimi ea est quam recta in punctis infinitis secare potest, qualis est Spiralis, Cyclois, Quadratrix & linea omnis quæ per radii vel rotæ revolutiones infinitas generatur.

I:
Linearum Ordines.

II.
Proprietates Sectionem Conicarum competunt Curvis superiorum generum.

Sectionum Conicarum proprietates præcipuæ & Geometris passim traduntur. Et confimiles sunt proprietates Curvarum secundi generis & reliquarum, ut ex sequenti proprietatum præcipuarum enumeratione constabit.

III.
Curvarum secundi generis Ordinata, Diametri, Vertices, Centra, Axes.

Nam si rectæ plures parallelæ & ad conicam sectionem utrinq; terminatæ ducantur, recta duas earum bifecans bifecabit alias omnes, ideoq; dicitur *Diameter* figuræ & rectæ bifectæ dicuntur *Ordinatum applicatæ* ad *Diametrum*, & concursus omnium *Diametrorum* est *Centrum* figuræ, & interseccio *Curvæ* & *diametri Vertex* nominatur, & *diameter illa Axis* est cui *ordinatim applicatæ* insistant ad angulos rectos. Et ad eundem modum in *Curvis* secundi generis, si rectæ duæ quævis parallelæ ducantur occurrentes *Curvæ* in tribus punctis: recta quæ ita fecat has parallelas ut summa duarum partium ex uno secantis latere ad curvam terminatarum æquetur parti tertiæ ex altero latere ad curvam terminatæ, eodem modo secabit omnes alias his parallelas curvæq; in tribus punctis occurrentes rectas, hoc est, ita ut summa partium duarum ex uno ipsius latere semper æquetur parti tertiæ ex altero latere. Has itaq; tres partes quæ hinc inde æquantur, *Ordinatum applicatas* & rectam secantem cui *ordinatim applicantur Diametrum* & interseccionem *diametri* & *curvæ Verticem* & concursus duarum *diametrorum Centrum* nominare licet. *Diameter* autem ad *Ordinatas* rectangula si modo aliqua sit, etiam *Axis* dici potest, & ubi omnes *diametri* in eodem puncto concurrunt istud erit *Centrum generale*.

Hyper-

Hyperbola primi generis duas *Asymptotas*, ea secundi tres, ea tertii quatuor & non plures habere potest, & sic in reliquis. Et quemadmodum partes lineæ cujuscvis rectæ inter Hyperbolam Conicam & duas ejus *Asymptotas* sunt hinc inde æquales : sic in Hyperbolis secundi generis si ducatur recta quævis secans tam Curvam quam tres ejus *Asymptotas* in tribus punctis, summa duarum partium istius rectæ quæ a duobus quibusvis *Asymptotis* in eandem plagam ad duo puncta Curvæ extenduntur æqualis erit parti tertiæ quæ a tertia *Asymptoto* in plagam contrariam ad tertium Curvæ punctum extenditur.

Et quemadmodum in Conicis sectionibus non Parabolicis quadratum Ordinatim applicatæ, hoc est, rectangulum Ordinarum quæ ad contrarias partes Diametri ducuntur, est ad rectangulum partium Diametri quæ ad Vertices Ellipseos vel Hyperbolæ terminantur, ut data quædam linea quæ dicitur *Latus rectum*, ad partem diametri quæ inter Vertices jacet & dicitur *Latus transversum* : sic in Curvis non Parabolicis secundi generis Parallelepipedum sub tribus Ordinatim applicatis est ad Parallelepipedum sub partibus Diametri ad Ordinatas & tres Vertices figuræ abscissis, in ratione quadam data : in qua ratione si sumantur tres rectæ ad tres partes diametri inter vertices figuræ sitas singulæ ad singulas, tunc illæ tres rectæ dici possunt *Latera recta* figuræ, & illæ partes Diametri inter Vertices *Latera transversa*. Et sicut in Parabola Conica quæ ad unam & eandem diametrum unicum tantum habet Verticem, rectangulum sub Ordinatis æquatur rectangulo sub parte Diametri quæ ad Ordinatas & Verticem abscinditur & recta quadam.

IV.
*Asymptoti eorum proprieta-
tes*

V.
Latera recta & transversa

quadam data quæ Latus rectum dicitur, sic in Curvis secundi generis quæ non nisi duos habent Vertices ad eandem Diametrum, Parallelepipedum sub Ordinatis tribus æquatur Parallelepipedo sub duabus partibus Diametri ad Ordinatas & Vertices illos duos abscissis, & recta quadam data quæ proinde *Latus rectum* dici potest.

VI.
Ratio contentorum sub Parallelarum segmentis.

Deniq; sicut in Conicis sectionibus ubi duæ parallelæ ad Curvam utrinq; terminatæ secantur a duabus parallelis ad Curvam utrinq; terminatis, prima a tertia & secunda a quarta, rectangulum partium primæ est ad rectangulum partium tertiæ ut rectangulum partium secundæ ad rectangulum partium quartæ: sic ubi quatuor tales rectæ occurrunt Curvæ secundi generis singulæ in tribus punctis, parallelepipedum partium primæ rectæ erit ad parallelepipedum partium tertiæ, ut parallelepipedum partium secundæ ad parallelepipedum partium quartæ.

VII.
Crura Hyperbolica & Parabolica & eorum placentia.

Curvarum secundi & superiorum generum æque atq; primi crura omnia in infinitum progredientia vel *Hyperbolici* sunt generis vel *Parabolici*. Crus *Hyperbolicum* voco quod ad Asymptoton aliquam in infinitum appropinquat, *Parabolicum* quod Asymptoto destituitur. Hæc crura ex tangentibus optime dignoscuntur. Nam si punctum contactus in infinitum abeat tangens cruris Hyperbolici cum Asymptoto coincidet & tangens cruris Parabolici in infinitum recedet, evanescet & nullibi reperietur. Invenitur igitur Asymptotos cruris cujusvis quærendo tangentem cruris illius ad punctum infinite distans. Plaga autem cruris infiniti invenitur quærendo positionem rectæ cujusvis quæ tangenti parallela est ubi punctum

Etum contactus in infinitum abit. Nam hæc recta in eandem plagam cum crure infinito dirigitur.

Lineæ omnes Ordinis primi, tertii, quinti, septimi & imparis cujusq; duo habent ad minimum crura in infinitum versus plagas oppositas progredientia. Et lineæ omnes tertii Ordinis duo habent ejusmodi crura in plagas oppositas progredientia in quas nulla alia earum crura infinita (præterquam in Parabola Cartesiana) tendunt. Si crura illa sint Hyperbolici generis, sit GAS eorum Asymptotos & huic parallela agatur recta quævis CBc ad Curvam utrinque (si fieri potest) terminata eademq; bisecetur in puncto X , & locus puncti illius X erit Hyperbola Conica (puta $X\phi$) cujus una Asymptotos est AS . Sit ejus altera Asymptotos AB , & æquatio qua ratio inter Ordinatum BC & Abscissam AB definitur, si AB dicatur x & BC y , semper induet hanc formam $xyy + ey = ax^3 + bxx + cx + d$. Ubi termini e, a, b, c, d , designant quantitates datas cum signis suis $+$ & $-$ affectas, quarum quælibet deesse possunt modo ex earum defectu figura in sectionem conicam non vertatur. Potest autem Hyperbola illa Conica cum asymptotis suis coincidere, id est punctum X in recta AB locari: & tunc terminus $+ey$ deest.

At si recta illa CBc non potest utrinq; ad Curvam terminari sed Curvæ in unico tantum puncto occurrat: age quamvis positione datam rectam AB asymptoto AS currentem in A , ut & aliam quamvis BC asymptoto illi parallelam Curvæque currentem in puncto C , & æquatio qua ratio inter Ordinatum BC

VIII.
Reductio Curvarum omnium generis secundi ad æquationum casus quatuor. Casus primus.

Fig. 1.

IX.
Casus secundus.

EC & Abſciſſam AB definitur, ſemper induet hanc formam $xy = ax^3 + bxx + cx + d$.

X.
Cafus tertius.

Quod ſi crura illa oppoſita Parabolici ſint generis, reſta CBc ad Curvam utrinque, ſi fieri poteſt, terminata in plagam crurum ducatur & biſecetur in B, & locus puncti B erit linea reſta. Sit iſta AB, terminata ad datum quodvis punctum A, & æquatio qua ratio inter Ordinatum BC & Abſciſſam AB definitur, ſemper induet hanc formam, $yy = ax^3 + bxx + cx + d$.

XI.
Cafus quartus.

At vero ſi reſta illa CBc in unico tantum puncto occurrat Curvæ, ideoq; ad Curvam utrinq; terminari non poſſit: ſit punctum illud C, & incidat reſta illa ad punctum B in reſtam quamvis aliam poſitione datam & ad datum quodvis punctum A terminatam AB: & æquatio qua ratio inter Ordinatum BC & Abſciſſam AC definitur ſemper induet hanc formam, $y = ax^3 + bxx + cx + d$.

XII.
Nomina formationum.

Enumerando curvas horum caſuum, Hyperbolam vocabimus *inſcriptam* quæ tota jacet in Aſymptoton angulo ad inſtar Hyperbolæ conicæ, *circumſcriptam* quæ Aſymptotos ſecat & partes abſciſſas in ſinu ſuo amplectitur, *ambigenam* quæ uno crure infinito inſcribitur & altero circumſcribitur, *convergentem* cujus crura concavitate ſua ſeinvicem reſpiciunt & in plagam eandem diriguntur, *divergentem* cujus crura convexitate ſua ſeinvicem recipiunt & in plagas contrarias diriguntur, *cruribus contrariis præditam* cujus crura in partes contrarias convexa ſunt & in plagas contrarias infinita, *Conchoidalem* quæ vertice concavo & cruribus divergentibus ad aſymptoton applicatur, *anguineam* quæ flexibus contrariis aſymptoton ſecat &

& utrinq; in crura contraria producitur, *cruciformem* quæ conjugatam decussat, *nodatam* quæ seipsam decussat in orbem redeundo, *cuspidatam* cujus partes duæ in angulo contactus concurrunt & ibi terminantur, *punctatam* quæ conjugatam habet Ovalem infinite parvam id est punctum, & *puram* quæ per impossibilitatem duarum radicum Ovali, Nodo, Cuspide & Puncto conjugato privatur. Eodem sensu Parabolam quoq; *convergentem*, *divergentem*, *curvibus contrariis præditam*, *cruciformem*, *nodatam*, *cuspidatam*, *punctatam* & *puram* nominabimus.

In casu primo si terminus a x³ affirmativus est Figura erit Hyperbola triplex cum sex curvibus Hyperbolicis quæ juxta tres Asymptotos quarum nullæ sunt parallelæ in infinitum progrediuntur, binæ juxta unamquamq; in plagas contrarias. Et hæ Asymptoti si terminus bxx non deest se mutuo secabunt in tribus punctis triangulum (Dd^Δ) inter se continentes, sin terminus bxx deest convergent omnes ad idem punctum. In priori casu cape AD = $\frac{b}{2a}$, & Ad = A^Δ = $\frac{b}{2r-d}$, ac junge Dd, D^Δ, & erunt AD, Dd, D^Δ tres Asymptoti. In posteriori duc ordinatam quamvis BC, & in ea utrinq; producta cape hinc inde BF & Bf sibi mutuo æquales & in ea ratione ad AB quam habet r'd ad a, jungeq; AF, Af, & erunt AB, AF, Af tres Asymptoti. Hanc autem Hyperbolam vocamus redundantem quia numero crurum Hyperbolicorum Sectiones Conicas superat.

XIII.
De Hyperbola
redundante &
ejus tribus A-
symptotis.

In Hyperbola omni redundante si neq; terminus ey desit neq; sit bb - 4ac æquale ± a e r'a curva nullam habebit diametrum, sin eorum alterutrum ac-

XIV.
De hujus Hyperbolæ
diametris
& situ crurum
infinite parvarum.

Uu

cidat

cidat curva habebit unicam diametrum, & tres si utrumque. Diameter autem semper transit per intersectionem duarum Asymptoton & bifecat rectas omnes quæ ad Asymptotos illas utrinq; terminantur & parallelæ sunt & Asymptoto tertiæ. Estq; abscissa AB diameter Figuræ quoties terminus ey deest. Diametrum vero absolute dictam hic & in sequentibus in vulgari significato usurpo, nempe pro abscissa quæ passim habet ordinatas binas æquales ad idem punctum hinc inde insistentes.

XV.
Hyperbolæ novem redundantes quæ diametro destituuntur & tres habent Asymptotos triangulum capientes.

Si Hyperbola redundans nullam habet diametrum quærantur Æquationis hujus $ax^4 + bx^3 + cx^2 + dx + \frac{1}{4} = 0$ radices quatuor seu valores ipsius x. Eæ sunt AP, A ϖ , A π , Ap. Erigantur ordinatæ PT, $\varpi\tau$, $\pi\gamma$, pt, & hæ tangent Curvam in punctis totidem T, τ , γ , t, & tangendo dabunt limites Curvæ per quos species ejus innotescet.

Fig. 1, 2.

Nam si radices omnes AP, A ϖ , A π , Ap sunt reales, ejusdem signi & inæquales, Curva constat ex tribus Hyperbolis, (inscripta circumscripta & ambigena) cum Ovali. Hyperbolarum una jacet versus D, altera versus d, tertia versus ϕ , & Ovalis semper jacet intra triangulam Dd ϕ , atq; etiam inter medios limites γ & τ , in quibus utiq; tangitur ab ordinatis $\pi\gamma$ & $\varpi\tau$. Et hæc est species prima.

Fig. 3, 4.

Si e radicibus duæ maximæ A π , Ap, vel duæ minimæ AP, A ϖ æquantur inter se, & ejusdem sunt signi cum alteris duobus, Ovalis & Hyperbola circumscripta sibi in vicem junguntur coeuntibus earum punctis contactus γ & t vel T & τ , & crura Hyperbolæ sese decussando in Ovalem continuantur, figuram nodatam efficiunt. Quæ species est secunda.

Si

Si e radicibus tres maximæ $A\rho$, $A\pi$, $A\varpi$, vel tres *Fig. 5, 6.*
 minimæ $A\pi$, $A\varpi$, AP æquantur inter se, Nodus in
cuspidem acutissimum convertetur. Nam crura duo
 Hyperbolæ circumscriptæ ibi in angulo contactus
 concurrent & non ultra producentur. Et hæc est
 species tertia.

Si e radicibus duæ mediæ $A\varpi$ & $A\pi$ æquantur in- *Fig. 7.*
 ter se, puncta contactus τ & γ coincidunt, & propte-
 rea Ovalis interjecta in punctum evanuit, & constat
 figura ex tribus Hyperbolis, inscripta, circumscripta
 & ambigena cum *puncto* conjugato. Quæ est species
 quarta.

Si duæ ex radicibus sunt impossibiles & reliquæ *Fig. 7, 8, 13, 14.*
 duæ inæquales & ejusdem signi (nam signa contraria
 habere nequeunt,) *puræ* habebuntur Hyperbolæ tres
 sine Ovali vel Nodo vel cuspide vel puncto conju-
 gato, & hæc Hyperbolæ vel ad latera trianguli ab
 Asymptotis comprehensi vel ad angulos ejus jacebunt
 & perinde speciem vel quintam vel sextam consti-
 tuent.

Si e radicibus duæ sunt æquales & alteræ duæ *Fig. 9, 10, 15, 16.*
 vel impossibiles sunt vel reales cum signis quæ a fig-
 nis æqualium radicum diversa sunt, figura *crucifor-*
mis habebitur, nempe duæ ex Hyperbolis seinvicem
 decussabunt idq; vel ad verticem trianguli ab A-
 symptotis comprehensi, vel ad ejus basem. Quæ
 duæ species sunt septima & octava.

Si deniq; radices omnes sunt impossibiles vel si *Fig. 11, 12.*
 omnes sunt reales & inæquales & earum duæ sunt
 affirmativæ & alteræ duæ negativæ, tunc duæ habe-
 buntur Hyperbolæ ad angulos oppositos duarum

Asymptotôn cum Hyperbola *anguinea* circa Asymptotôn tertiam. Quæ species est nona.

Et hi sunt omnes radicum casus possibiles. Nam si duæ radices sunt æquales inter se, & aliæ duæ sunt etiam inter se æquales, Figura evadet Sectio Conica cum linea recta.

XVI.
Hyperbole duodecim redundantes cum unicatantum Diametro.

Si Hyperbola redundans habet unicam tantum Diametrum sit ejus Diameter Abscissa AB, & æquationis hujus $ax^3 + bxx + cx + d = 0$ quære tres radices seu valores x.

Fig. 17.

Si radices illæ sunt omnes reales & ejusdem signi, Figura constabit ex *Ovali* intra triangulum Dd δ jacente & tribus Hyperbolis ad angulos ejus, nempe circumscripta ad angulum D & inscriptis duabus ad angulos d & δ . Et hæc est species decima.

Fig. 18.

Si radices duæ majores sunt æquales & tertia ejusdem signi, crura Hyperbolæ jacentis versus D sese decussabunt in forma *Nodi* propter contactum Ovalis. Quæ species est undecima.

Fig. 19.

Si tres radices sunt æquales, Hyperbola ista fit *cuspidata* sine Ovali. Quæ species est duodecima.

Fig. 20.

Si radices duæ minores sunt æquales & tertia ejusdem signi, Ovalis in *punctum* evanuit. Quæ species est decima tertia. In speciebus quatuor novissimis Hyperbola quæ jacet versus D Asymptotos in sinu suo amplectitur, reliquæ duæ in sinu Asymptotôn jacent.

Fig. 20.

Fig. 21.

Fig. 22.

Fig. 23.

Si duæ ex radicibus sunt impossibiles habebuntur tres Hyperbolæ *puræ* sine Ovali decussatione vel cuspede. Et hujus casus species sunt quatuor, nempe decima quarta si Hyperbola circumscripta jacet versus D & decima

decima quinta si Hyperbola inscripta jacet versus D, decima sexta si Hyperbola circumscripta jacet sub basi d^{δ} trianguli Dd^{δ} , & decima septima si Hyperbola inscripta jacet sub eadem basi.

Si duæ radices sunt æquales & tertia signi diversi Fig. 24.
 figura erit *cruciformis*. Nempe duæ ex tribus Hyper- Fig. 25.
 bolicis seinvicem decussabunt idq; vel ad verticem
 trianguli ab Asymptotis comprehenti vel ad ejus ba-
 sem. Quæ duæ species sunt decima octava & decima
 nona.

Si duæ radices sunt inæquales & ejusdem signi &
 tertia est signi diversi, duæ habebuntur Hyperbolæ
 in oppositis angulis duarum asymptotôn cum *Con-*
choidali intermedia. Conchoidalis autem vel jace- Fig. 27.
 bit ad easdem partes asymptoti suæ cum triangulo Fig. 26.
 ab asymptotis constituto, vel ad partes contrarias;
 & hi duo casus constituunt speciem vigesimam & vi-
 gesimam primam.

Hyperbola redundans quæ habet tres diametros XVII.
 constat ex tribus Hyperbolicis in sinibus asymptotôn Hyperbolæ duæ
 jacentibus, idq; vel ad angulos trianguli ab asympto- redundantes cum
 tis comprehenti vel ad ejus latera. Casus prior dat tribus Diametris.
 speciem vigesimam secundam, & posterior speciem vi- Fig. 28.
 gesimam tertiam. Fig. 29.

Si tres asymptoti in puncto communi se mutuo XVIII.
 decussant, vertuntur species quinta & sexta in vige- Hyperbolæ no-
 simam quartam, septima & octava in vigesimam vem redundantes
 quintam, & nona in vigesimam sextam ubi Anguinea cum Asymptotis
 non transit per concursum asymptoten, & in vige- tribus ad commu-
 simam septimam ubi transit per concursum illum, quo ne punctum con-
 casu termini b ac d desunt, & concursus asympto- vergentibus.
 tôn est centrum figuræ ab omnibus ejus partibus Fig. 30.
 oppositis Fig. 31.
Fig. 32.
Fig. 33.

oppositis æqualiter distans. Et hæ quatuor species Diametrum non habent.

Fig. 34.
Fig. 35.
Fig. 36.
Fig. 37.

Vertuntur etiam species decima quarta ac decima sexta in vigesimam octavam, decima quinta ac decima septima in vigesimam nonam, decima octava & decima nona in tricesimam, & vigesima cum vigesima prima in tricesimam primam. Et hæ species unicam habent diametrum.

Fig. 38.

Ac deniq; species vigesima secunda & vigesima tertia vertuntur in speciem tricesimam secundam cujus tres sunt Diametri per concursum asymptotôn transeuntes. Quæ omnes conversiones facillime intelliguntur faciendo ut triangulum ab asymptotis comprehensum diminuatur donec in punctum evanescat.

XIX.
*Hyperbole sex
defective diametrum non habentes.*

Si in primo æquationum casu terminus ax^3 negativus est, Figura erit Hyperbola defectiva unicam habens asymptoton & duo tantum crura Hyperbolica juxta asymptoton illam in plagas contrarias infinite progredientia. Et asymptotos illa est Ordinata prima & principalis AG . Si terminus $e y$ non deest figura nullam habebit Diametrum, si deest habebit unicam. In priori casu species sic enumerantur.

Fig. 39.

Si æquationis hujus $ax^4 = bx^3 + cxx + dx + \frac{1}{4}ee$, radices omnes $A\pi$, AP , Ap , $A\varpi$, sunt reales & inæquales, Figura erit Hyperbola anguinea asymptoton flexu contrario amplexa, cum *Ovali* conjugata. Quæ species est tricesima tertia.

Fig. 40.

Si radices duæ mediæ AP & Ap æquantur inter se, *Ovalis* & *Anguinea* junguntur sese decussantes in forma *Nodi*. Quæ est species tricesima quarta.

Si

Si tres radices sunt æquales, Nodus vertetur in *Fig. 41.*
cuspidem acutissimum in vertice anguinæ. Et hæc
 est species tricesima quinta.

Si e tribus radicibus ejusdem signi duæ maximæ *Fig. 43.*
 $A\rho$ & $A\tau$ sibi mutuo æquantur, Ovalis in *punctum*
 evanuit. Quæ species est tricesima sexta.

Si radices duæ quævis imaginariæ sunt, sola ma-
 nebit Anguinea *pura* sine Ovali, decussatione, cus-
 pide vel puncto conjugato. Si Anguinea illa non *Fig. 42.*
 transit per punctum A species est tricesima septima,
 sin transit per punctum illud A (id quod contingit *Fig. 43.*
 ubi termini b ac d defunt,) punctum illud A erit
 centrum figuræ rectas omnes per ipsum ductas &
 ad Curvam utrinq; terminatas bifecans. Et hæc
 est species tricesima octava.

In altero casu ubi terminus ey deest & propterea
 figura Diametrum habet, si æquationis hujus ax^3
 $= bxx + cx + d$ radices omnes AT, At, A τ , sunt
 reales, inæquales & ejusdem signi, figura erit Hyper-
 bola Conchoidalis cum Ovali ad convexitatem. Quæ
 est species tricesima nona. XX.
*Hyperbolæ sep-
 tem defectivæ, di-
 ametrum haben-
 tes.*
Fig. 45.

Si duæ radices sunt inæquales & ejusdem signi & *Fig. 44.*
 tertia est signi contrarii, Ovalis jacebit ad concavi-
 tatem Conchoidalis. Estq; species quadragesima.

Si radices duæ minores AT, At, sunt æquales *Fig. 46.*
 & tertia A τ est ejusdem signi, Ovalis & Conchoi-
 dalis jungentur sese decussando in modum *Nodi*.
 Quæ species est quadragesima prima.

Si tres radices sunt æquales, Nodus mutabitur in *Fig. 47.*
Cuspidem & figura erit *Cissois Veterum*. Et hæc est
 species quadragesima secunda.

Fig. 49.

Si radices duæ majores sunt æquales, & tertia est ejusdem signi, Conchoidalis habebit *punctum* conjugatum ad convexitatem suam, estq; species quadragesima tertia.

Fig. 49.

Si radices duæ sunt æquales & tertia est signi contrarii Conchoidalis habebit *punctum* conjugatum ad concavitatem suam, estq; species quadragesima quarta.

Fig. 49.

Si radices duæ sunt impossibiles habebitur Conchoidalis *pura* sine Ovali, Nodo, Cuspide vel puncto conjugato. Quæ species est quadragesima quinta.

XXI.
Hyperbolæ separatem Parabolicæ Diametrum non habentes.

Si quando in primo æquationum casu terminus ax^3 deest & terminus bx^2 non deest, Figura erit Hyperbola Parabolica duo habens crura Hyperbolica ad unam Asymptoton SAG & duo Parabolica in plagam unam & eandem convergentia. Si terminus ey non deest figura nullam habebit diametrum, si deest habebit unicam. In priori casu species sunt hæc.

Fig. 50.

Si tres radices AP , $A\pi$, $A\tau$ æquationis hujus $bx^3 + cx + dx + \frac{1}{4}ee = 0$ sunt inæquales & ejusdem signi, figura constabit ex *Ovali* & aliis duabus Curvis quæ partim Hyperbolicæ sunt & partim Parabolicæ. Nempe crura Parabolica continuo ductu junguntur cruribus Hyperbolicis sibi proximis. Et hæc est species quadragesima sexta.

Fig. 51.

Si radices duæ minores sunt æquales & tertia est ejusdem signi, Ovalis & una Curvarum illarum Hyperbolicæ-Parabolicarum junguntur & se decussant in formam *Nodi*. Quæ species est quadragesima septima.

Si tres radices sunt æquales, Nodus ille in Cuspide vertitur. Estq; species quadragesima octava. *Fig. 52.*

Si radices duæ majores sunt æquales & tertia est ejusdem signi, Ovalis in punctum conjugatum evanuit. Quæ species est quadragesima nona. *Fig. 53.*

Si duæ radices sunt impossibiles, manebunt illæ duæ curvæ Hyperbolo-parabolicæ sine Ovali, decussatione, cuspide vel puncto conjugato, & speciem quinquagesimam constituent. *Fig. 53, 54.*

Si radices duæ sunt æquales & tertia est signi contrarii, Curvæ illæ hyperbolo-parabolicæ junguntur sese decussando in morem crucis. Estq; species quinquagesima prima. *Fig. 55.*

Si radices duæ sunt inæquales & ejusdem signi & tertia est signi contrarii, figura evadet Hyperbola anguinea circa Asymptoton A G, cum Parabola conjugata. Et hæc est species quinquagesima secunda. *Fig. 56.*

In altero casu ubi terminus e y deest & figura Diametrum habet, si duæ radices æquationis hujus $bxx + cx + d = 0$ sunt impossibiles, duæ habentur figuræ hyperbolo-parabolicæ a Diametro A B hinc inde æqualiter distantes. Quæ species est quinquagesima tertia. *XXII. Hyperbole quatuor Parabolicæ Diametrum habentes. Fig. 57.*

Si æquationis illius radices duæ sunt impossibiles, Figuræ hyperbolo-parabolicæ junguntur sese decussantes in morem crucis, & speciem quinquagesimam quartam constituunt. *Fig. 58.*

Si radices illæ sunt inæquales & ejusdem signi, habetur Hyperbola Conchoidalis cum Parabola ex eodem latere Asymptoti. Estq; species quinquagesima quinta. *Fig. 59.*

Fig. 60.

Si radices illæ sunt signi contrarii, habetur Conchoidalis cum Parabola ad alteras partes Asymptoti. Quæ species est quinquagesima sexta.

XXIII.
Quatuor Hyperbolismi Hyperbolæ.

[Siquando in primo æquationum casu terminus uterq; $a x^3$ & $b x x$ deest, figura erit Hyperbolismus sectionis alicujus Conicæ. Hyperbolismum figuræ voco cujus Ordinata prodit applicando contentum sub Ordinata figuræ illius & recta data ad Abscissam communem. Hac ratione linea recta vertitur in hyperbolam Conicam, & sectio omnis Conica vertitur in aliquam figurarum quas hic Hyperbolismos sectionum Conicarum voco. Nam æquatio ad figuras de quibus agimus, nempe $x y y + e y = c x + d$, seu $y = \frac{e \pm \sqrt{e e + 4 d x + 4 c x x}}{2 x}$ generatur applicando contentum sub Ordinata sectionis Conicæ $\frac{e \pm \sqrt{e e + 4 d x + 4 c x x}}{2 m}$ & recta data m ad curvarum Abscissam communem x . Unde liquet quod figura genita Hyperbolismus erit Hyperbolæ, Ellipseos vel Parabolæ perinde ut terminus $c x$ affirmativus est vel negativus vel nullus.

Hyperbolismus Hyperbolæ tres habet asymptotos quarum una est Ordinata prima & principalis $A d$, alteræ duæ sunt parallelæ Abscissæ $A B$ & ab eadem hinc inde æqualiter distant. In Ordinata principali $A d$ cape $A d$, A^d hinc inde æquales quantitati \sqrt{c} & per puncta $d a c^d$ age $d g$, $d \gamma$ Asymptotos Abscissæ $A B$ parallelas.

Ubi terminus $e y$ non deest figura nullam habet diametrum. In hoc casu si æquationis hujus $c x x + d x + \frac{1}{4} e e = 0$ radices duæ $A P$, $A p$ sunt reales &

& inæquales (nam æquales esse nequeunt nisi figura *Fig. 61.* fit Conica sectio) figura constabit ex tribus Hyperbolis sibi oppositis quarum una jacet inter asymptotos parallelas & alteræ duæ jacent extra. Et hæc est species quinquagesima septima.

Si radices illæ duæ sunt impossibiles, habentur Hyperbolæ duæ oppositæ extra asymptotos parallelas & Anguinea hyperbolica intra easdem. Hæc figura duarum est species. Nam centrum non habet *Fig. 62.* ubi terminus d non deest ; sed si terminus ille deest *Fig. 63.* punctum A est ejus centrum. Prior species est quinquagesima octava, posterior quinquagesima nona.

Quod si terminus e deest, figura constabit ex *Fig. 64.* tribus hyperbolis oppositis quarum una jacet inter asymptotos parallelas & alteræ duæ jacent extra ut in specie quinquagesima quarta, & præterea diametrum habet quæ est abscissa AB . Et hæc est species sexagesima.

Hyperbolismus Ellipseos per hanc æquationem definitur $xy + ey = cx + d$, & unicam habet asymptoton quæ est Ordinata principalis $A'd$. Si terminus e *XXIV.* *Tres Hyperbolismi Ellipseos.* *Fig. 65.* non deest, figura est Hyperbola anguinea sine diametro atq; etiam sine centro si terminus d non deest. Quæ species est sexagesima prima.

At si terminus d deest, figura habet centrum sine *Fig. 66.* diametro & centrum ejus est punctum A . Species vero est sexagesima secunda.

Et si terminus e deest & terminus d non deest, *Fig. 67.* figura est Conchoidalis ad asymptoton AG , habetq; diametrum sine centro, & diameter ejus est Abscissa AB . Quæ species est sexagesima tertia.

XXV.
Duo Hyperbolismi Parabolæ.

Fig. 68.

Fig. 69.

Hyperbolismus Parabolæ per hanc æquationem definitur $x y y + e y = d$; & duas habet asymptotas, Abscissam AB & Ordinatam primam & principalem AG. Hyperbolæ vero in hac figura sunt duæ, non in asymptoton angulis oppositis sed in angulis qui sunt deinceps jacentes, idq; ad utrumq; latus abscissæ AB, & vel sine diametro si terminus e y habetur, vel cum diametro si terminus ille deest. Quæ duæ species sunt sexagesima quarta & sexagesima quinta.

XXVI.
Tridens.

Fig. 76.

In secundo æquationum casu habebatur æquatio $x y = a x^3 + b x x + c x + d$. Et figura in hoc casu habet quatuor crura infinita quorum duo sunt hyperbolica circa asymptoton AG in contrarias partes tendentia & duo Parabolica convergentia & cum prioribus speciem Tridentis fere efformantia. Estq; hæc Figura Parabola illa per quam Cartesius æquationes sex dimensionum construxit. Hæc est igitur species sexagesima sexta.

XXVII.
Parabola quinque divergentes.

Fig. 70, 71.

In tertio casu æquatio erat $y y = a x^3 + b x x + c x + d$, & Parabolam designat cujus crura divergunt ab invicem & in contrarias partes infinite progrediuntur. Abscissa AB est ejus diameter & species ejus sunt quinque sequentes.

Fig. 72.

Fig. 73.

Si æquationis $a x^3 + b x^2 + c x + d = 0$ radices omnes A τ , A T, A t sunt reales & inæquales, figura est Parabola divergens campaniformis cum *Ovali* ad verticem. Et species est sexagesima septima.

Si radices duæ sunt æquales, Parabola prodit vel *nodata* contingendo *Ovalem*, vel *punctata* ob *Ovalem* infinite parvam. Quæ duæ species sunt sexagesima octava & sexagesima nona.

Si

Si tres radices sunt æquales Parabola erit *cuspi-* Fig. 75.
data in vertice. Et hæc est Parabola Neiliana quæ
vulgo fêmicubica dicitur.

Si radices duæ sunt impossibiles, habetur Parabola Fig. 73, 74.
pura campaniformis speciem septuagesimam primam
constituens.

In quarto casu æquato erat $y = ax + bxx + cx$ XXVIII.
 $+ d$, & hæc æquatio Parabolam illam *Wallisianam* Parabola cubica.
designat quæ crura habet contraria & cubica di- Fig. 77.
ci solet. Et sic species omnino sunt septuaginta
duæ.

Si in planum infinitum a puncto lucido illumina- XXIX.
tum umbræ figurarum projiciantur, umbræ sectio- *Genesis Curva-*
num Conicarum semper erunt sectiones Conicæ, eæ *rum per Umbras.*
Curvarum secundi generis semper erunt Curvæ se-
cundi generis, eæ curvarum tertii generis semper
erunt Curvæ tertii generis, & sic deinceps in infini-
tum. Et quemadmodum Circulus umbram projici-
endo generat sectiones omnes conicas, sic Parabola
quinq; divergentes umbris suis generant & exhibent
alias omnes secundi generis curvas, & sic
Curvæ quædam simpliciores aliorum generum inve-
niri possunt quæ alias omnes eorundem generum
curvas umbris suis a puncto lucido in planum pro-
jectis formabunt.

Diximus Curvas secundi generis a linea recta in
punctis tribus secari posse. Horum duo nonnun- XXX.
quam coincidunt. *Curvarum pun-*
Ut cum recta per Ovalem infi- *ta duplicita.*
nite parvam transit vel per concursum duarum par-
tium Curvæ se mutuo secantium vel in cuspidem
coeuntium ducitur. Et siquando rectæ omnes in
plagam

plagam cruris alicujus infiniti tendentes Curvam in unico tantum puncto secant (ut fit in ordinatis Parabolæ Cartesianæ & Parabolæ cubicæ, nec non in rectis Abſciſſæ Hyperbolismorum Hyperbolæ & Parabolæ parallelis) concipiendum est quod rectæ illæ per alia duo Curvæ puncta ad infinitam distantiam sita (ut ita dicam) transeunt. Hujusmodi interfectiones duas coincidentes sive ad finitam sint distantiam sive ad infinitam, vocabimus punctum duplex. Curvæ autem quæ habent punctum duplex describi possunt per sequentia Theoremata.

XXXI.

*Theoremata de
Curvarum de-
scriptione orga-
nica.
Fig. 78.*

1. Si anguli duo magnitudine dati PAD, PBD circa polos positione datos A, B rotentur, & eorum crura AP, BP concursu suo P percurrant lineam rectam; crura duo reliqua AD, BD concursu suo D describent sectionem Conicam per polos A, B transeuntem: præterquam ubi linea illa recta transit per polorum alterutrum A vel B, vel anguli BAD, ABD simul evanescunt, quibus in casibus punctum D describet lineam rectam.

2. Si crura prima AP, BP concursu suo P percurrant sectionem Conicam per polum alterutrum A transeuntem, crura duo reliqua AD, BD concursu suo D describent Curvam secundi generis per polum alterum B transeuntem & punctum duplex habentem in polo primo A per quem sectio Conica transit: præterquam ubi anguli BAD, ABD simul evanescunt, quo casu punctum

ctum D describet aliam sectionem Conicam per polum A transeuntem.

3. At si sectio Conica quam punctum P percurrit transeat per neutrum polorum A, B, punctum D describet curvam secundi vel tertii generis punctum duplex habentem. Et punctum illud duplex in concursu crurum describentium, AD, BD invenietur ubi anguli BAP, ABP simul evanescent. Curva autem descripta secundi erit generis si anguli BAD, ABD simul evanescent, alias erit tertii generis & alia duo habebit puncta duplicia in polis A & B.

Jam sectio Conica determinatur ex datis ejus punctis quinq; & per eadem sic describi potest. Dentur ejus puncta quinq; A, B, C, D, E. Jungantur eorum tria quævis A, B, C & trianguli ABC rotentur anguli duo quivis CAB, CBA circa vertices suos A & B, & ubi crurum AC, BC intersectio C successive applicatur ad puncta duo reliqua D, E, incidat intersectio crurum reliquorum AB & BA in puncta P & Q. Agatur & infinite producat recta PQ, & anguli mobiles ita rotentur ut intersectio crurum AB, BA percurrat rectam PQ, & crurum reliquorum intersectio C describet propositam sectionem Conicam per Theorema primum.

XXXII.
Sectionum Conicarum descriptio per data quinque puncta.

Curvæ omnes secundi generis punctum duplex habentes determinantur ex datis earum punctis septem, quorum unum est punctum illud duplex, &

XXXIII.
Curvarum secundi generis punctum duplex habentium descriptio per data septem puncta.

& per eadem puncta sic describi possunt. Dentur Curvæ describendæ puncta quælibet septem A, B, C, D, E, F, G quorum A est punctum duplex. Jungantur punctum A & alia duo quævis e punctis puta B & C; & trianguli ABC rotetur tum angulus CAB circa verticem suum A, tum angulorum reliquorum alteruter ABC circa verticem suum B. Et ubi crurum AC, BC concursus C successive applicatur ad puncta quatuor reliqua D, E, F, G incidat concursus crurum reliquorum AB & BA in puncta quatuor P, Q, R, S. Per puncta illa quatuor & quintum A describatur sectio Conica, & anguli præfati CAB, CBA ita rotentur ut crurum AB, BA concursus percurrat sectionem illam Conicam, & concursus reliquorum crurum AC, BC describer Curvam propositam per Theorema secundum.

Si vice puncti C datur positio recta BC quæ Curvam describendam tangit in B, lineæ AD, AP coincident, & vice anguli DAP habebitur linea recta circa polum A rotanda.

Si punctum duplex A infinite distat debet Recta ad plagam puncti illius perpetuo dirigi & motu parallelo ferri interea dum angulus ABC circa polum B rotatur.

Describi etiam possunt hæ curvæ paulo aliter per Theorema tertium, sed descriptionem simpliciore[m] posuisse sufficit.

Eadem methodo Curvas tertii, quarti & superiorum generum describere licet, non omnes quidem sed quotquot ratione aliqua commoda per motum localem describi possunt. Nam curvam aliquam
secundi

secundi vel superioris generis punctum duplex non habentem commode describere Problema est inter difficiliora numerandum.

Curvarum usus in Geometria est ut per earum intersecciones Problemata solvantur. Proponatur æquatio construenda dimensionum novem $x^9 + bx^7 + cx^6 + dx^5 + ex^4 + fx^3 + gxx + hx + k = 0$. Ubi

XXXIV.
Constructio æquationum per descriptionem Curvarum.

+ m

b, c, d, &c. significant quantitates quasvis datas signis suis + & - affectas. Assumatur æquatio ad Parabolam cubicam $x^3 = y$, & æquatio prior, scribendo y pro x^3 , evadet $y^3 + bxyy + cy^2 + dxxy + exy + my + fx^3 + gxx + hx + k = 0$, æquatio ad Curvam aliam secundi generis. Ubi m vel f deesse potest vel pro lubitu assumi. Et per harum Curvarum descriptiones & intersecciones dabuntur radices æquationis construendæ. Parabolam cubicam semel describere sufficit.

Si æquatio construenda per defectum duorum terminorum ultimatorum hx & k reducatur ad septem dimensiones, Curva altera delendo m, habebit punctum duplex in principio abscissæ, & inde facile describi potest ut supra.

Si æquatio construenda per defectum terminorum trium ultimatorum $gxx + hx + k$ reducatur ad sex dimensiones, Curva altera delendo f evadet sectio Conica.

Et si per defectum sex ultimatorum terminorum æquatio construenda reducatur ad tres dimensiones, incidetur in constructionem *Wallisianam* per Parabolam cubicam & lineam rectam.

Construi etiam possunt æquationes per Hyperbolicum Parabolæ cum diametro. Ut si construenda sit hæc æquatio dimensionum novem termino penultimo carens, $a + cxx + dx^3 + ex^4 + fx + gx^5 + hx^7$

$+ kx^8 + lx^9 = 0$; assumatur æquatio ad Hyperbolicum illum $xy = 1$, & scribendo y pro $\frac{1}{xx}$, æquatio construenda vertetur in hanc $ay^3 + cy + dxxy + ey + fxy + mxx + gx + hx + kxx + lx^3 = 0$, quæ curvam secundi generis designat cujus descriptione Problema solvetur. Et quantitatum m ac g alterutra hic deesse potest, vel pro lubitu assumi.

Per Parabolam cubicam & Curvas tertii generis construuntur etiam æquationes omnes dimensionum non plusquam duodecim, & per eandem Parabolam & curvas quarti generis construuntur omnes dimensionum non plusquam quindecim, Et sic deinceps in infinitum. Et curvæ illæ tertii quarti & superiorum generum describi semper possunt inveniendo eorum puncta per Geometriam planam. Ut si construenda sit æquatio $x^{12} + ax^{10} + bx^9 + cx^8 + dx^7 + ex^6 + fx^5 + gx^4 + hx^3 + ixx + kx + l = 0$, & descripta habeatur Parabola Cubica; sit æquatio ad Parabolam illam cubicam $x^3 = y$, & scribendo y pro x^3 æquatio construenda vertetur in hanc

$$y^4 + axy^3 + cxxyy + fxy + ixx = 0,$$

quæ est

$$\begin{array}{cccc} +b & +dx & +gx & +kx \\ & +e & +h & +l \end{array}$$

æquatio ad Curvam tertii generis cujus descriptione Problema solvetur. Describi autem potest hæc Curva inveniendo ejus puncta per Geometriam planam, propterea quod indeterminata quantitas x non nisi ad duas dimensiones ascendit.

TRACTATUS

D E

Quadratura Curvarum.

INTRODUCTIO.

Quantitates Mathematicas non ut ex partibus quam minimis constantes, sed ut motu continuo descriptas hic considero. Lineæ describuntur ac describendo generantur non per appositionem partium sed per motum continuum punctorum, superficies per motum linearum, solida per motum superficierum, anguli per rotationem laterum, tempora per fluxum continuum, & sic in cæteris. Hæ Geneses in rerum natura locum vere habent & in motu corporum quotidie cernuntur. Et ad hunc modum Veteres ducendo rectas mobiles in longitudinem rectarum immobilium genesin docuerunt rectangulorum.

Considerando igitur quod quantitates æqualibus temporibus crescentes & crescendo genitæ, pro velocitate majori vel minori qua crescunt ac generantur, evadunt majores vel minores ; methodum quærebam
deter-

determinandi quantitates ex velocitalibus motuum vel incrementorum quibus generantur; & has motuum vel incrementorum velocitates nominando *Fluxiones* & quantitates genitas nominando *Fluentes*, incidi paulatim *Annis* 1665 & 1666 in Methodum Fluxionum qua hic usus sum in Quadratura Curvarum.

Fluxiones sunt quam proxime ut Fluentium augmenta æqualibus temporis particulis quam minimis genita, & ut accurate loquar, sunt in prima ratione augmentorum nascentium; exponi autem possunt per lineas quascunq; quæ sunt ipsis proportionales. Ut si areae ABC , $ABDG$ Ordinatis BC , BD super basi AB uniformi cum motu progredientibus describantur, harum arearum fluxiones erunt inter se ut Ordinatae describentes BC & BD , & per Ordinatas illas exponi possunt, propterea quod Ordinatae illæ sunt ut arearum augmenta nascentia. Progrediatur Ordinata BC de loco suo BC in locum quemvis novum bc . Compleatur parallelogrammum $BCEb$, ac ducatur recta VTH quæ Curvam tangat in C ipsiq; bc & BA productis occurrat in T & V : & Abscissæ AB , Ordinatae BC , & Lineæ Curvæ ACc augmenta modo genita erunt Bb , Ec & Cc ; & in horum augmentorum nascentium ratione prima sunt latera trianguli CET , ideoq; fluxiones ipsarum AB , BC & AC sunt ut trianguli illius CET latera CE , ET & CT & per eadem latera exponi possunt, vel quod perinde est per latera trianguli consimilis VBC .

Eodem recidit si sumantur fluxiones in ultima ratione partium evanescentium. Agatur recta Cc & producat eadem ad K . Redeat Ordinata bc

in locum suum priorem BC , & coeuntibus punctis C & c , recta CK coincidat cum tangente CH , & triangulum evanescens CEc in ultima sua forma evadet simile triangulo CET , & ejus latera evanescencia CE , Ec & Cc erunt ultimo inter se ut sunt trianguli alterius CET latera CE , ET & CT , & propterea in hac ratione sunt fluxiones linearum AB , BC & AC . Si puncta C & c parvo quovis intervallo ab invicem distant recta CK parvo intervallo a tangente CH distabit. Ut recta CK cum tangente CH coincidat & rationes ultimæ linearum CE , Ec & Cc inveniantur, debent puncta C & c coire & omnino coincidere. Errores quam minimi in rebus mathematicis non sunt contemnendi.

Simili argumento si circulus centro B radio BC descriptus in longitudinem Abscissæ AB ad angulos rectos uniformi cum motu ducatur, fluxio solidi generati ABC erit ut circulus ille generans, & fluxio superficies ejus erit ut perimenter Circuli illius & fluxio lineæ curvæ AC conjunctim. Nam quo tempore solidum ABC generatur ducendo circum illum in longitudinem Abscissæ AB , eodem superficies ejus generatur ducendo perimetrum circuli illius in longitudinem Curvæ AC .

*Recta PB circa polum datum P revolvens secet aliam Fig. 2. positione datam rectam AB : quæritur proportio fluxionum rectarum illarum AB & PB . Progrediatur recta PB de loco suo PB in locum novum Pb . In Pb capiatur PC ipsi PB æqualis, & ad AB ducatur PD sic, ut angulus bPD æqualis sit angulo bBC ; & ob similitudinem triangulorum bBC , bPD erit augmentum Bb ad augmentum Cb ut Pb ad Db .
Redeat*

Redeat jam Pb in locum suum priorem PB ut augmenta illa evanescant, & evanescentium ratio ultima, id est ratio ultima Pb ad Db , ea erit quæ est PB ad DB , existente angulo PDB recto, & propterea in hac ratione est fluxio ipsius AB ad fluxionem ipsius PB .

Fig. 3.

Recta PB circa datum Polum P revolvens secet alias duas positione datas rectas AB & AE in B & E : queritur proportio fluxionum rectarum illarum AB & AE . Progrediatur recta revolvens PB de loco suo PB in locum novum Pb rectas AB , AE in punctis b & e secantem, & rectæ AE parallela BC ducatur ipsi Pb occurrens in C , & erit Bb ad BC ut Ab ad Ae , & BC ad Ee ut PB ad PE , & conjunctis rationibus Bb ad Ee ut $Ab \times PB$ ad $Ae \times PE$. Redeat jam linea Pb in locum suum priorem PB , & augmentum evanescens Bb erit ad augmentum evanescens Ee ut $AB \times PB$ ad $AE \times PE$, ideoq; in hac ratione est fluxio rectæ AB ad fluxionem rectæ AE .

Hinc si recta revolvens PB lineas quasvis Curvas positione datas secet in punctis B & E , & rectæ jam mobiles AB , AE Curvas illas tangant in Sectionum punctis B & E : erit fluxio Curvæ quam recta, AB tangit ad fluxionem Curvæ quam recta AE tangit ut $AB \times PB$ ad $AE \times PE$. Id quod etiam eveniet si recta PB Curvam aliquam positione datam perpetuo tangat in puncto mobili P .

Fluat quantitas x uniformiter & invenienda sit fluxio quantitatis x^n . Quo tempore quantitas x fluendo evadit $x + o$, quantitas x^n evadet $\overline{x + o}^n$, id est per methodum serierum infinitarum, $x^n + n o x^{n-1}$

$\frac{nn-n}{2}oox^{n-2} + \mathcal{C}$. Et augmenta 0 & $nox^{n-1} + \frac{nn-n}{2}oox^{n-2}$
 $-\mathcal{C}$. sunt ad invicem ut 1 & $nx^{n-1} - \frac{nn-n}{2}oox^{n-2} + \mathcal{C}$.
 Evanescant jam augmenta illa, & eorum ratio
 ultima erit 1 ad nx^{n-1} : ideoq; fluxio quantitatis
 x est ad fluxionem quantitatis x^n ut 1 ad nx^{n-1} .

Similibus argumentis per methodum rationum
 primarum & ultimarum colligi possunt fluxiones li-
 nearum seu rectorum seu curvarum in casibus qui-
 buscunq; ut & fluxiones superficierum, angulo-
 rum & aliarum quantitatum. In finitis autem quan-
 titatibus Analysis sic institui, & finitarum naſcen-
 tium vel evanescentium rationes primas vel ultimas
 investigare, consonum est Geometriæ Veterum : &
 volui ostendere quod in Methodo Fluxionum non
 opus sit figuras infinite parvas in Geometriam intro-
 ducere. Peragi tamen potest Analysis in figuris qui-
 buscunq; seu finitis seu infinite parvis quæ figuris
 evanescentibus finguntur similes, ut & in figuris quæ
 pro infinite parvis haberi solent, modo caute pro-
 cedas.

Ex Fluxionibus invenire Fluentes Problema dif-
 ficilius est, & solutionis primus gradus æquipollet
 Quadraturæ Curvarum ; de qua sequentia olim
 scripsi.

TRACTATUS

D E

Quadratura Curvarum.

Quantitates indeterminatas ut motu perpetuo crescentes vel decrescentes, id est ut fluentes vel defluentes in sequentibus considero, designoq; literis z, y, x, v , & earum fluxiones seu celeritates crescendi noto iisdem literis punctatis $\dot{z}, \dot{y}, \dot{x}, \dot{v}$. Sunt & harum fluxionum fluxiones seu mutationes magis aut minus celeres quas ipsarum z, y, x, v fluxiones secundas nominare licet & sic dignare $\ddot{z}, \ddot{y}, \ddot{x}, \ddot{v}$, & harum fluxiones primas seu ipsarum z, y, x, v fluxiones tertias sic $\dot{\ddot{z}}, \dot{\ddot{y}}, \dot{\ddot{x}}, \dot{\ddot{v}}$, & quartas sic $\ddot{\ddot{z}}, \ddot{\ddot{y}}, \ddot{\ddot{x}}, \ddot{\ddot{v}}$. Et quemadmodum z, y, x, v sunt fluxiones quantitatum $\ddot{\ddot{z}}, \ddot{\ddot{y}}, \ddot{\ddot{x}}, \ddot{\ddot{v}}$, & hæ sunt fluxiones quantitatum $\dot{\ddot{z}}, \dot{\ddot{y}}, \dot{\ddot{x}}, \dot{\ddot{v}}$ & hæ sunt fluxiones quantitatum primarum z, y, x, v : sic hæ quantitates considerari possunt ut fluxiones aliarum quas sic designabo,

$\dot{z}, \dot{y}, \dot{x}, \dot{v}$, & hæ ut fluxiones aliarum $\ddot{z}, \ddot{y}, \ddot{x}, \ddot{v}$, & hæ ut fluxiones aliarum $\dddot{z}, \dddot{y}, \dddot{x}, \dddot{v}$. Designant igitur

$\ddot{z}, \dot{z}, z, z, \ddot{z}, \dot{z}, z, z$ &c. seriem quantitatum quarum quælibet posterior est fluxio præcedentis & quælibet prior est fluens quantitas fluxionem habens subsequenter.

Similis est series $\sqrt{az-zz}, \sqrt{az-zz},$

$\sqrt{az-zz}, \sqrt{az-zz}, \sqrt{az-zz}, \sqrt{az-zz}$, ut &

series $\frac{az+z^2}{a-z}, \frac{az+z^2}{a-z}, \frac{az+z^2}{a-z}, \frac{az+z^2}{a-z}, \frac{az+z^2}{a-z}$,

$\frac{az+z^2}{a-z}$. Et notandum est quod quantitas quælibet prior in his seriebus est ut area figuræ curvilinearæ cujus ordinatim applicata rectangula est quantitas posterior & abscissa est z : uti $\sqrt{az-zz}$ area curvæ cujus ordinata est $\sqrt{az-zz}$ & abscissa z . Quo autem spectant hæc omnia patebit in Propositionibus quæ sequuntur.

PROP. I. PROB. I.

Data æquatione quocunq; fluentes quantitates involvente, invenire fluxiones.

Solutio.

Multiplicetur omnis æquationis terminus per indicem dignitatis quantitatis cujusq; fluentis quam involvit, & in singulis multiplicationibus mutetur dignitatis latus in fluxionem suam, & aggregatum factorum omnium sub propriis signis erit æquatio nova.

Explicatio.

Sunto a, b, c, d &c. quantitates determinatæ & immutabiles, & proponatur æquatio quævis quantitates fluentes z, y, x &c. involvens, uti $x^3 - x y y + a a z - b^3 = 0$. Multiplicentur termini primo per indices dignitatum x , & in singulis multiplicationibus pro dignitatis latere, seu x unius dimensionis, scribatur \dot{x} , & summa factorum erit $3 \dot{x} x^2 - \dot{x} y y$. Idem fiat in y & prodibit $-^2 x y \dot{y}$. Idem fiat in z & prodibit $a a \dot{z}$. Ponatur summa factorum æqualis nihilo, & habebitur æquatio $3 \dot{x} x^2 - \dot{x} y y - ^2 x y \dot{y} + a a \dot{z} = 0$. Dico quod hac æquatione definitur relatio fluxionum.

De-

Demonstratio.

Nam sit o quantitas admodum parva & sũnto $\dot{o}z$, $\dot{o}y$, $\dot{o}x$, quantitatum z , y , x momenta id est incrementa momentanea synchrona. Et si quantitates fluentes jam sunt z , y & x , hæ post momentum temporis incrementis suis $\dot{o}z$, $\dot{o}y$, $\dot{o}x$ auctæ, evadent $z + \dot{o}z$, $y + \dot{o}y$, $x + \dot{o}x$, quæ in æquatione prima pro z , y & x scriptæ dant æquationem $x^3 + 3x\dot{o}x + 3x\dot{o}o\dot{x}x + o^3x^3 - xyy - \dot{o}xyy - 2x\dot{o}yy - 2x\dot{o}o\dot{y}y - x\dot{o}o\dot{y}y - x\dot{o}^3\dot{y}y + aaz + aaoz - b\dot{z} = 0$. Subducatur æquatio prior, & residuum divisum per o erit $3xx\dot{z} + 3xx\dot{o}x + x^3\dot{o}o - xyy - 2x\dot{y}y - 2x\dot{o}yy - x\dot{o}yy - x\dot{o}o\dot{y}y + aaz = 0$. Minuatur quantitas o in infinitum, & neglectis terminis evanescentibus restabit $3xx^2 - xyy - 2x\dot{y}y + aaz = 0$. Q. E. D.

Explicatio plenior.

Ad eundem modum si æquatio esset $x^3 - xyy + aa\sqrt{ax - yy} - b\dot{z} = 0$, produceretur $3x^2\dot{x} - xyy - 2x\dot{y}y + aa\sqrt{ax - yy} = 0$. Ubi si fluxionem $\sqrt{ax - yy}$ tollere velis, pone $\sqrt{ax - yy} = z$, & erit $ax - yy = z^2$
&

& (per hanc Propositionem) $\dot{ax} - 2\dot{yy} = 2\dot{z}$ feu
 $\frac{\dot{ax} - 2\dot{yy}}{2z} = \dot{z}$, hoc est $\frac{\dot{ax} - 2\dot{yy}}{2\sqrt{ax - yy}} = \sqrt{ax - yy}$. Et

$$\text{inde } 3x^2\dot{x} - x\dot{yy} - 2x\dot{y}\dot{y} + \frac{a^3\dot{x} - 2a\dot{a}y\dot{y}}{2\sqrt{ax - yy}} = 0$$

Et per operationem repetitam pergitur ad fluxiones secundas, tertias & sequentes. Sit æquatio $zy^3 - z^4 + a^4 = 0$, & fiet per operationem primam $\dot{zy}^3 + 3z\dot{zy}^2 - 4z\dot{z}^3 = 0$, per secundam $\ddot{zy}^3 + 6z\ddot{zy}^2 + 3z\ddot{yy}^2 + 6z\dot{y}^2\dot{y} - 4z\dot{z}^3 - 12z\dot{z}^2\dot{z} = 0$, per tertiam $\ddot{zy}^3 + 9z\ddot{yy}^2 + 9z\ddot{y}^2\dot{y} + 18z\dot{y}^2\dot{y} + 3z\ddot{y}\dot{y}^2 + 18z\dot{y}\dot{y}\dot{y} + 6z\dot{y}^3 - 4z\dot{z}^3 - 36z\dot{z}^2\dot{z} - 24z^3\dot{z} = 0$.

Ubi vero sic pergitur ad fluxiones secundas, tertias & sequentes, convenit quantitatem aliquam ut uniformiter fluentem considerare, & pro ejus fluxione prima unitatem scribere, pro secunda vero & sequentibus nihil. Sit æquatio $zy^3 - z^4 + a^4 = 0$, ut supra; & fluat z uniformiter, sitq; ejus fluxio unitas, & fiet per operationem primam $y^3 + 3z\dot{y}^2 - 4z\dot{z} = 0$, per secundam $6y\dot{y}^2 + 3z\ddot{y}^2 + 6z\dot{y}^2\dot{y} - 12z\dot{z} = 0$, per tertiam $9y\ddot{y}^2 + 18y\dot{y}^2\dot{y} + 3z\ddot{y}\dot{y}^2 + 18z\dot{y}\dot{y}\dot{y} + 6z\dot{y}^3 - 24z\dot{z} = 0$.

In hujus autem generis æquationibus concipiendum est quod fluxiones in singulis terminis sint ejusdem ordinis, id est vel omnes primi ordinis \dot{y} , \dot{z} , vel omnes secundi \ddot{y} , \dot{y}^2 , $\dot{y}\dot{z}$, \dot{z}^2 , vel omnes tertii \ddot{y} , $\ddot{y}\dot{y}$, $\ddot{y}\dot{z}$, \dot{y}^3 , $\dot{y}^2\dot{z}$, $\dot{y}\dot{z}^2$, \dot{z}^3 &c. Et ubi res aliter se habet complendus est ordo per subintellectas fluxiones quantitatis uniformiter fluentis. Sic æquatio novissima complendo ordinem tertium fit $9\dot{z}\ddot{y}y^2 + 18\dot{z}\dot{y}^2\dot{y} + 3z\ddot{y}y^2 + 18z\ddot{y}y\dot{y} + 6z\dot{y}^3 - 24z\dot{z}^3 = 0$.

PROP. II. PROB. II.

Invenire Curvas quæ quadrari possunt.

Sit ABC figura invenienda, BC Ordinatum applicata rectangula, & AB abscissa. Producat CB ad E ut sit BE = 1, & compleatur parallelogrammum ABED: & arearum ABC, ABED fluxiones erunt ut BC & BE. Assumatur igitur æquatio quævis qua relatio arearum definiatur, & inde dabitur relatio ordinatarum BC & BE per Prop. I. Q. E. I. Fig. 4.

Hujus rei exempla habentur in Propositionibus duabus sequentibus.

PROP.

PROP. III. THEOR. I.

Si pro abscissa AB & area AE seu $AB \times I$ promiscue scribatur z , & si pro e $\dot{+} fz^n \dot{+} gz^{2n} \dot{+} hz^{3n} \dot{+} \&c.$ scribatur R : fit autem area Curvæ $z^\theta R^\lambda$ erit. ordinatim applicata $BC =$

$$\theta e \dot{+} \frac{\theta}{\lambda n} fz^n \dot{+} \frac{\theta}{2\lambda n} gz^{2n} \dot{+} \frac{\theta}{3\lambda n} hz^{3n} \dot{+} \&c. \text{ in } z^{\theta-1} R^{\lambda-1}.$$

Demonstratio.

Nam si fit $z^\theta R^\lambda = v$, erit per Prop. I, $\theta z z^{\theta-1} R^\lambda \dot{+} \lambda z^\theta R R^{\lambda-1} = \dot{v}$. Pro R^λ in primo æquationis termino & z^θ in secundo scribe $RR^{\lambda-1}$ & $zz^{\theta-1}$, & fiet $\theta z R \dot{+} \lambda z R$ in $z^{\theta-1} R^{\lambda-1} = \dot{v}$. Erat autem $R = e \dot{+} fz^n \dot{+} gz^{2n} \dot{+} hz^{3n} \dot{+} \&c.$ & inde per Prop. I. fit $\dot{R} = \dot{+} fzz^{n-1} \dot{+} 2ngzz^{2n-1} \dot{+} 3nhzz^{3n-1} \dot{+} \&c.$ quibus substitutis & scripta BE seu v pro z , fiet

$$\theta e \dot{+} \frac{\theta}{\lambda n} \dot{+} fz^n \dot{+} \frac{\theta}{2\lambda n} gz^{2n} \dot{+} \frac{\theta}{3\lambda n} hz^{3n} \dot{+} \&c. \text{ in } z^{\theta-1} R^{\lambda-1} = v = BC.$$

Q. E. D.

PROP.

PROP. IV. THEOR. II.

Si Curvæ absciffa AB fit z, & fi pro e + fzⁿ + gz²ⁿ + &c. scribatur R, & pro k + lzⁿ + mz²ⁿ + &c. scribatur S; fit autem area Curvæ z^θ R^λ S^μ: erit ordinatim applicata BC =

$$\left. \begin{array}{l}
 \theta ek \frac{+\theta}{+\lambda n} fk z^n \frac{+\theta}{+\lambda n} gkz^{2n} \cdot * \dots * \dots \dots \\
 \frac{+\theta}{+\mu n} el z^n \frac{+\theta}{+\lambda n} fl z^{2n} \frac{+\theta}{+\lambda n} glz^{3n} * \dots \dots \\
 \frac{+\theta}{+\mu n} emz^{2n} \frac{+\theta}{+\lambda n} finz^{3n} \frac{+\theta}{+\lambda n} gmz^{4n}
 \end{array} \right\} \text{ in } z^{\theta-1} R^{\lambda-1} S^{\mu-1}$$

Demonstratur ad modum Propositionis superioris.

PROP. V. THEOR. III.

Si Curvæ absciffa AB fit z, & pro e + fzⁿ + gz²ⁿ + hz³ⁿ + &c. scribatur R: fit autem ordinatim applicata z^{θ-1}R^{λ-1} in a + bzⁿ + cz²ⁿ + dz³ⁿ + &c. & ponatur $\frac{\theta}{n} = r$. r + λ = s. s + λ = t. t + λ = v. &c. erit area

$$z^{\theta} R^{\lambda} \text{ in } \frac{+\frac{1}{n} a}{r, e} + \frac{+\frac{1}{n} b - s f A}{r + 1, e} z^n + \frac{+\frac{1}{n} c - s f B - t g A}{r + 2, e} z^{2n} + \frac{+\frac{1}{n} d - s f C - t g B - v h A}{r + 3, e} z^{3n} + \frac{+\frac{1}{n} f D - t g C - v h B}{r + 4, e} z^{4n} + \&c.$$

A a a denotant

denotant totas coefficientes datas terminorum singulorum in serie cum signis suis + & —, nempe A primi termini coefficientem $\frac{a}{r e}$, B secundi coefficientem $\frac{b - r f A}{r + 1, e}$, C tertii coefficientem $\frac{c - r f B - r^2 g A}{r + 2, e}$, & sic deinceps.

Demonstratio.

Sunto juxta Propositionem tertiam,

Curvarum Ordinatae

& earundem areae.

1. $\theta eA \frac{+}{-} \frac{\theta}{\lambda n} fAz^n \frac{+}{-} \frac{\theta}{2\lambda n} gAZ^{2n} \frac{+}{-} \frac{\theta}{3\lambda n} hAz^{3n} \&c.$	}	$Az^\theta R^\lambda.$
2 $\dots \theta \frac{+}{-} \frac{\theta}{\lambda n} eBz^n \frac{+}{-} \frac{\theta}{\lambda n} fBz^{2n} \frac{+}{-} \frac{\theta}{2\lambda n} gBz^{3n} \&c.$		$Bz^{\theta+1} R^\lambda.$
3 $\dots \dots \dots \frac{+}{-} \frac{\theta}{\lambda n} eCz^{2n} \frac{+}{-} \frac{\theta}{\lambda n} fCz^{3n} \&c.$		$Cz^{\theta+2} R^\lambda.$
4 $\dots \dots \dots \frac{+}{-} \frac{\theta}{\lambda n} eDz^{3n} \&c.$		$Dz^{\theta+3} R^\lambda.$

Et si summa ordinarum ponatur æqualis ordinatae $a \frac{+}{-} bz^n \frac{+}{-} cz^{2n} \frac{+}{-} dz^{3n} \frac{+}{-} \&c.$ in $z^{\theta-1} R^{\lambda-1}$, summa arearum $z^\theta R^\lambda$ in $A \frac{+}{-} Bz^n \frac{+}{-} Cz^{2n} \frac{+}{-} Dz^{3n} \frac{+}{-} \&c.$ æqualis erit areae Curvæ cujus ista est ordinata. Æquentur igitur Ordinarum termini correspondentes, & fiet $a = \theta eA$, $b = \frac{\theta}{+ \lambda n} fA \frac{+}{-} \frac{\theta}{n} eB$, $c = \frac{\theta}{+ 2\lambda n} gA \frac{+}{-} \frac{\theta}{+ \lambda n} fB \frac{+}{-} \frac{\theta}{+ 2n} eC \&c.$ & inde $\frac{a}{\theta e} = A$. $\frac{b - \frac{\theta}{+ \lambda n} fA}{\theta \frac{+}{-} n, e} = B$. $\frac{c - \frac{\theta}{+ 2\lambda n} gA - \frac{\theta}{+ \lambda n} fB}{\theta \frac{+}{-} 2n, e} = C$. Et sic deinceps in infinitum.

nitum. Pone jam $\frac{\theta}{n} = r$. $r + \lambda = s$. $s + \lambda = t$ &c. & in area $z^{\theta} R^{\lambda} \times A + Bz^n + Cz^{2n} + Dz^{3n}$ &c. scribe ipsorum A, B, C, &c. valores inventos & prodibit series proposita. Q. E. D.

Et notandum est quod Ordinata omnis duobus modis iu seriem resolvitur. Nam index n vel affirmativus est potest vel negativus. Proponatur Ordinata $\frac{3k - lzz}{zz\sqrt{kz - lzz + mzz}}$. Hæc vel sic scribi potest $z^{-\frac{1}{2}} \times \sqrt{3k - lzz} \times k - lzz + mzz$, vel sic $z \times \sqrt{-1 + 3kz^2 \times m - lzz^{-1} + kz^{-3}}$. In casu priore est $a = 3k$. $b = 0$. $c = -l$. $e = k$. $f = 0$. $g = -l$. $h = m$. $\lambda = -\frac{1}{2}$. $n = 1$. $\theta - 1 = -\frac{1}{2}$. $\theta = -\frac{3}{2} = r$. $s = -1$. $t = -\frac{1}{2}$. $v = 0$. In posteriore est $a = -1$. $b = 0$. $c = 3k$. $e = m$. $f = -l$. $g = 0$. $h = 1$. $\lambda = -\frac{1}{2}$. $n = -1$. $\theta - 1 = 1$. $\theta = 2$. $r = -2$. $s = -1\frac{1}{2}$. $t = -1$. $v = -\frac{1}{2}$. Tentandus est casus uterque. Et si serierum alterutra ob terminos tandem deficientes abrumptur ac terminatur, habebitur area Curvæ in terminis finitis. Sic in exempli hujus priore casu scribendo in serie valores ipsorum a, b, c, e, f, g, h, λ , θ , r, s, t, v, termini omnes post primum evanescent in infinitum & area Curvæ prodit $-\frac{2\sqrt{k - lzz + mzz}}{z^3}$. Et hæc area ob signum negativum adjacet abscissæ ultra ordinatam productæ. Nam area omnis affirmativa adjacet tam abscissæ quam ordinatæ, negativa vero cadit ad contrarias partes ordinatæ & adjacet abscissæ productæ, manente scilicet signo Ordinatæ. Hoc modo series alterutra & nonnunquam utraque semper terminatur & finita evadit si Curva geometricè quadrari potest. At si Curva talem quadraturam non admittit, series utraq; continuabitur in infinitum, & ea-

rum altera converget & aream dabit approximando, præterquam ubi r (propter aream infinitam) vel nihil est vel numerus integer & negativus, vel ubi $\frac{z}{c}$ æqualis est unitati. Si $\frac{z}{c}$ minor est unitate, converget series in qua index „ affirmativus est : sin $\frac{z}{c}$ unitate major est, converget series altera. In uno casu area adjacet abscissæ ad usq; ordinatam ductæ, in altero adjacet abscissæ ultra ordinatam productæ.

Nota insuper quod si Ordinata contentum est sub factore rationali Q & factore furdo irreducibili R^π , & factoris furdi latus R non dividit factorem rationalem Q ; erit $\lambda-1 = \pi$ & $R^{\lambda-1} = R^\pi$. Sin factoris furdi latus R dividit factorem rationalem semel, erit $\lambda-1 = \pi - 1$ & $R^{\lambda-1} = R^{\pi-1}$: si dividit bis, erit $\lambda-1 = \pi - 2$ & $R^{\lambda-1} = R^{\pi-2}$: si ter, erit $\lambda-1 = \pi - 3$, & $R^{\lambda-1} = R^{\pi-3}$: & sic deinceps.

Si Ordinata est fractio rationalis irreducibilis cum Denominatore ex duobus vel pluribus terminis composito : resolvendus est denominator in divisores suos omnes primos. Et si divisor sit aliquis cui nullus alius est æqualis, Curva quadrari nequit : Sin duo vel plures sint divisores æquales, rejiciendus est eorum unus, & si adhuc alii duo vel plures sint sibi mutuo æquales & prioribus inæquales, rejiciendus est etiam eorum unus, & sic in aliis omnibus æqualibus si adhuc plures sint : deinde divisor qui relinquitur vel contentum sub divisoribus omnibus qui relinquuntur, si plures sunt, ponendum est pro R , & ejus quadrati reciprocum R^{-2} pro $R^{\lambda-1}$, præterquam ubi contentum illud est quadratum vel cubus vel quadrato quadratum, &c. quo casu ejus latus
ponen-

ponendum est pro R & potestatis index 2 vel 3 vel 4 negative sumptus pro λ . & Ordinata ad denominatorem R^2 vel R^3 vel R^4 vel R^5 &c. reducenda.

Ut si ordinata sit $\frac{z^5+z^4-8z^3}{z^5+z^4-5z^3-2z^2+8z-4}$; quoniam hæc fractio irreducibilis est & denominatoris divisores sunt pares, nempe $z-1$, $z-1$, $z-1$ & $z+2$, $z+2$, rejicio magnitudinis utriusque divisorem unum & reliquorum $z-1$, $z-1$, $z+2$ contentum z^3-3z+2 pono pro R & ejus quadrati reciprocum $\frac{1}{R^2}$ seu R^{-2} pro $R^{\lambda-1}$. Dein Ordinatum ad denominatorem R^2 seu $R^{1-\lambda}$ reduco, & fit $\frac{z^6-9z^4+8z^3}{z^3-3z+2}$ quad., id est $z^3 \times 8 - 9z + z^3 \times 2 - 3z + z^3 \times 2$. Et inde est $a=8$. $b=-9$. $c=0$. $d=-1$, &c. $e=2$. $f=-3$. $g=0$. $h=1$. $\lambda-1=-2$. $\lambda=-1$. $n=1$. $\theta-1=3$. $\theta=4=1$. $s=3$. $t=2$. $v=1$. Et his in serie scriptis prodit area $\frac{z^4}{z^3-3z+2}$, terminis omnibus in tota serie post primum evanescentibus.

Si deniq; Ordinata est fractio irreducibilis & ejus denominator contentum est sub factore rationali Q & factore surdo irreducibili R^π , inveniendi sunt lateris R divisores omnes primi, & rejiciendus est divisor unus magnitudinis cujusq; & per divisores qui restant, siqui sint, multiplicandus est factor rationalis Q: & si factum æquale est lateri R vel lateris illius potestati alicui cujus index est numerus integer, esto index ille m, & erit $\lambda-1 = -\pi-m$, & $R^{\lambda-1} = R^{-\pi-m}$. Ut si Ordinata sit $\frac{3q^5-q+x+9q^2xx-qqx^3-6qx^4}{qq-xx\sqrt{\text{cub. } q^3+qqx-qqx-x}}$, quoniam

quoniam factoris furdi latus R feu $qz + qqx - qxx - xz$ divisores habet $q + x$, $q - x$, $q - x$ qui duarum sunt magnitudinum, rejicio divisorem unum magnitudinis utriusq; & per divisorem $q + x$ qui relinquitur multiplico factorem rationalem $qq - xx$. Et quoniam factum $qz + qqx - qxx - xz$ æquale est lateri R, pono $m = 1$. & inde, cum π fit $\frac{1}{3}$, fit $\lambda - 1 = -\frac{4}{3}$. Ordinatam igitur reduco ad denominatorem $R^{\frac{4}{3}}$ & fit $Z^o \times \frac{3q^6 + 2q^5x + 8q^4xx + 8q^3x^3 - 7qqx^4 - 6qx^5}{3qqx + 3x^3} \times q^3 + qqx - qxx - xz$. Unde est $a = 3q^6$. $b = 2q^5$ & c. $e = q^3$. $f = qq$ & c. $\theta - 1 = 0$. $\theta = 1 = \mu$. $\lambda = -\frac{1}{3}$. $r = 1$. $s = \frac{2}{3}$. $t = \frac{1}{3}$. $v = 0$. Et his in ferie scriptis prodit area $\frac{3qqx + 3x^3}{\sqrt{\text{cub. } a^3 + aax - axx - x^3}}$ terminis omnibus in ferie tota post tertium evanescentibus.

PROP. VI. THEOR. IV.

Si Curvæ absciffa AB fit z , & scribantur R pro $e + fz^n + gz^{2n} + hz^{3n} + \&c.$ & S pro $k + lz^n + mz^{2n} + nz^{3n} + \&c.$ fit autem ordinatim applicata $z^{\theta-1} R^{\lambda-1} S^{\mu-1}$ in $a + bz^n + cz^{2n} + dz^{3n} + \&c.$ & si terminorum, e , f , g , h , & c. & k , l , m , n . & c. rectangula sint.

ek	fk	gk	hk	&c.
el	fl	gl	hl	&c.
em	fm	gm	hm	&c.
en	fn	gn	hn	&c.

Et

Et si reſtangularum illorum coefficientes nume-
rales ſint reſpective

$$\begin{aligned} \frac{1}{n} \theta &= r. & r \dashv \lambda &= s. & s \dashv \lambda &= t. & t \dashv \lambda &= v. & \&c. \\ r \dashv \mu &= \acute{s}. & s \dashv \mu &= \acute{t}. & t \dashv \mu &= \acute{v}. & v \dashv \mu &= \acute{w}. & \&c. \\ \acute{s} \dashv \mu &= \acute{\acute{t}}. & \acute{t} \dashv \mu &= \acute{\acute{v}}. & \acute{v} \dashv \mu &= \acute{\acute{w}}. & \acute{\acute{w}} \dashv \mu &= \acute{\acute{x}}. & \&c. \\ \acute{\acute{t}} \dashv \mu &= \acute{\acute{\acute{v}}}. & \acute{\acute{\acute{v}}} \dashv \mu &= \acute{\acute{\acute{w}}}. & \acute{\acute{\acute{w}}} \dashv \mu &= \acute{\acute{\acute{x}}}. & \acute{\acute{\acute{x}}} \dashv \mu &= \acute{\acute{\acute{y}}}. & \&c. \end{aligned}$$

area Curvæ erit hæc

$$\begin{aligned} z^\theta R^\lambda S^\mu \text{ in } & \frac{\frac{1}{n} a}{r e k} \dashv \frac{\frac{1}{n} b \overset{-s f k}{\dashv s e l} A}{r \dashv 1, e k} z^\eta \dashv \frac{\frac{1}{n} c \overset{-t g k}{\dashv s \dashv 1, f k} B \overset{-t' f l}{\dashv t' e m} A}{r \dashv 2, e k} z^{2\eta} \\ & \dashv \frac{\frac{1}{n} d \overset{-s \dashv 2, f k}{\dashv s' \dashv 2, e l} C \overset{-t \dashv 1, g k}{\dashv t' \dashv 1, f l} B \overset{-v h k}{\dashv v' g l} A}{r \dashv 3, e k} z^{3\eta} \dashv \&c. \end{aligned}$$

Ubi A denotat termini primi coefficientem datam $\frac{1}{n} \frac{a}{r e k}$ cum ſigno ſuo \dashv vel $—$, B coefficientem datam ſecundi, C coefficientem datam tertii, & ſic deinceps. Terminorum vero, a, b, c, &c. k, l, m, &c. unus vel plures deeſſe poſſunt. Demonstratur Propoſitio ad modum præcedentis, & quæ ibi notantur hic obtinent. Pergit autem ſeries talium Propoſitionum in infinitum, & Progreſſio ſeriei manifeſta eſt.

PROP.

PROP. VII. THEOR. V.

Si pro $e \pm fz^n \pm gz^{2n} \pm$ &c. scribatur R ut supra, & in Curvæ alicujus Ordinata $z^{\theta \pm n \sigma} R^{\lambda \pm \tau}$ maneant quantitates datæ $\theta, n, \lambda, e, f, g,$ &c. & pro σ ac τ scribantur successive numeri quicunq; integri: & si detur area unius ex Curvis quæ per Ordinatæ innumeras sic prodeuntés designantur si Ordinatæ sunt duorum nominum in vinculo radicis, vel si dentur areæ duarum ex Curvis si Ordinatæ sunt trium nominum in vinculo radicis, vel areæ trium ex Curvis si Ordinatæ sunt quatuor nominum in vinculo radicis, & sic deinceps in infinitum: dico quod dabuntur areæ curvarum omnium. Pro nominibus hic habeo terminos omnes in vinculo radicis tam deficientes quam plenos quorum indices dignitatum sunt in progressione arithmetica. Sic ordinata $\sqrt{a^4 - ax^3} \pm x^4$ ob terminos duos inter a^4 & $-ax^3$ deficientes pro quinquinomio haberi debet. At $\sqrt{a^4 \pm x^4}$ binomium est & $\sqrt{a^4 \pm x^4 - \frac{x^8}{a^4}}$ trinonium, cum progressio jam per majores differentias procedat. Propositio vero sic demonstratur.

C A S. I.

Sunto Curvarum duarum Ordinatæ $pz^{\theta-1} R^{\lambda-1}$ & $qz^{\theta+n-1} R^{\lambda-1}$, & areæ pA & qB , existente R quantitate trium nominum $e \pm fz^n \pm gz^{2n}$. Et cum per
Prop.

Prop. III. fit $z^\theta R^\lambda$ area curvæ cujus Ordinata est $\theta e^{-\frac{\theta}{\lambda}} f z^\theta - \frac{\theta}{2\lambda} g z^{2\theta}$ in $z^{\theta-1} R^{\lambda-1}$, subduc Ordinatæ & areas priores de area & Ordinata posteriori, & manebit $\theta e^{-\frac{\theta}{\lambda}} f z^\theta - \frac{\theta}{2\lambda} g z^{2\theta}$ in $z^{\lambda-1} R^{\lambda-1}$ Ordinata nova Curvæ, & $-q z^\theta$

$z^\theta R^\lambda - p A - q B$ ejusdem area. Pone $\theta e = p$ & $\theta f - \frac{\theta}{\lambda} g = q$ & Ordinata evadet $\frac{\theta}{2\lambda} g z^{2\theta}$ in $z^{\theta-1} R^{\lambda-1}$, & area $z^\theta R^\lambda - \theta e A - \theta f B - \frac{\theta}{\lambda} g B$. Divide utramq; per $\theta g - \frac{2\lambda}{\theta} g$, & aream prodeuntem dic C, & assumpta utcunq; r, erit rC area Curvæ cujus Ordinata est $r z^{\theta+\frac{2\theta-1}{2\lambda}} R^{\lambda-1}$. Et qua ratione ex areis pA & qB aream rC Ordinatæ $r z^{\theta+\frac{2\theta-1}{2\lambda}} R^{\lambda-1}$ congruentem invenimus, licebit ex areis qB & rC aream quartam puta sD, ordinatæ $s z^{\theta+\frac{3\theta-1}{2\lambda}} R^{\lambda-1}$ congruentem invenire, & sic deinceps in infinitum. Et par est ratio progressionis ab areis B & A in partem contrariam pergentis. Si terminorum $\theta, \theta - \frac{\theta}{\lambda},$ & $\theta - \frac{2\theta}{\lambda}$ aliquis deficit & seriem abrumpit, assumatur area pA in principio progressionis unius & area qB in principio alterius, & ex his duabus areis dabuntur areæ omnes in progressionem utraque. Et contra, ex aliis duabus areis assumptis fit regressus per analysin ad areas A & B, adeo ut ex duabus datis cæteræ omnes dentur. Q. E. O. Hic est casus Curvarum ubi ipse index θ augetur vel diminuitur perpetua additione vel subtractione quantitatis. Casus alter est Curvarum ubi index λ augetur vel diminuitur unitatibus.

C A S. II.

Ordinatæ $pz^{\theta-1}R^\lambda$ & $qz^{\theta-1+n}R^\lambda$, quibus areae pA & qB jam respondeant, si in R seu $e - fz^n + gz^{2n}$ ducantur ac deinde ad R vicissim applicentur, evadunt $pe - pfz^n - pgz^{2n} \times z^{\theta-1}R^{\lambda-1}$ & $qez^n - qfz^{2n} - qgz^{3n} \times z^{\theta-1}R^{\lambda-1}$. Et per Prop. III. est $az^\theta R^\lambda$ area Curvæ cujus Ordinata est $\theta ae \frac{+}{+\lambda n} afz^n - \frac{+}{+2\lambda n} agz^{2n}$ in $z^{\theta-1}R^{\lambda-1}$, & $bz^{\theta+1}R^\lambda$ area Curvæ cujus ordinata est $\frac{+}{+\lambda n} bez^n - \frac{+}{+\lambda n} bfz^{2n} - \frac{+}{+2\lambda n} bgz^{3n}$ in $z^{\theta-1}R^{\lambda-1}$. Et harum quatuor arearum summa est $pA - qB - az^\theta R^\lambda - bz^{\theta+1}R^\lambda$ & summa respondentium ordinarum

$$\begin{array}{r}
 \theta ae \quad \frac{+}{+\lambda n} afz^n \quad \frac{+}{+2\lambda n} agz^{2n} \quad \frac{+}{+\lambda n} bgz^{3n} \text{ in } z^{\theta-1}R^{\lambda-1}. \\
 +pe \quad \frac{+}{+\lambda n} be \quad \frac{+}{+\lambda n} bf \quad + qg \\
 + pf \quad + pg \\
 + qe \quad + qf
 \end{array}$$

Si terminus primus tertius & quartus ponantur seorsum æquales nihilo, per primum fiet $\theta ae - pe = 0$ seu $-\theta a = p$, per quartum $-\theta b - n b - 2\lambda n b = q$, & per tertium (eliminando p & q) $\frac{2ag}{f} = b$. Unde secundus fit $\frac{\lambda n a f f - 4\lambda n a g e}{f}$, adeoq; summa quatuor Ordinarum est $\frac{\lambda n a f f - 4\lambda n a g e}{f} z^{\theta-1+n}R^{\lambda-1}$, & summa totidem respondentium arearum est $a z^\theta R^\lambda - \frac{2ag}{f} z^{\theta+1}R^\lambda - \theta a A - \frac{2\theta-1-2n-4\lambda n}{f} agB$.
 Divi-

Dividantur hæ summæ per $\frac{\lambda n a f f - 1 \lambda n a e}{f}$, & si Quotum posterius dicatur D, erit D area curvæ cujus ordinata est Quotum prius $z^{\theta + \eta - 1} R^{\lambda - 1}$. Et eadem ratione ponendo omnes Ordinatæ terminos præter primum æquales nihilo potest area Curvæ inveniri cujus Ordinata est $z^{\theta - 1} R^{\lambda - 1}$. Dicatur area ista C, & qua ratione ex areis A & B inventæ sunt areæ C ac D, ex his areis C ac D inveniri possunt aliæ duæ E & F ordinatis $z^{\theta - 1} R^{\lambda - 2}$ & $z^{\theta + \eta - 1} R^{\lambda - 2}$ congruentes, & sic deinceps in infinitum. Et per analysin contrariam regredi licet ab areis E & F ad areas C ac D, & inde ad areas A & B, aliasq; quæ in progressionem sequuntur. Igitur si index λ perpetua unitatum additione vel subtractione augeatur vel minuat, & ex areis quæ Ordinatis sic prodeuntibus respondent duæ simplicissimæ habentur; dantur aliæ omnes in infinitum. Q. E. O.

C A S. III.

Et per casus hosce duos conjunctos, si tam index θ perpetua additione vel subtractione ipsius η , quam index λ perpetua additione vel subtractione unitatis, utcunq; augeatur vel minuat, dabuntur areæ singulis prodeuntibus Ordinatis respondentes. Q. E. O.

C A S. IV.

Et simili augmento si ordinata constat ex quatuor nominibus in vinculo radicali & dantur tres arearum, vel si constat ex quinque nominibus & dantur quatuor arearum, & sic deinceps: dabuntur areæ omnes quæ addendo vel subducendo numerum η indici θ vel unitatem indici λ generari possunt. Et par est ratio Curvarum ubi ordinatæ ex binomiis constantur, & area una earum quæ non sunt geometricæ quadrabiles datur. Q. E. O.

PROP. VIII. THEOR. VI.

Si pro $e + fz^n + gz^{2n} + \&c.$ & $k + lz^n + mz^{2n} + \&c.$ scribantur R & S ut supra, & in Curvæ alicujus Ordinata $z^{\theta - \lambda \sigma} R^{\lambda - \tau} S^{\mu - \nu}$ maneant quantitates datæ θ , η , λ , μ , e , f , g , k , l , m , &c. & pro σ , τ , & ν , scribantur successive numeri quicunq; integri: & si dentur areæ duarum ex curvis quæ per ordinatas sic prodeutes designantur si quantitates R & S sunt binomia, vel si dentur areæ trium ex curvis si R & S conjunctim ex quinque nominibus constant, vel areæ quatuor ex curvis si R & S conjunctim ex sex nominibus constant, & sic deinceps in infinitum: dico quod dabuntur areæ curvarum omnium.

Demonstratur ad modum Propositionis superioris.

PROP.

PROP. IX. THEOR. VII.

Æquantur Curvarum areæ inter se quarum Ordinatae sunt reciproce ut fluxiones Abfcissarum.

Nam contenta sub Ordinatis & fluxionibus Abfcissarum erunt æqualia, & fluxiones arearum sunt ut hæc contenta.

COROL. I.

Si assumatur relatio quævis inter Abfcissas duarum Curvarum, & inde per Prop. I. quæretur relatio fluxionum Abfcissarum, & ponantur Ordinatae reciproce proportionales fluxionibus, inveniri possunt innumeræ Curvæ quarum areæ sibi mutuo æquales erunt.

COROL. II.

Sic enim Curva omnis cujus hæc est Ordinata $z^{\theta-1}$ in $\frac{e + fz^n + gz^{2n} + \&c.}{\lambda}$ assumendo quantitatem quamvis pro v & ponendo $\frac{z}{v} = s$ & $z^s = x$, migrat in aliam sibi æqualem cujus ordinata est $\frac{v}{n} x^{\frac{\theta-n}{n}}$ in $\frac{e + fx^v + gx^{2v} + \&c.}{\lambda}$.

CO-

COROL. III.

Et Curva omnis cujus Ordinata est $z^{\theta-1}$ in $\frac{a + bz^n + cz^{2n} + \&c. \times e + fz^n + gz^{2n} + \&c.}{\&c.}^\lambda$, affumendo quantitatem quamvis pro v & ponendo $\frac{v}{n} = s$ & $z^s = x$, migrat in aliam fibi æqualem cujus ordinata est $\frac{v}{n} x^{\frac{v\theta-n}{n}}$ in $\frac{a + bx^v + cx^{2v} + \&c. \times e + fx^v + gx^{2v} + \&c.}{\&c.}^\lambda$.

COROL. IV.

Et Curva omnis cujus Ordinata est $z^{\theta-1}$ in $\frac{a + bz^n + cz^{2n} + \&c. \times e + fz^n + gz^{2n} + \&c.}{\&c.}^\lambda \times \frac{k + lz^n + mz^{2n} + \&c.}{\&c.}^\mu$, affumendo quantitatem quamvis pro v & ponendo $\frac{v}{n} = s$ & $z^s = x$, migrat in aliam fibi æqualem cujus ordinata est $\frac{v}{n} x^{\frac{v\theta-n}{n}}$ in $\frac{a + bx^v + cx^{2v} + \&c. \times e + fx^v + gx^{2v} + \&c.}{\&c.}^\lambda \times \frac{k + lx^v + mx^{2v} + \&c.}{\&c.}^\mu$.

COROL. V.

Et Curva omnis cujus Ordinata est $z^{\theta-1}$ in $\frac{e + fz^n + gz^{2n} + \&c.}{\&c.}^\lambda$ ponendo $\frac{1}{z} = x$ migrat in aliam fibi æqualem cujus ordinata est $\frac{1}{x^{\theta+1}} \times \frac{e + fx^n}{\&c.}^\lambda$ id est $\frac{1}{x^{\theta+1+n\lambda}} \times \overline{e + fx^n}^\lambda$ si duo sunt nomina in vinculo radice vel $\frac{1}{x^{\theta+1+n\lambda}} \times \overline{g + fx^n + ex^{2n}}^\lambda$ si tria sunt nomina ; & sic deinceps.

CO-

C O R O L. VI.

Et Curva omnis cujus Ordinata est $z^{\theta-1}$ in $\overline{e + fz^n + gz^{2n} + \&c.}^\lambda \times \overline{k + lz^n + mz^{2n} + \&c.}^\mu$ ponendo $\frac{z}{\lambda} = x$ migrat in aliam sibi æqualem cujus ordinata est $\frac{1}{x^{\theta-1}} \times \overline{e + fx^n + gx^{2n} + \&c.}^\lambda \times \overline{k + lx^n + mx^{2n} + \&c.}^\mu$ id est $\frac{1}{x^{\theta-1+n\lambda+n\mu}} \times \overline{e + ex^\lambda}^\lambda \times \overline{l + kx^\mu}^\mu$ si bina sunt nomina in vinculis radicum, vel $\frac{1}{x^{\theta-1+2n\lambda+n\mu}} \times \overline{g + fx^n + ex^{2n}}^\lambda \times \overline{l + kx^\mu}^\mu$ si tria sunt nomina in vinculo radice prioris ac duo in vinculo posterioris: & sic in aliis. Et nota quod areæ duæ æquales in novissimis hisce duobus Corollariis jacent ad contrarias partes ordinarum. Si area in alterutra curva adjacet abscissæ, area huic æqualis in altera curva adjacet abscissæ productæ.

C O R O L. VII.

Si relatio inter Curvæ alicujus Ordinatam y & Abscissam z definiatur per æquationem quamvis factam hujus formæ, y^α in $e + fy^n z^\delta + gy^{2n} z^{2\delta} + hy^{3n} z^{3\delta} + \&c. = z^\beta$ in $k + ly^n z^\delta + my^{2n} z^{2\delta} + \&c.$ hæc figura assumendo $s = \frac{n-\delta}{n}$, $x = \frac{1}{s} z^s$ & $\lambda = \frac{n-\delta}{\alpha\delta + \beta n}$, migrat in aliam sibi æqualem cujus Abscissa x , ex data Ordinata

Ordinata v , determinatur per æquationem non affectam $\frac{1}{s}v^{\alpha\lambda} \times e + fv^n + gv^{2n} + hv^{3n} + \&c. \uparrow^{\lambda} \times k + lv^n + mv^{2n} + \&c. \uparrow^{\lambda} = x$.

C O R O L. VIII.

Si relatio inter Curvæ alicujus Ordinatam y & Abscissam z definitur per æquationem quamvis affectam hujus formæ, y^{α} in $e + fy^n z^{\delta} + gy^{2n} z^{2\delta} + \&c.$ $= z^{\beta}$ in $k + ly^n z^{\delta} + my^{2n} z^{2\delta} + \&c.$ $+ z^{\gamma}$ in $p + qy^n z^{\delta} + ry^{2n} z^{2\delta} + \&c.$ hæc figura assumendo $s = \frac{n-\delta}{n}$, $x = \frac{1}{s}z^s$, $\mu = \frac{\alpha\delta + \beta n}{n-\delta}$ & $\nu = \frac{\alpha\delta + \gamma n}{n-\delta}$, migrat in aliam sibi æqualem cujus Abscissa x ex data Ordinata v determinatur per æquationem minus affectam v^{α} in $e + fv^n + gv^{2n} + \&c. = s^{\mu}x^{\mu}$ in $k + lv^n + mv^{2n} + \&c. + s^{\nu}x^{\nu}$ in $p + qv^n + rv^{2n} + \&c.$

C O R O L. IX.

Curva omnis cujus Ordinata est $\pi z^{\theta-1}$ in $\frac{v}{e + \frac{v}{n}fz^n + \frac{v}{2n}gz^{2n} + \&c. \times e + fz^n + gz^{2n} \&c. \uparrow^{\lambda-1} \times [a + b|ez^{\nu} + fz^{\nu+1n} + gz^{\nu+2n} + \&c. \uparrow^{\omega}]^{\sigma}$, si fit $\theta = \nu\lambda$ & assumatur $x = \frac{v}{e + fz^{\nu+1n} + gz^{\nu+2n} + \&c. \uparrow^{\pi}}$, $\sigma = \frac{\pi}{\omega}$ & $\delta = \frac{\pi}{\omega}$ migrat in aliam sibi æqualem cujus ordinata est $x^{\lambda} \times a + bx^{\lambda}$. Et nota quod ordinata prior in

in hoc Corollario evadit simplicior ponendo $\lambda = 1$,
 vel ponendo $\tau = 1$ & efficiendo ut radix dignitatis
 extrahi possit cujus index est ω , vel etiam ponendo
 $\omega = -1$ & $\lambda = 1 = \tau = \sigma = \pi$, ut alios casus præte-
 ream.

C O R O L. X.

Pro $ez^v + fz^{v+n} + gz^{v+2n} + \&c.$ $vez^{v-1} + fz^{v+n-1}$
 $+ gz^{v+2n-1} + \&c.$ $k + lz^n + mz^{2n} + \&c.$ & nlz^{n-1}
 $+ 2nmz^{2n-1} + \&c.$ scribantur R, r, S & s respective, &
 Curva omnis cujus ordinata est $\pi Sr + \phi R^s$ in $R^{\lambda-1} S^{\mu-1}$
 $\times aS^v + bR^\tau$, si fit $\frac{\mu-v\omega}{\lambda} = \frac{v}{\tau} = \frac{\phi}{\pi}$, $\frac{\tau}{\pi} = \sigma$, $\frac{\lambda-\tau}{\pi} = \delta$,
 & $R^\tau S^\delta = x$, migrat in aliam sibi æqualem cujus or-
 dinata est $x^\delta \times a + bx^\sigma$. Et nota quod Ordinata
 prior evadit simplicior, ponendo unitates pro τ, v ,
 & λ vel μ , & faciendo ut radix dignitatis extrahi
 possit cujus index est ω , vel ponendo $\omega = -1$ vel
 $\mu = 0$.

P R O P. X. P R O B. III.

Invenire figuras simpliciffimas cum quibus Curva
 quævis geometrice compari potest, cujus ordinatim
 applicata y per æquationem non affectam ex data ab-
 scissa z determinatur.

C A S. I.

Sit Ordinata $az^{\theta-1}$, & area erit $\frac{1}{\theta}az^{\theta}$, ut ex Prop.V. ponendo $b=0=c=d=f=g=h$ & $e=1$, facile colligitur.

C A S. II.

Sit Ordinata $az^{\theta-1} \times \overline{e + fz^n + gz^{2n}}^{\lambda-1} + \&c.$ & si curva cum figuris rectilineis geometricè comparari potest, quadrabitur per Prop. V. ponendo $b=0=c=d$. Sin minus convertetur in aliam curvam sibi æqualem cujus Ordinata est $\frac{a}{n}x^{\frac{\theta-n}{n}} \times \overline{e + fx + gx^2 + \&c.}^{\lambda-1}$ per Corol. 2. Prop. IX. Deinde si de dignitatum indicibus $\frac{\theta-n}{n}$ & $\lambda-1$ per Prop. VII. rejiciantur unitates donec dignitates illæ fiant quam minimæ, devenietur ad figuras simplicissimas quæ hac ratione colligi possunt. Dein harum unaquæq; per Corol. 5. Prop. IX. dat aliam quæ nonnunquam simplicior est. Et ex his per Prop. III. & Corol. 9 & 10, Prop. IX. inter se collatis, figuræ adhuc simpliciores quandoq; prodeunt. Deniq; ex figuris simplicissimis assumptis factò regressu computabitur area quæsita.

C A S.

C A S. III.

Sit Ordinata $z^{\theta-1} \times \overline{a + bz^n + cz^{2n} + \&c.}$
 $\times \overline{e + fz^n + gz^{2n} + \&c.}^{\lambda-1}$, & hæc figura si quadrari
 potest, quadrabitur per Prop. V. Sin minus, di-
 stinguenda est ordinata in partes $z^{\theta-1} \times a \times \overline{e + fz^n}$
 $\overline{+ gz^{2n} + \&c.}^{\lambda-1}$, $z^{\theta-1} \times bz^n \times \overline{e + fz^n + gz^{2n} + \&c.}^{\lambda-1}$,
 &c. & per Cas. 2. inveniendæ sunt figuræ simpli-
 cissimæ cum quibus figuræ partibus illis respon-
 dentes comparari possunt. Nam areæ figurarum
 partibus illis respondentium sub signis suis + & —
 conjunctæ component aream totam quæsitam.

C A S. IV.

Sit Ordinata $z^{\theta-1} \times \overline{a + bz^n + cz^{2n} + \&c.} \times$
 $\overline{e + fz^n + gz^{2n} + \&c.}^{\lambda-1} \times \overline{k + lz^n + mz^{2n} + \&c.}^{\mu-1}$:
 & si Curva quadrari potest, quadrabitur per Prop. VI.
 Sin minus, convertetur in simpliciolem per Corol. 4.
 Prop. IX. ac deinde comparabitur cum figuris sim-
 plicissimis per Prop. VIII. & Corol. 6, 9 & 10:
 Prop. IX. ut fit in Casu 2 & 3.

C A S. V.

Si Ordinata ex variis partibus constat, partes
 singulæ pro ordinatis curvarum totidem habendæ
 sunt, & curvæ illæ quotquot quadrari possunt, sigilla-

tim quadrandæ sunt, earumq; ordinatæ de ordinata tota demendæ. Dein Curva quam ordinatæ pars residua designat seorsim (ut in Casu 2, 3 & 4,) cum figuris simplicissimis comparanda est cum quibus comparari potest. Et summa arearum omnium pro area Curvæ propositæ habenda est.

C O R O L. I.

Hinc etiam Curva omnis cujus Ordinata est radix quadratica affecta æquationis suæ, cum figuris simplicissimis seu rectilineis seu curvilineis comparari potest. Nam radix illa ex duabus partibus semper constat quæ seorsim spectatæ non sunt æquationum radices affectæ. Proponatur æquatio $ayy + zzyy = 2a^3y + z^3y - z^4$, & extracta radix erit $y = \frac{a^3 + z^3 + a\sqrt{a^4 + 2az^3 - z^4}}{aa + zz}$ cujus pars rationalis $\frac{a^3 + z^3}{aa + zz}$ & pars irrationalis $\frac{a\sqrt{a^4 + 2az^3 - z^4}}{aa + zz}$ sunt ordinatæ curvarum quæ per hanc Propositionem vel quadrari possunt vel cum figuris simplicissimis comparari cum quibus collationem geometricam admittunt.

C O R O L. II.

Et curva omnis cujus Ordinata per æquationem quamvis affectam definitur quæ per Corol. 7. Prop. IX. in æquationem non affectam migrat, vel quadratur

dratur per hanc Propositionem si quadrari potest vel comparatur cum figuris simplicissimis cum quibus comparari potest. Et hac ratione Curva omnis quadratur cujus æquatio est trium terminorum. Nam æquatio illa si affecta sit transmutatur in non affectam per Corol. 7. Prop. IX. ac deinde per Corol. 2 & 5. Prop. IX. in simplicissimam migrando, dat vel quadraturam figuræ si quadrari potest, vel curvam simplicissimam quacum comparatur.

C O R O L. III.

Et Curva omnis cujus Ordinata per æquationem quamvis affectam definitur quæ per Corol. 8. Prop. IX. in æquationem quadraticam affectam migrat; vel quadratur per hanc Propositionem & hujus Corol. 1. si quadrari potest, vel comparatur cum figuris simplicissimis cum quibus collationem geometricam admittit.

SCHOLIUM.

Ubi quadrandæ sunt figuræ; ad Regulas hæc generales semper recurrere nimis molestum esset: præstat Figuras quæ simpliciores sunt & magis usui esse possunt semel quadrare & quadraturas in Tabulam referre, deinde Tabulam consulere quoties ejusmodi Curvam aliquam quadrare oportet. Hujus autem generis sunt Tabulæ duæ sequentes, in quibus z denotat Abscissam, y Ordinatam rectangulam

gulam & t Aream Curvæ quadrandæ, & d, e, f, g, g. h, " sunt quantitates datæ cum signis suis — & —.

T A B U L A

Curvarum simpliciorum quæ quadrari possunt.

Curvarum formæ. Curvarum ares.

Forma prima.

$$dz^{n-1} = y. \quad \frac{d}{n} z^n = t.$$

Forma secunda.

$$\frac{dz^{n-1}}{ce-2efz_n-ffz_2} = y. \quad \frac{dz_n}{nce-uefz_n} = t, \text{ vel } \frac{d}{uef-ufz_n} = t.$$

Forma tertia.

1. $dz_{-1}^n \sqrt{e-|fz^n} = y. \quad \frac{2d}{3nf} R^3 = t, \text{ existente } R = \sqrt{e-|fz^n}$
2. $dz_{-1}^{2n} \sqrt{e-|fz^n} = y. \quad \frac{-4e-6fz_n}{15nfi} dR^3 = t.$
3. $dz_{-1}^{3n} \sqrt{e-|fz^n} = y. \quad \frac{16ce-24efz_n-3offz_2n}{105nf_3} dR^3 = t.$
4. $dz_{-1}^{4n} \sqrt{e-|fz^n} = y. \quad \frac{-96e_3-144eefz_n-18oeffz_2n-21of_3z_3n}{945n^4} dR^3 = t.$

Forma quarta.

1. $\frac{dz^{n-1}}{\sqrt{e-|fz_n}} = y. \quad \frac{2d}{nf} R = t.$
2. $\frac{dz^{2n-1}}{\sqrt{e-|fz_n}} = y. \quad \frac{-4e-2fz_n}{3n^4i} dR = t.$

dz^{3n^3}

$$3. \frac{dz^{3n-1}}{\sqrt{e-1-fz^n}} = y.$$

$$\frac{16ee-8efz^n+6ffz^{2n}}{15nf^3} dR = t.$$

$$4. \frac{dz^{4n-1}}{\sqrt{e-1-fz^n}} = y.$$

$$\frac{-96e^3-48eefz^n-36effz^{2n}+3ofz^3z^n}{105nf^4} dR = t.$$

T A B U L A

Curvarum simpliciorum quæ cum Ellipsi & Hyperbola compari possunt.

Sit jam aGD vel PGD vel GDS Sectio Conica cujus area ad Quadraturam Curvæ propositæ requiritur, sitq; ejus centrum A, Axis Ka, Vertex a, Semiaxis conjugatus AP, datum Abscissæ principium A vel a vel α , Abscissa AB vel a B vel $\alpha B = x$, Ordinata rectangula BD = v, & Area ABDP vel aBDG vel $\alpha BDG = s$, existente αG Ordinata ad punctum α . Jungantur KD, AD, aD. Ducatur Tangens DT occurrens Abscissæ AB in T, & compleatur parallelogrammum ABDO. Et siquando ad quadraturam Curvæ propositæ requiruntur areæ duarum Sectionem Conicarum, dicatur posterioris Abscissa ξ , Ordinata γ , & Area σ . Sit autem \div differentia duarum quantitatum ubi incertum est utrum posterior de priori an prior de posteriori subduci debeat.

Curva-

Curvarum Formæ. Sectionis Conicæ. Curvarum Area.

Forma prima. } Abscissa. Ordinata.

Fig. 5.

1. $\frac{dz^{n-1}}{e+fx^n} = y.$ $Z^n = x.$ $\frac{d}{e+fx} = v.$ $\frac{1}{n} S = t = \frac{\alpha GDB}{n}$
2. $\frac{dz^{2n-1}}{e+fx^n} = y.$ $Z^n = x.$ $\frac{d}{e+fx} = v.$ $\frac{d}{n^2} Z^n = \frac{c}{n^2} S = t.$
3. $\frac{dz^{3n-1}}{e+fx^n} = y.$ $Z^n = x.$ $\frac{d}{e+fx} = v.$ $\frac{d}{2n^2} Z^{2n} = \frac{de}{n^2 f} Z^n + \frac{ee}{n^2 f^2} S = t.$

Forma secunda.

Fig. 6, 7.

1. $\frac{dz^{\frac{1}{2}n-1}}{e+fx^n} = y.$ $\sqrt{\frac{d}{e+fx^n}} = x.$ $\sqrt{\frac{d}{f} - \frac{c}{f} XX} = v.$ $\frac{2xv^{\frac{1}{2}n-4S}}{n} = t = \frac{4}{n} ADGa.$
2. $\frac{dz^{\frac{1}{2}n-1}}{e+fx^n} = y.$ $\sqrt{\frac{d}{e+fx^n}} = x.$ $\sqrt{\frac{d}{f} - \frac{c}{f} XX} = v.$ $\frac{2de}{n^2 f} Z^{\frac{n}{2}} + \frac{4es-2exv}{n^2 f} = t.$
3. $\frac{dz^{\frac{1}{2}n-1}}{e+fx^n} = y.$ $\sqrt{\frac{d}{e+fx^n}} = x.$ $\sqrt{\frac{d}{f} - \frac{c}{f} XX} = v.$ $\frac{2de}{3n^2 f} Z^{\frac{n}{2}} - \frac{2dec}{n^2 f} Z^{\frac{n}{2}} + \frac{2eexv-4ees}{n^2 f} = t.$

Forma tertia.

Fig. 6, 7, 8. 1. $\frac{1}{z_n} \sqrt{c+tz_n} = y. \frac{1}{z_n} = xx. \sqrt{f+cxx} = v. \frac{4de}{n^2} \text{ in } \frac{V_3}{2ex} - s = t = \frac{4de}{n^2} \text{ in aGDT, vel in APDB} \div \text{TDB.}$
 Vel fic, $\frac{1}{z_n} = x. \sqrt{fx+cxx} = v. \frac{8dec}{n^2} \text{ in } s - \frac{1}{2}xv - \frac{fv}{4e} + \frac{fv}{4cex} = t = \frac{8dec}{n^2} \text{ in aGDA} + \frac{fv}{4cex}.$

2. $\frac{d}{z_{+1}^n} \sqrt{c+tz_n} = y. \frac{1}{z_n} = xx. \sqrt{f+cxx} = v. \frac{-2d}{n} s = t = \frac{2d}{n} \text{ APDB, seu } \frac{2d}{n} \text{ aGDB.}$

Vel fic, $\frac{1}{z_n} = x. \sqrt{fx+cxx} = v. \frac{4de}{n^2} \text{ in } s - \frac{1}{2}xv - \frac{fv}{2e} = t = \frac{4de}{n^2} \times \text{aGDK.}$

3. $\frac{d}{z_{+1}^{2n}} \sqrt{e+tz_n} = y. \frac{1}{z_n} = x. \sqrt{fx+cxx} = v. \frac{d}{n} s = t = \frac{d}{n} \times \text{aGDB vel BDPK.}$

4. $\frac{d}{z_{+1}^{3n}} \sqrt{e+tz_n} = y. \frac{1}{z_n} = x. \sqrt{fx+cxx} = v. \frac{3dfs-2dv_3}{6ne} = t.$

[201]

Forma quarta.

Fig. 6. 1. $\frac{d}{z_{+1}^n \sqrt{e+tz_n}} = y. \frac{1}{z_n} = xx. \sqrt{f+cxx} = v. \frac{4d}{n^2} \text{ in } \frac{1}{2}xv \div s = t = \frac{4d}{n^2} \text{ in PAD vel in aGDA.}$

Vel fic, $\frac{1}{z_n} = x. \sqrt{fx+cxx} = v. \frac{8dec}{n^2} \text{ in } s - \frac{1}{2}xv - \frac{fv}{4e} = t = \frac{8dec}{n^2} \text{ in aGDA.}$

2. $\frac{d}{z_{+1}^n \sqrt{e+tz_n}} = y. \frac{1}{z_n} = xx. \sqrt{f+cxx} = v. \frac{2d}{ne} \text{ in } s - xv = t = \frac{2d}{ne} \text{ in POD, vel in AODGa.}$

Vel fic, $\frac{1}{z_n} = x. \sqrt{fx+cxx} = v. \frac{4d}{n^2} \text{ in } \frac{1}{2}xv \div s = t = \frac{4d}{n^2} \text{ in aDGA.}$

D d d

$$3. \frac{d}{Z_{-1}^{2n} \sqrt{e - fz_n}} = Y \cdot \frac{1}{z_n} = X \cdot \sqrt{fx - exx} = V \cdot \frac{d}{\eta c} \text{ in } 3s \div 2XV = t = \frac{d}{\eta c} \text{ in } 3aDGa \div \Delta uDB.$$

$$4. \frac{d}{Z_{-1}^{3n} \sqrt{e - fz_n}} = Y \cdot \frac{1}{z_n} = X \cdot \sqrt{fx - exx} = V \cdot \frac{10dfxv - 15dfx - 2dexxv}{6\eta cc} = t.$$

Forma quinta.

$$1. \frac{dz_{2n-1}}{e - fz_n + gz_{2n}} = Y \cdot \sqrt{\frac{d}{e - fz_n + gz_{2n}}} = X \cdot \sqrt{\frac{d}{g} + \frac{ff - 4eg}{4gg}} \cdot XX = V \cdot \frac{XV - 2S}{\eta} = t.$$

Vel sic, $\sqrt{\frac{dz_{2n}}{e - fz_n + gz_{2n}}} = X \cdot \sqrt{\frac{d}{e} + \frac{ff - 4eg}{4cc}} \cdot XX = V \cdot \frac{2S - XV}{\eta} = t.$

$$2. \frac{dz_{2n-1}}{e - fz_n + gz_{2n}} = Y \cdot \left\{ \sqrt{\frac{d}{e - fz_n + gz_{2n}}} = X \cdot \sqrt{\frac{d}{g} + \frac{ff - 4eg}{4gg}} \cdot XX = V \cdot \right\} \frac{d\sigma - 2fs - fxv}{2\eta g} = t.$$

$$\frac{1}{e + \xi} = \gamma.$$

Forma sexta, ubi scribitur p pro $\sqrt{ff - 4eg}$.

$$1. \frac{dz_{2n-1}}{e - fz_n + gz_{2n}} = Y \cdot \left\{ \sqrt{\frac{2dg}{f - p + 2gz_n}} = X \cdot \sqrt{\frac{d}{f - p} + \frac{-f - p}{2g}} \cdot XX = V \cdot \right\} \frac{2XV - 4S - 2\xi\gamma - 4\sigma}{\eta p} = t.$$

$$\left\{ \sqrt{\frac{2dg}{f - p + 2gz_n}} = \xi \cdot \sqrt{\frac{d}{f - p} + \frac{-f - p}{2g}} = \gamma \cdot \right\}$$

$$2. \frac{dz_{2n-1}}{e - fz_n + gz_{2n}} = Y \cdot \left\{ \sqrt{\frac{2dezn}{fz_n - pz_n + 2c}} = X \cdot \sqrt{\frac{d}{fz_n - pz_n} + \frac{-f - p}{2c}} \cdot XX = V \cdot \right\} \frac{4S - 2XV - 4\sigma - 2\xi\gamma}{\eta p} = t.$$

$$\left\{ \sqrt{\frac{2dezn}{fz_n - pz_n + 2c}} = \xi \cdot \sqrt{\frac{d}{fz_n - pz_n} + \frac{-f - p}{2c}} = \gamma \cdot \right\}$$

Forma septima.

$$1. \frac{d}{z} \sqrt{e - fz^n + gz^{2n}} = y. \left\{ \begin{array}{l} Z^n = x. \sqrt{e - fx + gxx} = v. \\ Z^{2n} = z. \sqrt{g + fz + cz^2} = \gamma. \end{array} \right. \frac{41deez\gamma + 2def\gamma - 2dfv - 3deco - 4dfgs}{41eeg - 11ff} = t.$$

Fig. 6, 7. 2. $dz^n \sqrt{e - fz^n + gz^{2n}} = y. z^n = x. \sqrt{e - fx + gxx} = v. \frac{d}{n} s = t = \frac{d}{n}$ in $^e GDB.$

3. $dz^{2n} \sqrt{e - fz^n + gz^{2n}} = y. z^n = x. \sqrt{e - fx + gxx} = v. \frac{d}{3ng} v^3 - \frac{df}{2ng} s = t.$

4. $dz^{3n} \sqrt{e - fz^n + gz^{2n}} = y. z^n = x. \sqrt{e - fx + gxx} = v. \frac{6dgn - 5df}{24ngs} v^3 - \frac{5df - 4deg}{15ngs} s = t.$

Forma octava.

[20]

Fig. 6 1. $\frac{dz^{n-1}}{\sqrt{e - fz^n + gz^{2n}}} = y. z^n = x. \sqrt{e - fx + gxx} = v. \frac{8dgs - 4dgsxv - 2dfv}{41eeg - 11ff} = t = \frac{8dg}{41eeg - 11ff}$ in $^e GDB \perp \Delta DBA.$

2. $\frac{dz^{2n-1}}{\sqrt{e - fz^n + gz^{2n}}} = y. z^n = x. \sqrt{e - fx + gxx} = v. \frac{4dfs - 2dfxv - 4dev}{41eeg - 11ff} = t.$

3. $\frac{dz^{3n-1}}{\sqrt{e - fz^n + gz^{2n}}} = y. z^n = x. \sqrt{e - fx + gxx} = v. \frac{3difs - 2difs - 2defv}{-4deg - 4deg - 41eeg - 11ff} = t.$

4. $\frac{dz^{4n-1}}{\sqrt{e - fz^n + gz^{2n}}} = y. z^n = x. \sqrt{e - fx + gxx} = v. \frac{30degs - 4ddeg - 28degs - 10deev - 16deev}{-15deffs - 2dfg - 10deff - 16deev - 24eeg} = t.$

Forma nona.

$$1. \frac{dz^n \sqrt{e-fz^n}}{g-hz^n} = y. \sqrt{\frac{d}{g-hz^n}} = x. \sqrt{\frac{df}{h} + \frac{eh-fg}{h} XX} = V. \frac{4fg S - 2fg XV - \frac{2dfv}{x}}{4eh S - 2eh XV - \frac{2dfv}{x}} = t.$$

$$2. \frac{dz^{2n} \sqrt{e-fz^n}}{g-hz^n} = y. \sqrt{\frac{d}{g-hz^n}} = x. \sqrt{\frac{df}{h} + \frac{eh-fg}{h} XX} = V. \frac{4cgh - 2cgh}{4fgg S - 2fgg XV - \frac{2dh^3}{x^3}} = 2 \frac{dfg}{gh} = t.$$

Forma decima.

Fig. 6,7.

$$1. \frac{dz^{n-1}}{g-hz^n \sqrt{e-fz^n}} = y. \sqrt{\frac{d}{g-hz^n}} = x. \sqrt{\frac{df}{h} + \frac{eh-fg}{h} XX} = V. \frac{2XV-4S}{nf} = t = \frac{4}{nf} ADGa.$$

$$2. \frac{dz^{2n-1}}{g-hz^n \sqrt{e-fz^n}} = y. \sqrt{\frac{d}{g-hz^n}} = x. \sqrt{\frac{df}{h} + \frac{eh-fg}{h} XX} = V. \frac{4gs-2gxv + \frac{2dv}{x}}{nfh} = t.$$

Forma undecima.

$$1. dz^{-1} \sqrt{\frac{e-fz^n}{g-hz^n}} = y. \left\{ \sqrt{g-hz^n} = x. \sqrt{\frac{eh-fg}{h} + \frac{f}{h} XX} = V. \right. \\ \left. \sqrt{h-gz^n} = z. \sqrt{\frac{fg-eh}{g} + \frac{e}{g^2} XX} = r. \right\} \frac{dxv^3 z^n - 4dfs - 4der}{nfg - neh} = t.$$

$$2. dz^{-1} \sqrt{\frac{e-fz^n}{g-hz^n}} = y. \sqrt{g-hz^n} = x. \sqrt{\frac{eh-fg}{h} + \frac{f}{h} XX} = V. \frac{2d}{nh} S = t.$$

$$3. dz^{2n-1} \sqrt{\frac{e-fz^n}{g-hz^n}} = y. \sqrt{g-hz^n} = x. \sqrt{\frac{eh-fg}{h} + \frac{f}{h} XX} = V. \frac{dhxv^3 - 3dfg S}{2nfh} = t.$$

In Tabulis hifce, ferics Curvarum cujusq; formæ utrinq; in infinitum continuari potest. Scilicet in Tabula prima, in numeratoribus arearum formæ tertix & quartæ, numeri coefficientes initialium terminorum (2, -4, 16, -96, 868, &c.) generantur multiplicando numeros -2, -4, -6, -10, &c. in se continuo, & subsequenrium terminorum coefficientes ex initialibus derivantur multiplicando ipsos gradatim, in Forma quidem tertia, per $-\frac{3}{2}$, $-\frac{5}{4}$, $-\frac{7}{6}$, $-\frac{9}{8}$, $-\frac{11}{10}$ &c. in quarta vero per $-\frac{1}{2}$, $-\frac{3}{4}$, $-\frac{5}{6}$, $-\frac{7}{8}$, $-\frac{9}{10}$, &c. Et Denominatorum coefficientes 3, 15, 105, &c. prodeunt multiplicando numeros 1, 3, 5, 7, 9, &c. in se continuo.

In secunda vero Tabula, ferics Curvarum formæ primæ, secundæ, quintæ, sextæ, nonæ & decimæ ope folius divisionis, & formæ reliquæ ope Propositionis tertix & quartæ, utrinq; producentur in infinitum.

Quinetiam hæ ferics mutando signum numeri, variari solent. Sic enim, e. g. Curva $\frac{d}{z} \sqrt{e - fz^n} = y$, evadit $\frac{d}{z^{2n-1}} \sqrt{f + ez^n}$.

PROP. IX. THEOR. VIII.

Sit ADIC Curva quævis Abscissam habens *Fig. 9.*
 $AB=z$ & Ordinatum $BD=y$, & sit AEKC Curva
 alia cujus Ordinata BE æqualis est prioris areæ
 ABC

A D B ad unitatem applicatæ, & A F L C Curva tertia cujus Ordinata B F æqualis est secundæ areæ A E B ad unitatem applicatæ, & A G M C Curva quarta cujus Ordinata B G æqualis est tertiæ areæ A F B ad unitatem applicatæ, & A H N C Curva quinta cujus Ordinata B H æqualis est quartæ areæ A G B ad unitatem applicatæ, & sic deinceps in infinitum. Et funto A, B, C, D, E, &c. Areæ Curvarum Ordinatæ habentium $y, zy, z^2y, z^3y, z^4y,$ & Abfciffam communem z .

Detur Abfciffa quævis $AC=t$, fitq; $BC=t-z = x$, & funto P, Q, R, S, T areæ Curvarum Ordinatæ habentium x, xy, xxy, x^3y, x^4y & Abfciffam communem x .

Terminenter autem hæ areæ omnes ad Abfciffam totam datam AC, nec non ad Ordinatam positione datam & infinite productam CI: & erit arearum sub initio positarum prima $ADIC=A=P$, fecunda $AEKC=tA-B=Q$. Tertia $AFLC = \frac{ttA-2tB+C}{2} = \frac{1}{2}R$. Quarta $AGMC = \frac{tA-3ttB+3tC-D}{6} = \frac{1}{6}S$. Quinta $AHNC = \frac{tA-4tB+6ttC-4tD+E}{24} = \frac{1}{24}T$.

C O R O L.

Unde si Curvæ quarum Ordinatæ sunt y , zy , z^2y , z^3y , &c. vel y , xy , x^2y , x^3y , &c. quadrari possunt, quadrabuntur etiam Curvæ ADIC, AEKC, AFLC, AGMC, &c. & habebuntur Ordinatæ BE, BF, BG, BH areis Curvarum proportionales.

S C H O L I U M.

Quantitatum fluentium fluxiones esse primas, secundas, tertias, quartas, aliasq; diximus supra. Hæ fluxiones sunt ut termini serierum infinitarum convergentium. Ut si z^n sit quantitas fluens & fluendo evadat $z + o^n$, deinde resolvatur in seriem convergentem $z^n + n o z^{n-1} + \frac{n(n-1)}{2} o o z^{n-2} + \frac{n^3 - 3nn + 2n}{6} o^3 z^{n-3} + \dots$ terminus primus hujus seriei z^n erit quantitas illa fluens, secundus $n o z^{n-1}$ erit ejus incrementum primum seu differentia prima cui nascenti proportionalis est ejus fluxio prima, tertius $\frac{n(n-1)}{2} o z^{n-2}$ erit ejus incrementum secundum seu differentia secunda cui nascenti proportionalis est ejus fluxio secunda, quartus $\frac{n^3 - 3nn + 2n}{6} o^3 z^{n-3}$ erit ejus incrementum tertium seu differentia tertia cui nascenti fluxio tertia proportionalis est, & sic deinceps in infinitum.

[Exponi

Exponi autem possunt hæ fluxiones per Curvarum Ordinatas BD , BE , BF , BG , BH , &c. Ut si Ordinata BE ($=\frac{ADB}{1}$) sit quantitas fluens, erit ejus fluxio prima ut ordinata BD . Si BF ($=\frac{AEB}{1}$) sit quantitas fluens, erit ejus fluxio prima ut Ordinata BE & fluxio secunda ut Ordinata BD . Si BH ($=\frac{AGB}{1}$) sit quantitas fluens, erunt ejus fluxiones, prima, secunda, tertia & quarta, ut Ordinata BG , BF , BE , BD respective.

Et hinc in æquationibus quæ quantitates tantum duas incognitas involvunt, quarum una est quantitas uniformiter fluens & altera est fluxio quælibet quantitatis alterius fluentis, inveniri potest fluens illa altera per quadraturam Curvarum. Exponatur enim fluxio ejus per Ordinatam BD , & si hæc sit fluxio prima, quærat^rur area $ADB = BE \times 1$, si fluxio secunda, quærat^rur area $AEB = BF \times 1$, si fluxio tertia, quærat^rur area $AFB = BG \times 1$, &c. & area inventa erit exponens fluentis quæsitæ.

Sed & in æquationibus quæ fluentem & ejus fluxionem primam sine altera fluente, vel duas ejusdem fluentis fluxiones, primam & secundam, vel secundam & tertiam, vel tertiam & quartam, &c. sine alterutra fluente involvunt: inveniri possunt fluentes per quadraturam Curvarum. Sit æquatio $av\dot{v} = av + vv$, existente $v = BE$, $\dot{v} = BD$, $z = AB$ & $z = 1$, & æquatio illa complendo dimensiones fluxionum, evadet $av\dot{v} = avz + vv\dot{z}$, seu $\frac{av\dot{v}}{av + vv} = \dot{z}$. Jam fluat v uniformiter & sit

fit ejus fluxio $\dot{v}=1$ & erit $\frac{aa}{av+vv}=\dot{z}$, & quadrando Curvam cujus Ordinata est $\frac{aa}{av+vv}$ & Abfciffa v , habebitur fluens z . Adhæc fit æquatio $aa\dot{v}=a\dot{v}+\dot{v}v$ existente $v=BF$, $\dot{v}=BE$, $\ddot{v}=BD$ & $z=AB$ & per relationem inter \ddot{v} & \dot{v} feu BD & BE invenietur relatio inter AB & BE ut in exemplo superiore. Deinde per hanc relationem invenietur relatio inter AB & BF quadrando Curvam AEB .

Æquationes quæ tres incognitas quantitates involvunt aliquando reduci possunt ad æquationes quæ duas tantum involvunt, & in his casibus fluentes invenientur ex fluxionibus ut supra. Sit æquatio $a-bx^m=cxy\dot{y}+d\dot{y}^{2n}\dot{y}\dot{y}$. Ponatur $y\dot{y}=\dot{v}$ & erit $a-bx^m\dot{v}+d\dot{v}^2$. Hæc æquatio quadrando Curvam cujus Abfciffa est x & Ordinata \dot{v} dat aream v , & æquatio altera $y\dot{y}=\dot{v}$ regrediendo ad fluentes dat $\frac{1}{n+1}y^{n+1}=v$. Unde habetur fluens y .

Quinetiam in æquationibus quæ tres incognitas involvunt & ad æquationes quæ duas tantum involvunt reduci non possunt, fluentes quandoque prodeunt per quadraturam Curvarum. Sit æquatio $a x^m + b x^n \dot{y}^p = r e x^{r-1} y^s + s e x^r \dot{y} y^{s-1} - f \dot{y} y^t$, existente $\dot{x} = 1$. Et pars posterior $r e x^{r-1} y^s + s e x^r \dot{y} y^{s-1} - f \dot{y} y^t$, regrediendo ad fluentes, fit $e x^r y^s - \frac{f}{t+1} y^{t+1}$, quæ proinde est ut area Curvæ cujus Abfciffa est x & Ordinata $a x^m + b x^n \dot{y}^p$, & inde datur fluens y .

Sit æquatio $\dot{x} \times \sqrt{ax^m + bx^n}^p = \frac{dy y^{n-1}}{\sqrt{e+fy^n}}$. Et fluens
 cujus fluxio est $\dot{x} \times \sqrt{ax^m + bx^n}^p$ erit ut area Curvæ
 cujus Abfciffa est x & Ordinata est $\sqrt{ax^m + bx^n}^p$.
 Item fluens cujus fluxio est $\frac{dy y^{n-1}}{\sqrt{e+fy^n}}$ erit ut area Curvæ
 cujus Abfciffa est y & Ordinata $\frac{dy y^{n-1}}{\sqrt{e+fy^n}}$, id est
 (per Cafum 1. Formæ quartæ Tab. I.) ut area
 $\frac{2d}{nf} \sqrt{e+fy^n}$. Pone ergo $\frac{2d}{nf} \sqrt{e+fy^n}$ æqualem areæ
 Curvæ cujus Abfciffa est x & Ordinata $\sqrt{ax^m + bx^n}^p$
 & habebitur fluens y .

Et nota quod fluens omnis quæ ex fluxione prima colligitur augeri potest vel minui quantitate quavis non fluente. Quæ ex fluxione fecunda colligitur augeri potest vel minui quantitate quavis cujus fluxio fecunda nulla est. Quæ ex fluxione tertia colligitur augeri potest vel minui quantitate quavis cujus fluxio tertia nulla est. Et sic deinceps in infinitum.

Postquam vero fluentes ex fluxionibus collectæ sunt, si de veritate Conclusionis dubitatur, fluxiones fluentium inventarum viciffim colligendæ sunt & cum fluxionibus sub initio propositis comparandæ. Nam si prodeunt æquales Conclusio recte se habet:

bet : *ſin minus*, corrigendæ ſunt fluentes ſic, ut earum fluxiones fluxionibus ſub initio propoſitis æquentur. Nam & *Fluens* pro lubitu aſſumi poteſt & aſſumptio corrigi ponendo fluxionem fluentis aſſumptæ æqualem fluxioni propoſitæ, & terminos homologos inter ſe comparando.

Et his principiis via ad majora ſternitur.

F I N I S.

ERRATA.

BOOK I. Of Opticks.

PART I. p.3. l.20. *Properties which*, ib.p.5. l.5. and that C, p.6. l.9. DE, p.21. l.23. are two Rays, p.27. l.6. in the Margin put Fig.14 & 15, p.30.l.7. MN, l.9. M, p.44. l.15. as was proposed, p.52. l. 17. a paper Circle, p.57. l.ult. emerging, p.60. l.25. contain with the, p.64. l.18. and 14th, p.65. l.13. at the, p.66. l.3.Semicircular, p.67. l.25. Center, l.31. $4\frac{1}{8}$ Inches, p.68. l.8. to 16, l.9. or $5\frac{1}{2}$, p.71.l.1. bisect, p.72.l.13. falls, l.20. being. Part II. p.86.l.5. lelopipele, p.89. l.9. made by, p.93. l.18. to $77\frac{1}{3}$, l.28,29, by the third Axiom of the first Part of this Book, the Lams, p.105. l.5. see represented, p.144.l. 24, $\frac{1}{9}$, $\frac{1}{6}$, $\frac{1}{5}$, $\frac{1}{9}$, $\frac{1}{5}$, $\frac{1}{6}$, $\frac{1}{9}$. p. 118, 119. for Lib.1. Lib.2. write Part 1. Part 2. p.122. l.9. indico, p. 130. l.19. to the Angle, p.132. l.6. by the brightnes, p.135. l.14. For if in the, l.16. first Part you, p.136. l.26. first Part, l.27. lights, p.137. l.20. green, accordingly as, p. 138. l. 21. Prop.6. Part.2. p.139. l.5. on which, p.142.l.17. *XX* which have been, p.143. l.7. purple, l.16. several Lights, l.24. of white.

BOOK. II.

P.5. l. 5. nicely the, p. 7. l.9. y , z denote, l.28. them divers, p.10. l. 24. 1000 to 1024, p.11. l.11. *oliquities, I.* p.17. l.4. $14\frac{1}{2}$ to 9, p. 25. l. 11. $10\frac{1}{2}$, p.31. l. 12. more compounded, p.55. l.3. sizes reflect, l.24. and therefore their Colours arise, p.65. l.5. corpuscles can, p.71. l.17. given breadth, p.84.l. 4. are to those, p. 96. l. 24. Observation of this Part of this Book, p.103. l.17. was to the thickness, p. 105. l. 19. of this white Ring, p.107. l.20. become equal to the third of those.

Enumeratio Linearum.

p.143. l.20. *datas signis suis*, p. 144. l.27. *respiciunt*, p. 146. l.5. *sunt Asymptoto*, p. 154. l.13. *ex + d dat Ordinatam =*, l.14. *qua generatur.*

Quadratura Curvarum.

p.158.l.24. *recta AB*, p.176.l.ult. $\frac{\theta}{\lambda n} \int Z^n$, p.183.l.13. *a, b, c, &c. e, f, g, &c. k, l, m, &c.* p. 185. l.4. in $Z^{\theta-1}$, p.188. l.14. $Z^{\theta} \pm n\sigma$, p. 190. l. 19. vel $\frac{1}{x^{\theta-1} + 2n}$. p. 192. l. 18. $gz^{\theta} + 2n$. p.193. l.11. $\overline{aSu} + bR\tau^a$.

11/11/11

Quadr: Tab. I.

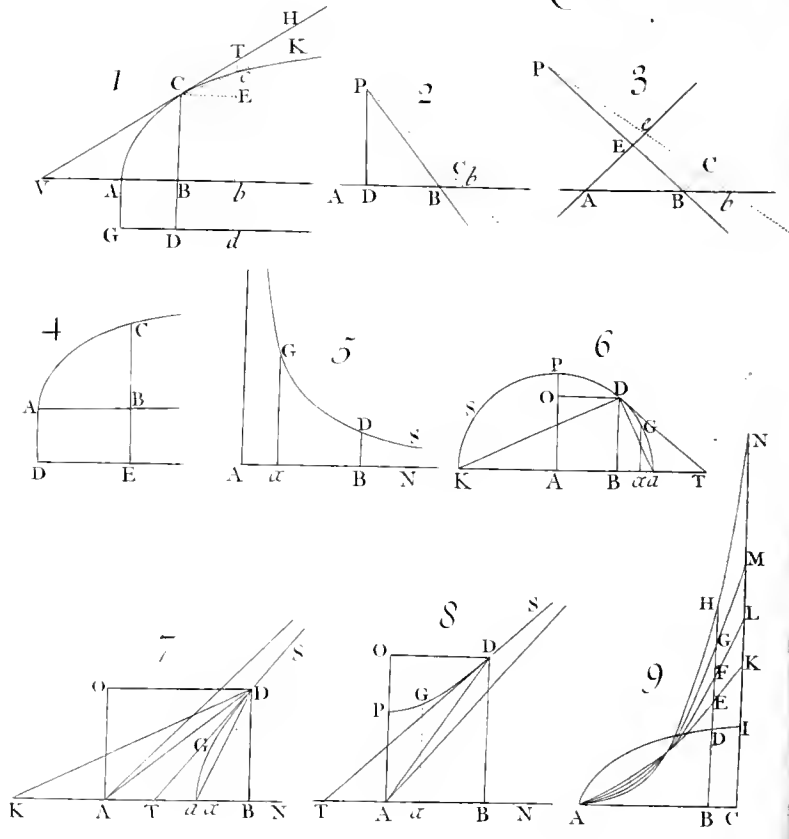

C

E

Fig 1.

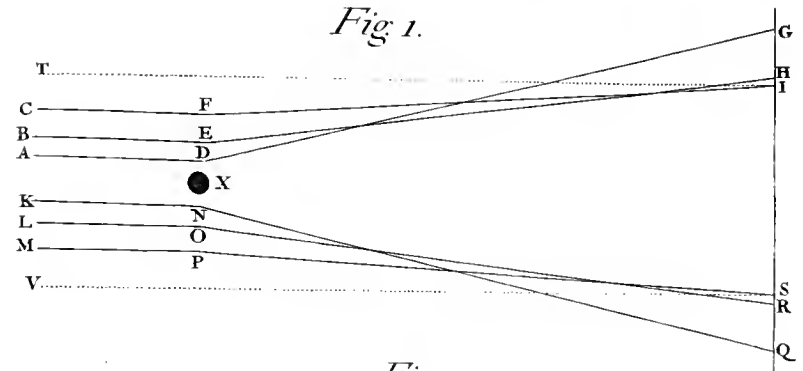

Fig 2.

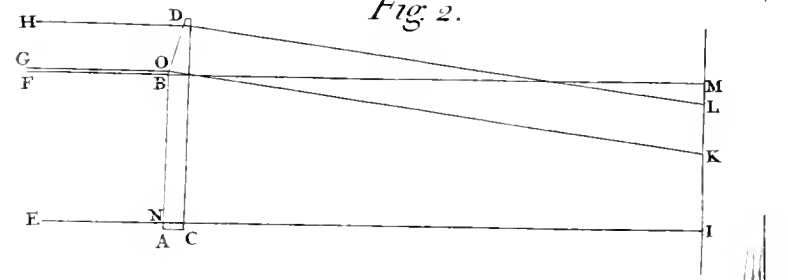
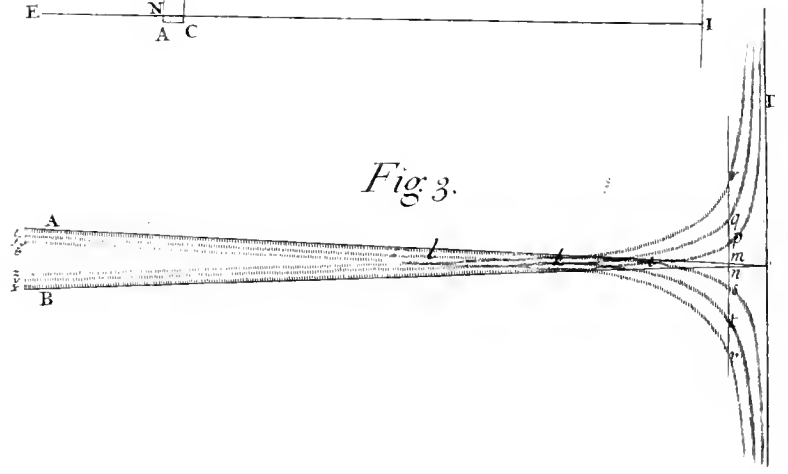
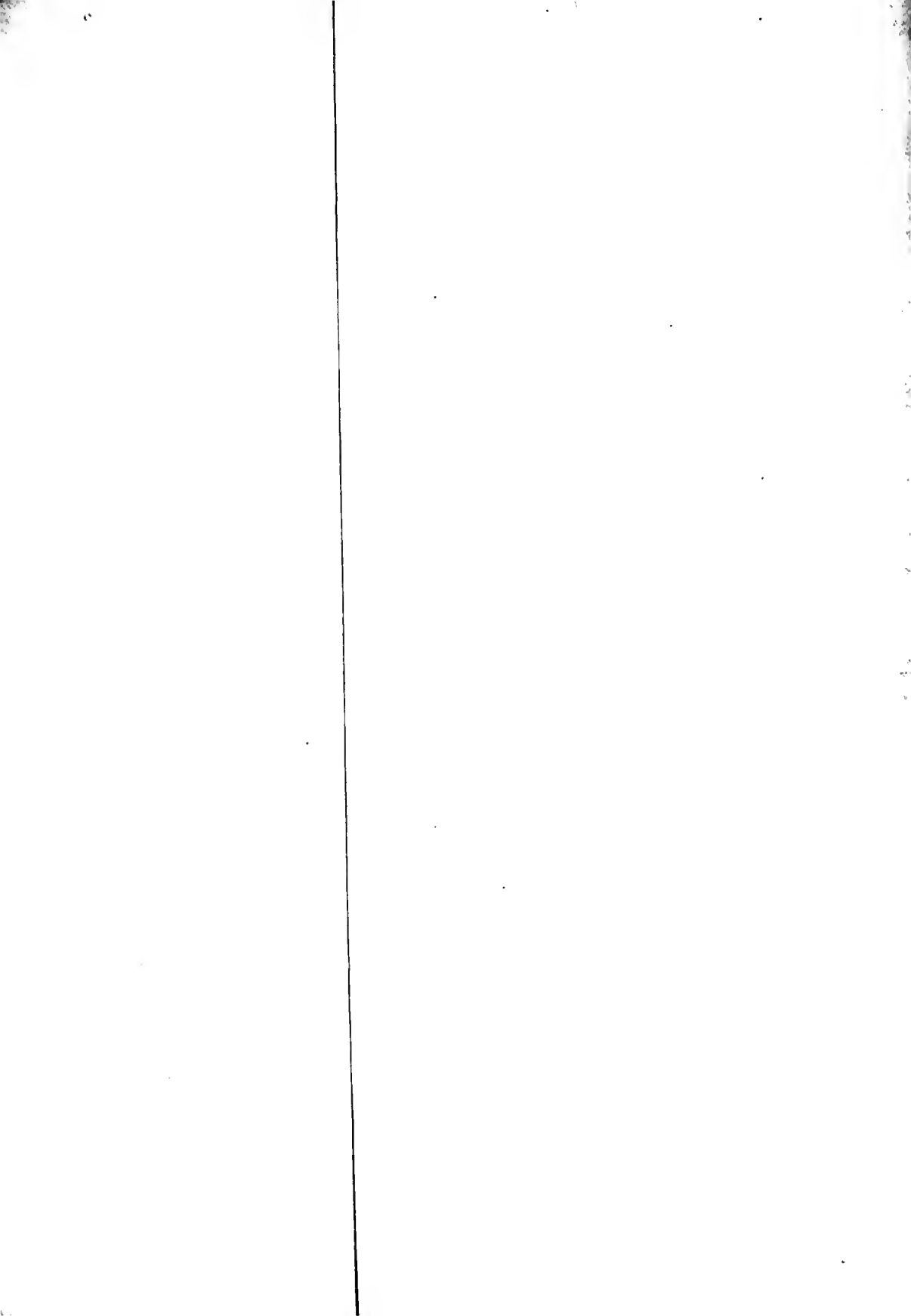
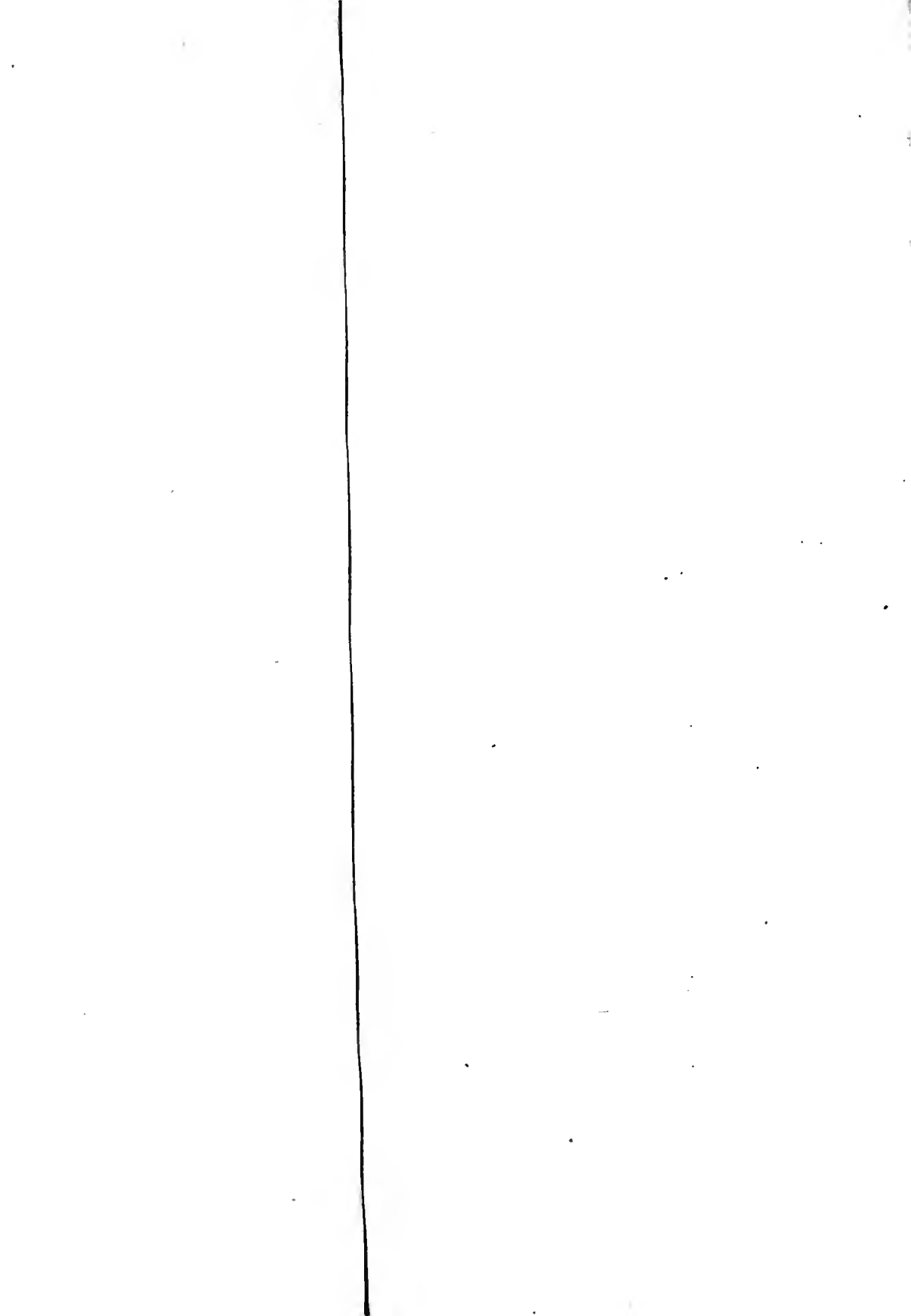

Fig 3.











Curvarum Tab.V.

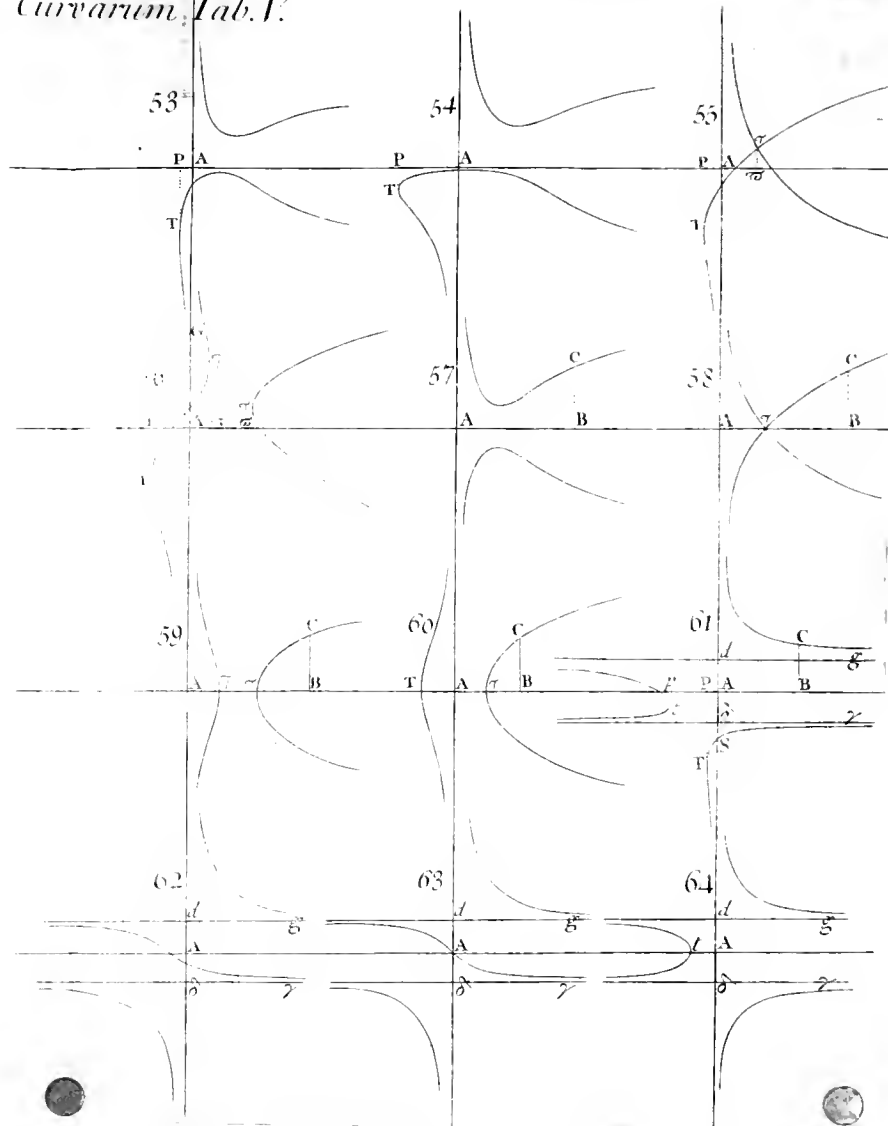



Curvarum Tab. VI.

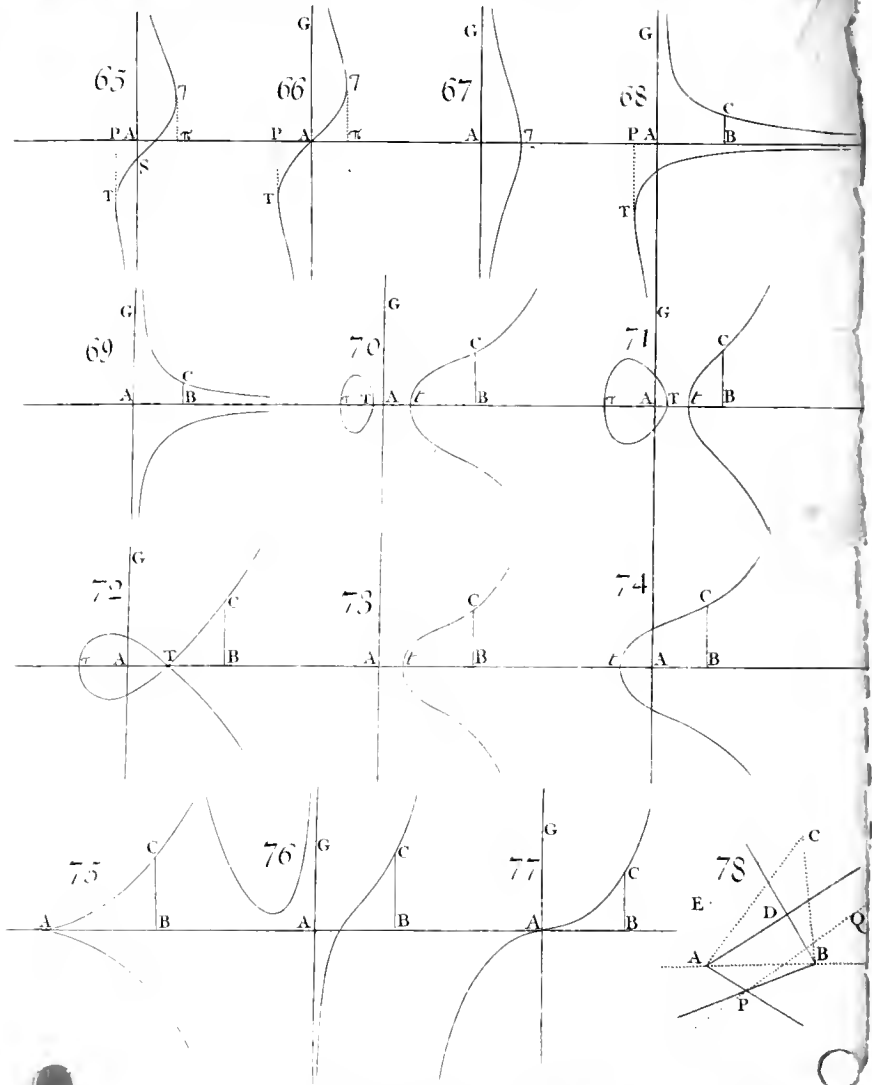

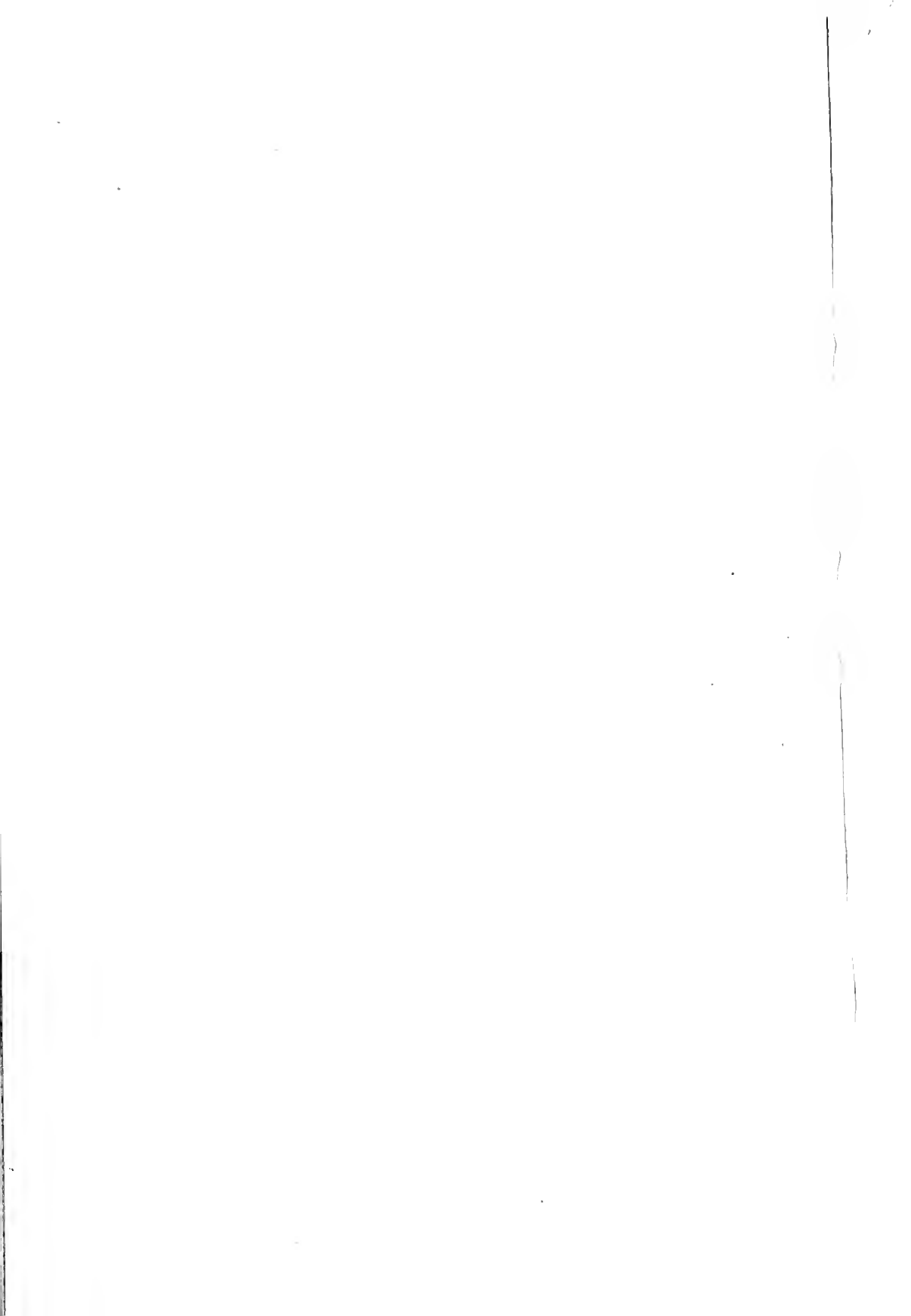

Curvarum Tab. IV.

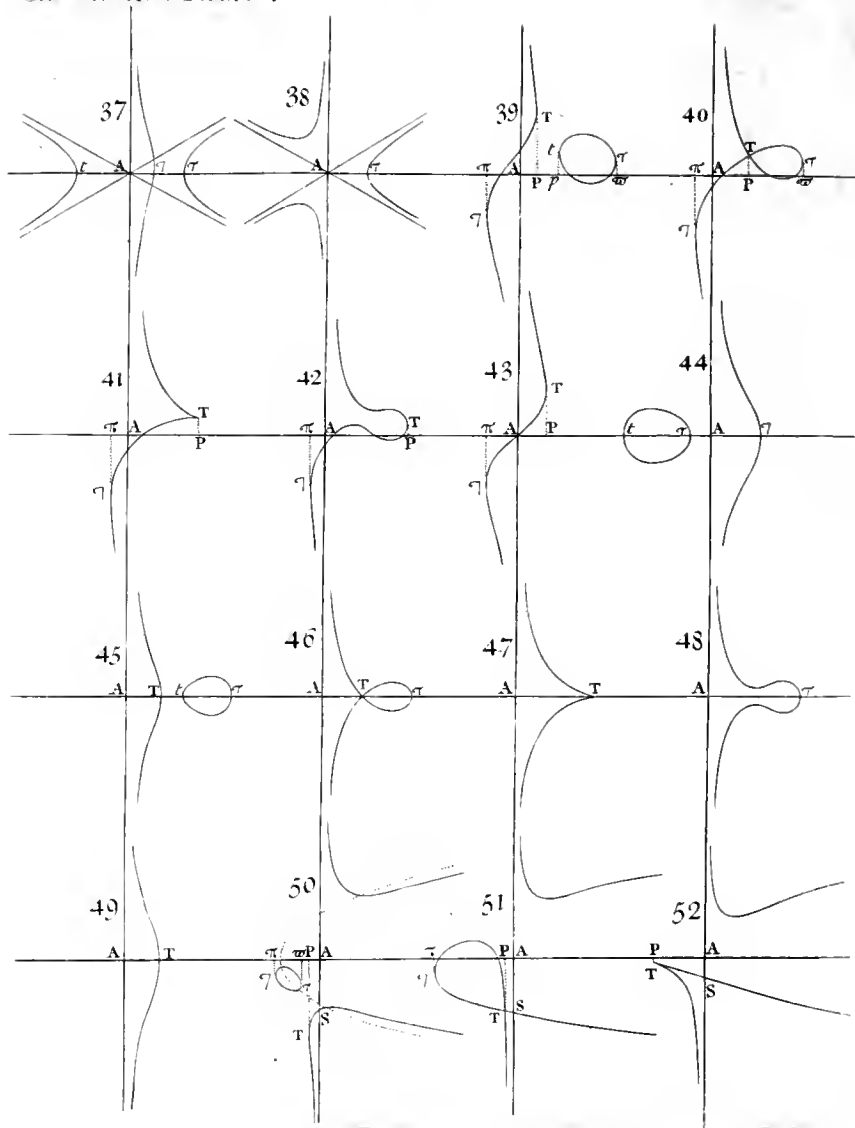



Curvarum Tab. II.

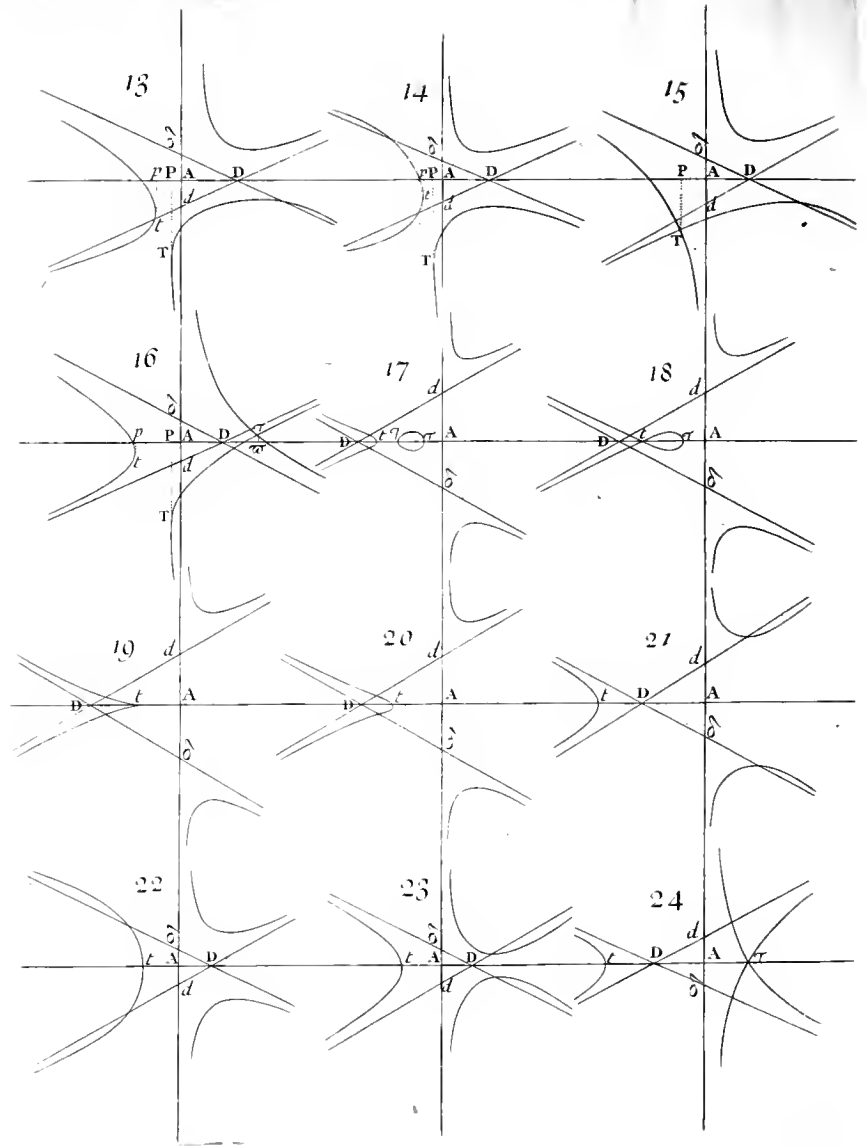

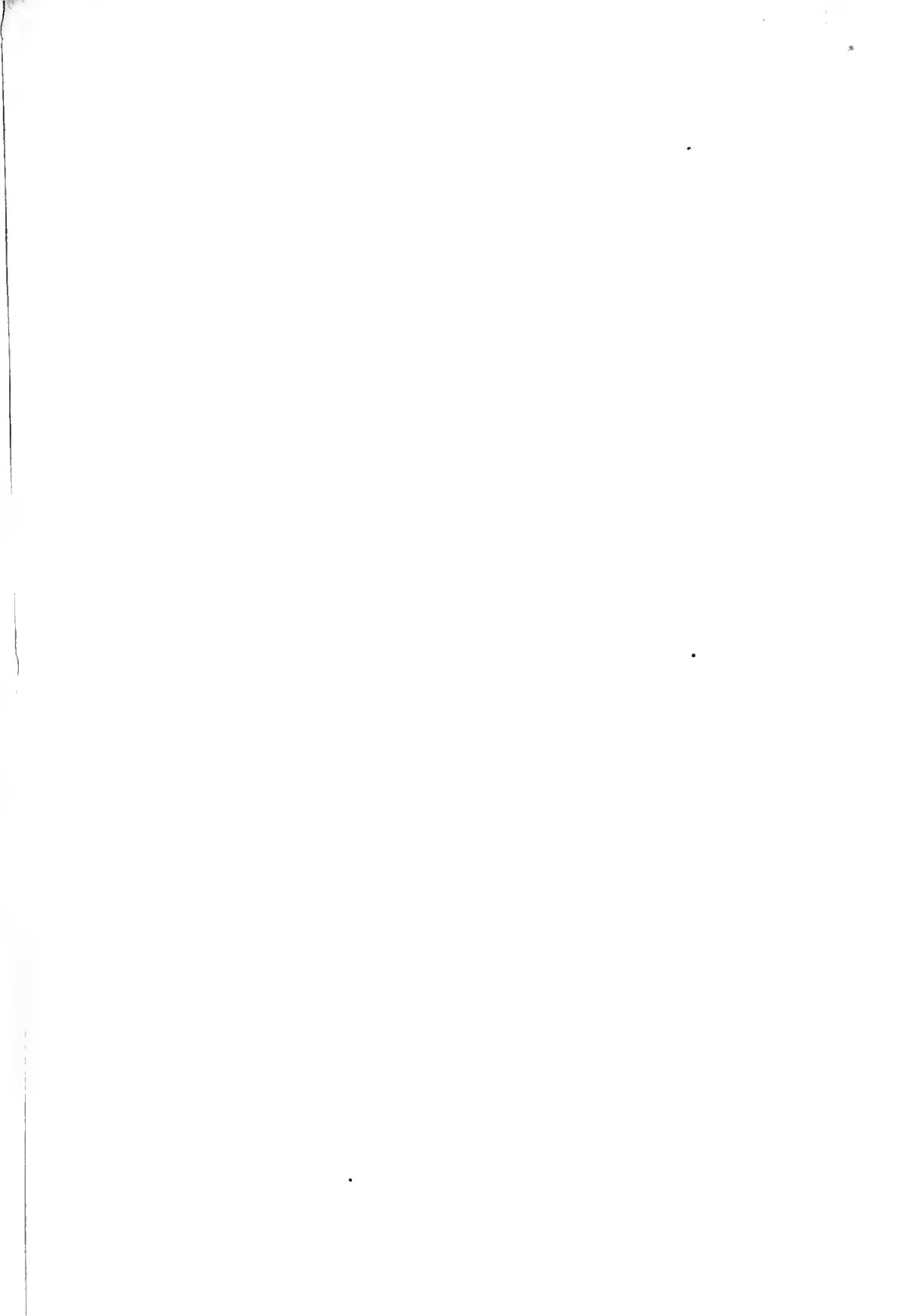

Curvarum Tab. I.

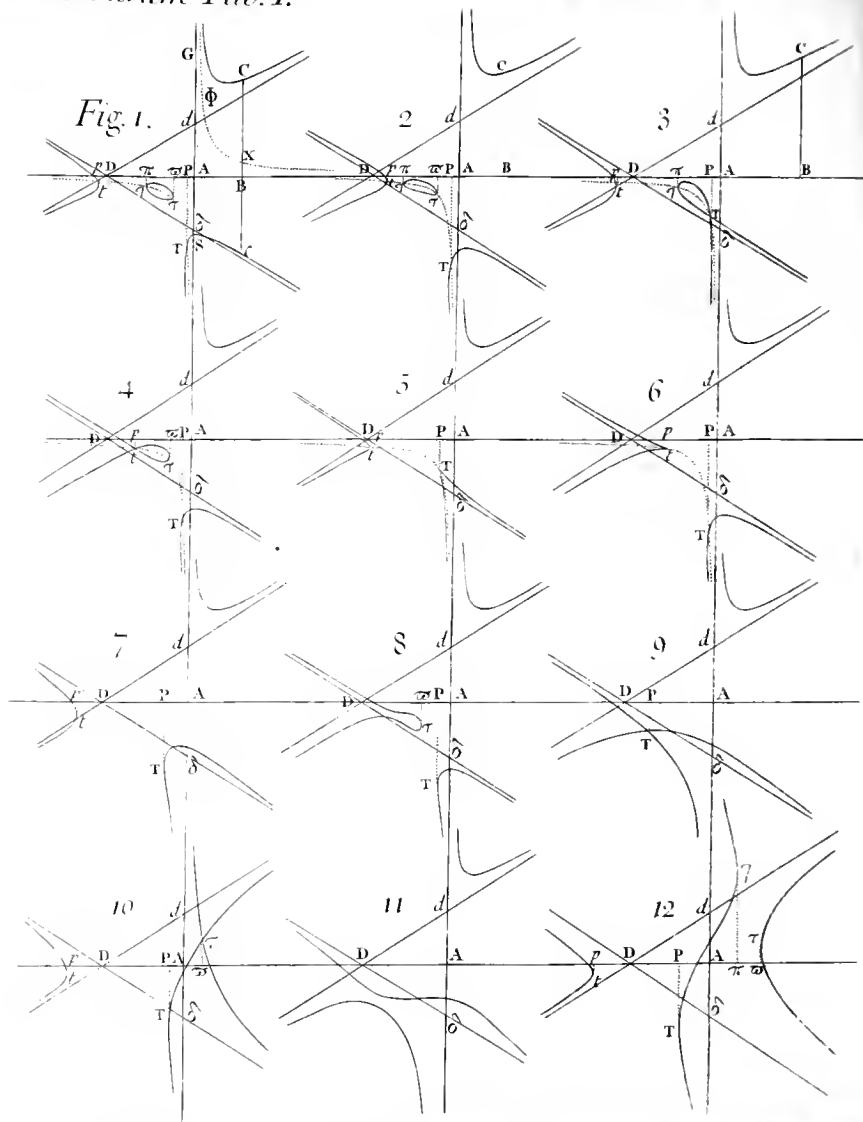

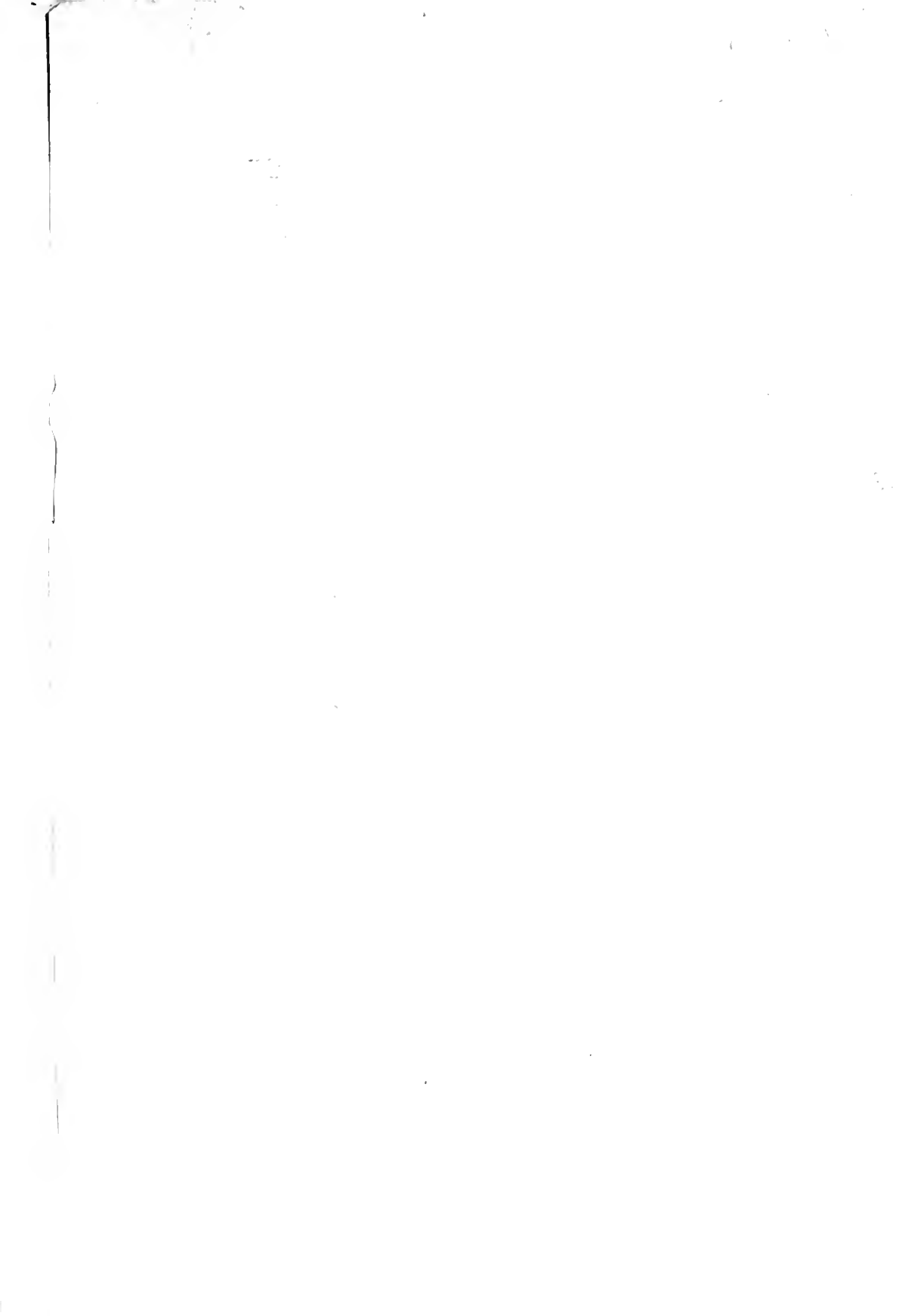

Collated by Bernard Quinn

ANN

