

MARINE BIOLOGICAL LABORATORY.

Received 15 Nov '35

Accession No. 45330

Given by J. C. Herrick
Church of St. Mary Magdalen
Place, New York City

**No book or pamphlet is to be removed from the Laboratory without the permission of the Trustees.



THE ORIGIN OF A LAND FLORA



MACMILLAN AND CO., LIMITED

LONDON · BOMBAY · CALCUTTA
MELBOURNE

THE MACMILLAN COMPANY

NEW YORK · BOSTON · CHICAGO
ATLANTA · SAN FRANCISCO

THE MACMILLAN CO. OF CANADA, LTD.

TORONTO

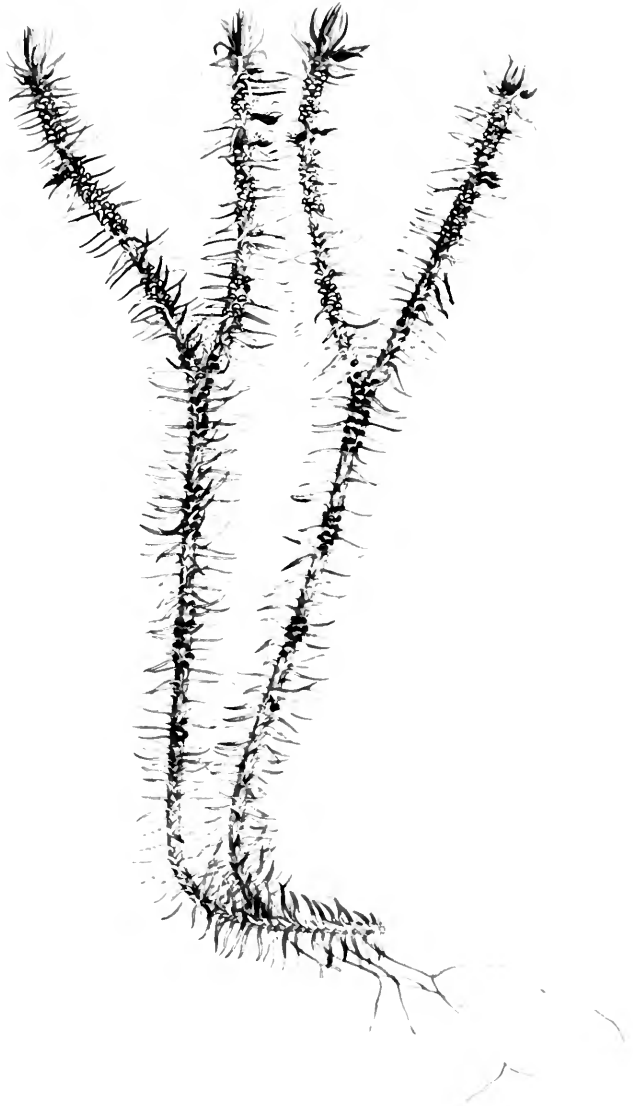

LYCOPodium.
SELAGO. L.

THE ORIGIN
OF A
LAND FLORA

*A THEORY
BASED UPON THE FACTS OF ALTERNATION*

BY
F. O. BOWER, Sc.D., F.R.S.
REGIUS PROFESSOR OF BOTANY IN THE UNIVERSITY OF GLASGOW

WITH NUMEROUS ILLUSTRATIONS



MACMILLAN AND CO., LIMITED
ST. MARTIN'S STREET, LONDON

1908

PREFACE

IN the year 1874 apogamy was discovered in Ferns by Farlow: and in 1884 instances of apospory in Ferns were demonstrated before the Linnaean Society of London by Druery. These events stimulated a fresh enquiry into the nature and origin of Alternation in Archegoniate Plants. My own observations on apospory confirmed my interest in this question: it seemed to me probable that some biological cause had determined the prevalence and constancy of the alternation, to which apogamy and apospory appear as occasional exceptions. The theory was entertained that the change of conditions involved in the invasion of the Land by organisms originally aquatic had played a prominent part in the establishment of those alternating phases of the life-cycle which are so characteristic of Archegoniate Plants. As early as 1889 I had already written several chapters of a treatise on this subject: but the necessary facts were found to be then so imperfectly known that the work was abandoned, and instead of a full discussion of the matter, the Biological Theory of Antithetic Alternation was briefly stated in a paper published in the *Annals of Botany* in 1890 (vol. iv. p. 347). The main position of Celakovsky in discriminating between Homologous and Antithetic Alternation was adopted; but the latter type, as seen in Archegoniate Plants, was recognised as having been fixed and perpetuated in accordance with the adaptation of aquatic organisms to a Land-Habit. The *Studies in the Morphology of Spore-producing Members* were then entered upon as preliminary investigations to elucidate the facts requisite for a more full statement, and they were published in five parts, from 1894 to 1903. Meanwhile, in 1894 Strasburger contributed to the Meeting of the British Association in Oxford his paper on the "Periodic Reduction of Chromosomes." He brought together a wealth of facts establishing the cytological distinction of the alternating generations, and his theoretical position was virtually identical with that of my paper of four years earlier.



TABLE OF CONTENTS

PART I.

STATEMENT OF THE WORKING HYPOTHESIS

CHAPTER	PAGE
INTRODUCTION, - - - - -	1
I. THE SCOPE AND LIMITATIONS OF COMPARATIVE MORPHOLOGY, -	5
II. THE LIFE-HISTORY OF A FERN, - - - - -	14
III. ON THE BALANCE OF THE ALTERNATING GENERATIONS OF ARCHEGONIATAE, - - - - -	33
IV. CYTOLOGICAL DISTINCTION OF THE ALTERNATING GENERATIONS OF ARCHEGONIATAE, - - - - -	46
V. ALTERNATION IN THALLOPHYTES, - - - - -	63
VI. BIOLOGICAL ASPECT OF ALTERNATION, - - - - -	79
VII. STERILISATION, - - - - -	87
VIII. THE SPORANGIUM DEFINED, - - - - -	103
IX. SOME GENERAL ASPECTS OF THE POLYSPORANGIATE STATE, -	113
X. VARIATIONS IN NUMBER OF SPORANGIA, - - - - -	119
XI. THEORY OF THE STROBILUS, - - - - -	132
XII. SPORANGIOPHORES AND SPOROPHYLLS, - - - - -	144
XIII. ON THE RELATIONS BETWEEN THE STERILE AND FERTILE REGIONS IN THE SPOROPHYTE, - - - - -	156
XIV. EMBRYOLOGY AND THE THEORY OF RECAPITULATION, - - - -	173
XV. ANATOMICAL EVIDENCE, - - - - -	188
XVI. SYMMETRY OF THE SPOROPHYTE, - - - - -	201

CHAPTER	PAGE
XVII. THE ESTABLISHMENT OF A FREE-LIVING SPOROPHYTE,	218
XVIII. EVIDENCE FROM PALAEOPHYTOLOGY, - - - - -	227
XIX. AMPLIFICATION AND REDUCTION, - - - - -	233
XX. SUMMARY OF THE WORKING HYPOTHESIS, - - - - -	244

PART II.

DETAILED STATEMENT OF FACTS

INTRODUCTION, - - - - -	255
XXI. BRYOPHYTA, (I.) HEPATICAE, - - - - -	257
XXII. BRYOPHYTA, (II.) MUSCI, - - - - -	272
XXIII. LYCOPODIALES—GENERAL MORPHOLOGY, - - - - -	288
XXIV. LYCOPODIALES—SPORE-PRODUCING MEMBERS, - - - - -	311
XXV. LYCOPODIALES—COMPARATIVE ANATOMY, - - - - -	328
XXVI. LYCOPODIALES—EMBRYOLOGY AND COMPARATIVE SUMMARY,	340
XXVII. EQUISETALES, - - - - -	366
XXVIII. SPHENOPHYLLALES, - - - - -	398
XXIX. SUMMARY FOR SPORANGIOPHORIC PTERIDOPHYTES, - - -	423
XXX. OPHIOGLOSSALES, - - - - -	430
XXXI. COMPARATIVE DISCUSSION OF OPHIOGLOSSALES, - - -	476
XXXII. FILICALES—BOTRYOPTERIDEAE, - - - - -	495
XXXIII. FILICALES—MARATTIACEAE, - - - - -	505
XXXIV. FILICALES—OSMUNDACEAE, - - - - -	530
XXXV. FILICALES—SCHIZAEACEAE AND MARSHIACEAE, - - -	542
XXXVI. FILICALES—GLEICHENIACEAE AND MATONINEAE, - - -	553
XXXVII. FILICALES—LOXSOMACEAE AND HYMENOPHYLLACEAE, - -	570
XXXVIII. FILICALES—THYRSOPTERIDEAE, DICKSONIEAE, DENNSTAED- TINAE, CYATHEAE AND SALVINIACEAE, - - - - -	589
XXXIX. FILICALES—MINTAE, - - - - -	612
XI. COMPARISON OF THE FILICALES, - - - - -	624

PART III.

CONCLUSION

CHAPTER	PAGE
XLI. ALGAE AND BRYOPHYTA, - - - - -	658
XLII. EMBRYOGENY OF THE PTERIDOPHYTES, - - - - -	663
XLIII. THE VEGETATIVE SYSTEM OF VASCULAR PLANTS ANALYSED, -	678
XLIV. THE VASCULAR SKELETON,- - - - -	685
XLV. THE SPORE-PRODUCING MEMBERS, - - - - -	692
XLVI. HETEROSPORY AND THE SEED-HABIT, - - - - -	703
XLVII. RESULTS, PHYLETIC AND MORPHOLOGICAL, - - - - -	709
INDEX, - - - - -	718

ADDENDUM.

By a regrettable oversight no mention has been made in the text of the interesting new genus *Loxsomopsis*, described by Dr. Christ as having been discovered in Costa Rica (*Bull. de l'Herb. Boissier*, 2me sér., tome iv., p. 393, 1904). This rare Fern, still unknown as regards stipe and rhizome, shows a habit like that of *Loxsonia*, but larger. The outline of the leaf, especially at the base of the pinnae, shows archaic characters, while the sori correspond in general features to those of *Loxsonia*; but the sporangia have a lateral dehiscence, and a complete ring composed of very numerous cells. In these details *Loxsomopsis* corresponds to *Thyrsopteris*. Pending a better knowledge of its characters and especially of its anatomy, it may be accorded a place in the neighbourhood of *Loxsonia* and *Thyrsopteris*, about the base of the series of *Gradatae* (compare p. 655, and Fig. 354).



INTRODUCTION.

OF the two branches of the Organic World, the Vegetable Kingdom might be expected to present a simpler problem of Descent than the Animal Kingdom, on account of the prevalent non-motility of the mature individual. That fixity of position which the Higher Plants show, should tend to a more obvious record of previous events than the ambulatory habit of Animals, and especially of their higher types, would seem to allow. It is reasonable to expect that organisms of fixed position should demonstrate in their distribution some traces of their past history; these would be specially valuable in the elucidation of the problem of the Origin of a Land Flora, and of the relation of the Land-growing Plants to those of the water.

But this *prima facie* probability is largely discounted by the extraordinary facility shown by Plants for the distribution of their germs. A comparison of the Higher Animals with the Higher Plants in respect of motility shows that the motile parent in the former is without special provision for distribution of its germs, while the Plant with its fixity of station shows high elaboration and variety in the methods of their dissemination. In consequence of this there will be a natural tendency in the vegetable kingdom, as there is also in that of animals, towards the obliteration of any such genetic record as the fixity of position of the individual plant during its active vegetation might otherwise have been expected to have left. Accordingly, on examination of the vegetation of any ordinary country-side, its uplands and lower levels, its swamps, streams, and pools, plants of the most varied affinity are found to be promiscuously shuffled together, and show little sign of ranking in their position according to their descent. For instance, the Flora of still fresh waters may be found to consist of such plants as various green Algae and Characeae; of *Isoetes* and *Pilularia*; together with Angiosperms, such as *Littorella*, *Lobelia*, and *Subularia*. In flowing mountain streams, in addition to green Algae may be found *Chantransia* and *Lemanea*, associated with *Pontinialis* and sundry Angiosperms. Conversely, in various positions on land, along with certain Algae in moist spots, representatives

of the great groups of Bryophytes, Pteridophytes, and Seed-plants may be found in close juxtaposition, and sharing the same external conditions. On the sea-littoral it is otherwise: there Algae are found associated together almost to the exclusion of other plants. Nevertheless, occasional Phanerogams do invade the belt between tide-marks, and thus even this limit between the Vascular Flora of the land and the Algal Flora of the sea-littoral is apt to be blurred.

It is plain, then, from such simple examples as these, which might be indefinitely varied and extended, that the problem of the origin of a Land-Flora is not to be solved by any mere reading of the facts of distribution into terms of the evolution of the characteristic plants of the land. Some other basis than that of distribution at the present day must be found for the solution of the problem. It is to be sought for in their comparison as regards structure and function, and that not only in the most complete condition of full development, but also in the successive phases of the individual life-cycle.

The study of the form and structure of plants, as well as of their physiology, directs attention naturally to the water-relation: this more than any other single factor dominates the construction of land-living plants, while comparison with kindred aquatics shows how profoundly land-living plants are influenced by the necessity of adequate water-supply. But not only is this dependence of land-plants on water a general feature of the whole life-cycle: in certain large groups of plants it is found that leading events in the individual cycle are directly dependent upon the presence of external fluid water. The importance of such matters in relation to the present problem of the Origin of a Land-Flora will be gauged by their prevalence and constancy in large groups of organisms. Now in the whole series of Archegoniate Plants (Mosses and Ferns), and in some Gymnosperms the act of fertilisation can only be carried out in presence of fluid water, outside the actual tissue of the organism: their spermatozoids are for a time independently motile in external water, and it is a mere detail that in the higher and more specialised forms, the distance to be traversed is only short from the point of origin of the spermatozoid to the ovum which it is to fertilise. The importance of fertilisation need not be insisted on here: everyone will admit it to be a crisis, perhaps the most grave crisis, in the life-cycle of the plant. When this critical incident in the life is found, in so large a series of allied plants as the Archegoniatae, to be absolutely dependent on the presence of external fluid water for its realisation, that fact at once takes a premier place in any discussion of the relation of plants to water.

A comparison of the Seed-Plants with the Archegoniatae leads without any doubt to the conclusion that their method of fertilisation by means of a pollen-tube is a substitution for that by means of the motile spermatozoid. The Seed-Plant by adopting this siphonogamic mode of fertilisation becomes thereby independent of the presence of external

fluid water at this critical period: it may thus be held to have broken away from a condition of life inconvenient and embarrassing to organisms which live on exposed land-surfaces: and to have established itself in this character, as well as in its vegetative development, as a typical land-living organism. If this view of the matter be adopted, it follows that the Mosses and Ferns occupy a middle position in the relation to water: they may almost be described as amphibious, since, though they vegetate mostly on land, and show certain advanced structural adaptations to such life, they are nevertheless dependent upon external water for the important incident of fertilisation in each individual life-cycle. The strange feature is that they have retained so persistently this aquatic type of fertilisation.

Looking further down in the scale of vegetation, attention is naturally directed towards the Algae, plants resembling, in some superficial characters of cell-structure and of colouring, the simpler terms of the Archegoniate series, though still more dependent than they upon external fluid water for the completion of their life-cycle. It may well be that the affinity which such features suggest is at best only a remote one; but at least the existence of such forms would seem to justify the view as a probable one, that the great Archegoniate series, which has had so large a share in initiating that Land-Flora which we now see occupying the exposed land surfaces of the globe, has had its origin in aquatic forms: that from these a gradual adaptation to a land-habit has provided those forms of vegetation which we group together under the terms, Liverworts, Mosses, Club-mosses, Horsetails, and Ferns: and finally, with further adaptation to the land-habit, came the Seed-Plants—first the Gymnosperms and subsequently the higher Flowering Plants. The latter culminated in the Gamopetalous Dicotyledons, which are essentially of Flowering Plants the most typical elements of a Land-Flora, since they include a smaller proportion of aquatic species than either the Monocotyledons or the Archichlamydeae.

This, then, is the general position adopted at the outset: it is in accordance with the known facts of Palaeontology, and is the view generally entertained by modern morphologists. It will be the object of the present work to enquire into the details of such progressions as those above mentioned: especially it will be our duty to see how far the life-histories of Archegoniate forms will justify the view that the present Land-Flora has originated from an aquatic ancestry, and that there has been a migration from the water to the land: in that case, it will be a further object to ascertain how this has been carried out, and to trace those methods of specialisation to a land-habit, which have led to the establishment of the higher terms of the series as the characteristic representatives of the Flora of exposed land-surfaces.

It is no new view which is thus to be put forward: for it has long ago been concluded that the origin of life, whether animal or vegetable,

has been in the water, and that the higher forms of either kingdom have assumed such structural and physiological characters as enable them to subsist in greater independence of aquatic surroundings than their simpler progenitors. The present attempt will be to fill in certain of the details into this general scheme, as applied to the vegetable kingdom, and to present some connected story of how the transition may have come about, as it may be seen reflected in the plants themselves, whether of the present day or of the remote past.

CHAPTER I.

THE SCOPE AND LIMITATIONS OF COMPARATIVE MORPHOLOGY.

CONFRONTED with the great variety of plant-types which exist living and fossil on the earth's crust, the Botanist may regard them in various ways with a view to reducing them to some general conception of order. He may be satisfied with the mere cataloguing and description of the divers^d forms which he is able to distinguish, and with the grouping of those together which show characters in common:—this is the work of the Descriptive Botanist, and it naturally took the first place in the historical development of the science. Or he may attempt to find in such similarities of form as are shown by organisms thus grouped together some consecutive account of their probable origin:—this is the work of the Scientific Systematist, or student of Phylogeny, and it is the ultimate aim of all current Morphology.

In the earlier periods the student of form understood himself to be enquiring into the details of the Divine plan, as illustrated in a series of isolated creations: and any similarities which species might show would demonstrate for him merely the underlying unity of that plan. But in these later days he believes that the comparative study of form will lead him towards a knowledge of the main lines of descent. Contributory to this, which can only result in a balancing of probabilities, or often of mere surmises, is the study of the Fossils: Palaeophytology gives the only direct and positive clue to the sequence of appearance of plant-forms in past time upon the earth. Unfortunately the results acquired as yet along this line of observation are so fragmentary that they do not suffice to indicate even the general outline of the true picture: they must for the present be used rather as a check to phyletic theories than as their constant guide. The field is thus left in great measure open to other lines of enquiry.

A second line of evidence which bears upon the evolutionary history may be derived from the geographical distribution of plants upon the

earth's surface. This is, however, applicable only within certain limits: one of those limits is imposed by the wide distribution of germs which is so prevalent in plants. Wherever the mechanism for dispersion of germs is highly elaborated, and successful, the traces of evolutionary history, as shown by geographical distribution, are apt to be obliterated. The consequence is that in practice such distribution is only available as evidence of descent within restricted limits. The great geographical barriers, such as the tropics, the greater oceans, and the more continuous mountain ranges, it is true, delimit at present certain areas of vegetation, within which evidence of value as contributory to a knowledge of descent may be gathered; but at best this applies only to the later phases of evolution, and geographical distribution of plants at the present day gives little clue, or perhaps none at all, to the origin of the great groups which constitute the Vegetable kingdom at large. The fact that such genera as *Equisetum*, *Lycopodium*, *Selaginella*, *Isoetes*, *Marattia*, *Marsilia*, and *Pilularia* are, within their several limits of temperature, virtually cosmopolitan shows how little can be expected from geographical distribution of living forms as a key to the evolution of early types. Among fossils, *Lepidodendron* is virtually cosmopolitan. Plants of the *Glossopteris* flora, long thought to be distinctively southern, have recently been recognised from Russia. Such examples suggest that neither does the geographical distribution of fossils as yet give any certain evidence as to descent of the main phyletic lines.

Another closely related branch of Botanical science is the study of organisms from the aspect of function and circumstance, as tested by physiological experiment. The intimate connection between form and environment is too obvious to need insistence here; but though the individual shows a high degree of plasticity under varying conditions, still there is a large field, embracing the very fundamentals of plant-form, such as the evolutionary origin of leaves, of roots, or of sporangia, which lies as yet outside the region of physiological experiment. Thus, however interesting the branch of physiological morphology may be, its scope is still narrowly limited. The method of experiment, with a view to ascertaining the effect of external agencies in determining form, is now nascent, and carries with it high possibilities. But it is well in the enthusiasm of the moment to keep in view the limitations which must always hedge it round. It is to be remembered that the effect of external conditions upon form is always subject to hereditary control, and that thus a large field is left open still for speculation. This seems to have been forgotten by a recent writer, who remarks that "the future lies with experimental Morphology, not with speculative Morphology, which is already more than full blown."¹ Though we may question the cogency of this antithesis, still the assertion contains an important truth, inasmuch as it accords prominence to experiment: but the case is overstated. All who follow the development

¹ *Flora*, 1903, p. 500.

of morphological science will value the results already obtained from the application of experiment to the problems of plant-form. But it is necessary at the same time to recognise that the two phases of the study, the experimental and the speculative, are not antithetic to one another, but mutually dependent: the one can never supersede the other. The full problem of Morphology is not merely to see how plants behave to external circumstances *now*—and this is all that experimental morphology can ever tell us—but to explain, in the light of their behaviour now, how in the past they came to be such as we now see them. To this end the experimental morphology of to-day will serve as a most valuable guide, and even a check to any more speculative method, by limiting its exuberances within the lines of physiological probability. But present-day experiment can never do without theory in questions of descent. Experiment by itself cannot reconstruct history: for it is impossible to rearrange for purposes of experiment all the conditions, such as light, moisture, temperature, and seasonal change, on the exact footing of an earlier evolutionary period. And even if this were done, are we sure that the subjects of experiment themselves are really the same? There remains the factor of hereditary character: there is also the question as to the circumstances of competition which cannot possibly be put back to the exact position in which they once were. Consequently there must always be a margin of uncertainty whether a reaction observed under experiment to-day would be the exact reaction of a past age. So far, then, from experiment competing with, or superseding speculation in Morphology, it can only act as a potent stimulus to fresh speculation, whenever the attempt is made to elucidate the problem of descent. It will be only those who minimise the conservative influences of heredity, or, it may be, relegate questions of descent to the background of their minds, who will be satisfied by the exercise of the experimental method of morphological enquiry, apart from speculation.

The relations of Morphology and Physiology have been variously recognised in the course of development of the science. In the earlier periods the two points of view rarely overlapped. Even Sachs, the great pioneer of modern experimental physiology, kept the two branches distinct in his text-book, recognising the "Difference between Members and Organs." But later, in his lectures, he brought them more closely together, and habitually regarded morphological facts in their physiological aspect. This is indeed the natural position for any adherent of Evolution: and it has been concisely said that morphology deals with the stereotyped results of physiology. Such a statement may, however, be criticised as assuming too much, in that it accords all initiative in, and determination of form, as well as its selection and perpetuation, to the influence of circumstance and function. A more apposite summing up of the relations of the two branches of Biological science has lately been given by Goebel¹

¹ "Die Grundprobleme der heutigen Pflanzenmorphologie," *Biol. Centrbl.*, Bd. xxv., No. 3.

when he said that "Morphology includes such phenomena as are not yet physiologically understood." He further indicates that the separation of the two points of view has not any foundation in the nature of the case, but it is only a preliminary aid to a clear view amid the multiplicity of phenomena. The limits between morphology and physiology must necessarily fall away as advances are made. But meanwhile Morphology must continue to exist, even though it is not and cannot be an exact science: it deals comparatively with phenomena imperfectly explained as regards their origin in the individual or the race. The history of development of plant-form is an ideal to be approached experimentally, and the final object will be not merely a knowledge of the phylogenetic development, but of the very essence and cause of the development itself. It will be obvious how far present phylogenetic theory falls short of this ideal of Causal Morphology, but that is no sufficient reason for discontinuing its pursuit as a progressive study.

For the present the comparative study of plant-form from the point of view of descent, as exhibited in the various phases of the individual life-cycle, must be pursued as in itself a substantive branch of the science: it is clear from what has been said above that it is not co-extensive with either Palaeophytology, Plant-Geography, or Plant-Physiology: nevertheless it overlaps with all of these, and must be liable to be checked by the results of any of these branches. Furthermore, the extension of knowledge of any of these branches will inevitably lead to further overlapping, till in the end the knowledge derived from the various methods of investigation should coincide in conclusions which will be general for them all, and constitute a true perception of the evolutionary story. But at the moment this consummation is so far from being attained that there is still room for the theoretical treatment of the evolution of plants as based on the formal comparison of their life-cycles. This must take due cognisance of the other branches of study, but will still rest upon its own footing of fact and conclusion.

There is one assumption involved in such comparative study which should be clearly apprehended and considered, rather than tacitly passed over. An evolutionary argument based on comparison of life-cycles is only valid if the organisms compared have retained the main incidents in their individual life unchanged throughout descent. In the main argument of this work, the assumption is deliberately made that such constancy existed, or, rather, the argument proceeds upon the conclusion derived from broad comparison, that the main incidents once initiated have been pertinaciously retained. It may be held, and reasonably defended, that sexuality may have arisen in many distinct phyletic lines. It is not our present purpose to distinguish those different origins, or defend their distinctness. But comparison leads us to conclude that, once initiated in an evolutionary sequence, sexuality remained throughout descent substantially the same process in normal life-cycles. It may be modified in mechanism,

as indeed there is good reason to see that it was; but it consisted still in the fusion of two cells together, bringing, as we believe generally, and see proved already in so many cases, a doubling of the chromosome-number as a consequence. Seeing sexuality of this nature a constantly recurring feature in the life-cycle of various definite phyla leads to the conclusion that in those phyla it was also constant during their descent. Similarly, a reduction of chromosome-number has been found to be regularly associated with normal spore-production, and spore-production is found to be a constantly recurring event in large series of plants. In these it is concluded that reduction and spore-production have also been constantly recurring incidents throughout the descent of those series. It is hardly right to designate this opinion as an assumption: it seems rather to be a natural and valid outcome of comparative study. But if, on the other hand, such constancy of the leading events of the life-cycle in any phylum during descent were to be clearly disproved, then it will follow with equal clearness that the comparative argument based upon such facts will have to be revised for that phylum. It may seem hardly necessary to put down *in extenso* reasoning which is so obvious; but, on the other hand, it is well to see clearly the basis upon which the main argument will proceed. The constancy of the events of sexuality and of spore-production in normal life-cycles of the several ascending series of green plants is itself the cardinal point of the theory to be advanced in relation to the origin of a Land-Flora. In so far as inconstancy of either of these events occurs in them it will be shown that there is good reason to believe such exceptions to be of relatively late origin.

The further facts which form the basis of Comparative Morphology include those relating to the mature external form of the plant, as seen in the successive phases of the individual life-cycle: the internal structure, as shown by its anatomical study: the form and structure of the parts involved in propagation, and the embryology of the individual. Such facts relating to living organisms are to be read in the light of comparison with the fossils, and the validity of any conclusions tested as far as possible according to the results of physiological experiment.

It has been customary from the earliest times of natural classification to group together as akin, according to their degree of similarity, those organisms which correspond in form. Such alliances, long ago recognised, received a new significance in the light of evolutionary theory: the likeness thus comes to be attributed to community of descent, the nearness of the kinship being held proportional to the similarity of form, structure, and development of the individual. It is essential, however, to bear in mind always that this is only an hypothesis, incapable of complete proof under present conditions of study, and that the extent of direct evidence as yet available is small indeed. It is true that variation in different degrees is widespread: that, whatever the causes or methods involved, new races may be, and indeed have been established, which come true in more or

less degree after propagation by seed: and that thus the possibility has been demonstrated of origin and establishment of new forms from more or less dissimilar parents. This is not the place to discuss the sources of variation: whether it arises by a cumulative summation of slight differences, or by mutations *per saltum*, or both: nor whether the characters acquired during the individual life are or are not transmitted to the offspring, thus giving a positive direction to variation: nor yet to consider the effect of sexuality, and of the subsequent reducing-division of the nucleus in distributing the qualities inherited from the parents. It suffices for our theoretical position that variations do occur, and that they are liable to be transmitted to offspring. The struggle for existence in this greatly over-populated world necessarily acts as a sieve upon such variants, and though the survival of the fittest is in no sense a positively constructive factor in itself, it results in the preservation of what is capable of self-support, and the elimination of what is physiologically less efficient. But when thus much is granted, it amounts only to this: that living organisms demonstrate that such an origin as evolutionary theory contemplates is at least possible. It does not necessarily follow that all known forms did originate in this way. Still, we are justified in accepting this view as a "working hypothesis," much more probable than any other explanation hitherto given of the existence of various living forms.

But though we may readily adopt an evolutionary view, as a working hypothesis applicable to organic forms at large, it is when we apply it in detail that the real difficulties begin. We contemplate, for instance, some group of plants which have essentially similar form, structure, and development: we find that they differ in certain details and proportions, and that it is possible to lay them out in a series extending from one extreme form, through minor gradations, to another extreme form. Such a series may be strengthened by tracing parallelism of variations of two or more characters. Where this can be done the probability of the series representing a real evolutionary line is greatly enhanced. But there are at least three ways in which such a series may be read: (1) that the simplest form was the most primitive, and the whole series one of *progression*: (2) that the most complex was the most primitive, and the whole series one of *reduction*: (3) that the origin was from some central point, and the development *divergent in two or more directions*. Any one of these alternatives would be compatible with general evolutionary probability. How are we to decide which to adopt in any given case?

The general principle that progress has been from the simpler to the more complex gives to the first alternative a *prima facie* probability. As a matter of fact this consideration weighed largely in the phylogenetic decisions of a quarter of a century ago, and the opinions on the descent of Ferns serve as a good illustration of it. Those Ferns which have the smallest sporangia (Polypodiaceae, Hymenophyllaceae) were held to be the most primitive, while those with larger and more complex sporangia

were regarded as more advanced (Osmundaceae, Schizaceae, Marattiaceae). But this, which was little better than an assumption, needed to be tested on other grounds, such as comparison with other Pteridophytes, and reference to the results of physiological and palaeontological enquiry. It is now pointed out, first, on the comparative basis, that the Leptosporangiate Ferns are isolated from other plants by the simplicity of their sporangia, and that the link in sporangial character with other early types is to be found more probably through the Eusporangiate than through the Leptosporangiate types. Secondly, it can be shown experimentally that reduction of complexity of leaf-structure follows the shade-habit; and the "filmy" character of the leaf in the Hymenophyllaceae is probably only an extreme case of this, while the smaller size of the individual sporangia shows some degree of parallelism with this adaptation: certainly it is so in the genus *Todea*. There is also some experimental basis for the conclusion that the thin-leaved habit is a derivative condition following on a shade-habit. Thirdly, the Palaeontological evidence shows that whereas the Eusporangiate Ferns were the characteristic Ferns of the primary rocks, while Leptosporangiate Ferns were certainly rare, the Leptosporangiates were in the ascendant in later strata, and are the dominant Ferns of the present day. From such evidence, which will be seen to be convergent along three lines of argument, the conclusion is drawn that the general series of Ferns has not been one of advancing complexity of sporangial structure, but of reduction. This case will serve as an illustration how the *primâ facie* probability of advance may be overruled by the cumulative effect of other evidence. As a consequence perhaps of such proof of reduction in this and other cases, the tendency of the moment among Botanists is to look with general mistrust upon ascending series. For my own part, I think this tendency has been allowed too free scope: the *primâ facie* probability of a series being truly progressive should be kept clearly in mind until it is disproved on more exact grounds.

Wherever a linear series of forms is recognised these two alternatives, of the series being an ascending or a descending one, will present themselves. But there is also the third alternative, viz. that the series may have been one of divergent development from some central point. It will be apparent that this is in truth merely a combination of the two preceding cases, and the lines of argument will be the same, though necessarily more complicated. As a consequence such divergent series are less readily substantiated than simple series would be.

But there remains the still more serious question whether a series which may have been laid out on ground of form as a presumable evolutionary sequence reflects actually any line of evolution at all. It may be composed of members of distinct phyletic lines, which have converged in respect of those characters which lie at the foundation of our comparison. It has long been known that similarity of form may be arrived at along distinct evolutionary routes: this is designated parallel, or polyphyletic development, and examples

can readily be found in the vegetative and propagative parts of plants both high and lower in the scale: it may affect not only the modification of parts already present, but also the origin of new parts. As prominent examples which will be discussed at length later, the polyphyletic origin of leaves, of heterospory, and of the seed-habit may be quoted. This frequent occurrence of parallel development should serve as a check on the too ready acceptance of conclusions based on mere formal comparison, and it shows that it is necessary to be sure of the phyletic unity of a series before sound conclusions can be arrived at from comparison of its components.

It may be useful to quote a specific case of fallacious reasoning based on comparisons which are not within one phyletic unity. It is possible to compare the sporangia of *Calamostachys* with those of *Selaginella*, of *Isoetes*, and of the Hydropterideae, as examples of heterospory: and general conclusions might be drawn from such comparison as to the progressive steps of the heterosporous differentiation. But these plants are now recognised as representing three (and possibly even four) distinct phyla, all of which include homosporous forms. The latter fact indicates that heterospory arose after the differentiation of those phyla. It is therefore impossible to argue correctly from one phylum to another as to the course which a common spore-differentiation has taken, since its course must have been distinct in each case from the others. The most that can be properly attained is an analogy between the separate progressions as seen in those several phyla.

It is plain then that organic nature is not self-explanatory; and that Comparative Morphology is a study beset with pitfalls. There is uncertainty, first, in the recognition of true evolutionary sequences: still more in their interpretation as ascending, descending, or divergent: and again in the connecting of these sequences together so as to construct some more or less consecutive story of descent: indeed, this can only be done when liberal use is made of the imagination, in bridging over the wide gaps in the series, which even the known fossils are so far from filling. The details of a story thus constructed depend so largely on comparative opinion, or balancing of probabilities, and in so slight a degree upon positive demonstration that the history as told by competent experts in Comparative Morphology may vary in material features. A little more weight allowed for certain observed details, or a little less for others, will be sufficient to disturb the balance of the evidence derived from a wide field of observation, and consequently to distort the historical picture. In the absence of more full "documentary" evidence from the fossils there is in truth no finality in discussions on the genesis and progress of organic life. But as long as the human mind has the power of and inclination towards enquiry, so long will such discussions continue, together with their kaleidoscopic changes of opinion. Every new fact of importance will in some degree affect the weight accorded to

others and vary the general result. It will be seen in the discussions which follow how largely this is so in the morphology of plants.

It may be objected that conclusions which are so plastic are little better than expressions of personal taste, or even of temperament: that the study of Comparative Morphology is therefore calculated to dishearten its votaries, while the non-specialist public, which is compelled to take its information at second hand, will be bewildered, and will conclude that it is useless to pursue a science which shows so little stability. But even where problems are apparently insoluble under circumstances of present knowledge, it is a satisfaction to most minds to entertain an opinion, even if that opinion be of a theoretical nature, and be liable to future modification or ultimate disproof. On the other hand, as regards the actual progress of morphology, those who follow its history with sympathetic care will gain heart when they compare the present position with that of a generation ago. And especially for Botanists it is encouraging to think that it is little more than half a century since the history of the life-cycle of a Fern was first completed by Suminsky. In some sixty years a vast array of kindred facts has been acquired, and a theoretic superstructure is being raised upon them which, though still protean, is gradually acquiring some settled form. Never in its history has the advance of morphological thought been so rapid as at present. But in no field of morphological research has investigation been more amply rewarded than in palaeophytology: the luminous facts derived from fossils are shedding a fresh and a direct light upon obscure problems, such as the origin of the seed-habit, and helping us to locate such difficult groups as the Psilotaceae and Equisetineae. When we regard these rapid advances, and truly estimate the influence they bring to bear in strengthening the positions already indicated by morphological theory, we shall not only see that this branch of the science is very actively alive, but also that its theorisings are not merely unsubstantial figments of the mind.

Considerations such as these go far to justify the statement in the present work of a theoretical view of the origin of a Land-Flora. Some may deem the opinions expressed as unduly speculative, but in the first place, they are based upon a wide area of fact, and secondly, as above remarked, comparative morphology must necessarily assume a theoretical form under present conditions. We have seen that its conclusions as to descent are at best the result of a balancing of probabilities. As long as this is clearly understood by the reader, and the author abstains from any dogmatic attitude, good should come from any duly reasoned statement, even though, like the present, it may be of a theoretical nature. A working hypothesis, open like others to refutation, is better than no hypothesis at all. This is the position consciously adopted here, for it is believed that the full statement of even a speculative view will stimulate enquiry, which may lead towards its ultimate proof or disproof.

CHAPTER II.

THE LIFE-HISTORY OF A FERN.

THE middle years of the nineteenth century marked an important epoch in the history of Plant Morphology. Before that period this branch of botany could hardly be said to exist as a science. What gave distinction to that period was the publication of observations which made it possible for the first time to give a consecutive account of the various stages in the life-history of the Higher Cryptogamia. Up to that time it had been the custom to compare Ferns with Flowering Plants, notwithstanding that the facts, so far as they were known, gave little support to any view of their close similarity; and to attempt to express the life-story of these and others of the lower plants in terms of the higher. But the investigations of that period, by following out the actual facts of development, showed not only that there was no correlative of the seed in the life-cycle of a Fern, but also that there was in the prothallus of Ferns a phase of the life-cycle which differed in essential points from anything which was then known to exist in the development of Seed-Plants.

The spores of Ferns were experimentally recognised as reproductive organs by Morison (1699), who raised young plants from them. But Kaulfuss first observed their germination (1825), and the formation of the prothallus, which had already been described by Ehrhart (1788): it was Bischoff (1842) who first recognised the embryo attached to the prothallus. Naegeli (1844) discovered the antheridia and spermatozoids, while Suminski (1848) ascertained the true nature of the archegonium, and its relation to the embryo. But it remained for Hofmeister to put together, and complete the story. In 1849 his description of the germination of *Pilularia* and *Salvinia* appeared, and two years later, in 1851, he gave to the world his *Vergleichende Untersuchungen*, a work which dealt in the most comprehensive way with the life-story of a number of Liverworts, Mosses, Ferns, Fern-Allies, and Gymnosperms.

It is impossible to exaggerate the importance of the advance in view which the publication of Hofmeister's book brought. The middle years

of the nineteenth century were indeed the heroic age of Plant Morphology, and the results then attained will always continue to be the basis of comparison, as applied to the ascending series of green plants. It must, however, be remarked that those results were achieved on a purely comparative footing, and at the moment carried no further interpretation with them. For these were the days before evolutionary theory held sway in the Biological sciences, and accordingly no underlying phylogenetic meaning was as yet seen in the facts observed and compared. But eight years later Darwin's *Origin of Species* was published, and "the Theory of Descent had only to accept what genetic morphology had actually brought into view." It is also to be noted that at first no past physiological history was traced in the facts of the individual life; this line of interpretation suffered much longer delay, and is even now only gradually becoming apparent. As we shall see, however, such a meaning and such a history may still be found reflected in those successive phases of the individual life which Hofmeister and his predecessors were able to detect and to compare. It is along lines such as these that we may best seek for the solution of the problem presented by the origin of a Land-Flora.

It will then be essential for our purpose, in the first place, to follow through all its phases the life-history of certain typical organisms, and we shall best begin with those which occupy a middle position in our system, viz. the Pteridophytes. The common Male Shield Fern (*Nephrodium Filix-mas*. Rich.) will serve as a familiar, and also a suitable example.

This Fern is known to every one as growing in woods and hedgerows, and even in more exposed situations, such as the open gills and hill-sides of higher-lying districts. It presents a robust appearance, and when fully developed it consists of an oblique and massive stock, which is relatively short: this is entirely covered over by the bases of the leaves, of which the youngest constitute a closely packed terminal bud (Fig. 1). Those leaves which are situated further from the apex, and immediately below the terminal bud, may in summer be found to be of large size and compound structure (Fig. 2); they are of a rather firm texture: individually they are in outline not unlike the ancient Greek shield, and collectively they form a crown-like series surrounding the terminal bud. Passing again further back from the apex of the stock, its surface is found to be closely invested by the bases of the numerous leaves of former seasons, the upper portions of which, having performed their functions, have rotted away. If the plant be dug up, and the soil carefully removed from it, an ample root-system will be seen, consisting of thin, wiry, and dark-looking fibrils, which spring from the basal parts of the leaves, and may bear numerous branch-rootlets.

All these parts consist of tracts of tissue differentiated to subserve distinct functions. The Vascular Skeleton, which appears as a cylindrical network of strands within the massive axis (Fig. 1, E, F), throws off continuous and connected branches, on the one hand into the leaves,

where they ramify and extend upwards to the extreme tips and margins. On the other hand, strands of vascular tissue derived from the leaf-bases extend towards the tips of the roots, and laterally into their branchlets. The Vascular System is thus a connected conducting-system throughout the plant. It is embedded in softer parenchymatous tissues, which serve

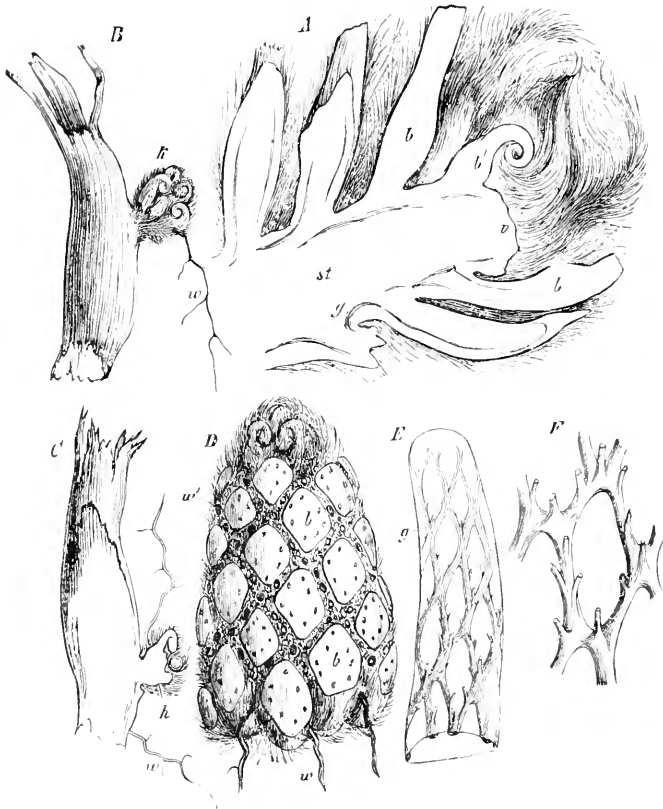

FIG. 1.

Nephrodium Filix-mas, Rich. *A*, stock in longitudinal section; *v*, the apex; *st*, the stem; *b*, the leaf-stalks; *b'*, one of the still folded leaves; *g*, vascular strands. *B*, leaf-stalk bearing at *k* a bud with root at *w*, and several leaves. *C*, a similar leaf-stalk cut longitudinally, bearing bud, *b*, with root, *w*. *D*, stock from which the leaves have been cut away to their bases, leaving only those of the terminal bud. The spaces between the leaves are filled with numerous roots, *w*, *w'*. *E*, stock from which the rind has been removed to show the vascular network, *g*. *F*, a mesh of the network enlarged, showing the strands which pass out into the leaves. (After Sachs.)

various purposes in the different parts: thus in the young root they may be absorbent, or serve to hand on the fluids absorbed to the conducting system: in the stem they may serve the purpose of storage of reserve materials, while in the leaf the parenchyma carries out the function of photosynthesis, together with the passing on of the supply thus acquired to the conducting system. The parts exposed to the air are covered by

an epidermal layer, with a cuticularised external wall, which prevents indiscriminate loss of water by surface-evaporation. But the epidermis is perforated by numerous stomata, the motile guard-cells of which can control, according to circumstances, the width of the pores leading into the intercellular spaces. There is thus a highly organised ventilating

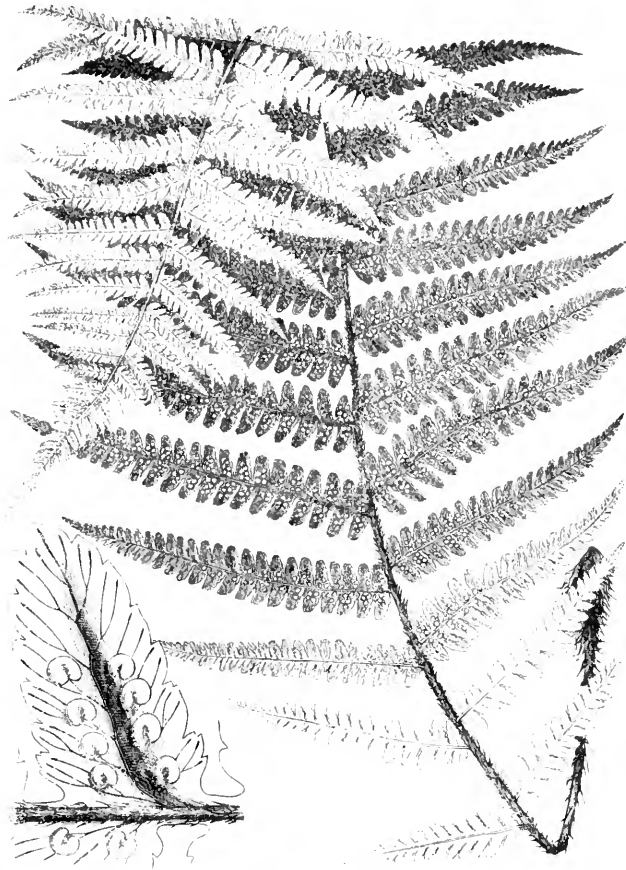

FIG. 2.

Nephrodium Filix-mas, Rich. Fertile leaf about one-sixth natural size, the lower part with the under surface exposed. To the left a single fertile segment, enlarged about 7 times. (After Luerissen.)

system. Finally, there are also firm, brown, resistant tissues, disposed sometimes near the outer surface, as in the stem and in the leaf-stalk: sometimes more deeply seated, as in the root, while in the leaf they follow the course of the vascular strands. These give to the several parts increased mechanical strength, and power of resistance.

Thus constituted the Male Shield Fern is an organism which is capable of leading an independent life on an exposed land-surface: it

is in a position to nourish itself by taking up from the soil the water and salts which it requires, and to elaborate therefrom, and from the carbon-dioxide of the air, fresh supplies of organic food. Further, though for reasons to be explained later, it frequently is found growing in situations where moisture is abundant and the air moist; still it can resist considerable drought, and is capable of living under as exacting conditions as any ordinary terrestrial plant. As proof of this, cases may be quoted of the removal of mature Shield Ferns from a more moist habitat to exposed situations, where there is no shade, nor any special supply of water: they are found to flourish there permanently; but they show slight differences of form from the shade plants: the leaves are more robust, of smaller area, and of a paler colour.

In this power of resisting drought the Shield Fern is by no means an isolated exception, nor in any sense an extreme type among Ferns. It is a familiar sight in this country to see dry hill-sides covered with the common Bracken, and taking no harm from a summer drought. There is also a small British Flora of Ferns of dry wall-tops, including such species as *Polypodium vulgare*, *Asplenium Ruta-muraria*, and *Ceterach*: these may be found sometimes with their leaves dried to crispness in summer. Abroad there are certain genera, such as *Nothochlaena*, and *Jamesonia*, and the *Niphobolus* section of *Polypodium*, which are typically xerophytic: in other cases isolated species may show special adaptation to dry surroundings; for example, *Hymenophyllum sericeum* which is a member of a peculiarly hygrophytic genus. These xerophytic Ferns inhabit dry climates, such as the higher Andes: or they are epiphytic in habit, and have no access to the water-reservoir of the soil. The forms which the xerophytic modification may take are succulence of the smooth leaf, with well-developed epidermis, as seen in *Polypodium nummulariaefolium*, and *piloselloides*, and also in *Platyserium*: or a development of a thick felt of hairs may cover the surfaces, as in *Niphobolus*, *Nothochlaena*, and *Jamesonia*: or of scales, as in *Polypodium (Lepicystis) incanum*, or *Asplenium Ceterach*: or there may be a xerotropic folding of the pinnae, as in *Nothochlaena sinuata* and *ferruginea*, and in *Jamesonia*. There is also a very efficient mode of resisting extreme drought which is not shown structurally, viz. the power of retaining vitality after drying up. A good example of this is seen in *Polypodium (Lepicystis) incanum*, which grows commonly in Trinidad on tree-trunks, and there shrivels for weeks without rain, under a tropical sun; but when moistened again it swells, and continues growth. Such vitality is shared in some degree by the Ferns of our wall-tops, and is a common feature leading to the survival of many other plants, notably among the Bryophytes. Such cases as these quoted will serve to show that a moist habitat is not always a necessity for the life of the mature Fern-Plant, and even that Ferns, as a family, show a considerable aptitude for resisting extremes of drought. But nevertheless most Ferns do affect moist situations, while to some, such as

the Filmy Ferns of tropical forests, an atmosphere approaching complete saturation with moisture is a constant necessity. The Male Fern may indeed be accepted as a medium type, showing no special adaptation nor susceptibility either to moisture or drought, while structurally it shows such characters as are usual in average Land Vegetation.

With very few exceptions Ferns are perennials, and in the case of the Shield Fern there is no theoretical limit to the duration of the individual life: in point of fact the plant may grow continuously for a long term of years, as is shown by the length of the stock, and the long succession of the bases of leaves of former years which may be observed persistent upon it in the larger specimens. But still it is subject to many vicissitudes, which are liable to terminate its existence. Some provision must be made for the maintenance of the race by the formation of new individuals.

The vegetative mode of propagation in the Shield Fern is by means of buds which appear at a late period upon the persistent bases of leaves of former years. These develop leaves similar to those of the parent, with roots which form an independent system, so that when the progressive rotting, which is always advancing from the base of the stock onwards, isolates the parent leaf from the rest of the plant, the bud is in a position to subsist as an independent individual (Fig. 1, B, C). This is merely one example of what is a very common phenomenon in Ferns, viz. the vegetative propagation of the individual. The details of the process, such as the position and the number of buds, may vary greatly in different cases (Fig. 3), but the essential point is the same, that by a purely vegetative growth, and without any known cytological complications, new individuals may be derived, which are similar in all essentials to the parent. Such means of increase are styled collectively under the head

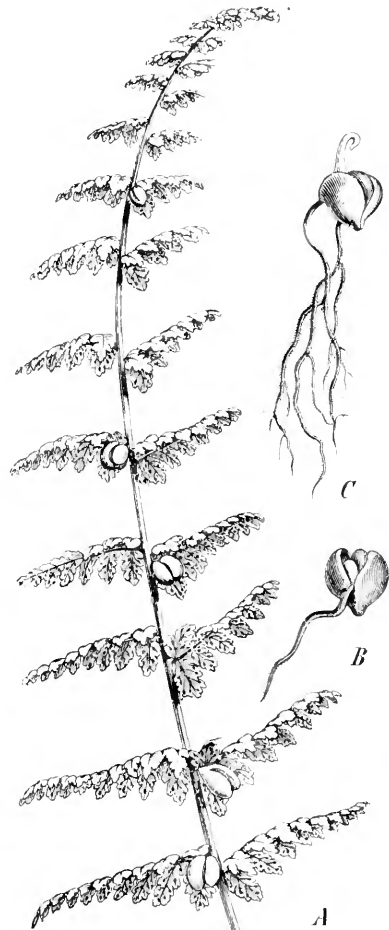

FIG. 3.

Cystopteris bulbifera (L.) Bernh. A, part of a leaf with adventitious buds. Natural size. B, an adventitious bud which has fallen off, forming a root. C, an adventitious bud further developed. B and C somewhat enlarged. (After Matouschek.)

of Sporophytic budding. It is plain that such growths are only methods of amplification of the morphological individual: though ultimately quite separate from the parent plant, there is no reorganisation of the protoplasts involved in their initiation.

There is, however, an alternative mode of increase in number of individuals, which deals with much larger numbers of potential germs, and involves a much greater complexity of the phases of production than the mere sporophytic budding: it is by means of *spores*. Since this spore-production is a constant feature in the normal life of all Ferns, and

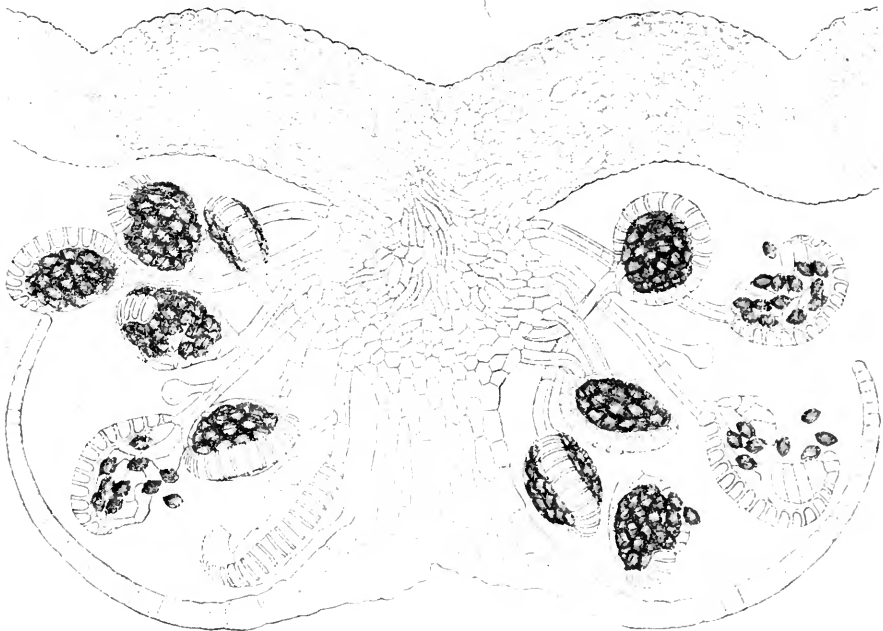

FIG. 4.

Vertical section of the sorus of *Nephrodium Filix-mas*. (After Kay.)

indeed of Archegoniates at large, while sporophytic budding only occurs in relatively few, there is good reason to believe that this was a more primitive and important form of propagation. It therefore demands more serious attention.

An examination of the leaves of the Male Fern will show in many cases, and especially in young plants, merely a smooth, rather pale green under surface: these are then the vegetative leaves, or "*trophophylls*," as they are sometimes called, and they always appear first in the development of the individual. But other leaves of older plants, and especially those formed later in the season, bear on their lower surface, and chiefly near their apical part, numerous roundish patches, which are green or brown according to age: these are the *sori*, and the leaves bearing them

are termed "*sporophylls*," but they do not differ in outline from the vegetative leaves (Fig. 2). The sori are disposed in a single linear series on either side of the midrib of the pinna, or pinnule, being seated on the secondary veins. The kidney-like outline which they present is due to a membranous covering called the indusium, which is protective: it is attached by a central stalk to a projecting cushion of tissue—the receptacle—which is in close connection with the vein, while there is

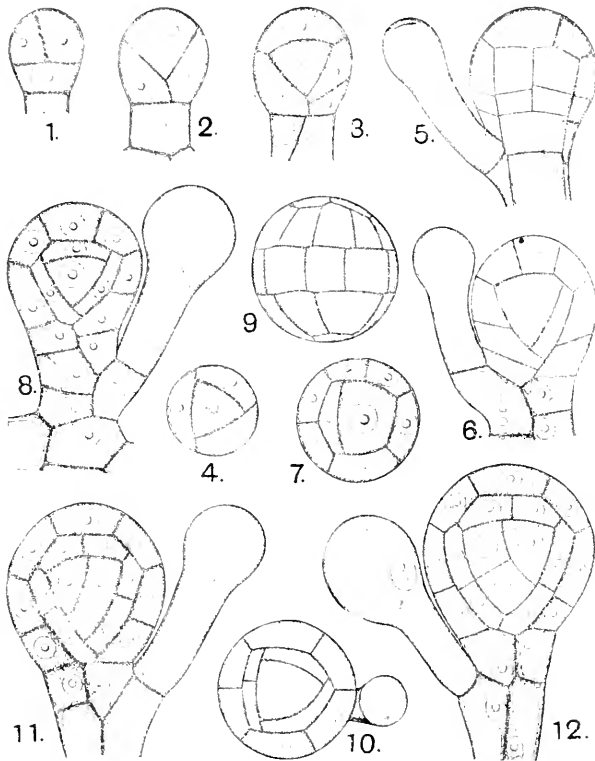

FIG. 5.

Young stages of segmentation of the sporangium of *Nephrodium Filix-mas*. (After Kny.)

a vascular extension from the vein into the receptacle. To the latter are also attached the numerous sporangia, stalked capsules of lenticular form, which are collectively overarched by the umbrella-like indusium. Various stages of development of the sporangia may be found together in the same sorus: those which are younger are smaller, and of pale colour: those which are mature are larger, and are filled with numerous dark brown *spores*: these showing through the more transparent wall give to the ripe sporangium a deep chocolate colour.

In order properly to understand the arrangement of the parts of the sorus it must be cut in vertical section (Fig. 4): it will then be seen

how the indusium, rising from the receptacle, overarches the sporangia, which are also attached to it by long thin stalks. The head of each sporangium is shaped like a biconvex lens: its margin is almost completely surrounded by a series of indurated cells, which form the mechanically effective annulus: this stops short on one side, where several thin-walled cells define the stomium, or point where dehiscence shall take place. Within are the dark-coloured spores, which, on opening a single sporangium

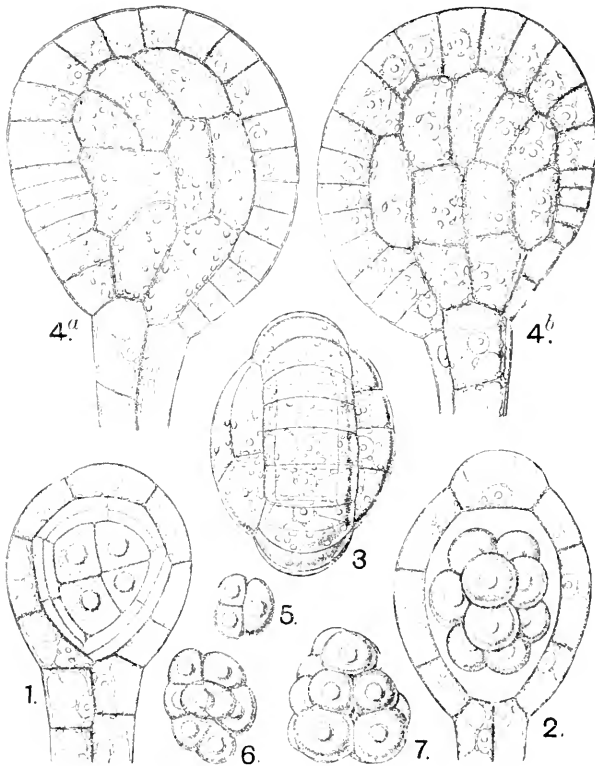

FIG. 6.

Later stages of segmentation of the sporangium of *Nephrodium Filix-mas*. (After Kny.)

carefully in a drop of glycerine, may be counted to the number of approximately 48.

The origin of the sporangium is by outgrowth of a single superficial cell of the receptacle, which undergoes successive segmentations as illustrated in Figs. 5: 1-3. A tetrahedral internal cell is thus completely segmented off from a single layer of superficial cells constituting the wall. The former undergoes further segmentation (Fig. 5: 11, 12) to form a second layer of transitory nutritive cells, called the tapetum, subsequently doubled by tangential fission (Fig. 6: 1). The tetrahedral cell which

still remains at the centre, having grown meanwhile, undergoes successive divisions till usually twelve *spore-mother-cells* are formed (Fig. 6. 2, 6, 7): these become spherical in form, and are suspended in a fluid which, together with the now disorganised tapetum, fills the enlarged cavity of the sporangium. Each spore-mother-cell then divides twice, so as to form a group of four cells, which constitute a *spore-tetrad* (Fig. 7), the component cells showing some differences in their arrangement. Finally, as ripeness is approached the individual cells of the tetrads separate as the *spores*, each of which has meanwhile developed a protecting wall: owing to the absorption of the fluid contents of the sporangium the separate spores are dry and dusty, and readily scattered. Since each of the 12 spore-mother-cells may form four spores their number is $4 \times 12 = 48$ in each sporangium. Each mature spore consists of a protoplast with nucleus, bounded by a colourless inner wall, and a brown epispore, which extends outwards into irregular projecting folds.

Meanwhile the wall of the sporangium has become differentiated into the thinner lateral walls of the lens-shaped head, and the *annulus*, which is a chain of about 16 cells surrounding its margin (Fig 6. 4a, 4b). These constitute a mechanical spring, which on the rupture of the thin-walled stomium becomes slowly everted as the cells dry in the air, and then recovering with a sudden jerk, throws out the spores to a considerable distance (Fig. 8), each individual spore being separate from its neighbours. If a Fern leaf on which the sori are fully matured be laid with its lower surface downwards upon a sheet of paper, and left in dry air for some hours, or if the drying be accelerated by heat, a fine brown dust, consisting of the mature spores, will be deposited on the paper, and they are shed in such vast numbers as to give a natural print of the outline of the leaf. A rough estimate may be made of the numerical output of spores from a large plant of the Shield Fern, as follows. In each sporangium 48 spores may be formed: a sorus will consist of fully 100 sporangia, usually more: 20 is a moderate estimate of the sori on an average pinna: there may be fully 50 fertile pinnae on one well-developed leaf, and a strong plant would bear 10 fertile leaves. $48 \times 100 \times 20 \times 50 \times 10 = 48,000,000$. The output of spores of a strong plant in the single season will thus, on a moderate estimate, approach the enormous number of fifty millions.

As we shall see, each of those spores is capable of acting as the starting-point of a new individual, and yet Male Ferns are not increasing perceptibly in number: the fact is that in open Nature the vast majority of these potential germs do not survive the vicissitudes of early life. It is evident, however, that the maintenance of the race is very fully provided for, while there is an ample margin for the effect of selection of those fittest to survive.

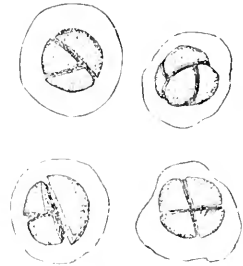

FIG. 7.

Spore-tetrads of *Polypodium vulgare*. (After Atkinson.)

In this connection it is well to note further that the spores are produced upon the leaves fully exposed to the air, and that dry circumstances favour the shedding of the spores: Ferns grown in uniformly moist conditions show how essential a dry period actually is, for their sporangia often do not burst at all. The spores of *Todea* and of some Hymenophyllaceae may even be seen germinating within the sporangium. Such

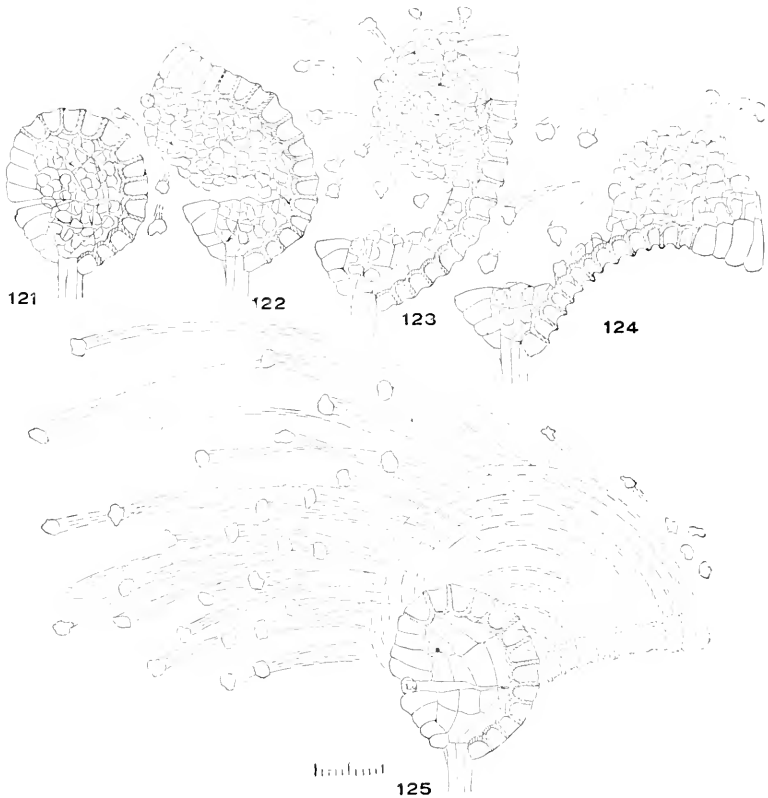

FIG. 5.

Dispersion of the spores from sporangium of *Aspidium acrostichoides*, showing different stages of the eversion and snapping of the annulus. (After Atkinson.)

a condition is obviously of no advantage to the plant, and is to be looked upon as a failure in the normal action of the annulus. We thus see that a relatively dry period, such as the Male Fern is able to undergo in summer, is a normal state, and indeed essential for the last phase of spore-production, viz. the dissemination of the numerous living germs.

But the relatively dry conditions which lead up to and are necessary for the dissemination of the spores do not suffice for their further development: in order that they may germinate moisture is required, as it is also throughout the immediately succeeding stages of life. When

exposed to suitable conditions of moisture and temperature each spore may germinate: the outer coat bursts, and the inner protrudes and increases in size, cell-divisions appearing as the growth proceeds. The body which is thus produced is called the *prothallus*, and it may vary in its form according to the circumstances. In average cases of not too crowded culture it usually takes first a short filamentous form, attached by one or more rhizoids to the soil (Fig. 9. 4): it then widens out at the tip

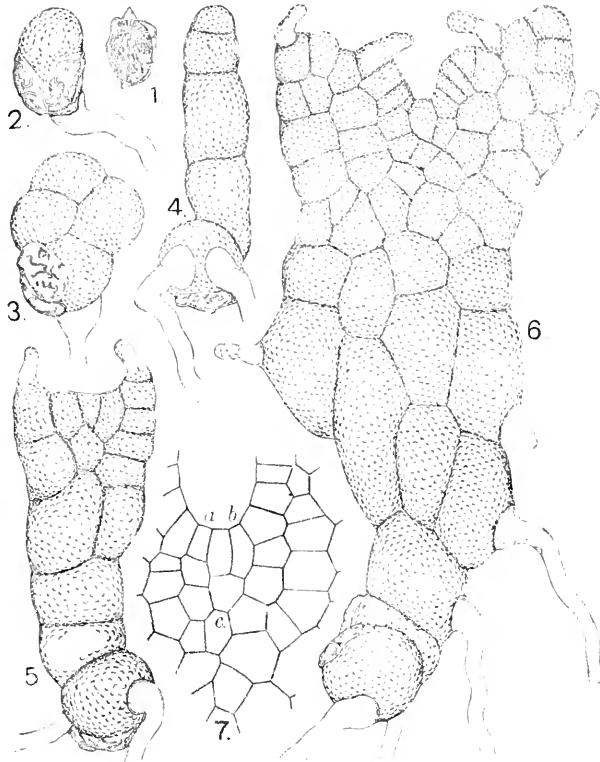

FIG. 9.

Germination of the spore in *Nephrodium Filix-mas.* and early stages of the prothallus.
(After Kny.)

to a spatula-like, and finally to a cordate form (Fig. 9. 5 and 6). This is the usual type, but when crowded closely together, the filamentous form may be longer retained, and prothalli are then of the type shown in Fig. 11. 1. It is thus seen that the form of the prothallus is plastic, a fact which may be brought into further prominence by culture under various conditions of lighting, etc.

The body of the prothallus, exclusive of the downward growing rhizoids, consists of cells which are essentially alike, arranged at first in a single-layered sheet. This simple structure is maintained permanently by the

peripheral parts, but in the central region, below the emarginate apex, the cells divide by walls parallel to the flattened surfaces of the prothallus, and thus form a somewhat massive central cushion. The mature cells are thin-walled, with a peripheral film of cytoplasm surrounding a large central vacuole, and embedding the nucleus and numerous chloroplasts. The whole body is capable of leading an independent existence, nourishing itself by absorption from the soil, and by photosynthesis (Fig. 10).

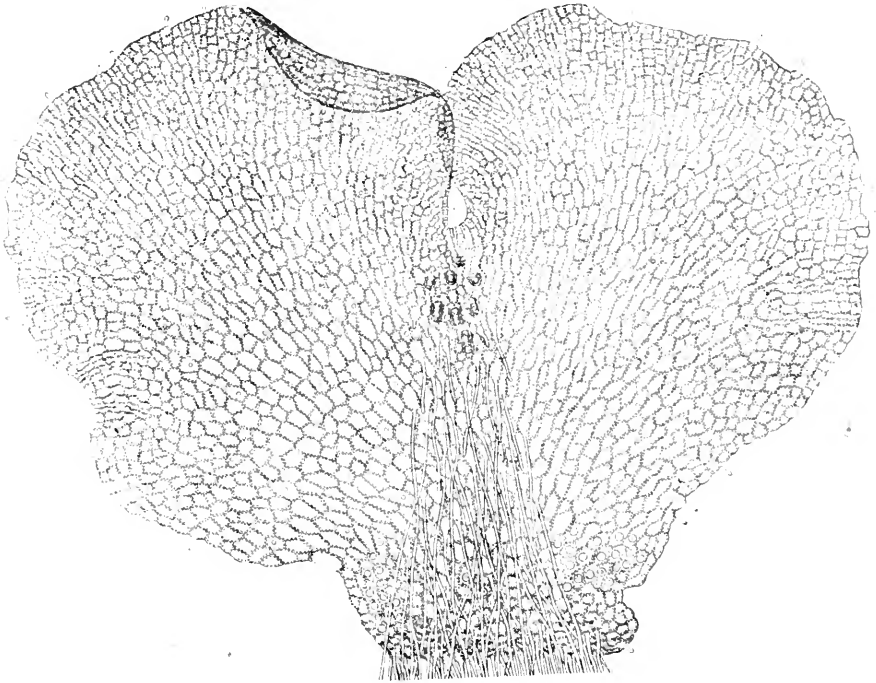

FIG. 10.

Mature prothallus of *Vephusium Filix-mas*, as seen from below, bearing antheridia and archegonia. (After Kny.)

Its structure at once suggests dependence on a continuous and efficient water-supply; for there is a large proportion of surface to bulk, while the cell-walls are thin, and the vacuole-contents voluminous. There is no arrangement to offer serious resistance to evaporation of water in dry air. As a matter of experience prothalli shrivel readily when exposed to dry conditions, while in Nature they are regularly found in moist and protected positions; a fact which goes far to determine the habitat also of the sporophytes which arise from them, and this cannot fail to act as a substantial check upon the distribution of Ferns. But shrivelling under drought does not necessarily involve death; in certain cases at least only a temporary arrest of activity is the consequence, and prothalli which have

been thus dormant for a considerable time have been seen to revive when soaked out, and to continue their growth. They share in some measure that faculty which is so important to many Bryophyta, of recovery after dormancy under drought. Comparing the prothallus with the Fern-Plant as regards the water-relation, it is plainly less adapted for life on exposed land-surfaces, and more immediately dependent on moisture.

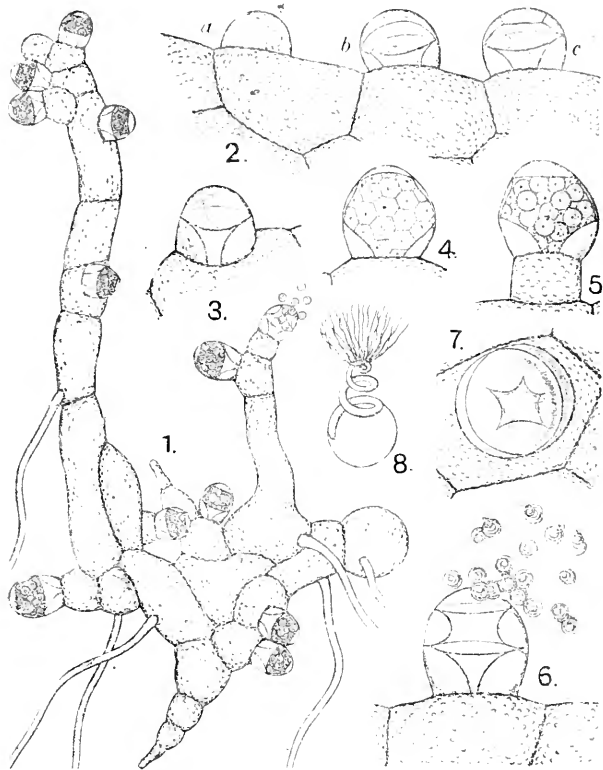

FIG. 11.

1. An attenuated male prothallus of *Nephrodium Filix-mas*; 2-5. stages of development of antheridia; 6, 7. ruptured antheridia; 8. a spermatozoid. (After Kn

The prothallus thus constituted is capable in some cases of vegetative propagation, by gemmae, and other forms of "gametophytic budding," but this does not occur in the Male Fern.

Though the close dependence on moisture for functional activity is thus seen in the prothallus, it is much more obvious in the behaviour of the sexual organs which the prothallus bears. These in the Male Shield Fern¹ are commonly borne, male and female, on the same individual

¹It is hardly necessary to say that the "Male" Fern is a misnomer, surviving from the misconceptions of earlier times. The Fern-Plant is neutral, being neither male nor female, while it is on the prothallus that the sexual organs are borne.

(Fig. 10): but conditions of crowded culture may lead towards a partial, or even complete separation of the sexes. The flattened hermaphroditic prothallus of the ordinary cordate outline, grown under normal circumstances of moisture and moderate lighting, on a horizontal substratum, lies with one of its flattened surfaces facing the substratum, and produces upon that lower surface antheridia and archegonia, the former in the basal or lateral regions, the latter upon the massive cushion: here they develop in acropetal succession, the youngest being nearest to the emarginate apex of the thallus. This position of the sexual organs is evidently favourable to their continued exposure to moist air, or even fluid water: and indeed the latter is necessary for the completion of their function.

The antheridium, which arises by outgrowth and segmentation of a single superficial cell, consists when mature of a peripheral wall of tabular

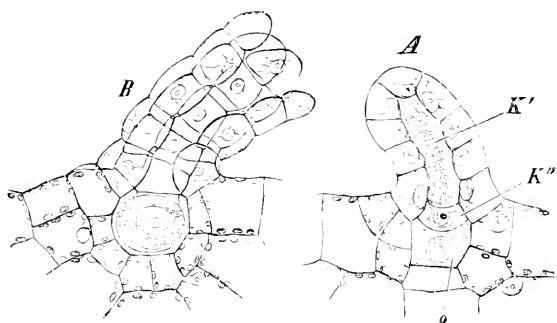

FIG. 12.

Archegonia of *Polygodium vulgare*. *A*, still closed: *o*=ovum. *K'*=canal-cell. *K''*=ventral-canal-cell. *B*, an archegonium ruptured. $\times 240$. (After Strasburger.)

cells, surrounding a central group of spermatocytes (Fig. 11. 4, 5). The antheridium readily matures in moist air, but does not open except in the presence of external fluid water: this causes swelling of the mucilaginous walls of the spermatocytes, and increased turgor of the cells of the wall: the tension is relieved by rupture of the cell covering the distal end, and the spermatocytes are extruded into the water, the cells of the wall assisting by their swelling inwards, and consequent shortening (Fig. 11. 6). The spermatocytes, thus extruded into the water which caused the rupture, soon show active movement, and the spermatozoid which had already been formed within each of them escapes from its mucilaginous sheath, and moves freely in the water by means of active cilia attached near one end of its spirally coiled body (Fig. 11. 6 and 8).

The archegonium also originates from a single superficial cell, and grows out so as to project from the downward surface of the thallus. It consists when mature of a peripheral wall of cells constituting the projecting neck, and a central group, arranged serially: the deepest seated of these is the large ovum, which is sunk in the tissue of the cushion, and above this is a small ventral-canal-cell, and a longer canal-cell

(Fig. 12, A). If prothalli be grown in moist air, and only watered by absorption from below, the archegonia will have no access to fluid water,



FIG. 13.

Fertilisation in *Oenochla sensibilis*: the arrows indicate direction of the growing point of the prothallium. A, vertical section through an open archegonium probably within ten minutes after the entrance of the first spermatozoid. $\times 500$. B, vertical section of the venter of an archegonium containing spermatozooids, and the collapsed egg with a spermatozoid within the nucleus. Thirty minutes. $\times 1200$. (After Shaw.)

and they will then remain closed, and fertilisation will be impossible: but if watered from above, as they would be in the ordinary course of Nature, the external fluid water will bathe them, and rupture will result. This may be observed in living archegonia which have been kept relatively dry, and then mounted in water under the microscope: the neck dehisces at the distal end owing to internal mucilaginous swelling, and its cells diverge widely: the canal-cell and ventral-canal-cell are extruded, and the ovum remains as a deeply seated, spherical protoplast, while access to it is gained through the open channel of the neck (Fig. 12, B). Thus the same conditions lead to the rupture both of the male and female organs: in Nature a shower of rain would supply the necessary external fluid water, and would at the same time supply the

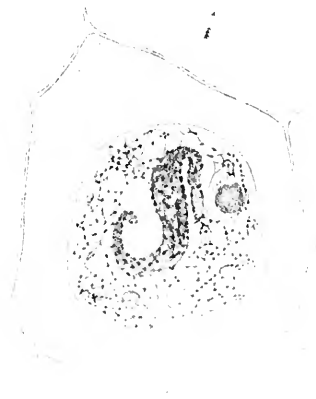

FIG. 13 bis.

Horizontal section of an egg, showing coiled spiral male nucleus within the female. Twelve hours. $\times 1200$. (After Shaw.)

medium of transit of the spermatozoids to the ovum. But the movements of the spermatozoids are not subject to blind chance: the chemiotactic attraction of the archegonium directs the spermatozoids through the water, towards the open neck, which they may be seen to enter, and finally one of the spermatozoids coalesces with the ovum: fertilisation is effected

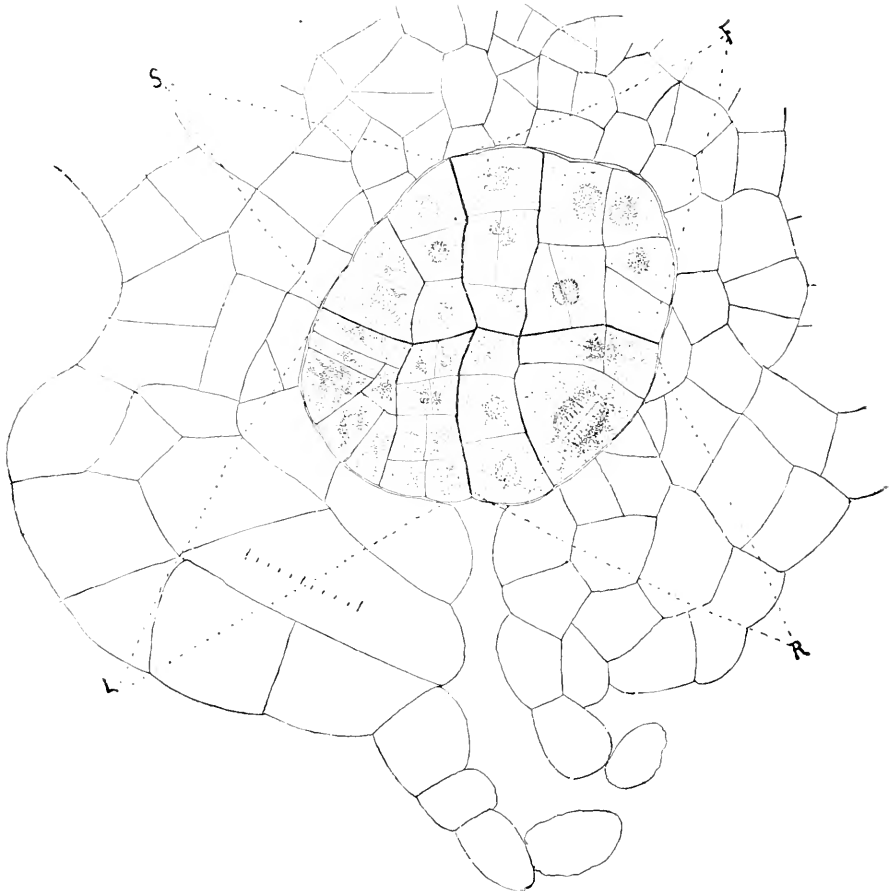

FIG. 14.

Young embryo of *Adiantum concinnum*. L = leaf-quadrant; S = stem-quadrant;
R = root-quadrant; F = foot-quadrant. (After Atkinson.)

by the absorption of the male nucleus in that of the egg (Figs. 13 and 13 bis). Thus the presence of external fluid water is essential for the process of fertilisation: without it the prothallus is unable to achieve that object of its existence.

The consequence of fertilisation is the growth and segmentation of the ovum, or zygote, as it may now be called, to form a mass of embryonic tissue, which at first remains embedded in the tissue of the

parent thallus (Fig 14): as it grows, leaf, stem, and root become differentiated (Fig. 15), which finally emerge: at first the embryo Fern-Plant is dependent for its nourishment upon the prothallus which embeds it; but as the first leaf expands it begins to exercise the assimilating function, which is taken up also by the later formed leaves. The first root also projects into the soil, and soon functionates as an absorbing organ: it is followed later by others. Thus the young plant soon becomes physiologically independent of the prothallus, which rots away,



FIG. 15.

Embryo of *Adiantum concinnum*, older than that in Fig. 14. L=leaf; R=root; S=stem; F=foot. (After Atkinson.)

leaving the young plant established on the soil. It gradually attains the mature characters similar to those of the parent from which it originated.

The above is a bare statement of the salient events in the life-cycle, or ontogenetic period of a Fern, as it is seen in its simplest form: and, the adjoining diagram may serve to present them graphically to the eye (Fig. 16). The two most notable points are those where the new individual is represented by a single cell, viz. the spore, and the fertilised ovum, or zygote. These are two landmarks between which intervene two more extensive developments, on the one hand the sexual generation, or prothallus, on the other the spore-bearing generation, or

Fern-Plant. If the events above detailed recur in regular succession there will be seen a regular alternation of two phases of life, or generations: of these the one, the prothallus, bears the sexual organs, which contain the sexual cells or gametes, and it may accordingly be styled the *gametophyte*: the other, the Fern-Plant, is non-sexual or neutral, and bears the sporangia, containing the spores: accordingly it may be styled the *sporophyte*. The study of Ferns at large leads to the conclusion that this

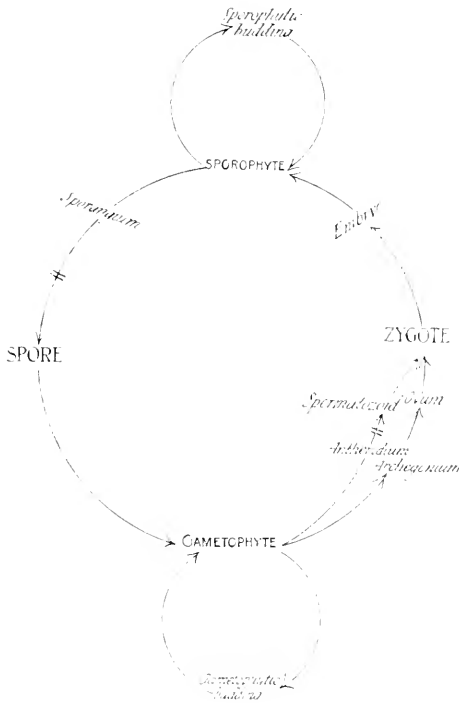

FIG. 16.

Scheme of life-cycle of a Fern.

regular alternation of generations is typical for the family. These two alternating generations differ not only in form, but also in their relation to external circumstances, and especially in the water-relation. The sporophyte is structurally a land-growing plant, with nutritive, mechanical, and conducting tissues, and a ventilating system: not only is it capable of undergoing free exposure to the ordinary atmospheric conditions, but dryness of the air is essential for the final end of its existence, viz. the distribution of the spores. On the other hand, the gametophyte is structurally a plant ill-fitted for exposure, with undifferentiated and ill-protected tissues, and no ventilating system. While the object of its existence, viz. the fertilisation carried out by the sexual organs, can only be achieved in the presence of external fluid water.

There is thus a marked difference between these two phases, and their sequence may be said to constitute an *antithetic alternation*. As regards the water-relation, the whole life-cycle of the Fern might not inaptly be designated as *amphibious*, since the one phase is dependent on external fluid water for achieving its object of propagation, while the other is independent of it.

It will be seen in the next chapter that this is not a condition for Ferns alone, but that such alternation as is seen here has its parallel in many other plants, though with great differences in detail, and especially in respect of the balance of size of the two generations.

CHAPTER III.

ON THE BALANCE OF THE ALTERNATING GENERATIONS OF ARCHEGONIATAE.

HOFMEISTER'S great work on the Higher Cryptogamia, alluded to in the previous chapter, was not a mere description of observations, but a comparative treatise. It not only revealed the life-stories of the various types of plant-organisation which he examined, but in it he also showed that their several stages corresponded in essential features. Notwithstanding wide differences of detailed form and of proportion, it was demonstrated that, as regards position among the recurrent events of each life-cycle, the neutral generation, or sporophyte, and the sexual generation, or gametophyte, remained distinct and recognisable in such diverse plants as the Bryophytes, Pteridophytes, and Gymnosperms. In arriving at this conclusion it was Hofmeister's great merit that he kept his eye securely upon those critical points where the individual life is represented by a single cell, viz. the zygote, and the spore. However differing in size or in complexity, he held as comparable, or, as it is said, "homologous," the phases which intervened respectively between those two events. This great generalisation of Hofmeister, stated by him with a brevity and a simplicity of language as remarkable as its content was new and far-reaching, has formed the essential foundation of all subsequent morphology of Archegoniate Plants. A series of examples will now be quoted in illustration of it, and these will be selected to show the differences in form and in the relative proportions of the two generations; but it will not be necessary to enter into a continuous account of the life of each example, for with certain modifications the essentials of sexuality and of spore-production remain the same in them all.

In *Riccia*, one of the simplest of the Liverworts, the gametophyte, or *Riccia*-plant, as it is called on account of its being more prominent than the sporophyte, is a green, dichotomously branched thallus, showing localised apical growth, while it is thick in proportion to its area: some species float on water, others are attached by rhizoids to the substratum of soil. The

only appendages other than rhizoids and occasional hairs are small flat scales borne on the lower surface. The gametophyte is thus of very simple form (Fig. 17). The sexual organs are borne in acropetal succession on its upper surface, and are sunk in depressions. The sporophyte, which results from fertilisation of the ovum by spermatozoids motile through water as in Ferns, is a small spherical body, with no distinction of apex and base (Fig. 18). It consists of a single layer of cells forming a peripheral wall, which is, however, disorganised before the ripeness of the spores. The latter are produced by a tetrad division of the spore-mother-cells, which occupy the whole internal space of the sporogonium (Fig. 18A): on germination the spores yield fresh gametophytes. Thus the two generations are here as distinct from one another, structurally and in origin, as in the Fern, though both are of small size and simple form. It is to be noted, however, that the sporophyte is throughout its life dependent

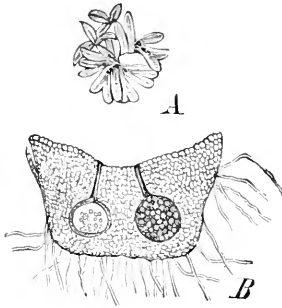

FIG. 17.

Riccia minima. A, thallus of natural size. B, the same in vertical section, showing two sporogonia sunk in the tissue of the thallus. Magnified. (After Bischoff.)

Fern, though both are of small size and simple form. It is to be noted, however, that the sporophyte is throughout its life dependent

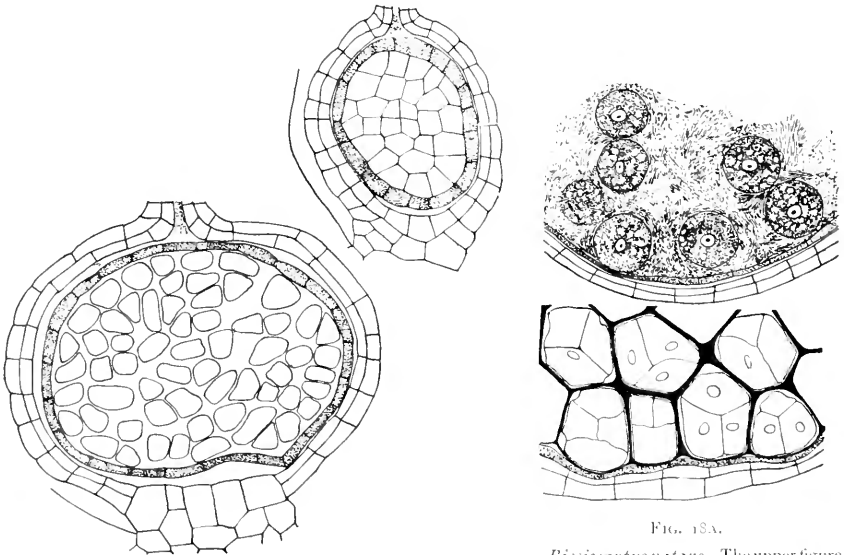

FIG. 18A.

Riccioarpus natans. Young sporogonia in longitudinal section, surrounded by the archegonial wall. The younger ($\times 666$) shows the amphithecium (shaded) surrounding the sporogenous cells: in the older ($\times 500$) these are separated, as the free, and rounded spore-mother-cells. (After Garber.)

Riccioarpus natans. The upper figure shows the spherical spore-mother-cells surrounded by nutritive material. The lower shows the tetrads formed from them: the sporogonial wall (shaded) is still seen surrounding them, and covered externally by the archegonial wall of two cell-layers. $\times 666$. (After Garber.)

upon the gametophyte, both mechanically and physiologically, and that it is an almost entirely undifferentiated, spore-producing body.

Taking *Catharinea undulata* (L.), Web. and Mohr, as an example of the condition commonly seen in Mosses, the gametophyte and sporophyte are both on a more advanced scale than in *Riccia*, and both show localised apical growth, but their relations remain substantially the same. The "Moss



FIG. 19.

Catharinea (Atrichum) undulata (L.), Web. and Mohr. The leafy gametophyte, bearing sporogonia. (After Schimper.)

Plant," or gametophyte (Fig. 19) appears as an upgrowing, branched, and leafy structure, attached to the soil by numerous rhizoids, and nourishing itself partly from materials absorbed by them, partly by the activity of its chlorophyll-containing shoots: it is thus physiologically an independent organism, as is also the simpler thallus of *Riccia*.³ In most Mosses the plant is ill protected against drought: but they commonly show, as a set

off against this, a remarkable power of recovery on the return of moisture after being dried up. The sexual organs are usually borne by the Moss-Plant at or near to the apex of its upward-growing branches. The result of fertilisation—here again carried out by spermatozoids motile through water—is the formation of the Moss-Fruit, or sporophyte, which is throughout life a mere appendage on the Moss-Plant. At first it is, like that of *Riccia*, completely enclosed by the venter of the archegonium (Fig. 20); but it soon shows apical growth and elongation: the venter is then ruptured transversely, and the sporogonium is exposed. As it elongates its base remains embedded in the tissue of the Moss-Plant: its apex is still covered by the upper part of the archegonial wall, the calyptra; but at ripeness this is shed, and the enlarged capsule on dehiscence is able freely to scatter its spores. After this the ephemeral sporophyte dies away.

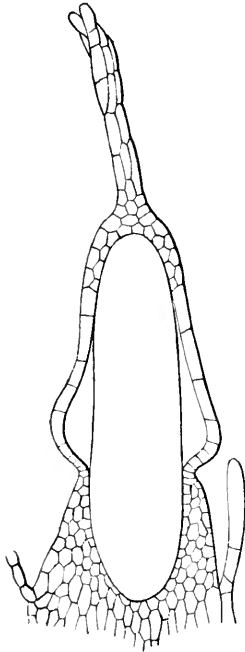

FIG. 20.

Young sporogonium of *Physcomitrella patens*, Br. and Sch., shortly before the rupture of the archegonial wall. (After Hy.)

Comparing such a Moss with *Riccia*, the phases of the life-history correspond, but their elaboration is different: the thalloid gametophyte of *Riccia* is replaced by the upright leafy plant of *Catharinea*. The fertilisation is still dependent on fluid water, but its product is more complex: there is in *Catharinea* a distinction of apex and base, with localised apical growth; but the form is still relatively simple, the whole construction being on the radial type, without appendages. The spore-production is restricted to the upper region, and takes place in one continuous sac. The sporophyte is still borne and nourished throughout its life by the parent gametophyte; but it is able by its chlorophyll-containing cells to carry on photosynthesis in some degree, as an accessory to the supply derived from the parent. It has a ventilating system like that characteristic of aerial plants, while this is absent from the gametophyte.

A comparison of such a Moss with a Lycopod shows a different balance of the two alternating generations. The gametophyte of *Lycopodium cernuum* is shown in Fig. 21 as a somewhat massive structure, bearing lobes of chlorophyll-containing tissue above, which have sometimes been compared with the leaves of a Bryophyte: below it is attached by rhizoids to the soil. Like the Moss it is an independent organism capable of self-nourishment. It bears its sexual organs about the bases of the lobes, and is dependent upon external fluid water for its fertilisation. Notwithstanding its massive bulk it is without a ventilating system. The

sporophyte of *L. cernuum*, on the other hand, is a large dendroid plant, which may attain a height of even 3-4 feet (Fig. 22). In the embryo state it is nourished by the gametophyte which bore it, but it soon establishes itself independently in the soil as a much-branched plant, with relatively massive axes showing localised apical growth and numerous small leaves; while true roots, not mere rhizoids, ramify in the soil. The whole plant is traversed by a vascular system, and there is also an efficient ventilating system. This ample vegetative development precedes the formation of the spores, which is localised in the terminal strobili:



FIG. 21.

Young leafy plant of *Lycopodium cernuum*, L., with the prothallus, bearing its irregular assimilating lobes, attached on its left-hand side. \times about 20. (After Treub.)

these do not differ in general plan from the vegetative shoots, but in the axil of each leaf of these fertile branches a single sporangium is borne, containing many small spores, which are all alike (Fig. 22 D, E).

The gametophyte of *Lycopodium* is among the most elaborate known in Vascular Plants: and yet it falls short of the complexity seen in the plant of *Catharinaea*. It is clear that the two correspond from the fact that they both arise from spores and bear sexual organs. On the other hand, the proportion of the sporophyte, as well as its conformation, differs in high degree in the two plants. In place of the dependent and ephemeral sporogonium, with limited apical growth, without appendages, and bearing a single terminal capsule of spores, as in the Moss, *Lycopodium* shows an independent and perennial plant, with apparently unlimited apical growth and numerous appendages: it is rooted in

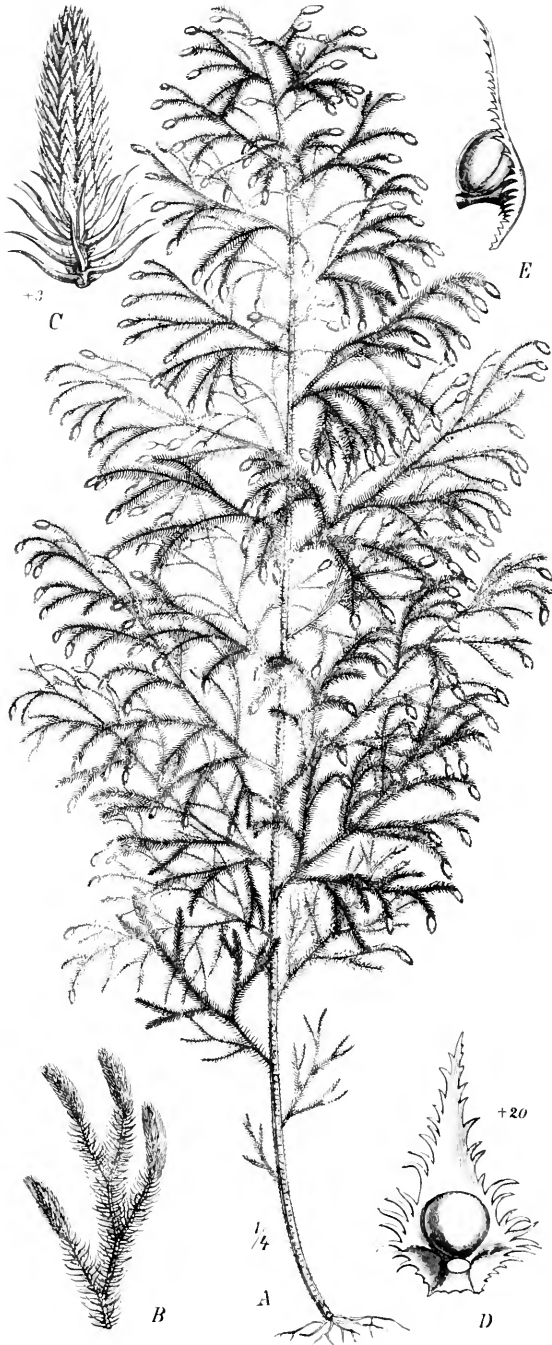

FIG. 22.

Lycopodium zernuum, L., var. *Kühleri*, Glaz. A, general habit ($\frac{1}{4}$ natural size); B, end of a branch (natural size); C, strobilus ($\times 3$); D, sporophyll seen from above; E, ditto, from the side ($\times 20$). (After Pritzl, in Engler and Prantl, *Nat. Pflanz.*)

the soil, and capable of complete self-nourishment for an extended period before the production of spores. Moreover, these are produced, not in a single sac, as in the Moss, but in very numerous distinct sacs--the sporangia. These essential differences of the sporophyte are those which clearly define the Bryophytes from the Pteridophytes. In the latter the mature sporophyte is always a free-growing organism, and a considerable vegetative period usually precedes the formation of the spores.

Referring back to our observations on the Male Fern in the previous chapter, it will be seen that these remarks apply there also. The most obvious difference between a Lycopod and a Fern is in the size of the leaf; but they correspond in all essentials, and both show a very marked advance of complexity of the sporophyte over the Bryophyte sporogonium. On the other hand, the prothallus of the Fern is a smaller and simpler thing than that of *L. cerneum*, and stands thus in still stronger antithesis to the leafy plant of the Moss. Putting all these points together, it is plain that in the Pteridophytes the balance in size of the generations is inverted as compared with that in the higher Bryophytes.

In all the Bryophytes, and also in many Pteridophytes, the spores are all alike, and of small size, as we have seen them to be in *Nephrodium* and *Lycopodium*: this is described as the "homosporous" condition, and it may be accepted as a primitive state. But in certain other Pteridophytes, and in all Seed-Plants, there are two different types of spore:--the relatively small spore, which is easily transferred when shed, and produces a small male prothallus; and the large spore which, though less easily transferred, develops within it what is so important to the progeny--a bulky female prothallus stored with nutriment. This store is derived from the parent plant, and is thus ready to supply the young immediately after fertilisation. The "heterosporous" condition brings a clear advantage, notwithstanding that the separation of the sexes on different prothalli increases the obstacles in the way of fertilisation being carried out. In certain cases the two types of sporangia and spores start their development alike, and only differentiate in the later stages; for this reason, as well as on grounds of general comparison, the heterosporous state may be accepted as the later and derivative. From the example of *Selaginella* it will be seen

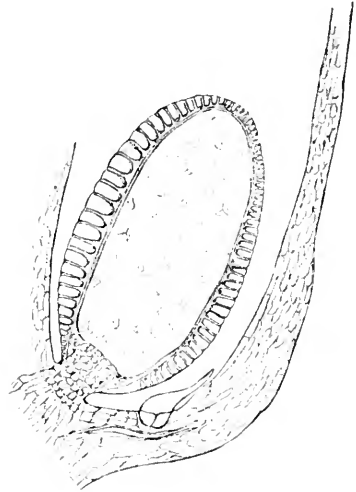

FIG. 23.

Microsporangium of *Selaginella apus* in median vertical section. $\times 55$. (After Miss Lyon.)

that heterospory may occur without any essential change in the sporophyte; for the plant of *Selaginella* is of the general Lycopod type, with small-leaved, much-branched shoot rooted in the soil, showing

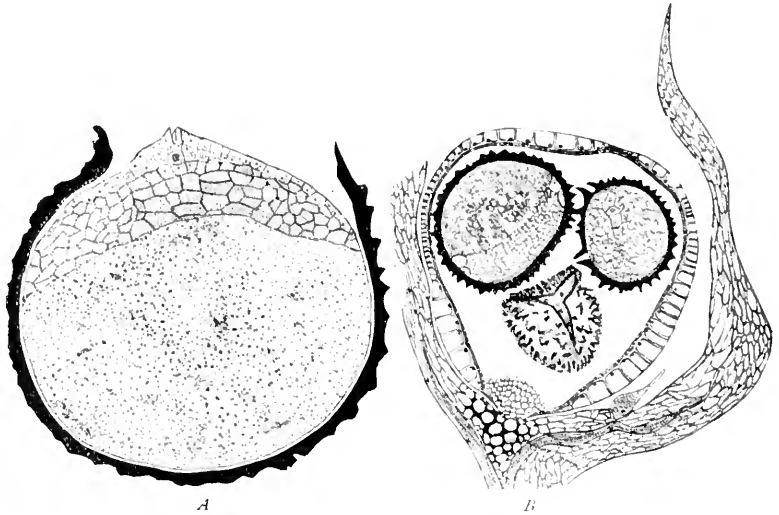

FIG. 24.

B, megasporangium of *Selaginella apus* in median vertical section, showing three of the four megaspores. $\times 21$. *A*, a single megaspore, with prothallus and an archegonium, more highly magnified. (After Miss Lyon.)

continued apical growth and terminal strobili. These are constructed essentially upon the Lycopodinous plan, but instead of the sporangia being all alike, some contain numerous small microspores, others contain

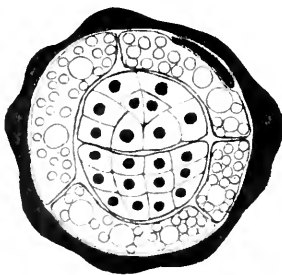

FIG. 25.

Microspore of *Selaginella apus*, after germination. (After Miss Lyon.)

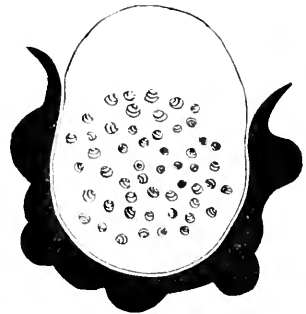

FIG. 26.

Microspore of *Selaginella apus*, just before extrusion of the spermatozooids. (After Miss Lyon.)

only four large megaspores. In both cases these result, like other spores, from a tetrad division: the chief difference is in their size (Figs. 23, 24 B).

But though the sporophyte is essentially unaltered, the changes in the gametophyte which accompany the heterosporous state are important. The prothallus is no longer a free-growing, self-nourishing organism, but it

tends to become, and often actually is, a mere means of working up the material stored in the mature spore into gametes and an embryo, and does not possess any functional vegetative system. This is exemplified in Figs. 25, 26 of *Selaginella*, which show the contents of the germinated microspore developed as little more than an antheridium. In Fig. 26 the wall of the spore is ruptured, and the contents are ready to be extruded as numerous spermatozoids. Fig. 24 A shows the megaspore with the female prothallus within it, bearing an archegonium. Fertilisation takes place as in Ferns through the medium of water. The ovum after fertilisation forms the embryo which remains for a time embedded in the prothallus: but later it bursts through, and establishes itself as the independent sporophyte.

In many heterosporous plants the germination takes place after the spores are shed, just as is the case in homosporous plants. But in others germination of the megaspore may be initiated or even carried through within the sporangium. This is the case in *Selaginella apus* (Fig. 24), in which it is evident that, even when the sporangium has not yet opened, the prothallus may be well advanced in the megaspores.

Fertilisation may be carried out within the sporangium after its rupture, by means of spermatozoids derived from spores shed from adjoining microsporangia,

and the embryo may be developed while the megaspore is still within the sporangium. It is no great step from this condition to that seen in the Seed-Plants, in which the megaspore—or embryo-sac as it is called in Seed-Plants—remains embedded in the tissue of the megasporangium or ovule (Fig. 27). The physiological advantage gained by this step is an important one: there is no longer any need to hurriedly pass the nutritive supplies into the spore before its wall, thickened for protective purposes, stops the process of transfer; for in the Seed-Plants the wall of the megaspore, no longer needed for protection, remains thin, and the nutrition of the female prothallus can be continued until long after the embryo is initiated within it.

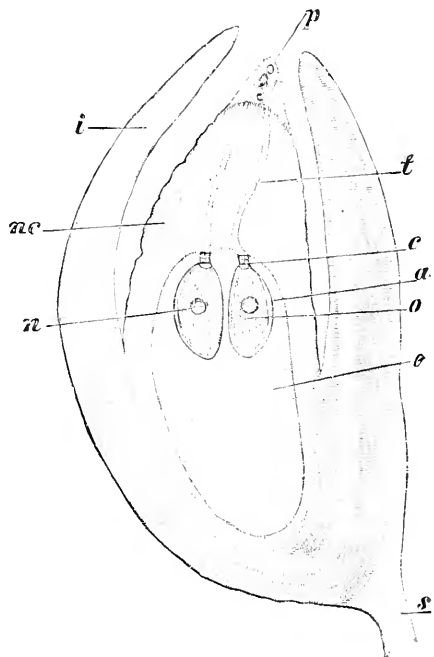

FIG. 27.

Median longitudinal section of the ovule of *Picea excelsa*, at time of fertilisation $\times 9$. *e*, embryo-sac filled by the prothallus; *a*, the venter; *c*, the neck of an archegonium; *o*, ovum; *n*, its nucleus; *nc*, nucellus of ovule; *p*, pollen-grains; *t*, pollen-tubes; *i*, integument. (After Strasburger.)

These points are illustrated in the Gymnosperms, which the positive evidence of the geological record shows to have been the primitive Seed-Plants. Since the time of Hofmeister comparative morphology has arrived

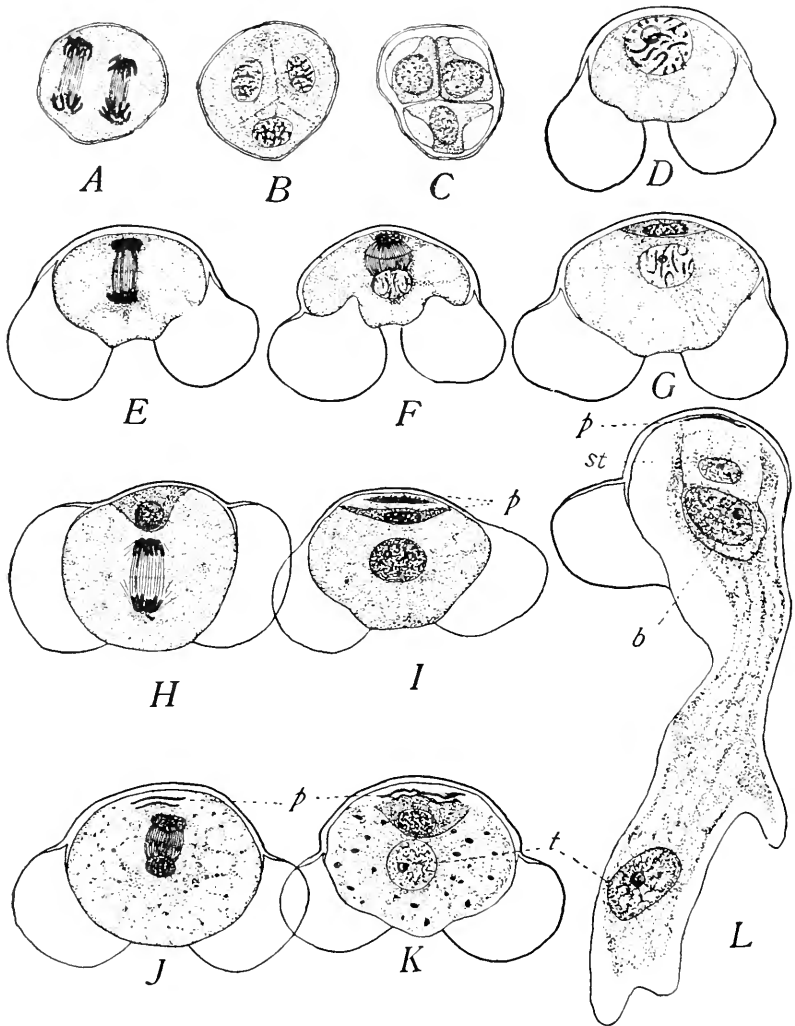

FIG. 25.

Pinus Laricio, showing a series from the formation of the tetrads to the development of the pollen-tube. *p*, vegetative cells; *st*, stalk cell; *b*, body cell; *t*, tube nucleus. $\times 600$. (After Coulter and Chamberlain.)

at the same conclusion, though along a distinct line of argument. Taking examples from the Pinaceae, the sporophyte is represented by the Tree, which is a large, much-branched, independent, and perennial organism, with theoretically unlimited apical growth, and a highly differentiated

system of root and shoot. A long vegetative period precedes the spore-formation. The sporangia are no longer alike as in *Selaginella*, but differ widely in form and position, and are located on distinct male and female strobili. The microsporangia, or pollen-sacs, produce after the usual tetrad division the microspores, or pollen-grains, which are shed at maturity. The male prothallus which they produce is partly formed on the parent plant, partly after shedding, and is restricted merely to a few cells (Fig. 28). Typically the megasporangia, or ovules, develop each only a single megaspore—or embryo-sac as it is called in Seed-Plants—and within it there is at the period of fertilisation a massive female prothallus, bearing archegonia (Fig. 27). Since the male and female strobili are distinct, it is necessary for fertilisation that the microspores, or pollen-grains, should be shed; but no independent vegetative thallus is produced from them: the pollen-grain, landing on the apex of the megasporangium, forms a pollen tube or siphon, which penetrates the sporangial wall, and by its means the non-motile male cells are transferred to the ovum. The essential point of fertilisation is the same as before, but the means are different. The dependence on external fluid water, characteristic of all Pteridophytes, is dropped, and the siphonogamic method of fertilisation may be held to mark the distinctive terrestrial habit. But as a lately acquired proof of the justice of Hofmeister's comparisons, the fertilisation by a motile spermatozoid is still retained, in a somewhat unpractical form, in certain primitive Gymnosperms, Cycadaceae, and Ginkgoaceae. The nursing of the embryo in the female prothallus, or endosperm, follows in the Pine on essentially similar lines as in *Selaginella*, also the final germination to establish again the independent sporophyte.

Lastly, in the higher Seed-Plants, or Angiosperms, which Palaeontology indicates as of later origin, the outline of the life-cycle is as in the Gymnosperms, but with still further reduction of the prothallial development in the pollen-grain (Fig. 29). Fertilisation is of the terrestrial siphonogamic type. The embryo-sac remains like that of Gymnosperms embedded in the tissue of the parent plant: it contains before fertilisation only an exiguous tissue-development, the exact homology of which is still a question in debate (Fig. 30).

The above sketch illustrates the general trend, though probably not the exact course, of evolutionary progress in the Archegoniate series. But it is necessary to remark that the examples selected do not form any actual phyletic sequence: of them all no two (excepting *Lycopodium* and *Selaginella*) belong to a single recognised phylum. The general result of their comparison is therefore a history read between the lines. But, with this proviso, the following conclusions may be drawn from it, as to the

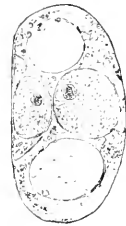

FIG. 29.

Tradescantia virginica.
Pollen-grain, showing the division into an antheridial and a vegetative cell. $\times 540$.
(After Strasburger.)

fluctuations of balance of the two generations of the antithetic alternation involved in the upward progress of plant-form.

The gametophyte was at first the predominant feature, and there is good reason, as we shall see later, to believe that it was the originally pre-existent phase. It was an independent, self-nourishing organism, with unlimited apical growth, and is seen in the Bryophytes either in the thalloid form, or developed as a more elaborate leafy plant. In

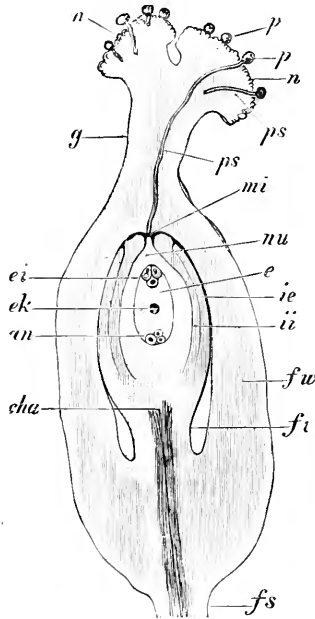

FIG. 30.

Ovary of *Polygonum convolvulus* during fertilisation. *fs*, stalk-like base of ovary; *fu*, tuniculus; *cha*, chakaza; *nu*, nucellus; *mi*, micropyle; *ti*, inner; *te*, outer integument; *e*, embryo-sac; *ek*, nucleus of embryo-sac; *ei*, egg-apparatus; *an*, antipodal cells; *s*, style; *st*, stigma; *p*, pollen-grains; *ps*, pollen-tubes. $\times 48$. (After Strasburger.)

the Mosses, and in the leafy Liverworts the sexual generation reached its morphological climax. But nevertheless in the relative simplicity of its tissues, and in the absence of an internal ventilating system, it remained, as its method of sexuality proclaims it to be, at best only an imperfect adaptation to growth under conditions of subaerial exposure. In the homosporous Pteridophytes, though there is in *Lycopodium*, and also in *Equisetum*, some indication of lateral appendages, the gametophyte is thalloid, but it still shows its physiological independence, while there may be a brief and ill-defined apical growth. Nevertheless, in the Pteridophytes the gametophyte as a rule bears the stamp of a temporary phase in the cycle rather than that of a permanent organism: but this becomes much more pronounced in the heterosporous forms: in these the independent, self-nutritive existence is lost, and the prothallus is without localised apical growth: the male gametophyte becomes little more physiologically than a means of producing spermatozoids: the female is at first a producer of ova, and later it is simply a means of nourishing the embryo at second hand from the plant on which it is dependent.

The morphological reduction which follows the heterosporous state is clear enough in *Selaginella* and in the Pine, and it reaches its climax in the Higher Flowering Plants, where the gametophyte is found to have dwindled away to an exiguous residuum of a few ill-defined cells, with virtually no vegetative characters at all. The whole story indicates the eclipse of the generation which appears to have been originally the predominant partner in the life-cycle.

The sporophyte, on the other hand, has a complementary story. It is seen in the simplest Bryophytes as an ephemeral, spherical body, without distinct apex or base, and no vegetative system except a temporary

protective wall of cells: it is dependent through life upon the gametophyte, and results in a limited number of spores. In more complex Bryophytes it is still short-lived and dependent, but larger, with distinction of apex and base, a brief apical growth, and a basal vegetative region distinct from the terminal capsule: there is entire absence of appendages, but a partial differentiation of tissues, with internal ventilating system and some assimilatory tissue. The spore-production is on a larger scale, but limited usually to the simultaneous development of one continuous spore-sac.

In the Pteridophytes the mature sporophyte is an independent, self-supporting organism; but it is dependent in youth upon the parent prothallus: it is commonly perennial. It has theoretically unlimited growth of axis and root: the appendages vary greatly in size: there is high differentiation of the tissues, with an elaborate ventilating system: the plant thus constituted is capable of complete and continued self-nutrition. The spores are produced after a more or less prolonged vegetative phase, and in perennial forms their production may be continued for an unlimited succession of seasons. They are borne in separate sporangia, which are commonly seated upon the appendages: the sporangia themselves are frequently produced in a continued succession. These arrangements are such as to lead to a high and even long-continued output of adequately nourished spores. The sporangia are frequently restricted to certain shoots, in which the parts are closely aggregated: these are termed strobili.

The heterosporous state seen in all the highest Vascular Plants, introduced advantages conducing to certainty in nursing the embryo, and led in Seed-Plants to an infinity of special developments which secured that transfer of the microspores which is so necessary for fertilisation. But the essential plan of the independent, self-nourishing Vascular Plant once laid down was not departed from, even in the highest forms. The sporophyte, thus sprung from small beginnings, remains the dominant generation in all distinctively terrestrial plants.

The entire inversion of the balance of the two alternating generations thus briefly sketched—the dwindling away of the one and gradually achieved dominance of the other—is a fact which requires some physiological explanation. We may be sure that such things do not happen without good reason. It will be our object later to enquire into this. Meanwhile we recognise the fact itself, and we shall see in the comparisons which lead to its recognition an enduring monument to the genius of Hofmeister who first pointed them out.

CHAPTER IV.

CYTOLOGICAL DISTINCTION OF THE ALTERNATING GENERATIONS OF ARCHEGONIATAE.

ALTERNATION is thus found to be a general phenomenon for Archegoniate Plants. It was at first recognised chiefly on the basis of the propagative organs which the alternating generations respectively bore, and the distinction was confirmed on grounds of external form and of anatomical structure. The two phases, however, presented no very strict criteria by which they could with certainty be told apart. As regards external form, a foliar development was found to exist in the sexual generation of the Bryophytes, and again in the neutral generation of Vascular Plants: and however strongly it might be urged on grounds of detailed comparison that these were distinct in origin, and therefore only analogous, still the fact that foliar development exists in them both showed that external form did not constitute a strict criterion. As regards anatomical structure, the presence or absence of vascular tissue, and of intercellular spaces appeared at first to give a ready distinction: but a better knowledge of the anatomy of the larger Mosses showed that they also contain conducting tissues closely analogous to the vascular strands of Pteridophytes. Again, it is a fact that there is an ample ventilating system in the sporophyte, and that intercellular spaces are generally absent in the gametophyte; but in the leaves of certain Filmy Ferns there may be no intercellular spaces throughout considerable tracts, while the statement for the gametophyte is one of those negative statements which are at any time open to reversal. Even the production of the characteristic organs of propagation, and the transition by spore or zygote from one generation to the other, is not so absolute a distinction as was once thought; for first apogamy, and later apospory were discovered, and it was thus seen that a vegetative transition might take place from either generation to the other, without the critical incident of production of spore or zygote intervening as a limit. The climax of these difficulties in definition of the two generations was reached when Lang described, in 1896, how in certain Ferns sporangia might be borne directly upon the prothallus itself.

This absence of strict criteria distinguishing between the two alternating generations of Archegoniate Plants has given rise to much discussion, and the differences of opinion have centred round the question of their origin. Were the two generations distinct *ab initio*, or were they merely phases differentiated from a common source? Under the "homologous" theory of alternation the two generations were held to have been similar in origin, and the alternation to have originated by a secondary modification arising in a pre-existent and independent organisation. The adherents of the "antithetic" theory held that the sexual generation was pre-existent, and that a new organisation arose, derived by amplification from the zygote: the sporophyte was thus originally not a result of change in a pre-existent organisation, but it arose as a newly expanded phase, distinct in its origin from other phases of the life-cycle. The difference of opinion entailed in these two theories is essentially one of history, and of method of origin.

In the absence of strict criteria of distinction, such discussions are apt to be long and inconsequent. It seemed accordingly to be a welcome advance when facts were gradually disclosed, showing that a cytological difference exists between the two generations. This appeared to raise the whole doctrine of alternation in Archegoniate Plants to a higher plane, and to relate the origin of the two alternating phases intimately with the existence of a sexual process. In order to understand the nature of this new criterion of distinction it is necessary to be acquainted with the main features of nuclear division. When a nucleated vegetable cell divides, the nucleus takes the initiative, and goes through a series of phases as shown in Fig. 31, which is quoted from Strasburger, to whom the discovery of the details is chiefly due. Without describing these at length it may be stated that the chromatin, that constituent of the nuclear body which stains most deeply, distributes itself in the linin: the body thus formed changes from a network of fine fibrils in the resting nucleus (1) to a thicker convoluted thread, which then divides transversely into segments—the chromosomes (3, 4). These segments then divide longitudinally (6, 7, 8), and the halves of each, separating from one another, pass to the opposite poles of the nuclear spindle, which has meanwhile been formed (8, 9, 10): they there reconstitute the chromatin-system of the two new nuclei (10, 11, 12). An essential part of this process is found to be that the number of chromosomes is definite, and though in different plants and groups of plants it may vary within wide limits, still in the species or individual the number is (with some exceptions) strictly maintained. But this is so normally only in the cells of the one or of the other generation; for it has been found, in cases which are constantly becoming more numerous as observations extend, that there is a numerical difference in the chromosomes of dividing nuclei in the two alternating generations of the same plant: in the sporophyte the number is twice that in the gametophyte: the former has accordingly been styled the "diploid," the

latter the "haploid" phase. It happens that the facts are more readily observed in most Seed-Plants than in Pteridophytes, owing partly to the greater size of the spindles, partly to the number of the chromosomes being smaller than in most of the Archegoniates. Accordingly we have the record of the numbers from over 60 Seed-Plants, showing with remarkable

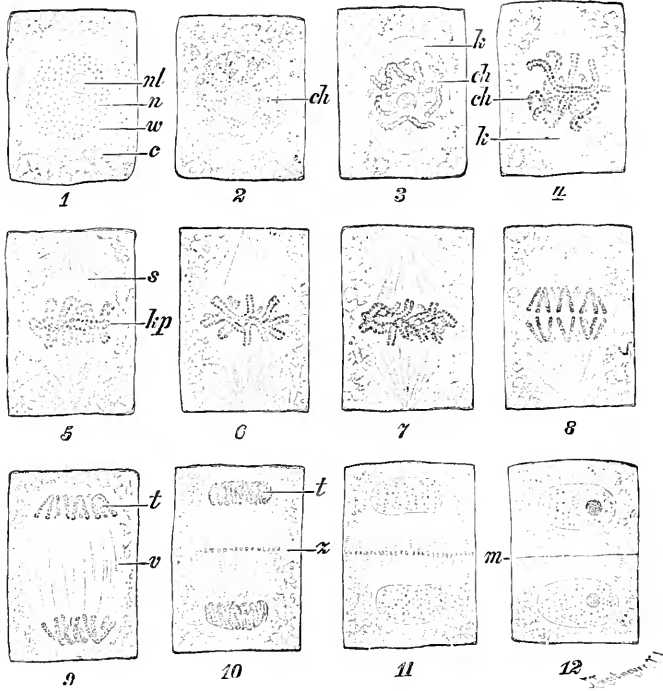

FIG. 31.

Successive stages of nuclear- and cell-division in an embryonic tissue. *nl*=nucleolus. *w*=nuclear wall. *c*=cytoplasm. *ch*=chromosomes. *k*=polar-cap. *s*=spindle. *kp*=nuclear plate. *t*=young daughter-nuclei. *v*=connecting threads. *z*=cell-plate. *m*=new septum. In 1 the resting nucleus is shown. In 2 and 3 the segregation of the chromosomes. In 4 the chromosomes are seen with transverse discs. In 5 the arrangement of the chromosomes to form the nuclear plates and their longitudinal fission. In 3-5 the formation of the spindle from the polar-caps. In 6 the longitudinal fission of the chromosomes. In 7 their separation towards the poles has begun. In 8 the daughter-chromosomes are completely separated. In 9 they are proceeding towards the poles. In 10, 11, and 12 the daughter nuclei are being formed. In 9-11 the connecting threads and the cell-plate are being formed. In 12 the completion of the septum. \times about 600. (After Strasburger.)

constancy that the number of chromosomes in the dividing nuclei of the sporophyte is double that in those of the gametophyte. Common numbers are 32:16—24:12—16:8; while they run as low as 12:6 or 6:3, and as high as 64:32 or 96:48.

Records from the Gymnosperms bring evidence of the same difference between the two generations in various species of *Pinus*, etc. Among Pteridophytes it has been observed in such Ferns as *Osmunda*, *Alsophila*,

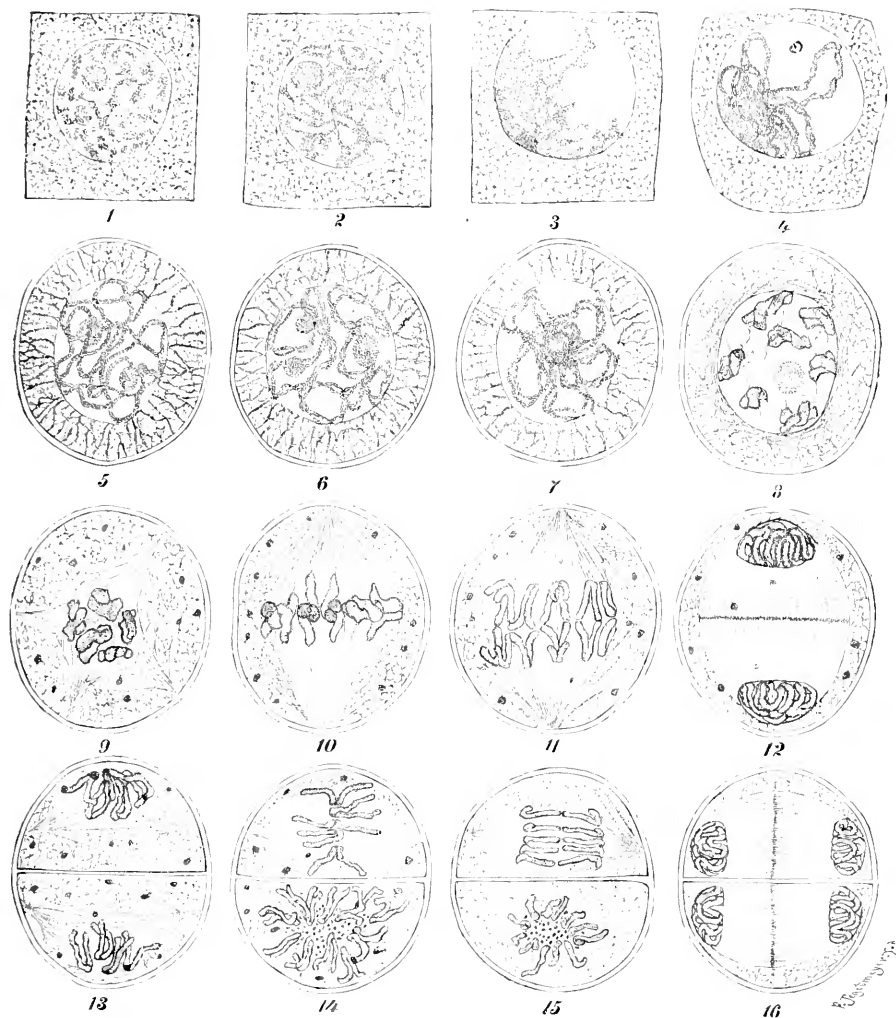

FIG. 35.

Pollen-mother-cells of a Lily in course of division, somewhat diagrammatic. 1. Mother-cell with resting nucleus. 2. The segregation of the chromosomes. 3. Synapsis. 4. Double threads already beginning to coalesce. 5. The spirem derived from the coalescent double-thread, apparently a single thread. 6. Subsequent separation of the threads. 7. The spirem transversely segmented, double chromosomes. 8. Diakinesis. 9. Initiation of multi-polar spindle. 10. Spindle of the mother-nucleus, the nuclear plate composed of double-chromosomes. 11. Reduction-division, the separating chromosomes showing a partial separation of their longitudinal halves. 12. Formation of daughter-nuclei. 13. The longitudinal halves of the chromosomes (daughter-chromosomes) are disposed in the nuclear spindles connected in pairs. 14. Daughter-nuclear-spindles. 15. Separation of the daughter chromosomes. 16. Formation of the nuclei of the second generation. \times about 800. (After Strasburger.)

and various Polyodiaceae. In the Bryophytes, the earliest case described was that of *Pallavicinia* investigated by Farmer, with four chromosomes in the gametophyte and eight in the sporophyte: and the same relation between the generations has since been found also in other genera of Liverworts. In Mosses few observations have yet been made, but Mr. M. Wilson has found that in *Mnium hornum* the numbers are 6 and 12 respectively in gametophyte and sporophyte. Accordingly the difference in chromosome-number may with high probability be held as a general diagnostic feature between the two generations in normal representatives of the Archegoniate series.

This being so, the recognised limits between the generations will naturally be expected to be the points of transition from the one chromosome-number to the other. Now it is found that when the sexual fusion of the two nuclei takes place, the subsequent divisions of the fusion-nucleus show the doubled number of chromosomes: therefore the zygote will be the one limit, and this is in accord with the old distinction of the generations dating from the time of Hofmeister. In his practice the other limit was the spore, since this is the actual body separated as an independent germ. But it is found that the actual reduction of the number of chromosomes to one half, that is, to the original pre-sexual number, takes place at the tetrad-division of the spore-mother-cell. This cell divides twice in rapid succession, and the process is well illustrated in the case of the pollen mother-cells of *Lilium*, in which it has been specially studied (Fig. 32). It starts from a cell with a nucleus having the double number of chromosomes, as shown by its origin. The nucleus first enters the condition of synapsis (Fig. 32. 3, 4), in which a lateral fusion of the chromosomes in pairs, respectively of paternal and maternal origin, is believed to take place: presently a coiled thread frees itself from the tangle of synapsis (Fig. 32. 4, 5), which becomes shorter and thicker, still showing, however, indications of its double nature (Fig. 32. 6, 7), and divides into segments, which are half as many as those of the parent nucleus (Fig. 32. 7, 8): each individual of the chromosome-pairs then moves apart (Fig. 32. 10, 11), one of each pair passing to either pole of the spindle which has meanwhile been formed: as each half is an original chromosome, the number at each pole is one half that of the parent nucleus, and the division is styled the heterotype, or reducing division (Fig. 32. 12). The second division in each of the two nuclei thus formed follows quickly, and is homotypic, that is, each chromosome undergoes longitudinal fission into two, as in a vegetative division (Fig. 32. 13, 14, 15). The four nuclei thus constituted have also half the number of chromosomes present in the nucleus of the spore-mother-cell; but the reduction is actually effected, as has been seen, in the first, or reducing division. Accordingly, Strasburger has recognised the spore-mother-cell, in which the reduction is initiated, as the actual limit between the two generations. But it is the spore itself which normally terminates the

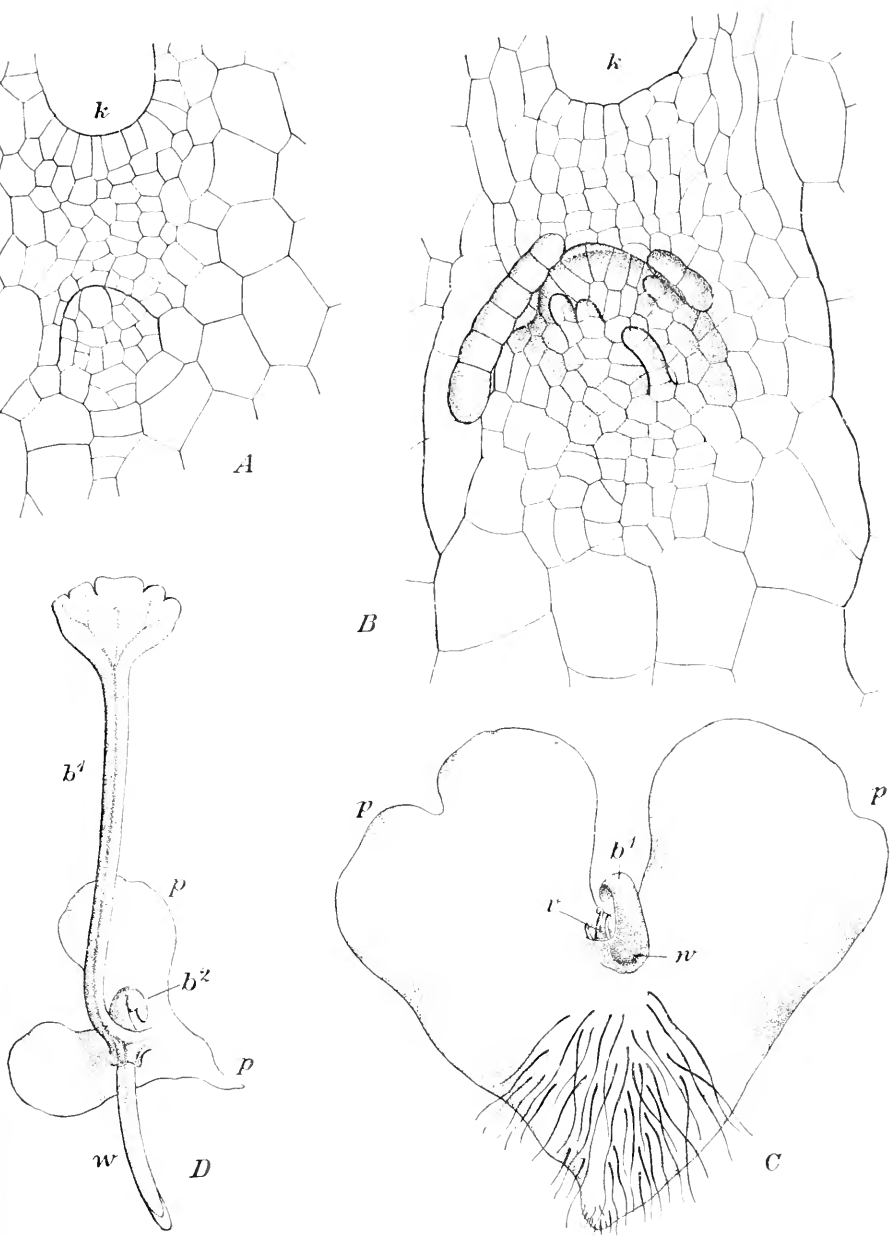

FIG. 33.

Apogamy in *Pteris cretica*, L. A and B, development of the first foliar process close to the emargination (*k*) on under surface of prothallus. C, a whole prothallus seen from below, showing a young apogamous shoot. D, a similar growth more advanced. *p* = prothallus; *b¹* = first leaf; *r* = stem-apex; *w* = root. D, a similar growth more advanced. A and B \times 145, C and D highly magnified. (From Engler and Prantl, after De Bary.)

one generation and forms the starting-point for the next generation: the older usage based upon this obvious fact is, therefore, to be preferred, and the spore may be still held to be the obvious boundary between the two generations. The gametophyte, or haploid phase, will then be recognised as extending from the spore to the zygote in each cycle, and it shows "n" chromosomes normally in all its nuclear divisions: the sporophyte, or diploid phase, is recognised as extending from the zygote to the spore, and it shows "2n" chromosomes in all its normal nuclear divisions. However difficult these nuclear details may be to recognise in any given case, so far as observation goes within the limits of the Archegoniatae they provide a structural basis for the distinction of the



FIG. 34.

Scolopendrium vulgare. Prothallus from the branched cylindrical process of which ten roots arose; eight of these are visible in the drawing. \times about 6. (After Lang.)

two generations more exact than any other, a distinction which runs parallel with those less accurate criteria on which the recognition of the generations was first founded. The possession of this means of diagnosis necessarily turns attention afresh to those cases where the transition from one generation to the other is bridged over by direct vegetative growth, viz. the phenomena of Apogamy and Apospory, which have figured so largely in the discussions on alternation. It has long been known that the two alternating generations are not always delimited from one another respectively by those unicellular phases of the spore and the zygote; but that in certain cases, and among the Archegoniatae most commonly in the Ferns, there may be a vegetative transition either from the prothallus to the sporophyte without the intervention of a sexual process—this is termed *apogamy*; or conversely, from the sporophyte to the prothallus without the intervention of spores—this is designated *apospory*.

In the most frequent examples of *apogamy* in Ferns the place of an embryo is taken by a process which originates from the tissue of the cushion as a result of vegetative growth and division of its cells (Fig. 33, A): it soon takes a form corresponding to that of an embryo, with first leaf, root, and apex of axis (Fig. 33, B and C), and it finally becomes an established plant in the same way as those sexually produced (Fig. 33, D). In some cases these developments may take place in entire absence of archegonia on the prothallus; in others various conditions of the archegonia may be

found, either showing normal structure or various modifications of it. But in other cases, which have been described in detail by Lang,¹ the apogamous developments may diverge far from the normal in point of the number and position of the parts. Originating by direct vegetative growth from the tissues of the thallus, in place of the normal sequence and position of the parts the several constituents of the sporophyte, root, leaf, sporangium, may appear without order or numerical rule: ten or more roots have been found apogamously produced upon a prothallus without other parts of the sporophyte (Fig. 34): sporangia have been observed without sporophylls, originating directly from a formless mass of sporophytic tissue apogamously produced on the prothallus (Fig. 35), or even, in an extreme case, from the prothalloid cells of the archegonial wall (Fig. 36). The irregularity of such growths must be taken into consideration in their theoretical interpretation, as will be seen later. Among the Archegoniatae apogamy has hitherto been observed in a score or more of species of Ferns, belonging to the Osmundaceae, the Hymenophyllaceae, and chiefly to the Polypodiaceae; and examples are also recorded from the Marsiliaceae. In the Bryophytes, the Lycopodiales, and the Equisetales no cases are as yet recorded. It may be noted, however, that similar phenomena have been observed in Flowering Plants, such as *Alchemilla*, *Thalictrum*, *Antennaria*, and *Taraxacum*.²

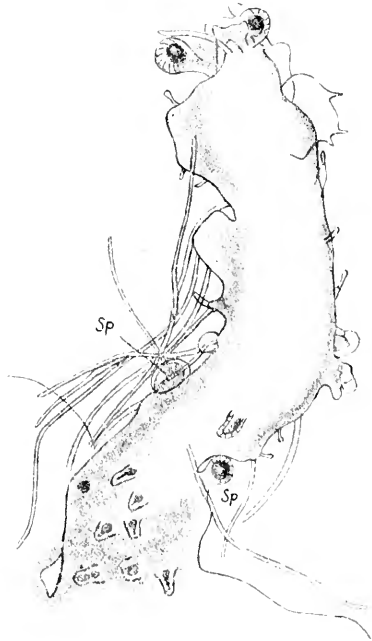

FIG. 35.

Nephrodium dilatatum, Desv., var. *cristatum* *gracile*. Prothalloid cylindrical process, bearing archegonia near its base. It arises by the side of an imperfect sporangium (*sp*), and bears a similar sporangium (*sp*) on the other side, and on the tip are a number of sporangia associated with rudiments. $\times 35$. (After Lang.)

Turning now to Apospory,³ that is, the transition by direct vegetative growth from the sporophyte to the gametophyte without the intervention of spores, instances are recorded from the Liverworts (*Anthoceros*, Lang),⁴ from the Mosses (*Hypnum* and *Bryum*, Pringsheim,⁵ *Ceratodon*, Stahl,⁶

¹ *Phil. Trans.*, vol. exc. (1898), p. 187, etc.

² For references see Strasburger, *Flora*, 1907, p. 139.

³ The term "Apospory" was introduced by Vines, in an article on the "Proembryo of *Chara*," *Journal of Botany*, 1878, p. 355.

⁴ *Annals of Botany*, vol. xv., 1901, p. 503.

⁵ *Pringsh. Jahrb.*, xi., 1877.

⁶ *Bot. Zeit.*, 1876, p. 689.

Funaria, Brizi),¹ and from various species of Ferns belonging to the Hymenophyllaceae and Polypodiaceae,² but no examples are on record from the Lycopodiales or Equisetales. Those cells which would in the normal course produce the spores take no part in the formation of the gametophytic growths. In *Anthoceros* the origin of these is commonly from sub-epidermal cells: in the Mosses from the cells of the seta, or of the sporogonial wall: while in Ferns the archesporial cell if already defined in a sporangium is abortive. Thus the aposporous growths are in no

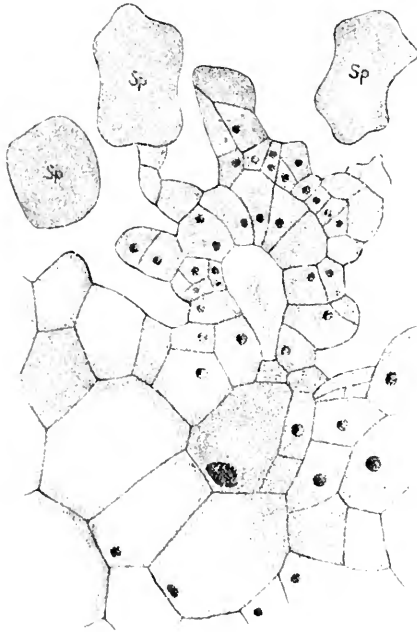

FIG. 36.

Scolopendrium vulgare. Group of sporangia (Sp) on a projection, the structure of which indicates its relation to an archegonium. Occasionally two nuclei are present in a single cell. $\times 600$. (After Lang.)

sense mere irregularities of development from sporogenous cells. In *Anthoceros* each growth is apparently referable in origin to a single cell, and the same is probably the case also for Mosses. But in the Ferns this is not so: here the vegetative development may start from a sporangium formed in its normal place: a plurality of the cells of the stalk, or of the sporangial wall surrounding the abortive central cell may divide, and assume prothalloid characters (Fig. 37), or the growth may arise from the receptacle of the sorus (Fig. 37 E): or again, it may be initiated at some point on the leaf, usually marginal, which thus extends directly into the prothallial expansion, and may bear antheridia and archegonia (Fig. 37 B, C, D).

The matter may be further complicated by the combination of apogamy and apospory in the same individual, and this condition has been seen in about half the recorded cases of these abnormalities in Ferns. The apogamous seedlings of *Nephrodium pseudo-mas*, var. *cristata* (Cropper), not only sprang themselves in an apogamous manner from the prothalli, but proceeded almost at once to an aposporous production of new prothalli on the margins of the young leaves.³ These prothalli bore antheridia,

¹ *Ann. Inst. Bot. Rom.*, v., p. 54.

² For references see Engler and Prantl, *Nat. Pfl.*, t. 4, p. 88, and Goebel, *Flora*, 1905, p. 239.

³ *Drucy, Journ. Linn. Soc.*, vol. xxix., p. 479.

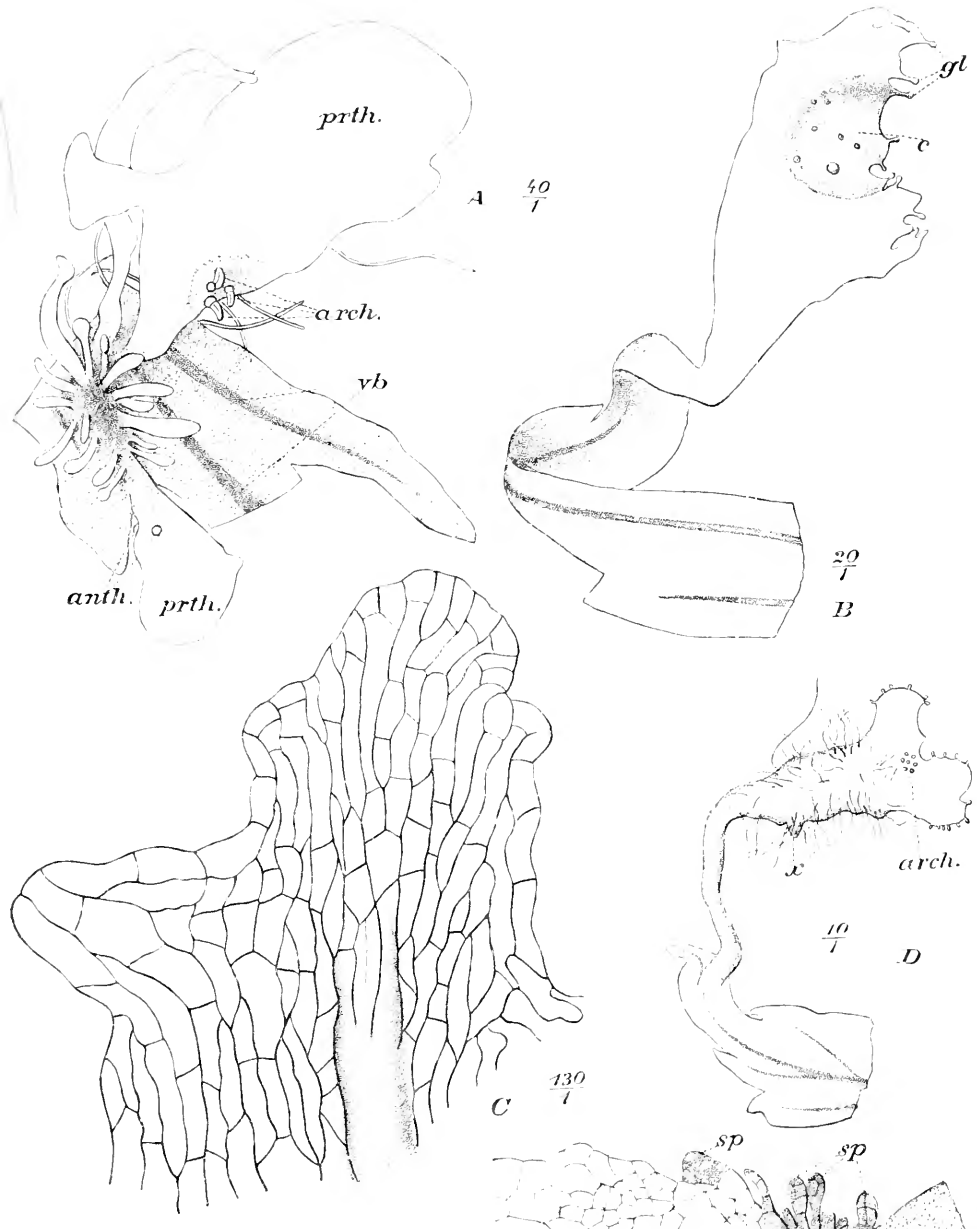

FIG. 37.

Apospory. *A* = Soral-apospory of *Athyrium filix foemina*, var. *clarissima*. Jones. Part of a pinnule with veins (*vb*) and a sorus. In the latter, in place of the sporangia, prothalli are formed (*prth*) with antheridia (*anth*) and archegonia (*arch*). $\times 40$. *B* = apical apospory of *Polystichum angulare*, var. *pulcherrimum*. Padley. A prothallus at the tip of a pinnule, as a direct continuation of it. *gt* = marginal glands, *c* = the cushion. $\times 20$. *C* = the first initiation of a prothallus as in *B*, at the apex of a pinnule. The shading indicates a vein beyond the tip of which the prothallus arises. $\times 130$. *D* = a similar growth, but borne on an elongated cylindrical process; archegonia (*arch*) are already present. $\times 10$. *E* = soral apospory in *Polystichum angulare*, var. *pulcherrimum*. A prothalloid growth bearing an antheridium (*anth*) and rhizoids (*rh*) has arisen from the stalk of a sporangium. $\times 70$.

but Dr. Lang's drawing shows how, nevertheless, the prothalli in turn hasten to a fresh apogamy (Fig. 38), thus the two transitions may be repeated at near intervals of time. The same was seen to be the case in *Trichomanes alatum*, in which apospory and apogamy were found to succeed one another,¹ and it has recently been proved to hold also for *Athyrium filix foemina*, var. *clarissima*, Jones, and other Ferns.²

Lastly, Goebel has shown³ that when the seedling leaves of certain ferns are removed and cultivated on a moist substratum, aposporous growths may be induced, which show sometimes the most intimate inter-



FIG. 33.

Nephrodium pseudo-mas, var. *cris-tata* (Cropper). Drawing by Dr. Lang, showing apogamous transition from prothallus to sporophyte, and subsequent aposporous transition to prothallus at the apex and margins of the leaf.

mixture of characters of the sporophyte and the gametophyte. These developments appear to be similar in kind, though not in detail, to those described by Lang and others. It would doubtless be possible to erect upon such facts a superstructure of theory; but it is necessary to remember that by the abscision of a young part it is placed in an anomalous and extreme physiological position. It is improbable that such circumstances ever arose in the course of descent: and accordingly it must remain a quite open question what bearing, if any, such observations have upon the evolutionary story. They demonstrate possibilities: but possibilities are not the equivalent of historical data.

The rapid succession of the transitions thus actually seen in some Ferns from the sporophyte to the gametophyte, and the converse, give some colour to the suggestion made by Goebel, that the sporophytic buds he found in the deep-water specimens of *Isoetes* are to be viewed as extreme cases of the telescoping of the alternate generations.⁴ This state of affairs is very nearly matched by certain *Adiantums* observed by Lang, in which numerous sporophytic buds were produced from the sorus. Examination showed that they sprang in certain cases from the sporangia themselves, but not from the sporogenous tissue. If we imagine the gametophyte stage reduced in such cases, not to a very short phase only, as it is in Lang's *Nephrodium*, but to the vanishing point, the result might be as in Goebel's *Isoetes*. But we may

¹ *Ann. of Bot.*, vol. i., p. 209.

² Farmer and Digby, *Ann. of Bot.*, 1907, p. 163-167.

³ *Sitz. d. Math.-phys., Klasse d. K. Bayer. Akad. d. Wiss.*, xxxvii., 1907. Heft. ii., p. 119. This is interesting for comparison with my own negative results on leaves of mature plants recorded in *Ann. of Bot.*, iv., p. 168 (1889).

⁴ *Bot. Zeit.*, 1879, p. 1.

well ask whether such an interpretation does not read into the facts more than actually exists? If *Isoetes* were a plant which habitually showed combined apospory and apogamy, and if various steps were present leading towards the extreme result, then the conclusions might be accepted. But *Isoetes* is a plant which is structurally stable as a rule, and there is in these abnormal growths no prothalloid tissue at all. Thus they appear to be merely sporophytic buds formed from sporophyte tissue, and having sporophytic character throughout. They will rank with those sporophytic buds which are found arising from the sorus in various Ferns, or from the nucellus in some Phanerogams: they are, in fact, a mode of vegetative continuance of the neutral generation, and nothing more.

The question necessarily presents itself, what is the cytological state of the tissues in the plants which show those vegetative transitions from one generation to another, such as have been described for the Mosses and Ferns above named? The facts would appear to be inconsistent with the structural distinction of the two generations, since the acts of sexuality and of spore-formation, by which the cytological changes are normally effected, are liable to be omitted. It will be important to know how far the distinction between the haploid and the diploid phases will remain valid. The facts have lately been elucidated for a number of the abnormal Ferns by Prof. Farmer and Miss Digby,¹ and for the very peculiar case of the genus *Marsilia* by Prof. Strasburger.²

Taking first the case of apogamy: already in 1898 Dr. Lang had observed in prothalli of *Scolopendrium*, in the tissues bordering on the change from gametophyte to sporophyte, the frequent presence of two nuclei in a single cell (Fig. 36). More detailed observations have since been made on other apogamous Ferns, by examination of very young prothalli, before any apogamous growths had begun to manifest themselves.³ Similar cells with two nuclei were observed in the case of prothalli of *Lastraea pseudo-mas*, var. *polydactyla*: but it was shown that when two nuclei are seen in a single cell a neighbouring cell is without one, and cases were found where the passage of the nucleus through the cell-wall was actually in progress (Fig. 39). This process is regarded as a kind of irregular fertilisation, for ultimately the two nuclei fuse. On their division the nuclei of the apogamous growth thus produced show, as a consequence of the fusion, evidence consistent with a doubling of the chromosomes, just as it happens in the normal post-sexual stage. But instead of one cell only serving as the starting-point for the new generation, a number of such units co-operate loosely to produce it. These results have their interesting bearing on the irregularity of number, and the sporadic position of the parts in such cases as those observed by Lang. It is thus seen that even in these irregular examples the cytological criterion between the two generations may hold, and the structural limit will be found in the cells

¹ *Ann. of Bot.*, xxi., p. 161.

² *Flora*, 1907, p. 123.

³ Farmer, Moore, and Digby, *Roy. Soc. Proc.*, lxxi., 1903, p. 453.

in which the doubling of the chromosomes is initiated by the nuclear fusion.

The first case of apospory to be cytologically investigated was that of *Nephrودیум pseudo-mas*, var. *crisitata apospora*, where the prothallus grows directly out from the margin or surface of the leaf. It was shown in this case by Miss Digby¹ that there is no nuclear change involved, but that both sporophyte and gametophyte have a number of chromosomes about 50. This result would at first sight appear to show that the

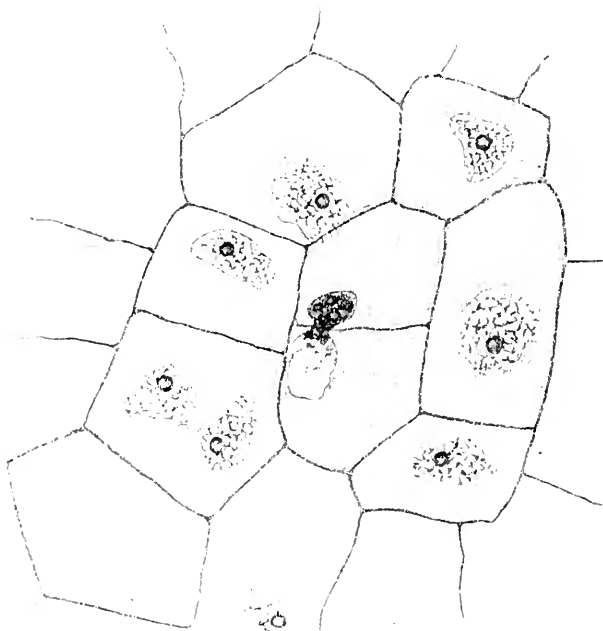

FIG. 39.

Nephrودیум pseudo-mas, var. *polydactylum*. Tissue of prothallus where an apogamous growth is to be formed, showing to the left a cell with two nuclei, while an adjoining cell has none. At the centre a nucleus is seen passing through a perforation of the wall, and fusing immediately with that of the cell it enters. (After Farmer and Moore, and Miss Digby.)

chromosome-criterion had hopelessly broken down. But a better understanding of such cases is obtained when the whole nuclear cycle is considered, than by contemplation of a single phase of it. It has been above noted that there is a frequent relation between apogamy and apospory in the life-cycle of the same individual: it is important to know the nuclear conditions throughout such cycles. The case of *Athyrium filix-foemina*, var. *clarissima*, Jones, may be taken as a first example where the complete chromosome-cycle is known.² In this Fern

¹ *Rep. Soc. Prot.*, lxxvi., 1905, p. 406.

² Farmer and Digby, *Ann. of Bot.*, 1907, pp. 103-7.

it has been shown by Farmer and Miss Digby that there is apogamy as well as apospory. The cytological investigation shows that in those cases where sporophytes were borne on the apogamous prothalli there is not any migration of nuclei from one prothallial cell to another, such as has been described for some cases of apogamy; nor is there doubling of the chromosomes in any other way. In fact, the chromosome-number is the same for the sporophyte as for the prothallus which bears it. Investigation of the aposporous transition from the leaf to the prothallus showed also that no change of number marks the passage from sporophyte to gametophyte. There is here a case of cytological uniformity throughout the whole cycle, with chromosome-number about 90. This is approximately the number found in the diploid stage of a typical *Athyrium filix-foemina*. The condition of the variety is as though reduction had been omitted from the cycle: as a consequence the prothallus being itself diploid, fertilisation would be unnecessary to produce a new sporophyte: accordingly apogamous budding will suffice, and that is what actually occurs.

A near parallel to this has been worked out with similar exactitude by Strasburger in *Marsilia Drummondii*, A.Br.¹ The typical chromosome-numbers are 16 and 32 respectively for gametophyte and sporophyte, and normal plants show the usual succession of events. But on germination of the megaspores borne by certain plants, the gametophyte was found to have the diploid character, and this was seen even in the division to form the ventral-canal-cell: thus the ovum itself is diploid. In such archegonia the neck does not open, so that fertilisation by spermatozoids is impossible: the unfertilised diploid egg develops apogamously into an embryo, which is naturally diploid also. An examination of the sporangia showed further that while in typical *Marsilia* the reduction to 16 chromosomes takes place as usual in the spore-mother-cells, in *M. Drummondii* the megasporangia show two types of spore-mother-cells: the one type is normal in number, and shows reduction: the other type is produced in smaller numbers in the sporangia, for instance only four in place of the usual 16: these on division have diploid nuclei, and the interesting fact is that their diploid state does not divert them from the usual characters of form and structure. Since the apogamous plants produce both diploid and haploid spore-mother-cells, it is accordingly not surprising that both apogamous and sexual plants should be produced from their sporocarps: and it is apparent that among the representatives of the species there will be individual cycles completed without any change of chromosome-number: certain cycles will accordingly be diploid throughout. In this they correspond to what is seen in *Athyrium filix-foemina*, var. *clarissima*, Jones, though they differ in the detail that the diploid ovum here forms the embryo, while in the *Athyrium* the embryo arises from the prothallus by apogamous

¹ *Flora*, 1907, p. 123, etc.

budding. But an exact parallel is found in *Athyrium filix-foemina*, var. *clarissima*, Bolton, and in *Scolopendrium vulgare*, var. *crispum Drummondæ*, in which the embryo arises from the unfertilised ovum.¹ It may be remarked that the phenomena thus seen in the last-named Ferns and in *Marsilia* correspond essentially to what has been described for certain Phanerogams.² It thus appears that in a number of cases, systematically apart from one another, a diploid condition of the gametophyte is associated with apogamous development from a diploid unfertilised ovum: the abnormality is initiated by omission of the reduction in the spore-mother-cell, and consequently the diploid state is continued in the gametophyte, which is normally haploid. It is important to note in such cases that a double number of chromosomes may be present without producing fundamental change of form or of external character in the gametophyte.

The further question will then present itself, whether under any circumstances the converse is possible, or has been observed, viz. that the phase normally diploid, that is, the sporophyte, may be haploid? Strasburger states (*l.c.*, p. 166) that no case has come under his observation in which the generation normally diploid has only the reduced number of chromosomes. No case of a haploid sporophyte has yet been proved beyond doubt: but a reasonable probability has been established by Farmer and Miss Digby in the case of *Lastræa pseudo-mas*, var. *cristata*, Druery (*l.c.*, p. 180). The detached leaf of this plant produces prothalli from its margin or surface, which bear occasional antheridia, but the sporophyte is apogamous. The chromosome-number in the prothallus is about 60: in the embryo the number varies considerably, one mean being 60, another mean number being about 78. No migration of nuclei was observed, nor is there any reduction in the whole cycle. The relatively small number of chromosomes in the nuclei of the sporophyte is striking, and suggested to Farmer and Miss Digby that the gametophyte character had been impressed on the sporophyte—the converse, in fact, of what was seen in the varieties of *Athyrium* and in *Marsilia*. A comparison of the chromosome-number (60, 78) with that in normal *Lastræa pseudo-mas* (144) certainly indicates that this is the probable condition of the apogamous sporophyte of Druery's variety: that the sporophyte is irregularly haploid, and that the whole cycle is essentially haploid throughout.³

It still remains to refer briefly to two other modifications of the normal cycle of alternation in Archegoniate Plants, so as to complete the tale of those which have been observed: I mean sporophytic and gametophytic budding. The former has already been mentioned in the case of

¹ Farmer and Digby, *l.c.*, p. 171.

² *Fucus hordii*, *Thalictrum*, *Antennaria*, *Taraxacum*. See Strasburger, *l.c.*, p. 139.

³ The examples quoted illustrate the more important modifications of the chromosome-cycle hitherto described. For further details reference must be made to the papers from which these have been derived.

Nephrodium Filix Mas, as occurring on the leaf-bases (Fig. 1), and in *Cystopteris bulbifera*, at points on the upper region of the leaf (Fig. 3). It also occurs in various forms in many other Ferns, in Lycopods, and Equiseta. The essential feature of it is that a portion of tissue of the sporophyte, developed as a bud with axis leaves and roots, on being detached from the parent plant, may continue its growth apart from the parent. This is plainly a mere vegetative amplification of the sporophyte itself, and its tissues are at first continuous into those of the bud: there is no reason to think that any nuclear change accompanies the production of these growths, and the result is the establishment of physiologically independent individuals; but their origin and detachment do not modify our conception of the sporophyte as a whole in any essential point. If that conception be based upon nuclear changes accompanying fertilisation and reduction, it will include all such results of vegetative amplification: they will be held to be intra-sporophytic means of propagation.

Similarly, in the case of gametophytic budding, which is common in Liverworts, Mosses, and in certain Ferns, by means of gemmae: these are small bodies, consisting of one or more cells, which are easily detached and under suitable conditions develop into new gametophytes. Here again the gemmae appear to be mere vegetative growths, and they secure increase in number of physiologically independent individuals; but there is no reason to think that there is any nuclear disturbance involved: they may be regarded as intra-gametophytic means of propagation.

How, then, do the irregularities above described affect the general view of the cytological distinction between the two alternating generations of the Archegoniatae? It is quite clear that an absolute chromosome-distinction cannot be held as universally applicable at the present time to the two alternating phases: nor does form depend on the exact number of the chromosomes: nor yet is there any obligatory ratio according to which the gametophyte is always haploid and the sporophyte always diploid. These facts give an opening to the facile conclusion that the chromosome-distinction is worthless, and opinions to this effect have already been expressed. But the recognition of the present existence of aberrant forms does not negative the importance of the relation which is usually seen, nor exclude it from taking its due place in the reconstruction of the history of the past. It is contrary to all evolutionary theory and experience to assume that what has been normal in the past is obligatory for the present or the future. Moreover, it seems probable that these abnormalities do not represent anything which took a settled place in the course of the evolution of the plants in which they appear: our opinion might be different if in any of the great phyla it could be shown that a definite stock, or line of descent, had been permanently established showing aberrant characters; for instance a permanent Archegoniate phylum showing a cycle without any chromosome-differences. But of this there is no evidence at all: every one of the main phyla

show normally the regular succession of events as described, viz. the haploid gametophyte leading through sexuality to the diploid sporophyte, which, again, through reduction or meiosis in the spore-mother-cells, leads back to the haploid prothallus. The constancy of this is too great to allow its recognition as the "normal" to be seriously disturbed by the occasional irregularities described—irregularities which bear all the characters of late, individual, and probably non-permanent aberrations. Their existence is suggestive on certain points, but it cannot be held to invalidate the view that the cycle as above stated existed in all probability throughout the earlier phases of descent of the Archegoniatae.

Accordingly the cytological distinction of the two generations may be upheld as the normal condition for the Archegoniatae. Further, the opinion of Farmer may be accepted, that the new facts relating to apogamy and apospory leave the question of alternation where it was: they tend neither to destroy the one theory of its origin nor to uphold the other (*l.c.*, p. 193). Moreover, the facts of the normal chromosome-difference may be held to accord with either of the theories of alternation, the homologous or the antithetic: they are not finally distinctive for either, and a decision must remain still in doubt until the actual history of the genesis of the diploid phase in the Archegoniatae can be traced. Towards forming a just opinion on this question it is desirable not only to compare the Archegoniatae among themselves, but also to take into consideration the life-cycles of the Thallophytes: for these plants often show a simpler mode of life, and have always been held to afford suggestions as to the probable origin of the more complex land-vegetation. This will be the subject of the next chapter.

CHAPTER V.

ALTERNATION IN THE THALLOPHYTES.

THE early recognition by Hofmeister of alternation of generations as a general feature in the life-cycle of the Archegoniatae naturally led Botanists to enquire whether any similar succession of phases existed in other plants: and the question was soon directed towards those lower in the scale, which are collectively termed the Thallophytes. Notwithstanding that this term covers a most heterogeneous series of organisms, a very large number of them show processes of propagation analogous to those seen in the Mosses and Ferns. The existence, on the one hand, of the phenomenon of sex, and on the other of the means of propagation by non-sexual bodies, or spores of various kinds, suggested the comparison with corresponding features in the Archegoniatae. Such comparison at once raises the further question how far the study of the Thallophytes may throw light on the origin of those recurrent and alternating phases seen in Archegoniate Plants.

It will be well at once to realise that the phenomenon of sex, and the production of germs, by which the number of individuals may be increased, are not necessarily in any way connected in plants at large. It is true that in certain plants, and even in large groups of them, experience shows us that there is an obligatory succession of such events in the life-history, liable, however, as we have seen in the Ferns, to certain exceptional modifications. We know from experience that the fertilised zygote of the Archegoniatae grows into the sporophyte, which has as its ultimate end the production of spores: it has never yet been seen to grow directly into a prothallus again. The spore of the Archegoniatae, according to our invariable experience, germinates to form a prothallus: it has never been seen directly to produce a new sporophyte. There is then an obligatory succession of events in the life-history of the Archegoniatae. External circumstances may affect the production of fertilised zygotes, or of matured spores: but so far experiment has not altered the product which arises respectively from the zygote or the spore, nor has such change been observed in Nature. When, however, we turn to organisms

lower in the scale, the case is found to be often different: the first clear demonstration for a Thallophyte that the phases do not follow an obligatory succession was given by Klebs for *Hydrodictyon*: subsequently his observations were extended to *Vaucheria*, and later to many other Algae and Fungi.¹ Up to 1890, when Klebs' first paper on *Hydrodictyon* was published, the comparison of the various stages of life in the Thallophytes—and indeed in plants at large—had rested on form, and very little was known of their behaviour under varying conditions. But Klebs applied to them the experimental method, and found in many cases that where the organism possesses two or more kinds of propagation, each is directly dependent upon quite definite external conditions. There appears in many cases to be no cause in the inner nature of the organism for one of these to be developed earlier or later: it lies in the hand of the experimenter to determine their succession. An exact knowledge of the conditions gives the experimenter the secure control over the organism, which can at will be forced into any desired mode of propagation within the limits of its species.

This may be well illustrated by the case of *Vaucheria*, which happens to have had its simple life-history adequately investigated through the experiments of Klebs. He found that the formation of the vegetative zoospores is most active if well-nourished plants are transferred to fresh external conditions, and especially to diminished intensity of light; while the formation of sexual organs can always be counted on when nutrition proceeds slowly, under relatively equable conditions, and under good illumination. Similar observations, correlating the phases of life of various Algae and Fungi with external conditions, have also been carried out, and though the determining circumstances may differ in different plants, the fact is now demonstrated for a number of Thallophytes, that there is in them no obligatory succession of phases: sexual reproduction or vegetative propagation may be repeated indefinitely, according to the conditions of life: neither of these leads of inner necessity to the appearance of the other. In fact the relation of the vegetative mode of propagation by isolated germs to the life-cycle of such Thallophytes is somewhat similar to the production of gemmae on the gametophyte of Archegoniate Plants, or to the sporophytic budding of Ferns or Lycopods. In all such cases, which may collectively be styled under the general term of somatic budding, the increase in number of individuals is secured, but only by an incident which takes no part in any rhythmic succession of obligatory phases, and involves no cytological change. The result is simply a repetition of the same phase from which the bud, gemma, or zoospore was itself derived. The experimental method of Klebs, by showing that the order of events in such cases is not obligatory, has laid the foundation for a more rational comparative study of the life-story in the Thallophytes. It may be considered probable that many more of the Fungi and Algae will be found to behave like the species which have been tested. As operative

¹ Klebs, *Bedingungen der Fortpflanzung bei einigen Algen und Pilzen*, Jena, 1896.

factors, external stimulus, light, temperature, moisture, access to oxygen, and the chemical composition of the nutritive medium, have already been recognised. These and others in various combination have been found, or may in the future be found, to determine the succession of propagative methods in many of the Thallophytes.

But, on the other hand, accurate observation is showing in an increasing number of examples that this freedom from obligatory succession of phases is not universally the case in the Thallophytes. It is beginning to be clear that here, as elsewhere, complications have arisen, associated with the phenomenon of sex, which lead frequently to an obligatory succession of phases, over which external conditions have little or no control. It has been seen in the Archegoniatae and in the Phanerogams that the result of sexual coalescence is a doubling of the number of chromosomes in the subsequent nuclear divisions, with reduction as the final consequence. The similarity in essentials of fertilisation in the Thallophytes to that in the Archegoniatae is obvious: it has been found in many cases to result in a doubling of the chromosomes in Thallophytes also, and this makes it seem probable that there should be post-sexual nuclear complications of somewhat the same nature in them also. Strasburger has drawn attention to the impossibility of indefinitely continued doubling of chromosomes in fertilisation, and the necessity for a reduction-process in plants which show sexuality: we must assume that some process of reduction will sooner or later follow in each life-cycle where sexual coalescence occurs; but the mechanism of the process, and the period at which it occurs in the life-cycle, may differ in different cases. The differentiation of the sexes in the Thallophytes has proceeded along many distinct lines. What is then more probable than that in different lines of descent the problem of reduction, as a necessary consequence of sexual fusion, should have been solved in different ways, and at different points in the life-story?

The facts observed in certain Thallophytes point to the conclusion that this has actually happened: reduction has now been shown in some of them to follow on sexuality, but its place in the life-cycle varies in different cases. The point of interest for present consideration is not so much the details of the process of reduction, as the place which it holds in the life-cycles of various Thallophytes, and the influence which it appears to have had in determining in them an obligatory succession of phases.

The question must for the present remain open how the reduction, which we may presume to be a necessary consequence on fertilisation, is carried out in those Thallophytes which show sexuality but have not any fixed succession of phases, such as *Vaucheria*, etc. Subsequent observations will doubtless provide the actual facts, and will probably locate the reduction-process either in near proximity to the germination of the zygote, or it may be to the production of the gametes.¹ We may even

¹ Oltmanns. *Morphol. u. Biol. d. Algen*, 1904, p. 324: B. M. Davis, "Oogenesis in *Vaucheria*," *Bot. Gaz.*, 1904, vol. xxxviii., p. 81.

anticipate that one or other of these locations will be found to be a general feature of those plants where there is no obligatory succession of phases, and their somatic condition would accordingly³ be in the former case haploid, in the latter diploid. With this remark they must be left on one side for the present.

In other cases, however, a succession of obligatory phases, defined on the one hand by the incident of sexual coalescence, and on the other by reduction, has been brought to light: in fact, examples of alternation have been found among the Thallophytes, showing cytological limits closely comparable with those which have been accepted in the previous chapter for the alternating generations in the Archegoniatae. Among the Algae one of the best cases of this, substantiated on both cultural and cytological evidence, is that of *Dictyota dichotoma*, Lamour. It has long been known that the tetraspores, antheridia, and oogonia of this plant are distributed on different individuals, but it has only recently been shown in what relation these plants stand to one another.¹ We now know that the number of chromosomes in the somatic divisions of the plants which bear antheridia and oogonia is 16: that there is no change of chromosome-number in the formation of the sexual cells, but that the fertilisation results in a zygote which on germination gives a plant with 32 chromosomes in its somatic divisions. This plant bears tetraspores; but in their production the mother-cell, on dividing its nucleus into two and then into four, shows a reduction to the original 16, the details of the process being closely comparable to those in the tetrad-reduction of Archegoniates and Phanerogams. The tetraspores on germination give plants which show 16 chromosomes on their somatic divisions, and thus correspond to the original sexual plants. The only gap which is left in the full demonstration of the life-cycle, both by cultures and by cytological observation, is that the plants raised by cultures from tetraspores have not yet been seen to bear sexual organs: but still they correspond in their chromosome-number. Here, then, is a succession of phases which appears to be obligatory, involving two stages which have the same chromosome-relation as the alternating generations in the Archegoniatae. But there is this difference: that in external form and structure the two alternating generations of *Dictyota* are substantially alike though the one is haploid and the other diploid.

Somewhat similar phases, which alternate in a less exact and obligatory manner, and in which the cytological details have not yet been observed, are seen in the life of *Cutleria*: they are known as the *Cutleria* and *Aglaosonia* stages.² This case is quoted here as showing that in plants probably akin to *Dictyota*, the exactitude of the alternation is not maintained. But this fact comes out much more strongly in the case of *Fucus*, in

¹J. Lloyd Williams, "Studies in the Dictyotaceae," *Annals of Botany*, 1904: D. M. Motlier, "Nuclear and Cell Division in *Dictyota dichotoma*," *Annals of Botany*, 1900.

²See Oltmanns, *Morph. u. Biologie der Algen*, Jena, 1904, p. 396, etc., where the current literature is fully dealt with.

which the thallus itself is diploid, but no alternation is known to exist. The cytological observations would indeed seem to exclude it: for the doubling of the chromosomes which follows on fertilisation is maintained throughout the somatic divisions, and reduction has been found to take place in *Fucus* in the first divisions respectively of the antheridium and the oogonium.¹ Such examples as these, taken from the group of the Brown Seaweeds, show that an obligatory alternation, though present in some of them in a type comparable cytologically with that of the Archegoniatae, is not a constant feature for them all, in the same sense as it is in the Mosses and Ferns.

In the Red Seaweeds the probability has long been contemplated that the peculiar developments following on fertilisation consist in the formation of a phase of the nature of a sporophyte. This position and a corresponding terminology have been accepted and developed for the Florideae generally by Oltmanns, in his work on Algae.² Until quite recently the necessary cytological details have only been observed in *Nemalion*, though the demonstration is not yet quite convincing.³ It is stated that on fertilisation of the procarp by the spermatium a nuclear fusion takes place: this results in a doubling of the chromosome-number from eight, which is the number in the somatic divisions of the thallus, to sixteen in those post-sexual divisions of the cystocarp which precede the maturing of the spores. On the other hand, though no tetrad-division occurs, a reduction-division is stated to be immediately associated with the production of the carpospores. If this be so, then the post-sexual stage, being diploid, will be cytologically comparable with the sporophyte-stage, and the carpospore on germination will initiate again the haploid or gametophyte stage. It is, however, to be borne in mind that neither *Nemalion* nor the genera allied with it bear tetraspores, which are so marked a feature in most members of the family. Fortunately the cytological history of *Polysiphonia*, a genus which bears tetraspores, is now before us, fully worked out by S. Yamanouchi.⁴

He finds in *P. violacea* that the carpospore on germination shows 40 chromosomes, and that the same number appear in the vegetative mitoses of the tetrasporic plant: so that it may be inferred that the tetrasporic plants come from carpospores. The tetraspore on germination shows 20 chromosomes, and the same number appear in the vegetative mitoses of the sexual plant: so it may be inferred that the sexual plants come from tetraspores. The nuclei of the gametes contain each 20 chromosomes: the fusion-nucleus in the fertilised carpegonium has 40 chromosomes, and gives rise to a series of nuclei in the central cell: some of these enter the carpospores, which are consequently a part of the sporophytic

¹ Strasburger, *Pringsh. Jahrb.*, 1897; Farmer, *Phil. Trans.*, B. 1898.

² *Morphologie u. Biologie der Algen*, 1904-5.

³ Wolfe, "Cytological studies on *Nemalion*," *Annals of Botany*, 1904, p. 607.

⁴ *Bot. Gazette*, 1906, p. 401.

phase to be continued in the tetrasporic plant. Tetraspore-formation terminates the sporophytic phase with typical reduction-phenomena, so that the tetraspores are prepared to develop the gametophyte generation. There is thus an alternation of a haploid, gametophytic phase with a diploid, sporophytic phase in the life-history of *Polysiphonia*, the cystocarp being included as an early part of the latter.

It appears, then, from the two types in which alone the cytological details are as yet available, that there is a want of uniformity of the cycle within the Florideae, not unlike that already noted for the Phaeophyceae. The alternation in *Nemalion*, where there are no tetraspores, is of a more restricted type than that in *Polysiphonia*: for in the former reduction appears to follow comparatively soon after the fertilisation, but in the latter the event is deferred till the diploid plant produces tetraspores. Yamanouchi suggests that the tetrasporic plant may have arisen by a suppression of the reduction-phenomena in connection with the carpospore, so that it germinates still with the sporophytic number of chromosomes, producing a diploid plant, and that the first tetraspore-mother cells probably corresponded to monospores produced on the sexual plant of the simpler type, since such reproductive cells would very naturally become the seat of the delayed reduction-phenomena. This is a possible, though a somewhat bold hypothesis. It may be anticipated that as the details become more fully known for the Florideae, a comparative basis, illustrated by intermediate steps, may provide more certain knowledge of the relation of these extreme types of cytological difference. At the moment it is interesting to see how great these differences are in the Florideae, as they have also been found to be in the Phaeophyceae: moreover, they are marked by no corresponding differences of external form: there is no haploid type of plant distinct from the diploid. This fact is probably referable to the uniformity of the conditions under which both generations live; but it also has its own interest in relation with what has been seen in the Archegoniatae: for there it has been shown that a gametophyte may be either haploid or diploid without any modification of form.

In certain Fungi also there has long been a suspicion that there is a somewhat similar alternation, and recent observations have tended to demonstrate that here also a cytological basis exists in some cases. The records of nuclear fusion in Fungi are rapidly increasing: in some cases in which such fusion may properly be held to be of a sexual nature, a doubling of the chromosomes has been observed in the post-sexual divisions; but it has been found more difficult to locate the necessary reduction exactly: among the Fungi there seems indeed to be the same want of general uniformity in this as in the Algae. For instance, in the Peronosporae, though the observations on *Peronospora* and on *Albugo* (*Cystofus*) are somewhat divergent,¹ there are several records of nuclear

¹Wager, *Annals of Botany*, iv., p. 127, x., p. 295, xiv., p. 263; Berlese, *Jahr. f. wiss. Bot.*, xxxi., p. 150; Stevens, *Bot. Gaz.*, xxviii., p. 149.

fusion with consequent doubling of the chromosome-number taking place on fertilisation, but actual chromosome-counting is difficult. There is, on the other hand, notwithstanding earlier statements which tended to locate reduction at the germination of the oospore, a growing opinion, based in part on exact counting, that the reduction in these plants is pre-sexual, and takes place at the maturing of the oogonium and antheridium. This receives considerable support from Trow's results on *Achlya*:¹ he finds that doubling occurs as usual on fertilisation, but the necessary reduction takes place in gametogenesis in this plant, as in most animals, and not in sporogenesis, as in most plants. Such a conclusion from the Saprolegniae would thus correspond to what seems probable for the Peronosporae: it has also been seen to be probable according to some writers for *Vaucheria*, and has been conspicuously proved for *Fucus*. In such plants the chromosome-number in the somatic divisions will be "2n," as in animals, and there will be an absence of cytologically distinct generations with obligatory alternation.

There are various cases among the higher Fungi in which, on grounds of comparison of form combined with nuclear fusion, a sexual process is now recognised, for instance in the simpler Ascomycetes. Here the carpogonium has long been regarded as a female organ, and the pollinodium male; a position which is now justified by the nuclear fusions observed. It naturally follows to regard the ascogenous hyphae as a post-sexual stage analogous to that in the Florideae: they hold the same place in the life-cycle as the carpogonial filaments of the latter. The condition of this stage as regards chromosome-number is still a matter of doubt; but there is some reason for believing that reduction may take place on formation of the ascospores, while their number in each ascus is in itself suggestive. Further observations will be required to show how far such comparisons have a cytological justification.

But in the Uredineae the case for an alternation based upon cytological detail has been fully made out for *Gymnosporangium* and *Phragmidium*, the facts being as follows:² The mycelium which bears aecidia and spermogonia has single nuclei: each is usually in a separate cell, and shows two chromatin-masses on division. This stage is compared with a gametophyte, capable of bearing sexual organs. The spermatia are held to be functionless male cells, and fertilisation is effected by other means. The young aecidium is held to be a sorus of female reproductive organs, each of which may be fertilised by the migration into it of the nucleus of one of the adjoining undifferentiated mycelial cells. The male and female nuclei do not fuse, however, but continue to divide simultaneously, and the product of fertilisation is accordingly a growth with paired nuclei: this condition is persistent throughout the rest of the life-cycle, including the aecidiospores, the mycelium which germinates from them, the

¹ *Annals of Botany*, xviii., p. 541.

² V. H. Blackman, *Annals of Botany*, xviii., p. 323, etc.

uredospores, and the teleutospores: these collectively are compared with a sporophyte-generation, and all show in their cells the paired nuclei, which divide in close association together, showing on division four chromatin-masses. The final nuclear fusion takes place in the maturing teleutospore, while the subsequent division of the fusion-nucleus shows changes which correspond to synapsis: at the same time there is a reduction of the chromatin-masses from the four characteristic of the paired nuclei collectively, to two. It seems thus clear that an alternation of phases, the one with "n," the other with "2n" chromatin-masses exists. It is known to be obligatory in those Uredineae which show the full cycle, and the limits of the two generations coincide respectively with a process of fertilisation (with suspended nuclear fusion), and a process of reduction. It is therefore comparable in its broad cytological features with the obligatory alternation seen elsewhere. The analogy with the Florideae is here again so obvious as to have led to the suggestion of some phyletic relation of the Uredineae with that group. As a corollary on these observations and conclusions, it has been further suggested that the absence of sexuality in the Basidiomycetes may be due to an apogamous shortening of the life-cycle, so as to omit the sexual stage altogether.

There remain for consideration certain of the Algae, which show post-sexual complications of an obligatory nature: they have been reserved to the last because they have long been singled out as those Thallophytes which most naturally suggest the manner in which the alternation in the Archegoniatae may have originated. An important feature in them is, that in close relation to the sexual fusion, rearrangements of nuclear condition occur; in some, these precede the act of fusion, though commonly they follow it; but in either alternative an apparently obligatory phase is associated with sexual fusion in the life-cycle, and there is good reason to think that its existence is bound up with the post-sexual reduction. This has been specially remarked by Strasburger in connection with the germination of zygotes in the Conjugatae¹ and in various Chlorophyceae. The actual fact of post-sexual reduction has not yet been established in them by chromosome-counting; but the fact that the post-sexual divisions of the nuclei are commonly into four, shows a pregnant analogy with tetrad-division, while in some cases the four nuclei are formed notwithstanding that only two are eventually required. This would hardly have been the case unless there were some importance attached to the division into four. Examples will now be given illustrating these points.

In the unicellular Desmids, where no somatic complications arise, conjugation and germination of the zygote have been studied by Klebahn, whose drawings of *Closterium* are here reproduced (Fig. 40).² The nuclei of the conjugating cells remain apart throughout the winter in the resting zygote (Fig. 40. 1), and only coalesce when germination begins in the spring: the contents escape from the thin-walled zygote, and division of

¹ *Ueber Reduktion theilung*, etc., 1900, p. 83.

² *Pringsh. Jahrb.*, vol. xxii

the fusion-nucleus soon follows (Fig. 40. 2, 3): this is succeeded by further mitosis (Fig. 40. 4), with the result that four nuclei are formed: two of these are larger than the other two, and a pair of nuclei of unequal size, one small the other large, finds its place in each of the two cells into which the zygote divides (Fig. 40. 5, 6). Of these nuclei the smaller one in each cell disappears, and it is thought that it becomes disorganised, while the other remains as the definitive nucleus of the new *Closterium* cell.

Certain Diatoms show on conjugation a singular parallelism of behaviour to this, but with important differences, and again it is to Klebahn that we owe the description of the details.¹ In the conjugation of *Rhopalodia*

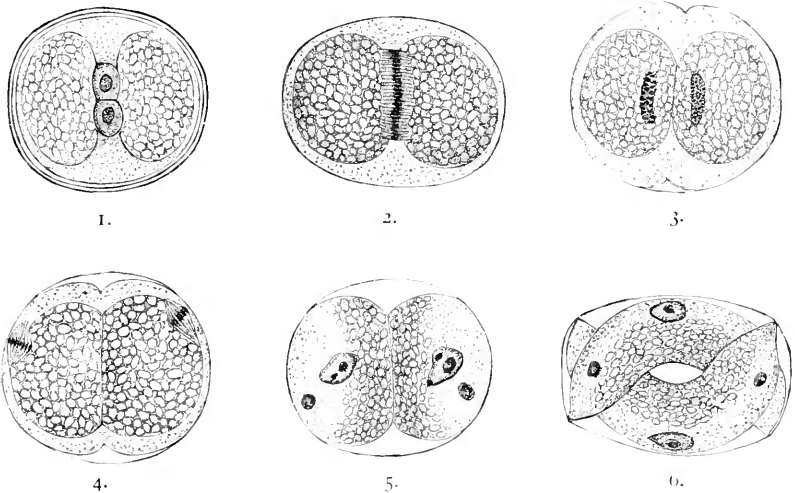

FIG. 41.

Germination of *Closterium*, after Klebahn. 1. Zygote before nuclear fusion. 2. First mitosis. 3. Bi-nuclear stage. 4. Second mitosis. 5. Bi-cellular stage with large and small nuclei. 6. Formation of the two germs. (From Oltmanns.)

(Fig. 41), the protoplasts of the two cells come into close relation, but the nuclei remain distinct (Fig. 41. 2), and undergo each a division into two, and again into four (Fig. 41. 3, 4): of these, two in each cell are soon reduced in size, while the others are distinguished by their larger size (Fig. 41. 4). Then comes an abstriction of each of the original protoplasts into halves, and each half contains two nuclei, one large and one small (Fig. 41. 5): these halves coalesce in pairs, and each fusion-pair finally develops into an auxospore (Fig. 41. 6, 7): the two larger nuclei of each pair meanwhile fuse, while the smaller nuclei become disorganised (Fig. 41. 8).

In these cases there is conjugation, and a tetrad-division of nuclei accompanies it. There is no evidence as yet of chromosome number,

¹ Pringsh. Jahrb., vol. xxix.

but in both cases half of the nuclei produced are discarded: this would seem to point to some special importance attaching to the division into

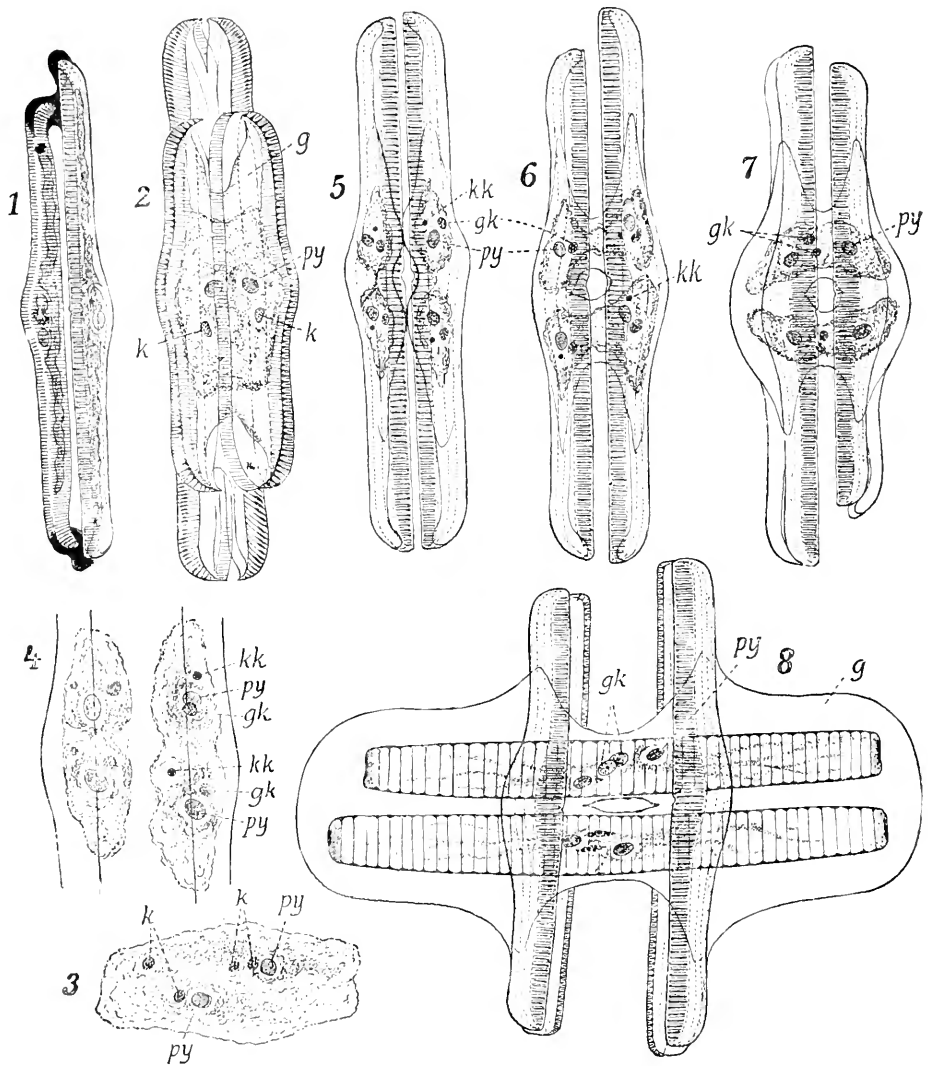

FIG. 41.

Conjugation of *Rhopalodia*, after Klebahn. *k*, nucleus; *kk*, small nucleus; *gk*, large nucleus; *py*, pyrenoid; *g*, mucilage. (From Oltmanns.)

four, and by analogy with what is seen elsewhere it would appear probable that the importance lies in a process of reduction accompanying it. Whatever the actual cytological condition may be, at all events this is clear, that, in these strangely similar plants, the tetrad-division of the nuclei

in the Diatom immediately *precedes* conjugation, while in the Desmid it immediately *follows* on conjugation. This fact is important for comparison with the order of events in other Thallophytes.

The post-sexual phase in *Ulothrix*, *Oedogonium*, and *Coleochaete* has been frequently brought into comparison with that of the Bryophytes, but the necessary details are still very imperfect as regards their nuclei. In *Ulothrix* the zygote is formed by the fusion of two motile gametes, and after encystment it undergoes a period of rest: parthenospores similar to the zygotes are also produced, as shown by Klebs,¹ when the sexual cells are exposed to a 0.5% culture solution: these also undergo a period of rest. On germination it is found that in either case there is a division of the contents into non-motile cells, which grow directly into new filaments. But apparently there is this difference, that the parthenospores form only two of these, while the zygotes form four. If this be constantly so, the point has a special interest as indicating that the tetrad-division is a consequence of sexual fusion, and need not happen unless the fusion be carried out. In a similar way the zygote of *Oedogonium* divides on germination into four, a number which suggests reduction; it is quite possible that the exceptions to this noted by Pringsheim,² may be explained on the ground of parthenogenesis, as in *Ulothrix*. The cell-body formed on germination of the zygote of *Coleochaete* is that which has most frequently been compared with the simplest sporogonia of Bryophytes. In this plant nuclear fusion has been observed in the ovum (Fig. 42. 6, 7), after which the zygote undergoes a period of rest, as a unicellular, uninucleate body, covered by a pseudoparenchymatous coat. On germination a transverse wall is formed at right angles to the axis of the oogonium: then follow longitudinal walls to form octants, and these usually divide further till 8-16 cells are formed in each hemisphere. The outer coat then bursts about the region of the transverse wall, and a zoospore is formed from each of the cells, which germinates like any ordinary zoospore. The question of homology of this body with a simple sporophyte has recently been decided by observations made by C. E. Allen³: he found that reduction takes place, with characteristic synapsis, on the first nuclear division in the germinating zygote. The cells of the "fruit-body" are then haploid, and correspond cytologically with the gametophyte, not with the sporophyte as had been commonly assumed. But there is no need as an alternative to hold this body as in any sense a derivative of the ordinary *Coleochaete* thallus: it seems more natural to see in it merely an extension of the usual tetrad; for if the second division of a normal tetrad were in this case repeated twice or thrice, a cell-group would result just as is seen in *Coleochaete*, and the biological advantage of increase in number of the progeny would thus be secured. Morphologically such

¹ *Bedingungen der Fortpflanzung*, p. 321.

² *Gesammelte Abhandlungen*, i., p. 251.

³ *Ber. d. D. Bot. Ges.*, 1905, p. 285.

a development stands hitherto alone,¹ but biologically it occupies the same place as a simple sporophyte.

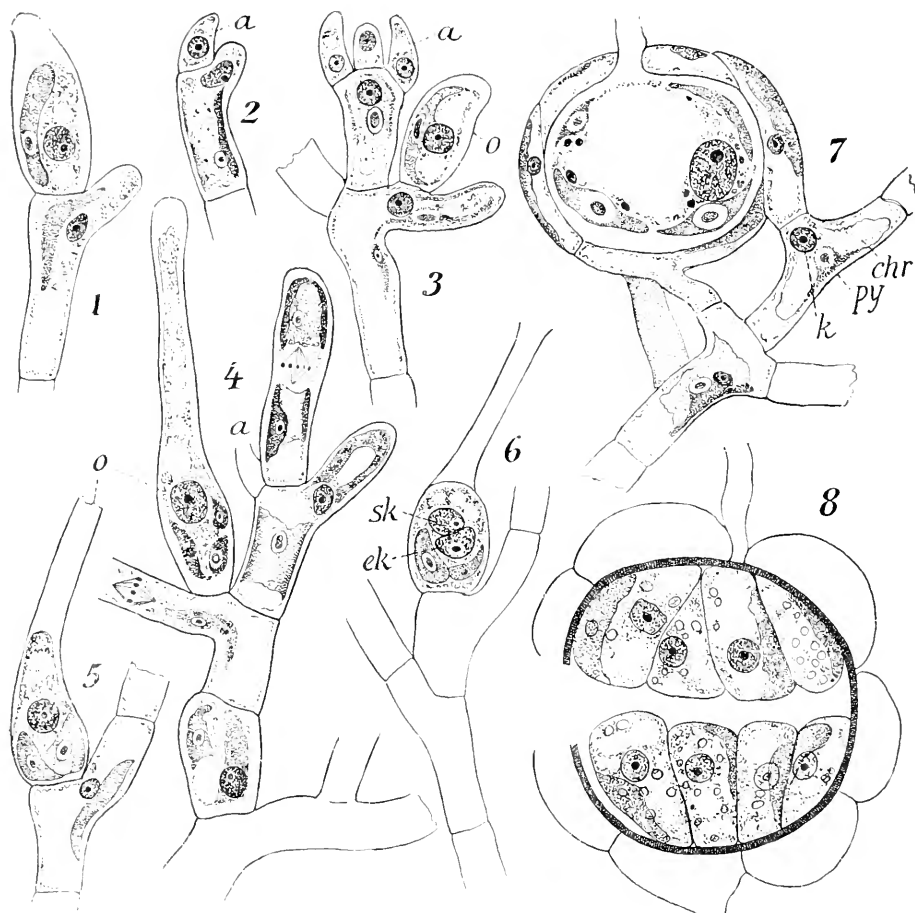

FIG. 42.

Coleochaete pulvinata, after Oltmanns. 1, Young zoosporangium (?). 2, 3, Antheridia (a) and young oogonium (o). 4, Oogonium shortly before opening. 5, Ditto after opening. 6, Zygote still with two nuclei. 7, Zygote developed to "fruit." 8, Germinating hypozygote. a, Antheridium. o, Oogonium. sk, Male nucleus. ek, Female nucleus. chr, Chromatophore. py, Pyrenoid. k, Nucleus.

Though the cases are thus seen to be still comparatively few in which the Thallophytes have had their cytological condition traced throughout the whole course of the individual life, there is a growing body of evidence to show that an obligatory alternation of cytologically distinct generations

¹It is possible that the multicellular spores of Ascomycetes supply a parallel. If, as is probable, the reduction accompanies the formation of the ascospores, then the subsequent divisions in those spores would hold a similar place in the cytological cycle to those in the fruit of *Coleochaete*.

exists among them. According to the criterion of chromosome-difference there may be recognised a haploid, pre-sexual phase, characterised by having "n" chromosomes—this corresponds cytologically to what has been termed elsewhere the gametophyte; and a diploid, post-sexual stage, characterised by having "2n" chromosomes—this corresponds in this respect at least to the sporophyte. The alternation of these phases depends primarily upon sexuality, which doubles the chromosome-number. The reduction of the chromosome-number to one half appears to be a necessary consequence of it, and the process by which the original number is restored is found to be commonly associated, here as elsewhere, with a tetrad-division.

As Professor V. H. Blackman has pointed out (*loc. cit.*, p. 364), three nuclear stages are to be observed in the sexual cycle of animals and plants: *nuclear association* by fusion of the protoplasts which contain them; *nuclear reduction, or fusion*, which doubles the chromosome-number; and *chromosome-reduction*, by which their number is halved. Of these three stages the second may take place at the same time as the first, or it may be delayed for a short time, as in *Spirogyra* or *Cosmarium*: or, as in the Uredineae, it may be delayed until the stage corresponding to chromosome-reduction. According to the relative time of these successive nuclear stages the sexual cycle may vary greatly, as we see that it does in the Thallophytes: and three leading types of the cycle emerge, though they severally may graduate into one another by intermediate steps: they include:

1. *Those in which reduction immediately precedes gametogenesis and sexual fusion.* The order of events would then be (a) somatic division with "2n" chromosomes: (b) chromosome-reduction: (c) gametogenesis and sexual fusion. This is the case generally for animals: in plants the best demonstration has been in *Fucus*: it is also seen probably in *Rhopalodia*; but it probably occurs also in many of those Thallophytes which have no obligatory succession of phases, and especially in *Achlya*, and probably in the Peronosporae.

2. *Those in which reduction immediately follows on sexual fusion.* The order of events in these would be (a) somatic division with "n" chromosomes: (b) gametogenesis with sexual fusion: (c) chromosome-reduction. This is probably the case in Desmids and other Conjugatae, and in the filamentous Chlorophyceae, including *Coleochaete*.

3. *Those in which a somatic phase of some extent intervenes between sexual fusion and reduction, and again between reduction and sexual fusion.* This is seen in *Dictyota*, probably in the simpler Ascomycetes, in Uredineae, and Florideae: it is comparable with what is seen in the Archegoniate series.

It is interesting to compare the grouping of types of alternation as thus stated with the position adopted by Celakovsky in his paper which was published some thirty years ago at Prag.¹ The data, both physiological and cytological, are now much more precise, though still very deficient.

¹*Sitz. d. Ges. d. Wiss. in Prag*, 1874, p. 30.

The criterion of chromosome-number is new: the method of physiological experiment is also new. Still, the conclusions are in the main unaltered. What was then styled "homologous alternation" now stands on a basis of cytological unity as regards the somatic divisions, and denotes such recurrent phases in plants as appear to be dependent on external condition, not obligatory in their succession, and involve no cytological change: this includes the cases grouped under (1) and (2) above. There is hardly any need to designate such life-cycles as showing alternation at all, were it not that this is the type of life-history for which the term was first introduced by the zoologist Steenstrup. The types grouped above under the heading (3) were distinguished by Celakovsky as showing "antithetic alternation," and it is now found to have its basis in a cytological difference of the successive phases, which also show an obligatory succession, not determined directly by external conditions.

The conception of normal antithetic alternation now turns upon the two critical points of sexual fusion and reduction: it is necessary to enquire how far these events are historically the same in organisms at large. It would seem probable that sexual differentiation, and perhaps even sex itself originated along several distinct phyletic lines: on this point there is no definite information, though the differences of character of the organisms which show the simplest types of sexuality distinctly suggest that it had not one common source only. In the present state of uncertainty it seems undesirable to depart from the usual convention by which the zygote is held to be "homologous"; and, accordingly, it serves as a point for general comparison between representatives of distinct phyla. But it must be distinctly understood that this is in itself a conventional understanding, and that its adoption for convenience of description does not necessarily imply a strict "homogeny," in the sense that sexuality was established once for all. Similarly with reduction, which is theoretically a necessary consequence of sexual fusion, it is only by a similar conventional understanding that in divers organisms the cell where this is initiated is held to be "homologous": it is not to be assumed that it is truly "homogenetic" in distinct phyla, as though reduction had been initiated once for all in sexual organisms. But, on the other hand, in organisms that are akin, such as the members of the phyla of the Ferns or the Mosses, it may reasonably be held as probable that the zygote and the spore-mother-cell are actually identical things, in fact homogenetic for the whole phylum, in the sense that each probably sprang from a phyletic source common for the whole phylum.

A comparison of plants at large as regards the position of the reducing process in the life-cycle relative to sexual fusion shows great differences, as we have seen. It is not improbable that these may have been due in part to initial differences: we have no right to assume that there was uniformity at the outset. Some ground for the view that initial differences existed is to be found in such cases as the Desmids and Diatoms; for in *Closterium* the rejection of the superfluous nuclei, and probably also

reduction, follows on nuclear fusion, while in *Rhopalodia* these events precede nuclear fusion. Such cases seem to point to a probability that the problem of reduction was solved independently and in different ways in different lines of descent.

Nevertheless the term sporophyte has been adopted as applicable collectively to the non-sexual phase which intervenes between sexual fusion and reduction in those plants in which it occurs. But, following the above reasoning, it must not be understood to convey necessarily any community of descent for all the bodies which it covers. It seems probable that the establishment of the sporophyte, whether by a process of intercalation or otherwise, has taken place independently in several distinct phyla: thus the sporophyte-stage in them, though in some more lax sense it may be styled "homologous," is not to be held as "homogenetic"; nevertheless, useful analogies may be drawn between the corresponding phases in distinct phyletic lines.

But, on the other hand, comparison within groups that are held to be akin gives strong reason for recognising that there has been a shifting of position of the event of chromosome-reduction in certain lines of descent, and that the balance of the generations has thus been altered in the evolutionary course. For instance, it seems probable that in the Uredineae there has been a deferring of the event of reduction after sexuality, with the result that the binuclear phase has attained considerable dimensions; the same seems probable also for the Ascomycetous Fungi, though along a quite distinct line. A similar intercalation has been suggested in the Florideae. Such conclusions can only become cogent when the cytological details are known in a large number of related forms. But the most familiar, and at the same time the most prominent and permanent example is that of the Archegoniatae: in these there is a strong comparative basis for the belief that the sporophyte stage has been intercalated, or in any case greatly extended, in consequence of the deferring of the event of chromosome-reduction. It may be a question whether the post-sexual stage in the life-history of certain green Algae represents any phyletic predecessor of the sporophyte of the Archegoniatae: it is quite probable that it did not. But this much is clear, that it occupies the same position in the life-cycle, and it gives at least the suggestion how the Archegoniate sporophyte may have originated. According to the antithetic theory as applied to the Archegoniatae, the complications of post-sexual nuclear reduction, involving, as they are seen to do, at least four nucleated cells, supplied the starting-point for a diploid somatic expansion. That is the theory which is adopted here as reflecting the probable mode of origin of the alternation in the Archegoniate series. But it is only right to acknowledge that it is not fully demonstrated either by the cytological facts, or by comparison with the alternation in the Thallophytes. The latter can only supply suggestive analogies so long as the actual phyletic origin of the Archegoniatae remains as obscure as it now is. It becomes, accordingly, an object of all

the greater interest to trace such internal evidence as there is of the method and manner of the intercalation of the diploid phase in the life-history of the Archegoniatae: and an important question will be what circumstances they probably were which conduced to fixing permanently the alternation that resulted, and to making it so constant a feature as it has been in the upward development of the green plants of the Land. This will form the subject of the next chapter.

CHAPTER VI.

THE BIOLOGICAL ASPECT OF ALTERNATION.

THE phenomenon of Alternation of Generations may be viewed in various ways, and the history of the science shows that the different aspects of this subject have presented themselves in a natural succession according to the progress of biological thought. First it seemed sufficient merely to observe the fact that successive, more or less distinct phases occur in the life of the individual in certain groups of plants. In the case of the Pteridophytes this was the gradually achieved result of the labours of various workers antecedent to or contemporary with Hofmeister; but subsequently the discovery of a similar succession of phases in other organisms than those in which it was first observed suggested at once their comparison: such comparison was placed upon a secure footing for Archegoniate plants by Hofmeister himself. Then followed the pursuit of such comparisons into the region of the lower and simpler Thallophytes; but this led to some confusion at first, owing to premature attempts to reduce all organisms which show sexuality to one rigid scheme as regards the successive phases of their lives. On the other hand, in similar comparisons with the higher Flowering plants, the issues were temporarily obscured by discussions over "the Alternation of Shoots" found in some of them, and by the confounding of this with Alternation of the more fundamentally distinct Generations seen in the Archegoniatae. But these temporary clouds were in great measure cleared away by Celakovsky, when he drew the distinction between "Homologous" and "Antithetic" Alternation. His comparisons, however, were still, like those of Hofmeister and of Sachs, based essentially on form; nevertheless, he arrived at conclusions which we have seen in a previous chapter to coincide very nearly with the opinions current at the present day, and this notwithstanding that those opinions are now based on facts which were quite inaccessible to him. The writings of Celakovsky may be said to have brought the formal study of Alternation to a close. His conclusions were widely accepted at the time, though Botanists of the weight and standing of Pringsheim still stood aloof from them.¹

¹ *Pringsh. Jahrb.*, Bd. ix., 1878, also Scott, *British Association Report*, Liverpool. 1896. Address to the Botanical Section.

The succeeding phase of the history has been one involving first physiological and subsequently minute cytological considerations. The study of the effect of external conditions on the succession of stages of the developing organism, initiated by Klebs in 1889, led at once to the recognition of the fact that in certain plants that succession is mutable according to circumstances, while in others the succession is obligatory. The distinction between different types of the life-cycle of organisms thus established was found to coincide very nearly with the distinction drawn by Celakovsky between "homologous" and "antithetic" alternation, and thus his general position came to be greatly strengthened. But another effect of the experimental test was to open up more definitely than before the problem of origin of this obligatory succession of phases, in those cases where it exists: it also accentuated the difference between the antithetic or true alternation, and those other appearances which bear a superficial resemblance to it. But meanwhile the question of the rise of the neutral generation was being approached also from the point of view of adaptation, and a theory of its origin in an amphibious mode of life, which it will be the object of this chapter to develop, was already being advanced as an explanation of the progress and final dominance of the sporophyte in the plants of the land. It is clear, however, that adaptation would only account for its advance, not for its ultimate origin. This amphibious theory was based upon physiological considerations, together with closer observation of the origin of the sporogenous cells, their limitations, and their relation to the tissues which are merely vegetative. Lastly, more careful observation of the details of sexuality and of spore-production led to the generalisation on the basis of minute nuclear structure: this put the cytological cachet, as well as a structural check upon the conclusions already drawn. But the existence of a chromosome-difference between the two generations turns attention afresh to the question of the ultimate origin of the obligatory succession of phases: it suggests that the origin was in sexuality, and in those post-sexual complications which are so frequently the consequence of nuclear fusion. Naturally these several phases of the study of alternation have overlapped one another, and proceeded in some degree coincidentally. One of the interesting features in the history is that their results have often run so nearly parallel as to yield a high degree of mutual support.

It has been remarked above that up to the time of Celakovsky the study of alternation was on the basis of form; but it is now clear that the merely formal comparison of different organisms, or of their successive stages one with another, cannot suffice for the full solution of the question as to the real nature of alternation. The case of the structurally similar but cytologically distinct generations of *Diclyota* show this, while the difference of the propagative organs which they bear confirms the distinctness of the two generations. In the Florideae also, there are no definite structural details which serve as formal differentiating characters between the pre-sexual and the post-sexual stages. Such examples will probably be multiplied as

cytological investigation progresses, but those quoted will suffice to show that, for those who accept the cytological distinction of the alternating generations, the mere distinction on ground of form is insufficient.

The existence of certain cases of alternation, demonstrated cytologically, where, as in *Dictyota*, the form of the two generations is substantially the same, and of other cases in which, as in the Archegoniatae, the generations differ fundamentally in form as well as in points of structure, raises a physiological question which has wide bearings. The external conditions to which, in the past as well as now, the two generations have been or are exposed must be considered in their relation to such differences. Now, in *Dictyota*, and also in *Polysiphonia*, since the two forms grow on the same coasts, at the same time, and about the same spots, it is obvious that the conditions to which they are exposed are substantially the same: knowing how closely form is dependent upon circumstance it is not surprising that the two generations should be so much alike.

In the case of the Uredineae, again, the external circumstances of the two cytologically distinct stages of the life are alike, both being internally parasitic: in form their mycelial stages are also alike, and their difference of character only becomes apparent on the formation of the propagative organs. Similar remarks will apply, perhaps with less cogency, to the post-sexual developments in certain Ascomycetes, the circumstances of which do not differ materially from those of the pre-sexual phase, and in this may be seen some illumination of the fact that they show for the most part mere variants upon the simple filamentous form. Thus, for certain Thallophytes in which cytologically distinct generations have been recognised, there is a remarkable similarity in form of the two generations: this probably finds its true explanation in the fact that the biological conditions to which they are respectively exposed are relatively uniform, and have been so throughout their descent.

But with the Archegoniatae the case is quite different: the cytologically distinct and alternating generations differ widely in their characters of form and structure. The question, therefore, presents itself, what is the biological and ultimately the phylogenetic bearing of this very obvious, and at the same time widespread fact? Far-reaching it is indeed, for it affects all the characteristic vegetation of the land. Taking, first, as the most prominent example, a typical Fern, the gametophyte, or prothallus, shows in its more delicate structure and in its habit, as well as in the way in which the sexual process is effected, an adaptation to moist conditions, under which it grows best; while its ultimate function, that of sexual reproduction, cannot be carried out without the presence of external fluid water: it is, in fact, typically semi-aquatic in its nature, sharing many of its main characters with the green Algae from which we have some reason to believe that the land-flora originated. The sporophyte, on the other hand, is fitted by its more robust texture, as well as by its differentiation of tissues, for successfully enduring exposure

to the air under comparatively dry circumstances, while dry weather is important for the dispersal of the spores, which it is the final function of the sporophyte to produce: thus the Fern, as we normally see it, is an organism with, so to speak, one foot in the water, the other on the land.

Calling in also such evidence from phylogeny as we can command, it will be generally accepted that the gametophyte is the older and pre-existent generation; it corresponds to the gametophyte as seen in the Liverworts, or in the green Algae: and if we trace the descent of the Archegoniate series from some green Algal forms, we may recognise that the gametophyte of the Ferns retains the chief Algal characters, as regards both its texture and its sexual process. The sporophyte, on the other hand, is the younger generation: among the present green Algae there is hardly any body strictly comparable to the sporophyte, nor is it to be expected that there should be, if, as above stated, the sporophyte is typically sub-aerial in its characters, while the green Algae are typically aquatic. A comparison of the successive families of the Archegoniate series suggests the progress of the sporophyte, from small beginnings, as illustrated in the Bryophytes, to larger size and greater complexity of form and structure, as seen in the Vascular Cryptogams and Gymnosperms: its advance is accompanied by a corresponding reduction of the gametophyte, and the whole is to be correlated with a progression from the aquatic or semi-aquatic habit of the lower forms, to the very distinctly sub-aerial habit of the higher. It may accordingly be concluded that the alternation which is so prominent in the main Archegoniate series is the result of adaptation of originally aquatic organisms to sub-aerial conditions of life: it may, in fact, be distinguished physiologically as an amphibious alternation, which finds its morphological expression in the difference of external form and internal structure between the more ancient gametophyte and the more recent sporophyte.

It is an important fact that in the main Archegoniate series the antithetic alternation is normally constant, though the balance of the two generations may vary: the constancy of the phenomenon makes us enquire why it should be so: the circumstances which have encouraged this constancy seem to have been these. The Archegoniate series probably sprang from green aquatic forms, inhabiting, as so many of the green Algae now do, shallow fresh water, or the higher levels between the marine tide-marks: the sexual reproduction was effected through the means of external water, and if other conditions were favourable it could be carried out at any time through the water which was always present. Certain forms, perhaps thereby escaping from competition, spread to the land, where access of water was only an occasional occurrence: in these the sexual process could only be effected at time of rains or floods or copious dews; and even then might not take place unless the sexual organs were fully mature: thus less dependence could be placed upon sexuality for propagation, and an alternative method of increase of individuals

had to be substituted. This was done by the production of the sporophyte from the zygote: once fertilised a zygote might in these plants divide up into a number of portions (carpospores), each of which would then serve as a starting-point for a new individual; and dry circumstances, under which they would be powdery, would favour their dispersion, as in the lower Liverworts. In proportion as these plants spread to higher and drier levels (in accordance with the advantage which they gained by escape from competition, and more free exposure to light for assimilation) the chance of a frequent recurrence of the circumstances necessary for sexual reproduction would be diminished, and the dependence upon carpospores for propagation would increase; consequently the number of spores produced by each sexually formed sporophyte must be larger, if the race is to survive, and be in a position to compete. Any increase in the number of spores entails greater supply of nourishment during their formation: this in the phylum of the Bryophytes is chiefly supplied from the gametophyte, which shows distinct adaptation to sub-aerial habit, while the means of nutrition on the part of the sporophyte itself are in these plants very limited, and the external morphological complexity of it very slight. In other phyla, however, such as the Filicales, Lycopodiales, and Equisetales, the sporophyte itself assumed the function of nutrition: a higher morphological differentiation of the parts followed, and a more clear distinction between the organs which were to supply the nutriment (stem, leaves, and roots), and the parts devoted to the formation of spores (sporangia): this for the first time stamped the sporophyte with a character of independence and permanence, while the number of spores produced might now be practically unlimited: in these respects the Pteridophytes are immeasurably superior to the Bryophytes. One strange point in the whole story is, however, the tenacity with which these plants (under the obvious disadvantages which it entails when their habit is sub-aerial) retain their aquatic type of fertilisation: it is only when we reach the Phanerogams, where the sporophyte attains its climax while the gametophyte is almost abortive, that we see the sexual process accommodated to that sub-aerial life which had led to the dominant position of the sporophyte: for in them the fertilisation is siphonogamic, being carried on by the pollen-tube: these plants are therefore independent of external fluid water for their fertilisation, and this fact has doubtless contributed largely to their present ascendancy. When, as in the preceding sketch, we consider what the results of the migration from water to land must have been, the permanence and constancy of the antithetic alternation explains itself. The permanence or morphological fixity of a phenomenon in any phylum is in a sense proportional to its importance in the well-being of the organisms: given a conservatism in the mode of fertilisation (which it is difficult to explain), the rise and progress of the sporophyte in the Archegoniate series appears to be a natural outcome of the migration from water to land.

The biological, or adaptation theory of antithetic alternation in the Archegoniatae, as embodied in the above paragraphs, was stated in my paper on alternation published in 1890.¹ In 1894 came Strasburger's Address on Periodic Reduction, delivered at the British Association meeting at Oxford.² He there introduced as a structural basis of antithetic alternation that cytological distinction of the two generations which had already been suggested by Overton:³ this at once gave a definiteness to alternation which it had never possessed before. He adopted a view similar to that above stated, as a biological explanation of the rise and final dominance of the sporophyte, and pointed out how its gradual development can actually be traced, the first indications of it being apparently to be found in the Algae: they are to be sought in such post-sexual complications, connected probably with reduction, as are seen in *Oedogonium*. There is, however, no direct evidence of the origin of any Archegoniate form from any Alga: all that can be said is that, given such a multicellular body as the post-sexual stage of certain green Algae, the biological conditions of migration from water to land and of an amphibious life will sufficiently account for the further advances which are exemplified in land-plants.

This is, then, the working hypothesis which will form the basis for our further enquiry. It will be necessary, however, to analyse the advance of the sporophyte, which is thus contemplated, from its simpler beginnings, and to consider the several factors which have been involved. Having done this, the enquiry will be made, what evidence there is in plants, living or fossil, that these factors of advance have actually been operative. The initial factor appears to have been "sterilisation," that is, the delay of reduction by the conversion of cells which are potentially, and were ancestrally, sporogenous, into cells which serve no longer a propagative but a vegetative function. It will be readily seen that this is a necessary biological consequence of any considerable increase in the number of spores: and it has been pointed out above that such increase is a biological advantage, especially in those plants where a land-habit places restrictions upon increase in numbers by sexual propagation. The larger the number of spores the greater the powers of competition, and the greater the probability of survival, and of spread. On a biological theory, the nutrition of the increasing number was secured by the conversion of some of the potential germs to form a vegetative system, which should provide for nutrition and protection. It was naturally important that these tissues should be established in the individual before the sporogenous tissue which it is their function to nurse: and accordingly the time of spore-production was deferred, and a vegetative system, ultimately of great

¹ *Annals of Botany*, 1890, p. 347.

² *Annals of Botany*, viii., 1894; *Biol. Centralbl.*, Dec., 1894. A similar view has also been adopted by v. Wettstein, and embodied in his *Handbuch der Syst. Bot.*, Band ii., p. 13, published in 1903.

³ *Annals of Botany*, vii. (1893), p. 139.

extent, was intercalated. But spore-production follows sooner or later in the normal life of every sporophyte, even of the most elaborate; and in the constancy of this process in all normal life-cycles is to be seen one of the strongest supports of the antithetic theory.

A second factor has been the *segregation of sporogenous tissue*, which in the simpler forms is a concrete and continuous tract of cells, into numerous more or less distinct pockets, or *sporangia*. Closely connected with this, though not a necessary consequence of it, may follow the *increase or decrease in number of the sporangia* thus distinct from one another. There is good reason to believe that the methods of morphological advance in former times were not essentially different from those to be seen reflected in the plants of the present day. If that be so, then a careful study of the modes of variation of number of sporangia seen to be effective now, should indicate the methods which have led in the past to the condition seen in vascular plants, in which the number of sporangia is as a rule large.

A third factor has been the *origin of the appendicular organs of the shoot*, and the *origin of the roots*. These changes have more than anything else contributed to modification of the form of the plant-body. But though these were such important steps, the mode of origin of the appendicular organs and roots is still a subject for surmise rather than for definite opinion. If, however, the development of the individual be accepted as a guide, a reasonable view may be arrived at, which will be stated later.

Beyond these, which are the *three fundamental factors of advance of the growing sporophyte*, are others which, though later in point of time, have had very far-reaching effects upon the organisms in which they appeared; such, for instance, as the abortion of parts: the initiation of the heterosporous state, and of its ultimate consequence, the seed-habit: also the adoption of the siphonogamic fertilisation, and of the various adaptive methods for transfer of the pollen, as exemplified by the higher forms. These factors are all closely related to the process of spore-production, which we may regard in point of history to have been the primary function of the sporophyte.

On the other hand, the vegetative system, which we may regard as being collectively secondary in its origin, has shown many characters which may be held as adaptive. The differentiation of tissues has provided first the means of construction of fresh organic material within the sporophyte itself, so that in place of being a body dependent for its nutrition upon the parent gametophyte, it became a physiologically independent, self-nourishing organism. Further, the establishment of a conducting system secured the necessary facility of transfer of materials from point to point: this becomes specially necessary where the formation of appendicular organs has brought about a large proportion of external surface to bulk. Lastly, the appendicular organs themselves are open to differentiation, so as to subserve definite functions: such as, absorption,

carbon assimilation, protection, propagation, and a variety of more special duties.

In the present work it is not proposed to enter into any detailed discussion of those later evolutionary advances, which are more especially shown by the higher Seed-Plants. The attention will be chiefly directed to the more fundamental features involved in the establishment of the sporophyte as a factor in terrestrial vegetation, and chapters will be devoted to sterilisation, to the methods of increase and decrease in number of sporangia, and to the origin of appendicular organs. The attempt will be made to gather from living plants (and from fossils also as far as possible) such evidence as there is which will bear upon the working hypothesis sketched in its broad outlines above. For this is the only satisfactory way of testing its validity in the absence of more direct evidence. Definite proof of the truth of the biological theory of alternation need not be anticipated. What is possible is to show such a degree of reasonable probability as will justify its acceptance. For this the evidence available appears to be sufficient.

CHAPTER VII.

STERILISATION.

It has been the practice from early times of Descriptive Botany to designate the leaves which produce the sporangia in Ferns and other organisms as the *fertile* leaves, those which carry out a vegetative function only the *sterile* leaves. The similarity of form which these show one to another readily established their close relationship: middle forms are frequently found between them, partly sterile, partly fertile; and any conversion of the fertile into the sterile would, to preserve uniformity of terms, be designated a process of *sterilisation*. The term thus applied to a leaf, or a pinna as a whole, will be properly applied also to its constituent parts, and so ultimately to the individual cells composing them; and thus, wherever a cell that is normally sporogenous is diverted from that function to any vegetative office, the process may be styled one of sterilisation of that cell. It seems necessary thus to justify this use of the word, since recent investigation has attached a definite structural meaning to the change involved in those cells which are diverted from the office of spore-production. Its cytological significance lies in the fact that chromosome-reduction, characteristic of fertile cells, does not take place in them. Without the historical explanation it might appear strange to describe this change of nuclear behaviour as sterilisation; but on the grounds of old custom this term will be retained throughout the present discussion.

In the Archegoniatae and in Seed-Plants the *tetrad-division is the criterion of the fertile or sporogenous cell*. It is true that among the highly specialised Seed-Plants this tetrad-division may sometimes be omitted; but putting these exceptions aside, it is the formation of a spore-tetrad which is the final distinctive mark of a sporogenous cell as distinct from a vegetative cell. But long prior to the appearance of this distinctive condition the sporogenous cells may in most cases be recognised with a high degree of certainty. They commonly form a clearly defined *sporogenous group*, distinguished by the dense protoplasmic contents of its cells, and

in the later stages by their large nuclei. In Vascular Plants each sporogenous group is as a rule derived by division from a single cell, or a row or sheet of cells, and in favourable examples it may present the appearance of a compact mass of tissue, which may readily be referred in origin to a single parent cell (Fig. 43). But the details of those divisions which result in the sporogenous group show great diversity in different plants, while in a not inconsiderable number of cases the limits of the sporogenous group are not found to be strictly coterminous with the tissue-products of definite initial cells. It is only by a careful study of the successive stages of development in each individual type of spore-producing organ that it is possible to assign the limits of origin of its sporogenous group. When this has been done, and the genetic story completely made out, the

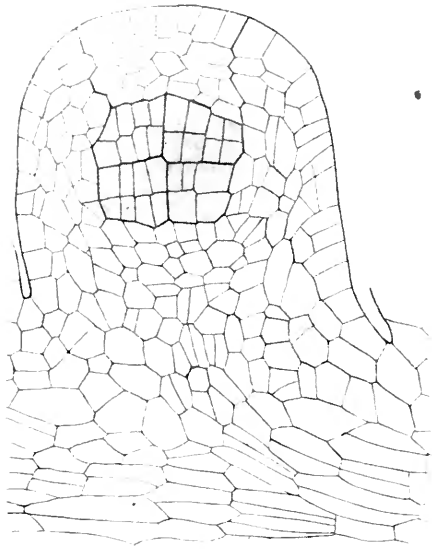

FIG. 43.

Botrychium daucifolium, Wall. Sporangium in vertical section, with the sporogenous tissue shaded. $\times 200$.

cell or cells which are found to be the ultimate parent-cells of a single sporogenous group are designated its *archesporium* (Fig. 44). The same terms are also applied in the case of the Bryophyta, the chief difference being that in them the sporogenous tissue of each individual forms only one concrete group.

In not a few cases the whole product of the archesporium becomes converted into spore-tetrads, and ultimately into spores; but this is not always so. It frequently happens that in the course of development certain cells which spring from the archesporium are diverted to other functions than that of direct spore-production; a good instance of this is seen in the sporangium of *Psilotum* (Fig. 45). It will be well to consider carefully how such a case as this is to be regarded from an evolutionary point of view, for it will be seen later that the same reasoning as is used in the present case is applicable to a great number of others also. Adequate investigation shows that in the sporangium of *Psilotum* all the cells of the sporogenous

group are not found to be strictly coterminous with the tissue-products of definite initial cells. It is only by a careful study of the successive stages of development in each individual type of spore-producing organ that it is possible to assign the limits of origin of its sporogenous group. When this has been done, and the genetic story completely made out, the

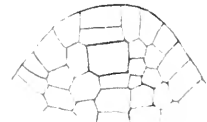
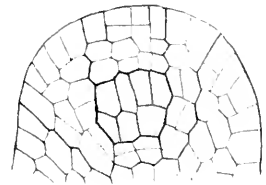

FIG. 44.

Botrychium daucifolium, Wall. Early stages of development of sporangia, showing by comparison that the sporogenous group originates from a single "archesporial" cell. $\times 200$.

group are not found to be strictly coterminous with the tissue-products of definite initial cells. It is only by a careful study of the successive stages of development in each individual type of spore-producing organ that it is possible to assign the limits of origin of its sporogenous group. When this has been done, and the genetic story completely made out, the

group have a common origin, and as sister cells they develop alike at first: they may therefore be held to be equipotential cells (Fig. 45 C). The conclusion that they are so is supported by comparison with plants having some degree of affinity with *Psilotum*, such as *Lycopodium*: here all the cells of a sporogenous group essentially similar to that of *Psilotum* are equipotential: all of them normally undergo the tetrad-division

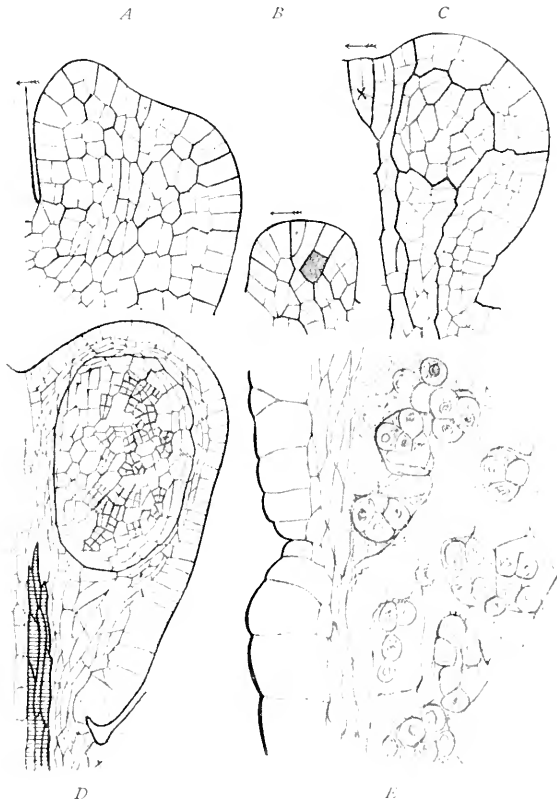

FIG. 45.

Psilotum triquetrum, Sw. Various stages of development of the synangium and sporangium. In C the sporogenous group is shaded. D shows the differentiation of its cells, the fertile cells being shaded. E shows the disorganisation of the remaining cells without forming spores. $\times 100$.

and develop spores. But in *Psilotum* the originally uniform group differentiates at a relatively late period into fertile and sterile cells, the former having dense protoplasm, and undergoing the tetrad-division: the latter having less dense protoplasm (Fig. 45 D): these become disorganised without tetrad-division, and their substance goes to nourish the young spores (Fig. 45 E). The conclusion to be drawn is that in *Psilotum* all the cells of the sporogenous mass are potentially sporogenous, as they are in *Lycopodium*, and probably were actually fertile in ancestral forms: that some of them have been *sterilised*, that is, diverted from

spore-production before the tetrad-division. It is a secondary matter morphologically that in this case their existence is brief; but physiologically it is important, for they are sacrificed to furnish better nutrition to the others which remain fertile, and produce spores. The structure seen in Fig. 45 is thus to be interpreted as indicating the *sterilisation of certain of the potentially fertile cells* in the sporogenous group of *Psilotum*.

A second example illustrating this partial sterilisation of a sporogenous group may be quoted: it is selected from among the Bryophytes; but the same arguments as in the previous case will equally apply here. Fig. 46 illustrates two stages in the development of the sporogonium of *Aneura*: the younger shows the clearly defined, hemispherical internal group

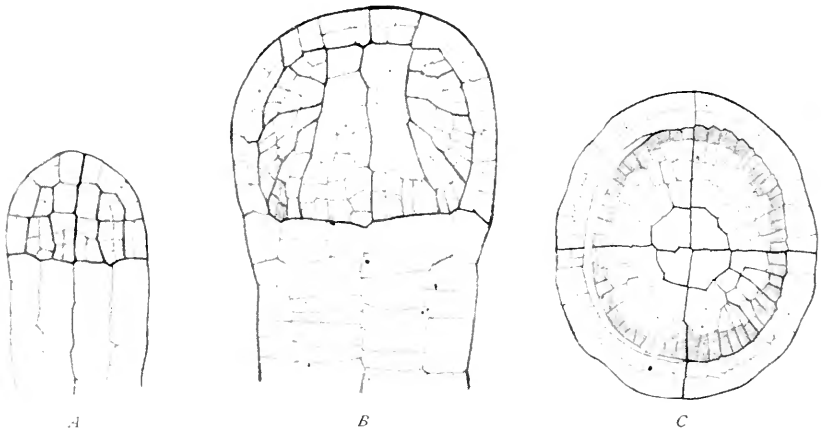

FIG. 46.

A, median section of young sporogonium of *Aneura ambrosioides*. The internal mass of cells of the sporogonial head ("archesporium") is already differentiated so as to indicate the sterile elaterophore, and the outer fertile region. *B*, the same, older: the indications of sterilisation have extended outwards, and it is only the peripheral fringe of cells (shaded) which will be sporogenous. *C*, transverse section of the same. $\times 150$.

of cells of the sporogonial head, which are equivalent *inter se*, inasmuch as they have a common origin: but they are already differentiated into two distinct regions, a peripheral fertile region, of which the cells are shaded, and a central sterile region. The former differentiates at a later stage into spore-mother-cells and elaters: the latter forms the sterile elaterophore. The whole hemispherical group corresponds in position to the body similarly placed in other Hepaticae, which have no elaterophore, and in which the whole region develops into spores and elaters. This case therefore illustrates an advanced stage of sterilisation of tissue which may be held to be ancestrally sporogenous throughout. But the final fate of the sterile cells here is not merely to serve as evanescent nutritive cells; for the elaterophore and elaters are a permanent tissue and permanent cells, which remain till the ripeness of the spores, and are functional in their dispersal.

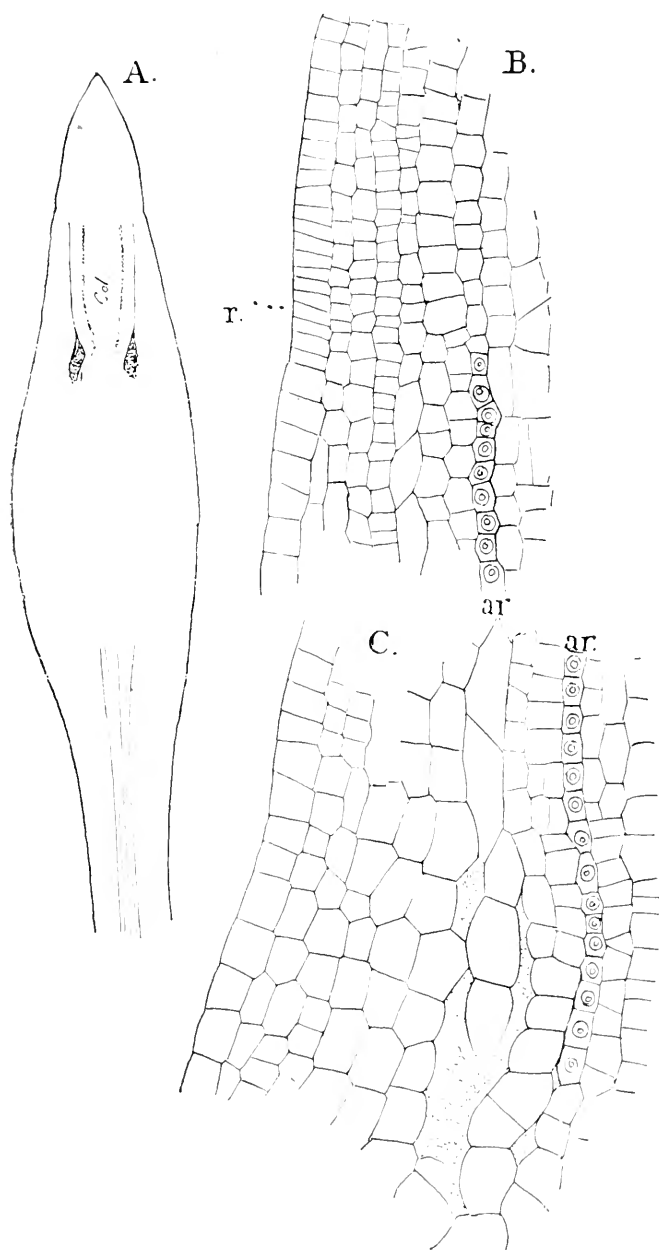

FIG. 47.

Funaria hygrometrica. A, longitudinal section of a sporogonium showing the first differentiation of its parts. \times about 95. B, the upper part of the same. \times 600. r marks the limits of the theca and operculum. C, basal part of the capsule of the same. \times 600. The intercellular spaces are beginning to form. ar, archesporium. col, columella.

Such examples serve to show that there are good grounds for holding that sterilisation of individual cells of the sporophyte, which by their origin are to be recognised as potentially fertile, does take place: and that such cells may be diverted to a temporary, or to a more permanent use in connection with the production of spores. Thus we are justified in holding that sterilisation, which is the initial factor in the working hypothesis sketched in the previous chapter, has been actually operative.

It will be impossible here to enumerate all the cases where evidence of sterilisation of potentially fertile cells has been brought forward; but some

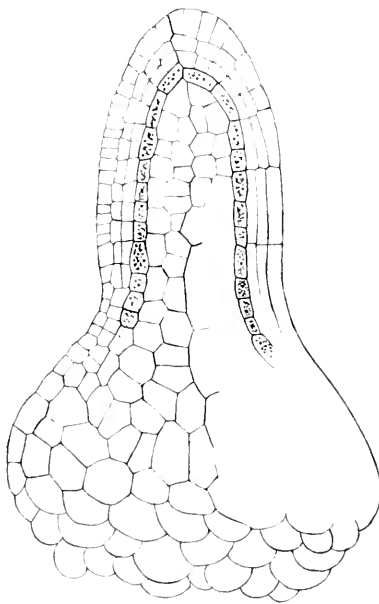

FIG. 48.

Median longitudinal section of a sporogonium of *Sphagnum*, with bell-shaped archesporium. : 170. (After Waldner.)

Aneura). In the Anthocerotaceae, on the other hand, the archesporium is a dome-shaped layer surrounding a central columella; but the products of this layer do not only form spore-mother-cells, but also numerous sterile cells arise from it, which develop as an irregular network enclosing the mature spores. In point of fact, in the Liverworts it is the exception rather than the rule for the whole of the sporogenous tissue to be fertile, though this is the case in the simplest of them.

In the Musci, on the other hand, the whole of the cells developed from the definite, single-layered archesporium normally produce spores; but the archesporium is relatively small compared with the bulk of the young sporogonium: it shows an apparently arbitrary limitation at its

of the more prominent instances of it will be quoted. At present it is the mere fact of sterilisation which is before us, not the biological consequences which follow in facilitating the nutrition or the dispersal of spores, nor yet the morphological advances which may result. These aspects of the matter will be left over till the several groups of the Archegoniatae are specially discussed.

Among the Liverworts the simple Ricciaceae have centrally an undifferentiated sporogenous tissue; but as a rule in the Marchantiaceae and Jungermanniaceae the almost spherical mass of sporogenous tissue becomes differentiated as development proceeds: cells, singly or in groups, instead of undergoing the tetrad-division, are developed in a vegetative manner, either as nutritive cells (*Sphaerocarpos*), or as elaters of various form and arrangement (compare Fig. 46, of

margin. Fig. 47 illustrates how the series of cells of the archesporium is continuous both upwards and downwards beyond the limit of its fertility: this indicates a probability that its marginal limitation has been due to sterilisation, a view which is strengthened by comparison with *Sphagnum* (Fig. 48); for there the archesporium is in the form of a complete dome:

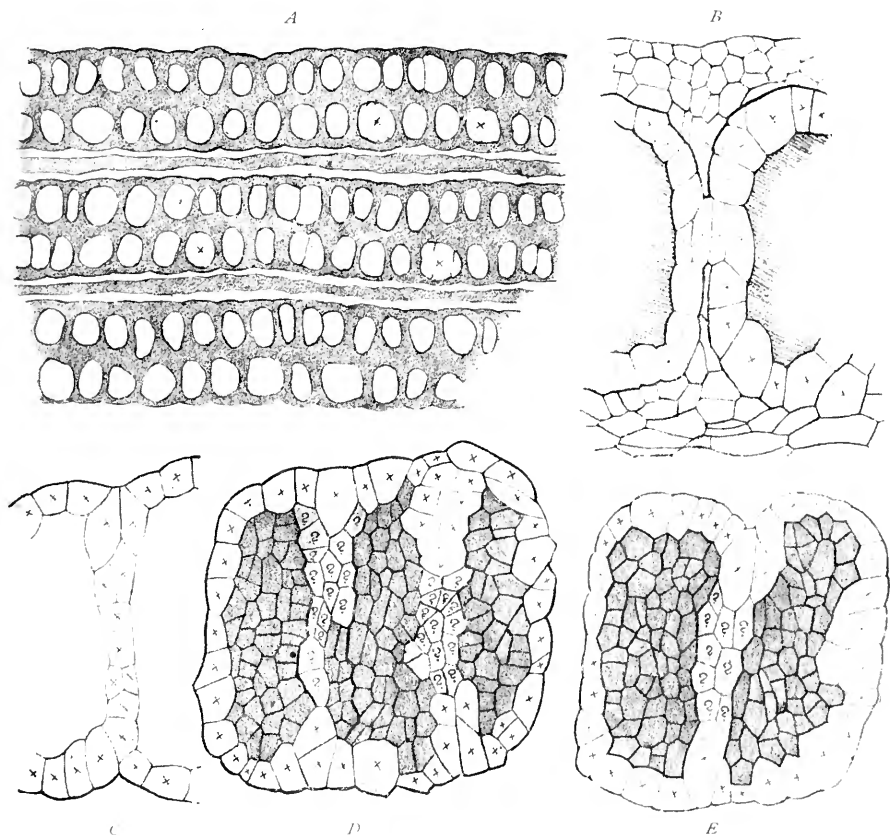

FIG. 46.

Danaea elliptica, Smith. Drawings illustrating partial septations of the sporangium. A, tangential section through three sori, showing the loculi in ground plan; the septa are often thin, so that pairs of loculi are in close juxtaposition; the loculi marked (x) are large, and show one or more partial septa. B, C, D, E, show such loculi with partial septa in greater detail; in D and E it is difficult to decide whether the cells marked (x) will develop as tapetum or as spore-mother-cells.

a sterile condition of the cells at its apex would give a barrel-shaped archesporium, as is seen in the Bryineae. Thus it will appear that any evidence of sterilisation in the Musci is less direct than that in the Hepaticae.

Evidence of sterilisation of potential sporogenous cells is common in the homosporous Pteridophyta: and, as in the Bryophytes, the function

of the arrested cells is sometimes simply nutritive, sometimes they form permanent tissue-masses. In *Lycopodium* and *Phylloglossum*, and in the homosporous Ferns, after the sporogenous tissue is first defined, all its cells normally undergo the tetrad-division, and develop spores: occasional cells may become disorganised without full development, though, as a rule, all the potentialities are realised. But among the Marattiaceae, where, as a rule, all the cells of the sporogenous groups are fertile, a number of exceptional cases have been noted: the most remarkable is that of *Danaea*, in which it has been shown how certain cells of the larger sporogenous groups remain sterile, and may be developed as tapetum, or even as component cells of a partial septum (Fig. 49). Somewhat similar conditions have been seen in *Kaulfussia*, *Marattia*, and *Angiopteris*.



FIG. 50.

A. apex of sporangium of *Equisetum limosum*, L., showing the sporogenous cells, surrounded by the tapetum (shaded), and sporangial wall. *B.* shows part of an older sporangium with its tapetum (*t*) still clearly defined, though the individuality of the cells is lost: within this the sporogenous tissue, of which certain cells (*a*) are abortive.
 5, 200.

In other cases it has been found that only a portion of the cells of the sporogenous group are fertile, as already described for *Psilotum* (Fig. 45): this has been shown to be the case also in *Tmesipteris*, and in *Equisetum* (Fig. 50), and it has been described also as an occasional feature in the Ophioglossaceae. In all of these a varying proportion of the sporogenous cells are sterile, and become disorganised without forming tetrads. As the proportion of the sterile to the fertile cells is not fixed, an elastic arrangement exists which leads to the largest number of spores being brought to maturity that the plant at the time can support. The limits of the sporogenous tissue in early stages are difficult to define in these large sporangia, and they show considerable irregularities: this is especially so in *Psilotum*, *Tmesipteris*, and *Ophioglossum*, and it appears to be partly due to the ill-defined and broad tapetum which is formed peripherally,

partly to the fact that owing to sterilisation the definitive fertile cells do not form a continuous mass.

Among heterosporous forms, sterile cells are commonly present in the female sporangium (Fig. 51): there is good reason to think that arrest of potential sporogenous cells has greatly favoured the advance in size of the relatively few remaining megaspores. But apart from this, the case of *Isoetes* is interesting, since there is evidence of sterilisation both in the mega- and micro-sporangia, and in both it has resulted in permanent tissue-masses. In both types of sporangium an extensive potential sporogenous tissue is formed, which is at first uniform in structure, as it was also in origin. In the microsporangium considerable tracts of this tissue differentiate later as vegetative trabeculae and tapetum,

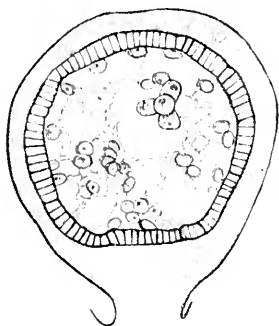

FIG. 51.

Selaginella spinulosa, A. Br. Section of megasporangium showing the single fertile tetrad still very small, and the rest of the sporogenous cells arrested. $\times 100$.

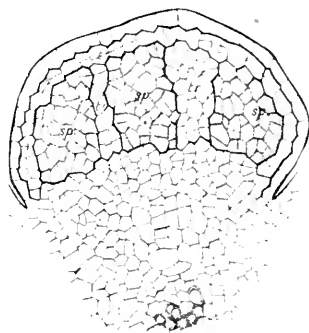

FIG. 52.

Isoetes lacustris, L. Vertical section of a young microsporangium. *sp*=fertile tissue. *tr*=trabeculae. *t*=tapetum. $\times 100$.

while the remainder forms microspores. From the history of development, and from comparison, the conclusion seems justified that the trabeculae and tapetum in this case represent sporogenous tissue which has been converted into sterile tissue, serving nutritive and mechanical purposes in the very large sporangium (Fig. 52). Similarly, in the megasporangium there is sterilisation, but it has been carried much further, and it has been possible to show that the megaspore-mother-cells are not morphologically predetermined, but are physiologically selected from among a large number of potentially sporogenous cells: also that each archesporial cell gives rise to several megaspore-mother-cells, as well as to trabeculae and tapetum (Fig. 53) (Wilson Smith). Thus there has been a differentiation of tissues of uniform origin, and a large part has been diverted to functions played by sterile vegetative tissue. Very similar sterile tracts of tissue have been seen in the large sporangia of *Lepidostrobis Brownii*, and their origin by sterilisation is highly probable, though naturally this is hardly susceptible

of demonstration in a fossil. The general conclusion may be drawn from such cases as those cited, that sterilisation has played a considerable part in the sporangia of Pteridophytes.

In Seed-Plants also there is frequent evidence of sterilisation of cells of a potential archesporium, both in megasporangia and in microsporangia. In the latter, examples have been seen in which a considerable proportion

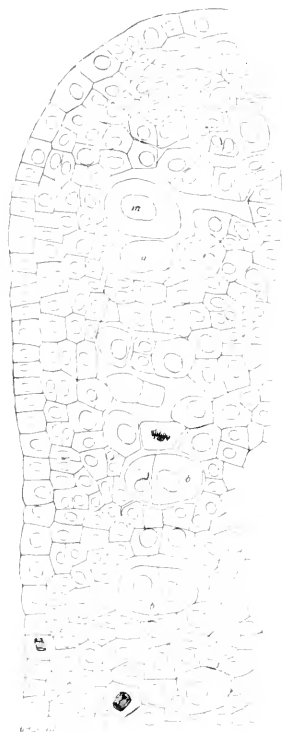

FIG. 53.

Part of a section of a megasporangium of *Isotria medeolae*. The cell marked (*m*) is the only fertile spore-mother-cell, the rest are undergoing vegetative divisions, including the cell (*v*) as shown by other sections of the series. Thus sterilisation affects the large majority of the cells of the sporogenous group. $\times 245$. (After Wilson Smith.)

of the cells of the sporogenous group are obliterated in much the same way as in *Psilotum*. But in the anthers of not a few Angiosperms partial or complete septa of sterile tissue may be formed in plants whose near allies have their pollen-sacs non-septate. Thus, in the Onagraceae the stamens of most of the genera are of the ordinary quadrilocular type: but in the genera *Circaea*, *Gaura*, *Clarkia*, and *Eucharidium* the four loculi are each divided transversely by one or more sterile septa: these septa may consist of only a single layer of cells having the character of tapetum, or of two layers, or even of four or more, of which the middle layers then resemble the tissue of the connective. An examination of early states of development of these anthers shows that the septa result from sterilisation of part of the sporogenous tissue, for in sections it is seen that the sporogenous cells and those which will form the septa originate from a common layer corresponding to the archesporium of normal anthers of the family (Fig. 54). A similar state of things has been described in certain of the Mimoseae (*Inga*, *Calliandra*, *Acacia*, *Albizzia*), in many of which there are eight pollen-sacs in place of the normal number of four; while in others (*Parkia*) the number may be much larger. Here, again, the developmental history shows that sterilised archesporial tissue provides the septa which divide the four original pollen-sacs into eight

or more loculi. With these may also be compared the cases of *Viscum* and *Loranthus*. Developmental study of the anther of *Rhizophora* has given the same result: in its massive anther the small pollen-sacs are very numerous, distributed over a large surface: Warming has concluded that the anther became multilocular by the arrest of the further development of certain parts of the pollen-forming tissue (see Fig. 72, p. 142). Such examples, which by no means exhaust the list,

show that sterilisation of sporogenous cells is not uncommon in the anthers of Seed-Plants.

Evidence of sterilisation is also found in the ovules of Seed-Plants. Among the Gymnosperms, the Gnetaceae show an archesporium consisting of a group of hypodermal cells: in *Gnetum Gnemon*, which is the best known example, these give rise to a considerable mass of sporogenous cells, but only one embryo-sac is finally matured. In the Cycads the case is similar, inasmuch as there is a considerable tract of sporogenous tissue, though only one embryo-sac matures. In the Coniferae also there is frequently a multicellular archesporium, and several embryo-sac-mother-cells have been seen to enlarge in *Taxus* and *Sequoia*, but in most of them only a single one. Among Angiosperms a condition very similar to that

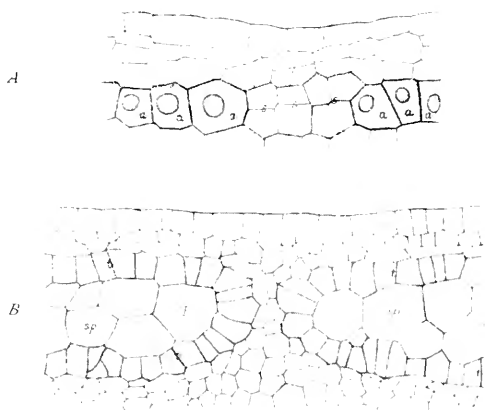

FIG. 54.

A, longitudinal section of one loculus of a young stamen of *Eucharidium concinuum*, showing differentiation of the potential archesporium into fertile cells (*a*) and sterile cells (*s*). *B*, similar section of stamen of *Clarkia elegans*, more advanced, showing a sterile septum dividing the contents of the single loculus into distinct sporogenous groups (*sp*). *t*=tapetum. $\times 365$.

in *Gnetum* is seen in *Casuarina* (Figs. 55, 56): this case is particularly interesting, since the potential embryo-sacs are not simply obliterated by the growth of the favoured one, but some develop into tracheides with thickened walls—a proof that permanent sterile tissue may be formed from potentially sporogenous cells. In certain Amentiferae also a similar formation of tracheides has been seen. A multicellular archesporium is common, besides, in other Archichlamydeous Dicotyledons, e.g. in the Ranunculaceae and Rosaceae, and some others (Fig. 57): but it is apparently less common in the more advanced Dicotyledons and in the Monocotyledons. The examples thus quoted suffice to show that sterilisation of potentially sporogenous cells is frequent both in the microsporangia and in the megasporangia of the Seed-Plants.

And thus it is seen that evidence of sterilisation is widespread: it is found in all the main groups of the characteristic Flora of the land, both

in homosporous and in heterosporous forms: the sterile cells may be functional sometimes only as transitory, nourishing cells; or they may persist as permanent tissue, forming in some cases partial, in others even complete septa.

The converse case, viz. the conversion of cells normally sterile into fertile cells, is a much less common phenomenon, though instances of it have been observed. This change is not to be confounded with the formation of whole organs of propagation, such as sporangia, in places where they do not normally exist: what is here meant is the change in

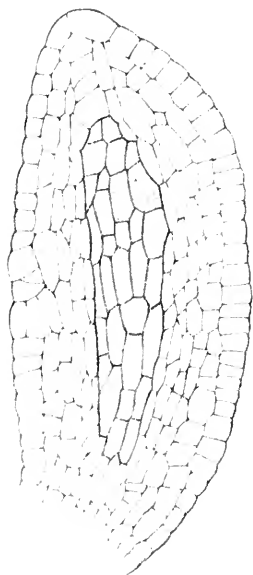

FIG. 55.

Casuarina Kumphiana, Mig.
Median section of the nucellus of an ovule, with the group of sporogenous cells shaded. $\times 285$. (After Treub.)

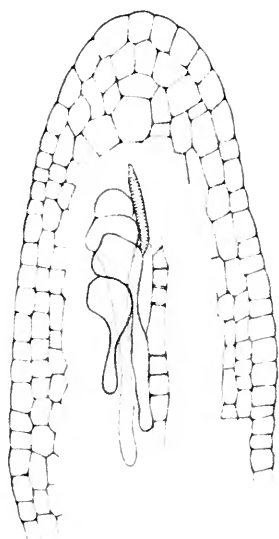

FIG. 56.

Casuarina glauca, Sieb. Median section of nucellus of an ovule showing the cells of the sporogenous group differentiated: some are becoming elongated in the direction of the chalaza: one long cell has divided by six swollen walls: another has developed as a tracheid. $\times 285$. (After Treub.)

individual cells, which are normally vegetative, to the sporogenous condition. A case of this has been recorded by Lanzius Beninga in a specimen of *Syntrichia subulata*: certain cells of the normally sterile columella were found to be undergoing tetrad-division prior to forming spores: a similar condition has also been noted by Kienitz Gerloff in a species of *Bryum*.¹ It has also been seen in rare cases in the Pteridophytes, that cells outside the limits of the normal sporogenous group, but contiguous with it, may show the characters of fertile cells. But the most distinctive case, which

¹ Lanzius Beninga, *Beiträge z. Kenntn. d. inn. Baues d. angew. Mooskapsels*, 1847, Tab. 58, Figs. 9*, 9** ; Kienitz Gerloff, *Bot. Zeit.*, 1878, p. 47, Taf. 2, Fig. 52.

has been fully made out, is that of *Tmesipteris*: the normal synangium of this plant has when mature two loculi, divided by a septum some five or six layers of cells in thickness. Certain synangia of small size are found about the limits of the fertile zones: they appear non-septate, and it has been shown that the cells of the septum in such cases develop as fertile cells, undergoing the tetrad-division (Fig. 58). Such examples show that occasionally a reversion may occur from cells normally sterile to the function of spore-production. Putting together the two converse series of

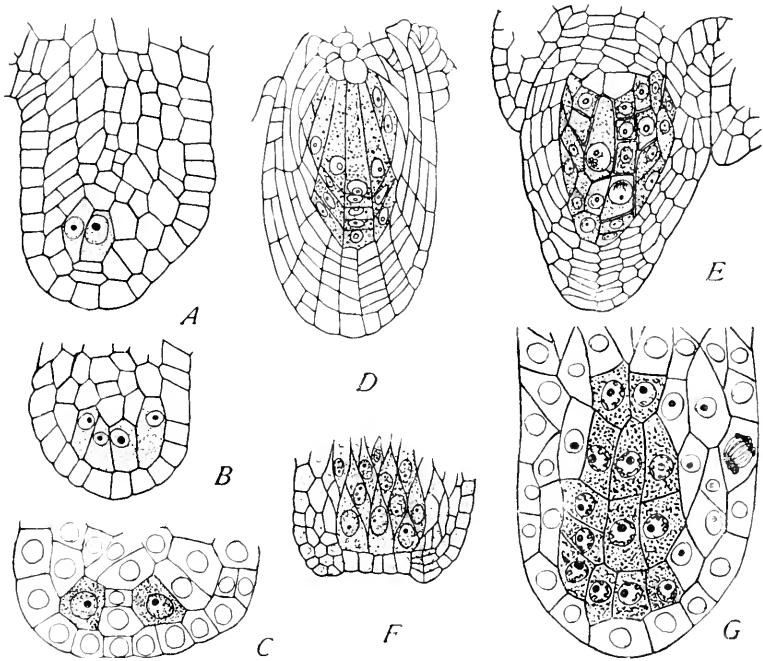

FIG. 57.

Longitudinal sections of ovules showing multicellular archesporia. *A, B=Astilbe japonica*. $\times 550$. (After Webb.) *C=Salix glaucophylla*. $\times 600$. (After Chamberlain.) *D=Rosa lvida*. $\times 224$. (After Strasburger.) *E=Alchemilla alpina*. $\times 275$. (After Murbeck.) *F=Callipeltis cucullaria*. (After Lloyd.) *G=Quercus velutina*. $\times 720$. (After Conrad.) From Coulter and Chamberlain, *Morphology of Angiosperms*.

facts—of sterilisation which is relatively common, and of reversion to the fertile state which is comparatively rare—two conclusions may be drawn: first, that the facts indicate a preponderance of the former over the latter in plants now living: in them sterilisation appears to be a more potent factor now than reversion, and it has probably been the same in the past also. Secondly, it may be stated generally for Archegoniate and Seed-bearing Plants, that spore-production is not always strictly limited to, or defined by pre-ordained formative cells or cell-groups.

Voechting has formulated the proposition that “No living vegetative cell of the plant-body, which is capable of growth, has a specific and

unalterable function."¹ This thesis should be extended so as to include also sporogenous cells: for, as we have seen, many cases can be cited of the conversion of cells which are normally sporogenous to a vegetative condition, and occasionally the converse. The facts before us show that vegetative and sporogenous cells are not things apart or essentially different, but that they are on occasions mutually convertible. The influences, external or internal, which act upon the embryonic cell, and determine whether it shall be vegetative or sporogenous, are still obscure: but clearly they act within restricted limits, for in Vascular Plants neither superficial cells of the plant-body nor deeply seated cells have ever been found to develop as spore-mother-cells.

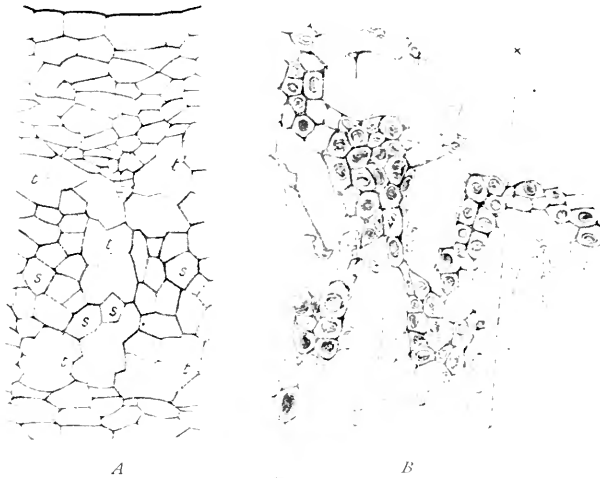

FIG. 58.

T. mesipteris Tannensis. Bernh. A, median section through synangium, showing the tissue where the septum normally is developing as sporogenous cells (s). t=tapetum. B, part of the contents of a similar synangium, rather older. xx shows the line where the septum should normally be, while a chain of fertile cells stretches continuously across it. $\times 1000$.

The conversion of potentially fertile cells into vegetative cells was recognised by Naegeli, and embodied by him in his fundamental law of organic development, as follows: "The phenomenon of reproduction of one stage becomes at a higher stage that of vegetation. The cells which in the simpler plant are set free as germs, and constitute the initials of new individuals, become in the next higher plant part of the individual organism, and lengthen the ontogeny to a corresponding extent."² The sterilisation seen in the sporophyte of the Archegoniatae and Seed-Plants is only one special case of that included under Naegeli's general law. He points out that the law is realised in three different ways, and the case for the sporophyte generation, with which alone we are at present concerned, falls under the first head, expressed by him as follows: "The propagative cells which arise by division are converted into tissue cells."

¹ *Orgaubildung*, p. 241.

² *Abstammungslehre*, p. 352.

The general features of the change from a sporogenous to a sterile character are associated usually with a less dense protoplasm and a smaller and less marked nucleus. If disorganisation be the ultimate fate, the wall breaks down, and the identity of the protoplast is lost, with or without fragmentation of the nucleus, as in *Psilotum*: or the protoplasm may shrink and collapse, and the whole protoplast become highly refractive before the final absorption, as in angiospermic ovules. If the cell is to continue functional in a vegetative capacity, the changes are those usual in cells passing from the embryonic to the mature condition. It has been stated above that the occurrence or absence of the tetrad-division, and of the consequent chromosome-reduction, is the ultimate criterion of distinction between a fertile and a sterile cell: in the majority of cases the distinction has been drawn on the basis of the results of subsequent development, not on that of actual observation of the nuclear changes. It is not, however, probable that this has led to any serious errors, since the tetrad-formation which follows on chromosome-reduction is a sufficiently distinctive feature in all cases except in the ovules of Seed-Plants. This being so, it is not surprising that the most exact nuclear observations of sporogenous cells, in which the sterile or fertile development is a critical question, have been made on the ovules of certain Angiosperms, viz. in the case of the apogamous species of the genus *Alchemilla*.¹ The exact questions connected with these plants do not come before us here; but in their elucidation Strasburger had reason to follow carefully through the development of certain embryo-sacs, as regards their nuclear condition. He found that an archesporial cell having entered the condition of an embryo-sac-mother-cell, its nucleus passes through the prophase of the reduction-division, up to the stage of synapsis. The embryo-sac mother-cell then alters its trend of development and becomes vegetative, and its nucleus passes out of the synapsis condition into that of a typical division, instead of continuing the reduction-division. The cell thus remains a part of the tissue-system of its parent, not the initial cell of a new generation. Such a case is interesting in that it shows how a cell may tremble on the verge between the sterile and the fertile state. It leaves, however, still open the question as to the influences, external or inner, which determine its fate. These probably vary in different cases, and the problem would naturally be a simpler one in the Homosporous Archegoniatae than in the ovule of an Angiosperm. It seems obvious in the simpler cases to suggest nutrition as one potent factor: it is a necessary axiom that an increasing spore-output, which is an advantage in increasing the probability of survival and dissemination, demands increased nourishment and protection: and that a vegetative system increased by sterilisation will tend to provide this. But still the advantage gained may be quite independent of the real cause: we are not yet in a position to translate the nutritive demand into terms of a direct influence upon the individual cell. It seems useless to

¹ Strasburger, "Die Apogamie der Eualchimillen," *Pringsh. Jahrb.*, Band xli., Heft i.

speculate upon such questions: for the present it is best to be content to recognise as an unsolved problem what those influences are which encourage or check reduction in any individual cell of a sporogenous tissue at the critical moment.

In conclusion, the question may be raised how sterilisation is to be viewed: is it an advance or a retrogression? If the antithetic theory of alternation be true, then sterilisation must be regarded as an evolutionary advance, as far as it influences the whole organism. According to our theory, it is by successive stages of sterilisation, following closely upon the heels of increase of potential sporogenous tissue, that the vegetative body of the sporophyte originated, and enlarged. A new phase of life of increasing importance was thus intercalated, the end and result of which was primarily an increased spore-output. But its origin was, conversely, in restricted propagative development of certain cells. Inasmuch as this has tended to a higher state, and greater success of the whole organism, it may be held to have been an advance. But as regards the individual cell, sterilisation can only be held to be a check to its development, as it prevents it from taking direct part in the final end of the sporophyte, which is the production of new germs.

From the examples quoted there is ample proof that sterilisation of potentially fertile cells does occur: thus from living plants the evidence is supplied of the existence of that factor which is the first essential of any theory of origin of the sporophyte by expansion from the zygote. It does not necessarily follow that the first vegetative tissues of the sporophyte did originate in this way: all that can be claimed is that plants show not uncommonly to-day such a conversion of cells from the propagative to the vegetative state as the antithetic theory would demand.

CHAPTER VIII.

THE SPORANGIUM DEFINED.

THERE are two main types of construction of the sporophyte in Archegoniate plants which differ in essential features. In the Bryophyte-type it is a body dependent on the gametophyte, without appendages of any sort, and with the sporogenous tract as one concrete archesporium, while the spores are consequently contained in one non-septate sac. In the Pteridophyte-type it is an independent organism, with roots and foliar appendages, while the archesporia are discrete and usually numerous: accordingly the spores are contained in many distinct pockets: these are the *sporangia*. There is no definite indication how the polysporangiate state of the Pteridophytes came into existence; but with a view to forming an opinion it will be necessary to enquire into the characters of the sporangium, and to separate the essential features from the non-essential.

In any ordinary sporangium of a Fern the following parts are to be recognised: the *stalk*, which supports the sporangial *head*; the latter consists of the *wall*, with an opening-mechanism, the *annulus*; within the wall at an early stage is the *archesporium*; later, the *tapetum* is differentiated, which surrounds the *sporogenous group*; ultimately the *spores* are matured from the latter (compare Figs. 4 to 8). It will be necessary to consider which of these parts are constant in sporangia at large, and which are inconstant or only occasional parts. It will be possible thus to arrive at some estimate as to which of these are essential and which are merely accessory parts of the sporangium.

Comparison shows that though sporangia are often stalked, still there are many others which are quite sessile, and indeed immersed in the tissue of the part which bears them (Fig. 59): this indicates clearly that the *stalk* is not an essential part of the sporangium.

In all the Archegoniatae the spore-mother-cells are covered externally by the sporangial *wall*: this is a protective sheet of cells, which may be of variable thickness and structure: it serves the several purposes of protection, of nutrition, and in many cases of dehiscence, and of mechanical ejection

of the spores. The extent of the wall as such is closely related to the position of the sporogenous cells: where these are deeply sunk, the wall is a mere roof over them: where they are carried outwards by the growth of the tissues surrounding them, and a projecting sporangium is formed, there the wall envelops them as a tissue of greater extent. But in either case it is continuous with the tissue of the sporangium-bearing part, of which it is to be regarded as a specially developed region. This view of it accords well with the structure of sunken sporangia, as in *Ophioglossum* (Fig. 59), in which the tissues of the wall are continuous with and little differentiated from the cognate tissues of the spike. The same is the case with other Ophioglossaceae, even in those where the sporangia project; but in these, as also in the Lycopods and Equiseta, there is some further specialisation



FIG. 59.

Ophioglossum reticulatum, L. Vertical section of the deeply sunken sporangium, with the sporogenous tissue shaded. $\times 100$.

of the Hydropterideae are also entirely without an annulus; nor is there any stomium in them, which would localise dehiscence. *Loxsonia* is a specially interesting case, for there the annulus, though indicated by the cell-divisions as complete, is only partially indurated: as a matter of fact, the part of it which is not indurated could not possibly be mechanically effective, owing to the mode of packing of the sporangia in the sorus (Fig. 60).

The general conclusion to be drawn is, that while the protective wall itself is always present, those mechanical arrangements collectively designated by the term "annulus" are not essential or constant parts of the sporangium, however constant they may seem to be in certain groups: where they cannot be mechanically effective they may be entirely omitted.

Nor is the *tapetum* to be looked upon generally as a morphological

of the wall for dehiscence than in the deeper-seated forms. In the Filicineae still more exact specialisation is the rule, and the mechanical *annulus* becomes a marked feature in the stalked sporangium. But a comparison of the Marattiaceae and other Ferns leads to the conclusion that the presence of an annulus, and its elaborateness, are to be correlated with the freedom of the sporangium from mutual relations with other bodies. The annulus, in fact, is still only a specialised region of the sporangial wall. This conclusion accords with the facts of its inconstancy, for sporangia which open under water may have no such mechanism. That is the case in *Isoetes*, while the sporangia

constant, notwithstanding that it shows some constancy of character in certain circles of affinity. Sometimes it is not differentiated at all, a condition which holds throughout the Bryophyta: in other cases it may appear as a more or less definite band of cells, which originates from the tissues surrounding the sporogenous cell or group of cells, sometimes from the sporogenous group itself. In some cases a large number of cells of the sporogenous groups act like a diffused tapetum, becoming disintegrated during the development of the spores (*Ophioglossum*, *Psilotum*): in *Equisetum*

both a diffused tapetum of this nature is found, and also a definite single-layered tapetum, which originates outside the sporogenous group. In *Lycopodium*, and in the Marattiaceae the tapetum arises from cells outside the sporogenous group: in other cases, such as *Selaginella* and the Leptosporangiate Ferns, the tapetum may consist of cells cut off from the sporogenous cell or cell-group. There is indeed good reason to think that there has been a progressive change of origin of the tapetum within certain circles of affinity: speaking generally it may be said that indefinite and non-specialised nutritive arrangements are characteristic of larger and probably primitive sporangia, but more definite tapetal layers are found in the smaller and probably derivative: and further, that while in sporangia of relatively large size the

tapetum usually originates outside the sporogenous group, in smaller sporangia of the same affinity it may be cut off from the sporogenous cell or cell-group. Such a change appears to be illustrated by comparison of *Lycopodium* with *Selaginella*, and of the Marattiaceae with the Leptosporangiate Ferns. The result of such comparisons is that the tapetum, however uniform it may be in function, is found to be variable both in occurrence and in origin, and accordingly it cannot be regarded as an essential or constant feature of the sporangium.



FIG. 60.

Loxsoma Cunninghamii, Br. E, young sorus. A, rather older. B, vertical section of the base of the receptacle, showing young sporangia. C, D, mature sporangia, showing the incompletely indurated annulus, and distal point of delicence (x). A + E \times about 20. B \times 250. C + D \times 50.

It remains to consider the *archesporium*, and the sporogenous group and spores which arise from it. An archesporium, in one form or another, is a necessary constant in the development of a fertile sporangium: the form, the limits, the mode of origin and of later segmentation which it shows, may vary, as indeed is seen to be the case in the different sporangial types; but whatever its variations may be, it is in the archesporium, and in the sporogenous cells which it produces, that we see the essential feature of the sporangium. It will be necessary, then, to examine it carefully, and to see how far it is possible to attach a definite meaning to it.

The term archesporium was introduced by Goebel,¹ and defined as follows: "In the Vascular Cryptogams, as in the Phanerogams, the spore-producing tissue may be universally referred as regards its origin to a cell, a cell-row, or a cell-sheet:—I designate these original parent cells of the sporogenous tissue as the archesporium." To this he added that "in all Vascular Cryptogams examined an hypodermal archesporium exists," thus definitely localising it in a position comparable to that in the Spermophyta. He remarks, however, later that he does not lay special stress upon the archesporium being always a cell-row or cell-sheet, and contemplates it as possible that sometimes the development may proceed otherwise than by the appearance of an archesporium of the form described. An examination of all the types of sporangia of living Pteridophytes has shown that this is the fact: a considerable number of cases have been observed in which the archesporium is not hypodermal, in that it is not defined by a single periclinal wall of the parent cells involved. The existence of many exceptions among Eusporangiate Pteridophytes suggests a reconsideration of the archesporium. We may enquire whether a definite meaning is attached to the term, and if so, whether that meaning is of general application.

The effect of Goebel's investigations on the sporangia of Pteridophytes was to extend downwards from the Phanerogams the demonstration of a formative cell or cells to which the origin of the spores may be ascribed. Before 1880 it was held that a mass of cells within the young sporangium, showing irregular divisions, took upon them the character of a sporogenous tissue: Goebel's results led him, as we have seen, to the statement that the spore-producing tissue can be referred as regards its origin to a cell, a cell-row, or a cell-sheet, which can be distinguished very early by the nature of its materials from the rest of the cell-tissue. This archesporium was successfully recognised in certain cases, and the tendency of the time was to expect similar success in all cases. Thus a special significance came to be attached to these cells, quite apart from that of the surrounding tissues, as being predestined from the first to the important function of spore-production.

The location of the archesporium in the Phanerogams was found to be consistently hypodermal: in a somewhat strained sense the same was

¹*Biol. Zeit.*, 1880, p. 545 etc.

found to be the case in many of the Pteridophytes. But it was not sufficiently recognised that between the two lies all the difference between stratified and imperfectly stratified meristems. This point was brought forward in 1896,¹ in the proposition that "the study of the sporangia or synangia of a plant should be carried out in the light of a knowledge of the segmentation of its apical meristems," and the generalisation was laid down that "where the apical meristems are distinctly stratified, the structure of the young sporangium is stratified also: in those plants where there is a non-stratified structure, with one or more initial cells, and frequent periclinal division of superficial cells near the apex of stem, leaf, or root, there the structure of the young sporangium is not distinctly stratified." Such exceptions to the hypodermal position of the archesporium as have been found among the Pteridophytes all fall under this generalisation, and it may be added as a corollary that in all Vascular Cryptogams investigated, the sporogenous tissue is ultimately referable to the segmentation of a superficial cell or cells. This has been since noted by Wilson Smith,² who has accordingly suggested that the term "archesporium" should be extended to these also, and he gives the definition as follows: "The cell, or group of cells, whether superficial or hypodermal, to which in a last analysis all the sporogenous portion of a sporangium can be traced, ought to be called the archesporium."

The use of the term "archesporium" has been discussed afresh by Goebel in his *Organography* (p. 771). He first describes the case for the anther of an Angiosperm thus: "In each of the four angles of the anther a cell-row or cell-layer below the epidermis (hypodermal) divides by periclinal walls. Of the cells which thus arise the internal form the archesporium, the outer the 'schichtzellen,' which now divide still further by periclinal walls." The archesporium is thus defined as the inner product of the division of the hypodermal layer; it gives rise neither to any part of the sporangial wall nor to the tapetum, though, since these have a common origin with it from the hypodermal layer, it is not clear why the latter should not itself be styled the archesporium. Passing on to the Pteridophyta, after noting how superficial cells give rise to the essentials of the sporangium, and that the details are not uniform, he proceeds (*l.c.*, p. 774): "We may then designate that superficial cell or cell-layer as archesporium which sooner or later gives off sterile cells, while in the sporangia of Angiosperms the archesporium is a cell-layer lying below the epidermis, which is already differentiated: with this the above-noted differences in wall-structure of the Pteridophyta and Gymnosperms on the one hand, and of the Angiosperms on the other would correspond." This passage calls for the following remarks.

In the first place, Goebel accepts the conclusion of Wilson Smith, that since the sporogenous tissues of Pteridophytes are all referable in origin to superficial cells, therefore those cells are to be recognised as the archesporium. By accepting this conclusion, it may be presumed that

¹ *Studies*, ii., p. 8.

² *Bot. Gazette*, vol. xxix., p. 325.

he approves of the method by which it is arrived at: that is, the method of recognition of the archesporium by "a last analysis" of cell-origin.

Secondly, Goebel's method of recognition of the archesporium is not consistent: he designates the inner product of the hypodermal layer in the Angiospermic stamen the archesporium, notwithstanding that the "schichtzellen" and the tapetum are sister-cells with it. But in the Pteridophyta, on the ground of common origin by segmentation, not only the tapetum but also the sporangial wall itself are described as derived from a superficial archesporium. If the recognition of an archesporium is to be based upon "a last analysis" of the segmentations, then the hypodermal layer of the Angiospermic anther, and not merely the inner product of its segmentation, is the archesporium.

Thirdly, the recognition of the archesporium by the method of "a last analysis" brings together under a common head, merely on the ground of early segmentations, things which are not really comparable, and ascribes a distinct origin to things which are indistinguishable when mature. The superficial archesporium of the Pteridophytes gives rise to part of the sporangial wall and of the tapetum: the archesporium of the Angiospermic anther, on Goebel's definition, gives rise to neither. It is impossible to conceive how by any known evolutionary progression the former type of "archesporium" could pass into the other, and the superficial cells be covered over: therefore the two are to be regarded as not truly comparable. Further, the recognition of superficial cells in the Pteridophytes as archesporial draws a distinction between part of the sporangial wall which originates from them, and the rest which does not: thus in the Leptosporangiate Ferns the apical part of the annulus would be archesporial, the lateral parts would not.

With all respect to the opinion of the writer who introduced the term. I think that this last change in its application, as suggested by Wilson Smith and accepted by Goebel, makes more obscure the meaning of a word which never has been clear. The Bryophyta provide a *reductio ad absurdum* of the method of "a last analysis"; for, following this method, in *Sphagnum* and some others the amphithecium would be reckoned as the archesporium, while in the ordinary Bryineae it would be the endothecium: or, carrying the analysis in the latter case to its extreme limit, the first segments in the upper half of the zygote, or even the ovum itself, would be the archesporium.

The fact is that this sort of analysis of formative tissues has served its turn: it has led to much detailed investigation, which has, however, shown that the segmentations which lead up to the formation of spore-mother-cells are not comparable in all cases. The time has come, in presence of many divergent details, to admit frankly that there is no general law of segmentation underlying the existence of that cell or cells which "a last analysis" may mark out as the "archesporium," and that therefore the general application of such a term to those cells which the

analysis discloses has no scientific meaning, beyond the statement of the histiogenic fact. At the same time, the value of the details which have been acquired by the pursuit of the archesporium must not be underestimated for purposes of comparison. What is dangerous is the attachment to them of ulterior ideas: the assumption that because a definite "archesporium" is often found, it should by rights be always present: and the effort to trace in its appearance homologies which seem based on forced rather than on natural comparisons. On the other hand, the term has become so established in the literature of the subject that it cannot be summarily discarded: it may be retained merely in a descriptive sense, in those cases where the cell or cells which give rise to the sporogenous group are obvious, but in a descriptive sense only.

The discrepancies which become apparent in the course of development between different types of sporangia tend to justify the position already adopted by Strasburger on general grounds: he remarks¹ that the centre of gravity of the developmental processes does not lie in those cells, cell-rows, or cell-aggregates which have been designated "archesporium" by Goebel: the archesporium still belongs to the asexual generation, and the presence or absence of a well-defined archesporium is not a matter of importance, for it is merely the merismatic tissue from which the spore-mother-cells are derived. From the point of view of a theory of sterilisation as enunciated above, these spore-mother-cells may be held to be, in the simpler cases at least, the residuum which a progressive vegetative change has left: in that case there is no reason to expect that the demarcation of these islands of fertile tissue should have followed any definite system in plants at large, which would be reflected with any exact uniformity in the segmentations now involved in their formation.

The frequency of hypodermal origin of the sporogenous tissue in Vascular Plants is readily intelligible biologically. In all except the very simplest sporophytes the spores are protected during development by tissues which surround them completely: this ensures nutrition and mechanical protection. In the Bryophyta the scattering of the spores would be equally efficient whether they be produced close to the surface or deeply seated, since the dehiscence, whether by a terminal operculum or by longitudinal slits, gives free exit to all the spores of the continuous spore-sac, and accordingly the spore-mother-cells of the Bryophytes may be central, as in many Hepatics, or removed more or less from the centre by the occurrence of a columella, as in most Mosses. But in all Vascular Plants, where the spores are produced in separate pockets or sporangia, the dehiscence leading to dissemination is referred to the several sporangia themselves: this necessitates for them a superficial position on the plant-body, or, better, that they shall project beyond the surface. The hypodermal origin of the sporogenous tissue which is so frequent, may thus be recognised as a compromise between the two requirements of effective

¹*Annals of Botany*, vol. viii., p. 319.

protection and nutrition on the one hand, and ready dissemination on the other. But the compromise may have worked out differently in different lines of descent, and, indeed, it appears from the variety of the segmentations in the Pteridophytes that this has actually been the case. From this point of view no difficulty need be felt to arise from the absence of any general law of segmentation, leading up to the formation of spore-mother-cells; but, on the other hand, similar and even definite types of segmentation, culminating in regularly segmented sporogenous groups resembling one another, may have been evolved along more than one line of descent.

It cannot escape notice that in some cases the *individuality of the sporangium* is not maintained. Certain synangial states are not uncommon, which can only be regarded, from the evolutionary point of view, as results of either septation or fusion: where the fusion or septation is incompletely carried out, and partial septa are present, it becomes a question whether the whole or only the part of the complex body is correctly to be termed a sporangium. This difficulty is very obvious in the sori of *Danaea* (Fig. 61). The mere application of a term is naturally a trivial matter: the question which is really important is, how far the conception of the sporangium is to be modified by the existence of such cases. The current conception of the sporangium is based upon examples where it has a distinct individuality: in the Ferns and Lycopods, and even in the pollen-sacs of normal Angiosperms such individualised sporangia are seen. But it is a question how far the idea of the individualised sporangium so gained is an enlightening one from the point of view of descent. In the same way, the old conception of the cell as the structural unit of the plant-body was based upon the study of the tissues of the higher plants, where the cells are for the most part individualised: it had to give way before the accumulated examples of cell-fusions, of polynucleate cells, and of non-cellular construction in plants both higher and lower in the scale. Just as by comparison of such structures as these the idea of the cell has undergone modification, notwithstanding that cells are commonly definite bodies in the ordinary tissues of the higher plants, so may the existence of evidence pointing to sporangial septations and fusions modify the conception of the sporangium.

The fact that sporangia originally simple have undergone septation has only been proved in comparatively few of those cases. The most complete demonstrations are those from the anthers of certain Angiosperms, such as the Onagraceae, Mimoseae, Loranthaceae, Rhizophoreae, etc. In these the comparative argument is made valid by the existence of numerous allied genera, which give ground for close comparison: for while many plants of these orders show the ordinary quadrilocular anthers, in others the loculi may be subdivided by further septa, and thus a number of sacs take the place of each original one. The development shows that the septation results from the conversion of sporogenous tissue into sterile septa. Similarly, an argument for fusion of sporangia can also

be supported on a basis of comparison among Angiosperms, though it is a less frequent change: examples are to be found in the coalescent ovules of certain Loranthaceae, or in the confluent pollen-sacs of certain Gut-tifeae, etc. Among Pteridophytes, on the other hand, the genera are so isolated as a rule that the comparative argument is difficult to apply: and

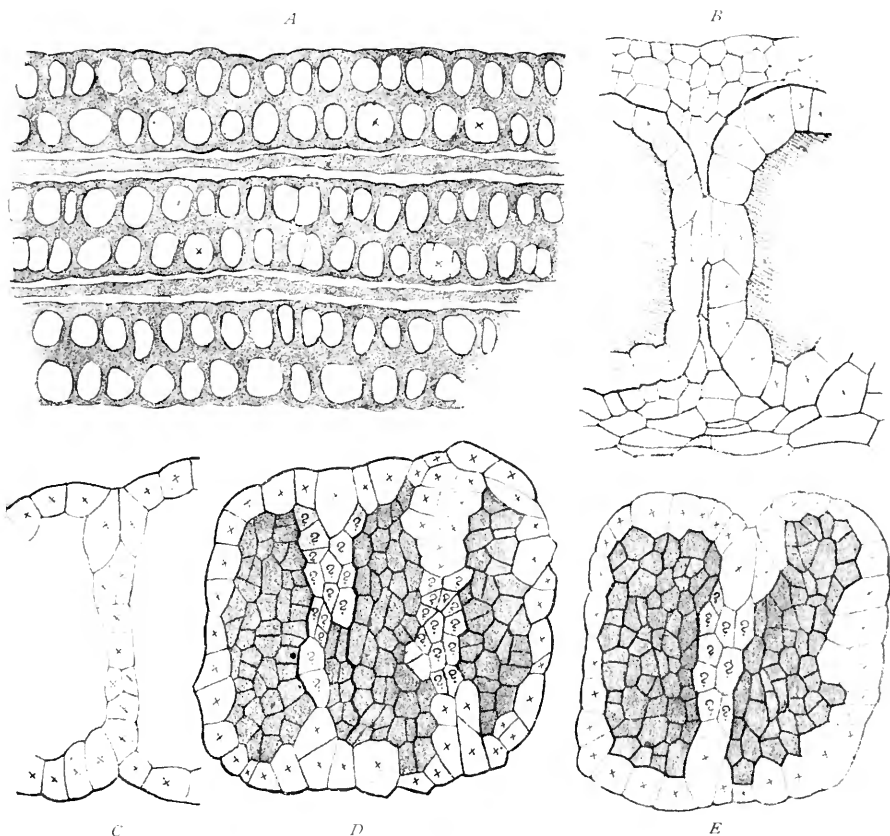

FIG. 61.

Danaea elliptica, Smith. Drawings illustrating partial septations of the sporangium. *A*, tangential section through three sori, showing the loculi in ground plan: the septa are often thin, so that pairs of loculi are in close juxtaposition; the loculi marked (x) are large, and show one or more partial septa. $\times 20$. *B*, *C*, *D*, *E*, show such loculi with partial septa in greater detail: in *D* and *E* it is difficult to decide whether the cells marked (?) will develop as tapetum or as spore-mother-cells. $\times 150$.

in each case of a synangium it may be a question whether the structure results from septation or from fusion. But without entering into these discussions at present, it is plain that either way the individuality of the sporangium is lost in such cases, just as it is in the Angiospermic anthers, and this is particularly clear where, as often happens, partial septa are found.

In summing up the considerations contained in the above pages, it may be asserted for sporangia at large, that the individuality of the sporangium

is not always maintained: that the elevation of the sporangia relatively to the surface of the part which bears them is variable; that while a sporangial wall is always present, the opening mechanisms are inconstant; that the tapetum is inconstant in occurrence and in origin; and that there is no general law underlying the segmentation of the sporogenous cell, or group of cells, so as to give it a constant hypodermal or other origin. What then remains as the fundamental conception of the sporangium in Vascular Plants? Simply the spore-mother-cell or cells, together with the protective wall. The definition of a sporangium will then be this: *Wherever there is found in Vascular Plants an isolated spore-mother-cell, or a connected group of them, or their products, this, together with its protective tissues, constitutes the essential of an individual sporangium.*

This definition is open to criticism, as indeed are all definitions of bodies represented in a large series of variable organisms. Still, it brings out the point that the essential feature of a sporangium is the presence of one or more spore-mother-cells, but without reference to the detail of their production, or to the structure of the wall which covers them. It has its value in ridding the idea of the sporangium of its accidental accessories, and fixing the attention upon what is really essential.

But it will perhaps be objected that a sporangium may still be a sporangium though it may contain no fertile cells; many imperfect structures may be quoted which have the form, position, and other details characteristic for the sporangia of the plant on which they are borne: they should thus to be ranked as sporangia. That is true: but as such bodies do not as a rule serve any useful purpose, it may be asserted that they would never have existed independently of the fully formed sporangia of which they are the imperfect representatives. Such vestigial parts, being of secondary origin, need not disturb the conception of the sporangium as above defined.

Finally, an important feature of the sporangium is to be seen in the fact that in so many cases the archesporium is not strictly circumscribed; the sporogenous group has often ragged edges; in many of the Eusporangiate forms it does not arise from any single archesporial cell, or definite group of cells: moreover, cells which are obviously sister-cells may not unfrequently be found to develop the one sterile, the other fertile. This suggests on the basis of structure that the fertile tract is a residuum left by advancing sterilisation, while the ragged and ill-defined limits point to the conclusion that the sterile and fertile tracts are closely related: in fact, that they had a common origin, and that the final condition represents the balance struck between sterile and fertile development. From the point of view of the hypothesis of progressive sterilisation such sporangia may, at least in the simplest cases, be regarded as islands of fertile tissue which have retained their spore-producing character. It will be seen later how far this view will have to be modified in the more complex and derivative cases, such as the Leptosporangiate Ferns.

CHAPTER IX.

SOME GENERAL ASPECTS OF THE POLYSPORANGIATE STATE.

It has been pointed out in Chapter VI., which dealt with the Biological Aspect of Alternation, that in the case of plants of aquatic origin migrating to the land an increasing production of non-sexual germs, or spores, would become important. Since under those circumstances dependence could no longer be placed on frequent recurrence of fertilisation, the production of numerous spores as a consequence of a single fertilising act will be essential, if the race is to survive and be in a position to compete and to extend its area. Other things being equal, the larger the spore-output the better. This should be constantly before the mind in the comparative study of the more primitive types of sporophyte, and the same principle should be applied to the more complex forms also, though in them the evidence is necessarily less obvious.

The antithesis between the Bryophyta and the Pteridophyta, as regards the method of spore-production, is chiefly marked by the former having one concrete sporogenous tissue, the latter numerous discrete sporogenous groups which form the centres of more or less distinct sporangia. The Bryophyte type is essentially a limited one, for indefinite enlargement of the concrete sporogenous tissue introduces mechanical and nutritive difficulties: these are most urgent at the critical period of separation of the spore-mother-cells, when they are floating freely in the fluid contents of the spore-sac. In actual life the Bryophyte type is almost always annual, and does not extend beyond limited proportions; nor is there evidence that it ever attained a larger size in earlier periods. This is exactly what biological considerations would have led us to anticipate.

But in the homosporous Pteridophytes, given an enlarging vegetative system, which in them is usually perennial, there seems no limit to the number of sporangia which may be borne on the individual plant; and as each sporangium is of moderate size, the mechanical and nutritive requirements at the critical period of tetrad-division are suitably met, while

the total output of spores from the numerous sporangia may be virtually unlimited: moreover, their production may be extended over many years on the same individual plant. Since, in the homosporous forms, each single spore is small, and therefore conveys with it only a small store of nutriment, the risks on germination are great; a reasonable chance of success is, however, secured by their large number.

But with the heterosporous condition complications arose. Owing to the storage arrangements in the enlarged female spore, this more specialised state leads to economy in number of the spores necessary to secure survival and spread of area; for each female spore carries with it, in its higher store of nourishment, a higher probability of successful establishment of an embryo, and a sufficient degree of propagative probability can thus be attained with a moderate number of spores. Hence heterosporous types may be expected to present examples of reduction of number, not only of sporogenous cells, but also of sporangia. That is seen to be actually the case, and it might be illustrated by numerous examples. It will then be in homosporous types, which are certainly the more primitive, that we shall expect to meet with the best evidence as to the origin of the polysporangiate state, or with traces of increase in number of sporangia; in fact, they will illustrate more faithfully than heterosporous forms the upgrade of complexity of their spore-producing parts.

On grounds of nutrition of the spores, and of stability at the critical stage when the spore-mother-cells are floating in fluid, there is a clear advantage in the segregation of the spores into separate pockets—the sporangia—as against any method of indefinite enlargement of a single sac. It is probably such conditions as these which have also determined the limits of size of the individual sporangia of the Pteridophytes, and led to some degree of uniformity in their dimensions. But still considerable variations in size of the sporangia are found to occur, even in close juxtaposition on the same plant: this is most conspicuous in the Eusporangiate forms. Sometimes the difference in size seems to be dependent on nutrition; for instance, it is usual to find about the upper and lower limits of the fertile strobilus of Lycopods sporangia of smaller size than those about the middle of the fertile region: the same is the case in the Psilotaceae and in *Equisetum*. But in other cases this simple explanation will not suffice, for smaller sporangia may be found distributed between the larger ones: this is especially so in the sori of the Marattiaceae, and a general survey shows that in many of the Eusporangiate forms the single sporangium is not quantitatively a definite unit.

But though there may thus be wide variation of size of the individual sporangia in certain Pteridophytes, still in others their dimensions are often very uniform. In the Leptosporangiate Ferns, indeed, the number of spores in a single sporangium is often strictly constant. In that case change in the output of spores on the plant is effected by change in the

number of the sporangia, not by variation of their dimensions: thus the number of the sporangia may come to be an approximate measure of the spore-output, as it is in fact in the *Leptosporangiate* Ferns.

The several types of *Pteridophytes* differ greatly in the closeness of the relation of their sporangia to the axis of the shoot; it will be pointed out in detail below how the five main series of them—the *Lycopodiales*, the *Equisetales*, the *Sphenophyllales*, the *Ophioglossales*, and the *Filicales*—exhibit successive degrees of enlargement of the appendicular organs, and of the consequent removal of the sporangia from the central axis. The strobiloid character, with small appendages, and one sporangium at the base of each, or even seated on the axis itself, is characteristic of the *Lycopods*; but this regularity is not characteristic of the larger-leaved types: thus the definiteness in number and in position of the sporangia relatively to the other parts, which is as a rule absolutely exact in the *Lycopods*, is less strictly observed in the *Equisetales* and *Sphenophyllales*, and it is almost entirely absent in the *Ophioglossales* and *Filicales*, in which the sporangia are borne upon the large leaves, far removed from the central axis: their number and their arrangement there tends to be indefinite. These facts may be summarised into the statement that in the *Pteridophytes* those forms which bear their sporangia in closest relation to the axis show the most strict definiteness in their number and position: where the sporangia are removed from the central axis, being borne upon larger appendicular organs, they habitually show less definiteness in number and in position.

The indefiniteness of number of the sporangia thus seen in the *Ophioglossales* and *Filicales* is an illustration of the variability of multiple structures, alluded to by Darwin as follows: "It seems to be a rule, as remarked by Is. Geoffroy St. Hilaire, both with varieties and species, that when any part or organ is repeated many times in the same individual (as the vertebrae in snakes and the stamens in polyandrous flowers) the number is variable: whereas the same part or organ, when it occurs in lesser numbers, is constant." That constancy is seen in the *Lycopods* in high degree: it is departed from to some extent in the *Sphenophyllales* and *Equisetales*, and it becomes unrecognisable in the *Ophioglossales* and *Filicales*, in which the number of sporangia on each appendage is large.

It has been remarked above that it is still an unsolved problem what those intimate influences are which determine the development of any specific cell of the plant-body as a spore-mother-cell on the one hand, or as a vegetative cell on the other. This determination lies at the root not only of the limitation of sporogenous tissues, but also of the initiation and consequent number of sporangia. The determining factors are probably numerous: suitable nutrition is certainly one. Speaking generally, better nutrition is clearly connected with more ample spore-formation; but it is also well known that a plethoric state may lead to sterility in certain

cases while starvation may conduce to early flowering in many Angiosperms. Thus the relation of nutrition to the production of sporangia is not of a simple character. Goebel (*Organography*, p. 498) speaks of other factors, such as intensity of light, and internal conditions or correlations, as influencing the production of sporophylls. Experimentally it seems easier, however, to convert sporophylls into foliage leaves than to make foliage leaves fertile. He quotes, nevertheless, the case of a Fern, allied to *Acrostichum Blumeanum*,¹ in which an arrest of growth of the rhizome, after previous good nourishment, led to production of sporangia. This is a result similar to that following root-pruning of fruit-trees. It reminds us also of the conditions found by Klebs to determine the production of reproductive organs in certain Algae and Fungi.² I do not suppose, however, that the conditions will be found to be uniform for all sporophytes, any more than they have been for Algae or Fungi. In any case, the present knowledge of the whole subject for Vascular Plants is indefinite and uncertain.³

The *time* of distinctive development of cells as sporogenous cells varies in different plants: the following tentative conclusions may be drawn from such differences. When in a tissue-tract the distinction between vegetative and sporogenous cells takes place relatively late in the individual, the presumption is that the distinction has been of late origin in the race. On this basis the conclusion has been founded in certain cases that increase in number of sporangia by septation has occurred. A large potential sporogenous tissue having a common origin is first seen; but later it differentiates, part becoming actually sporogenous, part remaining sterile. It is concluded that these late-differentiated sterile tracts were once in the race fertile, and that they were subsequently diverted from this previous condition; in fact, that the ontogenetic development reflects the evolutionary history. This is exemplified in certain Angiospermic anthers, in the synergia of *Tmesipteris*, and in the partially septate sporangia of *Danaea*: the same general argument holds also for the sporangium of *Isoetes* with its trabeculae. In other cases where the distinctive characters of the sporogenous cells or cell-groups are acquired earlier, the argument for septation is less clear, though on grounds of comparison a similar history of the structure actually seen appears probable.

The cases above mentioned involve sporangia which are closely associated as synergia, and they are naturally initiated simultaneously. But differences of the time of distinctive development of sporogenous cells may become more obvious in sporangia which are separate from one another, though in close proximity upon the part which bears them. In those types which comparison, as well as the Palaeontological record, points out as the

¹ Raciborski, *Flora*, 1900, p. 25.

² *Die Bedingungen der Fortpflanzung*, 1896.

³ The determining conditions have been discussed by various writers. See Diels, *Jugendformen und Blütenweise im Pflanzenreich*, Berlin, 1906, where reference is made to the literature on the subject.

earliest, the sporangia in near juxtaposition show a simultaneous origin; or some degree of succession may be seen from those earlier formed near to the base of the shoot or leaf, and leading to the apical region, where they appear later. Such simultaneity, or such acropetal succession, may be regarded as a primary condition, and it is seen in the Lycopodiales, Equisetales, and Sphenophyllales, as well as in those Ferns which are designated below the Simplices (see Part II.). But in certain Ferns, which the Palaeontological record, as well as comparison, would mark out as secondary, the sporangia in near juxtaposition do not arise simultaneously: sometimes, as in those which will be styled the Gradatae, there is a regular basipetal succession within the sorus, those lowest on the receptacle appearing latest. In others, again, there is no such regularity, and sporangia of different ages are found promiscuously intermixed: these Ferns are styled the Mixtae, and the Palaeontological record indicates that these were the latest to appear. Such facts, which will be stated at length below (Part II.), may be summed up into the following general statement. In the most primitive forms the sporangia in near proximity to one another develop simultaneously, though an acropetal succession may often be traced on the shoot or strobilus as a whole. Those successions, whether in regular order or irregular, which appear in various forms upon the leaves, may be held to be later derived, and secondary.

It will be readily gathered from the contemplation of those plants in which sporangia are numerous that accurate comparison of individual sporangia as identical bodies in parent and offspring, or in different, less closely related specimens, is not possible in plants at large. For the most part sporangia are merely examples of "essential correspondence" rather than of "individual repetition." The actual sporangia of the offspring are not coincident, as a rule, either in exact position or in number with those of the parent. This is a consequence of that continued embryology which is a leading feature in all vascular sporophytes. As a consequence the individual sporangia of any one individual plant or species cannot be held to be the exact ontogenetic correlatives of those seen on another individual or species. The possibility of such a recognition is most nearly approached in the Lycopods, where the sporangia are borne singly in definite relation to the axis and leaf. It is departed from furthest in the large-leaved Ferns: especially is this so in the Polypodiaceae, where the mixed character of the sorus is the rule: but most of all in such a case as that of *Aspidium anomalum*, Hk. and Arn., a Fern found on the uplands of Ceylon, and sometimes regarded as a mere variety of *A. aculeatum*, Sw.: its peculiarity consists in the appearance of sori upon the upper surface of the leaf, where normally they do not occur. As there is no question of mere inversion of the leaf, it can only be assumed that there has been a transfer of the stimulus, whatever it be, to soral development from the lower to the upper surface of the leaf. Clearly the sori which result cannot be the ontogenetic correlatives of any

previously existent in the race: much less is this possible for the individual sporangia of those sori. Such an example shows, in its most extreme form, how impossible it may be to compare, as numerically or locally identical, the otherwise similar parts, such as sori or sporangia: and this is most clearly so in the Ferns, where the leaves are large, and the sori and sporangia borne upon them more numerous than in any other Vascular Plants.

We thus see that the homosporous Pteridophytes, which are certainly the more primitive, will be the best guide in questions of the origin of the sporangial state: and that these may be arranged serially according to size of the appendages, the strobiloid types being at one end of the series and the large-leaved Ferns at the other. The forms thus arranged show more or less clear differences in the sporangial characters: in the simpler strobiloid forms the sporangia are less definite units as regards spore-output, in the Ferns they have tended to become in the evolutionary course more definite units in this respect. In the strobiloid forms the relation of the sporangium to the axis is close, and as regards position and number it is more definite; in the larger-leaved forms the sporangia are further removed from the axis, and their position and number tends to become more and more indefinite. In the strobiloid forms the time of origin of the sporangia in near juxtaposition to one another is simultaneous: in the larger-leaved forms it tends to become in various ways successive, while the palaeontological record shows that the most pronounced successions have been of secondary origin. These distinctions will have their value in leading to a more precise statement of the problem of origin of the sporangial state. To this end it will be found desirable to keep distinctly before the mind those vascular types in which the nearest approach can be made to a comparison of the sporangia as numerically and locally identical. Among the homosporous Pteridophytes this will be found to be the case most nearly in the smaller-leaved strobiloid forms: and among these especially in the ancient phylum of the Lycopodiales.



CHAPTER X.

VARIATIONS IN NUMBER OF SPORANGIA.

NOTWITHSTANDING the familiarity of the fact that the polysporangiate state is the constant condition in Vascular Plants, little attempt has hitherto been made to analyse the methods of variation in number of the sporangia which they bear. But this would appear to be a promising line of enquiry, for it may be held that an adequate knowledge of the methods of variation seen to be actually operative now should throw light upon the factors which have been operative in the past, and thus some suggestion should be obtained how the divers polysporangiate types came to be as we now see them. To such an end the facts drawn from those organisms which are held to be relatively primitive, such as the homosporous Pteridophytes, will naturally bear greater weight than those derived from more recent and specialised forms, such as the Flowering Plants. Nevertheless it will be best to treat the question of change of number of sporangia first of all in its relation to the Vascular Plants as a whole, so that all the known factors may be disclosed: and it will be a matter for subsequent discussion to decide in any individual case which of those factors appear to have been operative in bringing that organism to its present condition.

The subject of variation in number of sporangia in the individual or the race may be discussed either from the physiological or from the morphological point of view: it is the morphological question which will now be brought forward, though always in the light of physiological considerations. But I wish at once to meet the objections of those who will say from the physiological side that the number of sporangia depends on nutrition: this self-evident proposition neither explains nor rules out the morphological question how a plurality of sporangia arose, nor how the great numerical differences which we see may have been attained: nor does it modify the effect which observations of their numerical change in the living individual, species, or genus may have on views of Descent of the plants observed. By such observation and comparison of living

plants it is possible to recognise certain methods of numerical change of sporangia, now or previously operative: these may either lead to progressive *increase* in number, or to *decrease* in number. Under these two heads the following table shows the several methods of change in number of sporangia of which evidence has been found in living plants, but it is possible that the table is not exhaustive:

I. INCREASE IN NUMBER OF SPORANGIA.

- (a) By septation, with or without rounding off of the individual sporangia.
- (b) By formation of new sporangia, or of new spore-bearing organs, which may be in addition to, or interpolated between those typically present.
- (c) By continued apical or intercalary growth of the parts bearing the sporangia.
- (d) By branching of the parts bearing the sporangia.
- (e) Indirectly, by branchings in the non-sporangial region, resulting in an increased number of sporangial shoots: this is closely related to (c) and (d).

II. DECREASE IN NUMBER OF SPORANGIA.

- (f) By fusion of sporangia originally separate.
- (g) By abortion, partial or complete, of sporangia.
- (h) By reduction or arrest of apical or intercalary growth in parts bearing sporangia.
- (i) By fusion of parts which bear sporangia, or arrest of their branchings.
- (j) Indirectly, by suppression of branchings in the non-sporangial region, resulting in decreased number of sporangial shoots: this is closely related to (h) and (i).

Each of these factors of variation will now be discussed, and examples of them adduced. At the moment the object is only to recognise that such modifications of number of sporangia are or have been operative in actual cases, not to estimate the relative prevalence of any one: for it is necessary first to distinguish the factors of the problem.

FACTORS OF INCREASE.

(a) Increase in number of sporangia by *septation*, resulting in a plurality of loculi, where previously in the race the septa were absent, is shown in the septate anthers of various families of Angiosperms (Onagraceae, Mimoseae, Rhizophoreae, Myrsinaceae, Loranthaceae, etc.). The details have already been sufficiently described in Chapter VII., p. 97. The argument that septation has occurred is in many of these cases quite conclusive: thus the plurilocular anthers of certain genera of the Onagraceae

have the numerous small loculi arranged in four rows, corresponding in position to the four pollen-sacs of the normal anthers in other genera of the family, the only essential difference from these being the presence of the septa which separate the loculi. The cells which form the septa are similar in position to the archesporial cells of the normal anther (Fig. 62), and the conclusion is that certain of the archesporial cells are no longer fertile, but develop to form the sterile tissue of the septum. A similar argument will apply for other families of Angiosperms with varying degrees of cogency, according as the septate anthers diverge less or more from the usual type, or according to the less or greater isolation of the genera which show the multilocular state. In the Pteridophytes also there are cases of juxtaposition of loculi similar to those in the septate anthers:

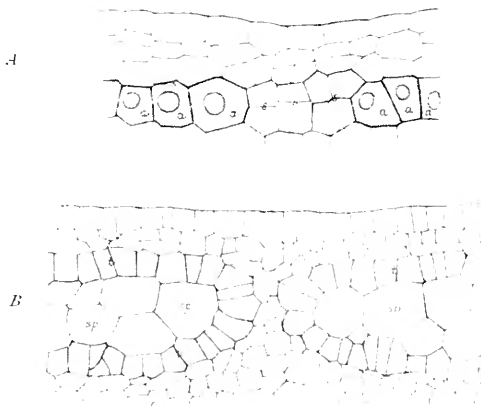

FIG. 62.

A, longitudinal section of one loculus of a young stamen of *Eucharidium concinnum*, showing differentiation of the potential archesporium into fertile cells (*a*) and sterile cells (*s*). *B*, similar section of stamen of *Clarkia elegans*, more advanced, showing a sterile septum dividing the contents of the single loculus into distinct sporogenous groups (*sp*). *t*=tapetum. $\times 305$.

conspicuous instances are found in the spike of *Ophioglossum*, and in the sorus of *Danaea*. But the development in the Pteridophytes gives less conclusive evidence than in the anthers of Angiosperms, owing to their meristems not being stratified, and to the fact that the genera are more isolated. But though the facts in these plants do not amount to a complete demonstration, there seems a reasonable probability that septation has played a part among them also. Whatever view be taken for these Pteridophytes, it is clear from the examples quoted from the Angiosperms that septation of sporangia previously in the race non-septate has been a factor of increase in number of sporangia.

(*b*) By the formation of new sporangia, or *interpolation*, is meant the initiation of a new sporangial primordium, or of several, at a spot previously in the race not so occupied. The results of this mode of increase may in some cases be difficult to differentiate from those of septation, where

the products have been rounded off: they will be best distinguished in the early stages of development. A good, clear example is found in the genus *Gleichenia*: the sorus of most species of the genus is of the radiate, uniseriate type, in which the sporangia form a series round the receptacle, while the centre of it is unoccupied by sporangia: there is good comparative reason to believe that this was the primitive type of sorus for the genus. But in *G. dichotoma* additional sporangia, one or more, are often seated in the central unoccupied space (Fig. 63). Examination of early stages of development shows that these sporangia are not a result of fission of sporangia typically present, but develop from new primordia not represented in other species (Fig. 64). The interpolation, of which this is a simple case, becomes a more prominent feature in the Ferns which palaeontology

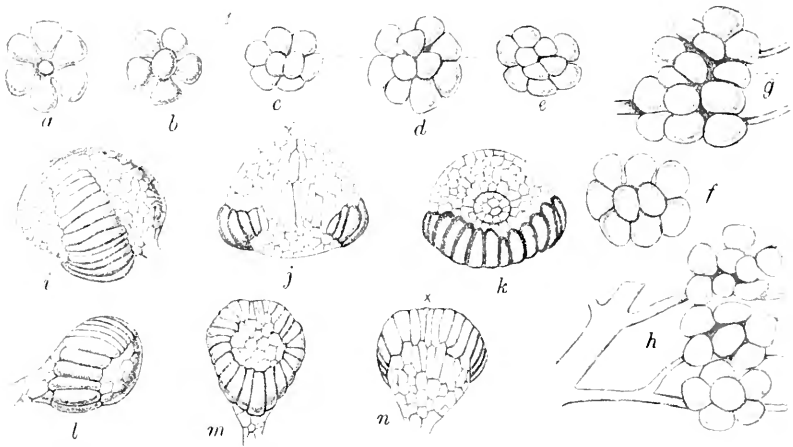

FIG. 63.

a-h, sori of *Gleichenia dichotoma*, Willd. Showing one or more sporangia in the centre of the sorus, usually in this genus vacant. *i-k*, sporangia of *G. circinata*, Sed. *l-n*, sporangia of *G. dichotoma*. *a-h* about 14. *i-n* $\times 50$.

teaches us to regard as the more recent. The succession of the sporangia characteristic of those Ferns which will be styled on that account the Gradatae, may be recognised as a repeated basipetal interpolation of sporangia on the receptacle of the sorus (Fig. 65 A). In the Mixtae it is still more prominent in the sorus, for new primordia, formed in continued succession, appear scattered between those which are more advanced (Fig. 66). But interpolation may take place not only of sporangia, but also of new spore-bearing organs between those typically present. This is exemplified in the interpolated stamens in certain flowers, the number of which is closely related to their bulk, and to the space available for them on the floral receptacle. Such interpolation of sporangium-bearing parts will clearly result in an increase in number of sporangia. The prevalence of interpolation thus seen in the Leptosporangiate Ferns, has given an entirely fictitious importance to this phenomenon in the general

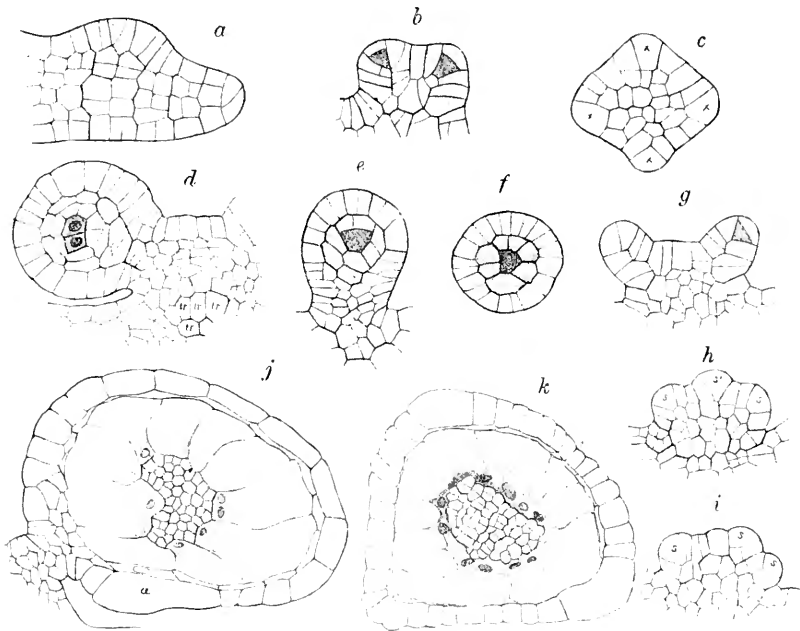

FIG. 64.

a, b, c, j, k=*Gleichenia flabellata*, Br. *d, e, f*=*Gleichenia circinata*, Sw. *g, h, i*=*Gleichenia dichotoma*, Willd. *a, b, c, d*, show young sori with sporangia marginal. *g* shows a similar condition in *Gleichenia dichotoma*, but in *h* and *i* the vacant middle space is occupied by young sporangia. *a-i* × 200, *j, k* × 100.

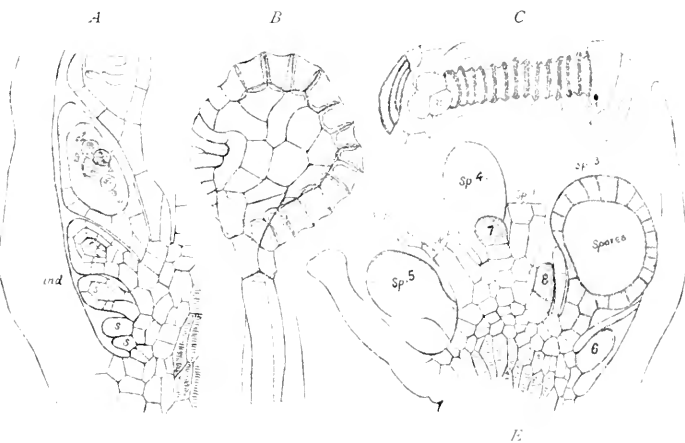

FIG. 65.

A, B, *Dennstaedtia apiifolia*, Hook. *A* shows the regular basipetal succession of sporangia characteristic of the Gradate. *C, D*, *Dennstaedtia virginosa*, Kaulf. *D* shows irregularity in the succession. × 100.

morphology of Vascular Plants; while the regularity and constancy in number and position of the sporangia in the Lycopods, Equiseta, and Eusporangiate Ferns, in which interpolation does not occur, has been underestimated. But these, on grounds of comparison, and of fossil history, are among the most primitive of Vascular Plants. Thus interpolation of new sporangia is to be recognised as an actual factor of increase in number of sporangia, but it is not a general phenomenon, and there is reason to

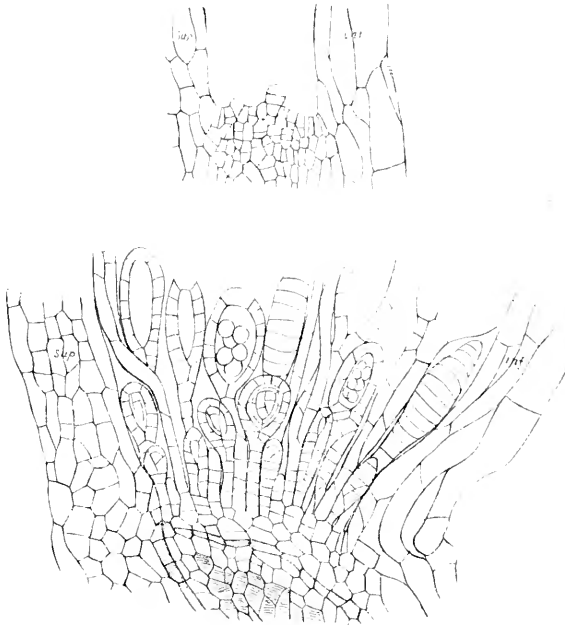

FIG. 66.

Sorus of *Duvallia griffithiana*, Hk. Showing sporangia of different ages irregularly intermixed. $\times 100$.

think that it has been initiated as a secondary character, and in certain groups only.

(c) *Continued apical growth of the parts bearing the sporangia* is a marked feature in most Vascular Plants: a concomitant of it, in the case of axes, is a continued embryology, with the initiation of an indefinite number of successive primordia of spore-producing parts. This is conspicuous in the axes of many Lycopods, and especially so in the *Selago* group of *Lycopodium*, where it appears to be unlimited: in other species of the genus the apical growth of the strobilus also exists, but is of shorter duration (Fig. 67). Much the same is the case in other strobiloid types, with varying duration of the apical growth. The apical growth of the axis is apt to be less prominent where the appendages are large, as in the

Ophioglossaceae and Filices, and in these the continued apical growth may largely devolve upon the sporophylls. The consequence of such growth is increased accommodation for sporangia. Similarly, continued intercalary growth may effect the same end: as in the sori of those Ferns designated

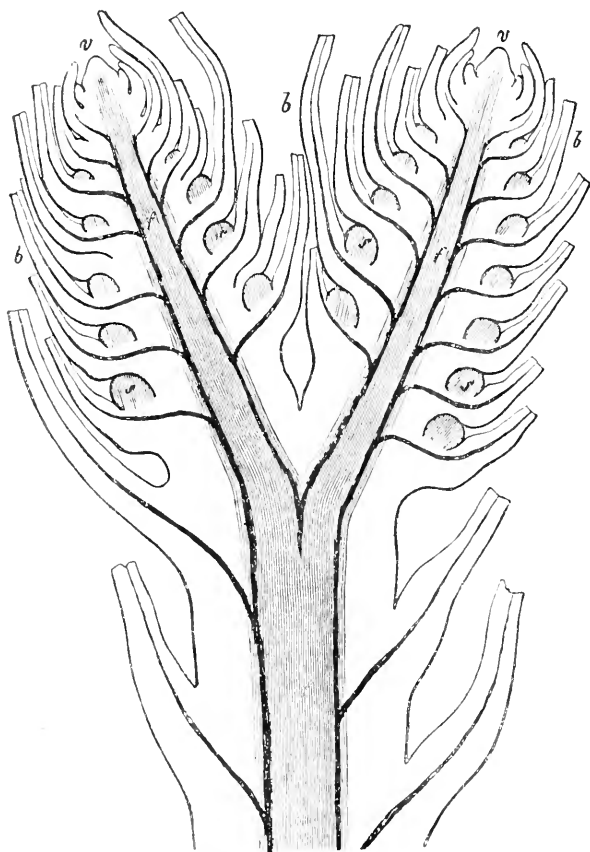

FIG. 67.

A forked sporangiferous branch of *Lycopodium chamaecyparissus* in longitudinal section, slightly magnified. *ff*=the axile vascular body. *bb*=leaves. *ss*=young sporangia.

the Gradatae. These serve as examples of the way in which, by continued growth of the parts which bear the sporangia, a sequence of these may be produced, which may be continued so long as the growth itself. It is clear from the examples adduced that such continued growth may occur in parts which are not morphologically comparable. In the more primitive Pteridophytes it is answerable for extensive increase in accommodation for primordia of sporangia.

(d) Closely related to (c) is the *branching of parts bearing sporangia*: this may also occur in parts which are in no way morphologically comparable. Branching of strobili is a common feature in *Lycopodium* and *Psilotum*: branching of the sporophyll is characteristic of most large-leaved Pteridophytes: branching of the receptacle of the sorus is common in

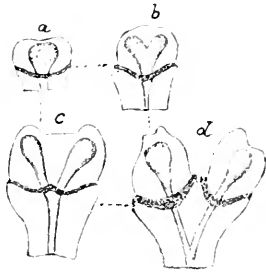

FIG. 68.

a-d, various examples of fission of the sorus in *Hymenophyllum dilatatum*. The sporangia, and one flap of the indusium have been removed, leaving the receptacle exposed. \times about 5.

not only is the vegetative indirect effect in increased powers of nutrition, which will have its indirect effect in increased apices are provided, any one of which may take up the character of a sporangial strobilus. The continued apical growth in the vegetative region is a general feature of Vascular Plants. Branching is profuse in many of the strobiloid Pteridophytes: in the Ferns also it occurs, but the effect in increasing the opportunities for spore-production is less obvious here than in the strobiloid types. In Flowering Plants also the complicated inflorescences and the multiplicity of flowers is dependent upon such apical growth, together with repeated branchings.

FACTORS OF DECREASE.

(f) Decrease in number of sporangia, by *fusion of sporangia* which previously in the race were separate, has been assumed as an explanation of synangial states by various writers: but it can only rarely be proved on grounds of comparison that fusion of sporangia has actually taken place, and the best evidence of it comes from the Angiosperms: Thus the fusion of the ovules, leading indeed to the obliteration of their identity, occurs in certain species of *Loranthus*, and comparison leaves little doubt that the sunken embryo-sacs represent the individual ovules, the identity of which is lost as regards external form. Fusion of pollen-sacs is more frequent; good examples, showing various states of the fusion, are found in the genus *Phyllanthus*, and in *Cyclanthera*: while the unilocular condition in

Ferns (Fig. 68): branching of the fertile spike is a marked feature in certain Ophioglossaceae: branching of stamens is common in the Angiospermic flower, and is to be distinguished from the interpolation above mentioned: a somewhat similar branching of the sporangiophores has probably occurred in the Sphenophylleae. In all such cases, though the parts are not morphologically comparable, the end is attained of an increased accommodation for sporangia, which consequently may be produced in increased numbers.

(e) *Continued growth and branching, occurring in the non-sporangial region*, may have the indirect effect of a further increase in the opportunities for production of sporangia; for system thereby increased, which will have its

Arisarum, and in *Najas*, §*Caulinia*, can hardly be ascribed to any other source than the fusion of the pollen-sacs, separate in the ancestry, into a single loculus. Thus in the androecium of Angiosperms, and occasionally

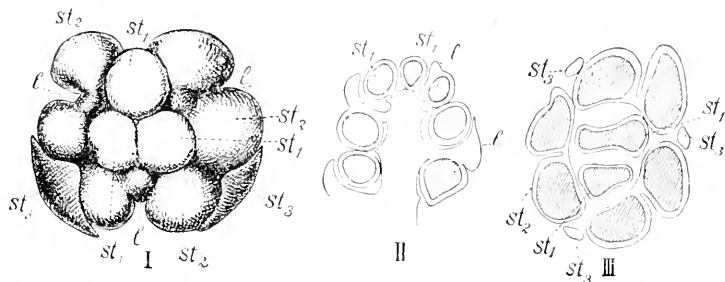

FIG. 69.

Juniperus communis. I., summit of a male flower seen from above. st_1 , the uppermost staminal whorl of these stamens; st_2 , the second staminal whorl shows on each stamen two pollen-sacs, and the indication of a lamina, l ; st_3 , the third staminal whorl, of which only the tips of two stamens are seen: each of the stamens of this whorl had three pollen-sacs, not shown in the figure. II., the same in longitudinal section. III., the same in transverse section. There is evidence here of reduction of the lamina, and of fusion of the pollen-sacs. (After Goebel.)

in the gynoecium, a fusion of sporangia is recognised, resulting in a reduction in their number. The apex of the male flower in *Juniperus communis* has been quoted by Goebel as a probable example of fusion of pollen-sacs (Fig. 69). In certain Pteridophytes the grouping of the sporangia is often such as to suggest a previous fusion; but this has not been proved on developmental or comparative grounds for any one case, and the question must be left open for discussion on grounds of general probability whether the synangial state in any individual case has been the result of fusion, or of septation with incomplete separation of the sporangia: obviously the synangial structure would be compatible with either origin. Whatever the final decision for the Pteridophyta may be, it is clear that fusion of sporangia originally separate has actually occurred in Flowering Plants: it is therefore a factor which must be regarded as a possible explanation of all synangial states.

(g) *Abortion*, partial or complete, of sporangia which were fully matured in the type or ancestry is so common a feature that special examples need hardly be quoted. Abortive pollen-sacs are commonly found on staminodes, and abortive ovules are frequently seen, as in *Anemone* (Fig. 70), which can only be accepted as the imperfect representatives of a plurality of ovules in the ancestry. In the Pteridophytes many examples of abortive sporangia have lately been described, and their very important morphological bearings will be discussed at length in Chapter XIII. But in connection with the circumstance that parts



FIG. 70.

Carpel of *Anemone nemorosa*, L., showing one ovule developed, and three abortive. (From Engler and Prantl.)

initiated frequently do not come to full maturity this further fact is to be borne in mind: that it is common in the ascending series of plants to find a larger number of primordia initiated than the individual can bring to full development. Consequently it will be necessary to discriminate between those imperfect parts which represent such as were fully matured in the ancestry, and those supernumerary primordia which do not represent parts ever actually matured in previous generations. In point of fact, unperfected primordia may, in some cases, really represent an exuberant tendency to progress, and cannot necessarily be assumed to indicate a state of reduction.

(h) *The reduction or arrest of apical or intercalary growth in parts bearing sporangia* has doubtless been a potent influence in the past, but it is somewhat difficult to point to concrete examples of it. The general fact that the floral axis in Phanerogams is abbreviated, while the axis of the strobilus in Pteridophytes is frequently endowed with continued apical growth, points to the probability of arrest of that apical growth. An example of it within a near circle of affinity is seen in the genus *Lycopodium*; for in the section *Selago* the apical growth of the axis is unlimited, and the number of possible sporangia borne on a given axis is unlimited also: in other sections of the genus which are held to be more specialised, as the strobilus becomes more strictly differentiated from the vegetative region the apical growth is arrested early, and the number of sporangia produced upon it is limited also. In floral details this is illustrated in some families of Angiosperms: thus the Ranunculaceae include such forms as *Myosurus*, with its elongated receptacle and indefinite number of carpels, and *Actaea*, with its abbreviated axis and only a single carpel. It seems probable that here also arrest of the apical growth has been associated with reduction of the number of sporophylls and of sporangia.

(i) *Fusion of parts which bear sporangia* is not so susceptible of illustration in the Pteridophytes as in the Angiosperms. A most convincing series of reduction is laid out in the Araceae by Engler, involving fusion of stamens, accompanied by reduction in number of the pollen-sacs (*Nat. Pflanzenfam.* II. i., p. 107). Many examples might also be quoted from other Angiosperms, e.g. Cucurbitaceae, Euphorbiaceae, where fusion of parts is connected with reduction in number of the sporangia which they bear. A suppression of branchings of sporangium-bearing parts may also be a factor: it has at times been assumed in theoretical writing, but it is difficult to give conclusive examples of it.

(j) Indirectly the *arrest of apical growth and the partial or complete suppression of branchings in the non-sporangial region* may affect the number of sporangia produced. The abortive buds at the base of inflorescences of *Aconitum*, for instance, or the abortive spikelets in *Cynosurus* are examples of potentially larger numbers of spore-producing branches arrested before they bear sporangia. Such arrests of growth and of branching may have been more prevalent sources of change than

is apparent externally, for in the absence of vestigial parts there would be no trace of what had happened.

The methods of change thus enumerated are, then, the known factors which affect the morphological problem of origin and present condition of the polysporangiate state. Any one of these, or more, may have been represented in the history of descent of any polysporangiate sporophyte as it is seen to-day. The examples quoted show that the methods enumerated are seen to have been actually operative in definite, living instances. Possibly these heads do not exhaust the methods of change of the present day nor of the past, and the list is open to additions. We are justified in assuming that (subject to the possibility of other factors having been operative of which we are yet unaware) the condition of any polysporangiate sporophyte as we see it is the resultant of modifications such as these operative during its descent. The problem will therefore be in each case to assign its proper place in the history to any or each of these factors. But in each case the physiological probability of any modification which the structure would suggest should be considered before it is admitted as part of the evolutionary story. Especially is this desirable in determining the probable relative prevalence of modifications of increase as against those of decrease. It is only in this way that any apparent morphological series can be put upon a convincing footing as an evolutionary sequence. In complex cases, however, it may be a matter of difficulty to analyse a progressive change, and to decide which of the factors enumerated have actually been involved.

It will be obvious that a complete account, in any given case, of the steps which have led to its present polysporangiate state involves a full knowledge of its evolutionary history—a knowledge which is far beyond present powers. The advantage which an attempt to analyse the factors of sporangial modification brings, however imperfectly it may be carried out, is to simplify the problem in certain definite cases. For instance, if in a whole phylum of living plants a certain mode of sporangial increase be unrepresented, and if the related fossils show a similar absence of it, then it seems just to hold that that mode of increase may be dismissed from consideration in the probable evolutionary history of that phylum. The case of interpolation already alluded to is one in point: in connection with this it is necessary to reconsider and examine certain old habits of thought which have too long dominated such discussions as the present. About the middle of the nineteenth century it was habitually maintained that the Polypodiaceous Ferns were primitive forms, and the probable progenitors of all other Pteridophytes. So long as this view was held interpolation of new sporangia between older ones, which is so prominent in them, was regarded as a general phenomenon which might appear anywhere among the derivative forms. The fundamental idea

thus came to be that sporangia are bodies essentially indefinite in number and variable in place. The habit of interpreting lower forms in terms of the higher, which was also prevalent in earlier times, further encouraged this view: the common occurrence of indefinite stamens in Angiosperms made unduly familiar the idea of the sporangium-bearing parts, as well as sporangia themselves, being irregular in number and in position. But now there is good reason to believe that both the Angiosperms and the Polypodiaceous Ferns were of relatively late origin, and in no sense primitive forms. Also that the interpolation of sporangia, or of sporangium-bearing parts, which is found in them both, arose secondarily as a concomitant of the increase of the sporangia in either type to high numbers. If this be so, then there is no sufficient reason to look upon the sporangia of earlier and more definite types as in any way affected by the presence of this secondary indefiniteness in number and position. This principle finds its application as follows: it may be held that the Lycopods were independent of the Ferns in phyletic origin: hence the question of origin of their sporangia may be discussed without reference to interpolation at all, since it is not a characteristic of that family nor of its relatives. Similarly with the Marattiaceous Ferns, interpolation is not seen in the sori of any living representative of that family, nor is it demonstrated in their fossil prototypes: their sporangia are simultaneous in origin: the fact that the relatively recent Leptosporangiate Ferns show frequent interpolation of successive sporangia should not affect our view of those Fern-types which certainly preceded them in time. In point of fact, interpolation of sporangia is an occasional and not a general phenomenon: it is restricted to certain groups of plants, and is probably of secondary origin: in other groups where it has not been observed the sporangia are often seen to be stable in number and also in position. Accordingly the problem of evolutionary origin becomes more simple in those cases where interpolation may be left out of consideration altogether.

A second case in point, where it is necessary to clear the mind of old habits of thought before entering on evolutionary questions, is that of synangial sporangia, which are so frequent in the Eusporangiate Pteridophytes. The assumption was formerly common that where this condition is seen it is the result of fusion of sporangia previously in the race distinct. This assumption is again to be traced to the old habit of regarding the Polypodiaceous Ferns as the primitive stock of Pteridophytes: the sporangia in them are all separate: consequently it was held that where in other Ferns they are united, this must be a secondary condition. But the synangial condition may just as well have resulted from septation as from fusion: the question which is the correct view in any individual case is difficult to decide, but evidence of some value may be obtained by examination of the structure and development, as well as by general comparison of allied forms. In approaching such matters opinion must be unbiassed and open. Both fusion and septation have

occurred in various instances, and in any given case the proper initial attitude is to hold that either mode of origin may have been the source of the syngial state as it now appears.

The feature which has probably been most effective of all in distracting attention from the methodical analysis of the polysporangiate state in Vascular Plants at large has been the swamping effect of continued apical growth, and of branching. In the lower Vascular Plants both apical growth and branching may be seen in either the sterile or the fertile regions. In the higher Flowering Plants the floral region itself is characterised by absence of branching, and by restriction of apical growth, but both occur freely in the sterile region of the inflorescence. The results of this in the Flowering Plants are apt to be so dominating that it is often hard to recognise the small terminal and late-produced strobilus or flower as the actual residuum which progressive sterilisation and growth of the sterile tract have left.

Among Vascular Plants it is only in the simpler Pteridophytes that this aspect of the sporophyte generation clearly emerges: and this is largely due to the fact that in them branching of the axis is often less profuse, or may even be absent altogether: moreover, the structural similarity between the sterile and fertile regions suggests their comparison. As a consequence of such comparisons, it follows that the great disproportion of the two regions so often seen in the Flowering Plants may be discounted as a secondary effect: it has been brought about principally by continued apical growth and repeated branching in the vegetative region, together with higher differentiation of the sterile and fertile shoots. Maintaining consistently this point of view, the overpowering effects of continued apical growth and of branching will be estimated at their right value, and so the way may be prepared for a more exact enquiry into the origin of the polysporangiate state, even in the more advanced types. It is by some such analysis as that sketched in this chapter that it may be possible to attain to a reasonable opinion how the condition seen in the earlier Vascular Plants came into existence. The detailed practical application of the method may often be difficult, and only partially successful: the present object has been to lay the basis for such an analysis, by showing what the recognised factors of numerical change of sporangia actually are, and to simplify the problem by showing that certain of those factors are of limited application only.

CHAPTER XI.

THEORY OF THE STROBILUS.¹

THE term strobilus is commonly applied to those fertile spikes with small appendages which are found in a terminal position on the shoots of many Pteridophytes. The construction of the vegetative region below the strobilus in these plants is on essentially the same plan as the strobili themselves, but without the sporangia. The similarity of the two regions, as well as the absence of any definite limit between them, is demonstrated with peculiar clearness in the case of *Lycopodium Selago*, as shown in the Frontispiece. The absence of the sporangia in the vegetative region may be accounted for on the ground of abortion. If this be so, the structure of the strobilus will be the prototype for the vegetative shoot, and any theory of its origin with its appendages should cover that of the vegetative shoot as well.

The strobiloid condition was common among the earliest Pteridophytes of which there is any fossil evidence: there is thus a probability that it was a relatively primitive state. It is characteristic of the Equisetales, the Lycopodiales, and the Sphenophyllales, which are all relatively microphyllous; but the same type of construction is also traceable in radially constructed megaphyllous forms, and it will be shown later how the Ophioglossales, and even the large-leaved Filicales, may be referred back to the strobiloid type of construction, but with the appendages developed to an inordinate size.

The strobilus, in any of the small-leaved Pteridophytes, consists of a relatively bulky axis, endowed with more or less continued apical growth, and terminated by an apical cone, upon which the appendages arise laterally (compare Fig. 67, p. 125). Those appendages appear in regular acropetal order, below the apex of the axis; and they arise exogenously, as more or less massive outgrowths of the tissue of the apical cone (Fig. 71). They have these characters in common in all cases, and, according to the

¹This and the following chapters are largely based upon an address given at the International Exposition at St. Louis, U.S.A., 1904.

morphological method of the latter half of the nineteenth century, all the parts which share these characters would rank as "leaves," and be regarded as "homologous." But the progress of the science should be leading towards the refinement of the use of the term "homology": an approach must be made, however distant it may yet be, to a classification of parts on a basis of Descent. Though this may readily be accepted in theory, it is still far from being adopted in the practice of Plant-Morphology. None the less, comparison is inevitably leading to the disintegration, on a basis of Descent, of the old-accepted categories of parts: and in the case of the appendages which are collectively styled "leaves," the question arises whether they are all truly comparable in Vascular Plants. This is clearly in close relation to the question of their origin, and we shall enquire

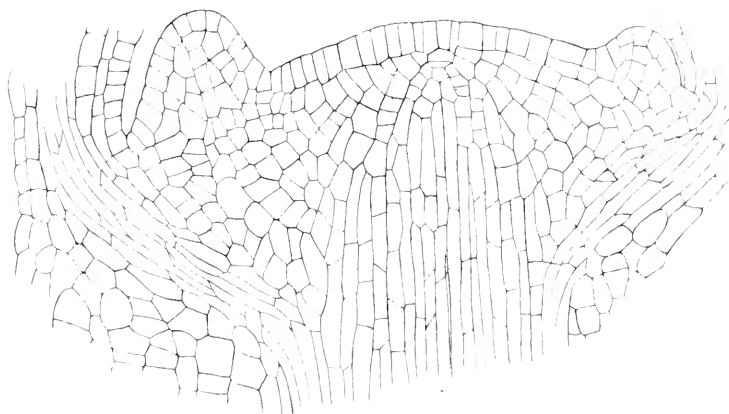

FIG. 71.

Longitudinal section through the apical cone of the stem of *Lycopodium Selago*. $\times 160$.
(After Strasburger)

whether there is not reason to think that the initiation of the foliar appendages may have been polyphyletic.

To those who hold the view that the two alternating generations of the Archegoniatae have had a distinct phylogenetic history, it will be clear that their parts can not be truly comparable by descent. The leaf of the Vascular Plant, accordingly, will not be the correlative of the leaf of a Moss. Even those who regard the sporophyte as an unsexed gametophyte will still have to show, on a basis of comparison and development, that the leaves of the two generations are of common descent. I am not aware that this has yet been done by them.

But the phylogenetic distinctness of origin of the leaves of the sporophyte and gametophyte is not the only example of parallel foliar development. Goebel has shown with much cogency that the foliar appendages of the Bryophytes are not all comparable as regards their origin; he remarks, "It is characteristic that the leaf-formation in the Liverworts has arisen

independently in quite a number of series,"¹ and has shown that they must have been produced in different ways. Here then is polyphyleticism in high degree, seen in the origin of those parts of the gametophyte which on grounds of descent we have already separated from the foliar appendages of the sporophyte.

Such results as these for the gametophyte lead us to enquire how the case stands as to the origin of foliar differentiation in Vascular Plants. In discussing such questions, it is to be remembered that in different stocks the foliar condition of the sporophyte as we see it may have been achieved in different ways, just as investigators have found reason to believe that it was in the gametophyte. We have no right to assume that the leaf was formed once for all in the descent of the sporophyte. But at the moment we are unprovided with any definite proof how it occurred. All the evidence on the point is necessarily indirect, since no intermediate types are known between foliar and non-foliar sporophytes. Physiological experiment has as yet nothing to say on the subject. The fossil history of the origin of the foliar state in the neutral generation is lost, for the foliar character antedated the earliest known fossil-sporophytes. There remain the facts of development of the individual, and comparison, while anatomical detail may have some bearing also on the question; but all of these, as indirect lines of evidence, fall short of demonstration, and accordingly it is impossible to come at present to any decision on the point. For the purposes of this discussion, however, we shall proceed on the supposition that all leaves of the sporophyte generation originated in essentially the same way, though not necessarily along the same phyletic line.

There are at least three alternatives which may possibly have been effective in the origin of a foliar differentiation of the shoot, in any progressive line of evolution of vascular sporophytes: (1) That the prototype of the leaf was of prior existence, the axis being a part which gradually asserted itself as a basis for the insertion of those appendages; the leaf in such a case would be from the first the predominant part in the construction of the shoot. (2) That the axis and leaf are the result of differentiation of an indifferent branch-system, of which the limbs were originally all alike; in this case neither leaf nor axis would predominate from the first. (3) That the axis pre-existed, and the foliar appendages arose as outgrowths upon it; in this case the axis would be from the first the predominant part.

The first of the above alternatives, viz. that the prototype of the leaf existed from the first, and was indeed the predominant part in the initial composition of the shoot, has been held by certain writers as the basis of origin of the leafy shoot in vascular plants.² On this view not only is the

¹ *Organography*, p. 261.

² Goethe, "Die Metamorphose der Pflanzen." Gaudichaud, *Mem. de l'Acad. d. Sci.*, 1841. Kienitz Gerloff, *Bot. Zeit.*, 1875, p. 55. Celakovsky, "Unters. ueber die Homologien," *Pringsh. Jahrb.*, xiv., p. 321, 1884; *Bot. Zeit.*, 1901, Heft. v., VI.

whole shoot regarded as being mainly composed of leaves, but some even contend that the axis has no real existence as a part distinct from the leaf bases.¹

This view in its general form represented the leafy plant as constructed on a plan somewhat similar to that of a complex zoophyte. It has more recently culminated in the writings of Celakovsky and Delpino. The former in his theory of shoot-segments ("Sprossgliedlehre") starts from the position that the plant is composed of morphological individuals; the cell, the shoot, and the plant-stock are recognised as such. The stock is composed of shoots and the shoot of cells. Braun recognised the shoot as the individual *par excellence*: between the cell and the shoot is a great gulf, which has not yet been filled; "between the cell and the bud (shoot) there must be intermediate steps, the limitation of which no one has succeeded in defining"; the long sought-for individual middle step is the shoot-segment (Spross-glied), which is neither leaf only nor stem-segment only, but the leaf together with its stem-segment. Now this reasoning appears to involve a mistaken method of morphology; the intermediate step *must* occur; we will, therefore, discover and define it. The definition of it consists in the drawing of certain transverse and longitudinal lines partitioning the shoot, lines which in the sporophyte have no existence in nature; the assumed necessity of partitioning the shoot into parts of an intermediate category between the whole shoot and the cell brings these assumed limits into existence.

Notwithstanding the ingenuity of the theory as put forward by Celakovsky, in the absence of any structural indication of the limits of the shoot-segments in the vast majority of cases the theory does not appear to be sufficiently upheld by the facts.

An extreme, and indeed a paradoxical position has been taken on this phytomic question by Delpino. As a consequence of his studies on phyllotaxis he concluded that the axis is simply composed of the fusion of the leaf-bases; that the leaves are not appendicular organs, but central organs; that an axis or stem-system does not exist, and accordingly that the higher plants are not cormophytes at all, but phyllophytes.

The second view, that the axis and leaf are the result of differentiation of an indifferent branch-system, of which the limbs were originally all alike, has lately been brought into prominence by Potonié.² Taking his initiative from the branching of the leaves in early fossil Ferns, he recognises the frequent occurrence of overtopping ("Uebergipfelung"), that is, the gradual process of assertion of certain limbs of a branch-system over others; in the branching of Fucoids he finds an analogy for his observations on Fern-leaves, and draws the following conclusion, that "the leaves of the

¹ Delpino, "Teoria generale della Filotassi." For ref. see *Bot. Jahresbr.*, viii., 1880, p. 118; also vol. xi., 1883, p. 550.

² *Lehrbuch d. Pflanzenpalaontologie*, pp. 156-159. Also *Ein Blick in die Geschichte d. Bot. Morph. und d. Pericaulontheorie*, 1903, p. 33, etc. It was, however, suggested previously by myself, *Phil. Trans.*, 1884, part ii., p. 605.

higher plants have been derived in the course of generations from parts of an Algal thallus like that of *Fucus*, or at least from Alga-like plants, by means of the overtopping of dichotomous branches, and the development as leaves of the branches, which thus become lateral." Dr. Hallier, who adopts Potonié's position, prefers to draw the comparison with Liverworts, which show a similar sympodial development of a dichotomous branch-system.¹

It seems not improbable that the condition of many branched Fern-leaves may have been derived through a process of "overtopping" in an indifferent branch-system of the leaf itself. But it lies with Potonié to show, on a basis of comparison of forms more nearly related to them than the Fucoids, that the relation of axis to leaf in the Ferns was so derived; and, further, that such an origin is in any way applicable to other foliar developments in Vascular Plants, especially in Pteridophytes such as the Lycopods, Equiseta and Sphenophylls. I am not aware that this has yet been done. But granting that this can be done, the question still remains whether similarity of method of branching is any criterion of comparison as to descent. For sympodial development of a dichotomous system (and this is all that such "overtopping" actually is) has occurred in cases where it cannot be held to have resulted in a branching which is foliar; and of this instances can be found without going so far afield as the Fucaceae. If this be so, then little value need be attached to the comparison of such branchings in plants not nearly allied to one another; these may be held to be quite distinct examples of a general phenomenon of branch-development, without the one being in any sense the prototype of the other. Such reflections as these indicate that the comparison in mode of branching between the leaves of Ferns and the thallus of Fucoids, which forms the groundwork of the view of Potonié (or between the Ferns and the Thalloid Liverworts, as may be preferred by others), are not to be held as more than distant analogies; consequently they are no demonstration of the origin of the leaf by a process of "overtopping."

The view recently advanced by Professor Lignier ("Equisétales et Sphénophyllales: leur origine filicinéenne commune," *Bull. Soc. Linn. de Normandie*, Caen, 1904, p. 93) is analogous to that of Potonié, though differing from it in detail. It involves ranking the Lycopod leaf as a "phylloid," of the nature of a flattened hair, and comparable to the amphigastrium of a Liverwort. The leaf of the Fern, however, is held to be a true leaf, or phyllome, derived by differentiation from an indifferent system of "cauloids," on which the "phylloids" have become abortive. All such hypotheses have critical points in their application: in the present case it lies in the comparison of the Psilotaceae and Sphenophylleae. For Lignier regards the leaf-lobes of *Tmesipteris* as only "phylloids," whereas the leaves of the Sphenophylls, and also of the Equisetales, are "phyllomes," reduced from the larger-leaved type of the Ferns. The argument is chiefly

¹ *Beitrag z. Morph. d. Sporophylle u. d. Trophophylls*, Hamburg, 1902.

based on comparisons as to branching and anatomical structure. These grounds will not suffice to override the inherent probability that the leaves of the Lycopods and Psilotaceae are essentially of the same nature as those of the Sphenophylls or Equiseta, and not the consequence of an entirely distinct evolutionary history. Moreover, on his own admission the "Prohepatic" type, from which Professor Lignier's theory starts, is still wholly hypothetical. Further, it may be remarked that the embryology of the sporophyte gives no assistance to those who would derive it from a dorsiventral thallus. On these as well as other grounds the theory, as stated by Professor Lignier, cannot be upheld.

An essentially similar hypothesis has been enunciated by Tansley (*New Phytologist*, 1907, p. 25, etc.). He contemplates a megaphyllous origin of a Fern-like sporophyte from a "hypothetical Archegoniate Alga," which showed dichotomous branching: certain branch-systems became specialised for assimilatory functions as erect shoots, and assumed radial symmetry, while the axis originated by transition through sympodial development of the dichotomy to monopodial branching. On this hypothesis the dorsiventral symmetry would be the primitive and the radial the derivative state in the original sporophyte. The megaphyllous types would be primitive and from these the microphyllous would be derived by widespread reduction.

Putting aside the collateral speculations of Tansley to which exception may be taken, such as the homoplastic origin of the archegonia and of the spores, as well as of the whole sporophyte in Bryophytes and Pteridophytes, and the wholesale resort to reduction in order to explain the origin of the ancient microphyllous phyla, there are two points of fact, or of absence of fact, which appear specially to oppose his theory: he assumes a radial type of construction to be derivative for the sporophyte and a dorsiventral type to be primitive: but in point of fact, in their individual development all sporophytes are originally radial, a condition which has probably a very close relation to their production in the archegonium: that the dorsiventral state is as a general rule derivative in the sporophyte, may be concluded from comparison and shown by experiment (see Chapter XVI.). Further, there is no known case of dichotomy in the sporophyte, where one branch develops as axis and the other as leaf. The known facts derived from living Ferns as well as from the fossils point clearly to dichotomous branching of the axis itself and of the leaf itself, and to transition from a dichotomous to a monopodial branching in the establishment of rachis and pinna. But such evidence is wanting in the relations of leaf and axis. It was chiefly the absence of such evidence that influenced me in rejecting my own suggestion of origin of the shoot from a dichotomous branch-system made in 1884 (*Phil. Trans.*, vol. ii., 1884, p. 605): it applies equally to the theory as stated by Tansley, which appears thus to break down on the test of fact.

There remains the third view, which, however, is no new one; for there have not been wanting those who have assigned a more prominent

place to the axis in the initial differentiation of the shoot. Perhaps the most explicit statement on this point is that by Alexander Braun, who remarks in his *Rejuvenescence in Nature* (English edition, p. 107), referring to phytonic theories, that "all these attempts to compose the plant of leaves are wrecked upon the fact of the existence of the stem as an original, independent and connected structure, the more or less distinct articulation of which certainly depends upon the leaf-formation, but the first formation of which precedes that of the leaves." Unger also, in his botanical letters to a friend (No. VIII.), described how "The first endeavour is directed towards the building up with cell-elements of an axis"—"those variously formed supplementary organs which are termed leaves originate laterally upon it" and he concludes that "we may [therefore] say with perfect justice that the plant . . . is, as regards form, essentially a system of axes." Naegeli contemplated a somewhat similar origin of the leafy shoot as an alternative possibility; in fact, that the apex of a sporogonium-like body elongated directly into that of the leafy stem, in which case the axis would be the persistent and prominent part, and the leaves be from the first subsidiary, and lateral appendages. In my theory of the strobilus in Archegoniate Plants the central idea was somewhat similar to this.¹ It may be briefly stated thus: There seems good reason to hold that a body of radial construction, having distinction of apex and base, and localised apical growth as its leading characters, existed prior to the development of lateral appendages in the sporophyte; the prior existence of the axis and lateral origin of the appendages upon it are general for normal leafy shoots. The view thus put forward is, indeed, the mere reading of the story of the evolution of leaves in terms of their normal individual development.

It is natural to look to the Pteridophytes for guidance as to the origin of foliar development in the sporophyte, for they are undoubtedly the most primitive plants with leafy shoots. They may be disposed according to the prevalent size of their leaves in a series, leading from microphyllous to megaphyllous types. I have lately shown that such a seriation is not according to one feature only, but that certain other characters which have been summarised as "Filicineous" tend to follow with the increasing prominence of the leaf.² This indicates that such seriation is a natural arrangement. Now it is possible to hold either that the large-leaved Fern-like plants were the more primitive, and the smaller-leaved, derivatives from them by reduction; or, conversely, that the smaller-leaved were the more primitive, and the larger-leaved derivatives from them by leaf-enlargement; other alternative opinions are also possible, such as that the leaf-origin has been divergent from some middle type, or that the leaves of Vascular Plants may have been of polyphyletic origin. For the moment we shall leave these latter alternatives aside.

Much of the difference of view as to foliar origin centres round the

¹ *Annals of Botany*, vol. viii., p. 343.

² *Studies*, v., p. 254.

question whether originally the leaf was relatively large or small. Those who hold that the large-leaved forms were the more primitive will be naturally disposed towards the view of the original preponderance of the leaf over the axis, and will favour some phytonic theory; those who hold the smaller-leaved forms to be the more primitive will probably adopt a strobiloid theory of origin of the leafy sporophyte. I propose to offer some remarks on the relative probability of these alternative views.

If large-leaved prototypes be assumed generally for Vascular Plants, this naturally involves a widespread reduction, since small-leaved forms are numerous now, and have been from the earliest times of which we have any record. Convincing evidence of reduction of leaf-complexity in an evolutionary sequence, supported on grounds of comparison of form and structure, and in accordance with the palaeontological facts, has been adduced in the progression from Ferns, through Cycado-Filicean forms to the Cycads; and it applies with special force in the case of their sporophylls. Ferns, which are essentially shade-loving and typically zoidiogamic, or amphibious, may be understood to have given rise to the Cycado-Filices and Cycads, which are more xerophytic, and show that essential character of land plants—the seed-habit. The case for reduction of leaf-complexity seems to be here fully made out, and somewhat similar arguments will also apply for other types of Gymnosperms. It must therefore be admitted that extensive reduction of appendages has occurred in certain very ancient phyla.

But while we thus recognise a probability of reduction in certain phyla producing relatively smaller-leaved forms, it does not follow that *all* small-leaved Vascular Plants originated thus. On this point the anatomical evidence is of importance, as bearing on the origin of the small-leaved strobiloid Pteridophytes. Of these (putting aside the Hydropterids as being a special reduction problem in themselves) there remain the Lycopodiales, the Equisetales, and the Sphenophyllales, which are all cladosisiphonic in the terminology of Dr. Jeffrey. The question will largely turn upon the meaning of this anatomical feature. The cladosisiphonic character may be held as the anatomical expression of the dominance of the axis in the shoot. Here the leaf-trace is merely an external appendage on the stele, which is hardly disturbed by its insertion. This type is seen constantly in certain small-leaved Pteridophytes. On the other hand, the condition, styled by Dr. Jeffrey the phyllosiphonic, is the anatomical expression of the dominance of the leaf over the axis in the shoot. Here the insertion of the vascular supply of the leaf profoundly disturbs the vascular arrangement in the axis, leading to an open communication between the cortex and the central medulla at each leaf-insertion. It is characteristic of certain large-leaved Pteridophytes, and is seen also generally in Seed-Plants. There is thus a probability, supported on anatomical evidence, that the seed-bearing plants at large were descended from a large-leaved ancestry, and had undergone reduction of leaf-complexity in their descent.

It is a fact of importance that, in the individual life, the one or the other anatomical type is usually constant: but in certain Ferns the progression may be traced from the cladosiphonic in the young plant to the phyllosiphonic in the mature, thus suggesting a similar progression in descent, viz. that the large-leaved phyllosiphonic Ferns were derived from a smaller-leaved cladosiphonic stock. Of the converse, viz. the progression from the phyllosiphonic to the cladosiphonic state in the individual life, I know of no example among the Pteridophytes, though it is true that there is some approach to it in the Marsiliaceae. Thus the anatomical evidence indicates a probability that, even in large-leaved Ferns, the cladosiphonic was the primitive type; but that the phyllosiphonic, once initiated, is as a rule maintained: this is shown by its persistence in the Seed-Plants, even where the leaf has been reduced in size.

Having thus gained a valuable sidelight from anatomy, indicating that small-leaved types were probably primitive, we may now return to our central question of the initial relation of leaf to axis. Of the three theories already noted, the theory of overtopping as applied to the origin of the leaf may, in my opinion, be dismissed, as it is not based upon comparison of nearly related forms, while the facts of embryogeny and of leaf-origin do not support it: and further, the sympodial development of a dichotomous system, on which it is founded, is a general phenomenon of branching, restricted neither to leaves nor to the sporophyte generation. As to the other two, the facts, whether of external form or of internal structure, seem to me to indicate this conclusion: that the strobiloid condition, was primitive for certain types, such as the Equisetales, Lycopodiales, and Sphenophyllales; that in them the leaf was from the first a minor appendage upon the dominating axis, and anatomically they have never broken away from the cladosiphonic structure which is the internal expression of their microphyllous, strobiloid state. That the Filicales and also the Ophioglossales were probably derived from a microphyllous strobiloid ancestry, and achieved the phyllosiphonic structure as a consequence of leaf-enlargement, this being the derivative rather than the primitive condition; its derivation is even illustrated in the individual life of some Ferns. From the Filicales the phyllosiphonic structure was probably handed on to the Seed-Plants, and by them retained notwithstanding the subsequent leaf-reduction which followed on their adaptation to an exposed land-habitat. Thus a strobiloid origin may be attributed to all the main types of Vascular Plants. It seems to harmonise more readily with the facts than any phytonic theory does.

A prototype, which was probably a prevalent, though perhaps not a general one for the Pteridophytes, may then be sketched as an upright, radial, strobiloid structure, consisting of a predominant axis, showing continued apical growth, and bearing relatively small and simple appendages. On our theory the origin of these appendages in descent would be the same as it is to-day in the individual development, viz. by the outgrowth

or enation¹ of regions of the superficial tissue of the axis to form them, and this would occur not simultaneously but successively, the origin of the appendages following the continued apical growth of the axis, as it does in the developing shoot of the present day. The axis would pre-exist in descent, as it actually does in the normal developing shoot. The origin of these appendages may have occurred independently along divers lines of descent, and the appendages would in that case be not homogenetic in the strict sense. Thus there would be no common prototype of the leaf, no morphological abstraction or archetypic form of that part. More than one category of appendages might even be produced on the same individual shoot, differing in their function on their first appearance. Such has perhaps been the case in the Calamarian strobilus, where, as will be seen later, the leaf-tooth cannot be readily homologised with the sporangiophore. These suggestions will suffice to indicate how elastic a strobiloid theory is, and how its application will cover various types of construction, even such as are shown by the most complex cones of Pteridophytes.

The objection to a theory of enation will probably be raised that it contemplates an origin of new parts rather than a modification of parts already present, and that experience indicates the latter as the usual source. The reply to this is a double one: first, that the appendages actually appear in the ontogeny by enation: a leaf arises as an outgrowth from the previously smooth surface of the pre-existent axis: the theory reads the descent in terms of the individual life. But secondly, an origin of new parts upon a smooth surface of a pre-existent part must necessarily have taken place frequently in the formation in isolated genera of emergences and prickles, often of large size and with vascular supply. Thus the origin of new appendages is not without frequently recurring precedent among Vascular Plants.

An essential feature in the theory of the strobilus is that it involves the phyletic pre-existence of the axis. This is a point upon which embryological evidence can be adduced, both that of the primary embryology and of the continued embryology of the growing shoot (see Chapter XIV.).

Thus far nothing has been said of the sporangia in relation to this theory of the strobilus. It remains to trace the relation of these to the appendages. On the above hypothesis the shoot originated from a body having a fertile upper region and a sterile base. It is not necessary to fix upon any type of sporophyte represented in any living plant as a prototype: what is contemplated is an acropetally growing body, with already some distinction of a sterile base, and a terminal fertile region endowed with apical growth. In two or more types of living Bryophytes the relegation of spore-production towards the outer surface is seen, with the formation of a

¹The term "enation" has long been used in Vegetable Teratology. See Masters, "Vegetable Teratology," *Key. Ser.*, 1869, p. 443: it connotes the exogenous outgrowth of an appendage from a previously vacant surface.

sterile central columella: such was probably the case also in the predecessors of the strobilus, but the process was more completely carried out, so that the spore-formation came to be, as it now is in all Pteridophytes, located close to the outer surface. A further step would be the disintegration of the sporogenous tissue into separate pockets or sporangia: of such disintegration there is evidence in certain Pteridophytes, but it is exemplified in the clearest way in the anthers of various Angiosperms: the condition which is actually seen in the anthers of *Viscum album*, or in the large multilocular anthers of *Rhizophora* illustrates the point (Fig. 72): here

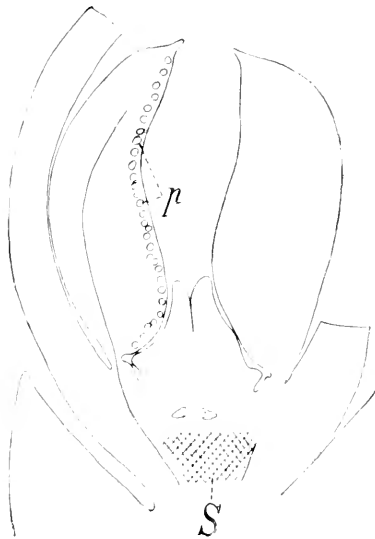

FIG. 72.

Rhizophora mucronata. Flower in longitudinal section. Numerous spherical microsporangia, *p*, in the anther. (After Goebel.)

the numerous, small, isolated loculi cover the very considerable surface of the enlarged stamen, and development as well as comparison points to an origin of these by segregation from the normal type of pollen-sacs. The outgrowth of appendages by enation, from such an apically growing structure has been already recognised as a probable feature; if this took place either between the segregated loculi or below them so as to carry them outwards beyond the general surface, during its acropetal development, the result would then be a strobiloid structure with an acropetal succession of appendages, such as is seen in various Pteridophytes. Sometimes the sporangia might be borne in close relation to the axis, as in *Lycopodium* or *Selaginella*, while other Lycopods illustrate varying degrees of the carrying

of the sporangia outwards upon the appendage. In other cases varying numbers of sporangia are borne upon a single appendage, as in the Calamarians and Sphenophylls: and according to their form, and their relation to or freedom from sporangia, divers ranks of these appendages may be distinguished: these matters will be discussed in detail later.

In the hypothesis thus sketched there are several steps which may be named as distinct, though actually they may have overlapped: they are (1) the differentiation in the primitive sporophyte of a vegetative base, and a fertile upper region having a power of apical growth: (2) the relegation of sporogenous cells in the latter to a superficial position: (3) the segregation of them into separate pockets or sporangia: (4) the enation of the appendages. Every one of these steps has its actual prototype among living plants, so that nothing is advanced which is contrary to

morphological experience. Therefore the validity of the strobiloid theory is not open to *à priori* objection. The real question is whether those processes which are seen to have been in operation elsewhere did actually take part in the production of the Pteridophyte strobilus as it is now seen? The applicability of the theory to the various known types of Pteridophytes will be the true test of its validity. This will be carried out in detail in the second part of this work, so far as the very imperfect evidence will allow. In questions such as this of the origin of the shoot, it is desirable to take the simplest possible reading of the facts as the basis of an opinion: on this ground the theory of enation, as accounting for the origin of the appendages of the strobilus, seems to be preferable to any phytonic theory. It has been remarked that the strobiloid theory involves "tremendous morphological assumptions in the way of the origin of new organs" (Tansley, *New Phytologist*, 1907, p. 28, etc.): the only assumption, however, which is apparent to the mind of its author, is that the order and mode of origin of the appendicular parts in the course of Descent has been that which is actually seen in their individual development. They are formed by enation from the axis now, and it is held that they originated in the first instance in the same way.

CHAPTER XII.

SPORANGIOPHORES AND SPOROPHYLLS.

THE theoretical position taken up in the last chapter is characterised not only by its simplicity but also by its elasticity. It carries with it no obligation to assume that all the appendicular organs should show definiteness or constancy in their disposition upon the axis which bears them, nor even that they were all alike in their initial character or function. Now, as a

matter of fact, an examination of the strobili of such plants as the Psilotaceae, Horsetails, and Calamarians shows that irregularities of arrangement of the parts are common: it is impossible to reduce the arrangement of the appendages in the cone of *Tmesipteris* or of *Equisetum maximum* to any regular scheme (Fig. 73): the appendages of both vary in radial angle and in level of insertion. There is also great variability in the disposition of the leaves in the genus *Lycopodium*, being sometimes whorled, sometimes irregularly spiral. It is true that cases do exist among the strobiloid Pteridophytes which show regularity in the disposition of their parts, but in their shoots at large a regular disposition of the appendages cannot

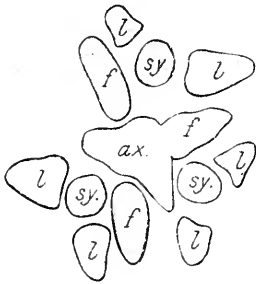

FIG. 73.

Transverse section through a sporangiferous bud of *Tmesipteris*. ax = axis. f = foliage leaves. l = lateral lobes. sy = syngonia. $\times 20$.

be held to be a general feature. Such irregularities, so far as they are of primary origin, are difficult to explain on the basis of any sympodial construction of the strobilus: to a theory of enation, as expounded in the previous chapter, they offer no obstacle: for if the appendages originated from the surface of the pre-existent axis, as suggested, they might equally well appear in regular positions, or be disposed with greater or less irregularity—as, indeed, is seen to be the case.

The comparative classification of those appendages of the strobilus which are seen in the different types of Pteridophytes has always presented

difficulties: of this the Psilotaceae are a conspicuous example, and the analysis of the parts composing their strobili has led to voluminous discussions. The difficulties are no less in the Sphenophylls and Calamarians. The presumption upon which morphologists have habitually proceeded has been that all the parts are, or at least should be, reducible to certain categories, such as axis, leaf, emergence, sporangium—these being the headings under which the parts of the shoot in the higher Vascular Plants are ranged. It is possible by the use of artifices, which sometimes appear to be curiously strained, to carry out the classification of all the constituent parts of the shoot in Phanerogams into these categories. But is the morphologist justified by this measure of success in the practice of a somewhat artificial method in assuming that it shall always be equally applicable to all Vascular Plants? And further, is it a scientific method forcibly to extend the conclusions obtained from the study of the higher forms to the lower? The attitude of the believer in evolution should be the converse: to examine the lower types with a mind untrammelled by conceptions derived from the higher, and a terminology free to express what is actually seen in the more archaic forms. Subsequently his conclusions may be extended to the higher forms. At the present day it will seem hardly necessary to put down such simple principles as these explicitly; but doing so finds its justification in the habit of thought, still ingrained in the science, of reading the lower Vascular Plants in terms of the higher, just as it was done in the pre-Darwinian days. From this the mind of the modern morphologist must be entirely free.

The difficulty of reducing the parts of the strobilus in certain Pteridophytes to the categories above named has already extorted from morphologists the adoption of a further term not yet used in reference to Flowering Plants. The non-committing word "sporangiophore" is now understood to connote a structure which bears sporangia, but is not readily referable to the category either of axis or leaf, though it might be included under some broad use of the term "emergence." It may contain vascular tissue, and be inserted either on the axis or on an appendage. It will be the object of this chapter to consider the relations of the sporangia, the sporangiophores, and the sporophylls to one another, and to the axis of the whole strobilus, as seen in the various types of Pteridophytes.

It is a rare thing for sporangia to be borne directly upon the axis itself, though there is theoretically no reason against it, but rather the reverse. The Lycopodiales include forms which show this position of the sporangia, and *Selaginella* is usually quoted as a case in point (Fig. 74). It is true that here the sporangium is inserted on the axis, and springs directly from its tissue: it may originate as a swelling quite distinct from that which develops into the sporophyll; but the sporangia are not scattered irregularly on the axis, for there is a constant relation of each sporangium to the subtending appendage: the sporangium and the sporophyll are in

the same median plane, and, excepting rare abnormalities, each sporophyll subtends only one sporangium: this is seen in all plants belonging to the Lycopodiales. But they illustrate various degrees of remoteness of the sporangium from the axis, while still retaining the strict numerical and subtending relation. Thus *Selaginella* shows the closest relation of the sporangium to the axis: but the sporangium of *Lycopodium* originates clearly from the tissue of the sporophyll itself (Fig. 75): in some of them (*L. Selago*) the sporangium may at maturity appear to be thin-stalked and axillary, while in others (*L. clavatum*, *Lepidostrobos*, and *Isoetes*) the sporangium may extend with a broader base some considerable distance along the upper surface of the sporophyll. An extreme condition is that



FIG. 74.

Selaginella Martensii, Spring. Radial section of a strobilus, including apex (*af*), and traversing a young sporophyll (*l*), and sporangium (*r*). Also another section of sporophyll and sporangium, rather older. $\times 365$.



FIG. 75.

Radial sections through young sporangia of *Lycopodium Selago*. In the youngest the whole sporophyll is shown (*l*), and the axis (*st*), and it is seen that the sporangium arises upon the surface of the sporophyll. $\times 200$.

of the early fossil *Spencerites* (Fig. 76), in which the narrow-stalked sporangium is attached some distance from the base of the sporophyll. It is thus seen that while the numerical and radial relations of sporangium and sporophyll are constant, the distance of the sporangium from the axis may vary. This arrangement in the Lycopods, which dates back to the earliest fossil records, is certainly the simplest seen in the cones of Pteridophytes, and the relation of the sporangium to the axis is habitually closer in them than in any other type.

But other plants, which also have representatives of palaeozoic age, bear cones of more complex construction: these present intricate morphological problems if the effort is made to classify their parts according to the strict categories and the usual successions of axis, leaf, emergence, and sporangium; for instance, the modern Psilotaceae and the ancient

Sphenophyllaceae raise important questions. Among the former, *Tmesipteris* bears appendages of simple form in the vegetative region; but the fertile appendages are forked at their distal end, and bear on their upper surface, just at the point of branching, a bilocular synangium, which has a short stalk traversed by a vascular strand (Fig. 77). Various views have been propounded in order to read this body in terms of the formal morphology of the higher plants: for us, the suggestion would seem to suffice that

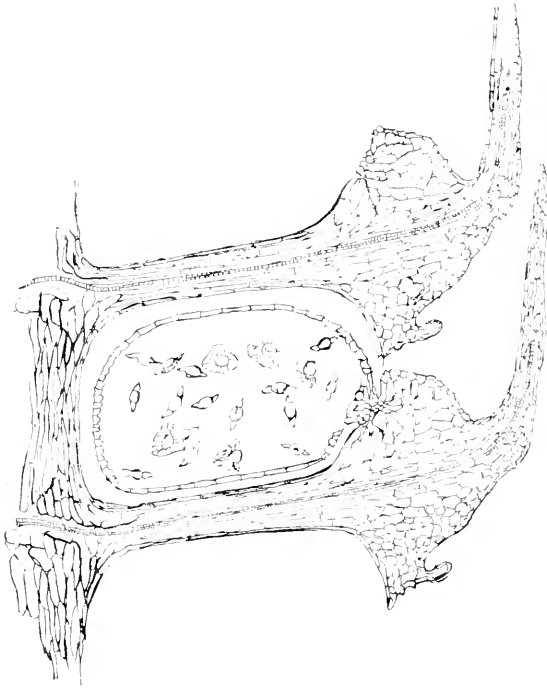

FIG. 76.

Spencerites insignis. Somewhat diagrammatic radial section of part of the cone, showing two sporophylls in connection with the axis. On the lower sporophyll the sporangium is shown attached at its distal end to the ventral outgrowth of the sporophyll: within the sporangium some of the characteristic winged spores are shown. (After Miss Berridge.) From Scott, *Progressus rei Botanicae*, vol. i.

the plant is heterophyllous, the vegetative appendages being simple and the fertile branched: while to the upper surface of the branched sporophyll a sporangiophore is attached with vascular supply and bearing two sporangia. In *Psilotum* the structure is the same, but the number of the sporangia is larger. The disposition of the parts in *Sphenophyllum majus* is again very similar to this (Fig. 78): a synangial group of four to six sporangia occupies a position comparable to that of the Psilotaceae on the upper surface of a doubly branched appendage: but these appendages are disposed

in regular whorls, instead of irregularly as in *Tmesipteris*. In other Sphenophylls the number of sporangia may be less, and the number of the more



FIG. 77.

Tmesipteris tannensis, Bernh. A, habit of a whole plant, pendulous form, showing dichotomy. Natural size. B-E, sporophyll and synangium; B from the side, C from above, D after dehiscence, E from below, all about $\frac{3}{4}$. F = rhizome. $\frac{1}{2}$ size. G = transverse section of stem. $\frac{1}{4}$. (After Engler and Prantl.)

elongated stalks or sporangiophores, greater: thus in *S. Dawsoni* they are twice, in *S. Römeri* three times as numerous as the segments of the

vertical: these variations in number of the sporangiophores would be difficult to harmonise with any reference to "leaf-segments," as ordinarily understood elsewhere: and their disposition suggests the idea of chorisis of the sporangiophore similar to that seen frequently in the stamens of Angiospermic flowers.



FIG. 73.

Forked sporophyll of *Sphenophyllum majus*, bearing sporangiophore. (After Kidston.)

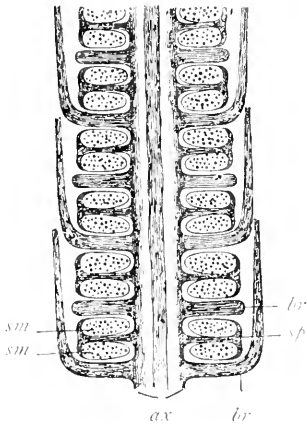

FIG. 76.

Calamostachys. Diagram of cone in radial section. *ax*=axis, which bears successive verticils of bracts (*br*) and peltate sporangiophores (*sp*). *sm*=sporangia borne on the sporangiophores. As the bracts are alternate with one another their upturned tips are only shown in every alternate verticil. (After Scott.)

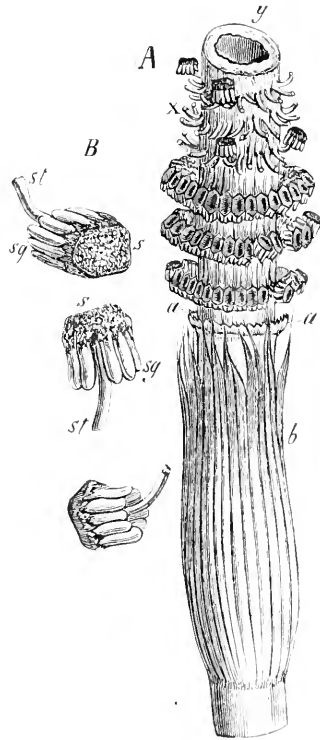

FIG. 79.

Equisetum maximum, Link. *A*, the upper part of a fertile axis, with the lower half of the strobilus. Natural size. *b*=the leaf-sheath. *a*=annulus. *x*=stalks of sporangiophores cut off. *y*=transverse section of axis. *B*=sporangiophores in various positions, slightly enlarged. *st*=stalk. *sg*=sporangia. *x*=enlarged distal end. (After Sachs.)

In the Equiseta and Calamarians, spore-bearing bodies of outline not unlike those of Psilotaceae are attached directly to the axis itself, and bear the pendent sporangia (Fig. 79). They show sometimes almost constant, but frequently inconstant, numerical and local relation to the whorls of

bracts or leaf-teeth: thus, in the modern *Equisetum* and in the ancient *Bornia* they occupy the whole strobilus in large numbers, and bracts are absent: in *Phyllothea* the fertile spikes are interrupted by occasional whorls of vegetative leaves: in *Calamostachys* the strobilus bears successive whorls of bracts, and whorls of sporangiophores alternate with them; but even here they do not show exact numerical correspondence with the bracts, which, moreover, alternate independently of them. Further, their longitudinal

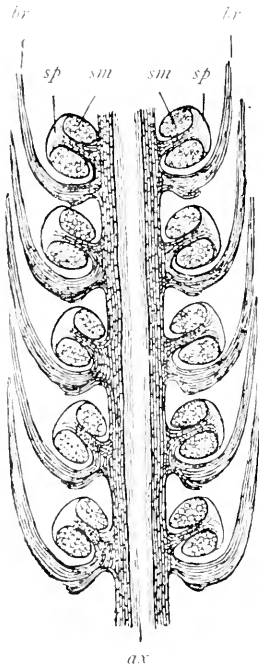

FIG. 81.

Palaeostachya. Diagram of cone in radial section. *ax* = axis, which bears verticils of bracts (*br*) with peltate sporangiophores (*sp*) in their axils. *sm* = sporangia. (After Renault.) From Scott.

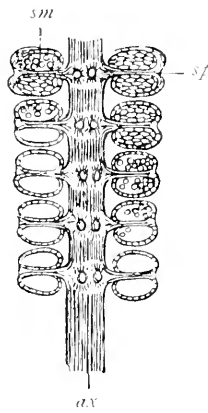

FIG. 82.

Archaeocalamites. Part of cone showing the axis (*ax*) in surface view, bearing superposed verticils of peltate sporangiophores (*sp*) without bracts. *sm* = sporangia. (After Renault.) From Scott.

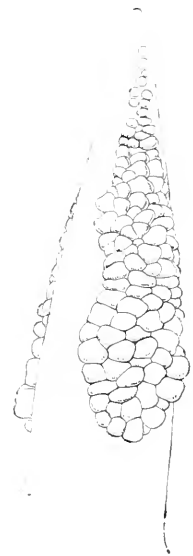

FIG. 83.

Helminthostachys zeylanica. Young spike in oblique profile: the primordia of sporangiophores are densely clustered on the margin. Magnified. (After Goebel.)

position relatively to the bracts varies, for in *Calamostachys* they are placed midway between the whorl of bracts, in *Palaeostachya* in their axils, in *Cingularia* immediately below them. This indefiniteness of relation of the spore-bearing bodies to the bract-leaves in number and position, as seen among the Equisetales, when taken together with the difference of function, points to their being a separate category of members from them (Figs. 80, 81, 82).¹

¹This statement is not in accord with the opinions expressed by Prof. Lignier, which will be considered where the Equisetales are specially treated in Part II.

In the Ophioglossales the structure of the shoot at large is open to various interpretations; but without entering here into questions which will be taken up in detail later it will suffice to mention that in *Helminthostachys* there are sporangiophores which are broadly similar in outline to those of *Equisetum*, but they are borne in irregularly disposed bands on the lateral margins of the fertile spike (Fig. 83).

It may at first sight seem difficult to bring the very varied disposition of the sporangia upon the enlarged sporophyll in modern Ferns into line with these examples of spore-bearing bodies in smaller-leaved types. But it is to be remembered that in Palaeozoic Ferns definite sori were common; they were as a rule of circular form, and all their sporangia were produced simultaneously. The wide-extended sori, such as are frequently found among the Polypodiaceae, were probably of relatively late and secondary origin, by extension of the sori of the circumscribed type. Now, a circular sorus, with relatively few sporangia formed simultaneously and borne upon a more or less projecting receptacle, into which, as may often be seen, a vascular supply extends, differs in no essential from such bodies as we have been considering. A sorus of this simple type is seen, for instance, in *Kaulfussia*, which is closely similar to that of the Palaeozoic Fern, *Ptychocarpus unitus* (Fig. 84). It has been seen that spore-bearing bodies may be borne directly on the axis or on the appendages; the latter is the case in the Ferns, the chief difference between them and the strobiloid forms being that the appendages here are large and the sori, or sporangiophores, very numerous. Regarded in this light, the Fern-type is not a thing distinct or apart; the difference from other types is mainly one of the degree of development of the sporophyll which bears the sori.

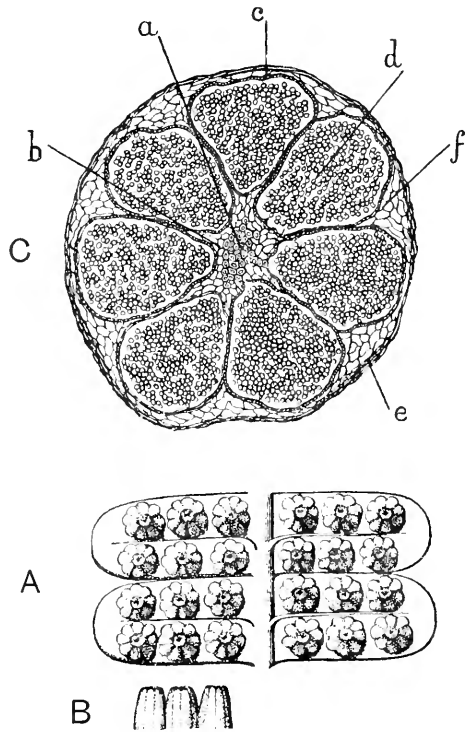

FIG. 84.

Ptychocarpus unitus. Fructification. *A*, part of a fertile pinnaule (lower surface), showing numerous synangia. *B*, synangia in side view. (*A* and *B* \times about 6.) (After Grand'Eury.) *C*, a synangium in section parallel to the surface of the leaf, showing seven confluent sporangia. *a*, bundle of receptacle; *b*, its parenchyma; *c*, tapetum; *d*, spores; *e*, *f*, common envelope of synangium. \times about 60. (After Renault.) From Scott's *Studies in Fossil Botany*.

Spore-bearing bodies, or sporangiophores, or sori such as those above named, have then the following characters in common: They are outgrowths of varying length, which bear one or more sporangia: these are, when numerous, more or less closely related one to another, and frequently synangial: they are usually disposed in a circle round the periphery of a disc-like expansion at the distal end of the more or less elongated stalk, but other arrangements may be found. A vascular strand usually runs through the stalk to its distal end, where it may divide into branches which terminate in close relation with the sporangia. The similarity in all essentials of structure of the sporangiophores in these early Pteridophytes, notwithstanding the diversity of their position, points to the conclusion that they are the result of similar response to similar requirements, carried out, it may be, in various distinct stocks in the various positions in which they are now seen. Their structure suggests that they are simply the outcome of placental growth, which has the advantage of securing freedom of dehiscence of the sporangia which they bear. In that case there is no obligation to hold that they were the result of "metamorphosis" of any pre-existent appendage or part. And herein lies the importance of the introduction of the term *sporangiophore* which is now applied to them: for it simply implies the fact that the part so called bears sporangia, but does not suggest any view of its further morphological character, nor does it impose any limitation upon the position which the sporangiophores may hold.

It remains to consider what relation, if any, subsists between such sporangiophores and the "leaves." The difficulty in finding mutual ground for discussion of this question lies in the preconceived ideas which the term "leaf" carries with it in the minds of many botanists. It is often assumed that the vegetative leaf was pre-existent in descent to the appendages of the strobilus, the mind naturally translating the successive events of the individual life directly into the history of its evolutionary organisation; in fact, the sporophyll has habitually been regarded as a vegetative leaf which has become fertile. In the following chapter reasons will be given for holding that the converse is nearer the truth, *i.e.* that foliage leaves are often the equivalent of sporophylls which have become in the course of descent sterile. If this be so, then signs of the origination of a vegetative system are to be sought in the fertile zone rather than the converse.

A second preconception which is commonly entertained is that "the leaf," whether sporophyll or foliage leaf, is a part having a common evolutionary origin in all plants in which it appears; but on grounds explained above we shall be prepared to contemplate as possible a polyphyletic origin of those parts which are designated collectively "leaves."

A third preconception, which is a common one also, is that those bodies which are designated sporangiophores are necessarily of the nature of sporophylls, or of segments or parts of sporophylls. Any sporangiophore

attached to an axis would thus be held to be a complete foliar structure, and a sporangiophore attached to the upper surface of a bract would be recognised as a "ventral lobe" of that bract. But if it be admitted that spore-production in the sporophyte was prior to its vegetative development, and was a constant phase throughout the evolution of the sporophyte, then such a description seems not only unnecessary but highly improbable. Moreover, it has been seen that sporangiophores may be present in positions which are not those of the normal succession of known vegetative parts: in the endeavour to bring these into line with the customary position and succession of vegetative parts, recourse has to be taken to almost fantastic explanations. But there is no need for this if the sporangiophore be accepted simply to be, what it structurally is, a placental growth. The object of the morphologist should be not the forcible reduction of different organisms to one scheme of construction, but to read in their diverse forms the probably diverse story of their origin. This should proceed along the lines of the least strained and simplest interpretation. Following these principles, the sporangiophore in the Pteridophytes will be held to be a part *sui generis*, itself primitive in its nature, in the sense that it is not the result of modification or replacement of any other sort of appendage.

Certain physiological limitations must necessarily have been operative during the transition of the fertile region of any sporophyte from a simpler to a more complex condition, such as has been figured to the mind in the last chapter. As already pointed out, an increase in spore-production is an advantage in homosporous plants, since it increases the chance of survival and of distribution. But in any increasing body the formation of separate loculi will facilitate the protection and nutrition of the increasing mass of spores while young: thus segregation has its biological rationale. Projection of the sporangia beyond the surface of the part which produces them will facilitate the shedding of the spores, and makes possible those mechanical devices which are seen in so many of the Pteridophytes. For the protection of the sporangia while young, close juxtaposition of the appendages of the strobilus is also important, and illustration of this is seen in almost all strobiloid types. But at the same time any projection of the spore-producing parts necessitates the conveyance of their nourishment through a longer distance, and by more restricted channels. Such crossing of interests will have tended to keep the appendages which bear the spores small, so long as they are themselves not active or essential as nutritive organs; in fact, there would in that case be a tendency to perpetuate the strobiloid type. But if the appendages themselves carry on efficiently the function of supply of organic material, then there need be no limit to their size, provided that the water-supply to them can be maintained; and they may accordingly bear an infinity of sporangia, as is seen to be the case in the megaphyllous types. It is in connection with these functions of protection and nutrition that the foliar development would naturally come into prominence as a feature of the strobilus, and

this may have taken effect in more than one of the several phyla of the early Pteridophytes.

The relation of the sporangia and sporangiophores to the parts designated as bracts, sporophylls, or leaves is habitually, though not always, a close one. In the simpler strobiloid forms the leaf either subtends the spore-producing member, or the latter is borne upon its upper surface, commonly in a median position. The biological importance of this probably lies in the protection which is afforded, and in the ready supply of nourishment in cases where the leaf is an effective organ of assimilation. But it is an error to assume that there is any obligatory or constant relation for plants at large between the spore-producing members and the leaves. This is shown, first, by the fact that sporangiophores, even in very early fossils such as *Bornia*, may exist independently of the subtending leaves; and secondly, that when associated with leaves they may vary greatly both in numerical and local relation to them, even within near circles of affinity: this is seen in the Sphenophylleae with special clearness. Such examples taken from early fossils teach that the spore-producing members show a high degree of independence from the sporophylls. For the present these general remarks must suffice: but later, when the sporangiophoric Pteridophytes have been described in detail, we may attempt some more exact recognition of the varying relations which existed between the sporangiophores and the sporophylls in early strobiloid types.

In this connection the question may be raised whether sporangiophores and leaves have always been distinct categories of parts: whether leaves or foliar parts have ever developed into forms resembling sporangiophores. In the case of the Cycads there is little doubt that the parts usually designated female sporophylls or carpels are reduced foliar structures: it is shown on the basis of comparison that their form, so like that of many sporangiophores, has been attained by a process of reduction, and thus they may be held to be homoplastic with the primitive sporangiophores of Pteridophytes.

Such considerations as these will deter the morphologist from any precise definition of the categories of parts borne upon the strobili of early Pteridophytes according to experience derived from study of the Phanerogams. There is indeed no reason to assume that there was any initial uniformity of the development such as would lead to their always falling into strictly definite categories. Greater uniformity is, however, found among the higher forms, and it is this uniformity which has led to the establishment of those old morphological categories which are found to fit so ill upon the lower Vascular Plants. Each plant-type may be held to have worked out its own progressive development, while biological conditions common for them all would tend to reduce them to some common scheme. Such constancy as appears among the parts of the higher plants would then have been achieved by gradual evolution of order from beginnings which were less constant: and as a matter of fact the exceptions from that

order of disposition of the parts, or from that structural character which has been held as typical, are chiefly found where they would on this view be theoretically probable, viz. in the Homosporous Pteridophytes. This seems to be the natural way of regarding the various types of strobilus seen in early Vascular Plants: it is certainly more satisfactory than any attempt forcibly to reduce them to conformity with categories based upon the study of those plants which represent a later phase of evolution.

CHAPTER XIII.

ON THE RELATIONS BETWEEN THE STERILE AND FERTILE REGIONS IN THE SPOROPHYTE.

From the days when Morphology first arose as a branch of the science of Botany, the relations between the sterile or vegetative region of Plants, and the fertile or reproductive have been the subject of enquiry. Originally the question presented itself as one of simple comparison of those regions in the Flowering Plants, in which they are clearly differentiated one from another: the basis of the comparison was that of their external form, with the idea behind it of some degree of unity of plan in the construction of the two regions. At the present time the enquiry involves the direct question of their physiological relation, but it also extends to the indirect historical problem of their genetic relationship. This can best be approached by comparison of forms lower in the scale of development, such as the Pteridophytes, in which the differentiation is less complete than it is in the Flowering Plants.

From a physiological point of view, the necessity of a due balance between the sterile and fertile regions in the case of any fully differentiated, self-supporting organism is readily grasped; for the material required to build up the strobilus or flower to the point of maturing its spores must be derived from an adequate development of the vegetative organs which produce it. It is naturally otherwise in sporophytes which are not self-supporting, or only partially so, as in the Liverworts and Mosses; also in the case of parasites and saprophytes; but the latter, as derivative or secondary conditions, may be put aside when we discuss the adjustment of balance between the two regions in its evolutionary aspect. The indirect historical question is less readily tangible, but in its solution the sources of nutritive supply must be steadily kept in view throughout the comparative study of the lower and simpler sporophytes.

The fact that there is frequently a tendency towards extended production of spores in the Homosporous Archegoniatae has been brought forward repeatedly in previous chapters, where also the racial advantage which

follows upon it has been sufficiently recognised. The evidence that this tendency actually exists is to be found in the fact, illustrated in so many plants, that more numerous spores are habitually initiated than the plant is able to bring to maturity. The powers of nutrition impose the actual limit of the output of spores in any specific example, and any increase of the vegetative system will therefore result in an increased capacity for producing mature spores. Where the vegetative region extends so as to increase the powers of nutrition, it commonly happens that the initiation of potential spores still keeps in advance of such increased supply, and so the two seem to advance together. In the present chapter various examples from among the Archegoniatae will be examined from this point of view: upon these some idea may be based of the general methods of progression of the sporophyte, from its less differentiated state towards that seen in the Flowering Plants, where the vegetative and reproductive regions are clearly distinct, though their construction still shows a fundamental similarity of plan. But before this is entered upon, it will be well to clear the ground by consideration of the earlier theoretical views on the relation of these two regions of the plant-body.

Kaspar Friedrich Wolff laid the foundation for a comparative view of the appendages of the Higher Plants. In his *Teoria Generationis*, published in the latter half of the eighteenth century, he propounded the thesis that "in the whole plant, the parts of which differ so extraordinarily from one another at first sight, there is nothing to be found on mature consideration but leaves and stem, for the root belongs to the latter." For him all the appendages were of foliar nature. The modifications which appear in the parts which compose the flower arose, in his view, from the gradual waning of vegetative power, or "*vegetatio languescens*," as he called it; their development constantly diminishes the longer the vegetation is continued, and finally ceases altogether; consequently the essence of all these modifications of the leaf lies in their incomplete development.

It is but a slight step from ideas such as these to the doctrine of Metamorphosis as introduced by Goethe in 1790. He assumed an ideal fundamental organ, from which the different leaf-forms in any one of the higher plants could be regarded as derived. He designated as "Metamorphosis" that process by which one and the same organ presents itself to us in various modifications. This metamorphosis may be of either of three kinds: regular, irregular, and occasional. Of these the regular or progressive metamorphosis, with which we are specially concerned, is that illustrated in any normal Flowering Plant by the progression from the cotyledons through the foliage leaves to the flower with its successive series of parts. But, as Sachs points out in his *History of Botany* (Engl. Ed., p. 156), Goethe sometimes used the word "Metamorphosis" in its literal sense, as meaning an actual change in the organs arising from a transmutation of the species; sometimes his meaning was an ideal one: for, regarding the way in which cotyledons, foliage leaves, bracts, sepals,

petals, etc., originate on the stem, they were all included under the one general idea of "leaf." In the words of Sachs, Goethe's doctrine could only make its way to logical consistency and clearness of thought by deciding for the one or the other meaning of the word: he must either assume that the different leaf-forms, which were regarded as alike only in the idea, were really produced by change of a previous form—a conception that at once presupposes a change of the species in time:— or he must entirely adopt the position of the idealistic philosophy, in which the idea and the reality coincide. In this case the assumption of a change in time was not necessary: the metamorphosis would remain an ideal one, a mere mode of view; the word leaf would then signify only an ideal fundamental form, from which the different forms of leaves actually observed may be derived, as De Candolle's constant species, from an ideal type.

Though Goethe did not himself decide finally for either of these alternatives, the introduction of a theory of Descent, and a general belief in transmutation of species, went far towards clearing away any such ambiguity. In its light the facts seemed to point definitely towards a conception of a real transformation, and this point of view came into prominence *pari passu* with a better knowledge of the lower Vascular Plants, where leaf-differentiation is less fully carried out and gradual transitions are to be seen between vegetative leaves and sporophylls. Accordingly, it seemed to be the plain and simple reading of the facts to accept the metamorphosis as a change which had actually been effected in the course of descent. The natural progression shown in the life of the individual seemed to be that already described as progressive by Goethe: it was natural to accept this in terms of the theory of descent as progressive in the race also. On this basis the floral appendages would be held to be essentially foliage leaves, but altered in character to subserve propagation; and the pollen-sacs and ovules which they bear accessories which are added to the already existent foliar parts. The experience of zoologists had its influence in apparently confirming this position. The analogies between the two organic kingdoms are at many points so close that the general conclusions of the animal embryologists seemed readily applicable to plants also. If the ontogeny of the higher animals is found often to recapitulate the history of the race, should not the same conclusion apply also to the higher plants? Moreover, such a view presented itself as a mere continuation of the theoretical opinion of Goethe: the progressive metamorphosis which he recognised would figure, accordingly, as a principal feature in the evolution not only of the individual but of the race. Thus regarded the sporophyll of the individual plant would be an altered foliage leaf, and its origin by descent would be the same: the difference of their development would then lie in the presence of the sporangia, which brings correlative restriction of the foliar development in its train.

This position may seem satisfactory so long as the Higher Vascular

Plants alone are considered, or if sporangia are not regarded too scrupulously from an evolutionary point of view, and if it be assumed that they may be and have been habitually generated at large in the course of descent upon pre-existent foliar organs. If these points be granted, then it might be possible to retain Goethe's progressive Metamorphosis as the basis of an evolutionary story applicable to the Higher Plants. As a matter of fact, Botanists continued to analyse and describe the flowers of the Higher Plants in this way for a whole generation after the *Origin of Species* had been published. The flower was habitually regarded as the result of metamorphosis of a foliage shoot. Though the point was not always put into direct terms, the underlying assumption was that a conversion of vegetative parts into propagative parts takes place in the individual: that sporangia originated sporadically in descent, as they seem to do in certain cases now, and that such changes as are seen in the development of the individual had their place also in the history of its evolution. But increasing knowledge of the life-cycles of the lower forms, and of their comparison one with another, was meanwhile leading to sounder views of the origin of the higher Vascular Plants. Alternation of generations became gradually a more exact factor in the morphology of the last half-century. It seems no longer possible to look upon the Vascular Plant as a primary entity, as it was held to be in the time of Goethe. The sporophyte generally, and consequently the plant-body of all the Higher Plants which is a sporophyte, must necessarily be held to be secondary by all those who recognise antithetic alternation as a constant feature in descent of the Archegoniatae: for them the story of origin of the sporophyte must affect the interpretation of its parts.

A fundamental question of method in morphology is involved in this discussion, viz. the question of the validity of conclusions based on observations of the ontogeny as against the well-founded conclusions of phylogeny. It will now be generally agreed that, provided the conclusions as to phylogeny be sound, they should have the precedence over those based on observation of the individual life. But in the practice of the middle part of last century it was customary to act in the opposite sense, and to take the successive events in the story of development of the individual as the basis of morphological history: such views on descent as are based on comparison were often left out of account or given only a second place. If this latter principle be adopted, then conclusions harmonising with Goethe's progressive metamorphosis will follow, and the sporophyll may be accepted as an altered foliage leaf: but if precedence be given to the results of a broad comparison, then a converse conclusion will necessarily appear the more probable.

But there is also another question involved in Goethe's view of "progressive metamorphosis," that of the origin of the sporangia which appear in the strobilus or flower. The assumption that sporangia can be formed indiscriminately upon pre-existent vegetative parts was at the back of

Goethe's theory: it must be enquired whether this is a justifiable assumption. This question has not been too exactly scrutinised by his followers, who translated his "progressive metamorphosis" into terms of an evolutionary progression. The basis for the assumption was primarily the succession of events as seen in the individual life of the higher plants; but a certain laxity of view was further encouraged by the irregularities of number and position and of time of appearance of the sporangia in the Leptosporangiate Ferns. These plants were accorded an undue prominence in the early study of Pteridophytes, and for long the belief was held that they were the prototypes of all Vascular Plants. But it is now sufficiently clear that the Leptosporangiate Ferns are relatively late derivative forms, and that the types of Ferns of the primary rocks were more precise and



FIG. 85.

Botrychium Lunaria. Sterile laminae, which occasionally produce sporangia (*sp*) on certain pinnulae, and have partly or wholly assumed the form of the fertile spike: / in B and C is the fertile spike itself. Natural size. (After Goebel.)

exact in the arrangement and in the time of origin of their sporangia. Such precision is seen in higher degree in the Calamarians and Sphenophylls, and it is specially prominent in the Lycopods. All of these are types of quite as early, probably of even earlier, geological history than the Leptosporangiate Ferns. Accordingly it may be held that in the earliest Vascular Plants which we know the arrangement, time of appearance, and number of the sporangia showed some degree of definiteness, and were in some cases very precise. It cannot be denied that accessory sporangia may at the present day appear in some cases where none are normally present: conspicuous examples are those described by Lang in apogamous Ferns (compare Fig. 35), while a less bizarre case is that of the sporangia which appear on the usually sterile leaf of *Botrychium Lunaria* (Fig. 85): abnormal flowers of Phanerogams also provide numerous examples of sporangia not produced in the usual order or position. The question is whether the existence of such cases at the

present day will justify the assumption that in the evolutionary story sporangia originated indiscriminately upon pre-existent vegetative organs. My own opinion is that it does not, for a careful examination of such cases and comparison of them with the general type to which the plants in question belong shows that they are exceptional, if not indeed of the nature of monstrosities. It is clear that promiscuous formation of sporangia in present-day forms is possible, and that it does at times occur, but it does not follow that this was a general mode of their origin in past times.

An essential fact bearing upon the question in point is that spore-production is a constantly recurring event in Archegoniate Plants. There is good reason to believe that it has found its place in every normally completed life-cycle throughout their descent. Cytologically it is now seen to be the natural complement of the sexual process. Taking all types of Archegoniate Plants into our view, including the more recent Flowering Plants as well, there is reason to believe that spore-production was the initial function of the sporophyte, and that it has been continued and repeated throughout descent. If this be admitted, how can the strobilus, or the flower—the part bound up with that primary function of spore-production—be the result of metamorphosis of a vegetative shoot, the leading function of which is secondary? The conclusion to be derived from broad comparison will be the direct converse: viz. that vegetative parts in the sporophyte have originated by change of parts originally fertile.

But in order to carry conviction that this conclusion is correct, it will be incumbent on those who hold it to bring forward evidence bearing on the origin or increase of the vegetative system, which we see at the present day preceding spore-production in the history of the individual life. It has already been shown in Chapter VII. that *sterilisation* of individual sporogenous cells, that is, their conversion into cells having a vegetative function, is common. It is found in the sporangia of Vascular Plants, but it is in the sporogonia of Bryophytes that it has been recognised as specially effective in adding to the vegetative system. The sporogonium of *Ancura* (Fig. 86) has already served as an example, while reference to the writings of Goebel (*Organography*, pp. 326-329, Engl. Ed., p. 103), shows how fully sterilisation has already been realised, and accepted as a source of increase of the vegetative system in the Bryophyta. Similarly, in Vascular Plants it has been shown above, that sterile cells of a sporogenous group may be converted into vegetative tissue of a septum. Such examples indicate how sterilisation of individual cells may be effective in increasing, and perhaps in the first instance even in originating, the vegetative system.

A second factor, which has been specially effective in contributing to the increase of the vegetative system in the more differentiated types of sporophyte, is the *abortion of sporangia, or of sporangium-bearing parts.*

As this in my opinion has not yet been accorded its proper place in the evolutionary story, I propose to consider it at some length.

Imperfectly developed parts have played an important rôle in arguments on Evolution. On the Zoological side especially they have been used as weighty evidence. Similarly, in Botany they have been the basis of discussion: in the morphology of the flower, abortive stamens, carpels, pollen-sacs, and ovules have been cited as foundations for elaborate argument. Where present in normal position the existence of an abortive stamen or staminode has been habitually held to be sufficient indication of the previous existence of a fully developed stamen in the ancestral line: and on such evidence natural affinities have been traced and accepted,

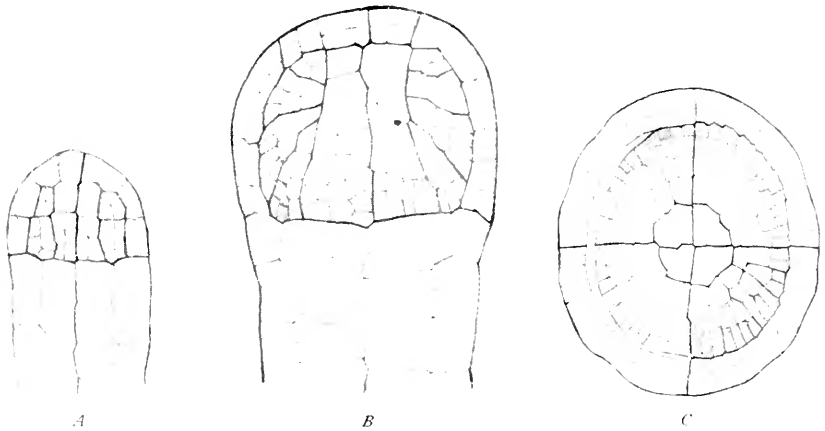

FIG. 26.

A, median section of young sporogonium of *Ancistroambrosioides*. The internal mass of cells of the sporogonial head ("archesporium") is already differentiated so as to indicate the sterile elaterophore, and the outer fertile region. *B*, the same, older: the indications of sterilisation have extended outwards, and it is only the peripheral fringe of cells (shaded) which will be sporogenous. *C*, transverse section of the same. 150.

usually without question. But floral morphology has gone further: comparative study has led to the conclusion that in certain ancestral lines of descent parts have existed, which in the individuals of the present day are entirely unrepresented by any vestigial growth. This condition of complete disappearance of a part or parts has been styled "ablast," as distinct from "abortion," where the incompletely developed part has an objective existence. Eichler maintained that the conditions distinguished as "abort" and "ablast" are not essentially different in kind, but only differ in degree. He points out that abortion itself is not susceptible of objective proof, and it may be remarked incidentally that it is this fact which has prevented the full recognition of the part which it has played in the origin of the sporophyte. Speaking of the relations between partial abortion, where a vestigial structure is present ["abort"], and complete suppression ["ablast"], Eichler remarks (*BlüthenDiagramme*, p. 52) that in

cases of abortion "objectively we see nothing more than that cell-divisions occur, that a rudiment appears; thus strictly speaking we observe that something develops, not that something is reduced: this may become a gland, an emergence, or what not. It is comparison, and usually the comparison with other species and genera, etc.—that is, the type-method,—which teaches that it is a reduced organ, and what is its special category. Whenever the same comparative method leads even to the assumption of a complete suppression, where no rudiment of the organ is seen with the bodily eye, in my opinion that is, in point of fact, no more than one step further along the same course." This is the position which should be the foundation of a correct view as to abortion, or even complete suppression of parts: it is currently accepted, and put in practice in the morphological treatment of the Angiospermic flower, and it is now high time that it should be applied equally to the Pteridophytes, where it has probably played a very important part. In the Pteridophytes too little attention has hitherto been paid to such subjects, and notably observations of arrest of sporangia, or of spore-producing organs, have been neglected. It is the isolation of many of the genera, and the paucity of species in some of the most important of them, which has stood in the way of their detailed comparison in this respect, and consequently arguments from arrest have not taken their proper place in the morphology of the Pteridophyta. But the argument to be founded on an imperfect sporangium at the base of a strobilus of *Lycopodium*, or on the abortive fertile spike of an *Ophioglossum* seated in the position normal for the fully developed part in other individuals, species, or allied genera, is precisely the same as that on an imperfect pollen-sac or ovule, or on a stamen or carpel in Flowering Plants. Further, a comparison as regards the presence or absence of spore-producing parts in species evidently related to one another may lead to the conclusion that sporangia entirely unrepresented at the present day were probably borne upon ancestral forms: the line of reasoning being the same as that in cases of hypothetical complete suppression of floral parts. It will presently be shown that such hypothetical suppression of spore-producing parts may be held accountable for changes in balance of the vegetative and propagative regions in the Pteridophytes, and be recognised as having led to an increasing prominence of the vegetative system in the course of their evolution.

The Lycopodinous type, being represented by numerous species of essentially similar construction, lends itself well to such comparative treatment, while the comparison is the more pointed owing to the definite relation of one sporangium to each subtending leaf, which arrangement, with very few exceptions, is the constant rule for the fertile regions of these plants. In all known Lycopodinous types a sterile leafy region, of greater or less extent, precedes the fertile region in the life of the individual plant. In many species of *Lycopodium*, and especially in those which have the vegetative and fertile regions less clearly differentiated,

the initial vegetative stage is soon closed by the appearance of sporangia in the axils of the leaves; but alternate fertile and sterile zones, merging into one another imperceptibly as regards form, succeed one another at irregular intervals throughout the upper region of the plant. This may be styled the *Selago* condition, as it is seen conspicuously in *Lycopodium Selago* (Frontispiece). In others, and especially in those in which the fertile region appears in the form of a definite terminal strobilus, the initial vegetative phase is more extensive, though still essentially similar to the strobilus in its construction; there is, however, a prevalent difference of form between the sterile and the fertile leaves, but the relation of the sporangia to the latter is the same as in the *Selago* form. It seems natural to conclude that the *Selago* type is the more primitive, and the definitely strobiloid type the derivative.

The question in either of these cases is, what genetic relation has existed between these sterile and fertile regions which are so similar in plan, but differ in the absence or presence of the sporangia. The clew is given by examination of the basal limits of the fertile zones in either case: for here, at the point of transition from the sterile to the fertile, imperfectly developed sporangia are often found, occupying the place normally taken in the fertile region by those fully developed. Applying to these the same argument as in the case of an imperfectly developed ovule or pollen-sac in an Angiospermic flower, they will be held to be vestigial representatives of sporangia, normally present, and actually initiated, but not completely developed. Passing from these to the vegetative region, where no vestigial sporangia are present, though the arrangement, character, and in the *Selago* type even the form of the leaves is the same as in the fertile region, the question arises whether these are not essentially sporophylls, in which the sporangia are completely suppressed? The result of a broad consideration of the question will be an answer in the affirmative. The facts indicate that in the simple Lycopod type progressive sterilisation has been effective, and that it has involved the partial abortion, or even the complete suppression, of whole sporangia; the result is that leaves originally in the race fertile have become sterile, and have thus contributed to the enlargement of the vegetative region. The fact that the *Selago* condition is seen represented in certain Lycopod fossils of the Coal period is important evidence of the validity of this progression as an early evolutionary factor.

Such sterilisation as that believed to have occurred in *Lycopodium* in the course of descent has been experimentally induced by Goebel in *Selaginella*,¹ by cutting off young strobili, and treating them as cuttings: the sporangia of the upper region aborted, and the sporophylls of the newly formed parts of the shoot developed as foliage leaves. Thus the result theoretically contemplated may follow from experiment.

¹ *Organography*, p. 957.

With this progressive sterilisation, and the consequent increase of the vegetative region, the apical growth of the axis keeps pace: it secures the initiation of additional sporophylls and sporangia to take the place of those transformed or aborted, and as there is no theoretical limit to the apical growth and branching, in such species as *L. Selago* the balance can constantly be readjusted between the sterile and the fertile regions. This combination of sterilisation and continued apical growth provides, in a sense, a forward impulse, and it will be effective up to the limit of physiological supply. That it is so is seen in the fact that at the apex of any Lycopod strobilus imperfect sporangia are found, which are to be recognised as supernumeraries, showing the continued exuberance of initiation beyond the power of the plant to bring to complete maturity. We thus acquire the conception of a zone of reproductive activity—or in the *Selago* type it may be several interrupted zones—limited below by parts which are to be held as vestigial, and above by parts which are supernumerary. By comparison of living species of *Lycopodium* it is seen that the fertile zone is not always located at the same level on the plant: it is sometimes preceded by a shorter, sometimes by a longer vegetative region. There has probably been a phylogenetic shifting of the fertile zone or zones: the biological significance of this is obvious, for any advance of the fertile zone to a higher point, by abortion of sporangia, while the sporophylls remain in a vegetative capacity as foliage leaves, provides a larger vegetative region below for purposes of nutrition. Such a manner of advance has probably been effective in the evolution of the Lycopods as we now see them.

If the Lycopods stood alone in showing such features as those described the facts would be of limited interest, but they do not; conditions essentially similar are seen in the sporophytes of other Vascular Cryptogams, though varying in detail. The mature plant of *Isoetes* is virtually of the *Selago* type: it bears fertile and sterile leaves intermixed: vestigial representatives of sporangia are found in the position normal for sporangia upon many of the sterile leaves; further, the probability that the leaves actually sterile are so by suppression is as strong here as in the case of *Lycopodium Selago*. The mature plant is preceded by an embryonic vegetative phase, with leaves bearing no sporangia; but after the first sporangia appear, the whole plant may be regarded as a strobilus, imperfectly differentiated, as in the *Selago* type, into fertile parts and parts sterile by abortion or by complete suppression.

Similarly, in the Psilotaceae, the *Selago* condition, with irregular alternation of sterile and fertile zones, is seen in both *Psilotum* (Fig. 87) and *Tmesipteris*, while imperfect synangia are found about the limits of the fertile regions. There is, however, a broad difference in form between the simpler sterile appendages and the more elaborate fertile ones; in this respect the differentiation of sterile and fertile parts has proceeded further than in the Lycopods. In the allied fossils, the Sphenophylleae, there

is, as a rule, a definite strobilus, which is fertile throughout: but in *S. majus* this is not clearly differentiated by form either at base or apex from the vegetative region. Such a condition shows an interesting analogy with the less differentiated states of *Lycopodium*.

Among the Equisetales, *Equisetum* and *Bornia* have, as a rule, a definite strobilus, composed entirely of sporangiophores borne on an axis, and clearly marked off from the vegetative region which precedes it in the ontogeny. But in the Calamarians, as also in the fossil known as *Phyllothea*, sterile leaf-sheaths are interspersed between the sporangiophores, a condition occurring also as an occasional abnormality in *Equisetum* (Fig. 88). The morphology of these cases will be more fully discussed below; meanwhile it may be held that while in *Equisetum* and *Bornia* the differentiation of the fertile strobilus from the vegetative region is more distinctively marked, *Phyllothea* or the Calamarians show some degree of analogy with the *Selago* condition seen in *Lycopodium*.

The Ophioglossaceae provide clear cases where the argument of abortion leading to complete suppression will apply: for various degrees of development of the fertile spike may be found borne upon the fully formed leaf, from that fully matured to small vestigial parts which do little more than mark the place where the normal spike would be inserted;

in other cases again the spike is entirely unrepresented. The facts here correspond to those in *Lycopodium Selago* or in *Isoetes*, except as regards the size and number of the parts concerned. Such a condition in an Angiospermic flower would certainly be interpreted as abortion, and the

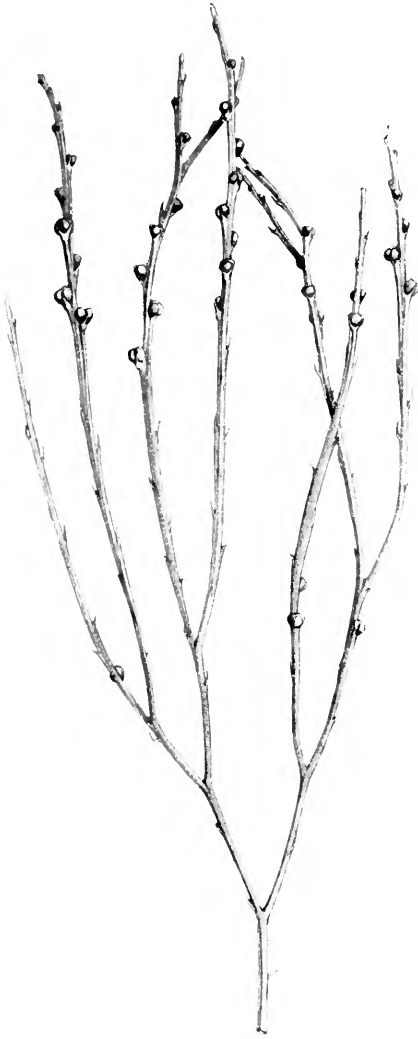

FIG. 87.

Shoot of *Psilotum*. Natural size. Showing "Selago" condition in the bifurcate branch-system: the base is vegetative: then follows a zone bearing synangia, then a vegetative zone, and higher up a second fertile zone.

incomplete parts where present as vestigial, and a similar conclusion seems justified for the Ophioglossaceae. It may thus be held that in the mature plant of the Ophioglossaceae all the leaves are potentially fertile: the sterile foliage leaf is merely the part which remains when the spike is abortive, and its genetic relation to the fully matured sporophyll is the same as that of the sterile to the fertile leaf in *L. Selago* or in *Isoetes*.

There remains for consideration from this same point of view the large series of the Ferns. Notwithstanding the preponderant size of their leaves, and the wide distribution of the sori and sporangia over their large surface, they should still be studied in the same way as other Pteridophytes: their difference of conformation should not be allowed to affect the recognition of such similarity in the relations of the vegetative and propagative parts as may exist between them and the smaller-leaved forms. Since the relation of leaf to axis is essentially the same in Ferns as in other Vascular Plants, the whole shoot may be held as equivalent to the shoot, for instance, of an *Isoetes*: and this aspect of it may be maintained equally in those cases where the axis is short and the leaves crowded upon it, and also in those where the axis is elongated and the leaves isolated at long intervals apart. Maintaining this point of view of the shoot as a whole, there is in the ontogeny of the Ferns a preliminary vegetative phase, which may be of varying extent; subsequently the fertile phase begins. The broad relations of the two phases are thus the same as in other Pteridophytes.

The fertile region in Ferns is imperfectly differentiated, and it is in this respect comparable with those imperfectly differentiated forms which show what has been called the *Selago* condition. But the matter is further complicated by the fact that in many Ferns the differentiation does not involve whole leaves, but only parts of them: the large Fern-leaf, in fact, does not always behave as one unit, but the differentiation of sterile and fertile regions may involve only parts of the individual leaf, not the whole.

Taking into consideration first the simpler case, where whole leaves are differentiated either as sterile or fertile, examples are seen in such cases as the common Hard Fern (*Blechnum boreale*) or in the Ostrich

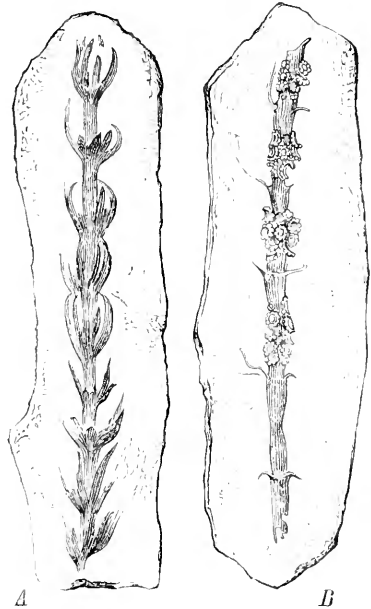

FIG. 88.

Phyllotheca. Ligno. A, Ph. equisetiformis from Rovere di Velo, near Verona. *B, inflorescence* from Siberia, placed by Schmalhausen with *Phyllotheca*. (After Solms.)

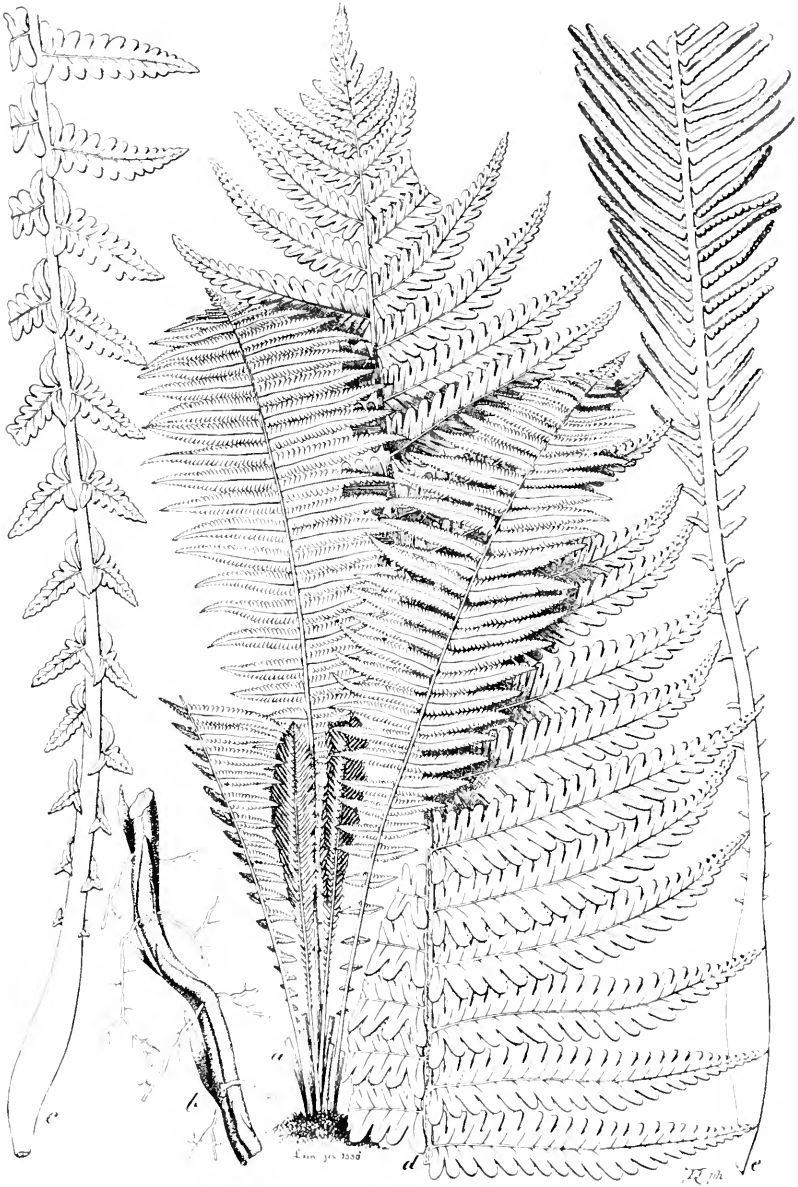

FIG. 56.

Onoclea Struthiopteris, Hoffm. a, fructifying plant, much reduced, with most of the sterile leaves removed; b, lower and upper portions of a sterile leaf; c, lower part of a fertile leaf. b, c, two-thirds natural size. (From Rab. *Kgypt. Flora*.)

Fern (*Onoclea Struthiopteris*) (Fig. 89). There may be some degree of regularity in the succession of sterile and fertile leaves, which may be correlated with season; thus in *Blechnum boreale* the leaves first expanded in the spring are sterile, and they are followed by a series of fertile leaves. The condition of the shoot as a whole is, in fact, comparable with that of *Lycopodium Selago* or of *Isoetes*, with their successive sterile and fertile zones.

But the commoner case for Ferns is that where leaves are not sterile or fertile as a whole, but many or even all the leaves of the mature plant are fertile at least in part, and frequently show a correlative reduction of area as compared with the rest of the leaf, which is sterile. In the distribution of the fertile and sterile parts of the individual leaf there is great diversity, and differences may be seen in species of the same genus, or even in individuals; thus in *Osmunda regalis* the lower parts of the fertile leaf are broadly expanded and sterile, the apical region is fertile and correlatively exiguous; but in *O. javanica* the fertile region extends irregularly over the lower pinnae, and the apical region is expanded and sterile (Fig. 90).

It has been shown by Goebel that the mode of development of such Fern-leaves may be experimentally altered: by removing from a plant of *Onoclea Struthiopteris* the foliage leaves which are first expanded in the spring, the later expanded leaves, which are normally sporophylls, were induced to assume the character of foliage leaves. Similar results were also obtained by Atkinson.

The facts thus briefly summarised for Ferns are evidently comparable with those noted for the Lycopods, and the differences in detail which exist have their relation to the megaphyllous character. But in Ferns the facts are less cogent; for though abortive sporangia and imperfect sori are at times found on Fern-leaves, still the evidence that they are vestigial is less clear than in *Lycopodium*, *Isoetes*, or *Ophioglossum*, owing to the less definite position and number of those parts in Ferns. The conclusion that the foliage leaves or parts of leaves in Ferns are phylogenetically sterilised sporophylls, or parts of sporophylls, is therefore based rather on broad comparisons and on analogies with other Pteridophytes than on the direct observation of parts which may be held to be vestigial. That such a transmutation may take place in the individual life is fully demonstrated by the experiments of Goebel above quoted. It seems therefore reasonable to hold for Ferns, as for other Pteridophytes, that sterilisation of sporophylls has been effective in the course of their evolution.

A converse view to that thus stated has been habitual in the past, and is maintained by some to the present time. By them the evolutionary history is read in direct terms of the ontogeny, and the sterile leaf is thus assumed to be the primitive leaf, which has become a sporophyll by the superposition upon it of sori and sporangia. Those who take this point of view have brought forward in its support the facts that the development and structure of the sterile and fertile leaves is closely alike, and that intermediate forms exist frequently between the two, so that the

distinction is very perfectly bridged over. But I submit that the most exact demonstration of similarity in detail of development, and the quotation

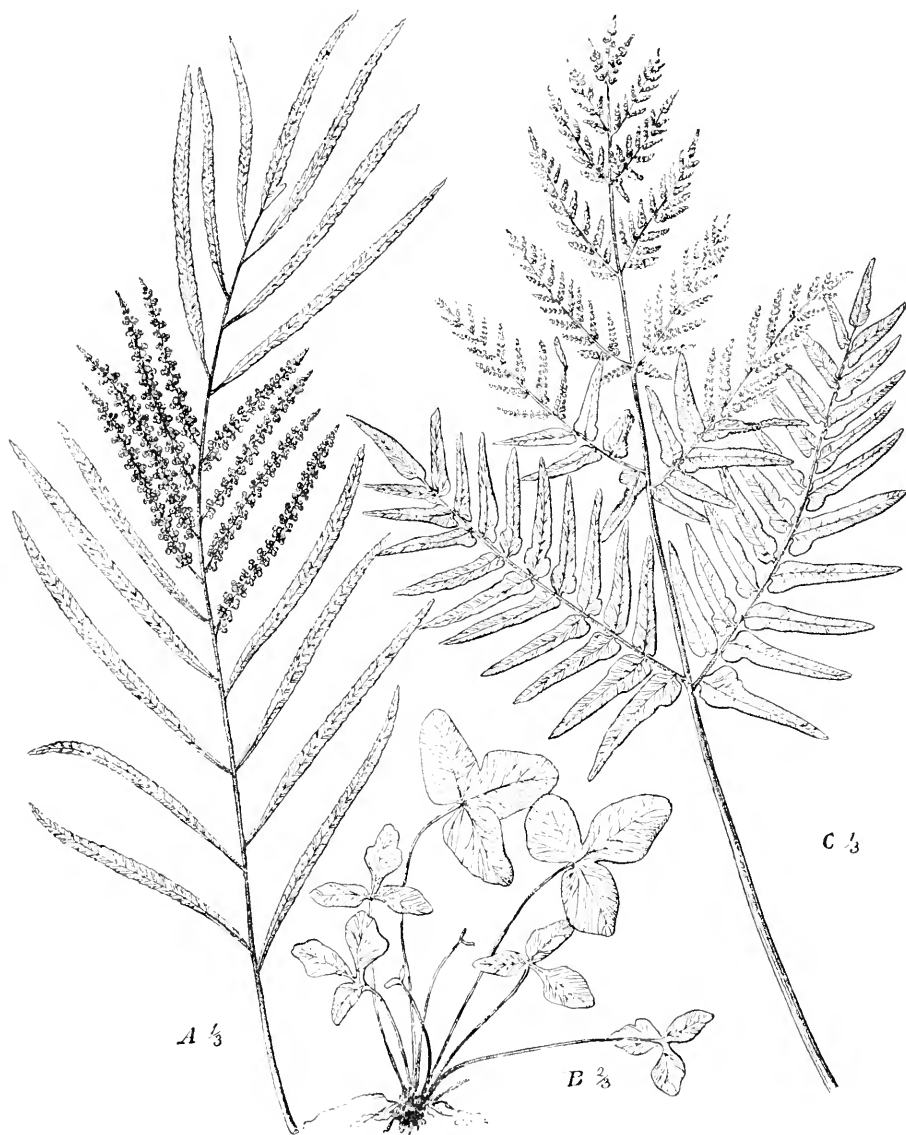

FIG. 96.

Osmunda, L. A = *O. Presliana*, L. Small leaf. B and C = *O. Regalis*, L. B = young plant. C = leaf of a mature plant. (After Engler and Prantl.)

of an infinity of middle-forms drawn from the most varied types of Ferns, does not touch the question of phylogenetic priority. Such facts are the

necessary basis either for the older view, that the sporophylls are altered foliage leaves, or for the view that the foliage leaves are sterilised sporophylls: but they do not tell distinctively for either. The decision must rest primarily upon the presence of vestigial sporangia, together with broad comparison rather than upon details of individual development. Still it is necessary that any final conclusion should be in accord with the details of the individual development, and this is so in the present case, whichever of the alternative conclusions be adopted.

Finally, the interesting demonstration by Goebel, that the sporophyll may be experimentally converted into a foliage leaf, does not serve as a decisive proof of either view. It demonstrates, however, the close relation of the two which either hypothesis will demand. It shows also that sterilisation of a sporophyll such as our hypothesis requires can actually occur. Such a process of sterilisation, carried out continuously in the course of descent, and involving either whole leaves or only parts of them, would result in the differentiated character of the leaves of Ferns which is actually seen in nature.

The leading types of Pteridophytes have thus been reviewed as regards the relations of their sterile and fertile regions. In the individual life of them all, there is at first, as their physiological condition demands, a more or less extensive vegetative phase, succeeded sooner or later by a fertile phase, though this is often not clearly differentiated from it. By comparison, it may be concluded that vegetative leaves have been derived by sterilisation from sporophylls; and it is not difficult to realise how a vegetative system may thus have been increased, and the production of spores have been delayed in the individual life.

On the other hand, the unlimited apical growth seen in many of the Pteridophytes, acts as a set off against the progressive sterilisation, for it tends to preserve the balance of the sterile and fertile regions which the sterilisation would disturb, and still provides for the initiation of an adequate number of spores. In the simpler strobiloid forms, such as *L. Selago*, it is easy to conceive how progressive sterilisation and continued apical growth combined would lead to a larger vegetative system and an increased final output of spores. In the more complex Ferns a progression of a parallel nature may be traced, though with less exactitude, owing to the fact that the large individual leaves do not develop as units. Any individual Pteridophyte plant may thus be regarded as being the resultant of two progressions: advancing sterilisation below, and apical growth, with or without branching, which provides for additional spore-producing capacity above; and it may be pictured to the mind, especially in the strobiloid forms, how the fertile zone, which is limited below by the limit of sterilisation, may thus have been raised progressively higher on the axis as development proceeded, and the time of spore-formation may have been correspondingly delayed. But it is essential to remember that however long it is delayed, the spore-production which eventually happens is the same

process, as regards the whole life-cycle, as that in the simplest sporophytes. All the vegetative machinery which precedes and delays it, is, from our point of view, a phase intercalated between the two constant and cytologically complementary events of sexuality and spore-production.

Once fully differentiated the sterile and fertile regions may vary independently of one another. This is already seen in some degree in those species of *Lycopodium* or *Selaginella* in which the strobilus is strictly circumscribed: but it becomes a more prominent feature in the higher Flowering Plants, where the flower often differs in marked degree from the vegetative system of the same plant. Still, even where the sterile and fertile regions are the most divergent a comparison of the life-histories as a whole points to the conclusion that their genetic relation has ultimately been as it is seen in the less advanced Archegoniatae: that the larger part at least, if not indeed the whole of the vegetative system is referable in its origin to progressive sterilisation of parts originally fertile. The question whether the whole is thus referable involves embryological discussion, which must be reserved for the next chapter.

CHAPTER XIV.

EMBRYOLOGY AND THE THEORY OF RECAPITULATION.

BEFORE bringing into the discussion any evidence derived from the study of comparative embryology, it will be well to enquire briefly into the foundations upon which its arguments are based. Here as elsewhere the methods and opinions of the present time are founded on the knowledge and practice of the past: from time to time, it becomes necessary to re-examine the methods currently applied in any special branch of it, and to ascertain how far they are in accord with the general position of the science as a whole. It will be seen in the matter of embryology that as the point of view of the whole science has altered the methods and opinions of workers in this field have also undergone modification, and we must accordingly be prepared for still further changes so as to keep embryological method in accord with the time. A short historical sketch will illustrate this, and at the same time it may give some better insight into the bases of embryological method as it exists at present.

Embryology as a branch of the science of Botany can hardly be said to have existed before 1840. It is true that there was already some knowledge of the form and position of the germ in Flowering Plants. So early as the seventeenth century both Grew and Malpighi dissected and described the embryos of various seeds, while Ray, in his *Historia Plantarum*, founded the distinction of Dicotyledons and Monocotyledons on characters of the embryo. But up to the early decades of the nineteenth century the study of the early stages of development of the individual was not used as a systematic means of elucidation of the relations of plants. This method was introduced by Schleiden, who saw in the history of development the foundation of all insight into morphology. He founded the study of development of the flower, which has had such far-reaching effects on their comparison and systematic arrangement. He also gave special prominence to the initial embryology of the individual plant, and to comparison of the higher forms with the Cryptogams. Almost simultaneously the details of cellular construction and of apical segmentation in the lower forms were revealed by Naegeli, and as he extended his

observations, which were thus initiated among the lower Cryptogams, to the Archegoniatae and the Phanerogams, he secured that morphological ideas, hitherto drawn primarily from the Phanerogams, should be examined in the light afforded by the history of development in the Cryptogams. And thus the way was prepared for the brilliant embryological work of Hofmeister, who, after investigating the embryogeny of the Phanerogams, tracing the individual from the egg onwards, proceeded to apply the same method to the Bryophytes and Pteridophytes, with the results which are now permanently interwoven into the web of the science. It may be said that subsequent work in this direction has done little more than to fill in the details in the areas of observation left blank upon the morphological map thus plotted in broad outline about the middle of the last century. It is in the interpretation of the facts, and the recognition of the evolutionary history which they convey that there has been room for some difference of opinion: and it is this that will now be discussed.

While the elucidation of the facts by Naegeli, Hofmeister, and others was proceeding, the belief in the mutability of species became prevalent: the Darwinian theory seemed, as we have already seen, to provide a natural explanatory thread running through the facts of genetic morphology and connecting them into an evolutionary history. It was held that the successive events of the individual life directly illustrated the course of descent: as regards the sporophyte the first stages were accordingly regarded as phylogenetically the earliest, and consequently for comparative purposes the most important. Embryological detail was thus given a high place in comparative morphology. Analogy with the results and arguments of zoologists seemed to support this position, and just as some consistent reflection of the phylogenetic history was found in the beginnings of the individual life of the higher animals, so, it was held, should be the case with the plant: the embryology of the sporophyte was accordingly made the basis of a consecutive history of its development in the race. For instance, the first formed leaves were held to represent the primitive and original foliar type, and those formed later on in the individual life were regarded as subsequent in the history of the race: or, carrying this line of thought further into detail, the order and position of the first segmentations in the ovum were regarded as of special comparative importance, and were used as the basis of elaborate theorising.

But before such conclusions are accepted, it is well to reflect upon the profound differences which exist between the embryology of the higher animals and that of the sporophyte in plants. In the first place, the embryogeny of the higher animal is carried out once for all after fertilisation: the main parts are laid down at a comparatively early stage, and are not repeated later. But in the sporophyte of all Vascular Plants the initial embryogeny is merely a preliminary phase leading to that continued embryogeny which involves the repeated formation of parts: this is maintained throughout the active life of the plant. Hence the initial embryo-

geny of any higher sporophyte is a much less essential incident in the whole development than that in any higher animal: the embryogeny of a higher animal is at best only comparable with the initial embryogeny of a plant where the embryo is still enclosed in the tissue of the parent: it has no counterpart corresponding to that continued embryology which is so long maintained in the apical region of the plant-body.

Secondly, the sporophyte is now believed to be itself an intercalated phase, which has assumed increasing proportions in the course of descent, while the function of spore-formation, which comparison tells us was the initial function of the sporophyte, has been proportionally delayed. If this be true, so far from the first formed parts being in their present form the prototypes, they would be more correctly recognised as derivatives, modified, or it may be transformed, during later evolutionary periods.

The absence of strict analogy between the embryogeny of the higher animals and the higher plants is further illustrated in relation to the theory of germinal layers. Following on the experience of animal embryologists who found that definite regions of tissue of the mature animal body are referable in origin to definite germinal layers of the embryo, Famintzin undertook to prove that the same holds for the definite systems of epidermis and vascular tissue in the Angiosperms. It is true that the origin of the epidermis and of the central stele gives some countenance to such a view, though even in these it is not difficult to quote exceptions where that regular mode of origin does not exactly apply. But the question becomes critical with regard to those parts of the vascular system which pass from the stem into the leaves: do these originate from the plerome system of the axis, as by the theory of germinal layers they ought to do? As De Bary pointed out,¹ this could not be otherwise effected than by outgrowths of the plerome pushing between the other layers of the young forming leaf. But as a matter of fact, they are derived from the primary periblem, and definite bands of this tissue show the corresponding differentiation, by which means the vascular system of the leaf is connected with that of the axis. This almost forgotten discussion is quoted here as an example of an attempt, actually made, to impose an embryological idea derived from the study of animals upon the embryology of the higher plants; and it shows how, when submitted to the test of detailed observation, it has been rejected. It must be clearly understood that such comparisons deal only with distant analogies, and that for reasons such as those already explained the methods and arguments of animal embryologists are not transferable to the embryology of the sporophyte of plants. In point of fact, hitherto plant-embryology owes little to animal embryology beyond the confusion of thought which follows on fallacious comparisons.

The success of Naegeli and Leitgeb in recognising and delineating the apical cell, and the regular succession of its segmentations in various plants, turned the course of accurate observation about the middle of

¹ *Comp. Anat.* Engl. Ed., p. 23.

the last century into this channel. Without their having any clear understanding what the apical segmentation signified, it became an object for investigators to define its details in representatives of all the main groups of plants, and the attempt was made to correlate the segmentation observed with the initiation of definite external parts or internal tracts of tissue. With regard to the former, it is undoubtedly the fact that the appendages in certain of the lower organisms may be directly correlated with apical segmentation: this is seen in many Algae: in Mosses also each segment of the apical cell gives rise to a leaf, and Naegeli, who looked upon the apex as a dominating influence, held that the same was the case in Pteridophytes as well. But a general revision of the question has led Schwendener to the conclusion that the origin of the appendages in the Pteridophytes is not necessarily connected with or determined by the

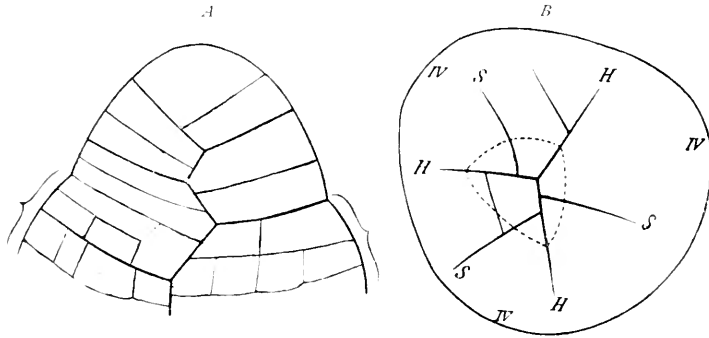

FIG. 91.

A = Apex of *Equisetum scirpoides*: the swelling below shows the highest leaf-sheath: this extends upwards on the right to the segment-wall, on the left only to the middle of a segment.
B = trans. sec. of the same apex: the dotted line indicates the apical cell: focussing downwards, the outline shows the youngest sheath, with its three leaf-teeth already indicated by the faintly three-lobed outline. *H* = principal walls, *S* = sextant walls; the position of the leaves is independent of these. $\times 550$. (After Schwendener.)

segmentation at the apex. The genus *Equisetum* is a good case in point: for though the segments of the apical cell are constantly arranged in three longitudinal rows, still the number three does not dominate the variable numbers of leaf-teeth in the whorls of the mature plants of the genus. Moreover, as the leaves of successive whorls alternate, while the successive segments do not, it would be difficult to trace any constant connection between them. Even in *E. scirpoides*, in which the leaves are regularly three in a whorl, Schwendener has shown that these are not directly related to definite segments (Fig. 91).¹ The slender apices of *Salvinia* and *Azolla* have been held to show a constant relation of appendages to segments; but even here, though a numerical correspondence may be traced, the successive leaves arise in different parts of the corresponding segments, being placed alternately in their upper and lower halves. In the Ferns there is not any regular numerical relation between

¹ Schwendener, *Sitz. d. Akad. zu Berlin*, 1885, pp. 927-933. Figs. 7, 8.

segments of the apical cell and the appearance of leaf-primordia: Schwendenner has even been able to show that where the arrangement of the leaves is spiral, the spiral of leaf-arrangement may be antidromous to that of the successive segments, and he states that the latter condition is almost as common as that where the two spirals are homodromous. It thus appears that, in those Pteridophytes in which the apical segmentation is most regular, no constant relation exists between the formation of segments and the origin of the appendages: Naegeli's conception of the apex as a dominating influence in this matter is not supported by the facts. And here it may be noted that even in the embryo of the Higher Plants there is evidence that the first cleavages in the embryo do not define the position of the parts: for it has been found by Westermaier¹ that the primary median wall of the embryo of Cruciferae has no strict relation to the position of the subsequent cotyledons.

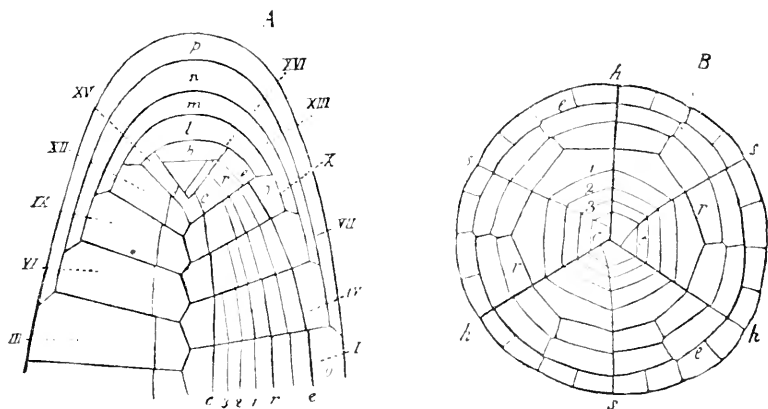

FIG. 92.

Scheme of the succession of cells in the apex of the root of *Equisetum hiemale*, after Naegeli and Leitgeb. *A*, longitudinal section. *B*, transverse section at the lower end of *A*. *h*=principal walls, *s*=sextant walls. *c*=the first, *e*=the second, *r*=the third tangential wall. In *A* the figures I.-XVI. denote the successive segments. *σ*=dermatogen. *k, l, m, n, p*=successively older portions of the root cap. From Sachs's *Text-book*.

A somewhat similar idea to that above discussed was initiated also in relation to the internal differentiation of tissues. Naegeli and Leitgeb established early the relation of the outer limit of the central vascular cylinder to the first periclinal wall in segments at the apex of the root in Equisetaceae, Marsiliaceae, and Polypodiaceae (Fig. 92). Subsequently Hanstein's study of the meristems in certain well-defined cases of the Higher Plants led him to distinguish formative tissues giving rise respectively to epidermis, cortex, and vascular cylinder: these he designated dermatogen, periblem, and plerome. As the study of the tissues became more exact, and took form in the stelar theory of Van Tieghem, the

¹ *Ref. Bot. Cent.*, vol. lxxvii., p. 122, 1899.

generalisation came to be widely accepted that the delimitation of the embryonic tissues by Hanstein should coincide exactly with that of the mature tissues by Van Tieghem, and that this is generally applicable to stems as well as roots of Vascular Plants.

But this whole subject has recently been submitted to a detailed revision by Schoute,¹ and it has been shown that the generalisation of Hanstein—that the three formative regions exist at the apex—was based on a very narrow area of observation. As a matter of fact, there is no separate origin of them in Pteridophytes, for they all spring from the initial cell or cells. In the Phanerogams such separate origin is best seen in roots, but even there it is not constant at the extreme tip. In stems it is only seen clearly in some few cases; in most stems hardly at all. The dermatogen is the most frequently and the most clearly defined of the three: the distinction of periblem and plerome in stems is only rarely carried out. Neither is the partitioning of the formative regions in the embryo clearly marked at an early stage in vascular plants at large: though there is some approach to it in some Dicotyledons, the Monocotyledons and Gymnosperms show little regularity, and it is almost entirely wanting in some plants. Thus it cannot be said that the details of development of the embryo in any way strengthen the position as regards the formative regions of Hanstein. The general conclusion seems a justifiable one, that no great morphological importance is to be attached to the formative regions of Hanstein since they are so commonly of inconstant occurrence.

An examination of the further question whether the dermatogen really produces epidermis, the periblem cortex, and the plerome the central cylinder, also shows inconstant results. In those roots in which periblem and plerome are clearly defined at the apex the cortex does originate from the periblem and the central cylinder from the plerome, though this does not hold exactly for all roots. But in stems the correspondence of Van Tieghem's primary tissue-systems with the formative regions does not hold: it is not even carried out exactly in the single regular example which has been described, viz. *Hippuris*: for here, according to Schoute, the endodermis and part of the cortex may be derived from the plerome. It is thus seen that the case is similar to that already discussed of the relation of apical segmentation to the origin of the appendages: in certain few examples the early segmentation may coincide with the definite mature condition, but in the great majority no such regular relation exists in either case. Where it does exist it may be held to be casual rather than causal, and will bear no constant phylogenetic significance.

The reasonable degree of success which seemed at first to attend these efforts to correlate with early segmentation at the apex not only mature external form, but also internal structure, led to a peculiar development in the study of the primary origin of the embryo from the egg. However clearly we may now see that the position assumed by the investigators of

¹ *Die Stelär Theorie*, Groningen, 1902.

1870-1880 is untenable in face of present facts, still their reasoning was correct: and quite logically (provided the premises were sound) it was argued that if the segmentation at the apex of axis or root defines and dominates the later development of its tissues or appendages, then a similar importance, but enhanced by its earlier position in the individual life, should attach to the first segmentations of the zygote. Accordingly the study of segmentation was assiduously pursued back to the earliest stages of the embryo; and, as apparently confirming the position, the fact was disclosed that a high degree of constancy rules in the first fissions of the ovum of the Archegoniatae. Also it was found possible, with some degree of certainty, to assign specific developmental functions to the earlier segments: thus the first or basal wall was seen to separate a part which habitually formed the shoot from a part which habitually formed the foot or root: further, the four quarters of the Fern-embryo were shown to correspond to the points of origin of stem, leaf, root, and foot: and as the Leptosporangiate Ferns were regarded about the time when this work was being done, as a fundamental type, the effort was made on the basis of the Fern-embryo, to construct what might be called a general embryology founded upon study of cell-cleavages. This was extended not only to the various types of Pteridophytes, but also, irrespective of the great systematic gulf which lies between these classes of Plants, to the Bryophytes. An example of the lengths to which this embryology based upon cell-cleavages was driven is found in the comparison of the embryo of a Fern and of a Moss, by Kienitz-Gerloff.¹ He recognised the basal wall of a Fern-embryo as comparable with that of a Moss: the epibasal half of the embryo in the latter divides into quadrants, of which one develops no further, while the other forms the whole of the upper part of the sporogonium. Since this quadrant corresponds in position, and in some degree in segmentation to that which forms the leaf of a Fern, it was suggested that there is a true homology between the sporogonial head of a Moss and the leaf of a Fern. Such comparisons die hard, and this one still figures in the morphological arena.

A more reasonable position, and one which is likely to leave still more permanent effects on current embryology, was that of allocating certain organs of the embryo to certain octants resulting from the primary segmentation of the zygote. It is true that the cleavages are relatively constant in certain forms: and that the position in which the several parts originate may also show a high degree of constancy. The reference of such parts in origin to certain octants presupposes that there is some causal connection between the two. There are, however, good reasons for not conceding any such causal connection. The first is the fact, now demonstrated even in cases where the apical segmentation is regular, that the parts of the mature sporophyte are not referable in origin to definite segments. A second is that in many cases though the part in question may be referred in origin to a definite octant or octants, only a relatively small part of those octants

¹ *Bot. Zeit.* 1878, p. 55.

may participate in the growth; while, conversely, the growth may actually extend in some cases to other octants than those cited. Further, in certain cases, and especially in the Lycopodiales, the relative position of the parts of the embryo is not constant. There are thus difficulties in the way of according any high importance to the primary segmentations of the embryo. From the facts as now known, it would appear more natural to regard the embryo as a living whole: to hold that it is liable to be segmented according to certain rules at present little understood: that its parts are initiated according to principles also as yet only dimly grasped: that there may be, and sometimes is, coincidence between the cleavages and the origin of the parts, but that the two processes do not stand in any obligatory relation the one to the other.

While the embryology based on cell-cleavages was developing, Sachs was engaged in maturing his comprehensive views on the arrangement of cell-walls in the youngest parts of plants. His recognition of the prevalence of rectangular division of the cells, coupled with the demonstration that the same mode of segmentation may occur in such diverse bodies as embryos and superficial hairs, went far towards reducing the arrangement of cell walls to a general rule: it became apparent that the first cleavages of the embryo are not so much the indications of a phylogenetic history, as the necessary consequences of rectangular division in a body of approximately spherical form. And now that finally the demonstration has come that in the continued embryology at the apex of stem and root the segmentation has no strict or constant relation either to the formation of the appendages, or to the internal differentiation of tissues in plants at large, the logical foundation has been swept away from below the feet of the adherents of arguments from cleavage. For here as elsewhere we are bound now to admit that there is no necessary or constant relation between cell-cleavages and differentiation, external or internal. Such relations may exist, it is true, and they sometimes do; but their inconstancy shows that they cannot be made the subject of general argument.

It will thus appear that the methods of embryology hitherto employed require considerable revision, so as to bring them into line with the facts already observed. Excepting perhaps within narrow circles of affinity, and especially in those where definiteness is the rule, arguments from detail of segmentation must be discounted: and this will be so in regard to the initial embryogeny of the sporophyte, as much as to the continued embryology close to the growing apex. Concurrently with the gradual acquisition of the facts which have led to this general conclusion, there has grown up a definite tendency of thought towards a new view of embryological facts. The assumption of some unity of plan, or type of construction of the embryo in Archegoniate plants, which so long dominated these comparisons, has relaxed its hold: in its place has come the desire to study the young sporophyte biologically, as a germ to be nursed by the parent plant, in the Bryophytes till full maturity, but in the Vascular Plants for a time only,

till it is established in the soil. And as the prothallus differs in form and position, in size and in duration of life, so the germ itself may differ in the place and time of origin of its parts, as well as in their form and structure. A few illustrations will show how this point of view gradually asserted itself.

In 1882 a comparative revision of those parts which serve as haustoria in various embryos led me to the conclusion that they are not to be regarded as clearly defined morphological members, but rather as swellings of the hypocotyl, which arise only where they are required for the first processes of development and nutrition of the young embryo.¹ Some years later Treub introduced his theory of the "Protocorm":² theoretical considerations of the biological condition of the young embryo had led him to conceive of an organ preceding in descent the leafy shoot, such as is now seen in Vascular Plants; and this he recognised as actually present in the embryonic tubercle of certain Lycopods: a preliminary stage, in fact, which is to them as the protonema is to a Moss. Whatever view we may now hold of the protocorm, this theory takes its place as a further step towards a biological rather than a purely formal study of embryology. At the hands of various other writers such views have been further developed, especially in relation to the better knowledge recently acquired of the embryology of the Lycopods and Ophioglossaceae: and it was thus open to Goebel to formulate the position, as he does in his *Organography*.³ Having shown that external forces do not come into consideration in the arrangement in space of the parts of the embryo,⁴ he points out that we need only consider internal factors, and say generally that root, shoot, and haustorium are laid down in the positions that are most beneficial for their function. This is in fact an extension to the whole embryo of the conclusion which I had applied in 1882 to the foot only. Comparative embryology of the sporophyte would thus become essentially a study of the circumstances and conditions which influenced the embryo during its evolution, and of the way in which the germ is formed to meet them.

But it may be enquired whether the germ itself does not still show beneath these adaptive modifications, some characters of a central type? Is all trace of the early evolutionary history eliminated by the subsequent modifications? There is at least one leading feature which remains traceable with some degree of constancy throughout the series of known embryos of the Pteridophyta: it is found in the relation of the parts to that initial polarity which is established at a very early stage in them all. This may often remain obscured owing to the precocious development of certain parts, in response to biological requirements; but nevertheless, it will be shown as the several embryos are described, that the apex of the axis has constantly a position in close relation to the intercrossing of the octant-

¹ *Quart. Journ. Micr. Sci.*, xxii., p. 277.

² *Buitenzorg Annals*, viii., p. 1. The Theory of the Protocorm will be discussed at length below, in relation to the embryogeny of the Lycopods.

³ *Organography*, ii., p. 246.

⁴ *Ibid.*, i., p. 219.

walls of the epibasal hemisphere of the embryo. This position of the apex of the axis remains the same though the appendages may vary greatly in their number, their position, and their relative time of development. It is also important to observe that the cotyledons show a constant orientation to this point, as to a relative axis, whether or not the apex of the axis is early developed as an obvious cone. These relations appear to be the most constant among the other fluctuating features of the various types of Pteridophyte embryos: the theory of the strobilus contemplates the phyletic pre-existence of the axis: the early and constant definition of the polarity thus seen in the primary embryology is a material fact in relation to that theory.

Goebel further enforces the point that differentiation of the primarily similar cells of the embryo takes place gradually, and that the actual distinction of the organs begins only late, even though the arrangement of the cells may allow of their position being recognised at an earlier period. The actual time of their distinctive development may vary in different cases, and it is often possible to correlate this with the biological requirements; for instance, the Fern-prothallus is a limited body, with small powers of nutritive supply: it is therefore essential that the young Fern-plant shall soon establish itself, and accordingly its parts, especially the leaf and root, are rushed forward comparatively early. In the case of bulky prothalli with large reserves of nutrition, on the other hand, such as those of the Lycopodiaceae and Ophioglossaceae, the parts of the embryo are differentiated relatively late, not being required for immediate action. But even within near circles of affinity there is considerable variety in the time of appearance of the organs of the embryo. Jeffrey points out how in *Marattia* and *Angiopteris* there is a precocious development of the cotyledon, while in *Danaea* it is the root which first shows prominently.¹ A somewhat similar state of affairs is seen in the Equisetaceae, where *E. arvense* and *hiemale* have a precocious root, while in *E. limosum* and *palustre* the root is of later appearance. Among the Ophioglossaceae, in *O. pedunculosum* the cotyledon first emerges, while in *O. pendulum*, *vulgatum*, and in *Botrychium Lunaria* and *virginianum* the root takes the lead.

Lastly, there is variability in respect of the suspensor. It is present in *Lycopodium* and *Selaginella* but absent in *Isoetes*. It is absent in all *Equiseta* and Ferns, and in all Ophioglossaceae hitherto observed, excepting *Botrychium obliquum*, according to H. L. Lyon.² It thus appears that within near circles of affinity there is usually constancy of the suspensor, but that exceptions may occur even within the single genus.

There is thus a considerable latitude of detail in the development of the embryo in Pteridophytes, and even within near circles of affinity. In face of this, the whole conception of embryology should be more plastic

¹ *Gametophyte of Botrychium virginianum*, Toronto, 1898, p. 18.

² *Bot. Gaz.* vol. xl., p. 455.

than has often been assumed, and comparative arguments based on embryological facts must be used with the greatest caution.

The independence of origin of the separate parts thus seen in some degree in the embryo calls for further consideration, since it is shown also elsewhere than in the normal embryo, and it will affect in some degree the conception of the nature of the parts of the plant. It is a common experience in the plant at large that roots may arise independently of other parts: frequently their occurrence is irregular both in number and position, and this finds its illustration in almost all the large groups of plants. Goebel¹ quotes examples of "free-living" roots, which do not spring from a shoot at all, in *Pyrola* and *Monotropa*: he regards these as derived from the normal in accordance with the saprophytic mode of life of these plants. A very peculiar illustration of the detachment of origin

of roots is shown in the abnormal cases of apogamy described by Lang (Fig. 93); for here numerous roots were formed independently of any other parts of the sporophyte: thus the idea of detachment of the root is already a familiar one. On the other hand, the current conception of the leaf is of a part in close genetic connection with the axis: but this also has been shown by Goebel to be open to exceptions. He describes cases of free-living leaves.² The old

morphological dogma asserted that a leaf could only arise out of the vegetative point of a shoot: but Goebel accepts the facts disclosed in *Lemna* and *Utricularia*, as well as the condition of the embryo in many Monocotyledons, as overthrowing this dogma. In the latter case the cotyledon arises without any vegetative point of an axis being visible. He also quotes the case of *Adiantum Edgeworthi*, a Fern which produces buds at each leaf-tip.³ This case I regard as being important for comparison with the condition seen in embryos: for according to Goebel's description and drawings (Fig. 94), the first leaf of the new bud arises not from the



FIG. 93.

♁ *Scolopendrium vulgare*. Prothallus from the branched cylindrical process of which ten roots arose: eight of these are visible in the drawing. ♂ about 6. (After Lang.)

¹ *Organography*, p. 234.

² *L.c.*, p. 235.

³ *L.c.*, p. 241. See also Kupper, *Flora*, 1906, p. 337, who found that in *Adiantum*-species three, and in *Ancinmia rotundifolia* even six leaves originated before the stem-apex was defined.

leaf-tip which supplies the apex of the new bud, but from a position near it upon the convex side of the mother-leaf. As Goebel remarks, this finds its parallel in the formation of the embryo and in the apogamous origin of a Fern-plant on a prothallus. Through such examples we arrive at a conception of a leaf also as a part which may be at times of independent origin, and not necessarily produced from a pre-existent and obvious axis. But the cases above quoted from mature plants are almost certainly secondary, and are probably consequent upon peculiar conditions of life. The question then presents itself whether the independent origin of a leaf as it is seen to occur in certain embryos is not also a secondary condition in descent, and a consequence of what might be called anticipatory development of that part of the shoot, to meet such early biological needs as that of assimilation or of storage? It is impossible to answer such a question with any approach to proof: nevertheless the case of *A. Edgeworthi* is

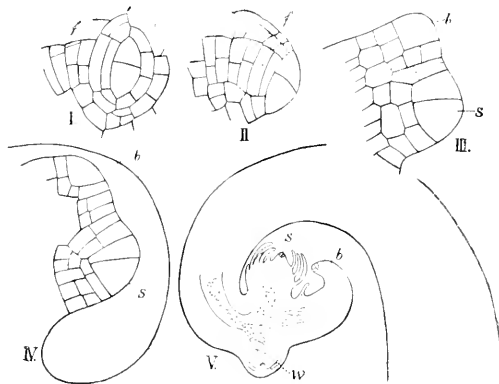

FIG. 94.

Adiantum Edgeworthi. Origin of leaf borne buds. I. = apex of leaf seen from above: the apical cell has divided by a cross-wall. f. = position at which the first leaf of the bud arises. f. = position of origin of the lateral leaf-series whence usually in a leaf the pinnules develop. II. Apex of leaf seen from the side, lettering the same. III. Apex of leaf in optical longitudinal section: s = divided apical cell; b = first leaf of the bud. IV. Somewhat older stage. V. Apex of leaf in longitudinal section: s = apex of bud surrounded by scales; b = first leaf, looking like the continuation of the mother-leaf; w = incipient root. I-IV, highly magnified. V, less highly magnified.

embryogeny of the Lycopods, a family in which the diversity of character of the prothallus has imposed considerable and instructive differences of development upon the embryo. Meanwhile I see no sufficient reason, on the ground of their position or the mode of their origin, to regard the "cotyledon" or "protophyll" as representing a category essentially apart from foliage leaves:¹ nor does the apparently independent existence of

¹ Goebel, *Organography*, ii., p. 400, remarks specifically for Pteridophytes that the cotyledons "are without exception arrested forms of foliage leaves": he extends the conclusion also to Seed-plants (p. 402).

very suggestive of such a detached and anticipatory development of an individual part. Clearly the early appearance of a leaf in the Fern-embryo would be an advantage, while the axis is in no way essential for the performance of its first functions. If such be the origin of the first leaf or leaves of a sporophyte embryo, then so far from their independent position being, as is usually assumed, the primitive position, it would be secondary, a mere result of adaptation to the early requirements of the embryo. This question will be specially studied later in connection with the

cotyledons or protophylls raise any insuperable obstacle in the way of a theory of the strobilus as stated in a previous chapter, so long as they are held to be anticipatory growths in the sense above explained.

From the above pages it will be seen that the foundations of recent or current embryology of the sporophyte are open to criticism. The analogies with animal embryology are misleading: strict recapitulation is not to be assumed where, as in plants, continued embryology holds sway: segmentation appears to be a phenomenon connected in no obligatory sense with the origin of organs: the relative position of the parts of the embryo, though it may be fairly uniform in circles of near affinity, is variable according to biological requirements which are readily intelligible in the establishment of the germ: the relative time of origin of the parts may also be variable, even within circles of near affinity. The question will therefore be what weight in our comparisons is to be accorded to these somewhat fluctuating facts of the primary embryogeny of the sporophyte? They have been very highly estimated in the past: while not denying their value, I think that they have been given altogether undue precedence over the characters of the sporophyte which appear later, and this opinion is based both on general considerations and on detailed comparison. According to the view of alternation advanced above, there does not appear to be any sufficient reason for attaching special comparative importance to the initial steps of the primary embryology. If it had not been for the recapitulation theory of the zoologists, it is improbable that this position would ever have been adopted in the case of plants. The more natural inference from the facts would probably have been the converse, that is, to attach greater weight to the characters of the mature shoot: in fact, the position now is that the embryogeny must be interpreted in terms of the mature plant rather than the converse which a recapitulation theory would demand. For the reasons thus stated the initial embryogeny of the sporophyte will be accorded only a minor place in our comparisons: when once the earlier, and in considerable degree adaptive embryonic phase is past, and the form characteristic of the mature plant is by way of being established, this would seem to be a more reliable basis for comparison than any minute details of the initial embryogeny.¹ Probably the strobilus itself will give the most trustworthy basis of all.

But it is not to be concluded that recapitulation plays no part whatever in the development of the sporophyte. Seedlings of many plants with highly specialised shoots, such as the phyllodineous *Acacias*, and spinous plants such as *Ulex*, start with a postcotyledonary shoot of simple and not specialised form, characteristic of the group to which they belong: they only assume their peculiarly adaptive character later. They thus reflect in some degree in their ontogeny the history of their specialisation. Such facts are familiar, and the interpretation generally accepted. But

¹ Miss Thomas (*New Phytologist*, 1907, p. 77, etc.) has expressed a similar view as applied to the embryogeny of Angiosperms.

it does not follow from its acceptance in these cases that a theory of recapitulation can be applied consistently, or in detail, to all phases of development, or that evidence of it is to be found necessarily in the earliest steps of the embryogeny. It remains for the morphologist to draw for himself the reasonable limit of its application. If this be done, and especially if the variability which exists be duly appreciated, then the early stages of the initial embryogeny of the sporophyte will take their right place: and recapitulation will be traced as a limited phenomenon, only, applicable, it is true, to the case of relatively recent adaptations, but not with equal certainty to the far-away facts of the past. For reasons such as are explained in this chapter, it will not be assumed that plants so diverse as are the main groups of Archegoniatae show in their early segmentation, or in the initial form of their embryos, any detailed reflection of ancestral characters. The facts observed should be used with the greatest caution, especially where the comparisons are made between representatives of phyla which must have diverged early from some primitive stock, if indeed they be related at all.

Certain points touched in the above discussion will help towards an understanding of the relations of sporophylls and foliage leaves to the first leaves of the embryonic plant. In Chapter XIII. it was concluded that in certain cases at least foliage leaves are to be held phylogenetically as sterilised sporophylls: and the question remains whether or not all non-propagative leaves, including the cotyledons themselves, originated in this way. There seems to be a high probability that in the Pteridophytes they did. There is no reason to hold that their first leaves differ in any essential point from those which are formed later: frequently they resemble the later leaves closely in outline; but they are sometimes characterised by peculiarities of form, though these are less marked than in the cotyledons of Phanerogams. Sometimes the first leaves in Pteridophytes arise laterally on an axis already defined (*Equisetum*); but in other cases, and especially in the megaphyllous forms, the first leaf or cotyledon may appear prior to any definite outgrowth of the axis itself. This fact may be held to be in itself an inherent objection to ranking the cotyledon as the equivalent of a foliage leaf which arises from the axis: but this objection is met by the fact that free-living leaves, apart from any obvious existent axis, do occur elsewhere in certain specialised cases: these may be interpreted as originating by an anticipatory development, though still in relation to an axis not yet defined by external growth. And so also the cotyledon in the Fern may be held to be essentially an appendage of the axis, the central point of which is already defined in close relation to the intersection of the octant walls of the epibasal segment, but not characterised as yet by external growth: the cotyledon, on the other hand, is hurried forward precociously in its development to meet the physiological need for nutrition, but maintains nevertheless its orientation relatively to the deferred axis.

This precocity, however, does not alter its nature as an early foliage leaf, bearing essentially the same relation as others do to the sporophylls, and to the relative axis.

In support of this conclusion it may be noted that, according to Prantl, even the primordial leaves of *Lygodium subulatum* are sporophylls, so that sterile leaves do not exist at all in that species.¹ No more complete demonstration is possible than this of the correctness of the conclusion that the cotyledon is the equivalent of the foliage leaf, and of the sporophyll. The position at which we arrive is then this: that foliage leaves are sterilised sporophylls, and the protophylls or cotyledonary leaves are further modifications of the same type. In fact, all those parts which are commonly styled "leaves" on the Pteridophyte plant belong to the same category, but differentiated to meet special needs.

¹ *Schizoclelea*, p. 14.

CHAPTER XV.

ANATOMICAL EVIDENCE.

IN the previous chapter it has been shown that early embryological detail is an insecure guide for purposes of comparison: that segmentation is not related with any general constancy to the origin of the appendages: also that the anatomical regions of the mature part are not defined with any constancy by early segmentations at the apex. It remains to enquire in what way the anatomical characters of the mature parts will affect the questions discussed, and especially whether they tend to support or to refute the strobiloid theory as put forward in Chapter XI.

The most pregnant change in anatomical view effected during the last half century has been caused by the introduction of the Stelar theory of Van Tieghem. Prior to it the individual vascular strand, pursuing its course from the appendage into the axis, was regarded generally as the structural unit of the vascular system of the whole shoot. This was a natural consequence of that detailed investigation of the course of the individual vascular strands which was initiated with such success by Naegeli, and extended by many other writers. The position taken up by these observers is admirably summarised in the *Comparative Anatomy* of De Bary: from his account it will be seen that the method of anatomical study, as well as its result up to 1877, was such as to give prominence to the individuality of the leaf: the facts as there stated might almost be read as an expression of phytomic theory in terms of internal structure, since the chief aim was to follow downwards to its termination each individual strand of the leaf-trace. A phytomic view of the facts was never explicitly set down by De Bary, though the under-current of thought seemed clearly to lead to an analytical rather than an integral view of the construction of the shoot.

But very soon this was corrected, on general and external grounds rather than on those of anatomy, by Sachs: for in his *Lectures on the Physiology of Plants* (1882), he strongly insisted on the contemplation of the shoot as a whole. It is impossible to say how far this may have

influenced the thoughts of Van Tieghem, and stimulated him in the direction of his later generalisation; but it may be remarked that what Sachs did in urging the integral view of the shoot on more general grounds, Van Tieghem, by his introduction of the stelar theory in place of the mere study of the individual vascular strands, did on a basis of anatomical investigation. Both of these reforms tended in the same direction, viz. towards the conception of the shoot as a whole, with axis and leaf as its constituent parts. It may be said that any step of observation or of reasoning which tends to emphasize the primary individuality of the leaf, leads towards some phytonic theory of the shoot at large: any step which tends to emphasize the primary individuality of the axis leads towards some strobiloid view. The effect of the stelar theory of Van Tieghem has been in the latter direction. The recognition of the vascular column of the axis as a structural unit of the conducting system has gone far towards the reinstatement of the axis on the basis of structure, as a substantive and essential part of the shoot; and the change of view has been in opposition to those phytonic theories which would regard it as a mere congeries of leaf-bases. It will accordingly be important to consider this matter carefully in its bearings on the general theory of the shoot in the sporophyte.

Van Tieghem recognised the central cylinder of the axis in the great majority of plants as an anatomical region coordinate with the anatomical regions of the cortex and the epidermis, which lie outside it: he designated it the stele. This cylinder is delimited by certain continuous sheaths: the inner, the pericycle, belongs typically to the stele: the outer, the endodermis, belongs to the cortex: the boundary of the tissue held to be stelar is the surface between these contiguous layers. The stele thus defined consists of vascular tissue—xylem and phloem—and of conjunctive tissue—usually parenchyma. In certain plants throughout, and in certain regions of other plants, the structure of the vascular tissue of the axis is relatively simple and compact, consisting of a solid central core of xylem, with a peripheral band of phloem: this was probably the primitive or original type, though it may also result, as in some well-known cases, from reduction: it is designated the protostele. But in very many shoots the type of stele is more bulky owing to the presence of parenchymatous tissues: the vascular tissue may thus be separated into distinct strands, and in that case they are usually arranged with a radial symmetry and embedded in the conjunctive parenchyma: this tissue occurs partly as the pith, which occupies all the central region, partly as a lateral and external packing for the several strands. Such a stelar structure, of either the compact or of the more bulky type, is found in the axis and in the root of the vast majority of sporophytes.

Exceptional arrangements exist, however, in certain cases: the most important of these is the polystelic type of stem-construction, which is found in many Pteridophytes and in some few stems of Phanerogams.

It is indicated by the presence in the transverse section of two or more vascular masses, each being constructed and delimited in the same way as the single stele of normal axes. At first it was thought by Van Tieghem that to produce this condition the stele, originally simple, underwent a branching, notwithstanding that the axis in which this would take place remained simple. This suggestion seemed inherently improbable, and it has since been shown by direct examination of specific cases that the real origin of the polystelic state as it occurs in Ferns is by the formation of large leaf-gaps below the bases of insertion of the successive leaves: the steps of increasing complexity of stelar structure in Ferns have been tentatively outlined by Gwynne-Vaughan as follows: The most primitive type of vascular construction was probably the single protosteles, with uninterrupted central xylem, and this is met with in some of the early Fern types in the mature stem, but it is also seen in polystelic types of Ferns at the very base of the young plant. Internal parenchyma then

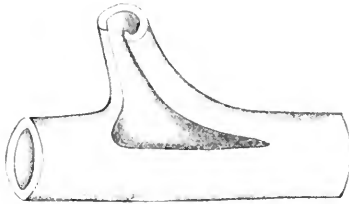

FIG. 95.

Dicksonia punctiloba. Diagram of vascular system of rhizome, including a node and the base of a leaf-trace. The upper surface of the rhizome would face the observer. (After Gwynne-Vaughan)

makes its appearance about the periphery of the protosteles at points just above the departure of the leaf-traces: this advances gradually inwards from these points until the most central region of the stele is affected. A structure resembling a cylinder or, as it is styled, a "solenostele," may then be attained by the gradual differentiation of phloem and endodermis through the leaf-gaps and all round inside of the xylem-ring. Below the insertion of each leaf a large leaf-gap occurs in the solenostele (Fig. 95): in transverse section at such a point the stele will appear as an incomplete ring. If, then, the arrangement of the leaves be a close one, two or more of these gaps would occur in a single transverse section, and the result would be an appearance as of several steles arranged in a ring. These originate, however, not by branching, as Van Tieghem thought, but by resolution of the stele, first into a cylinder and then into a cylindrical network. The result of this mode of amplification would, therefore, be more correctly styled "a dictyostele" rather than a polystelic state, and the parts "meristeles" rather than a plurality of distinct steles, since the whole is a result of amplification, not of branching, of the original monostele.

But polystely is also found in the genus *Selaginella*. There is little doubt that the monostelic type is the original one for this genus also, since it exists in many species. The origin of the more complex state is, however, connected rather with the branching of the axis than with the insertion of the minute leaves. It has certainly taken place within the genus, but the comparative study of the illustrative species from the

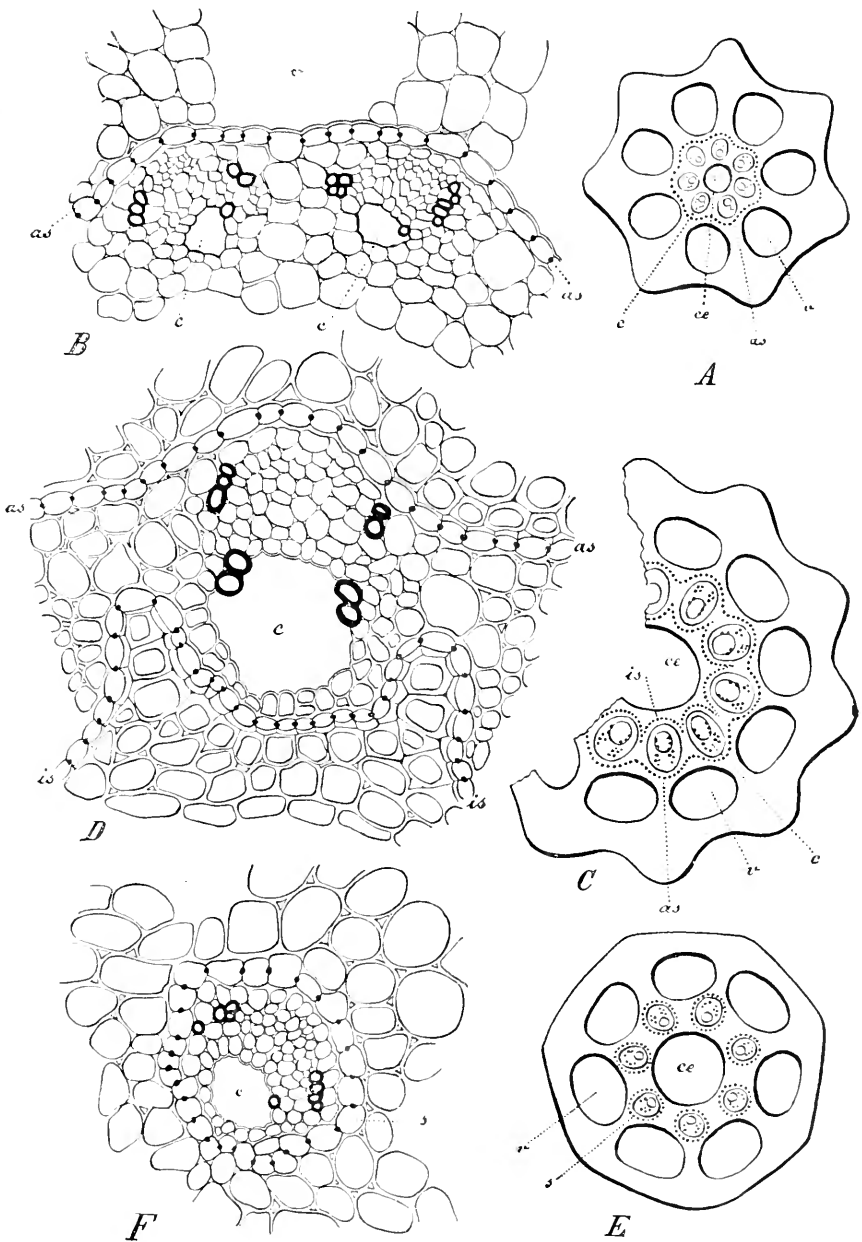

FIG. 96.

A. transverse section of the stem of *Equisetum palustre* ($\times 26$), and *B.* part of it $\times 160$. *C.* transverse section of the rhizome of *Equis. sylvaticum* ($\times 26$), and *D.* part of it $\times 160$. *E.* transverse section of the rhizome of *Equis. litoreale* ($\times 26$), and *F.* part of it $\times 160$. *ce* = central cavity, τ = vallecular canals, *c* = carinal canals, *s* = sheath of separate strands, *as* = outer, *is* = inner general endodermis; in *A.*, *C.*, and *E.* the endodermis is indicated by a dotted line. (After Pfitzer.) From *Rab. Krypt. Flora*.

developmental point of view is still required before a complete elucidation is possible. The case for *Medullosa* must also remain for the present unexplained; but at least it seems almost certain that it is not a polystelic condition arising from overlapping of leaf-gaps, as in Ferns.

Among Phanerogams the polystely in *Auricula* has been investigated by Gwynne-Vaughan, and the origin of it is again by a resolution of a primitive monostele. Perhaps the same may be the case for the more complex condition of *Gunnera*, but that is still uncertain. Of these isolated cases of polystely which exist among the vast majority of monostelic forms the Ferns are the most important: and as their case has been shown to be a result of amplification of the monostele, the existence of occasional exceptions elsewhere, not yet fully explained, cannot be held as a valid objection to the acceptance of the monostele as the fundamental type of structure in the sporophyte at large.

Another mode of amplification of the protostele is exemplified by Lycopods, and possibly occurs also elsewhere: it is by the progressive conversion of a central tract of the xylem-core into parenchymatous tissue of the nature of a pith. This is probably related to another modification of the stelar structure found in stems, viz. that designated the *schizostelic*, or by some the *astelic*, state. Here the several vascular strands are not collectively surrounded by an endodermal ring, but are independent, and may have a special endodermal sheath surrounding each. This structure is found in some species of *Equisetum* and in certain Phanerogams. It seems to be generally admitted that in the stem this condition is derivative from the ordinary monostelic state, a conclusion which would naturally follow in the case of the genus *Equisetum* from a comparison of its different species (Fig. 96). If this be so, then both the marked exceptions in vascular structure in the stem are referable in origin to the usual monostele, and the conclusion seems justified that in the axis of Vascular Plants there is only one fundamental stelar type, and that is the monostelic type. The morphological importance of any character is held to be in accordance with its constancy in a large series of allied organisms: the general occurrence of a monostelic structure, or of arrangements derivative from it in Vascular Plants at large gives the monostele a place in the first rank as an internal morphological feature of the axis.

The prevalent bifacial character of the leaf is apparent in the simplest forms of Vascular Plants, where its comparatively small expanse is traversed by a single vascular strand. This structure is found in such primitive types as the Lycopods, *Equiseta*, *Isocetes*, etc. Where the leaf is larger the vascular system is expanded in various ways: numerous strands may traverse it, diverging from one another towards the margin, but converging towards the base, where, with or without fusions, they may form a curved series as seen in transverse section (Fig. 97). The orientation with the protoxylem tending adaxially is a [constant feature. Each strand is surrounded by a definite sheath throughout its individual course, but on fusion two

or more may pass within a common sheath: a flattened vascular plate, or it may be a curved series of strands, is thus produced. In some leaves of Ferns and in some Dicotyledons the vascular tissue thus disposed in a curve as seen in transverse section, with its concave surface upwards, may show a closing in of the lateral margins as the leaf-base is approached; it seems not improbable that this is connected with mechanical requirements consequent on the leverage of a large leaf on its base. This closing in may even be carried so far that the two edges may become contiguous, and the result will be a structure not unlike that of a cylindrical stele of the axis (Fig. 98). But it would be a mistake, on the mere ground of such structure and without the check of comparison, to suggest any close identity of character of such "pseudosteles" with the stelar condition of the axis. There is reason to believe that these pseudosteles of the leaf are secondary

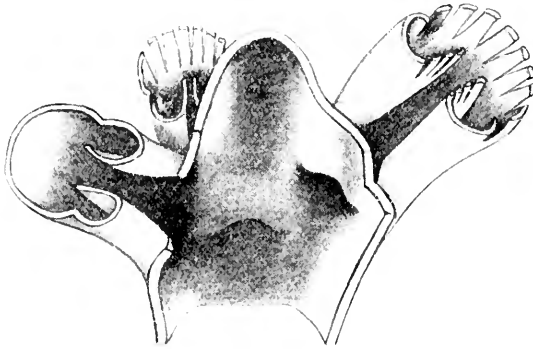

FIG. 97.

Dicksonia Barometz. Portion of the vascular system of the stem, seen from within, and showing the departure of three leaf-traces. (After Gwynne-Vaughan.)

in their origin, for it is the fact that they are characteristic of leaves of relatively large size, while smaller leaves are typically dorsiventral in their vascular structure. Moreover, Professor Bertrand and others have been able to show by exact comparative analysis that even in very aberrant cases of Fern-petioles the pseudostelic structure is referable still to a dorsiventral origin, and is to be explained as the result of complex foldings and fusions of a band-like vascular tract. A somewhat similar explanation may be given of the "pseudostelic" petioles of such Dicotyledons as are quoted by Schoute (*l.c.*, p 158) and of the "polystelic" petiole of *Primula Auricula* examined by Gwynne-Vaughan; these may be held to be secondary modifications of a structure originally dorsiventral, and the position may accordingly be summed up as follows: The construction of the axis is essentially cylindrical, and finds its anatomical expression in the cylindrical stele; the construction of the leaf is essentially dorsiventral, and it finds its anatomical expression in the isolated vascular strands disposed dorsiventrally. Both these are liable to modification in special cases, thus by

breaking up of the stele in certain axes a schizostelic state with individual strands may be attained; but comparison shows that these are not the phylogenetic equivalents of the individual strands of the simple leaf, though they may be continued outwards into the leaves: conversely, in the progressively developing leaf, a pseudostelic structure may be produced by fusion of strands phylogenetically distinct: but again comparison shows that this is not the phylogenetic equivalent of the primitive stele of the axis, but a condition secondarily derived.

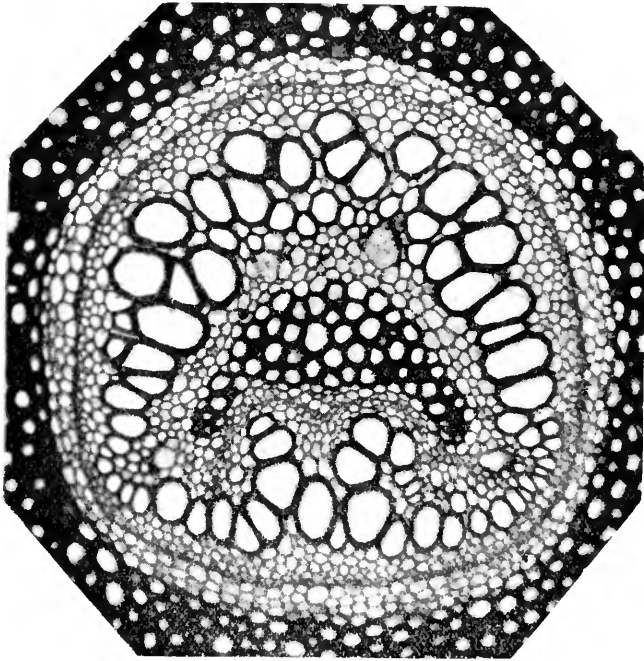

FIG. 98.

Transverse section of base of petiole of *Glischia dicarpa*, showing a pseudo-stelar structure resulting from contraction of horse-shoe-like xylem till the margins fuse. Photograph by R. Kidston from section by Gwynne-Vaughan.

It is necessary thus to differentiate characters which are primary from those which are secondary. It has long been recognised that the distinction cannot always be maintained between axis and leaf on the basis of strict criteria of form or structure: exceptions can be found to all morphological criteria proposed. Still, if on a basis of comparison the primary and secondary conditions be clearly kept apart, the divergent anatomical characteristics of the two parts become sufficiently obvious. Accordingly, in our view the structure of the leaf is recognised as primarily *astelic* throughout, that is, the isolated strands are not to be held as results of resolution of a primitive stele: where an apparently stelar structure appears

in the leaf it would at best be only a *pseudostele*, secondary in origin, and thus phylogenetically distinct from the stele of the axis. The primary structure of the axis is *monostelic*: where isolated strands occur in the axis, each with its sheath is a *schizostele*, a result of secondary segregation of the component tissues of the stele.

In this connection it is important to recall the old distinction between “common” and “cauline” vascular bundles. In the former the lower part of the course of the individual strand is in the axis, the upper extends into the leaf: in the case of the tissues which may be styled cauline, the course is within the stem throughout. From a theoretical point of view the existence of cauline vascular tracts is important, for it accentuates the axis as something more than a mere basis for insertion of leaves. The further fact that the axial stele may be followed beyond the youngest leaf-traces shows that the vascular system of the axis has an objective existence independently of the leaf-traces, however closely it may be connected with them in ordinary cases. These cauline extensions are prevalent in early Pteridophytes, such as Lycopods, Psilotaceae, and Ferns; this fact must necessarily be of special interest in connection with any theory of the origin of foliar developments in Vascular Plants.

It is evident that the existence of a cauline stele bears directly towards a strobiloid theory of the shoot. This suggests the question whether any existing group of plants show a nascent condition of the vascular system of the shoot such as a strobiloid theory would demand, viz. a columnar conducting stele, with no appendages, or with appendages anatomically accessory to rather than formative of the central stelar column. In a paper on the conducting tissue-system in Bryophyta, Tansley has shown that such a structure is found in the more complex Mosses.¹ In discussing the points brought forward he very properly disavows at the outset any strict homology with Vascular Plants, remarking that it is almost as certain as any phylogenetic thesis is likely to be that the conducting tissues of Bryophytes have nothing directly to do with the origin of the conducting tissues of the higher plants. The main seat of the development of these tissues in Bryophytes is the gametophyte generation, which is in any case excluded from the comparison, since the vascular system in Pteridophytes is confined to the sporophyte. And at the least it is extremely unlikely that the Pteridophytes have been derived from a Bryophytic ancestor with a sporophyte showing anything approaching the specialisation of the moss-sporogonium, in which conducting tissues also occur. But it must not for this reason be supposed that the Bryophytes are of no interest in considering the problem of the evolution of the vascular system in Pteridophytes.

¹ *Ann. of Botany*, xv., 1901, p. 2. For Mr. Tansley's later views on this and kindred subjects, especially as affecting the question of origin of the shoot in the Filicales, reference should be made to his Lectures (*New Phytologist*, 1907). This chapter was in type before Mr. Tansley's lectures were given. The opinions here expressed may have to be modified.

We see among the former group plants in the very act, so to speak, of developing a conducting system in response to vital needs, and others in the most various stages of its evolution in complexity. The conditions under which this evolutionary development occurred must have been practically identical with those to which the primitive Pteridophytic sporophyte was subjected.—gradually increasing adaptation of a simple leafy form to terrestrial life. And the final result, as seen in the highest Polytrichaceae, is so strikingly like the state of things obtaining in the true vascular plant as to furnish probably one of the completest and most interesting cases of homoplastic development in the plant-kingdom. It can hardly, therefore, be denied that the study of the conducting system in Mosses is calculated to throw most valuable side-lights on the question of the evolution of the vascular systems of the higher plants.

As the result of his careful analysis of the tissues, Tansley¹ concluded that the highly developed Polytrichaceous stele is in the aerial stem essentially double in nature and phylogenetic origin, consisting (1) of a central primitive hydrom-cylinder originally developed, and still serving to supply the apical bud, sexual organs, and sporogonium with water; and (2) of a double peripheral mantle of hydrom and leptom separated by a starchy hydrom-sheath, and all three layers composed of the joined bases of leaf-traces, and designed between them to conduct water to and formed material from the leaves.

The bearing of these considerations on the problem of the nature and origin of the primitive stele among the Pteridophytes, as we find it, for instance, among the Sphenophyllales and Lycopodiales, is a very interesting question. Two alternative explanations of such a stele are possible. According to a strobiloid theory, we may suppose the primitive Pteridophyte descended from a form bearing a terminal fruit-body; this contained a primitive hydrom-stele comparable with that of the Mosses, but supplying the fruit-body directly, since it is developed in the sporophyte, instead of merely leading up to the base of the sporogonium. The lineal descendant of such a primitive hydrom-stele would then perhaps be seen in the central metaxylem of, for instance, *Sphenophyllum*, *Cheirostrobos*, the *Lepidodendra* with solid steles, the monostelic *Selaginellas*, and (modified in various ways) in *Psilotum*, *Lycopodium*, etc. (Fig. 99). Added to this would be the bases of the leaf-traces represented by the peripheral protoxylem-strands, and only evolved after the primitive sporophyte had thrown out leaves requiring a vascular supply connected with the main channel of the stem. The fact that they appear before the central xylem in the development of the individual stem would be merely in relation to the need for the early establishment of conducting channels to the leaves—a need which is universal in leafy vascular plants.

On the other hand, under some phytotic theory we might suppose that the formation of leaf-structures requiring a vascular supply preceded the

¹ *l.c.*, p. 35.

formation of a regular stele: in which case the leaf-traces, represented in the first case by the protoxylem-strands, would be phylogenetically prior: the central metaxylem, on the other hand, would be a later formation, developed in the larger forms to furnish additional conducting channels to

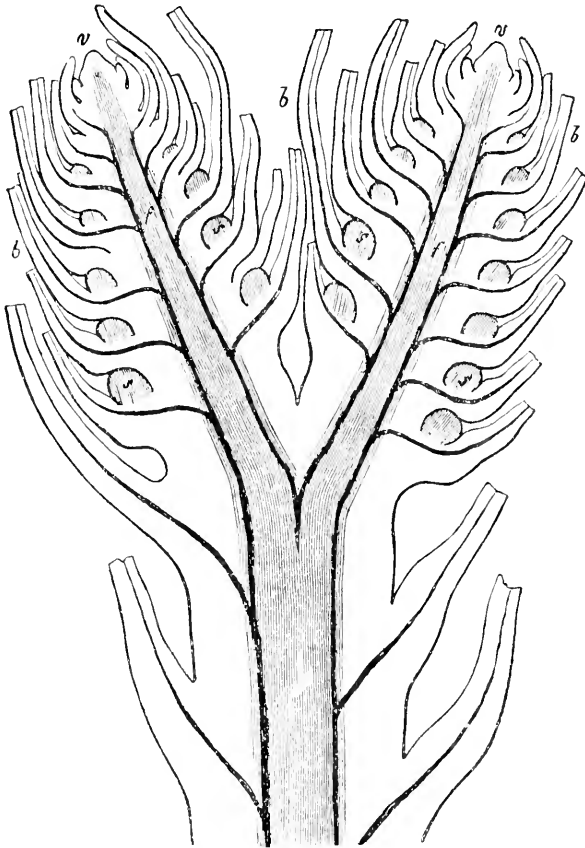

FIG. 93

A forked sporangiferous branch of *Lycopodium chamaecyparissis* in longitudinal section, slightly magnified. *ff*=the axile vascular body. *bb*=leaves. *ss*=young sporangia.

supplement the protoxylems in supplying the needs of the higher foliage leaves and sporophylls.

In approaching an opinion on such a question much will turn upon the initial relation of the leaf to the axis in the evolution of the leafy sporophyte, a matter already discussed in Chapter XI. If the leaf were from the first a preponderating influence in the shoot, then the latter explanation

would be the more probable: if the leaf were initially a minor appendage, then the former of the two explanations suggested by Mr. Tansley will naturally follow. The facts are not decisive in indicating either of these alternatives; but a comparative study of the vascular relations of leaf to axis in the earlier leafy sporophytes will throw a valuable side-light upon the question. Dr. Jeffrey¹ has distinguished two main types of relation between the vascular supply of the leaf and the vascular system of the axis. The one type he styles "cladosiphonic": it is characterised by the insertion of the leaf-trace on the periphery of the axial stele, which is itself hardly disturbed at the point of junction (compare Figs. 71 and 99). This is clearly the anatomical expression of the dominance of the axis in the shoot, for the leaf-trace is added as a mere appendage on the periphery of the otherwise cauline stele. In this respect the structure is like that described for some of the larger Mosses. This condition is characteristic of the Lycopodiales, Equisetales, and Sphenophyllales; all of them small-leaved forms, and of early occurrence in the scale of vegetation: and there is good reason to believe that it is a really primitive condition in these early Pteridophytes.

The other type recognised by Dr. Jeffrey is the "phyllosiphonic," which is characterised by the profound disturbance of the vascular tissues of the axis at the point where the leaf-supply is inserted: so much so that a distinct leaf-gap is produced, and connection may be established at that point between the central and peripheral tissues (compare Fig. 95). This is the anatomical expression of the dominance of the leaf over the axis in the shoot, and it is characteristic of certain large-leaved Pteridophytes, and is also general in Seed-Plants. As regards the latter, it has already been seen in Chapter XI. that certain of the Gymnospermic Seed-Plants have probably been derived, with progressive leaf-production, from a Filicéan ancestry: their phyllosiphonic character supports this view, which is, however, based upon a wide area of comparison on other points besides. It may be held as probable that the seed-bearing plants at large were developed from a large-leaved ancestry, having undergone reduction of leaf-complexity in the course of their evolution. But while we thus recognise a probability of a widespread reduction producing relatively small-leaved forms, it does not follow that all smaller-leaved forms originated thus: and the anatomical and palaeontological facts together make it probable that such small-leaved forms as the Lycopodiales, Equisetales, and Sphenophyllales were primitively small-leaved.

It has been remarked in Chapter XI. that in the individual life, one or the other anatomical character is usually constant: this is true for the mature structure, but the transition from the cladosiphonic to the phyllosiphonic may frequently be traced as the young plant of the latter type passes to the mature state. It has been shown very clearly in the case of *Alsophila excelsa* by Gwynne-Vaughan (*l.c.*, p. 710) (Fig. 100): here the

¹ *Mem. Boston Soc. of Nat. Hist.*, vol. v., No. 5, 1899.

axis is protostelic at the base, and the first leaf-trace may depart without in any way altering the structure of this stele, thus showing the cladosphonic character. It is only subsequently, by the overlapping of those intrusive pockets of phloem and endodermis which accompany the exit of the leaf-trace, that a gradual transition is effected to the phyllosiphonic type. Thus the anatomical evidence indicates a probability that, even in large-leaved Ferns, the cladosphonic was the primitive type; but that the phyllosiphonic, once initiated, is as a rule maintained: this is shown by its persistence in the Seed-Plants, even where the leaf has been reduced in size. Accordingly the trend of anatomical evidence is towards the recognition of a small-leaved, strobiloid type of construction of the primitive sporophyte.

It may be objected that in certain Pteridophytes the condition of the embryo is such as to militate against any strobiloid theory, and that their anatomical details offer as great an obstacle as their external form. The cases which will be cited are those of some Lycopods, in which the first leaves are isolated, and show no vascular connection with the later-formed leaves (Fig. 101): or my own observations on *Phylloglossum* may be held as a valid objection, for there also a single vascular strand has been observed passing down in one case directly from a protophyll into a root, without any relation to the other members.¹ Such cases may be held to establish the individuality of the leaf anatomically before the axis has any existence. In the interpretation of these the discussion on embryology in Chapter XIV. should be recalled, and especially the opinion there brought forward that the separation of individual leaves in certain cases from the rest of the shoot is a secondary condition, resulting from what might be called anticipatory development, to meet an early need for an assimilatory mechanism. The inconstancy of detail which is shown by the embryos of *L. ceruuum*, and by the young annual growths of *Phylloglossum*, is in itself a support of this opinion. The vascular supply of the leaves thus isolated is separated it is true from that of the main shoot, but its separateness may be held to be secondary, and not a proper basis for conclusions as to the primitive construction of the vascular system of the normal shoot.

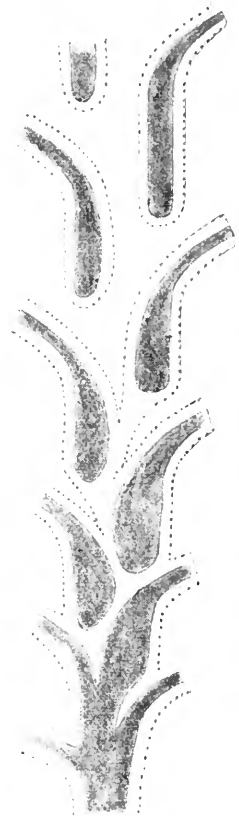

FIG. 100.

Aisophila excelsa. Diagram of vascular system of a young plant in median longitudinal section. The xylem is black, the phloem lightly shaded, and the endodermis is indicated by a dotted line, the ground-tissue is left white. (After Gwynne-Vaughan.)

¹ *Phil. Trans.*, part ii., 1885, Plate 73, Fig. 42A.

It appears, then, that the anatomical evidence is consistent with the early existence of a small-leaved type of shoot in Vascular Plants. Comparative anatomists are practically unanimous in recognising the non-medullated monostele as the primitive stelar type, from which the more diffuse vascular types with medulla, and ultimately with separate strands, or it may be a dictyostelic state, were derived. Translated into terms of general morphology, this opinion indicates a primitive state where the axis was structurally dominant in the shoot. The derivation of more complex anatomical arrangements from the non-medullated monostele suggests an

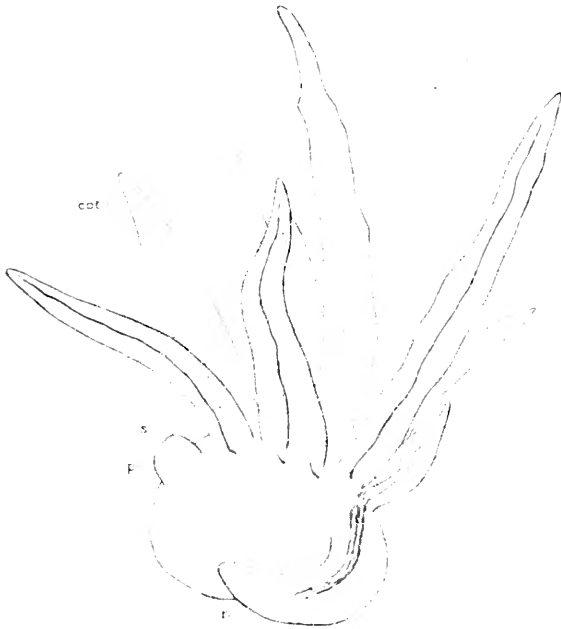

FIG. 101.

Embryo of *Lyxophodium cornuon*, after Treub. *s*=suspensor. *β*=foot. *r*=root. *cot*=cotyledon. The numerous protophylls contain each a vascular strand, which is however disconnected from the rest.

increasing influence of the leaf in the shoot at large, which finds its anatomical expression in various types of resolution of the stele into separate strands. The general conclusions from anatomy thus appear favourable to a strobiloid theory of the shoot, and lead us to contemplate a primitive condition, in which the axis was the dominant factor and the appendages of subordinate importance. And as this coincides with the story of individual development of the leaf upon the axis in all normal shoots, that coincidence should go far in supporting a strobiloid theory of the shoot in the sporophyte generation.

CHAPTER XVI.

SYMMETRY OF THE SPOROPHYTE.

AMONG plants at large various types of symmetry are recognised. The most simple form is the sphere, a type of symmetry without polarity, that is, having no distinction of apex and base: it is the usual initial form of the individual, when it is first delimited as the zygote or the spore. Occasionally this form may be retained to maturity, as in the sporogonium of *Riccia*: but in the vast majority of plants polarity appears early in the individual life, usually with growth localised in relation to it. The body thus produced may develop variously as regards an imaginary axis of construction, which passes between the two poles. Three types of symmetry are usually distinguished where polarity exists: (1) the *radial* construction, where the development is equal in all directions round the imaginary axis: (2) the *bisymmetric* or *bilateral*, in which the construction is flattened equally on both sides: and (3) the *dorsiventral*, where the construction is also flattened, but not equally on both sides, the result being two faces which differ obviously from one another in form, and usually also in inner structure. These types of symmetry may, as a rule, be related to the external conditions under which the parts are developed: thus orthotropous, or vertical parts are almost always radial or bilateral: while plagiotropous, that is oblique or horizontal parts, are commonly dorsiventral, or occasionally bilateral. Dorsiventrality of the shoot, where it exists, has usually some evident relation to the external conditions of life, such as the incidence of unequal lighting, or oblique disposition to the action of gravity: and it may also be seen in lateral branches to be connected with the relation of the part in question to the chief shoot which bears it. In some cases it may arise from inner causes,¹ but investigation has shown that dorsiventrality of the shoot is usually to be referred to some external determining influence.

¹A striking example of this is brought forward by Willis, in the Podostemaceae, where dorsiventrality appears in erect and anemophilous flowers. He suggests that this condition has been forced upon them, without reference to any advantage, by the steadily increasing dorsiventrality of the vegetative system (*Annals of Botany*, 1902, p. 593).

These types of symmetry are not restricted to any of the great groups of plants: examples of any one of them may be found in any of the great divisions of plant-life. But nevertheless, in certain circles of affinity, one or other type of symmetry may be prevalent: thus in the Red and Brown Algae the bilateral symmetry is common: among the sporogonia of Bryophytes the radial construction prevails: the gametophyte of Liverworts is with very few exceptions dorsiventral.

The further fact that a single shoot may be at first of one type, and subsequently change to another type of symmetry, demonstrates that they pass one into another. It can be shown both by comparison and by experiment that this occurs within certain limits. The most frequent transmutation is that from the radial to the dorsiventral, a change which is of special importance in its bearings on the morphology of the sporophyte.

In discussing the subject of symmetry, it has hitherto been usual to draw illustrations indifferently, either from the gametophyte or from the sporophyte generation. Doubtless, in considering the phenomena of form in their general aspects this is right: the wider the net is cast over the area of fact, the greater the probability of arriving at a sound conclusion as to the qualities and the causes of the several types of symmetry in the Plant-body. But it is a different question to enquire into the effect which modification of symmetry may have exercised in the evolution of the neutral generation. Analogy, with corresponding phenomena in the gametophyte, may assist indirectly: but in the elucidation of the actual historical record these can only have a theoretical interest. According to an antithetic theory the starting-point of the two generations has been quite separate and distinct, and this must have its effect on the study of their symmetry.

In the case of the gametophyte various types of symmetry are found in the plants of the present day: and since there is no reason to believe that there was any common origin of all gametophytes from any one body of definite form, there is wide room for speculation as to the source of their varying form, and little hope of finality of conclusion. But in the case of the sporophyte it is different: the ovum, produced within the venter of the archegonium, is normally the starting-point for the sporophyte generation in the Archegoniatae: in these plants it is approximately spherical in form, and the conclusion follows, on comparative grounds, that the initial form of the sporophyte was approximately the sphere—a body without polarity and of radial construction. The question to be discussed in this chapter is, then, what modifications of forms this simple body undergoes in the course of its development into the complex sporophyte, as seen in Archegoniate Plants; and under what circumstances those modifications may have been introduced.

The development might, in the first instance, consist of simple enlargement, together with cell-division, with or without a differentiation

of the products. Such a condition is seen in the spherical sporogonium of *Riccia*, which has habitually been held to be primitive in its simple characters of structure and form (compare Fig. 18). Here there is no polarity: no distinction of apex and base. This character it shares with the earlier stages of some other embryos of Archegoniatae, which enlarge at first as a simple sphere. But a distinction of apex and base soon makes its appearance in all the more complex forms, with or without a localised apical growth. The two great series of Archegoniatae differ widely in the symmetry of their further development. The Bryophyta, with very few exceptions, which will require special consideration, show polarity, but retain their radial symmetry. Not a few of the Pteridophyta also retain their radial symmetry, but under modifications which necessarily follow as a consequence of their leafy habit: others, however, depart broadly from it, some at an early period of their individual life, others at later periods.

The general view which is implied in the preceding paragraph is that the radial type of symmetry is the prior condition for the sporophyte at large. This opinion is not based merely on the fact that the ovum from which all sporophytes spring is spherical. Much stronger grounds are to be found, first, in the high degree of constancy of the radial type of construction in the sporogonia of Bryophytes: while it is also frequent in the Pteridophytes and Seed-Plants, especially in their strobili and flowers. Secondly, in the fact that it is possible in many cases to refer the dorsiventral symmetry, where it exists, to the unequal incidence of external conditions, and to see by experiment how such conditions may bring about some dorsiventral modification of a structure which is in the first instance radial. Examples of this may be quoted occasionally from the Bryophytes, and frequently from the Pteridophytes, and from the vegetative shoots and flowers of Phanerogams. There is thus not only a comparative, but also an experimental basis for the opinion that the radial symmetry is the primitive, and the dorsiventral the derivative condition in the sporophyte.

Few facts relating to any large group of organisms are more impressive than the constancy of the radial symmetry throughout the sporogonia of Bryophytes. That body, originally spherical, becomes more or less spindle-shaped in its later development, with or without a localised apical growth. Zones higher or lower on the spindle-shaped body may undergo more strong development than the rest, especially towards the distal end, which is to be the fertile capsule. This is commonly seen, both in Liverworts and in Mosses, but the Splachnaceae stand out as extreme examples, and in *Splachnum luteum* the apophysis immediately below the capsule is expanded into a wide disc (Fig. 102). Nevertheless, here also the development is uniform all round in any transverse zone, and accordingly the radial construction is accurately maintained. The constancy thus usual for the sporogonium in itself directs attention to

those relatively few cases among Bryophytes where the radial symmetry is departed from.

Among the Liverworts the only recorded example of departure from the radial symmetry is that of *Monoclea*: here the sporogonial head, which is borne upon a cylindrical seta, is curved over to one side, and it dehisces along the upper surface by a longitudinal slit, the whole capsule widening out later into a spoon-like form. Examination of

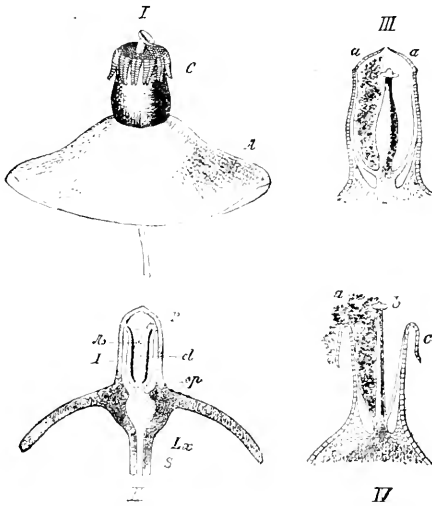

FIG. 102.

Splachnum luteum. I. Capsule open. *A*=apophysis. II. Unopened capsule in longitudinal section. *s*=seta; *Lx*=leptoxylem; *sp*=stomata on apophysis; *c*=columnella; *p*=peristome; *As*=archesporium; *∩*=intercellular space. III. and IV. Diagrams to illustrate the opening of the capsule. (From Goebel, after Hedwig, Vaizey, and Bryhn.)

developmental stages shows that the young sporogonial head is cylindrical in structure. The accepted version of this is that the capsule is developmentally four-valved, but that dehiscence is by one slit only, and accordingly that the four valves remain coherent; but transverse sections of the mature capsule show no evidence of a structural dorsiventrality: the transverse section is radial up to maturity, and there is no apparent structural provision for dehiscence. The natural conclusion will be that *Monoclea* shows only a slight, and ontogenetically late and unimportant deviation from the usual radial type. There are no observations connecting this with external causes.

The sporogonia of most Mosses are also of the radial type throughout: but in a considerable number a more or less marked dorsiventrality is seen in the mature condition. The radial construction is as a rule accurately maintained in those sporogonia which grow vertically upwards, such as *Sphagnum Phascum*, or *Orthotrichum*, and all sides appear equally developed in the longitudinal section (Fig. 103, 3). But in many an unequal development is found, which is in relation to the position which they assume. As maturity is approached they curve to one side, and the capsule becomes oblique, or may even hang over. In these cases the earlier stages of the sporogonium are radially constructed, but an inequality appears on the two sides, with, it may be, a slightly greater development of the assimilating tissue on one side than on the other, as in *Fumaria* (Fig. 103, 5): or this may be carried to such an extent that the sporogonium is markedly lopsided, as it is found to be in the Buxbaumieae (Fig. 103, 8, 9, 10).

An examination of the origin of this dorsiventrality, thus seen in an organ which is as a rule of radial construction, has shown that it appears relatively late in the course of the individual development, and is thus secondary. The young embryo of *Funaria* is a radially constructed spindle, and the inequality only appears as the capsule approaches

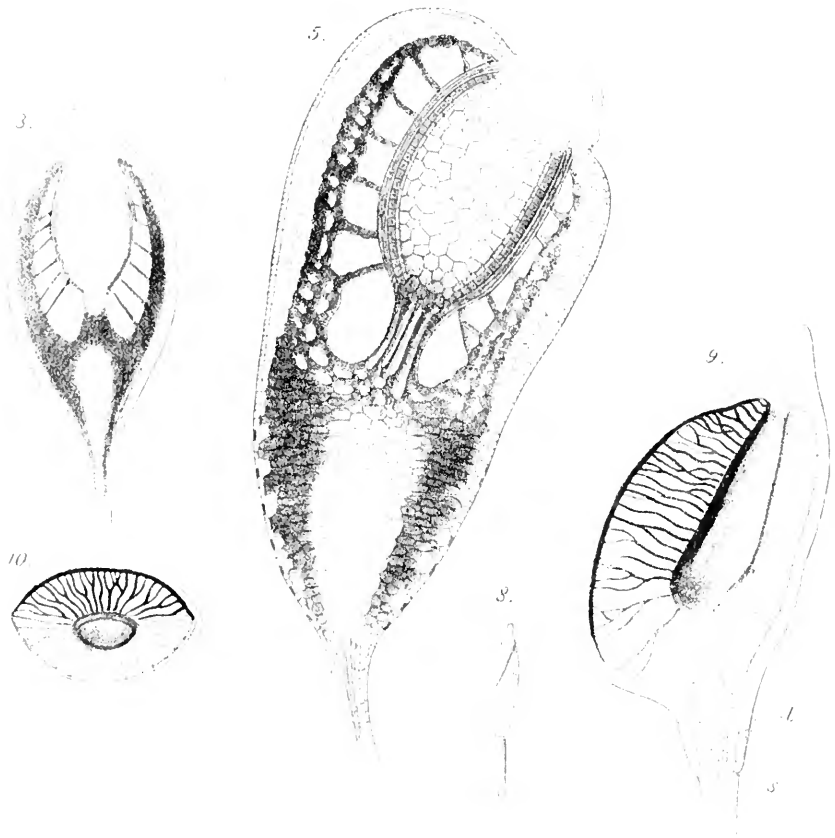

FIG. 103.

1. Diagrammatic longitudinal section through the green capsule of *Physcomitrium pyriforme*. 2. Profile view of mature capsule of the dorsiventral capsule of *Buxbaumia aphylla*. 3. Median longitudinal section through the mature green capsule of *Funaria hygrometrica*. 4. Median longitudinal section of the same capsule; *a*=cylindrical air-space; at *s* the stomata. 5. 6. Transverse section of the same capsule, about the middle. 7. 8. (After Haberlandt.)

maturity. In the Buxbaumieae the dorsiventrality is more marked: the sporogonium of *Diphyscium* shows when young a characteristically radial cell-net; but external examination of even young sporogonia shows that the dorsiventral form of the capsule as a whole can be recognised comparatively early: a condition which accords with its very pronounced lopsidedness when mature. An enquiry into the circumstances which

bring it about has led Goebel to the conclusion that unequal illumination is a determining cause; for he found that in *Diphyscium* the flattening of the unilateral sporogonia always takes place on the illuminated side (Fig. 104). The primary advantage which is gained by the dorsiventral development is the enlargement of the assimilating system. Haberlandt has shown how considerable the assimilatory activity is in the capsule of Mosses, and has specially pointed out in the case of *Buxbaumia* how much more extensive, as well as better stocked with chloroplasts, the enlarged face of the capsule is, than is the side directed downwards.

A secondary advantage is that the oblique position is effective in connection with the scattering of the spores.

Such facts relating to the Bryophyta clearly indicate that the radial type of construction is the fundamental one for their sporogonia. Not only are the departures from that type relatively few, and far from being extreme examples as compared with dorsiventrality elsewhere, but also they may in some cases at least be put in definite relation with external causes, and the altered form be shown to have a favourable biological effect. When to this it is added that the dorsiventrality appears comparatively late in the individual development, the case seems fully made out for the priority of the radial construction of the sporogonium of Bryophytes.

The infinitely greater variety of form among the Vascular Plants in some measure confuses the question of a fundamental type of symmetry

for them. Moreover, the issue is further obscured by the diversity of their embryogeny: so long as the initial characters of their embryos are held accurately to reflect their evolutionary story, this difficulty will remain, but in a previous chapter this doctrine has been held open to doubt. In the present discussion of the symmetry of the shoot in Vascular Plants their embryology will be put temporarily aside, and it will be considered towards the close of this chapter. Questions of symmetry in Vascular Plants are also complicated by the presence of a foliar development. This difficulty will weigh most with those who entertain some pytonic theory of the shoot: but into their difficulties we need not enter, since reasons have been given for not sharing their view (Chapter XI.). Assuming, in accordance with our earlier discussions, a strobiloid theory, the shoot will be habitually regarded as an entity, and its symmetry as a whole will be held to be determined by the equal or unequal development of the appendages, with or without a corresponding development of the axis which bears them.



FIG. 104.

Diphyscium foliosum. Longitudinal section of a stem bearing a sporogonium. The arrow indicates the prevalent incidence of light. (After Goebel.)

In accordance with the general opinions already expressed, it will be natural to take first into consideration the fertile region or strobilus: or in the higher plants the flower, which is held to be its outcome in a more advanced state of development. These may, according to a theory of sterilisation, be held to retain the primitive character of fertility: it will be seen that they are conservative also in their symmetry.

It has become almost a commonplace of the elementary text-books that the radial type of flower in the Angiosperms is the primitive and the dorsiventral (or zygomorphic) the derivative condition. The question of symmetry of the flower has been treated so lately and so well by Goebel¹ that it is unnecessary here to discuss it in detail. He distinguishes two cases: first, that in which the flowers are laid down radially, and become dorsiventral in the course of development—this includes most of the dorsiventral types, and various influences may be recognised as conducing to the result, such as the unequal incidence of gravity and of light. Secondly, he distinguishes that type in which dorsiventrality is brought about before the unfolding of the flower. In this case he is of opinion² that we have in the position of the flower an element of special importance, and the behaviour of the flower in becoming dorsiventral only after unfolding must be taken as a starting-point in any enquiry into this matter. Lateral flowers are in a different position with regard to external forces from terminal flowers. According to the sensitiveness of the former to external factors the configuration of the flower will be changed more or less early. Such changes may become inherited, and flowers so changed will be, of course, favoured over others, and many of their parts will be aborted as useless members after the introduction of dorsiventral structure. In this connection the fact is of importance that in plants normally with zygomorphic flowers, when a terminal flower appears, it is frequently of radial type, or is, as it is termed, peloric. Goebel remarks,³ "No doubt these wonderful forms of flower exhibit a more primitive type than the dorsiventral flowers, which are the normal ones in the plants in which they occur." Experiment has shown in certain cases that peloria is related to intensity of insolation, and thus it seems not impossible that the quality of the lighting, as well as position, may have had its influence in leading to zygomorphy. But whatever the conclusion drawn from a complete analysis of the causes leading to zygomorphy may be, that analysis, as far as it has gone, and comparison also, point clearly to the radial type of flower in Angiosperms as the primitive, and the dorsiventral as the derivative. Similarly, in the case of inflorescences, which are often dorsiventral in their development, it may be held as probable that the dorsiventral inflorescences have proceeded from radial ones.⁴

¹ *Organography*, Engl. edn., vol. i., p. 128.

² *L.c.*, p. 132.

³ *L.c.*, p. 188.

⁴ Goebel, *L.c.*, p. 138.

In the Gymnosperms the radial type is constant as a whole for the cones, both male and female; but, as in *Welwitschia*, there may be a more or less marked zygomorphy in the individual flowers.

In the strobiloid Pteridophytes also the strobili are for the most part of radial construction. In the Equisetineae this is the case without exception; also in the Sphenophylleae, so far as they are known. The related Psilotaceae are also radial in their fertile region, with the exception of the pendent species *Ps. complanatum*, Sw., which is isobilateral, probably as a secondary modification in accordance with its pendent habit: it bears its leaves and synangia only on the margins of the flattened branches. In the genus *Lycopodium* the strobili are always radial, even where the vegetative shoot is strongly dorsiventral. But in *Selaginella*, though the large majority of species show a radial strobilus, even where the vegetative shoot is dorsiventral, still the subgenera "Homostachys" and "Heterostachys" have dorsiventral strobili. The conclusion that these are derivative seems in this case unavoidable. *Isoetes*, and the fossil Lycopodinous genera have all radial strobili. Even *Ophioglossum* and *Botrychium* may be held to be of the same type, their upright axis in the polyphyllous species bearing leaves of equal size on all sides; but in the monophyllous species only one of these is as a rule expanded at one time; still, excluding the factor of time, the type of arrangement is radial of the shoot as a whole. *Helminthostachys*, however, is dorsiventral as regards the whole shoot; and this may well be held, on comparison with the other genera, to be a derivative condition.

The case of the Ferns, including the Hydropterideae, is not so readily brought into line with the strobiloid forms, owing to the sori and sporangia being distributed widely over their large leaf-surfaces and margins, while the sporophylls frequently show no differentiation in form or position from the foliage leaves. Their condition will be more fully considered later; meanwhile it may be pointed out that, within definite circles of affinity, a radial conformation is seen in upright forms, similar to that in strobili of other Pteridophytes, while those with oblique or horizontal axis show dorsiventrality, such as is seen in the strobili of certain *Selaginellas* and in *Helminthostachys*. Thus, though no definite strobilus is present, the relations of symmetry of the fertile shoot in Ferns are still comparable with those in other Pteridophytes.

Thus a review of the strobili of Pteridophytes as a whole leads to the recognition of a very great prevalence of the radial symmetry in them. In several large groups, which are certainly primitive in character, being represented early in palaeophytological history, the radial type of strobilus is never departed from: in others only occasionally; and this radial character of the strobilus may even persist in cases where the vegetative system shows dorsiventrality.

An examination of vegetative shoots of vascular plants at large shows

that they are more highly susceptible of modification of symmetry than is the strobilus; and so they have naturally been the more frequent subject of enquiry and of experiment, the observations chiefly relating to the post-embryonic shoot. The dorsiventral construction of the vegetative shoot is very common in creeping and climbing plants in the most different circles of affinity. It also appears in the lateral shoots of plants of which the primary shoot is radial. Dorsiventrality may make itself apparent either in unequal development of the leaves (anisophylly), or in difference of their position; or it may also affect the form of the stem itself. It may be found in one plant that outer influences may directly bring about the dorsiventrality, while in others it may exist from the beginning, and be hereditary. Goebel¹ has pointed out how *Vaccinium Myrtillus* shows in its lateral shoots a transitional state between these two cases; for in the lateral buds of this plant there is an influence exercised, probably by light, which leads to a distichous arrangement of the leaves; but it does not take place in all buds alike: in some the effect is only a secondary one, acting upon the leaves which originate in a spiral succession: in others the effect is primary, acting upon the vegetative point itself, on which accordingly the leaves arise. The existence of such gradations of effect, between dorsiventrality which is the result of immediate impress of outer influences and that which is an hereditary condition, is important as suggesting how the more fixed dorsiventrality may have come into existence. The comparison of such cases, and of the vegetative system at large in a number of allied plants, leads to the conviction that in the vegetative shoot as well as in the strobilus the radial was the primary type, and the dorsiventral the derivative. The causes are probably the same in both cases. It is, however, essential to note that the vegetative region is more liable to be influenced by them than the fertile; for it has been seen in many species of *Selaginella* and of *Lycopodium* that the vegetative shoot is dorsiventral, while the strobilus is radially constructed. The same is the case with many of the Coniferae. Such examples indicate that the strobilus is more conservative of form than the vegetative shoot. It is true the converse may be found in some of the higher Flowering Plants; for instance, in the Labiatae the vegetative shoot is commonly radial, while the flowers are dorsiventral. But this condition of the flower is probably one of the relatively late specialisation.

Examining more particularly the vegetative region of the Pteridophytes, the radial type of shoot is found with high constancy in the Equisetales, both fossil and modern. Also in the ancient Sphenophyllales and the modern Psilotaceae: the only exception in the latter being *Psilotum complanatum*, with its bilateral symmetry already mentioned. Of the Lycopodiales the early fossil types were characteristically radial in

¹ *Organography*, Eng. ed., vol. i., p. 94.

construction, though possibly dorsiventrality may have existed among the smaller forms. Of modern Lycopods, the mature shoots of *Lycopodium* show in relation to their position the most gradual transitions from the radial to the dorsiventral. The species of the sub-genus *Selago*, and *Sub-Selago* maintain the radial construction, and are for the most part of upright habit. The rest of the genus is very variable: the shoot is sometimes radial, as in *L. inundatum*: or distinctly distichous forms may occur, such as *L. Phlegmaria* and *nummularifolium*, which are both pendulous

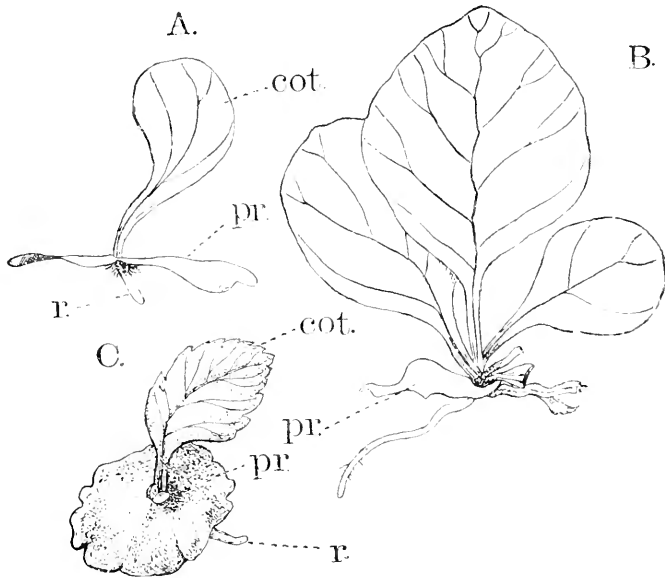

FIG. 105.

A, young sporophyte of *Danaea simplicifolia* still attached to the gametophyte. *pr.*, prothallium. B, an older sporophyte of the same species. C, gametophyte of *Angiopteris erecta* with young sporophyte. (A, B, after Brebner; C, after Farmer, from Campbell's *Mosses and Ferns*.)

epiphytes. The change from the radial type may be apparent first in a slight inequality of direction of the leaves, otherwise equal, as in the creeping shoots of *L. annotinum* or *clavatum*: or in the marked inequality of their size and structure, as in *L. complanatum* or *alpinum*. Goebel has shown¹ by experiment on *L. complanatum* that the dorsiventrality is directly induced by light. Finally, the climbing species, *L. volubile*, is specially characterised by a distichous form of the shoot not unlike that usual in *Selaginella*. It has already been concluded on other grounds that the *Selago* type of *Lycopodium* is the most primitive: it is this same type which retains most constantly that radial construction which there is reason to believe is a primitive character.

¹ *Organography*, vol. i., p. 252.

The genus *Selaginella* includes eight species which are isophyllous, and over three hundred which are anisophyllous in the vegetative region. An intermediate condition is found in *S. sanguinolenta*, which has accordingly been investigated by Goebel.¹ He found the dorsiventral structure to arise under the influence of external factors, such as moisture and shade. In certain strong-growing species, such as *S. caulescens*, the upright axes may be isophyllous, and the dorsiventrality only become pronounced in



FIG. 106.

A small plant of *Danaea aiata*. $\frac{1}{2}$. st=stipules. (After Campbell.)

the plagiotropic upper branches. Others may be dorsiventral from the first. Thus the genus illustrates gradual steps of dorsiventral development, such as have been noted in *Lycopodium* and *Vaccinium*, though the details are different. And the same conclusion may be drawn as in those cases, viz. that the radial is the primitive form, and the dorsiventral the derivative.

The Fern-shoot, notwithstanding the preponderance of its leaf-development, may be examined from the same point of view as other Pteridophytes. The ancient Marattiaceae illustrate a probable initiation of dorsiventrality of the shoot within their own phylum. The young sporophyte seedling

¹*l.c.*, p. 105.

in all the genera of Marattiaceae investigated hitherto is upright, bursting through the prothallus, not recumbent as in other Ferns (Fig. 105). In

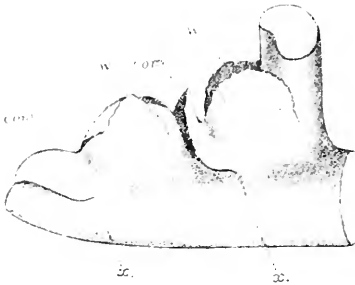

FIG. 107.

Diagrammatic representation of the end of a rhizome of *Kaulfussia*. *w*=wings of stipule; *com*=transverse commissure. (After Gwynne-Vaughan.)

Angiopteris and *Marattia* this condition is maintained throughout life, and there is no reason to think otherwise than that these plants retain their primitive position. It is probably shared also by *Archangiopteris*:¹ at all events there was no dorsiventrality in the only specimen with an axis hitherto examined. In the genus *Danaea* the same holds for *D. simplicifolia*; but certain other species of *Danaea* have an oblique rhizome, for instance, *Danaea alata* (Fig. 106). Comparison of a number of stocks of this Fern shows various degrees of inclination and curvature of the axis. It is upright at first, and produces leaves and roots uniformly on both sides of the axis; but later the axis arches over to one side, and a distichous arrangement of the leaves is approached, while the roots originate chiefly from the side directed downwards. In *Kaulfussia* these characters are more pronounced; for there the mature rhizome is horizontal, with marked dorsiventrality, and with internodes of appreciable length (Fig. 107). Unfortunately the early development of the sporophyte of *Kaulfussia* is still unknown. It seems a reasonable interpretation of the facts that the upright position, with radial symmetry, as seen in *Angiopteris* and *Marattia*, was the primitive condition here as in other Vascular Plants: and that the oblique position, already seen in certain *Danaeas*, became more accentuated in the horizontal rhizome of *Kaulfussia*, with its marked dorsiventrality.

The analogy with what is seen in the Ophioglossaceae greatly strengthens this conclusion. As in the Marattiaceae, so also in all the genera of the Ophioglossaceae the axis is from the first upright (Fig. 108); and that position is maintained throughout life in *Ophioglossum* and *Botrychium*. But in *Helminthostachys*, notwithstanding its originally vertical position, the axis of the mature plant is markedly dorsiventral (Fig. 109), with distichous arrangement of the leaves. The conclusion which naturally follows is that in the



FIG. 108.

Helminthostachys zeylanica. Young plant attached to prothallus. Natural size. (After Laing.)

¹ Gwynne-Vaughan, *Ann. Bot.*, xix., p. 260.

Ophioglossaceae, as in the Marattiaceae, the upright radial shoot is primitive, and the dorsiventral character of the shoot derivative: that in *Helminthostachys*, as in *Danaea* and *Kaulfussia*, all of them heavily-leaved forms in proportion to their relatively elongated stem, the axis has become horizontal.

The Leptosporangiate Ferns present a more varied and difficult problem as regards the symmetry of the shoot. They include many upright radial forms, such as *Cyathea*, *Alsophila*, or *Osmunda*; as well as many which show various degrees of obliquity of the axis, accompanied by corresponding degrees of dorsiventrality. It is not an uncommon thing to find upright radial

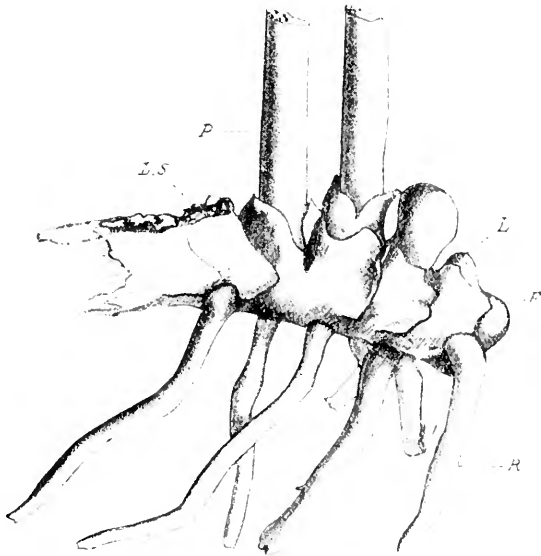

FIG. 109.

Naked-eye drawing of rhizome of *Helminthostachys zeylanica*. *F*=stipular flap; *R*=root; *L*=leaf; *P*=petiole; *LS*=leaf-scar. (After Farmer and Freeman.)

species, and straggling, dorsiventral species in the same genus: for instance, *Onoclea germanica* is radial and upright, *Onoclea sensibilis* is creeping; *Pteris aquilina* is creeping, while many other species are tufted and radial. The same question will arise here as elsewhere, which of the two was the primary condition. From analogy with other cases as well as from internal evidence, the upright, tufted forms with radial symmetry would be held to be the prior type: but the question is complicated by the fact that the embryo itself is not upright in the Leptosporangiate Ferns, and it may be thought that its recumbent position defines *ab initio* the dorsiventrality of the shoot.

It is true that the first leaf of the young sporophyte is uniformly on the side away from the prothallus: but the position of the second and

succeeding leaves may vary, as was already noted by Hofmeister. He stated specifically¹ that "the similarity in the development of the different species of Ferns does not extend beyond the formation of the rudiments of the first frond, and of the first root." He then proceeded to show that whereas in *Pteris aquilina* the second frond originates on the side of the axis opposite to the first, and distant from it by about half the circumference of the stem, in *Nephrodium (Aspidium) Filix mas* it is at a distance of about a third of the circumference²: "the third diverges from the second, and the fourth again from the third at about 120 degrees to the right, so that the fourth stands vertically over the first." Thus the arrangement of the leaves is radial from the first in the Male Fern. The same radial character, with varying divergences, has been

found in other Fern-seedlings: for instance, in *Nephrodium dilatatum*, *Asplenium marinum*, *Pteris tremula*, *Osmunda regalis*, and *Todea superba*. The leaf-divergence in such cases is variable, but approximates to a half, or one-third, and it is spiral from the first, without dorsiventral tendency. This shows that in plants which are radial in the mature state the initial condition of the recumbent embryo does not impress dorsiventrality on the seedling. In others, however, where the mature plant is markedly dorsiventral, the dorsiventrality asserts itself early. Among these the case of *Polypodium vulgare* is very instructive, as showing

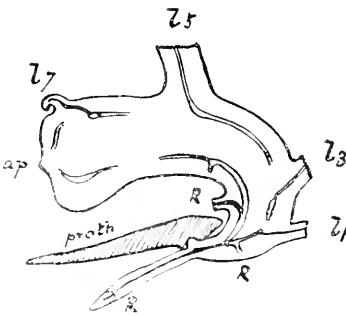

FIG. 110.

Polypodium vulgare. : 6. Median section through prothallus, and embryo, partly diagrammatic: showing one series only of the distichous leaves l_1, l_2 , etc.; R =roots; ap =apex of axis. The hypostemal shoot becomes completely inverted, growing backwards over the prothallus.

that the dorsiventrality of the mature shoot is not a direct consequence of the initial procumbent position. The initial embryogeny is as usual: the second leaf of the embryo is obliquely on the same side of the axis as the first, and as the subsequent leaves are also inserted alternately and obliquely on that same side, and the growth of the axis is stronger on that same side which faces away from the prothallus, the whole shoot becomes inverted by a strong curvature upwards through the apical indentation of the prothallus; and thereafter it pursues its horizontal course backwards over the top of the prothallus (Fig. 110). It is interesting to note as a consequence of this that the side of the axis initially turned downwards in the embryo becomes the upper side of the dorsiventral rhizome, owing to the inverting curve: thus the creeping position of the permanent shoot is not merely a direct continuance of the initial prone position of the embryo. Other examples might be quoted, but this will suffice to show that the dorsiventrality of the mature shoot is

¹ *Higher Cryptogamia*, Eng. ed., p. 208.

² *L.c.*, p. 227.

not a necessary or a direct consequence of the recumbent position of the embryo of Leptosporangiate Ferns. It may also be added that the dorsiventrality, in cases where it exists, may be initiated in different ways. Such evidence points to its being a secondary condition.

A further indication that the shoot of Leptosporangiate Ferns is primarily radial is to be seen in the internal structure of the axis. It has been found in a considerable number of cases that the vascular tissue is uniformly developed all round. This is naturally the case in upright radial axes: but, apart from the leaf-insertions, it may even be so in stems which are horizontal, such as *Matonia*: though in others, such

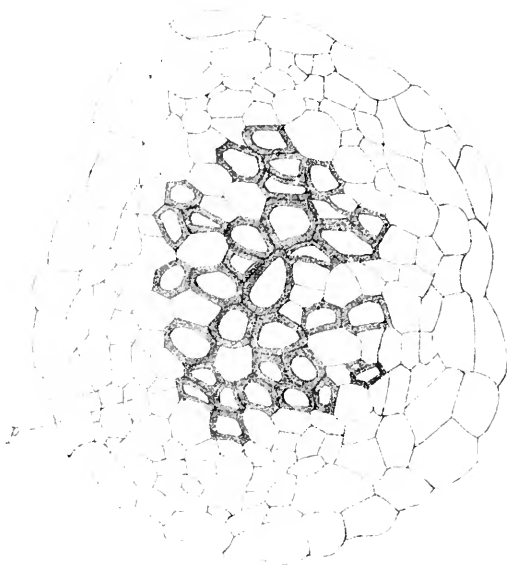

FIG. 111.

Transverse section of axis of seedling of *Lygodium japonicum*, below the first leaf. $\mu =$ one of the xylem-parenchyma cells. $\times 39\%.$ (After Boodle.)

as *Pteris aquilina*, the vascular system is like the stem itself dorsiventral. In young seedlings it has been shown in various cases that the stele is cylindrical, and it is found to be so even in Ferns which are markedly dorsiventral in the mature state, such as *Lygodium japonicum* (Fig. 111). Such examples indicate again a probability that the radial construction of the shoot was primitive in the sporophyte of Ferns.

But it may be urged by those who dissent from this conclusion that dorsiventrality is clearly seen in the early embryonic stages of some other Pteridophytes, and especially in the case of various species of *Lycopodium*. But here also it seems probable that the condition is adaptive rather than primitive: for in the first place the embryo in the genus is singularly inconstant in its form: in some species, such as *L. Selago*, or *L. clavatum*,

the embryo settles down at once into an upright radial type of structure: in others, and particularly in *L. cernuum*, which has been made the subject of special study and comparison, the embryo may show at first a marked dorsiventrality; but it is at the same time exceedingly variable in form, and in some individual cases the embryo of *L. cernuum* may closely resemble the ordinary radial type of other species. This variability will in itself discount arguments based upon details of form, and suggests that the dorsiventrality where it occurs is the result of relatively direct adaptability of a very plastic organism.¹

The facts and arguments brought forward in this chapter lead up to a general view of the symmetry of the sporophyte generation. It would appear probable that the original type of its construction has been radial throughout, a condition which commonly goes along with a vertically upright position. This is the position of the vast majority of Bryophyte sporogonia: in them the radial construction is rarely departed from, and where this does happen the dorsiventrality is readily referable to a modification of a radial type. The greater diversity of habit of the Pteridophytes, especially as regards the sporophyte, necessarily brings greater difficulties in attaining to any general opinion for them; but a careful review of their various types, and especially a comparison of members of the same group of them *inter se*, leads back constantly to the radial type as primitive, even in cases where dorsiventrality is most marked. The fact that in the Equisetales and Sphenophyllales the radial construction is predominant, while it is also prevalent among the more primitive Lycopodiales, and in a less degree in the Filicales, shows the strong hold which the radial construction had among very early types. In fact the position is fully strong enough to justify the general statement that the radial mode of construction was primitive for the sporophyte at large; and that where dorsiventrality occurs, it is a secondary condition.

This conclusion is plainly out of harmony with the theoretical position of Lignier,² who would refer the sporophyte as well as the gametophyte to a hypothetical thalloid origin: this thallus, which was dichotomous, and lay flat upon the soil, tended to curve upwards, and consequently to

¹The more exact comparison of the embryology in the genus *Lycopodium* will be taken up in the special part of this work.

²"Equisétales et Sphénophyllales. Leur origine filicinéenne commune." *Bull. Soc. Linn. de Normandie*, 1903, p. 93. A somewhat similar speculation has recently been published by Tansley (*New Phytologist*, 1907, p. 25): he refers the Archegoniatae in origin to some "hypothetical Archegoniate Alga." He also passes lightly over the transition from a sympodial rhizome to an upright, radially organised type (p. 33). It is necessary, however, to remember that, as a matter of observation, all Archegoniate sporophytes are initially of radial construction. The same difficulties appear to confront both Tansley's and Lignier's hypotheses. To meet them both authors postulate hypothetical forms which are "of course the purest speculation" (*loc. cit.*, p. 32). It appears preferable to adhere to observed facts.

assume a cylindrical symmetry. On this hypothesis the dorsiventral was the prior state for both the sporophyte and the gametophyte, and the radial the derivative. The author himself states that this "prohepatic" type, from which the two generations were evolved, is still wholly hypothetical. As regards the sporophyte, since the embryology gives no countenance to an originally dorsiventral "prohepatic" state, while instances are common of the impress of dorsiventrality upon parts of it originally radial, the theory of Lignier cannot be upheld. It may apply for the gametophyte, but that has nothing to do with our present discussion. It seems the unavoidable conclusion from the facts that the primitive symmetry of the sporophyte was radial.

CHAPTER XVII.

THE ESTABLISHMENT OF A FREE-LIVING SPOROPHYTE.

So far the shoot only of the sporophyte has been the subject of discussion: it remains to consider the question how the sporophyte, originally dependent upon the parent prothallus, became established as a free-living organism on the soil. There will be no two opinions which of the principal regions of the independent sporophyte, the shoot or the root, was of prior existence: it is a necessary outcome of the evolution of the neutral generation as sketched above that the shoot was first established, as a body dependent on the gametophyte; it carried out primarily the function of spore-production, but ultimately also, as we have seen, that of vegetative nutrition. The root is essentially an accessory, which made its appearance after those earlier steps were past; it arose from its primitive state of dependence to an existence free from the parent gametophyte.

Comparison of living plants indicates, however, a probability that the initiation of a root-system followed closely upon the adoption of a free-living habit: for roots are present in free-living Pteridophytes with very few exceptions, and are, as a rule, formed early in the embryology. It seems doubtful, even in the few exceptional cases, whether the rootless condition is not due to reduction, rather than representative of a primitive rootless, but free-living sporophyte. Among the Pteridophytes roots are absent in the Psilotaceae, also in certain Hymenophyllaceae, and in *Salvinia*: it seems probable that reduction will correctly account for it in such specialised forms as the Hymenophyllaceae: and also in *Salvinia*, with its peculiar floating habit: the question in the Psilotaceae is more problematical, and their rootless condition may perhaps have been really primitive, though in the absence of any knowledge of their embryos there is no clear indication that it was so: moreover, their habit is so peculiar as to make any conclusion difficult. Rootless Phanerogams also exist, but there is no reason to regard them as other than results of relatively recent reduction. Accordingly, it may be concluded that there is little

evidence from plants of the present day of the existence of a primitive, permanently free-living, but rootless state of the sporophyte.

The root in the fully-developed state is broadly different from the axis: its endogenous origin, its root-cap, and the radial arrangement of its vascular system are its most distinctive features, in addition to the absence of appendicular organs, other than root-hairs, or lateral roots. Its full character depends upon the collective existence of those features; for some of them are inconstant, and all of them may occasionally be matched by axes:¹ thus the two parts are not absolutely distinct in character. Sometimes, indeed, it may be found that roots grow on directly into normal leafy shoots, as in certain Ferns, Aroids, and Orchids, etc.:² the converse, however, has not yet been shown to occur.

The resolution of the problem what genetic relation, if any, subsisted between axis and root will naturally be looked for in such plants as show the least degree of differentiation of those parts. As such the living Lycopods are pre-eminent, while their fossil relatives also show features of importance for comparison. Like axes, the first roots may be exogenous, as in certain Lycopod embryos, and in *Phylloglossum*: in the Lycopods the roots show apical dichotomy as do their stems also, while the exarch xylem and general disposition of the vascular tissues of the Lycopod stem are points of similarity to root-structures which are not equalled in other Vascular Plants. Finally, the *Selaginellas* present features of further interest in their so-called "rhizophores," parts which occur in many, but not in all species: they are exogenous in order, and capless: they branch dichotomously, and upon them the roots with root-cap arise endogenously. In structure they are usually like roots, but in some cases the rhizophore has a structure resembling that of an axis: for instance in *S. Kraussiana* the protoxylem is central, and the whole arrangement very like that of the stem in *S. spinosa*.³ Further, the rhizophores may be readily converted in some species into leafy shoots, by suitable cultivation. Thus the rhizophores do not show the full characters of roots or of axes, and the question has long been debated whether or not they are truly of root-nature. Some prefer to distinguish them by a special name, as "rhizophores": others describe them merely as the aerial region of the root.

¹ Exogenous roots are seen in *Phylloglossum*, and in the embryos of some species of *Lycopodium*, as well as in some Phanerogams. Capless roots are known in *Aesculus*, and in some few others (Goebel, *Organography*, vol. ii., quote from Engl. ed., p. 267). On the other hand, a protective cap has been observed on the apex of the axis in embryos of *Arancaria*, and *Cephalotaxus* by Strasburger (*Angiosp. und Gymnosp.*, Plates six. to xxi.): endogenous shoots are not common, but they occur occasionally, as in the flower-buds of *Ptilostyles*, as well as on the emergence of shoot-buds adventitiously from roots (Goebel, *l.c.*, pp. 226, etc.). A radial disposition of the vascular tissue, *i.e.* with exarch xylem, is characteristic of the axes of Lycopods, and of some others of the early types of Pteridophytes.

² Goebel, *Organography*, vol. ii., p. 226.

³ Harvey Gibson, *Ann. of Bot.*, 1894, Pl. x., Fig. 39. Also 1902, Pl. xx., Fig. 17.

For my own part, I am satisfied to regard them as belonging neither to the category of stem nor of root, but as a result of development to meet a certain need, and that the growth produced was not of either character in phyletic origin.¹

It is interesting to compare *Selaginella* with the allied fossils, which have as their underground system the enigmatical Stigmarian development (Fig. 112). These underground parts of *Lepidodendron* and *Sigillaria* present morphological questions somewhat similar to those of *Selaginella*: the main Stigmarian trunks are not roots, for their anatomical structure

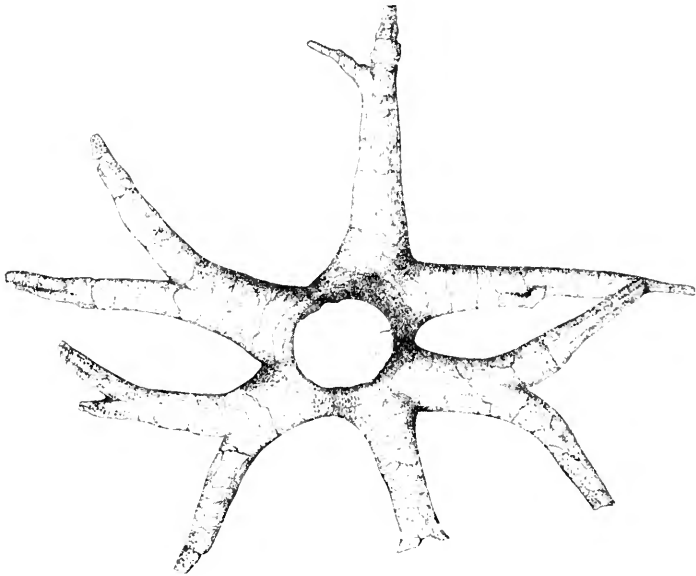

FIG. 112.

Ground plan of a Tree-stump with Stigmaria-trunks. One-sixtieth the natural size.
(After Potonie.)

is far removed from that of any known roots: they are not typical rhizomes, for the only appendages they are known to bear are the Stigmarian rootlets, which are rightly so recognised from their anatomical features. They may be best classed with the rhizophores of *Selaginella*, or more especially with the basal knot on the hypocotyl of *S. spinulosa* (Fig. 113), though the correspondence is far from being exact. These, the Stigmarian trunks, and the curious processes in *Pleuromöia* (Fig. 114),² may all be held to be outgrowths which fall into no recognised category of parts, such as stem, leaf, or root; and they all serve the same purpose, of acting as a basis of attachment for the roots themselves. The existence of such bodies points to the Lycopodiales as presenting characters of peculiar

¹ Cf. Goebel, *Flora*, 1905, p. 209.

² Solms, *Bot. Zeit.*, 1899, p. 227.

interest in any discussion of the origin of a subterranean absorptive system.¹

But the presence of such "rhizophores" does not greatly assist the solution of the problem of origin of the roots themselves. There is, in fact, no sufficient or decisive evidence how the root came into existence in Vascular Plants: but on the facts as they stand two alternative opinions are possible. Either that it resulted from the transformation of a leafy shoot by loss of the appendages, followed by other special adaptations in relation to its life, and to its absorptive function in the soil. Or that it

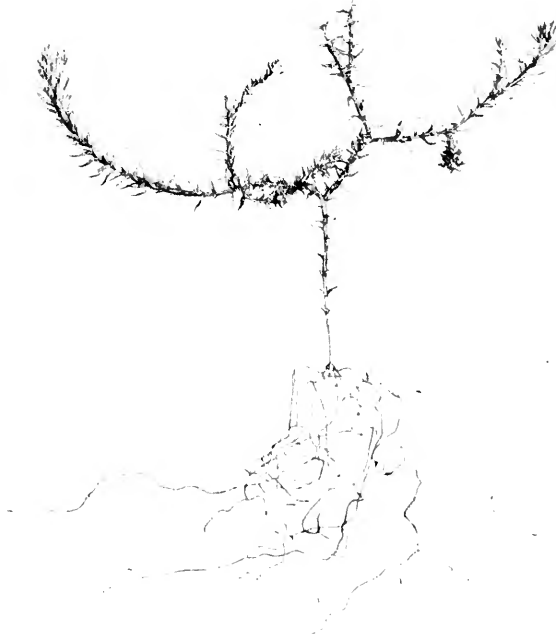

FIG. 113.

Plant of *Selaginella spinulosa*, with root system springing from swollen knot at base of the upright hypocotyl. $\frac{1}{2}$ natural size.

arose as a new type of haustorial outgrowth, not originally of shoot-nature: but nevertheless that in its first and less differentiated condition it resembled the shoot from which it arose, in its structure, and in the character of its branching. That those features which were helpful in its absorptive and conducting functions were permanently maintained, and they became distinctive characters of the differentiated root: other characters, such as the root-cap and endogenous branching, may have been added in accordance with the underground habit. This latter view seems to me the more probable alternative.

Applying it in the case of the Lycopodiales, the root at its inception would, like the stem of these plants, be exogenous, with exarch xylem

¹ Compare Goebel, *Organography*, vol. ii., p. 230

and dichotomous branching; and these stem-like characters are actually exemplified in the roots of living Lycopods: but in most cases the exogenous origin and dichotomous branching gave way to endogenous origin and monopodial branching, both of which are more suitable for parts which have to make their way through the soil. The exarch xylem was, however, maintained: and, being biologically convenient in absorptive organs, it became a characteristic feature of the root for Vascular Plants at large. Many of the primitive types of Vascular Plants had exarch xylem in the stem: and if in the same way their primitive roots resembled

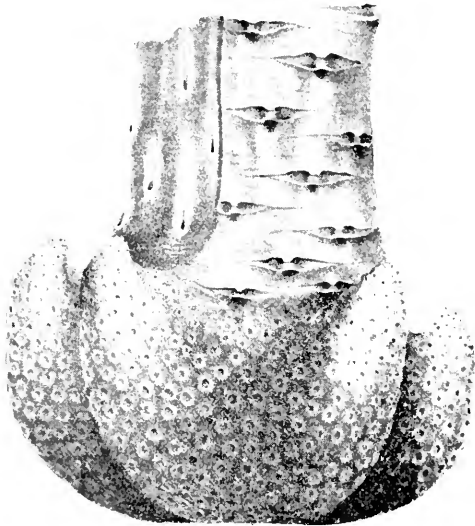

FIG. 114.

Pleuromia Sternbergi. Swollen base of stem with root-scars, and showing part of the aerial stem, with the epidermis and leaf-scars on the right, and on the left the sub-epidermal sculpture. (After Bischof, from Engler and Prantl.) Two-thirds natural size.

their stems structurally, they also would have exarch xylem. On this hypothesis the roots would appear to have retained a structural character which was represented in the early structure of stems. In this way the origin of roots may be presented to the mind without their being held to have been actually the result of transformation of a leafy shoot itself, of which there is no evidence from abortive appendages. But as a matter of fact, there is no certain knowledge how the root originated.

In most embryo sporophytes of the present day a root-development is initiated before the need for it arises, that is while the embryo is still entirely dependent upon

the parent gametophyte. But it cannot be assumed that this was always the case: indeed, it is thought by some that there is an inherent probability that some intermediate condition may have preceded the initial formation of the root in descent. Among the embryos of some of the early types of Vascular Plants a condition has been found which has been held to be primitive, and to illustrate how the transition to a free-living condition of the sporophyte may have been effected: it is seen in certain species of *Lycopodium*, *L. cernuum*, and *L. inundatum*, in which the prothallus is green and subaerial, thereby suggesting a relatively primitive condition as compared with other types of the genus. In these the upper half of the embryo, owing to the rapid extension of the massive foot, is soon extruded laterally from the prothallus (Fig. 115).

The body of the embryo thus exposed bears the cotyledon, and a variable number of leaves directed upwards, but it terminates downwards in a tuber-like body provided with rhizoids (compare Fig. 21, p. 37). At first there is no root, and in extreme examples the appearance of the first root may be deferred for a considerable time; but so soon as the normal aerial shoot with leaves is defined, the first root soon penetrates the soil, and



FIG. 115.

Young embryo of *Lycopodium cornutum*, beginning to project from the prothallus. *az*=archegonium; *s*=suspensor; *cot*=cotyledon; *tub*=embryonic tubercle. (After Treub.)

establishes the plant in the usual way. The tuber which thus precedes the establishment of the plant by means of a root was called by Treub the "protocorm," and he regarded it as a rudimentary structure, which was the phyletic forerunner of the leafy shoot as now seen generally in Pteridophytes. It is represented, however, only in few cases, and is not constant even in the genus *Lycopodium*: for instance, it is absent in *L. Selago*, and also in *L. Phlegmaria* and *L. clavatum*. In *Phylloglossum*, on the other hand, this type of development is not only found in the primary embryology, but is repeated constantly in

each season's growth, while the tuber itself is here greatly enlarged for purposes of storage. The characteristic "protocorm" is absent from all other Pteridophytes.

The question is, what is the true interpretation of these facts. Does the protocorm really represent some condition which existed in the phylogeny, intermediate between the fully-rooted sporophyte and that more primitive state where it was fully dependent on the prothallus? The first point which strikes attention is the way in which the transition from dependence to independence of the sporophyte is actually carried out in the plants which show this "protocorm" development: assuming that there is some difficulty, nutritive or other, in formation of the root itself, the case is quite adequately met by the tuberous development with rhizoids, as a temporary shift. It seems not improbable that some such difficulty should precede in descent the initiation of so important, and so characteristic a body as the root. A second point, however, is that a protocorm development is exceedingly limited in its distribution among living plants: it is not constant even in the genus *Lycopodium*, and outside the Lycopodiales it is not characteristically developed in any other of the early forms: this must be taken fully into consideration before assigning to the "protocorm" any general phyletic significance. But, on the other hand, it may be urged that the real importance of the "protocorm" would exist only in those cases where either the root-development has not yet been initiated in the race, or where its late development in the individual is a matter of moment, on nutritive or other grounds. Immediately any initial difficulty of development of a root-system is surmounted in any line of descent, the "protocorm" would be liable to be cut out of the ontogeny, as a cumbrous and unnecessary stage. This would sufficiently account for the absence of a "protocorm" in the great majority of Vascular Plants. But, again, Goebel, in arguing against the general phyletic significance of a "protocorm," has cited a number of cases of Phanerogamic Plants in which, if the formation of the root is suppressed temporarily or entirely in the seedling, a protocorm-like body is formed, which is anchored to the substratum by hairs.¹ He remarks that this appearance of a protocorm in very different circles of affinity seems to him unfavourable to the hypothesis of its having a phyletic significance, and he only sees in it an organ which corresponds in its development, and especially in its formation of roots, to an arrested hypocotylous segment: he suggests that a suppression of the formation of the roots may have taken place in *Lycopodium*, as also in the Orchideae, and that this was connected with the prolonged development of the germ-plant in them: perhaps also the symbiosis with fungi which takes place in these plants, may have had its effect. On this view the "protocorm" would be secondary, and it would not illustrate an archaic mode of establishment of the

¹ *Organography*, vol. ii., Engl. ed., p. 232

sporophyte on the soil. Such a suggestion certainly accords readily with the sporadic occurrence of the "protocorm."

It is difficult to arrive at a conclusive balance between such conflicting facts and arguments as these. So far as any conclusion commends itself to my mind it is as follows: A "protocorm" development may have been an important phase in the establishment of certain Lycopod embryos, in that it serves as a temporary substitute for a root-system delayed in its development. But it seems unnecessary to take such cases as prototypes for even the genus *Lycopodium* as a whole: since the Lycopod embryo, while showing essential unity in its general plan, seems prone to parenchymatous swelling. Two such swellings, somewhat similar in structure but differing in place of origin and in function, are known, viz., the enlarged "foot" of *L. clavatum* and *annotinum*, which originates from the lower tier of cells of the embryo, and is intra-prothallial; and the "protocorm" of the *cernuum*-type, which originates from the upper tier of the embryo, and is extra-prothallial. They are both biologically intelligible, for the former acts as an haustorium, the latter may be a ready mode of fixation in the soil, and also a specialised place of storage. A genus which shows two types of parenchymatous swellings in two distinct types of embryo, while both are absent from other species of the genus, cannot be expected to have ever had one of these as a constant feature in its ancestry. This consideration makes me doubt any general application of the theory of the "protocorm" even in the genus *Lycopodium*. These parenchymatous swellings may be looked upon as opportunist growths, rather than as persistent relics constant from a remote ancestry. This view is greatly strengthened by the occurrence of protocorm-like developments in isolated cases among the Angiosperms. *Phylloglossum* with its large storage "protocorm" would then be the extreme type of a line of embryological specialisation, not a form preserving the primitive embryological characters of the whole race. On such grounds, while not denying that a "protocorm" may have had a certain importance in certain cases, the facts do not appear to justify attaching to it any general significance.

From the above pages it will be plain that the origin of the free-living habit of the sporophyte, and of its root-system is quite as obscure as that of the leafy shoot itself. The important step from dependent to free life was certainly taken at a period before the earliest fossil records of Vascular Plants; for all the best-known types of early fossil Pteridophytes have roots assigned to them on secure grounds of observation: so naturally the evidence from them does not lead to a solution of the difficulty. On the basis of comparison, to which this question must necessarily be relegated, no decisive help is forthcoming; the theory of the protocorm, which at first sight seemed so full of promise, does not give more than a suggestion how the transition from dependence to independence may actually be carried out in certain cases, and among

the Pteridophytes it is illustrated only within a strictly localised area of affinity. The course of transition from the dependent embryo to the rooted plant, as it is carried out in the individual life, may be held to be the most reasonable guide to the same transition in the past. It is seen to be occasionally through the intermediary of a protocorm, but oftener without. It may be that this indicates correctly the actual course which events took; and suggests that all vascular sporophytes did not achieve their independence in the same way.

It is of course possible to take an entirely different view of the relations of the two generations from that here presented, and to consider the dependence of the sporophyte as being itself secondary, and the haploid and diploid phases as having been originally as independent as they are seen to be in *Dictyota*. In that case the problem would be the converse: viz., to trace the origin of the dependent state of the sporophyte. There is, however, no serious basis of fact or comparison hitherto adduced, which can place this suggestion upon a footing of reasonable probability: it will suffice here to have mentioned that the suggestion has been made.

CHAPTER XVIII.

THE EVIDENCE FROM PALAEOPHYTOLOGY.

It has been remarked above (Chapter I.) that the only direct and positive clue to the sequence of appearance of Plant-Forms in past time upon the earth is to be obtained from the study of fossils. Luminous facts derived from them are beginning to shed a fresh and direct light upon problems hitherto obscure; and the last quarter of a century especially has shown how greatly a knowledge of the fossil forms may advance the true perception of affinities of certain groups of plants now living.

But the success which has already attended Palaeontological investigation, and has led to such important results, must not be allowed to disguise the limits which circumscribe this branch of enquiry: nor should it unduly raise the hope that the area of fact available for comparison with forms now living will be indefinitely extended. It can hardly be anticipated that data derived from fossils will ever take a decisive place in discussions of the primary origin of the sporophyte. In the mind of the Morphologist there can be no spirit of depreciation of the recent advances of Palaeophytology, but rather a very high estimate of their value: nevertheless he cannot help recognising how inadequate the evidence drawn from fossils is in its bearing on such questions as those discussed in the foregoing chapters. Hitherto it has given no clue whatever to the origin of the Bryophyte sporogonium: nor does it materially assist in resolving the problem of the origin of the leafy sporophyte, or of its adoption of a free-living habit: nor, again, does it indicate with any decisiveness the evolutionary relationships of the great phyla of the early Pteridophytes. All these questions deal with events which we may presume to have preceded the existence of the earliest fossils of which any exact record has hitherto been discovered.¹

¹ I am unable to share the very sanguine view of Mr. Arber (*Annals of Botany*, 1906, p. 216), who remarks that "the imperfection of the Record, largely exaggerated in the past, can be wholly neglected where we are considering the larger divisions of the vegetable kingdom, such as phyla, classes, or groups of Plants."

There are three palpable deficiencies in the Palaeontological evidence: one, as has been said, is its incompleteness as regards the prime origins of the leading types which are lower in the scale of vegetation; another is the usual, and almost necessary absence of developmental detail; the third arises from the frequency with which fossils are known by impressions only, without the material sufficing for study of the internal structure. This is especially so for some of the earliest, and from an evolutionary point of view the most important forms. The first is by far the most serious shortcoming.

The earliest fossil-bearing strata contain plant-remains which are more in the nature of independent problems than an assistance, on any basis of comparison, to the understanding of the known types of the vegetable kingdom. Such plants as *Nematophycus* and *Pachytheca* suggest the existence of Algae in the Silurian age, but are not readily ranked with more modern forms. Similarly, the plant-remains from the Lower Old Red Sandstone are highly problematical, though they indicate a probability of terrestrial life. This seems more clear in the Middle Devonian, where among other remains of plants apparently of the land, *Palaeopitys Milleri* has been found: this is a stem with structure, showing tracheides arranged evidently as having been produced from a cambium, while pits are seen in the longitudinal sections: the whole structure is reminiscent of some Cordaitean structure. But it is only in the upper Devonian that the remains of a Land-Flora are such as to be referable with any degree of confidence to known types: thus *Bothrodendron Kiltorchense* seems plainly to be a large Lycopod; *Archaeopteris hibernica* has usually been referred to the Filicales, though it has recently been suggested that it may not improbably be in reality the male fructification of a Pteridosperm: *Pseudobornia ursina* lately described from Bear Island by Nathorst, is a Calamarian type with relatively large fimbriated leaves; characteristic Cordaitean remains are also to be found. These may all be referred to well-known groups of Land-growing Plants, and though they may differ in certain important respects from related forms of later date, they show in complexity of character, and often also in size, features which are definitely those of the highly organised phyla to which they are referred. Thus the early representatives give little clear information beyond the fact of the early existence of those phyla to which they belong: they do not provide an explanation of their origin, and help only slightly to form opinions as to their mutual relations. Few facts are more striking than this apparently sudden presentment of certain vegetable types, already showing in a high degree the characteristics of their class. An extreme case of this is pointed out by Zeiller.¹ He remarks that evidence of the existence of the Gymnosperms, "dates from the base of the strata of Gaspé in Canada; that is to say, from the most ancient epoch which has left to us the remains of terrestrial plants: they are there represented by the

¹ *Eléments de Palaeobotanique*, p. 369.

Cordaiteae, a type already very perfect and specialised. We cannot then draw from the data of Palaeobotany which we possess any indication of the origin of these first Gymnosperms." This illustrates how hopeless it must be, so long as earlier strata yield only indefinite remains or none at all, to base upon stratigraphical evidence any consecutive story of the rise of a Land-Flora: for on a comparative basis these Gymnosperms which thus appear so early stand high in the scale of Vascular Plants. Other examples might be quoted, but this will suffice to illustrate the deficiency of the record as regards prime origins. It has already been noted that developmental detail is usually absent from fossils, and that many are known only as impressions, without the possibility of minute structural examination of their tissues under the microscope. These considerations only show still further how scanty is the positive information from study of the fossils which is available for elucidating the early origin of the sporophyte.

There is also a converse line of information, which involves negative evidence, based on the absence of certain types from strata where others are present. It may be held that organisms which first appear in the earlier strata are more primitive branches of the evolutionary tree than those which appear only in the more recent strata. But the fact that the record is, as we have seen, so very incomplete as regards the prime origins of the leading phyla will at once strike the note of caution in use of such negative arguments. Moreover, the probability of preservation of the representatives of any group may depend greatly on the character of the organisms in question: thus it need be no surprise that the small and delicate Bryophytes are conspicuous by their absence from the earlier records, while Algae are but rarely preserved. Again, the non-representation of any group may depend in some measure on the position in which the plants grew: thus the flora of uplands will be less likely to be preserved than that of low-lying lands or swamps; this argument has sometimes been applied in explanation of the absence of Angiosperms till a relatively late period. It is often possible to make out a plausible case from such negative evidence: but its insecurity is obvious. To use it with effect it must be supported by other considerations, such as argument from comparison. Thus the absence of evidence that Polypodiaceous Ferns existed in Palaeozoic times, must be taken with the position which is assigned to them on grounds of comparison among other Filicales; it then becomes a very convincing argument as showing their later derivative character, and the more so that Fern-types are among the best-preserved of early fossils. On the other hand, the entire absence of well-authenticated Ophioglossaceous remains from all the earlier formations only intensifies the difficulty of the problem which surrounds these curious plants, and cannot in itself be accepted as demonstrating that they are of relatively recent origin.

These remarks are intended to indicate the limitations to which the use of palaeophytological evidence must necessarily be subject. It is when these

are clearly apprehended that the true value of that evidence will begin to emerge. Though, as we see, it cannot yet be held to throw any direct light on the prime origin of terrestrial plants, still it has valuable bearings on the mutual relations of the earlier known types. It is especially valid in supplying a knowledge of "synthetic types," that is, plants now extinct, which include among their characteristics some of the peculiarities of two or more distinct lines of descent. The most important of these hitherto disclosed are the Sphenophylls, which constitute a series separate from the three great phyla of living Pteridophytes, though some affinity is to be recognised between them and the modern Psilotaceae. Their leaves agree with those of the Equisetales in being whorled, and being superposed they are most nearly like the oldest known Calamite—*Archaeocalamites*. Their whorled arrangement also corresponds with that of one of the earliest Lycopods, *Lycopodites Stockii*, from the calciferous sandstone. The anatomy of the stem of *Sphenophyllum* is Lycopodial rather than Equisetal, but the strobili are nearer to those of the Equisetales than to those of any other known family. The interest in the group which showed such mixed characters was further intensified by the discovery of *Cheirostrobus*.¹ "This strobilus presents the same combination of Lycopodial with Equisetal characters which we find in *Sphenophyllum* itself, but in both directions the agreement is more striking. . . . We may express its probable natural position by placing it in the main division Sphenophyllales, but in a family by itself, distinct from the Sphenophylleae in the narrower sense. The threefold affinities of *Cheirostrobus*, firstly with the Sphenophylleae, secondly with the Equisetales, and thirdly with the Lycopodiales, appear indisputable, and indicate that this genus, and the Sphenophyllales generally, represent a phylum intermediate between the other two, which we must suppose to have originated with them, from a common ancestral group. In this way, the study of the extinct Sphenophyllales has thrown quite a new light on the obscure affinities of the Equisetal stock, for it indicates clearly that this phylum had a common origin with that of the Lycopodiales, a conclusion which the exclusive investigation of their recent representatives could never have suggested." Another important synthetic group of plants, of early occurrence, is that of the Cycadofilices, which link together the Pteridophytes and the Gymnosperms. Such examples illustrate what may be held to be the most important results obtained hitherto from Palaeobotany, as aiding the study of descent in Plants.

Another line of argument from Palaeontological data is now beginning to be used, though only sparingly, since it is rare as yet to find that the facts suffice for its application. It consists in the comparison of plants of near affinity from different strata, and deducing from their stratigraphical sequence a progression as regards some single character. This method has been carried out successfully by Mr. Kidston, in respect of the structure of the stele of Lycopods: he has concluded that "it is probable that the

¹ See Scott, *Studies in Fossil Botany*, pp. 494-497.

continuous ring of primary xylem is the older type of Sigillarian stem structure, and that the circle of isolated strands which form the primary xylem of the Clathrarian Sigillariae of the higher geological horizons has originated by a splitting up of the continuous-ring type of bundle; and as already mentioned, even in the few Clathrarian Sigillariae from the higher horizon of which the structure is known, the actual transition from the one type to the other can be observed."

"The *Lepidodendra* form, however, an older genus than *Sigillaria*, and extend to the base of the Carboniferous Formation. In beds not far above the base, and low down in the Calciferous Sandstone Series, specimens of *Lepidodendron* showing structure have been found; and of two of these occurring in the same bed, one species shows the continuous ring of primary wood, while the other possesses a solid cylinder of primary wood without any trace of pith; and although there occur here the two types of primary wood, side by side, still the solid cylinder type seems to be more common in the lower than in the upper horizons of Carboniferous Rocks, and the sequence of changes in the development of the primary xylem of the palaeozoic Arborescent Lycopods seems to point to the solid vascular cylinder as the oldest type, from which has been derived the medullate cylinder with a continuous ring of primary wood, and this continuous ring of primary wood has, in turn, broken up to form the isolated strands of primary wood found in the Clathrarian Sigillariae."¹ This is a good example of an evolutionary story, shown among plants of near affinity in respect of a single character, and based upon stratigraphical as well as structural comparison. Similar conclusions are emerging at various other points.

Another result of importance derived from Palaeontological study is less direct in its bearings on the story of descent: it is that by comparison of fossils with modern plants certain stereotyped views, based primarily on the study of modern plants, are liable to be revised, and relaxed. This may be illustrated by reference to secondary thickening in stems. It was formerly held that stems which showed well-developed secondary wood were necessarily referable to Seed-bearing Plants. Difficulties followed from the acceptance of this doctrine, and they culminated in the case of the Calamariae. Here the better knowledge of their anatomy, and of their fructifications showed clearly that a true Pteridophyte might attain large dimensions, and show a secondary thickening of its stem. Similar results are now familiar for other phyla of the Pteridophytes, and these facts, together with a better knowledge of recent plants, has shown that secondary thickening is a feature restricted to no single group of plants. Similarly, fossils have led to a relaxing of ideas respecting heterospory, and the seed-habit, and have helped quite as much as any study of recent forms, to the acceptance of a doctrine of parallel origin of marked characters independently in more than one line of descent.

¹ *Trans. Roy. Soc., Edin., 1905, vol. xvi., p. 548.*

But however valuable such results may be in leading towards a better knowledge, and more rational views, still they deal with relatively minor matters, and do not directly touch questions of prime origin. As to the early stages of evolution, of Bryophytes as well as Pteridophytes, the study of Fossils is still silent, and it seems not improbable that it will remain so. In order to frame some view of the prime origin of Land-Plants recourse must accordingly be taken to the only other method available for resolution of these problems, viz., the comparison of living forms. Experiment, another possible line of enquiry, but still in its infancy, is left out of account at present, for reasons explained above (p. 7). Those who deal habitually with the stronger weapon of direct historical fact involved in the study of the fossils are apt to feel some distrust of the more delicate weapon of comparison: it is liable to be weak and indecisive, and its results are much more in the nature of expressions of opinion than of actual demonstration. Still, so long as comparison is the only means available, it is necessary to use it, notwithstanding its weakness and uncertainty: while its conclusions will be checked, wherever possible, by reference to the more direct results of Palaeophytology. Such conclusions may ultimately come also under revision, on the grounds of their probability in the past, at the hands of the experimental morphologist. But as his experiments can never apply directly to any organisms except those now existing on the earth, the conclusions which he arrives at can never have the direct cogency which is inherent in Palaeo-phytological fact.

For reasons thus explained, it is upon comparative study that we must chiefly depend at present, when we attempt to trace the origin of the sporophyte generation, whether as exhibited in forms now living, or in those which the palaeophytologists are disclosing with such amazing rapidity.

CHAPTER XIX.

AMPLIFICATION AND REDUCTION.

WHEREVER the attempt has been made by studying plants as they are seen living or fossil, to link them together into some coherent evolutionary story, theories of phyletic amplification and reduction have been freely employed. Sometimes greater prominence has been given to the one, sometimes to the other.

The term amplification is used to embrace all changes leading to increased formal or structural complexity of the plant. It is necessary to distinguish between those changes of amplification which are individual and those which are phyletic. The former are the result of development traceable in some degree to the direct effect of external circumstances upon the individual organism: phyletic changes of amplification are those traceable as inherited from generation to generation in an advancing stock. But in actual practice it is difficult to discriminate between them, for the two are not different in kind: in point of fact it is only on a basis of comparison that phyletic amplification can be recognised: it may indeed be held to be a perpetuation of such individual amplifications as are transmitted in descent.

In the simplest cases amplification may be a consequence of mere non-localised distension of the plant-body; but in all more complex organisms growth is localised and continued at certain initial points, which thus take the character of apical cones, and define the polarity of the resulting structure. Or, furthermore, a secondary activity may appear in some intermediate zone, and new tissue be there intercalated: the common and obvious type of this is where increase in length or in width of the whole organ is the result, and that is what is usually understood as intercalary growth. But it would also include those developments of vascular tissue designated as secondary thickening. Closely associated with apical growth, but less commonly with intercalary growth, is the initiation of new apical points, which lead to the various modes of branching of parts. This has also played an important rôle in the origin of complex plants as we see them.

Reduction is the term used to connote the converse of amplification, and it also may be either individual or phyletic, where the development of the mature organism, either in whole or in part, in external form or in internal structure, falls short of that of the ancestry, the condition would be described as reduced: such a state may be held to result from a check in the development before maturity, as shown in the ancestry, had been attained. If such a condition become a character of an evolutionary sequence, then it would rank as a phyletic reduction.

Progressive amplification and progressive reduction are phenomena which may be illustrated in any phyletic sequence, and the question whether or not, and how far either has been operative in the history of descent in any specific case is virtually the equivalent of enquiry into its evolutionary history. The character of the progression may have varied at different times: in any stock a period of evolutionary advance may have been succeeded by a period of retrogression—or the converse. Further, it is to be noted that amplification or reduction may affect the organism as a whole, or only special parts of it. Moreover, different parts of the same organism may show evidence of having behaved in exactly converse ways in the course of descent. Examples of this are seen in every case of correlation, the amplification of one part habitually entailing the reduction of another.

To produce any organism as it is seen to-day, the two factors of amplification and reduction have been constantly possible throughout descent. The organism itself may be held to represent the sum of all such progressions and retrogressions, phyletic and individual. It is obvious that while reduction may have been active in the later phases, the balance taken over the whole evolutionary history must have been on the side of amplification, otherwise the organism would be non-existent. This may seem a mere platitude; but it is essential to state it, in view of the overestimate of the factor of reduction, as shown in most morphological discussions. This has resulted from the greater readiness with which evidence of reduction comes to hand, together with the method of our comparisons, which habitually start from pronounced "types."

The common criterion is that of mere size, but this carries with it differences of complexity, either of external form, or of internal structure, or usually of both. As a rule it is impossible to tell from a single specimen, or even from a number of representatives of a constant species whether the organism has been reduced or amplified in the course of its antecedent phyletic history: it does not bear any certain index of these points in its individual characters, unless in cases where reduction has led to change of the original function of a part. It is primarily upon the comparison of organisms related to any given species that an opinion may be based how far amplification or reduction respectively have been operative in its evolution.

In cases where there is good reason to believe that the phyletic origin is correctly recognised, and where the type is represented by numerous well-known species, a very strong presumption may be accepted, amounting almost to a demonstration, of what has taken place in the more recent steps of descent. This is more easily illustrated in respect of a given part, than of the whole organism. For instance, in the phyllodineous *Acacias* the progressive amplification of the phyllode and the progressive reduction of the lamina are practically demonstrated by comparison of the various species included in the single genus: the conclusion is further supported by the facts of development of the individual seedling: for the young plants frequently show in their ontogeny the steps which comparison among distinct species had already suggested. It is unnecessary to multiply examples of such phenomena, for they are familiar to every student.

It is, however, the familiarity with such ideas, in cases where sufficient evidence is available (a condition frequently seen among the Higher Plants), which has led to their misuse in cases where the evidence is less complete. Where ordinal or generic types are isolated, and the genera represented, it may be, by few species, or even by a single one, as is so often the case in the Pteridophytes, the weapon of comparison is apt to lose its temper and its edge. Still, it has been used, but in these isolated cases the comparative argument is less cogent, its application being more violent and less exact. The cogency of all morphological comparisons varies inversely with the distinctness of the organisms compared: this is especially to be borne in mind in dealing with questions of progressive amplification or reduction among the Archegoniatae.

Looking back upon the theories of amplification or of reduction which have been suggested in the past, it becomes evident that they have often been applied at random. That one or the other has been advanced according to the taste, or, one might almost say, according to the temperament of the writer: frequently they have been invoked under the pressure of doubt, or in support of an insecure hypothesis. More especially was this so in the days when monophyletic views ruled more than they at present do. A full recognition of the probability of polyphyletic origins has obviated the necessity which was once felt to refer all related organisms to one scheme: there is no present obligation to explain their form as derivative from one type, either by amplification, or by the more common *deus ex machina*—reduction.

Goebel has drawn attention to the prevalence in phyletic speculation of theories of arrest of development over theories involving amplification. He remarks that most of our phylogenetic series are reduction-series,¹ and traces this to the fact that a definite type is habitually recognised as a starting point for comparison. Naturally such a type must already be

¹ *Organography*, Part I., p. 60.

a thing with pronounced characters, otherwise it would not be held as typical: there will then be an inherent probability that allied forms would range themselves as reductions from such a type. On the other hand, in series which have really been ascending series, the original forms would not be prominent as types, and so would not be likely to command attention.

Commonly it has been on a basis of simple comparison that phyletic series have been traced; but it is plain that apparent sequences should be checked according to other considerations than those of mere formal comparison. The most important of such checks is that of physiological probability, or even in some cases possibility. In those phyla where the organisms are relatively isolated, and the wide gaps in the series make comparisons less certain, such checks are specially necessary, and in none more so than in the Pteridophyta.

There is overwhelming evidence that the homosporous state was the original condition of all the known phyla of Pteridophytes, as it is the uniform condition of all the Bryophytes. It may be assumed that it was while still in this condition that the leading characters of their several sporophytes were established, though in many of them the heterosporous state supervened at a later date. This brought with it complications of the factors which originally determined the form of the sporophyte. It is desirable to avoid any confusion of these later factors with those which determined the character of the sporophyte in its more primitive homosporous state. It will be best to put them on one side for the moment, and to confine the attention at first to the simpler problem of the evolution of the homosporous types: for this will be found to give a better insight into the principles relating to amplification and reduction, and the part which they respectively played in the evolution of the primitive sporophyte.

According to the adaptive theory of alternation, as stated in Chapter VI., the extended development of the sporophyte acted as an offset to those obstacles to fertilisation which faced aquatic organisms as they extended to a land habit. Where all germs are alike (homosporous), the larger the number of them produced the greater the probability of survival: thus selection would favour those with the highest spore-output. But to secure a high output of spores there must be an adequate supply of nutritive material: thus a condition of any extension of spore-output will be a due nutritive supply; and, conversely, any diminution of nutritive supply will reduce the output. The two systems, that of nutrition and that of propagation, will thus tend to vary together as regards amplification or reduction. And since in homosporous forms the highest chance of survival and of spread lies with those organisms capable of the highest numerical propagation, we should naturally anticipate that in them, other things being equal, a general progressive amplification would have the upper hand.

But it is to be remembered that in the plant-body the two functional systems, the vegetative and propagative, are not equally free of one another. In any independent organism the vegetative system may increase without any corresponding amplification of the propagative; but the latter cannot do so without the former, since it is dependent on the vegetative system for its nutritive supply. In the Archegoniatae this statement will hold for the organism as a whole, taking gametophyte and sporophyte as one. But if, as in the present work, attention be centred on the sporophyte, qualifications will require to be made: for a considerable proportion of the nutritive supply of the sporophyte may originate from the parent gametophyte. In the embryos of all the Archegoniatae this is the initial condition, and some of the simplest have never broken away from it; but in all the more advanced types the vegetation independence of the sporophyte is fully attained, while others hover in varying degree between self-nutrition and dependence. It thus becomes a question of the source of the nutritive supply in each separate case before it is possible to decide how the balance of the nutritive to the propagative system in the sporophyte has been adjusted in descent; and this is a necessary preliminary to any view as to the probable amplification or reduction of either.

It will be well to consider a few examples illustrative of the various degrees of embryonic dependence in Archegoniate Plants. In the sporogonium of *Riccia* there is no self-nutritive tissue: the supply comes entirely from the gametophyte: it may be a question for discussion whether the absence of a nutritive system is due here to reduction, or is itself the actual primitive state; but the latter is the view usually accepted. In most other Liverworts there is little or no functional nutritive system in the sporophyte. But the Anthoceroceae form an exception, and in them it is represented in varying degrees: in *Dendroceros* and *Notothylas*, and part of the genus *Anthoceros* there is chlorophyll-parenchyma in the sporogonial wall, but no stomata: but in the two sections of the genus *Anthoceros* with non-spiral elaters, the presence of stomata is a structural indication of the efficiency of the sporophyte in self-nutrition. It may, however, be a question whether the simpler Anthoceroceae are on the up-grade or the down-grade of development. That a down-grade of development may occur even among simple Liverworts has been placed upon a reasonable footing of probability by Lang, in the case of the genus *Cyathodium*¹ (Fig. 116), where it appears to be a consequence of growth in a moist, shaded habitat. Not only is the reduction effective in size, but also in complexity of the whole sporogonium; but the spores themselves, though numerically fewer, fully maintain their individual bulk. The foot is also reduced, and it is suggested as possible that the absence of a foot in the *Riccia* cell may be the consequence of still further reduction in them of a similar nature to that seen in *Cyathodium*.

¹ *Annals of Botany*, xix., p. 241.

Among the Mosses the small Cleistocarpic forms are virtually dependent for all their nutritive supply upon the Moss-Plant. In larger forms, such as *Mnium*, *Splachnum*, and *Buxbaumia*, there is a well-developed assimilatory system with functional stomata, and there is no doubt that it contributes materially to the nutrition of the sporophyte. But in some cases, such as *Sphagnum*, *Ephemerum*, and *Nanomitrium*, stomata, though present, are non-functional, a fact which indicates a probability that these sporogonia are now more dependent for nutrition upon the Moss-Plant than their ancestors were. There seems some probability also that there has been, in the genera last named, a reduction in the numerical spore-output. These examples from the Bryophyta illustrate how the sporophyte is variously dependent upon the gametophyte for nutrition; and that while

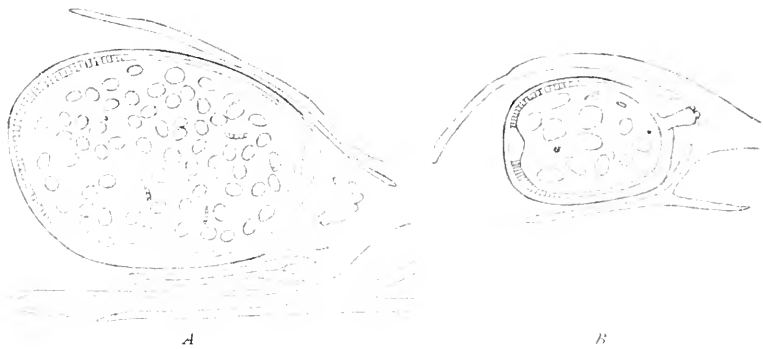

FIG. 116.

Longitudinal sections through sporogonia of *Cyatodium catenarium* (A), and *Cyatodium foetidissimum* (B), to show their position on the thallus and their relative size. In both cases the sporogonia contained spores and elaters with their walls thickened, but had not quite attained their full size. $\times 74$. (After Lang.)

in some cases provision has been made for some degree of self-nutrition, in others the dependence may have increased in the course of descent, as shown by reduction of the assimilatory system of the sporophyte; and there is also some indication that the spore-output has suffered by the change. Thus, notwithstanding their homoporous state, it would seem probable that phyletic reduction both of the vegetative system and of the spore-output has been operative among them in some cases in their neutral generation.

Among the Pteridophytes the embryonic dependence is usually brief: the young plant hastens to elaborate its own assimilatory system, and to become physiologically independent, as in any mature Fern, or Horsetail. But under some circumstances the period of dependence is liable to be extended, a condition which brings with it evidences of a corresponding reduction of the first-formed appendages. This is seen in certain embryos borne on underground, mycorrhizal prothalli, and examples of it are seen in the Lycopods, and in the Ophioglossaceæ. For instance, while *Lyc-*

pedium Selago expands its first leaves as green assimilating leaves, those of *L. clavatum* are developed underground, and appear as minute colourless scales, succeeded later by green foliage leaves (Fig. 117). Again, in *Botrychium virginianum* the cotyledon is a green, expanded foliage leaf: in *B. Lunaria* the first leaves are minute colourless scales. These cases from among the Pteridophytes illustrate in two distinct series how, where physiological dependence of the sporophyte is extended, owing to peculiar circumstances, a local reduction of its vegetative system may follow. They also have their interest for comparison with those Bryophytes which have non-functional stomata, for in both the gametophyte appears to have assumed increased responsibilities. Nevertheless, in these cases from the Pteridophytes, the plant when ultimately free shows no general reduction: the effect is local, and does not extend to the mature organism; moreover, there is no reason to see in such effects any reducing influence upon the ultimate spore-output.

Passing on to the independent sporophyte as seen in the Pteridophyta after the embryonic period is past, two cases require consideration: the autotrophic types, on the one hand, and on the other those sporophytes which show indirect nutrition, such as is seen in the mycorrhizic types. In independent autotrophic, homosporous Pteridophytes, the presumption, as has been seen above, would be that they would show evidences of amplification rather than of reduction. So strong does this presumption appear that, wherever a line of reduction is suggested for a homosporous type, it should be incumbent upon its author to show physiological reasons why it should have occurred. Mere morphological comparison without physiological support should be held as an insufficient basis for theories of general reduction in homosporous forms.

But examples of special reduction, affecting parts or details of homosporous Pteridophytes, are not uncommon. It seems not improbable that the leaves of modern species of *Equisetum* are reduced as compared with those of early Calamarian forms, and this may be held as correlative to the development of the cortex in *Equisetum* as an effective assimilating tissue. Certain of the leaves of *Osmunda* have an arrested lamina, while the leaf-base remains as part of the protective armour which covers the axis: potentially these are complete leaves, and their arrest before maturity may be held as a case of reduction. Such examples as these are in the nature of correlative adjustment of



FIG. 117.

Seedling of *Lycopodium clavatum*.
(After Bruchmann.) *r*=root; *f*=foot;
r=root; *bl*=leaves here represented
as minute underground scales

parts of the shoot, *inter se*, and cannot be held to be examples of general reduction.

There remain to be considered those sporophytes which show some form of indirect nutrition, the commonest of which is the mycorrhizic symbiosis. The occurrence of a symbiotic state is often loosely held to be equivalent in itself to a demonstration that the organism in which it occurs has been the subject of general reduction; and reference is apt to be made in support of this to extreme cases, where it has in fact led to complete saprophytism. But it is necessary to be clear what effects they are which necessarily follow upon this habit, as apart from those which are occasional and extreme: for it is only the former which can properly be counted on for argument. Stahl has indicated that the usual structural concomitants of mycorrhiza in green plants are such as lead to economy of the water-interchange:¹ viz., a restricted root-development, with thick unbranched roots, and absence of root-hairs: little structural provision for water-transfer and an absence of organs of water-secretion: while a leathery texture of the leaf, a feature of other plants which economise water, is not uncommon. But these characters are by no means uniformly or exclusively found in mycorrhizic plants: for instance *Cyathea* is mycorrhizic, but it shows such characters as the leathery leaf less obviously than *Asplenium nidus* and *Osmunda regalis*, which are not. When present the features above named may be held to be indicative of a probable reduction in respect of the parts immediately affected; but that is a very different thing from the general reduction which is sometimes assumed to follow mycorrhiza as a necessary consequence. General reduction implies an effect on both the nutritive system and the propagative system. But it is to be clearly understood that so far as the mycorrhizic habit affects nutrition, by yielding as it does in some cases an efficient saprophytic supply, the reduction will appear in the vegetative system only, and not in the propagative. This is amply illustrated in Phanerogamic plants such as *Neottia* and *Sarcodes*,² where the flowers and fruits remain of the usual types though the vegetative system is reduced. Similarly, among Pteridophytes, if mycorrhiza were really effective in them as a considerable means of saprophytic nourishment, we should expect the consequent reduction to appear in the vegetative system, with a loss of chlorophyll in extreme cases; but that the spore-producing parts should remain of the usual dimensions and character of the family: that is, supposing the saprophytic supply to be as efficient as the normal chlorophyll nutrition. Now, putting aside certain exceptions to be noted below, such a condition is unknown among Pteridophytes, and its absence goes far to show that the mycorrhizic symbiosis seen in them is not a fully effective source of organic nutritive supply. The facts do not bear out the general assumption that mycorrhizic symbiosis, as seen in certain of

¹ *Pringsh. Jahrb.*, xxxiv., p. 539.

² See F. W. Oliver, on *Sarcodes*, *Ann. of Bot.*, iv.

the Pteridophytes, leads to a general reduction of the infected sporophyte as a whole.

The particular family in which the argument relating to mycorrhiza has been specially applied is the Ophioglossaceae. A more detailed account of it will be given where the family is specially described below; but meanwhile it is to be noted that there is throughout the Adder's Tongues a close parallelism of proportion of the sterile lamina to the fertile spike: this is indeed one of the most remarkable features in the morphology of the family, the parallelism extending not only to the size of the respective parts, but also to the character and extent of the branching of each. If saprophytic nourishment by the mycorrhiza were in this case a real substitute for chlorophyll-assimilation the sterile lamina would fall behind the spike in its dimensions; but in the normal representatives of the family it does not. The conclusion follows that in the mature sporophyte of the Ophioglossaceae the mycorrhiza is not functionally an effective substitute for nutrition by chlorophyll-assimilation.

There is, however, one series of species in that family in which the proportion of the two parts is not maintained, viz., the section *Ophioderma* of the genus *Ophioglossum*. Here the epiphytic *O. pendulum* shows approximately the usual balance; but in *O. intermedium*, a land-growing species, the sterile lamina is relatively small, while in *O. simplex*, also a ground-growing species in which mycorrhiza is present, the lamina appears to be altogether unrepresented. I regard this section, *Ophioderma*, as a series in which mycorrhiza has become effective as a substitute for chlorophyll-nutrition, and that reduction of the vegetative system has actually followed as a consequence: nevertheless the spike, being effectively nourished, retains its dimensions. But disturbance of the balance of the vegetative and reproductive systems such as this is a very different thing from any general reduction of both, such as is sometimes assumed to follow in consequence of a symbiotic habit.¹

Another family which provides an interesting parallel in this respect to these Ophioglossaceae is that of the Psilotaceae. In *Tmesipteris* there is a reasonable balance of size between the forked sporophyll and the bilocular synangium. In *Psilotum* this balance is not maintained, for the small sporophylls are ineffective as assimilating organs while the trilocular synangium is still of large size. It is true the green axis is an effective organ of assimilation, but it would appear probable that the mycorrhizic state also assists.

The discussion of the parts played respectively by amplification and reduction in the genesis of the homosporous sporophyte may now be summed up. The end of its development is the production of the largest number of effective germs. To increase their number involves amplification of the propagative system. This involves also in many cases amplification of the nutritive system. However, this is not an

¹ See Scott, *Studies*, p. 511.

end in itself, but only a means to the end, viz., the suitable nutrition of the nascent germs. There are several ways in which this nutrition may be effected; they are these:

- (1) Nutrition by the gametophyte, which was the most primitive method.
- (2) Self-nutrition of the sporophyte by its own assimilatory system.
- (3) Indirect nutrition of the sporophyte, *e.g.* by mycorrhiza.

Provided the spore-production be maintained, it matters not which of these is effective, or dominant in any individual case; and in point of fact they have varied in the phyletic history. In the original state of the sporophyte there was undoubtedly nutrition by the first method. Subsequently the second supervened; and there is reason to think that during the phyletic history there has been a varying balance of the effectiveness of these two factors. Generally speaking (1) has waned in importance proportionately to the whole requirement; but in such cases as the Moss-sporogonia with non-functional stomata, and in the large underground prothalli of Lycopods and Ophioglossaceae (1) appears again to have increased in proportional importance, encroaching upon the effectiveness of (2), with the result that local reduction of the mechanism of self-nutrition in the sporophyte followed; but still that may have produced no ill effect upon the spore-output. Passing to the independent sporophyte, its primitive nutrition was autotrophic (2), and there was a suitable balance of the nutritive and propagative systems, the method of which differed in the different phyla. Lastly, in those cases where indirect nutrition (3) by mycorrhiza contributes effectively, a reduction of the normal nutritive system of the sporophyte may take place; but so long as the sum of nutrition is maintained the propagative system would not be reduced. If, however, for any reason the sum of nutrition fall, then general reduction would ensue.

It is not then enough to suggest reduction on mere grounds of comparative convenience: to make the suggestion convincing in any group where general reduction is believed to have occurred, it will be necessary to prove that the sum of nutrition, from whatever source, has diminished in the course of descent, and that reduced spore-output has been the result. Until this has shown to have occurred in any case, there seems no sufficient reason to accept as more than a quite open hypothesis any suggestion of general reduction of its sporophyte. The biological probability is against extensive, or general, reduction in homosporous forms, and in any case the positive balance during the whole phyletic history must have been on the side of amplification.

But where there is heterospory, and especially in plants showing the seed-habit, where a high certainty of a germ becoming effectively established is attained by storage in the enlarged spore, reduction in the number of spores followed, and the cognate reduction of other parts assumed many

different forms. These need not be detailed here: it will suffice to quote as one example of a case fully made out the reduction of the sporophyll in the Cycadales.

It is thus seen that hypotheses of relative primitiveness, or of reduction as applied to living organisms, do not stand on an equal footing. The former has the logically prior claim, and should be accepted as a working theory until good grounds can be given for preferring the latter; and the mere exigencies of comparison will not be sufficient: a proper foundation can only be sought in the biological circumstances of the organism in question. Such evidence is specially necessary when dealing with homosporous forms, in which the problem is more directly one of size, nutritive capacity, and consequent spore-number, than in the case of those which are heterosporous.¹

¹ Compare Bower, *Science Progress*, vol. iv., p. 358, etc. Also Tansley, *New Phytologist*, vol. i., p. 131.

CHAPTER XX.

SUMMARY OF THE WORKING HYPOTHESIS.

It will be useful to collect the substance of the preceding chapters into a more concise form, hypothetical and uncertain as in their very nature any conclusions must necessarily be.

The general problem of the origin of a Land-Flora is not to be solved by mere observation of the present-day distribution of the organisms composing it; some other basis for an opinion must be sought. The problem has been approached primarily from the point of view of the individual life; and special regard has been given to the relation which subsists between the environment and fertilisation, the most critical incident in the life of any organism (Introduction).

It seems probable that certain Algae represent in their general characters the original source from which the Land-Flora sprang. Their prevalent method of fertilisation by motile gametes is by many held to show a reminiscence of their ultimate origin from the free-living Flagellates: however this may be, the gamete motile in water is a character which many Algae share with the Archegoniatae; it is a feature essentially typical of aquatic vegetation.

In respect of their whole life-cycle the Archegoniatae may be said to show an amphibial existence, the aquatic and the terrestrial characters being reflected in its two alternating phases (Chapters II. and III.). The gametophyte is as a rule delicate in texture, without intercellular spaces in its tissues, or a fully developed water-conducting system, while its sexual organs only become functional on their rupture in water outside the plant-body: the gametophyte thus proclaims its ultimate dependence on external fluid water as thoroughly as an Alga. The sporophyte, on the other hand, is a characteristically subaerial body: this is shown by its more robust habit, its effective ventilating system, and its vascular strands for the conducting function seen in all the higher forms: its final result, the maturing and dissemination of spores, is normally carried out under circumstances of dryness. All these features mark it as an essentially terrestrial phase.

The Archegoniatae themselves retain with remarkable pertinacity the awkward and embarrassing mode of fertilisation through the medium of external fluid water. But with the advent of the Seed-Habit this became modified: finally the sperm was no longer set free as a cell motile in external water, but fertilisation came to be effected by means of a closed pollen-tube. Thus the higher Seed-Plants at last became typically terrestrial organisms, breaking away from the last vestige of the amphibious habit of their progenitors, the Archegoniatae.

But all this was not achieved suddenly. From living organisms, and in some degree from fossils, indications may be gathered of the various steps which led to the establishment of the sporophyte as the essential feature of a Land-Flora. Tracing these steps backwards it is possible to obtain a clue from the simpler aquatic organisms: these plants give the best indication available how the initial start was probably made. There is reason to believe, on grounds of comparison, that the sexual generation or gametophyte was the prior existent, and that the neutral generation or sporophyte arose as a phase intercalated in the course of descent between successive gametophytes: that the initial step which led to this was the existence of those complications of cell-division which appear in so many of the lower plants as a consequence of sexuality, and are connected with the reduction of chromosomes already doubled in the sexual fusion of nuclei. It is certainly the fact that in some Algae such post-sexual divisions do result in the production of a plurality of germs: biological circumstances which would encourage the multiplication of those germs might be expected to lead towards the establishment of a neutral generation. In plants exposed to changing conditions of moisture and of drought, such circumstances would be specially effective, and this must naturally be the position of any which spread to a land-habit. Here access to external fluid water would be an occasional rather than a constant occurrence: consequently sexuality could only be carried out occasionally, when water was available, while it would be precluded under dry conditions. Less dependence could then be placed on sexuality for increase in number of individuals, and a premium would be put on an alternative mode of propagation, suitable for dryer circumstances. The post-sexual divisions accompanying reduction would supply the initial state upon which variation and selection could work towards this end, and by an increase of these divisions the number of post-sexual germs would be increased. It is thus seen that the biological conditions involved in the transition from water to land would naturally encourage some form of amphibious alternation (Chapters V. and VI.).

The establishment of a Land-Flora thus involves the origin of a body adapted to terrestrial life; and as such the sporophyte is to be recognised. Its first function, as it is also its final office even in its most elaborate forms, is to produce spores. The spores of the simpler Archegoniatae are all similar and equivalent germs: the larger their

number the better the chance of survival; in this may be found the rationale of the enormous numbers of spores habitually produced by the homosporous Archegoniatae. To protect them while young, and to nourish them during their development presupposes some vegetative system, which will require to be more elaborate the larger the number of spores. The protection is in part supplied by the parent gametophyte, though in all but the simplest it falls on the sporophyte. The nutrition may also in some cases be supplied by the gametophyte, as it is in the simpler Liverworts and Mosses; but in the more advanced forms, after the first embryonic stages are passed this duty falls on the sporophyte itself, as in the Vascular Plants. The comparative study of the sporophyte in its various living forms suggests certain factors of advance, which led to its becoming efficient for carrying out these functions of protection and self-nutrition, and thus conduced to its final independence; the most important of these are: (i) sterilisation of cells potentially sporogenous, so as to supply a vegetative system (Chapter VIII.); (ii) the segregation of the sporogenous tissue into distinct pockets, or sporangia, thereby facilitating nutrition and dispersal (Chapters VIII. and IX.); and (iii) the origin of appendicular organs, which serve a variety of purposes beyond the usual direct ones of supporting the sporangia, and of nutrition (Chapter XI.).

Sterilisation of cells potentially sporogenous is a feature which is very widespread among living sporophytes: evidence of its occurrence may be drawn from all the main groups composing the characteristic Flora of the Land (Chapter VII.). The argument to be based on this fact is as follows: it is seen in plants of the present day that in definite cell-groups of the sporophyte, which may be recognised as sporogenous, sometimes the whole body of the cells undergo the tetrad-division, and form spores; in other cases, while certain cells of such groups are fertile, other cells of like origin with them remain sterile: these may, however, subserve various purposes in less direct relation to the production of the spores: in certain cases the sterile cells may even develop as permanent tissue. The conclusion from this is first ontogenetic: viz., that the sterile cells, being sister cells with those which are fertile, are potentially sporogenous cells which have been diverted from their original purpose, and that their potential spore-producing capacity has been sacrificed to ensure the success of those which remain fertile. The second conclusion is phylogenetic, and it follows from the fact that examples of such sterilisation may be drawn from all the main groups of Plants which form the characteristic Flora of the Land: it is that such transformation of cells from the fertile to the sterile condition as is seen so commonly at the present day, was also of common occurrence in the course of evolution of the sporophyte. It would be going too far to say that there is in this any demonstration of the source from which all vegetative tissues of the sporophyte have been traced; but at least this is a justifiable working hypothesis.

It is possible to conceive of an indefinite increase of the sporophyte, by continued cell-division and progressive sterilisation, in a body maintaining a simple form; but mechanical and physiological checks impose a moderate limit. The Bryophytes illustrate in some of their forms such progress in the sporophyte successfully carried out to a relatively high degree of complexity. But in all their more advanced types there is a distinction of apex and base, the basal region being sterile and the apical region fertile. Their sporogonia, however, always retain a simple form, and with few exceptions the radial type of construction: they are all alike also in having a single continuous spore-sac. This is plainly a type of construction which has its limits imposed by mechanical and physiological conditions. Reasons such as these have tended to prevent the Bryophytes from developing their sporogonia beyond a very moderate size. They show, however, very clearly on comparison the successive steps by which progressive sterilisation may advance the complexity of a simple type of sporophyte (Chapters III. and IX.).

But the Vascular Plants, while showing the same plan of life-cycle, have been able to continue development without those mechanical and physiological checks operating upon their spore-output. The outstanding features in which they are more free than the Bryophytes follow from the segregation of sporogenous tissue in distinct sporangia, and the formation of appendicular organs. The biological advantages thus attained are obvious: a plurality of sporangia makes possible the separate, and more efficient nutrition of each: thereby also the mechanical difficulties, which act in limiting the Bryophyte sporogonium, are effectively avoided. On the other hand, the development of appendicular organs makes independent self-nutrition of the sporophyte really effective, while the position of the sporangia on the appendages facilitates the dispersal of the spores. The palaeontological record shows conclusively that both of these features were of very early date, and their consequences are illustrated in the earliest fossils of which there is any detailed knowledge (Chapter XVIII.). The advantages secured by an unrestricted type of development were doubtless such as to lead to a rapid advance. It can therefore be no matter for surprise that connecting links between the two states are absent, even supposing the two phyla, in which they are characteristically shown, to have had some degree of community of origin.

The Pteridophytes show diversity of type, according to the size of their appendages: those which are smaller-leaved, as in the Lycopods, Equiseta, and Sphenophylls, have as a rule a terminal strobiloid fructification, though this is not always clearly differentiated from the vegetative region. In the Fern-like types the fructification is disposed more generally over the enlarged leaves. As in the Bryophyta so in the strobiloid Vascular Plants, a sterile basal region precedes the terminal fertile strobilus. This vegetative region may be held to be a phase

intercalated as a consequence of sterilisation, and will therefore take a secondary place. An important question will then be how this more elaborate condition of the strobilus of Vascular Plants came into existence. Any theory of the origin of the strobilus should be based upon detailed knowledge of its structure and development, in forms living and fossil, and of its parts: these are the axis, which is the central part in any strobilus; the appendages; and the sporangia, which are usually produced in relation to the latter. These parts will require separate consideration.

A detailed study of the sporangia of Vascular Plants has led to the following definition of the sporangium (Chapter VIII.), which discards non-essential and fluctuating characters, and retains only what is essential and constant. "Wherever there is found in Vascular Plants a single spore-mother-cell, or connected group of them, or their products, this, together with its protective tissues, constitutes the essential of an individual sporangium." In many cases the sporogenous group is not strictly circumscribed, but has ragged edges: cells which are sister-cells may not unfrequently be found to develop the one sterile, the other fertile. On the basis of structure this is consistent with the view that each fertile tract is a residuum left by advancing sterilisation. In the simpler strobiloid types the sporangia are associated, singly or in small numbers, with appendages of various form and nature, which arise laterally, and in acropetal succession, as superficial outgrowths from the pre-existent axis: these are designated in various cases sporophylls or sporangiophores. The theory of the strobilus, stated in Chapter XI., uses the structural and developmental facts thus briefly summarised in the following way. It assumes, first, a sporophyte-body, already showing a distinction of a basal vegetative and an apical fertile region. This was endowed with apical growth, and an acropetal succession of its spore-development. The latter was relegated towards the surface, a change clearly indicated by the analogy of the Liverworts and Mosses. That by advancing sterilisation the fertile tissue underwent segregation into separate pockets, or sporangia, and that, by enation from the surface, appendages were formed in acropetal succession, of the nature of sporangiophores, or sporophylls: upon these the fertile loculi would be borne outwards, as they are seen to be in the individual development of sporangiophores to-day. The apically growing axis would thus have been the pre-existent portion of the shoot, and the successively formed appendages secondary, as they are in the actual development. It has been shown that every one of these steps has its prototype among living plants: moreover the theory is in accordance with the ontogeny at every step (Chapter XI.).

In the strobiloid type of the Lycopods the sporangia are definite in position and in number: while the relation of them to the bulky axis is very close. This is held to be a primitive condition, and palaeophytology shows that it was existent among the earliest fossils. In others,

also probably primitive and certainly early, the appendages are larger, and the sporangia more removed from the axis; and in proportion as this is so their number is less precise. But even where the appendages are largest, as in Ferns, or Ophioglossaceae, the relation of leaf to axis remains essentially the same.

The variations of number of sporangia actually seen as effective in Vascular Plants have been discussed in Chapter X., in which methods of increase are separated from those of decrease. Both of these are liable to be disguised by the swamping effect of continued apical growth, and of branching of axes and appendages, which are so prevalent in Vascular Plants. But, putting these more obvious sources of numerical change of sporangia aside, there are others which have also been effective, and have probably played an important part in evolution. As factors of increase in number of sporangia septation and interpolation are to be recognised. The former of these has probably been underestimated hitherto in its evolutionary effect: numerous synangial bodies in Pteridophytes are compatible with it, and each must be considered on its merits: moreover, septation is demonstrated to have actually occurred in the anthers of a number of Angiosperms. Interpolation of new sporangia among those previously present, on the other hand, has hitherto been overestimated: in certain of the simplest forms, and particularly in the Lycopods, it is non-existent: it is more prominent in larger-leaved forms, where sporangia are indefinite in number, such as the Ferns, and it has played an important part among the later Polypodiaceae; but no clear case of it is known among Palaeozoic Plants. It is held as a relatively late mode of increase, initiated as a secondary phenomenon, and it cannot be assumed to have been of general occurrence in the course of descent.

Among the factors of decrease in number of sporangia the arrest of apical growth in axes, or in appendages, has probably been one of the most effective, and especially so in the later types of development; but as this, where operative, would leave no trace behind of what had actually occurred, it is liable to be underrated in its effect. The chief remaining factors of decrease are fusion of sporangia originally distinct, and abortion. The former of these has probably been overestimated hitherto in its evolutionary effect: the assumption has been too generally made that synangia are the result of fusion of sporangia originally separate. Each such case must be considered on its merits, but with the full consciousness that septation will produce results structurally similar to those of fusion. Abortion has been altogether underestimated in dealing with early Vascular Plants. In the Lycopods there is ample evidence of its effect; and it is to be remembered that where abortion is complete, no vestige remains to show what has taken place (Chapter XIII.).

The condition of any poly-sporangiate sporophyte, regarded from an evolutionary aspect, may be held to be the resultant of such conflicting factors of increase or decrease as those mentioned, which were operative

during its descent. The problem will therefore be to assign its proper place in the evolutionary history to any or each of these factors. But to do this presumes a knowledge of that history more complete than is at present accessible: still it is well thus to formulate the problem, with a view to clearing the points at issue.

The sporangia are rarely inserted directly on the axis, but usually on appendicular organs of various form and size: these have been designated in some cases sporophylls, in others sporangiophores. Reasons have been assigned in Chapter XII. for the opinion that all these appendages are not to be held as referable to any single original category of parts, such as the formal morphology of the higher plants would recognise. According to a strobiloid theory there is no need to assume that all appendicular organs were alike in their initial character, though circumstances may have led to their ultimately settling down to a more or less uniform type among plants of advanced development.

The term sporangiophore is applied to certain appendages which bear one or more sporangia, and are traversed as a rule by a vascular strand for their supply. Their position may be directly upon the axis, as in the Equisetales; or upon some lateral appendage, as in *Helminthostachys*; or on the surface or margin of a leaf, as in Ferns, where they are commonly called sori. The sporangiophore, wherever found in primitive forms, may be held to be itself a primitive structure, and is not to be assumed to be a result of modification of any other sort of appendage (Chapter XII.). The position which "foliar" parts hold relatively to sporangia or sporangiophores is frequently that of subtending them, as though determined by some function of protection, or, in some cases, of nutrition. It is illustrated in the Lycopods, the Sphenophylls, and the Ophioglossaceae: and with less regularity in the Calamarians. These relations are probably due to some common causal circumstances.

Such discussions naturally open up the question of the nature and origin of those parts which are comprehended under the term "leaf." So long as the fossil record remains as imperfect as at present, there can be no certain knowledge on these points, since the foliar development was present in the earliest vascular fossils of which there is certain or detailed evidence: accordingly the question can only be approached on grounds of comparison. There is reason to believe that the Bryophytes acquired their leaves polyphyletically, and this consideration would suggest that the foliar appendages of Vascular Plants may also have been polyphyletic; this position, which accords with their differences of character, is quite compatible with the strobiloid theory (Chapter XII.). One point which follows naturally from the observation of the earliest stages of development of foliar organs, whether in the sterile or the fertile shoot, is their lateral origin below the apex of the axis which bears them. In the ontogeny the axis pre-exists the youngest leaves: this is believed to have been the case also throughout descent (Chapter XI.).

Though the evolutionary origin of the leaf must be still a matter of doubt, there is less uncertainty as to the relation of the sporophyll to the foliage leaf (Chapter XIII.). The idea of "progressive metamorphosis" from the foliage leaf to the sporophyll, as propounded by Goethe, is incompatible with the strobiloid theory as above stated: the converse of Goethe's progressive metamorphosis will appear to have [occurred, viz., that at least in some cases, and perhaps in all, the foliage leaf is a sterilised sporophyll: thus the vegetative region, though ontogenetically the first, is held to be phylogenetically the derivative not the primitive condition of the shoot. The evidence that this is so is primarily based upon broad comparison; but secondarily upon the existence of abortive sporangia in certain Pteridophytes, about the limits of the vegetative region. It is further pointed out that in cases of complete suppression, where no vestige remains of the undeveloped part, there is no structural evidence that the abortive part ever existed: this will account for the apparent deficiency of more direct evidence bearing on the origin of the vegetative system. The result is a basal vegetative region, more or less clearly defined from a terminal strobiloid region, the latter retaining the primitive characters and the spore-producing function. A vegetative region thus established in any phylum as distinct from the fertile, may undergo a distinct progressive evolution of its own, according to its special nutritive or other function; and the result may be as wide a divergence in character of the two parts. But in many Pteridophytes the differentiation is not effectively carried out; as is seen in the "*Selago*" condition of *Lycopodium*; or in many Ferns, in which any of the vegetative leaves may bear sori.

The anatomical characters of the shoot accord readily with the theory of the strobilus (Chapter XV.). The non-medullated monostele is generally accepted as the primitive type, and the more diffuse vascular conditions with medulla and ultimately with separate strands as derivative types; and this holds even in the megaphyllous forms, for their individual life habitually opens with a protostelic condition of the axis, which may subsequently pass into some more diffuse structure. This is held to indicate a prior state of the shoot where the axis was structurally dominant, and the appendages small: the more complex vascular arrangements go along with an increasing influence of the leaf in the shoot, and are the internal expression of it. On the theory of the strobilus this is a secondary condition, as in the anatomical history of the individual it is seen to be.

The embryology of the sporophyte generation has figured largely in comparative argument. It is pointed out in Chapter XIV. that the importance of the earliest stages has been greatly overestimated. It has been shown that neither the initial segmentation of the embryo, nor the continued segmentation at the growing point bears any constant relation to the genesis of appendages, or of specific tissues. It thus becomes apparent that the early details of segmentation themselves are not

sufficiently trustworthy guides in the study of the origin of members, except perhaps between closely allied organisms. The present tendency is to study the embryo biologically, rather than as an embodiment of early historical fact: and to recognise that the various appendages of the embryo originate in such positions, and at such times as are most suitable for the performance of their functions. The demonstration that "free-living" leaves or roots may occasionally exist, suggests that some such degree of freedom may rule also in the first stages of the embryo.

There is, however, one relatively constant and fixed point in the embryology of Pteridophytes; it is the position of the apex of the axis in close proximity to the intersection of the octant walls in the epi-basal hemisphere. This at once defines the polarity of the embryo, whether or not the axis may assert itself early by active growth. But when once the more plastic stage of the embryo is past, and the characteristic form of the plant established, this would seem to be a more reliable basis for comparison than the first phases of the embryo (Chapter XIV.).

A general comparison of the shoot in the sporophyte generation as regards symmetry leads to the conclusion that it was originally radial (Chapter XVI.). In the Bryophytes the sporogonium is a body which shows polarity, but retains with very few exceptions the radial symmetry. In the Pteridophytes many retain the radial symmetry also; but others depart broadly from it, some at an early period of the individual life, others at later periods. These changes may be referred to the unequal incidence of external conditions, and it has been shown experimentally that a radial structure may be influenced towards dorsiventrality by such external causes as unequal incidence of light, or of gravity. This has been the probable origin of the dorsiventrality as seen in the sporophyte. A comparison of the representatives of the same phylum among themselves frequently indicates that those genera or species which are radial are less specialised in other respects than those which are dorsiventral: this is particularly clear in the Lycopodiales, as also in the large-leaved Ophioglossaceae and Marattiaceae. A careful review of the various phyla of Pteridophytes leads back constantly to the radial type as primitive. The fact that the radial construction is predominant in the Equisetales, Sphenophyllales, and Lycopodiales, while it is prevalent also in the Palaeozoic Filicales, shows how strong a hold it had among the earliest types of Vascular Plants.

There is little evidence from plants of the present day of the existence of a primitive, permanently free-living, but rootless state of the sporophyte (Chapter XVII.). There is no certain knowledge how the root originated: it is clear, however, that in the Lycopodiales the structure of the root is more like that of their axis than in other plants, while the comparison may also be strengthened by the fact of its occasional exogenous origin in those plants, and its dichotomous branching. Further in the same phylum there exist in the Stigmarian trunks, and the rhizophores of

Selaginella, parts which are neither true roots nor axes, but serve as bases of attachment for roots. Though these bodies do not as yet greatly help to solve the question of origin of the root, they draw attention to the Lycopodiales in connection with any discussion how a subterranean absorptive system originated. In the vast majority of Vascular Plants the root is formed early, and is ready as soon as the embryo projects from the prothallus, to take up its physiological duty. There seems in them no need to assume that they achieved their independence through an intermediate "protocorm" stage. It is quite as probable that the transition was in descent, as it is to-day, directly to the rooted state.

The general conception of the rise of the sporophyte embodied in the preceding chapters differs in its tone and tendency from some of the writings which have preceded it. The attempt has here been made to treat the sporophyte consistently throughout: to apply the same point of view to the Vascular Plants as to the Bryophytes. One important difference between the morphological method adopted here and that of some other writers is that it gives a less prominent place to hypotheses involving reduction from a more complex ancestry. The general principle here has been to assume that morphological characters are in the up-grade of development, unless there is good reason for holding a contrary opinion; and only to admit that an organ has been reduced from some more elaborate body when there is some assignable reason (comparative or physiological, but preferably both) for that conclusion (Chapter XIX.). A theory of reduction has never been resorted to merely as a means of resolving a difficulty of comparison. The position adopted has accordingly been to regard it as probable that the smaller-leaved types were themselves primitive as a rule, though in some there is evidence of probable reduction; and to contemplate it as probable that microphyllous have given rise to megaphyllous types. It is highly probable, on the other hand, that reduction of size and complexity has been highly effective in certain phyletic lines: for instance, the recognised evolutionary story of the Cycads involves extensive reduction of the sporophylls. But for the primitive strobiloid forms, it would seem to harmonise better with their early occurrence, and their morphological characters, to hold that they represent a relatively primitive condition, rather than a down-grade of morphological complexity.

The recent changes of view have been in great measure due to the extension of the knowledge of the fossils, both stratigraphically and morphologically. It is true that such data are seldom decisive on questions of comparison (Chapter XVIII.), but the case here is a strong one. It is found that strobiloid forms are at least as early in occurrence as large-leaved Fern-like types. Further, they appear not only to have been present in the earliest fossil-bearing strata, but also well represented in numbers and in variety of type. This has brought with it the conviction that the strobiloid type has quite an equal right with any other to be

held as itself of primitive character. Whether the facts justify the conclusion that the megaphyllous types are derivations of a microphyllous strobiloid ancestry, the fossil record does not disclose. The only avenue to an opinion is then a detailed comparison of the known representatives. It will be the object of the Second Part of this work to supply such comparisons, relating not only to this important question, but also to the whole theory of the strobilus, as stated in the First Part.

PART II.

INTRODUCTION.

WE proceed now to deal with the detailed statement of facts bearing on the theoretical position expounded in the First Part of this work. The arrangement to be adopted must not be understood as indicating any definite opinion as to kinship of the several phyla described: it is often dictated by convenience of exposition, as much as by the estimate of degrees of affinity. Moreover, to any who entertain a belief in polyphyletic origins, it will be clear that any simple serial sequence must be misleading. The primary end here pursued is not to assign degrees of affinity to the relatively isolated relics of a former World-Flora: such relations must always remain highly problematical, so long as the data remain as incomplete as they at present are. The object is rather to frame some general idea of the methods of advance of the sporophyte; and to trace the effects of those methods from its simpler beginnings to its final condition as an independent plant, forming the essential feature of the Flora of the Land. Such a study must depend largely on details. Those details will now be put together in systematic sequence.

It may be objected that the scheme of this book is a reversal of the ordinary logical procedure of using the facts as a basis for the conclusions. But in point of fact, it is not so: for in writing the preceding chapters which have dealt with the general theory, all the data now to be described were before the mind of the author, and formed the natural foundation of his thoughts. It is for the convenience of readers that the working hypothesis has been stated first, so as to convey the point of view from which the facts may be examined and appraised. The detailed statement will thus be more intelligible in its bearing on the question of the origin of a Land-Flora, than would otherwise have been possible. It will hardly be necessary to repeat again that the general theory of the foundation of a Land-Flora as a concomitant of antithetic alternation has been stated only as a "working hypothesis": it is now to be tested by its applicability to the details which are to follow. The course adopted

will be to start with the simpler types, and to proceed to the more complex. The presumable course of progressive evolution will thus be followed, but only in the broadest lines. Paragraphs will be inserted from time to time, pointing comparisons from one phylum to another; and thus some general conclusion may be arrived at as to the stability of the "working hypothesis."

It may be anticipated that the first place in the detailed description will accordingly be given to those Algae which show post-sexual developments of the nature of a sporophyte, inasmuch as their nuclei have a double chromosome-number. But it seems unnecessary to give any more detailed account of these than that already embodied in Chapter V.: for at best these Algae only show that such post-sexual complications do exist among them, while none of them can be accepted as direct lineal progenitors of even the simplest of the Archegoniatae. It is therefore sufficient for our present purpose to recognise again the fact that they suggest how the antithetic alternation seen in the Archegoniatae may have originated.

With these remarks the Thallophytes may be left on one side: it is reasonable to expect, however, that in the future a better knowledge of them may result in their being drawn more directly into discussions of the origin of alternation; but at present they have only a remote, and chiefly a theoretical connection with the question of the origin of a Land-Flora. Such materials as are available for the elucidation of this question are to be sought for in the study of the Archegoniatae, organisms which show themselves already fitted in greater or less degree for life on exposed land-surfaces.

In treating the Archegoniatae there will be no need to give any detailed description of the gametophyte: this is already adequately done in the *Mosses and Ferns* of Campbell, and in the *Organography* of Goebel. It may be necessary to refer in some special cases to the gametophyte in order properly to understand the sporophyte which it bears; but excepting in such cases the gametophyte will be omitted from our descriptions: and thus the subject resolves itself into a comparative examination of the sporophyte in the Archegoniatae, from the general point of view laid down in the foregoing chapters.

CHAPTER XXI.

BRYOPHYTA.

I. HEPATICAE.

THE Liverworts include three main series, which differ, not only in the structure of the gametophyte but also in the details of the sporophyte; the differences are sufficient to require their separate treatment: the three series are—the Marchantiales, the Jungermanniales, and the Anthocerotales. The results acquired from any one of these series may be brought into comparison with those from any other, and suggestive side-lights may thus be gained on the methods of advance of the sporophyte which they illustrate: but the extent of their differences shows that they cannot readily be held to constitute one consecutive evolutionary sequence.

A. THE MARCHANTIALES.

These include those Hepatics which show the simplest of all Archegoniate sporophytes; and the fruit-body of *Riccia* is the extreme example of simplicity of construction. As in all other Archegoniatae the sporophyte of *Riccia* originates from the ovum, contained in the venter of the archegonium (Fig. 118), which is here deeply sunk in the tissue of the thallus. The naked ovum at fertilisation is contracted away from the wall of the archegonium, but after fertilisation it forms a cell-wall, and expands till it completely fills the cavity. It then segments, the first plane of segmentation being inclined to the axis of the archegonium: this is followed by other cell-divisions resulting in cleavage of the sphere into octants, after which the segmentation becomes less regular. It is only at a comparatively late period that walls parallel to the outer surface separate a superficial series of cells forming the wall of the fruit-body, from the mass of cells which lie within (Fig. 119). All these latter cells are fertile, while the superficial cells composing the wall are sterile and subsequently they become disorganised, their substance being absorbed by the developing

spores so that at maturity they are not to be recognised. A similar fate is described for the cells of the inner layer into which the archegonial wall has meanwhile divided; and thus there is a supply of nutritive material to the developing spores, comparable to that from the tapetum in the higher Archegoniatae. The cells that lie within become rounded off, and thus separate from one another in the enlarging fruit (Fig. 120): all of them undergo the tetrad-division, and develop into spores, which have

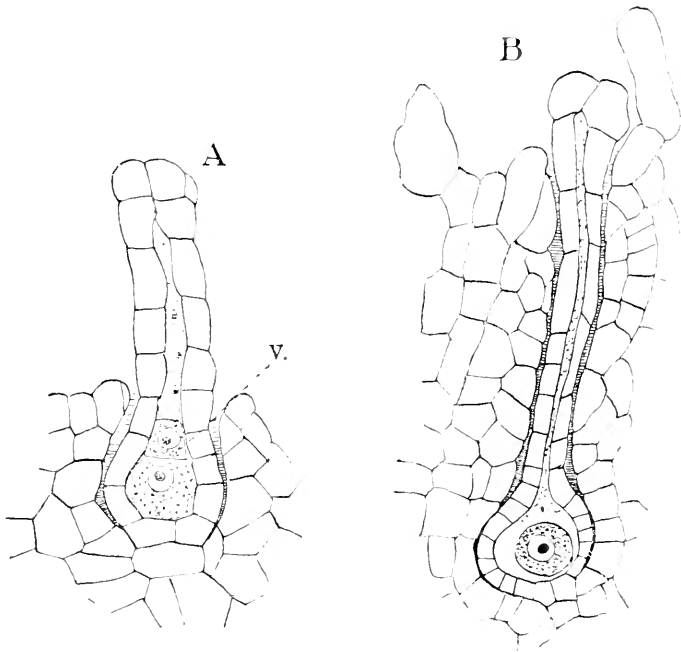

FIG. 113.

A = archegonium of *Riccia trichocarpa* showing ventral canal cell (v) and ovum. ♂ 525.
B = ripe archegonium of *Riccia glauca*. ♂ 260. (After Campbell.)

a thick, darkly coloured outer wall. These are set free by the disorganisation of the archegonial wall, or calyptra, the outer layer of which persists till the spores are ripe. Under suitable conditions the spores germinate, and each forms a new gametophyte.

Hitherto no observations have been described as to the reduction of chromosomes in the tetrad-division of *Riccia*; but it may be assumed from analogy with other Liverworts that it takes place here also. It is, however, recorded by Garber¹ that the number of chromosomes in the gametophyte of *Ricciocarpus natans* is four, while in the sporophyte it is eight; but the actual fact of reduction in the tetrad-division was not observed.

The sporophyte of *Riccia* thus described is the simplest sporophyte known among the Archegoniatae. It has been habitually regarded as a

¹ *Bot. Gaz.*, 1904, p. 171.

primitive type, though the suggestion has also been made that it may really be reduced; but in view of the fact that the gametophyte in the Ricciaceae is a well-developed structure, amply capable of nourishing not only one but many such sporogonia, there appears no immediate reason to hold that this sporophyte is other than primitive in its simplicity. The points of special interest in it for the purposes of comparison with the more complex Archegoniatae are these: that it shows no distinction of apex and base: that the whole central mass of cells is fertile, each cell producing spores, while none are diverted to purposes of nutrition or of

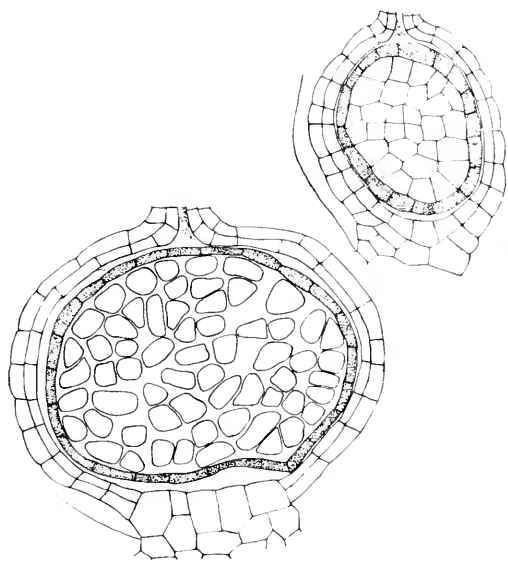

FIG. 116.

Ricciocarpus natans. Young sporogonium in longitudinal section, surrounded by the archegonial wall. The younger ($\times 666$) shows the amphithecium (shaded) surrounding the sporogenous cells: in the older ($\times 560$) these are separated, as the free, and rounded spore-mother-cells. (After Garber.)

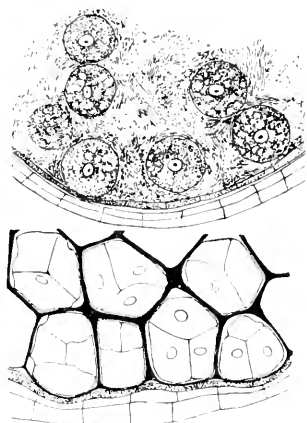

FIG. 126.

Ricciocarpus natans. The upper figure shows the spherical spore-mother-cells surrounded by nutritive material. The lower shows the tetrads formed from them: the sporogonial wall (shaded) is still seen surrounding them, and covered externally by the archegonial wall of two cell-layers. $\times 666$. (After Garber.)

dispersal: and that the superficial cells forming the wall are segmented off by periclinal walls of relatively late origin, indicating some relatively recent differentiation of them from the cells which lie within.

A reasonable theory of the phyletic origin of a simple sporogonium, such as that of *Riccia* founded on these facts, would then be, that it sprang from the simple zygote, as in point of fact all normal sporophytes do. The simplest possible case of a sporophyte would be that the chromosome-reduction which follows on fertilisation should take place on the first segmentation of the zygote, and in certain Algae this appears actually to occur (Chapter V.). But in the sporogonium of *Riccia* the reduction which accompanies tetrad-division is held over till a limited number of segmentations of the zygote have been completed: this suggests

that the event of reduction was deferred in the course of its descent. The cell-mass thus produced in *Riccia* is at first homogeneous, as was probably the case definitively in certain of its ancestry. Differentiation comes later in the sporogonium of *Riccia*, as it probably did also in the race: in place of every cell being equally liable to the tetrad-division, this is carried out only by those which lie internally: those forming the superficial wall are sterile, and form only somatic tissue. There is ample evidence of such sterilisation of fertile cells occurring elsewhere, both in plants related to *Riccia*, and in other phyla (Chapter VII.), so that no *a priori* objection can be taken to its place in the theory: there is, however, no direct proof that this was actually the case. The remaining cells which lie centrally then all undergo the tetrad-division, which on the above theory was the primitive condition for all the cells of the sporophyte.

Till recently it was thought that the fruit-body of *Coleochaete* supplied a prototype of an undifferentiated mass of cells, all fertile, such as this theory contemplates; but it has now been shown that in *Coleochaete* reduction occurs at the first segmentation of the zygote, and accordingly the old comparison is no longer permissible. There is, however, a growing body of evidence, from several distinct phyla of Thallophytes, that the event of chromosome-reduction consequent on sexuality may be deferred in the individual life: that a sterile, or vegetative phase of the nature of a sporophyte, varying in structure and in mode of origin, but similar in being partly somatic, partly fertile, may be thus intercalated between the two events. The Florideae, the Ascomycetous Fungi, and the Uredineae provide examples of such intercalation of a sporophytic phase: these point an analogy in this respect with the simplest Archegoniatae, though along phyletic lines almost certainly apart from the latter (Chapter V.). Thus the view now stated of the phyletic origin of the simple sporogonium of *Riccia* by continued segmentation of the zygote, and deferred tetrad-division, with sterilisation of the superficial cells, is in the main hypothetical, it is true; but it has a reasonable basis, partly on the facts of the individual development, partly on analogy. In the absence of still simpler sporophytes affording comparisons within the series of the Archegoniatae themselves, this analogy, together with the facts of the individual development in *Riccia* itself, make the view thus stated appear more probable than any alternative hitherto proposed.

Riccia being the simplest type of sporogonium in the Archegoniatae, the basis of the antithetic theory has been fully stated, as applied to the facts of its development. The same theory may be extended from it to other forms also, in which the sporophyte, though more complicated, arises from the zygote by similar though more extended segmentation. Steps in advance are illustrated in other Marchantiales, which will now be described.

The sporogonium of the Marchantiaceae, of which *Fegatella* (*Conocephalus*)

may be taken as a fair example (Fig. 121), is more complex than that of the Ricciaceae in having polarity of structure, and differentiation of the internal mass of sporogenous cells. Both these characteristics suggest further steps in sterilisation of potentially fertile cells. The polarity is marked in the more or less oblong external form, but more definitely by the fact that the basal tissue is sterile, and develops as the foot

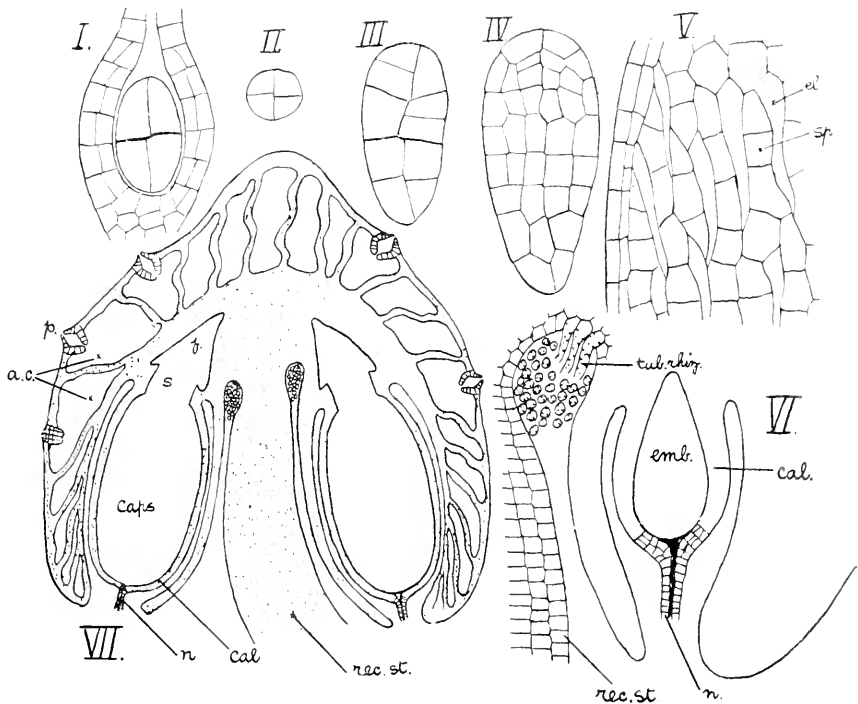

FIG. 121.

Sporogonium of *Fegatella* (*Conocephalus*). I., venter of fertilised archegonium with eight-celled embryo. II., transverse section of a similar embryo. III., IV., older embryos in longitudinal section. V., part of a longitudinal section of a developing capsule, showing differentiation of archesporial tissue into elater-forming cells (*el*), and sporogenous cells (*sp*). VI., part of longitudinal section of receptacle with embryo. VII., similar section showing two mature sporogonia in outline. *ac*=air-chambers; *cal*=calyptra; *caps*=capsule; *f*=foot; *n*=neck of archegonium; *β*=pore; *rec. st.*=stalk of receptacle; *rhiz.*=rhizoids; *s*=seta of sporogonium. I.-V. $\times 350$. VI. $\times 76$. VII. $\times 20$. (After Cavers.)

which supports the fertile capsule (Fig. 121, VII.). It is stated that the whole hypobasal half of the zygote is thus sterile, though this limitation may not apply for all cases. This state as compared with that of *Riccia* might be expressed as a consequence of sterilisation of the whole product of the hypobasal half of the zygote; but it is still a matter for debate whether the Ricciaceae really represent the progenitors of the Marchantiaceae. The presence of this polarity may be held as a biological concomitant of the position of these larger sporogonia relatively to the thallus which bears them: the spherical form of *Riccia* is suitable to its

habit, surrounded as it is up to full maturity by the tissues of the parent thallus. But the larger sporogonia of the Marchantiaceae project at maturity from their envelopes, and even during development their relation to the parent thallus is not uniform all round, their nutrition emanating mainly from base of the archegonium: a certain degree of polarity, expressed in the formation of a sterile foot for nutritive and mechanical purposes, is thus intelligible.

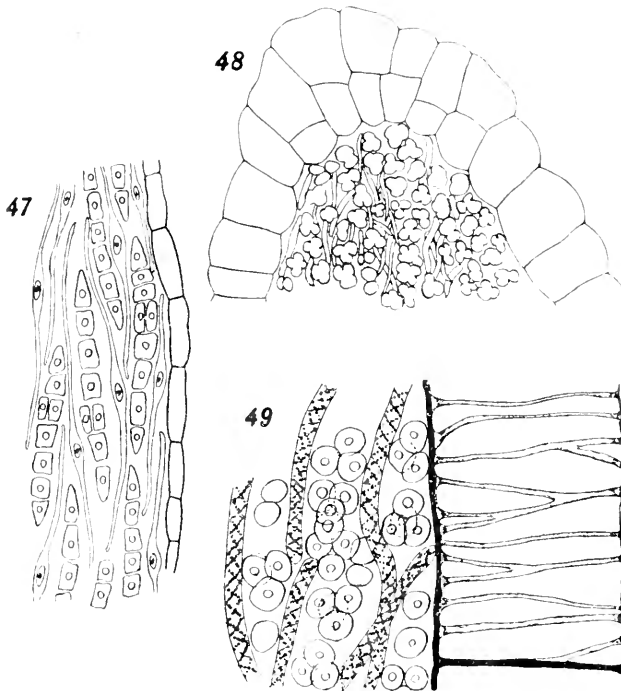

FIG. 122

Monoclea Forsteri, Hook. 47=part of a longitudinal section of a capsule showing elaters and rows of spore-mother-cells. $\times 350$. 48=longitudinal section of the tip of a nearly mature capsule, showing the lobed spore-mother-cells. $\times 160$. 49=elaters, tetrads of spores, and a cell from the wall of a still more mature capsule. $\times 350$. (After Johnson.)

But much more interest attaches to the internal differentiation of the capsule. The wall is initiated at a relatively early stage, and remains a single layer, excepting at the extreme apex: the mass of tissue which lies within, corresponding as it does in position to the sporogenous cells of *Riccia*, is composed of cells all alike in origin, and it is often designated the archesporium (Fig. 121 iv.). But they do not all develop as spore-mother-cells: some become elongated, and form the well-known sterile elaters (Fig. 121 v. *el*): others, undergoing more numerous divisions, remain fertile, and divide into spore-tetrads: a later stage of this differentiation is well illustrated in Fig. 122 for *Monoclea*, a genus of doubtful

affinity with the Marchantiaceae, though showing a similar relation of spore-mother-cells and elaters. Since the whole mass is uniform in origin, and since the similar mass in *Riccia* is wholly fertile, it is the natural conclusion that certain of the potentially fertile cells have been sterilised to form the elaters: or, in other words, remain as somatic cells without undergoing chromosome-reduction. The final function of the elaters is to assist mechanically in the dispersal of the mature spores: but it is possible that in such a plant as *Fegatella* (*Conoccephalus*) they may in some degree assist in the early nutrition of the cells which remain fertile. This seems almost certainly to be the case in *Corsinia*, and also in those genera of more doubtful affinity, viz. *Sphaerocarpus*, *Geothallus*, and *Riella*, where the sterile cells are not mechanically strengthened by spiral or annular thickenings of their walls: they are here recognised as "nutritive cells," and they undoubtedly aid in the supply of nourishment, and perhaps also in dispersal of the spores by swelling of their mucilaginous remains. The obvious importance of these nutritive cells, as well as of the elaters, is further evidence of the probability that a progressive sterilisation, or conversion of reproductive into somatic cells, has occurred.

In the Marchantiaceae there is regularly present at the distal end of the capsule a small mass of tissue within the one-layered wall, which remains sterile, and comes away at dehiscence as a cap, or lid. This also originates from the archesporium: its development has been clearly shown by Lang in *Cyathodium*: Fig. 123 illustrates the apex of a sporogonium, and from comparison of the young state it is plain that certain cells of the archesporium are told off as sterile from the first.

From these notes it appears that in the Marchantiaceae, as compared with the Ricciaceae, the evidence is strong for the conclusion that the sporogenous tissue is liable to be reduced at various points by diverting cells, or groups of cells, from their original function as fertile cells: the somatic functions which they then perform have obvious uses, and this gives biological probability to the conclusion.

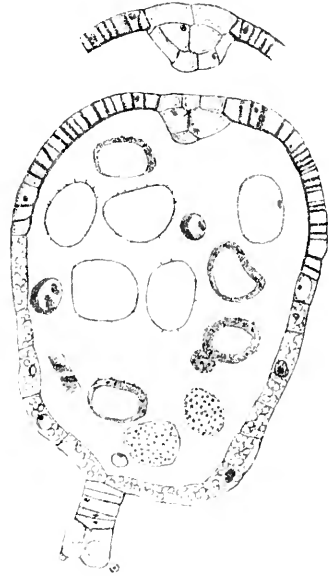

FIG. 123.

Cyathodium cavernarum, longitudinal section of an almost mature sporogonium showing apical disc. $\times 200$. Above, the apical disc of the same sporogonium in median section. $\times 200$. (After Lang.)

B. THE JUNGERMANNIALES.

The same principle is illustrated also in the Jungermanniales, but with differences of detail. In these the first segmentation of the zygote separates a hypobasal cell, which in some cases develops as a multicellular

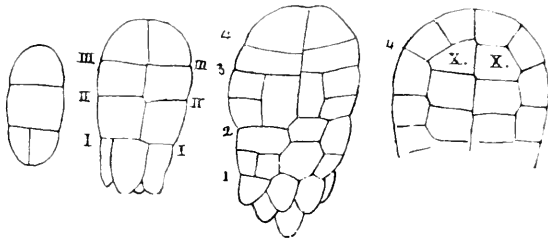

FIG. 124.

Frullania dilatata, development of the embryo. $\times 300$. (After Leitgeb). x, x' , the archesporial cells. The numbers indicate the primary transverse divisions. (From Campbell, *Mosses and Ferns*.)

haustorium (*Frullania*), but more frequently remains as a minute appendage at the base of the fruit, while the epibasal cell gives rise to the capsule, stalk, and foot. So far as a comparison on the basis of the segmentation of the zygote is valid, this would indicate in the Jungermanniales a still further delegation of function from the hypobasal to the epibasal half of the embryo.

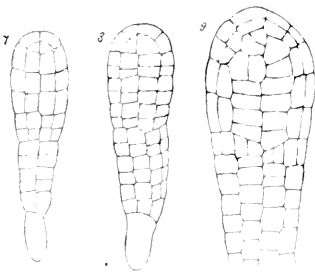

FIG. 125.

Embryos of *Radula complanata*. $\times 230$. (After Leitgeb.) 7, 8, show the basal appendage cut off by the first segmentation of the zygote; 9 shows the upper region of a more advanced embryo.

The epibasal half of the zygote undergoes segmentation, so that a number of transverse discs are formed, each composed of four cells, while the terminal tier is composed of four octants of a hemisphere (Fig. 124). The segmentation is often very regular, but exceptions exist.¹ The uppermost tier of cells appears to be cut off by the first transverse wall in the epibasal half of the zygote, and in many of the Anakrogynous Jungermanniaceae the whole of the capsule is derived from

these cells: subsequent intercalary divisions in the lower half of the epibasal cell gave rise to the sterile seta. But, on the other hand, in many of the Akrogynous Jungermanniaceae—for instance, in *Radula*—it is shown by Leitgeb² that some of the lower tiers of cells also take part in the formation of the capsule; in *Radula* the number of these appears to be three (Fig. 125). Thus there is in such cases no general distinction, on

¹ See Campbell's Figs. of *Porella*: *Mosses and Ferns*, Fig. 55.

² *Lebermoose*, ii., p. 55.

the basis of the first segmentations, of the capsule from the seta. So far as segmentations offer a basis for argument, the general conclusion may be drawn that the seta and capsule are not always distinct *ab initio*. The developmental facts suggest that the fertile region may be held to be a residuum left by sterilisation, which has been basifugally progressive: the result of such sterilisation is the region of the seta as it is seen in these plants. We may regard as the most primitive case that in which all the tiers of cells of the embryo form the archesporium: those cases in which the differentiation of the archesporium is deferred in the individual life may be held to be relatively less primitive.

The four cells of the uppermost tier, which thus as a rule form the capsule in the Jungermanniales, divide first transversely to form four terminal cover-cells: the four larger cells below again segment to form four inner cells and eight to twelve peripheral cells. This is the same segmentation as occurs also in the lower tiers: the similarity is in accordance with the view above expressed as to the origin of the seta by basifugal sterilisation, and supports the conclusion that seta and capsule had a common origin.

However interesting such questions may be, they are more or less speculative. A much greater interest, proportional to the greater cogency of the facts, attaches to the various modes of development of the capsule itself in the Jungermanniales. It has been seen that the inner cells above described constitute the archesporium. In many of the Akrogynous Jungermanniaceae the cells, after repeated divisions, undergo a differentiation as in the Marchantiaceae, into spore-mother-cells and sterile elaters: these are associated in various ways, and the case of *Porella* will serve as an average example (Fig. 126). The argument from differentiation of sterile and fertile cells during development applies equally here as in the Marchantiaceae. The same is the case with many of the Anakrogynae; but in some of the latter there is a more specialised tissue-differentiation leading to the formation of a coherent mass of sterile tissue, with a more definitely localised residuum of fertile tissue: this sterile mass has been

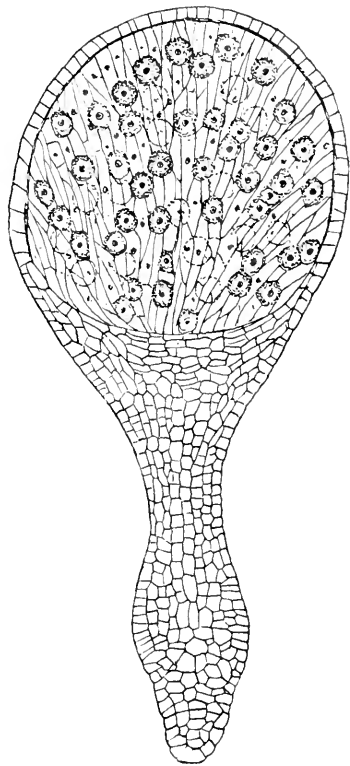

FIG. 126.

Porella Bolanderi. Longitudinal section of a sporogonium after the final division of the archesporial cells. $\times 35$. (After Campbell.)

styled an elaterophore. It is illustrated in the cases of *Metzgeria* and *Ancura* (Fig. 127), and also in *Pellia* (Fig. 128). In the former the elaterophore is attached internally at the distal end of the capsule, in the latter at its base. In *Ancura* the capsule-wall consists of two layers of cells, while the archesporium lies within. The differentiation of this body is initiated early: in so young a sporogonium as that of Fig. 129 A there is a distinction already marked by the protoplasmic contents between a central group of more transparent cells and a peripheral band with

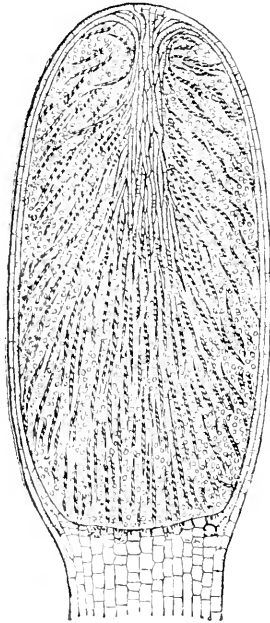

FIG. 127.

Ancura pinguis. Ripe capsule in longitudinal section. From the summit the elaterophore hangs into the spore-cavity, in which are many spores and elaters. Magnified. (After Goebel.)

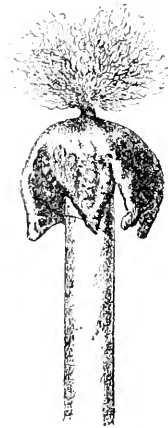

FIG. 128.

Pellia calycina. Sporegonium opened, and emptied, showing the valves of the wall recurved, and an elaterophore of many threads. (After Goebel.)

denser protoplasm. The former constitutes only a central part of the elaterophore: it is clearly shown at a later stage that the differentiation has extended (Fig. 129 B), and that some of the inner products of the darker band shown in Fig. A are also developing as sterile cells, while it is only the fertile outer fringe which is the final residuum after these progressive steps of sterilisation. This point comes out even more clearly in a transverse section (Fig. 129 C), where the central group of cells first differentiated are readily distinguished from those differentiated later. There can be little doubt, after comparison with other Jungermanniaceae, that the history of the individual development in this case gives a correct

clue to the steps of evolution of the elaterophore: that it arose by partial sterilisation of the archesporium, with the consequence that the fertile zone is relegated to the exterior. The development in *Pellia* is essentially the same, but the attachment of the elaterophore is to the base of the capsular cavity. It is worthy of note that these modifications occur in the Anakrogynous Jungermanniaceae, which, as we have already seen, are more advanced than the Akrogynous as regards the differentiation of the seta and capsule.

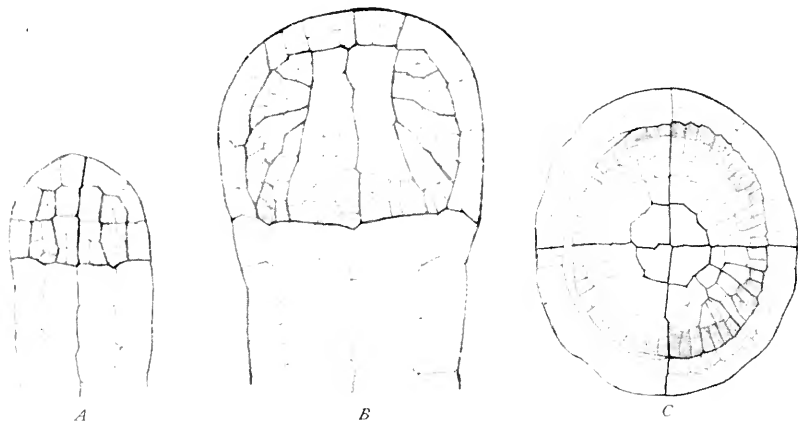

FIG. 129.

A, median section of young sporogonium of *Ancura ambrosioides*. The internal mass of cells of the sporogonial head ("archesporium") is already differentiated so as to indicate the sterile elaterophore, and the outer fertile region. *B*, the same, older: the indications of sterilisation have extended outwards, and it is only the peripheral fringe of cells (shaded) which will be sporogenous. *C*, transverse section of the same. $\times 150$.

It thus appears that in the Jungermanniales partial sterilisation of the sporogenous tissue has occurred analogous to that in the Marchantiales: but in addition there is reason to believe that the elongated seta has here originated also by relegation of the spore-producing function from the lower segments to the upper, or even to that tier of them which is apical.

C. THE ANTHOCEROTALES.

The Anthocerotales stand clearly apart in the mature characters of the sporogonium. Its large size and early freedom from the calyptra, the continued intercalary growth, and the specialisation for self-nourishment are external characters which dissociate the family from other Liverworts: while internally, the presence of a columella, at least in the larger forms, and the origin of the archesporium from the outer cells of the young capsule, also point in the same direction. There are, however, differences of detail within the family, which indicate with some degree of probability a line of derivation from a Jungermanniaceous type, the nearest approach being in the genus *Notothylas*.

The development of the sporogonium has been carefully studied in *Anthoceros* by Campbell.¹ The early segmentations result in three tiers composed of four cells each (Fig. 130 A): of these the lowest is derived from the hypobasal half of the zygote, and it forms the main part, if not indeed the whole of the foot. The highest tier gives rise to the primary capsule, while from the intermediate zone derived from the second tier the meristematic part of the older sporogonium is formed (Fig. 130 E). The highest tier of four cells segments further to form

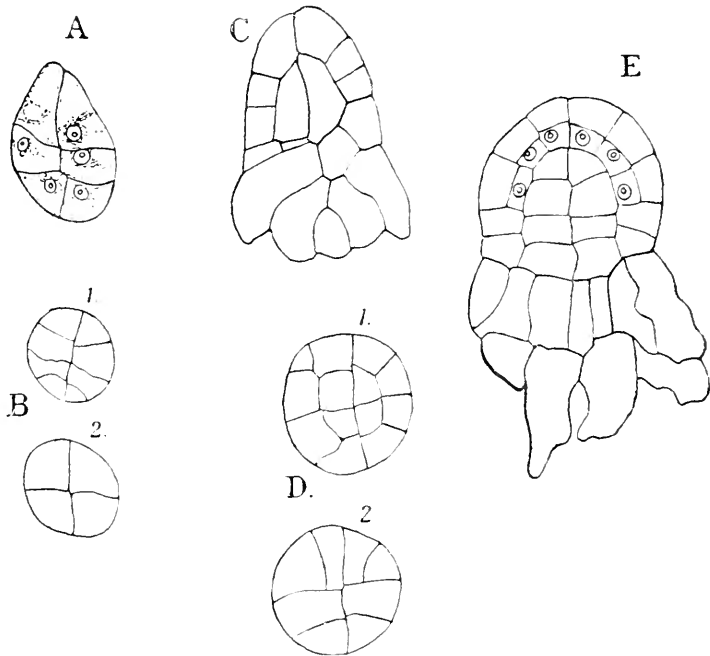

FIG. 130.

Anthoceros Pearsoni. Development of the embryo. $\times 300$. A, C, E, median longitudinal sections. B and D, successive cross-sections of embryos of about the age of A and C respectively. In E the archesporium is differentiated. (After Campbell.)

a central group of four, and a peripheral series (Fig. 130 C, D): from the former the sterile columella originates, although in all other Liverworts the corresponding cells give rise to the archesporium. This, however, is primarily formed in *Anthoceros* from the inner cells resulting from periclinal division of the peripheral cells of the highest tier, and its form is that of a dome completely covering the rounded apex of the columella (Fig. 130 E). The columella thus initiated in *Anthoceros* develops entirely as sterile tissue. The layer of cells immediately outside it, recognised as the archesporium by their denser protoplasm, differentiates

¹ *Mosses and Ferns*, p. 134.

later, in the well-known way, into elaters and spore-mother-cells, showing thus a partial sterilisation (Fig. 131 A). Subsequently the intercalary activity begins in the middle zone, and it adds by basipetal increments respectively to the columella, the archesporial layer, and the capsular wall. Such intercalary development may be held to have been of secondary origin from the region corresponding to the seta of other forms, and the

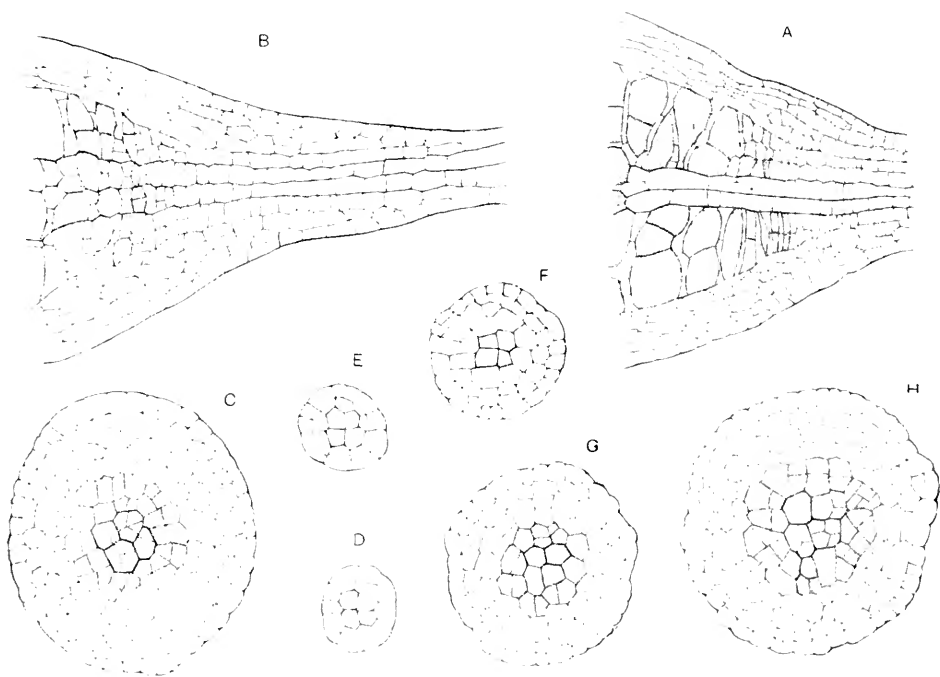

FIG. 131.

Notothylus Breutelii. A, longitudinal section of the basal region of an almost mature capsule, showing a short sterile columella derived from the endothecium. $\times 130$. B, a similar section, but without sterile columella. In the upper part the wall of the capsule can be distinguished from the sporogenous tissue, the cells of which are differentiated into spore-mother-cells (shaded), and elaters. Traced downwards, the central portion of the sporogenous tissue is continuous with the endothecium, while the peripheral portion comes from a layer of cells which have a common origin with the wall. $\times 170$. C, transverse section of a sporogonium like B, at the base of the fertile region: the uniform sporogenous tissue (shaded) can be seen to be composed of four central groups of cells (endothecium) and a surrounding layer derived from the amphithecium. $\times 170$. D, E, F, G, H, successive transverse sections of a sporogonium, in which one of the four rows of cells of the endothecium is forming a sterile columella, left clear in G and H. The origin of the amphithecial archesporium can be followed. $\times 170$. (After Laug.)

primary condition of the sporogonium will thus be a more satisfactory basis for comparison with other Liverworts than its mature state.

It might be difficult, in the absence of intermediate forms, to bring this peculiar sporogonium of *Anthoceros* into relation at all with those of other Liverworts. But within the Anthocerotales there is the genus *Notothylas*, which bears sporogonia of small size, and of limited intercalary growth, whereas in the other genera the large sporogonia appear

to have the intercalary activity unlimited. Moreover, in these small sporogonia, though a sterile columella is often present, sometimes its place is taken by fertile tissue: and the difference may be seen in sporogonia of the same species. The details of this were long ago described by Leitgeb,¹ but doubts have since been raised regarding his conclusions by investigators who, working chiefly with other species, did not obtain the same results.² Recently, however, Lang has made observations which go far to explain the discrepancies; and though they do not exactly coincide with Leitgeb's account as regards the development of *Notothylas*, they show that, as regards the fertility of the columella, he was substantially correct.³

It appears that the embryonic structure of the sporogonium of *Notothylas* is essentially like that of *Anthoceros*, in respect of the relations at its base of columella, archesporium, and capsule-wall. In those cases where the columella is present in the mature state, the spore-mother-cells originate only from the archesporium. But in other cases where a definite columella is not present in the mature state, any cell of the tract laid down structurally as columella may become a spore-mother-cell. Many do so, and thus, as Leitgeb described, the place of the sterile columella may be taken by a spongy mass of sterile tissue, in the meshes of which the spores are included. In addition to this, however, fertile cells and elaters are also produced from the archesporium, which lies, as in *Anthoceros*, outside the columella (Figs. 131 A-F). Two interpretations of this state are possible: either that the columella-less forms are primitive, and their partly fertile condition intermediate towards the establishment of a completely sterile columella: or that the forms with a columella are primitive, and the columella-less forms a reversion, some of its cells resuming fertility which had previously been lost. Dr. Lang is inclined to consider the columella-less forms as reduced: but whether reduced or not the facts throw considerable light upon the relation of the columella-less to the columelloid forms: they increase the justification for considering the central group of cells, which in all other Anthocerotaceae is wholly devoted to the formation of a sterile columella, as the original sporogenous tissue, and the amphithelial archesporium as of secondary origin. The duty of producing spores would seem to have been transferred from the central to the superficial set of cells. It is thus possible to bring the apparently divergent sporogonium of the Anthocerotales into relation to that of the simpler and probably more primitive Jungermanniales. The causes of the change of the products of the endothecium from the fertile to the sterile condition must be looked for in influences acting on the primary meristematic tissue of the embryo, or on the intercalary zone of secondary meristem. Dr. Lang holds⁴ that the idea of grouping of elaters in a central position to form the columella is not in this case in accordance

¹ *Liebermoose*, v., p. 39.

Mottier, *Bot. Gaz.*, 1894; Campbell, *Mosses and Ferns*, Edn. ii., pp. 151-155.

² Lang, *Ann. of Bot.*, vol. xxi., p. 201, etc.

⁴ *L.c.*, p. 208.

with the facts. These suggest rather the influence of nutritive factors acting on the young embryo while still enclosed in the tissue of the gametophyte.

The characters of progress achieved by the more complex Anthocerotales, in advance of the Jungermanniales, appear accordingly to be these: (1) a continued intercalary growth at the base, originating from the seta, and giving an unlimited sequence of spore-production; (2) provision for the nourishment and ultimate dispersal of the spores by means of the columella; (3) relegation of spore-development to a more superficial source, as the sterilisation at the centre becomes established; and (4) development of an assimilatory apparatus for self-nourishment from the tissues of the capsular wall. All these advances are readily intelligible on biological grounds, and are due either directly to sterilisation of fertile cells, or to secondary modifications in tissues already sterile in the simpler types. The theory of progressive sterilisation has already been traced in its application to the sporogonia of other Liverworts, as elucidating the origin of the protective capsular wall, the seta, the elaters, and elaterophores. It is now seen that the origin of the sporogonium of the Anthocerotales, though the most advanced of all the Hepaticae, falls naturally within the lines of a theory of progressive sterilisation, which starts from relatively simple post-sexual cell-divisions.

CHAPTER XXII.

II. MUSCI.

THE Mosses for the most part show greater uniformity of plan in their sporogonia, and give less indication of the steps of their evolution than do the Liverworts. It is a question open for discussion what, if any, are the genetic relations of these two classes. Whatever view may be held on this point, there are certainly strong features of similarity between their sporogonia. Without necessarily accepting these resemblances as indications of near genetic affinity, they must at least be held to point a strong analogy between the two series: so strong indeed that it will go far to justify an application of a theory of sterilisation in the Musci, even where the gradual steps of the process are less clearly indicated than they are in the Liverworts.

The Musci include the Sphagnales, the Andreaeales, and the Bryales: these are sufficiently distinct in their sporophyte-structure to require separate description: and the Sphagnales will be taken first, as showing the clearest analogies with the Hepatics.

A. SPHAGNALES.

Notwithstanding the strong divergence of their gametophytes, both in form and in structure, the sporogonia of the Sphagnales and Anthocerotales show marked similarity, both in form and in development. Alone among the Mosses the embryo of *Sphagnum* segments by successive transverse walls, like a Liverwort: there is no continued apical growth, the further enlargement after the first segmentations being intercalary in the segments already laid down (Fig. 132 A): of these only the upper three or four go to form the capsule: the rest form the short seta, and the foot. In the upper region each segment divides into quarters, which again divide so as to form in each transverse section a central group of four (endothecium), and a peripheral series (amphithecium) (Fig. 132 C, D, E). The former give rise to the columella alone, which is in *Sphagnum* a bulky mass

of tissue with rounded apex (Fig. 133 F, H). The peripheral series of cells, or amphithecium, divides periclinally to give off internally the single

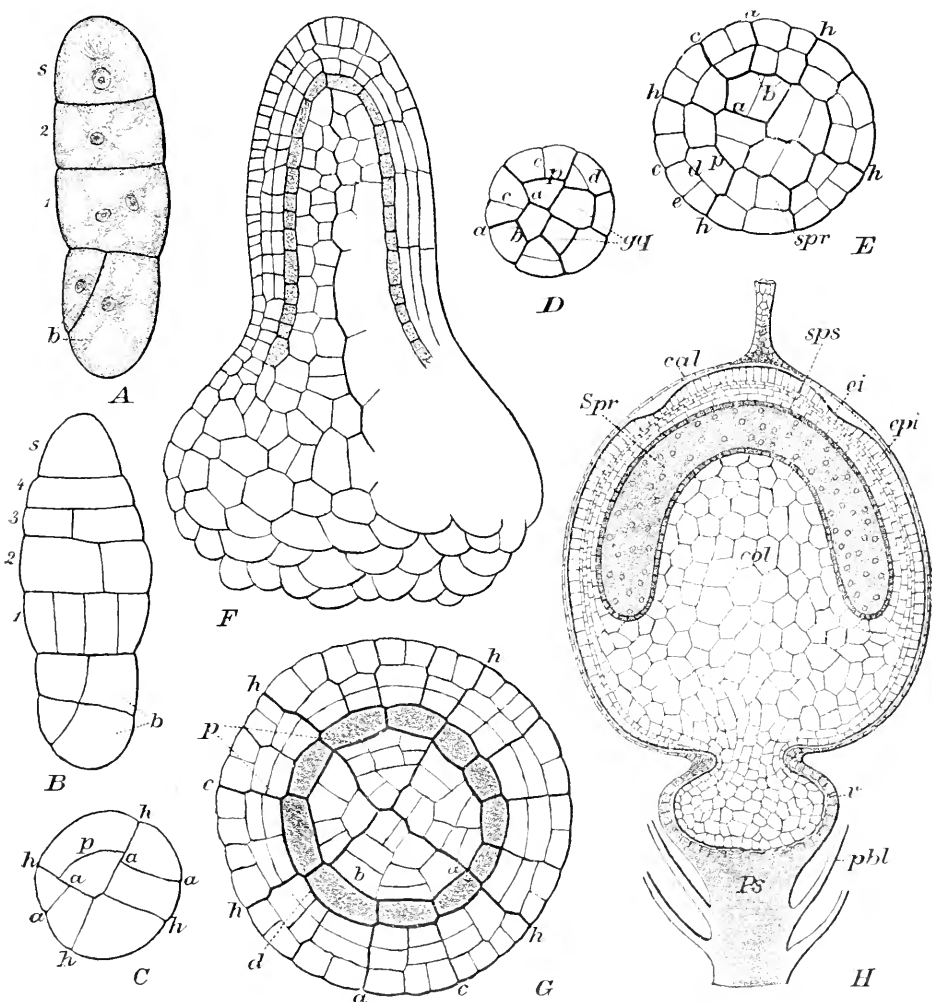

FIG. 133.

Development of sporogonium of *Sphagnum acutifolium*, Ehrh. *A* = embryo with four tiers; *s* = apical cell; *b* = basal cell with oblique division. *B* = embryo with five tiers; *C* = optical section of the same embryo; one quadrant is still undivided; *a* = anticlinal; *p* = periclinial walls; *h* = principal walls. *D* = transverse section of the lower part of an embryo. *E* = a rather older stage; *spr* = spore-forming layer. *F* = median longitudinal section of a sporogonium showing the bell-shaped sporogenous layer, and the wall covering it externally. *G* = transverse section of a sporogonium of similar age; lettering as in *E*. *H* = median longitudinal section, though a half-ripe sporogonium; *cal* = calyptra; *spr* = spore-cavity, in which the spore-mother-cells are isolated; *sps* = spore-sac; *epi* = epidermis; *i* = furrow in wall where the operculum will separate; *Ps* = pseudopodium; *r* = vacuola; *pbl* = perichaetial leaves; *col* = columella. (After Wadner, from Engler and Prantl.)

layer of the archesporium: this appears as a continuous dome closely investing the columella. The external product of the amphithecium forms

the many-layered capsular wall (Fig. 132 F, G, H). The dome-shaped archesporial layer divides later into four layers, and every cell undergoes the tetrad-division to form spores. At maturity dehiscence takes place by a transverse rupture, setting free a circular operculum. The foot is considerably enlarged as an haustorium, which is marked off at maturity by the narrow neck of the short seta: and the whole is borne upwards on a more or less elongated pseudopodium developed by the parent gametophyte (Fig. 132 H).

In the facts thus briefly sketched there is no obvious evidence of sterilisation: it is only when the peculiarly close analogies with the Anthocerotae are traced that any relation to the theory emerges. The points of similarity with the typical Anthocerotales are seen in the form of the sporogonium, in its absence of apical growth, and in the manner of its primary segmentation: also in the origin of the columella from the whole of the central group of cells, and of the completely dome-shaped archesporium from the primary capsular wall outside it. It differs, however, in the mode of dehiscence, and in the fact that elaters are absent, while the columella is not mechanically functional: it serves no purpose beyond the nutrition of the considerable mass of spores. But as methods of dehiscence, and of distribution of spores not unfrequently vary within near circles of affinity, this discrepancy does not seem of prime importance. Lastly, however, there is, as a point of difference from *Anthoceros*, the absence of any functional assimilatory system in the sporogonium of *Sphagnum*, though it is so well developed in *Anthoceros*. But, as Haberlandt has shown,¹ functionless stomata, without pores and without intercellular spaces below them, are present in large numbers on the capsules of *Sphagnum*: from this he concludes "that it is certain not only that the ancestors of the present Bog-Mosses had normal functional stomata on their capsules, but also that the capsules of these ancestors possessed a relatively well developed assimilatory system as well." All these considerations taken together point to a close analogy (if nothing more) between the two types.

On the other hand, *Sphagnum* has always been ranked as a Moss on such grounds as habit, absence of elaters, and structure of the archegonium: but it differs from all other Mosses in the transverse segmentation of the embryo, and in the absence of an apical cell: also (excepting *Andreaea*) in the complete dome-shape of the archesporium, and in its origin from the amphithecium; these all being features of correspondence with *Anthoceros*. Such equivocal comparisons, with Liverworts on the one hand, and with Mosses on the other, give *Sphagnum* itself a special interest: at the same time they serve to link together the two large groups of Bryophytes, and point to the propriety of regarding their sporogonia equally from the point of view of a theory of sterilisation. The columella would thus be held in both cases to be a consequence of sterilisation

¹ *Pringsh. Jahrb.*, xvii., p. 474.

progressive from within, which has extended in *Sphagnum*, as in *Anthoceros*, to the whole product of the endothecium, while in both the archesporium takes its origin wholly from the amphithecium. A key to this difference of *Sphagnum* from all other Mosses may be found in *Notothylas*, in which the sporogenous cells may arise from both sources, the centrifugal progress of sterilisation being less completely carried out there than in *Anthoceros*. In both cases the difference appears referable to the degree of centrifugal sterilisation in a body in which the spore-production was originally central. Thus the condition of *Sphagnum* is in this respect the most advanced in the Mosses, as that of *Anthoceros* is among the Liverworts. As regards decentralisation of the fertile tissue the rest of the Mosses will be seen to correspond to the less extreme types of the Hepatics, while the columella-less sporogonia of *Notothylas* link together the two degrees of decentralisation.

B. ANDREAEALES.

The mature sporogonium of *Andreaea* offers analogies with that of *Sphagnum* in its form, with its short seta and large foot, the whole being borne up on an elongated pseudopodium: it also corresponds in the fact that the columella is interrupted at the apex, and covered by the archesporium which forms a complete dome (Fig. 133); but it differs in the dehiscence when mature by longitudinal slits.

The segmentation of the zygote corresponds to that of other Mosses rather than to that of the Hepatics, for after the appearance of the transverse basal wall, the cleavages are oblique, a two-sided initial cell being present (Fig. 134 A-D); but the number of such segmentations is limited to about a dozen.

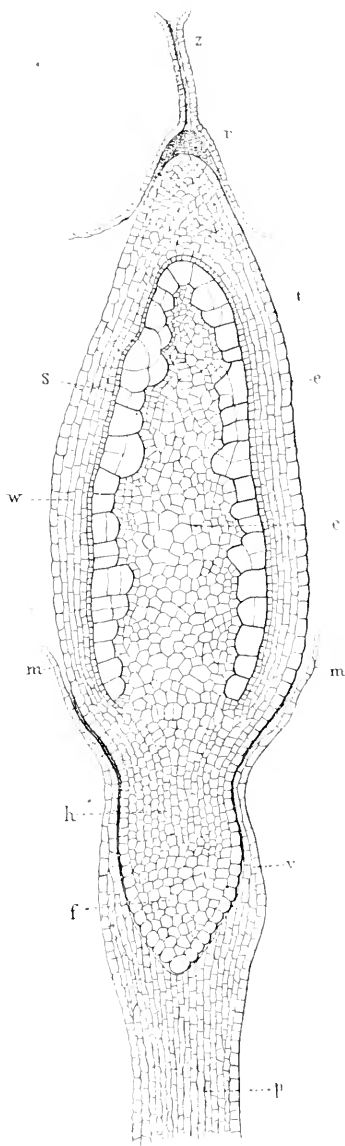

FIG. 133.

Median longitudinal section of sporogonium of *Andreaea rupestris*, at the time of division of the archesporium. *p*=pseudopodium; *f*=foot; *v*=vaginula; *h*=neck; *c*=columella; *w*=wall of sporogonium; *e*=epidermis; *s*=spore sac; *t*=archesporial cells dividing; *r*=calyptra; *z*=neck of archegonium. (After Kuhn.) $\times 50$.

These undergo further sub-divisions to constitute an endothecium of four cells, and a many-celled amphithecium (Fig. 134 G). The hypobasal half, which has meanwhile undergone irregular divisions, together with the two lowest segments of the epibasal region remains sterile, and constitutes the short seta and enlarged foot. Three or four only of the upper segments are fertile, while the rest go to form the sterile apex of the capsule (Fig. 134 E).

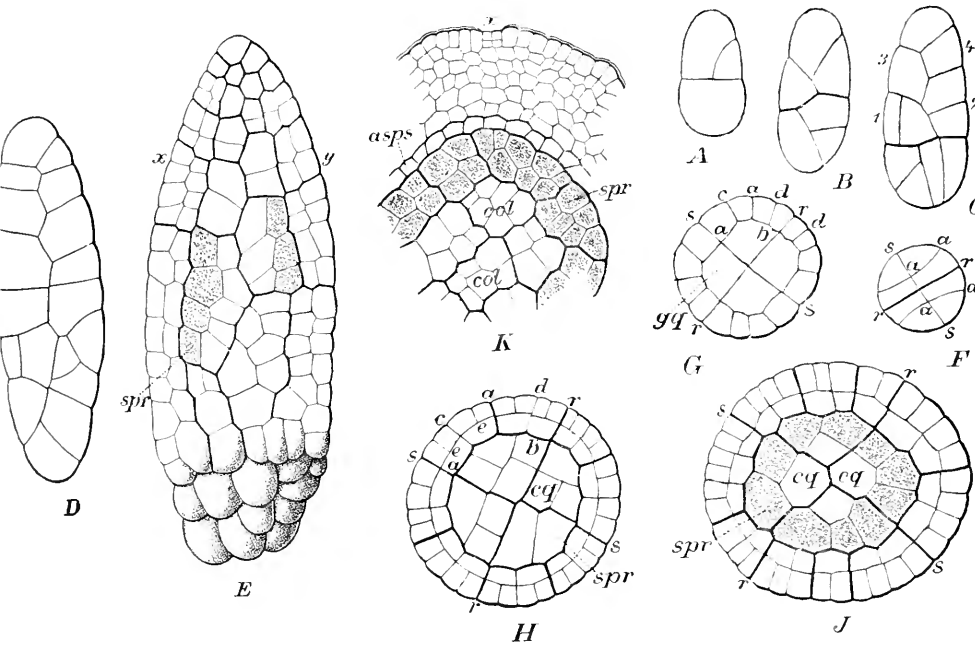

FIG. 134.

Development of sporogonium of *Androcaca*. *A* = young embryo of *A. crassinervis*, Brch. *B* = *A. petrophila*, Ehrh. *C* = of *A. crassinervis*, older. *D* = of *A. sp.*, older still. *E* = optical longitudinal section of *A. petrophila*; *spr* = archesporium. *F* = optical transverse section of a young embryo; *ss* = segment-walls; *rr* = radial walls; *ar* = first divisions of the quadrants. *G* = older stage; *gq* = "grund-quadrat." *H* = older stage with division to form archesporium. *I* = archesporium differentiated. *K* = archesporium divided into two layers; *asp* = outer spore-sac; *col* = columella. (After Waldner.) *D* after C. Müller-Berol. (From Encler and Prantl.)

The archesporium is here, as in all other Mosses, derived from the endothecium: the peripheral cells which result from the segmentation of the endothecium, become densely granular, and give rise to spore-mother-cells. the internal cells form the columella (Fig. 134 F, J, K). It is not stated by Waldner how the archesporial dome is completed at its apex: probably it is by certain cells of the inner product of the endothecium, forming spore-mother-cells, in place of sterile cells of the columella. In this there would be no theoretical difficulty, for on the present theory all cells derived from the endothecium were at first potentially fertile cells; moreover, as bearing indirectly on this point, the internal limit between the archesporium

and the columella is in *Andreaea* a very irregular one (Fig. 135). Further, in *Archidium*, which some writers put in close relation to *Andreaea*, any cell derived from the endothecium may apparently become a spore-mother-cell.

It is thus seen that though *Sphagnum* and *Andreaea* have certain apparent characters of the sporogonium in common, their segmentation is essentially different, and the dome-shaped archesporium is produced in different ways in the two. It remains doubtful therefore how far the similarities indicate a real affinity. In any case the relation of the Andreaeales to the simpler Bryales is much nearer than to the Sphagnales, and it is in this direction that comparison of the sporogonia will bring the more interesting conclusions concerning them.

C. BRYALES.

These include the vast majority of Mosses. In their sporophyte generation there is uniformity of the general scheme, though considerable fluctuation in size, as well as in minor detail. Some of the smallest forms, which show irregular opening of the capsule on maturity, are classed as the Cleistocarpae; the more elaborate forms, which dehisce transversely, setting free an operculum, are designated the Stegocarpae. The latter, as they represent the prevalent type in Mosses, will be taken first, while the Cleistocarpic forms being taken later, will then be better appreciated in their value for purposes of comparison.

(a) *Stegocarpae*.

The embryo of all these Mosses takes at an early stage the form of a more or less slender, but always simple spindle: any later deviations from this are of secondary origin. Its development from the zygote is first by the appearance of a transverse basal wall, which is succeeded by oblique segmentations in the epibasal half: these appear alternately on opposite

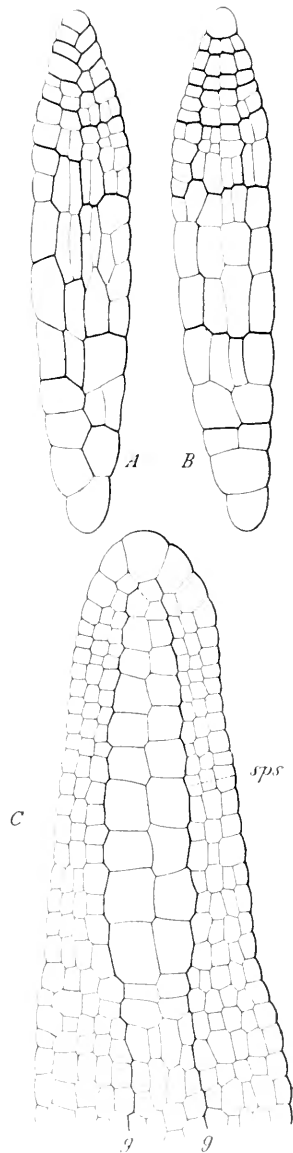

FIG. 135.

Ceratodon purpureus. A, B, young embryo seen from points of view at right angles to one another. C=an older embryo; gg=outer limit of endothecium; sps=outer spore-sac. (After Kienitz-Gerloff.)

sides, so as to cut off two rows of segments successively from the terminal, two-sided initial cell (Fig. 135 A and B). The apical growth is, however, not very long continued, and gives place later to intercalary activity. The hypobasal cell, as also sometimes the lowermost segments, undergo less regular sub-divisions, but the upper segments sub-divide with greater regularity—though still with some differences of detail—in such a way that a definite result is arrived at, viz., the formation of a central tract of tissue (endothecium), consisting of four rows of cells, and a peripheral series (amphithecium), consisting of more numerous cells, which soon divide both radially and periclinally to form a thick wall (Fig. 135 C). It is important, from a theoretical point of view, to note that the endothecium thus established, though less definite in the lowest of the epibasal segments, extends upwards throughout the length of the capsule to its apex: it is not merely a local development in that part which is ultimately to be the fertile region, but it is a continuous and definite column of tissue, occupying the centre of the spindle-shaped sporogonium. It may be a question what is the morphological importance of a tract thus defined by embryonic segmentation. In Chapter XIV. the relation of the leading anatomical regions of axis and root to the apical segmentation has been discussed, and it was seen that there is no obligatory correspondence between early segmentation and the definition of mature tissue-tracts: for it has been found that, in parts of such complicated outline as the leaf-bearing shoot, the correspondence between early segmentation and mature structure is not strictly maintained. But it is the fact that in parts of such simple outline as roots there is a definite correspondence of that nature, and this is particularly clear in certain Pteridophytes. The case of the simple spindle-shaped sporogonium of a Moss is comparable, in its form as well as in the early segmentation of its central tract, with such roots; and there seems good reason to regard the endothecium accordingly as being in fact a morphologically definite region throughout its length. The most important function of the endothecium is that it is the exclusive source of spore-formation; but as a matter of fact, it is only a relatively small extent of it which carries this into effect, the rest remaining sterile, performs other duties.

The archesporium originates from a restricted region of the endothecium some distance back from the apex of the sporogonium, and a very considerable distance from its base: the sterile region of the capsule at the distal end forms the calyptra and peristome: the much longer sterile region at the base forms the apophysis and the seta. These regions may vary in their proportion to the fertile region in different types of Mosses: a fair average is that seen in *Funaria* (Fig. 136 A). The origin of the archesporium is by periclinal division cutting off a single layer of cells from the periphery of the endothecium: this ultimately divides up into several layers of minute cubical cells, all of which undergo the tetrad-division in the usual way, and produce spores.

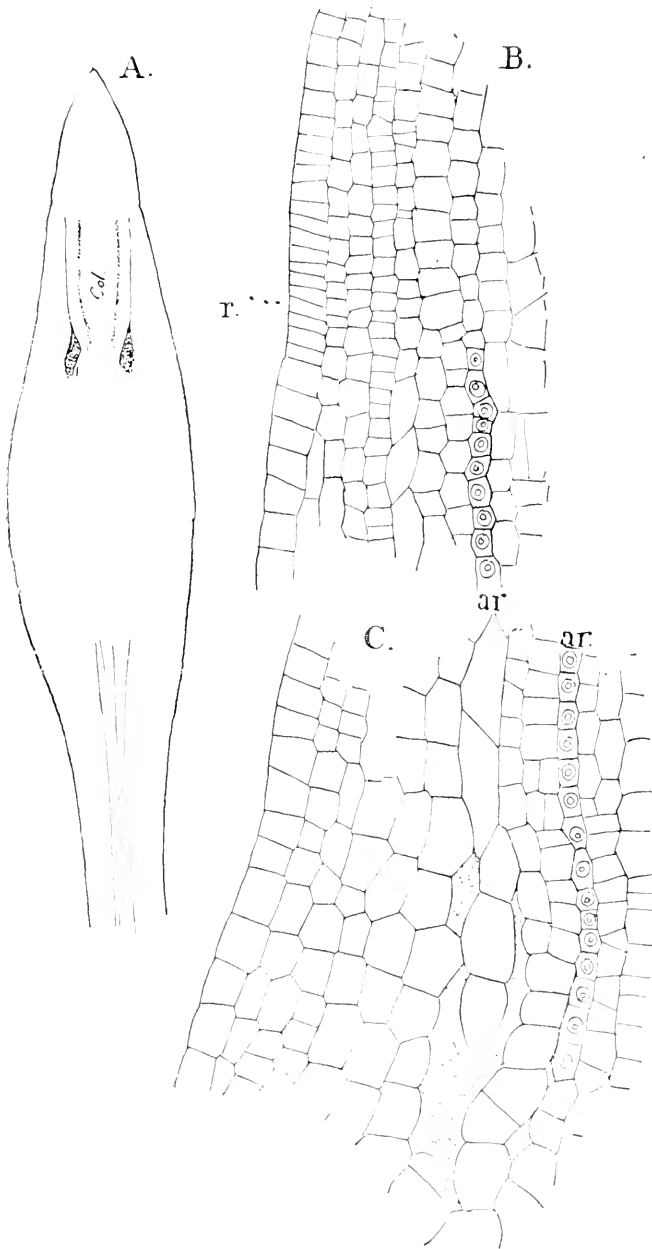

FIG. 136.

Funaria hygrometrica. A=longitudinal section of a sporogonium showing the first differentiation of its parts. \times about 400. B=the upper part of the same. \times 600. r, marks the limits of theca and operculum. C=basal part of capsule of the same. \times 600. ar=archesporium; col=columella. (After Campbell.)

Meanwhile, however, other changes supervene, and they are especially marked in the amphithecium; but all such changes are nothing more than secondary modifications of the amphithecial tissue: there is no development of new parts, however greatly the external appearance of the sporogonium may be affected by their presence. They may be considered in

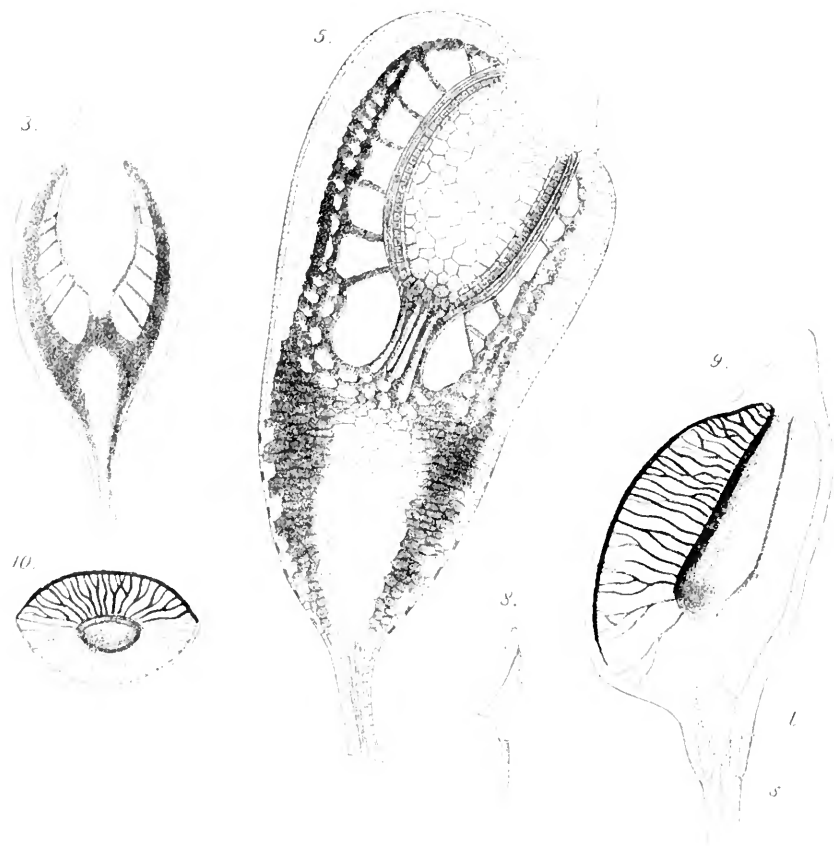

FIG. 137.

3. Diagrammatic longitudinal section through the green capsule of *Physomitrium pyriforme*. : 14. 5. Median longitudinal section through the mature green capsule of *Funaria hygrometrica*. : 20. 2. Profile view of mature capsule of the dorsiventral capsule of *Funaria aphylla*. 6. Median longitudinal section of the same capsule; *l*=cylindrical air-space; at *s* the stomata. : 19. 10. Transverse section of the same capsule, about the middle. : 9. (After Haberlandt.)

succession from below upwards. The lower part of the sporogonium which forms the seta elongates more or less in different types: where well developed, as for instance in *Funaria*, its structure shows a peripheral sclerotic band, which merges gradually into thinner-walled parenchymatous tissue: centrally lies a strand of thin-walled water-conducting tissue, without cell-contents when mature, surrounded by a thicker-walled sheath.

No accurate statements are to hand showing the genetic relation of the endothecium to this central tract, but it certainly gives rise to the greater part, if not exclusively to the whole, of the conducting strand.

In the upper region assimilating tissue is usually developed in more or less close relation to the capsule itself, together with numerous and often large intercellular air-spaces. These developments are derived chiefly from the amphithecium, while at the same time the sterile cells of the columella usually expand, as a tissue for water-storage: this may also contain some chlorophyll, and occasionally forms air-spaces. The swollen shape of the capsule is chiefly

due to these changes, which are obviously secondary. Different types may be distinguished according as the assimilatory system is developed from the wall of the capsule itself, or partly here and partly in the apophysis below, or entirely in the region of the apophysis.

For instance, in *Bartramia* the assimilatory system is chiefly in the wall of the capsule, where it is equally developed all round.

In *Buxbaumia* (Fig. 137, 8, 9) the same is the case, except that the development is dorsiventral: the capsule early takes an oblique position, and the assimilatory tissue is developed more strongly

on the better-lighted side. In other cases, however, the assimilatory system extends some distance below the actual capsule,

constituting the swollen region of the apophysis: this is of small size in *Polytrichum*, and the assimilatory system is chiefly here also in the wall of the capsule, but it extends downwards to the small apophysis, while the numerous stomata lie in the narrow neck between these parts. In many Mosses, again, the apophysis itself becomes the chief seat of assimilation, as, for instance, in *Funaria* (Fig. 137, 5), and this leads to its enlargement: so much so that it becomes the most prominent feature in the whole sporogonium: thus in the Splachnaceae it is commonly larger than the capsule which it is to nourish, and in *S. luteum* (Fig. 138) it appears as a wide umbrella-like expansion, which shows a structure not unlike a leaf-lamina, with well-marked epidermis, spongy mesophyll, and stomata upon the upper surface. Still, with all these variants at or near to the

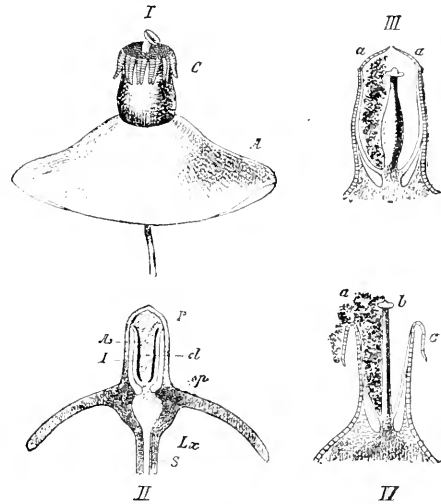

FIG. 138.

Splachnum luteum. I. Capsule open. A=apophysis. II. Unopened capsule in longitudinal section. S=seta; Lx=leptoxylem; sp=stomata on apophysis; cl=columella; P=peristome; As=archesporium; I=intercellular space. III. and IV. Diagrams to illustrate the opening of the capsule. (From Goebel, after Hedwig, Vaizey, and Bryhn.)

fertile region of the capsule, the original formation is the same: it is based upon an amphithecium, capable as we see of variously extended development, and an endothecium which is less variable, though it may expand also to form a more bulky tissue for water-storage: its most distinctive function, however, is to give rise to spores, while below it serves for conducting purposes.

Above the fertile region the endothecium as a rule develops only cells similar to those of the columella below: the amphithecium, however, undergoes changes of induration of the walls, variously distributed, which result in the formation of the operculum, the annulus by which it is detached, and the peristome which is laid bare when the operculum falls away. The details of the peristome may vary considerably in different Mosses, but in all cases it appears to take its origin from the innermost layer of the amphithecium.¹ The columella may in some cases co-operate with it mechanically in the function of spore-distribution, but neither the endothecium nor any of its products take any share in the development of the peristome.

It thus appears that the sporogonium of the stegocarpic Bryales is composed of two tissue-tracts, distinguished early from one another in segmentation, and divergent in their later development. The outer is always sterile, while the other is fertile only in part. The question arises as to the initial condition, and the origin of these regions. It may be in some degree elucidated by comparison of some of those smaller forms in which the sporophyte is of simpler construction: they have in common the feature that the mechanism of dehiscence is absent, or imperfect, and on this account they have been grouped together as the Cleistocarpace. It is clear at the outset that this condition may either have been primitive or the result of reduction: these alternatives must be kept in mind in any discussion of such forms, even though no definite conclusion be arrived at.

(b) *Cleistocarpace.*

Of the various genera grouped as the Cleistocarpace, *Phascum* has been examined developmentally by Kienitz-Gerloff: the primary segmentation is according to the type of the Bryales, with well-marked endothecium and amphithecium (Fig. 139). From the periphery of the former the archesporium is derived in the usual way, while the formation of an air-space and spore-sac, and the enlargement of the cells of the columella, are all according to the usual type: stomata may also be present, but there is neither operculum nor peristome. Developmentally there is a near similarity to *Andreaea*, though on the ground of its peculiar dehiscence and domed archesporium this genus is usually kept apart. It has, however, been pointed out above that a very slight modification of the ordinary type of *Andreaea* would produce the condition of the archesporium seen in

¹Goebel, *Organography*, p. 383.

Phascum: the sterilisation of the whole of the upper products of the endothecium at the narrow distal end of the fertile tract would interrupt the dome, and complete the columella, just as it is seen in *Phascum*. There is no inherent improbability in this, but rather the reverse: for it would be only introducing one further step in sterilisation. On such grounds the relation of the Phascaeae to the Andreaeaceae would appear to be a near one.

Another simple Cleistocarpic form which has not only been observed externally, but also worked out developmentally, is *Nanomitrium tenerum*. The small capsule has here a provision for dehiscence by the formation of a rudimentary annulus. The segmentation of the embryo begins on the plan of the Bryales (Fig. 140, 1.), and there is as usual a differentiation of the endothecium and amphithecium (Fig. 140, II.). The cells of the

latter, after further division, become differentiated into an exiguous central columella, surrounded by relatively numerous and somewhat irregularly arranged spore-mother-cells (Fig. 140, IV.): but as maturity approaches the columella disappears, its materials having served for nourishing the spores which fill the cavity of the capsule.

The genus *Ephemerum* is closely related with that of *Nanomitrium*, from which it differs in the absence of any definite operculum: the condition of the columella is the same, but while it disappears at maturity in some species (*E. papillosum*), in others it may still be seen in the mature capsule (*E. crassinervium*). The fact that stomata occur on the capsule-wall, though when ripe this is only a single layer in thickness, has its bearing on the question whether these simple Mosses are primitive or reduced forms. A systematic position is now assigned to them by many writers apart from other Cleistocarpic forms, in close relation to the Funariaceae.

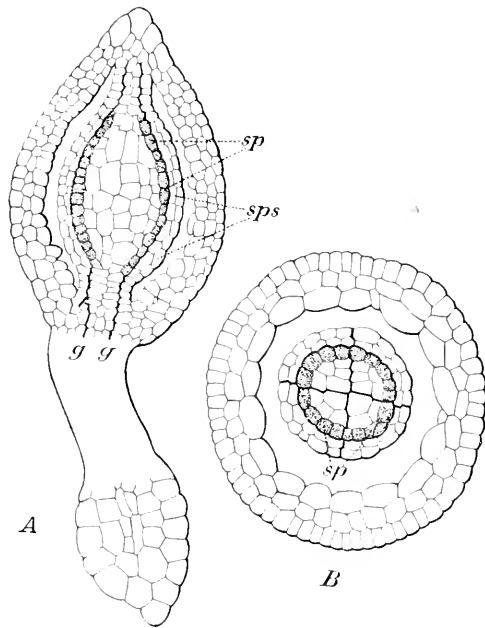

FIG. 139.

Phascum cuspidatum, Schreb. Schut. *A*=longitudinal section through a sporogonium after formation of the air-space; *sp*=archesporium; *sps*=spore-sac; *gg*=limits between amphithecium and endothecium. *B*=transverse section of the same. (After Kienitz-Gerloff.)

Another Cleistocarpic type, but again one of doubtful affinity, is *Archidium*, in which the small sporogonium has been examined developmentally by Leitgeb.¹ The first stages agree with those of the Phascaceae; but the tissue of the endothecium shows no differentiation into archesporium and columella: certain few cells of it, definite neither in number nor in position, become spore-mother-cells, while the sterile cells in which they are embedded are absorbed as the spores become matured. This condition in *Archidium* suggested to Leitgeb a comparison with that in certain Liverworts, for instance, *Riccia*; but in view of the facts ascertained by

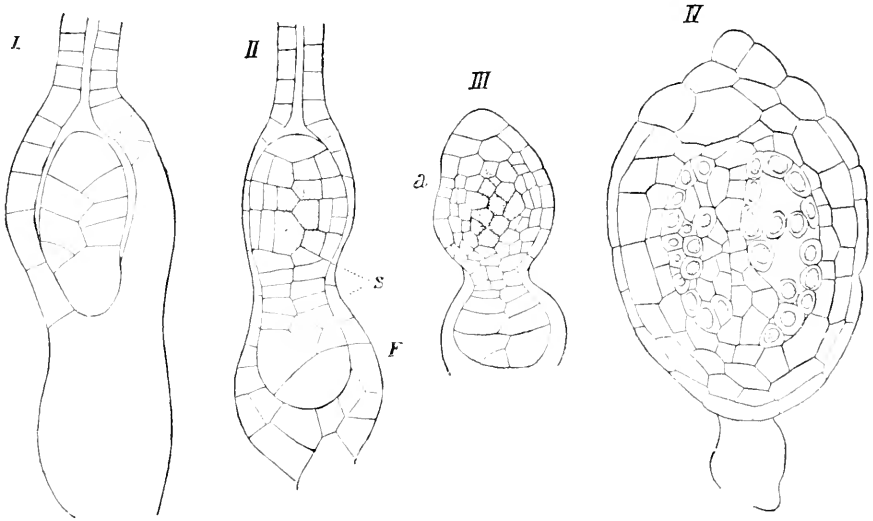

FIG. 149.

Nanomitrium tenerum. Archegonium after fertilisation and young sporogonium at different stages of development, in longitudinal section. In II. the endothecium is shaded. F=foot; S=stalk. IV. Sporogonium showing the sporocytes in greater part separate round the columella. All magnified. I. the most highly. (After Goebel.)

Lang, the comparison with *Notothylas* would seem more pertinent. Without suggesting even a remote relationship, these two forms both illustrate how individual cells, distributed without order in an otherwise sterile columella, are partially fertile; and they suggest that the whole of the columella was originally fertile. Of this in the Liverworts there is substantial comparative evidence, and this adds probability to the similar conclusion for the phylum of the Mosses.

While it is thus seen that in normal Cleistocarpic forms, which may be held to be either primitive or reduced, internal cells of the endothecium may develop as spore-mother-cells, a similar condition is also seen occasionally in Stegocarpic forms as an abnormality: cases have been described of the appearance of fertile cells among the normally sterile

¹ *Sitz. Akad. Wiss., Wien*, 1879.

cells of the columella.¹ Such facts again indicate a probability that the whole product of the endothecium was fertile in more primitive forms.

A general comparison of the sporogonia of Mosses (excluding the Sphagnaceae) thus leads to the conclusion that two distinct tissue-tracts are consistently produced in them by early segmentation, the endothecium and the amphithecium. As these are differentiated early, and with great constancy, while they differ also in their products, they are to be accepted as morphologically distinct. The amphithecium is always sterile, and to its modifications the chief mechanical and assimilatory tissues owe their origin; the modifications may involve expansion of tissues, but no initiation of new parts. The endothecium, theoretically fertile in the first instance throughout its length and breadth, underwent progressive sterilisation, parts of it being diverted to other uses: a central tract became the sterile columella, while the fertile region became abbreviated both at its upper and lower limits; and thus the actual archesporium in typical Bryales is a mere truncated residuum, with its barrel-like form open at both ends: the structural indication that its origin was as thus suggested is seen in its apparently arbitrary limitations at either end (compare Figs. 135, 136, 139).

This is well illustrated in *Funaria* and *Phascum*, where there is a continued growth with an initial cell at the apex of the sporogonium: the archesporium appears in longitudinal sections of young sporogonia as a definite row of cells on either side of the columella; but it is impossible at first to tell in those rows of cells where the exact limit of spore-development will be. Below the lower limit the cells of the row develop sterile, above it fertile; but in either case the segmentations which define the cell-row are the same. Passing to the apex, the archesporial row is continued beyond the limit of fertility: passing downwards, the cell row may also be traced into the seta: structurally the possibility of further spore-production seems to be there, but arrested. In different types of Mosses the fertile zone thus limited is not always located at the same level in the sporogonium as a whole: it is sometimes preceded by a shorter, sometimes by a longer, seta. By comparison of these different types, an idea is acquired of a residual and limited fertile zone, which has been liable to be shifted in the course of descent; and such shifting is made possible by the continued apical growth seen in the developing sporogonium. It is important to have a clear conception of the fertile zone as a residuum thus movable in the course of descent; the variable balance thus established between sterile and fertile tissues is not only interesting in its bearing on the study of sporogonia, but it will come into comparison later with similar features seen in certain strobiloid

¹ Lantzius Beninga, *Beitr. z. Kenntn. d. Mooskapsels*, 1847, Tab. 58, Figs. 9', 9". Also Kienitz-Gerloff, *Bot. Zeit.*, 1878, p. 47, Taf. 2, Fig. 52.

Pteridophytes, in which the apical growth is longer continued, and the shifting of the fertile zone consequently more obvious.

The results of progressive sterilisation should not only be studied in their longitudinal aspect, but also in the transverse, as leading towards decentralisation of the fertile residuum, and establishment of a central sterile tract. There is reason to believe that the original type, both of Liverworts and Mosses, had a solid core of sporogenous cells. In the Liverworts a step toward decentralisation is seen in the partial elaterophores of the Jungermanniaceae, but it attains a greater completeness in the Anthocerotae, where, excepting in *Notothylas*, the spore-production is relegated even to the amphithecium. In *Sphagnum* the same is the case, though there is no guide as to the evolutionary steps which led to it. In the Bryales also decentralisation has been effective, but has not attained the length of relegating spore-production to the amphithecium. The biological significance of decentralisation is plain, as the presence of a central conducting column provides a means of better nutrition for the increasing mass of spores than where these constitute a solid core. In respect of the degree of decentralisation it may be said that the Anthocerotae and Sphagnaceae are the most advanced of the Bryophytes; but all Bryophytes stand far behind the Pteridophytes in this respect, for as we shall see, in all the Pteridophytes the spore-production is referable in origin, not to deeply seated, but to superficial cells of the plant-body.

The biological circumstances of dispersal of the ripe spores, as well as those of nutrition, have doubtless affected the position of the archesporium in Archegoniate Plants. Where, as in the Bryophytes (excepting the Anthocerotae), the spores are all produced simultaneously in one capsule, which collapses at their maturity, a superficial position of the archesporium is immaterial: indeed a relatively central position will be advantageous as simplifying the problem of nutrition. Dispersal of the ripe spores is then carried out by some drastic method of decay or of dehiscence of the protective wall, and the whole sporogonium ceases its functional activity with the liberation of the mature spores. The central tissues can be sacrificed with impunity where, as in the Bryophytes, the spore-production is simultaneous. But in Vascular Plants the spore-production is in one way or another successive, and the succession, acropetal as a rule, brings with it the great biological advantage of spreading the physiological drain for nutrition over a longer period. In this case the central tissue cannot be sacrificed, but must be maintained as a nutritive core, in the interest of the later-formed spores of the acropetal succession. A more superficial position of the archesporium thus becomes necessary, while the projection of the separate sporangia beyond the surface which bears them will increase the facility for scattering the spores when mature. Thus the difference between the deep-seated position of the archesporium of the Bryophytes, and its

superficial position in the Pteridophytes is intelligible on biological grounds: it is closely related to the simultaneous development of the spores in Bryophytes, as against the successive spore-production in the Pteridophytes. Still in the former some degree of decentralisation, as we have seen, brings advantages of nutrition, and its structural expression is the sterile columella: but decentralisation does not become a peremptory condition of success of the Bryophyte-type, as it appears to have been in the Pteridophytes. There is thus a biological reason for the nearer relation which all Bryophytes show to that condition which comparison indicates as primitive, where the fertile tissue is deeply seated, or even occupies a central position in the simpler types. Such considerations lend a biological probability to the theory of progressive sterilisation applied in the above pages to the sporogonia of the Bryophyta.

Reviewing the Musci as a whole, the evidence of progressive sterilisation in them is less cogent than it is in the Hepaticae. They probably represent a more or less distinct phyletic sequence from the latter; but still analogies may be drawn between the two; such analogies strengthen the weaker evidence in the Musci; and, as there appear to be no facts which preclude such a view, while many give a reasonable measure of support, it may be held that progressive sterilisation has been effective here in essentially the same way as it is more clearly demonstrated in the Hepaticae.

CHAPTER XXIII.

INTRODUCTORY REMARKS ON PTERIDOPHYTA.

IN the comparative sketch of the sporophyte in the Bryophyta which has been given in the preceding chapters, it has been seen that for these plants a theory of sterilisation of potentially fertile cells accords well with the developmental facts. Numerous cases have been seen of cells, similar in origin to the sporogenous cells, being diverted to other uses than that of propagation: these form somatic tissue: there is indeed good reason to think that most, if not even the whole, of the somatic tissue of the sporogonium originated in this way. This is no new conception: it is a very natural corollary on the fundamental conclusions of Hofmeister: it was first clearly stated in the writings of Leitgeb on Liverworts, and was extended by him also to the Mosses: it was adopted by Goebel in his work on the Muscineae in Schenk's *Handbuch*, and it is now more definitely formulated in his *Organography*, Eng. edn., vol. ii., pp. 93-167. It may be held as the generally accepted hypothesis underlying any comparative study of the sporogonia of the Bryophytes at the present time.

But the hypothesis of sterilisation has not been extended with the same readiness to other Archegoniate forms. In treating the Pteridophytes, notwithstanding that they have an essentially similar life-cycle, there is rarely any reference in the current literature to the effect which progressive sterilisation may have had in their evolution. A certain excuse for this want of consistency may be found in the fact that in the Pteridophytes the proportion of somatic to propagative tissue is very large: any hypothesis of sterilisation must therefore recognise the process as having extended much further in them than in the Bryophytes. The form of the sporophyte also is much more complicated than in the Bryophytes: consequently the difficulties of application of a theory of sterilisation to the Pteridophytes are much greater, and the results less secure. This is certainly true, but it does not appear to be a sufficient reason for a plain departure from a theoretical position which has illuminated the comparative

study of the Bryophytes. Nor, on the other hand, does it justify the initial assumption that the origin of the sporophyte in Vascular Plants differed essentially from that in the Bryophytes. Accordingly, the theory of progressive sterilisation will here be applied to the study of the Pteridophytes also, along lines parallel to those observed for the Bryophytes. It is not to be expected that the facts will amount to a complete demonstration: the present object will be to see how far they accord with a theory which has its more obvious application in the simpler series of Archegoniate Plants.

The most important evidence will naturally be obtained from the study of the spore-producing members themselves; and these will be described in detail in the several types of Pteridophytes. But facts of value bearing indirectly on the general hypothesis, are also to be derived from the form and structure of the vegetative parts, as well as from their origin and early development. In fact, the whole sporophyte is to be studied in relation to the question of its origin, just as much in the more complex as in the simpler Archegoniate forms. One guiding line must constantly be maintained, and it is this: that however late in the individual life the production of spores may appear, still spore-production was on our general hypothesis the first office of the sporophyte. By various means the vegetative phase may have attained a large size, and great complexity of structure: but however preponderant it may appear, still we should be prepared to regard it theoretically as secondary, that is, as a phase intercalated between the events of nuclear fusion in the zygote and reduction in the spore-mother-cell.

It will be well to observe some regular order in the discussion of the large area of fact involved. The several groups of the Pteridophytes will accordingly be taken in succession, starting from those with relatively small appendages and strobiloid habit, and proceeding to those with appendages of larger size. The fossil representatives will be included in the discussion, together with the living forms. In each group a preliminary section will deal with the external characters of the mature organism, with special reference to the balance of the vegetative and reproductive regions. It will be followed by a detailed examination of the spore-producing members, and lastly, certain facts of anatomy and of embryology will be considered in their bearings on the general question. The characters of the gametophyte will only be referred to incidentally, so far as they affect the biological circumstances of the young sporophyte.

If then the Pteridophyta be arranged according to the complexity of the appendages, and especially of their spore-producing parts, the *Lycopodiales* will come first, since in them each isolated sporangium is attached in the median plane to its subtending sporophyll.

A second series is characterised by having one or more sporangia borne on a vascular pedicel: when the number is more than one they

are disposed in radiate fashion around its distal end, which is usually enlarged. The whole structure, which is called a "sporangiphore," may be inserted directly on the axis, as in the *Equisetales*, or upon the appendages of the axis, as in the *Sphenophyllales* (including the Psilotaceae). In the latter case the position is, as a rule, in the median plane of the subtending leaf; but in cases where the sporangiphore is more elaborate and shows indications of branching the position may be less obvious. Extreme elaboration of the sporangiphore, sometimes including its branching, is seen in the series of the *Ophioglossales*, which appear as the most advanced examples of this pedicellate or *Sporangiophoric Type*.

In a third series, the *Filicales*, the sporangia are usually grouped in "sori," which have features in common with the sporangiphores, but they differ from the sporangiophoric types in that the sori are distributed over the margins or surfaces of the leaf itself, which is here of relatively large size and complex construction.

The order of description will follow the sequence thus laid down, and it will become apparent that the elaboration of the leaves themselves follows roughly parallel with that of the sporangial arrangement: in fact the whole series may be regarded as progressing from simpler to more complex types of the whole shoot. The arrangement thus adopted is convenient for description. The question will be reserved for later discussion how far it indicates a true evolutionary progression.

LYCOPODIALES.

I. General Morphology.

These plants are taken first because in them the spore-producing members are more simple and regular in their disposition on the shoot than in any other Vascular Plants. Throughout this phylum (as now limited by the exclusion of the Psilotaceae), each single sporangium is subtended by a sporophyll (Frontispiece), the median planes of the sporophyll and of the sporangium coincide, and typically no more than one sporangium is associated with each sporophyll.¹ These appendages are borne laterally upon the axis, which is endowed with apical growth. The arrangement of the appendages, either sterile or fertile, is sometimes in regular whorls, but frequently it is according to some more or less interrupted spiral scheme (Fig. 141). The axis may undergo frequent branching, typically in a dichotomous manner, though intermediate steps are seen in certain species to the monopodial type: in some of the Lycopodiales, however, branching is rare, or absent. It is thus evident that the whole shoot is of a simple strobiloid type. It bears roots at its base, and in the

¹Occasional exceptions have been noted, where two small sporangia, side by side, are subtended by a single sporophyll. These are rare, and appear to originate in some form of fission of the normal sporangium (*Annals of Bot.*, xvii., p. 278).

straggling or creeping forms these may arise adventitiously at points far up along the axis. It is by comparison as regards the differences which occur in this otherwise uniform family that some knowledge of the course of development of the Lycopod-type may be derived.

The Lycopodiales are divided, according to the presence or absence of a ligule, into two divisions: the Eligulatae, which include the Lycopodiaceae, that is the living genera *Lycopodium* and *Phylloglossum*, with which are also to be associated certain early fossils designated *Lycopodites*; and

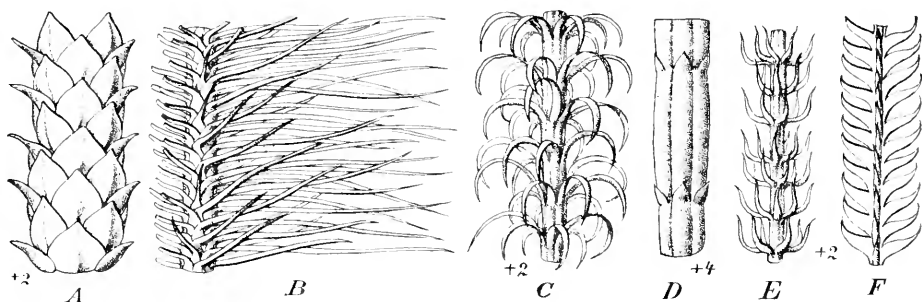

FIG. 141.

Shoots of several species of *Lycopodium* to show the form and arrangement of the leaves. *A* = *L. rufescens*, Hook. $\times 2$. *B* = *L. maudicayanum*, Radcl. Natural size. *C* = *L. reflexum*, Lam. $\times 2$. *D* = *L. casuarinoides*, Spring. : part of a terminal branch of an old plant. $\times 4$. *E* = *L. cominum*, L. $\times 2$. *F* = *L. volubile*, Forst, seen from above. $\times 2$. (From Engler and Prantl.)

the Ligulatae, which include the Selaginellaceae and Isoetaceae of living forms, together with the fossil Lepidodendraceae and Sigillariaceae. These will be severally considered as illustrating variants on the simple strobiloid type of the whole phylum.

A. ELIGULATAE.

The genus *Lycopodium*, which includes about a hundred living species, was arranged by Spring according to the degree of differentiation of the several species.¹ He distinguished two main sections of the genus, the first including those with sporangia scattered over the length of the shoot: the second including those with the sporangia associated in definite cones. The former section was again sub-divided according as the leaves were all alike, or as a distinction appeared between sterile and fertile leaves: the latter section according as the shoot was developed radially or dorsiventrally. The details of Spring's scheme have since been modified, but the principle remains the same in the classifications of the present day: it is to arrange the genus along lines which clearly indicate a progressive differentiation and specialisation of sterile and fertile tracts. Such an arrangement naturally harmonises with evolutionary theory. The species

¹ *Monographie des Lycopodiacees*, 1841.

which Spring placed first of all was *L. Selago*; and though this may not be actually the most elementary living species in the genus, still it is the best known of those which show a low degree of differentiation.

The plant of *L. Selago* is shrubby, with dichotomously branched axes, bearing numerous leaves of approximately equal size and simple form (Frontispiece). There is usually a sterile region at the base of the plant: this is followed by the well-known alternating sterile and fertile zones, the length of which corresponds with a high degree of exactitude on the several branches. They are stated to be determined by successive seasons, the middle region of each year's increment of growth being fertile. These zones are not definitely marked by any distinction of the leaves themselves, but by the presence or absence of sporangia: nor are they strictly delimited in this respect, for occasionally a single sporangium may be found in an otherwise sterile region. About the limits of these zones sporangia of smaller size may be found, which sometimes remain closed when all those near them have dehisced. These are those incomplete sporangia which have already been referred to in Chapter XIII., in connection with the argument for sterilisation as affecting the balance of the sterile and fertile regions. The condition thus seen in *L. Selago* is shared in more or less complete degree by about 40 living species, which constitute the section *Selago*: they are mostly ground-growing plants. An examination of them shows that while most of them have, like *L. Selago*, a sterile basal region of considerable length, still in certain species (*L. compactum*, Hook., and *L. Trencilla* Sodiro) sporangia have been found in the leaf-axils down to the base of the mature plant: this has been noted also, but less completely, in *L. firmum*, Mett., and *L. rigidum*, Gmel. Unfortunately these species are unknown in the embryonic state, so that it is impossible to tell how early in the individual life the formation of sporangia actually begins: but practically the whole of the mature plant is a fertile strobilus. The incomplete differentiation of the sterile and fertile zones is seen in all the 40 species: isolated sporangia are frequently found in an otherwise sterile zone, and occasionally sterile leaves occur in a fertile zone: these facts, together with the occurrence of incompletely developed sporangia at the limits of the zones, and the very uniform character of the leaves whether sterile or fertile, have their direct bearing on the theory of sterilisation enunciated in Chapter XIII.

Some ten other species were grouped by Baker under the heading *Sub-Selago*, and are characterised by having the sterile leaves a little different from the fertile, but passing into them gradually, while the sporangia are aggregated into indistinct terminal spikes. All the species thus grouped have a sterile basal region: above this follows a recurrence of sterile and fertile zones, as in § *Selago* (*L. Dalhousiacanum*): reversion from the fertile strobilus to a permanently sterile state is more common (*L. carinatum*, *gnidioides*). A progressive diminution of size of the fertile leaves upwards is seen: it is sometimes gradual (*L. squarrosum*), but

sometimes more sudden (*L. Dalhousiaeaeum*). Isolated sporangia in the sterile region are more rare than in § *Selago*, but they do occur (*L. carinatum*, *gnidioides*, *squarrosum*): also partially abortive sporangia have been seen at the base of the strobilus (*L. carinatum*). All these characters together

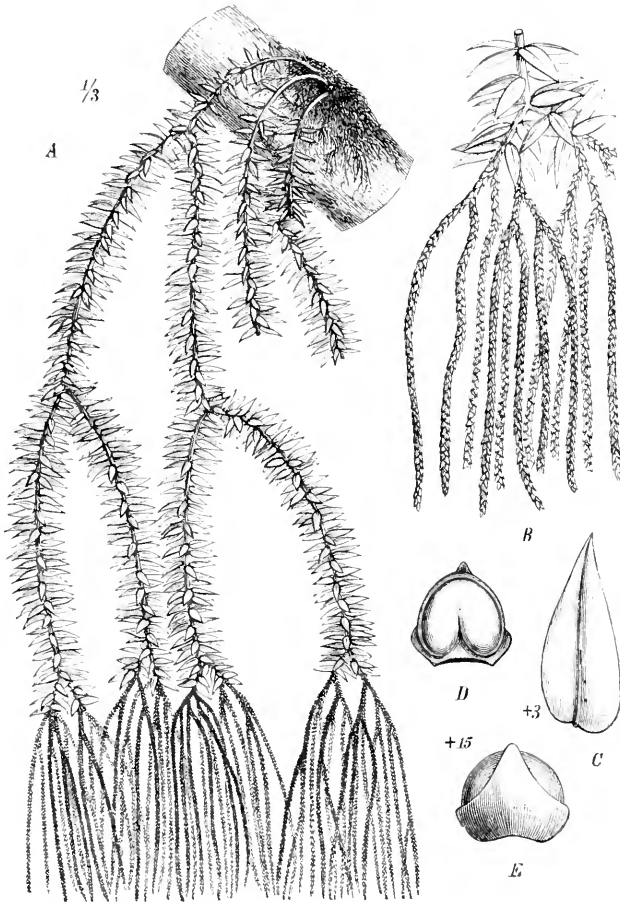

FIG. 142.

Lycopodium Phlegmaria, L. A = figure showing habit of the whole plant. One-third. B = end of a branch. Natural size. C = a sterile leaf, somewhat enlarged. D = sporophyll seen from below, enlarged. E = a sporophyll seen from above, enlarged. (From Engler and Prantl.)

show a very close similarity to what is seen in the *Selago* group, but with gradually increasing definition of the strobilus from the lower vegetative region.

In the *Phlegmaria* group, which includes about eighteen species of epiphytic character, the spikes are slender, and dichotomously forked, with sporophylls as a rule very different in size from the foliage leaves (Fig. 142). Occasionally sporangia may be found in the vegetative region

subtended by leaves of the foliage type (*L. varium*); while, on the other hand, leaves of the sporophyll type may develop no sporangia (*L. subulatum*, *Phlegmaria*). There may occasionally be alternating sterile and fertile zones (*L. nummularifolium*). Transitions from the fertile strobilus to the larger-leaved foliage shoot are frequent (*L. nummularifolium*, *subulatum*, *ophioglossoides*, *pinifolium*, *Phlegmaria*). Thus the differentiation of the strobilus is one of external form rather than a rigid difference of intimate character. The converse conditions of *L. varium* and *L. subulatum* show that the difference of size of sporophylls and foliage leaves is not due directly to correlation in the individual parts, but rather to the general condition of the shoot as a whole.

The above groups, including fully one half of the living species of *Lycopodium* are now associated together under the sub-genus *Urostachya*¹; the characters assigned are not only those of the distribution of the sterile and fertile zones, but extend also to other features. The branching of the axis is almost, or entirely, absent in the simplest of the upright forms: in the trailing or pendulous forms it is more frequent. It is of the dichotomous type, and usually in planes successively at right angles. The roots arise primarily from the basal region of the axis; in no case is there a creeping monopodial axis, with adventitious roots arising along its whole length. In about half of the species there is no formal distinction of sporophylls from the foliage leaves: where such a distinction exists the sporophylls still have a green colour, and as a rule an entire margin. The spores have a pitted surface, without external processes. These general characters indicate a natural grouping of species which are certainly the simpler living representatives of the Lycopod type.

The second sub-genus, designated *Rhopalostachya*, includes the remaining species which are more differentiated than the first in many of their characters. The branching of the axis is only dichotomous in the younger parts, and becomes monopodial later, often with a well-marked main axis. All the species are ground-growing; a few are climbers. The upright species are freely branched (Fig. 143); in the creeping species the recumbent axis gives off upright branches, and is attached to the soil by successive adventitious roots; the fertile strobili are for the most part definitely marked off from the sterile region, and are often carried upon elongated stalks, which bear minute scale-leaves (Fig. 144). The differentiation of the sterile and fertile leaves is constant; the sporophylls are pale, often chaffy scales, with toothed, ciliate margin (Fig. 143 D, E), while the spores bear reticulate flanges or prickles on their outer wall. These characters collectively mark off *Rhopalostachya* as more differentiated than *Urostachya*. But it includes some species which approach the latter; thus the three species associated as the *inundatum* group show only slight differentiation of the strobilus from the vegetative shoot, while abortive sporangia are found at the base in *L. inundatum*. *L. Drummondii* even

¹ See Pritzel, Engler u. Prantl, *Nat. Pflanzenfam.*, i. iv., p. 591.

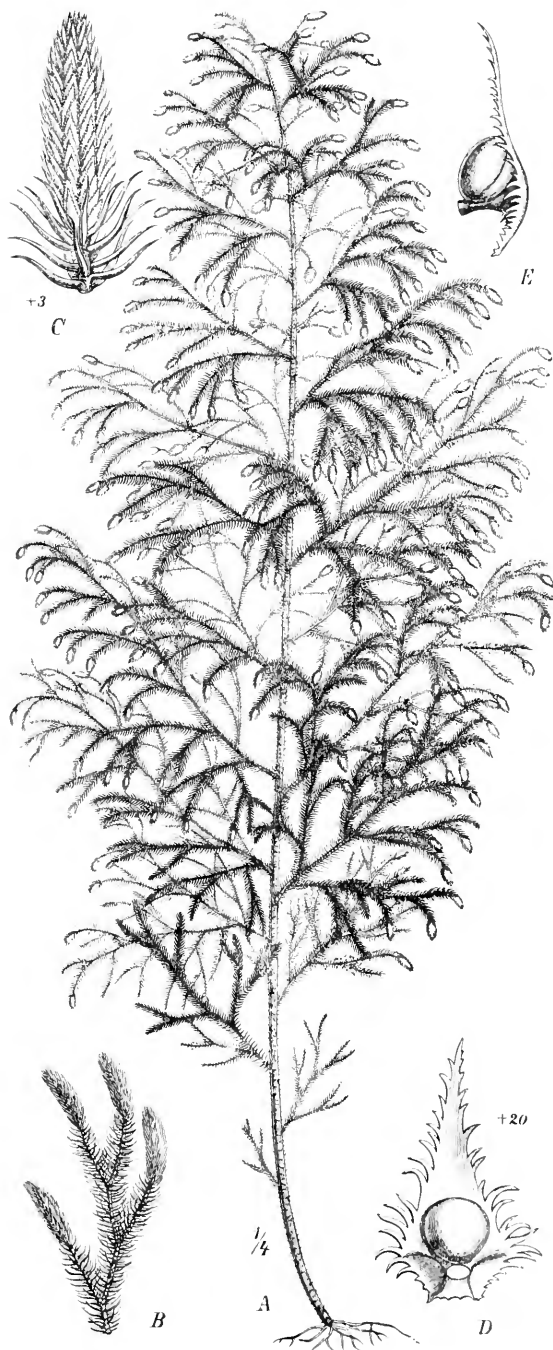

FIG. 143.

Lycopodium cernuum, L., var. *Fichtleri*, Glaz. A, general habit ($\frac{1}{4}$ natural size); B, end of a branch (natural size); C, strobilus ($\times 3$); D, sporophyll seen from above; E, ditto, from the side ($\times 20$). (After Pritzel, in Engler and Prantl. *Nat. Pflanz.*)

approaches *L. Selago* in its alternation of successive sterile and fertile zones. On such grounds the *imundatum* group has been associated with *Phlegmaria* by Baker in the sub-genus *Lepidotis*, though this association is not now upheld. In the rest, however, the definition is more exact, and is strictly maintained: for instance, in *L. ceruuum* in a very large number of specimens a transition from the strobilus back to the vegetative shoot was never observed. The same is the case in the species associated as the group of *L. clavatum*, which are terrestrial trailing species, with well-defined strobili. In this series the intercalation of a peduncle, with small distant scales, between the larger-leaved foliage shoot and the definite strobilus is indicated (Fig. 144). The question whether the peduncle is directly derived from the basal part of the strobilus, or from a specialised part of the already sterile foliage region, may be left open; but as sporangia are not found on it, nor even any vestiges of arrested sporangia, the latter seems the more probable source of the peduncle: the biological importance of it in ground-growing forms is readily understood.

Finally, the dorsiventral species, previously grouped as the sub-genus *Diphasium*, are now distributed according to their obvious affinities; the dorsiventral character of their vegetative shoot being held as a secondary adaptation: the strobilus, however, remains as clearly defined as in the more advanced representatives of the sub-genus *Rhopalostachya*, and does not share in the dorsiventral development.

A comparison of the living species of *Lycopodium* thus appears to demonstrate a progression from a less differentiated to a more differentiated state. In the simplest forms the whole of the unbranched or sparsely-branched shoot is practically a fertile strobilus, which serves the double purpose of assimilation and of spore-production.

By gradual steps the living species suggest how the two functions became separated: a purely vegetative region was established by abortion of the sporangia, and it was naturally located in the first-developed or lower part of the plant, since the function of nutrition must necessarily precede that of spore-production. The fertile upper region also became more specialised, and in the species where it is most clearly defined from the vegetative region

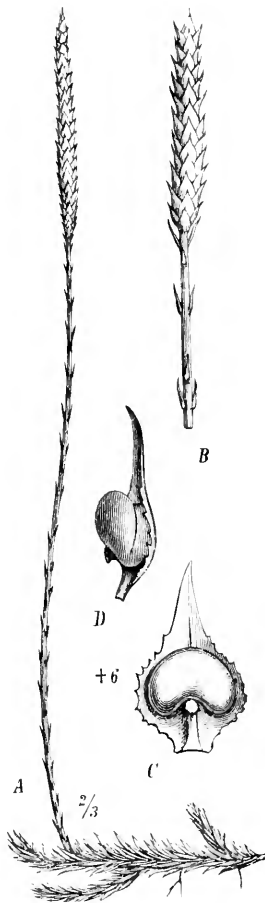

FIG. 144.

Lycopodium carolinianum, L.
A=figure showing habit. About two-thirds natural size. *B*=strobilus. Natural size. *C*=sporophyll seen from above, $\times 6$. *D*=the same from the side, $\times 6$. (After Engler and Prantl.)

the sporophylls no longer serve as assimilating leaves, but appear as chaffy scales, performing a protective function. It would be difficult to read from the comparative study of the mature sporophyte in the genus *Lycopodium* any other evolutionary story than this.

The only other living genus of eligulate Lycopods is the monotypic *Phylloglossum*, long recognised as the simplest of them all. The mature plant as seen above ground consists of a tuft of almost cylindrical assimilating leaves, from the midst of which rises the simple axis terminated by the short strobilus; below ground are found two ovate storage tubers, one dating from the preceding year and in course of exhaustion, the other in course of development as a store for the succeeding year. There are also one or more roots (Fig. 145). The lower parts of this curious little plant cannot be properly understood till it is compared with the embryos of certain species of *Lycopodium*, for it repeats in its annual growths their embryonic characters: the discussion of them will therefore be postponed (p. 351). The very short strobilus shows a similarity to the *Urostachya* rather than to the *Rhopalostachya* section of the genus: this is

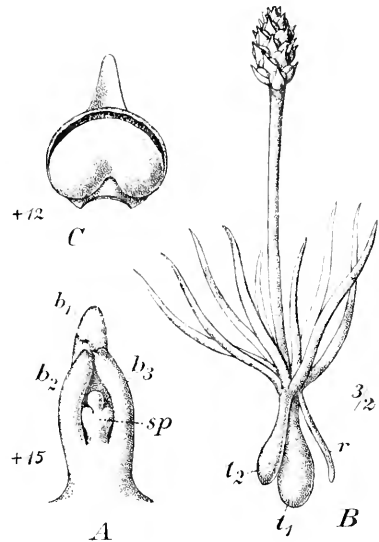

FIG. 145.

Phylloglossum Drummondii, Kunze. A = apex of a germinated tuber; b_1, b_2, b_3 , leaves; sp = the young strobilus. $\times 15$. B = the whole plant. \times one-half. t_1 = the old tuber; t_2 = the young tuber; r = root. C = sporophyll with sporangium seen from above. $\times 12$. (After Engler and Prantl.)

seen in the smooth margin of the rather fleshy sporophylls, as well as in the incomplete protection of the sporangia. It is interesting to note that transitions are occasionally found between the foliage leaves (protophylls) and the sporophylls: Fig. 146 A shows a case where a single sporophyll of larger size than the normal, with a sporangium in its axil, stands isolated some way below the strobilus: thus it is intermediate both in position and in character between the two types. A small protophyll without any sporangium may also sometimes be found at the base of the pedicel. Dichotomous branching of the strobilus is sometimes seen, but it is rare: an example is shown in Fig. 146 B. Such features are important for comparison with *Lycopodium*, and indicate that there is a close relation between the two genera.



FIG. 146.

Phylloglossum Drummondii, Kunze. A = a plant showing protophylls and strobilus: one sporophyll of the latter is at a distance below the rest, intercalary growth having taken place in the axis above it. $\times 3$. B = a plant with the strobilus branched into two unequal parts. $\times 3$.

Of the fossils which have been referred to a near affinity with *Lycopodium* under the name *Lycopodites*, many have been shown to find



FIG. 147.

Lycopodites Stockii, Kidst. 1 = specimen, natural size; a, b, sporangia; g, sporophyll. 2 = sporophyll enlarged. 4 = small portion of stem, enlarged, showing verticillate leaf-bases. (After Kidston.)

their true place elsewhere.¹ But some at least of them show distinct Lycopodinous characters: for instance, *Lycopodites Stockii*, Kidston, from the calciferous sandstone of Dumfriesshire. In habit it is like *Lycopodium*

¹ Kidston, *Trans. Nat. Hist. Soc.*, Glasgow, vol. vi., p. 32.

Phlegmaria, showing a terminal strobilus, with sporangia, and the sporophylls smaller than those borne by the more lax region of the shoot below (Fig. 147). The leaves are arranged in whorls—a condition not unknown among species of the *Phlegmaria* group. The sporangia do not appear to have been restricted to the terminal strobilus, but to have occurred also in relation to the larger foliage leaves: this is a condition which has been seen to occur in *L. varium*, as well as in the living species of the group *sub-Selago*, from which the *Phlegmaria* group appear to be a specialised offset. So far from this distribution of the sporangia raising a difficulty, it seems to point to the existence in very early strata of a Lycopodinous type showing characters which exist in living species, and which comparison indicates as primitive. These fossils are unfortunately rare, and in the particular case of *L. Stockii* the essential facts are based upon a single specimen.

B. LIGULATAE.

The ligulate Lycopodiales resemble the Eligulatae in general habit, but they differ from them in the presence of a small process—the ligule—borne on the upper surface of the leaf, near its base: also whereas the living Eligulatae are all homosporous, all the living Ligulatae are heterosporous. *Selaginella* is the preponderant genus of the living Ligulatae: its vegetative development is characterised by frequently repeated branching of the axis, which bears numerous small leaves: but whereas in *Lycopodium* the dorsiventral development of the shoot is the exception, and the radial the rule, in *Selaginella* only a few species show the radial construction as a permanent character: the latter, as Goebel remarks,¹ usually grow on dryer and brighter spots than the dorsiventral. As the result of experiments on species such as *S. sanguinolenta*, in which anisophylly is not constant, but appears under the influence of external factors, Goebel concludes that the dorsiventrality is a phenomenon of adaptation brought about by light: thus the radial type will naturally be the more primitive. In the great majority of the living species, however, the strobilus is isophyllous, even where the vegetative shoot is anisophyllous: thus indicating that it is the more conservative part of the plants. But in some ten per cent. of the living species the strobilus itself is also anisophyllous. The definition of the strobilus from the vegetative shoot in *Selaginella* is more marked than in *Lycopodium*: a condition corresponding to that of the *Selago*-group of *Lycopodium* is unknown, nor have isolated sporangia ever been observed in the vegetative region: the differentiation of the sporophyte of the genus as a whole corresponds to that of the more specialised types of *Lycopodium*. But imperfect sporangia have been observed at the base of the strobilus of *S. spinulosa*, and *Martensii*, and would doubtless be found in many other species: this condition is open to the same interpretation as

¹ *Organography*, vol. i., p. 105.

in *Lycopodium*. As is well known, the megasporangia and microsporangia are alike in their early stages of development, though differing later in the spores which they produce: this additional degree of differentiation in the genus falls in with the higher differentiation noted in the vegetative organs, as compared with *Lycopodium*.

Of the species with radial construction, the best known is *S. spinulosa*, specially investigated by Bruchmann:¹ this will be briefly described for purposes of comparison on the one hand with *Lycopodium*, and on the other with the related fossils, while the dorsiventral *Selaginellas* may be regarded as specialised offsets from some such radial type as this. The seedling of *S. spinulosa* is like other *Selaginellas* in having an upright elongated hypocotyl (Fig. 148), which is continued directly into the primary root: the hypocotyl bears two cotyledons, after which a variable number

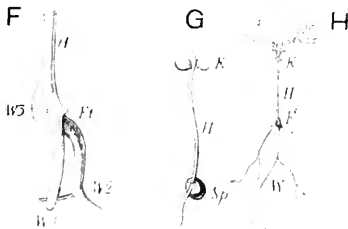

FIG. 143.

Selaginella spinulosa. G=young seedling with megaspore attached, showing elongated hypocotyl (H) and cotyledons K. H=seedling more advanced showing dichotomy. F=base of hypocotyl with swollen knot. W=roots, H=hypocotyl. Et=suspensor (after Bruchmann). H=natural size. F, G=enlarged.

of pairs of epicotylar leaves are formed before the first branching, which is a true dichotomy. The limbs thus formed branch repeatedly, at first dichotomously, but later monopodially, all the branchings being in one plane, at right angles to that of the first dichotomy: thus two fan-like branch-systems are produced, of which certain stronger branches are fertile, the rest sterile (Fig. 149). The arrangement of the leaves of the primary axis is decussate, but on the later branches there are transitions to spiral,

while in the thicker strobili the arrangement is on a complex spiral plan. The main axis terminating below in the hypocotyl remains permanent, and its base swells at the level of the suspensor to form a knot, from which alone the later roots originate: they are formed endogenously in swellings of tissue of the knot, and burst their way outwards through the superficial tissue. The whole plant of *S. spinulosa* is thus dependent upon a central source of water-supply from the base of the main axis. In most species of *Selaginella*, however, the well-known rhizophores are formed, at the branchings of the axes of higher order, and thus their rooting may be efficiently carried out at a distance from the primary axis: this is probably a derivative condition, just as the dorsiventral development, of which it is the usual concomitant, is also derivative. Both in the form of the shoot, and in the central rooting, the type of *S. spinulosa* may be held to be more primitive than the common dorsiventral type of the genus: in these respects it will be seen to correspond more nearly with the large fossils than do the more specialised species of the genus.²

¹ *Unters. über S. spinulosa*, A. Br., Gotha, 1897.

² See Goebel, *Organography*, vol. ii., p. 230.

But the Fossil Ligulates were not all large. There is evidence that small organisms, corresponding in habit to the heterophyllous *Selaginellas*, existed also in early geological times. The fossil from the Upper Coal Measures, described as *Lycopodites Guthieri*, Göpp, can hardly have been anything else. *Lycopodites primævus*, Schr., from the Westphalian Middle Coal Measures, though it shows no distinctly Selaginelloid shoot, has heterosporous sporangia, with megaspores more numerous than four in each sporangium, as shown me by Mr. Kidston, in specimens belonging to the Brussels Museum. A similar condition has been described by Zeiller¹

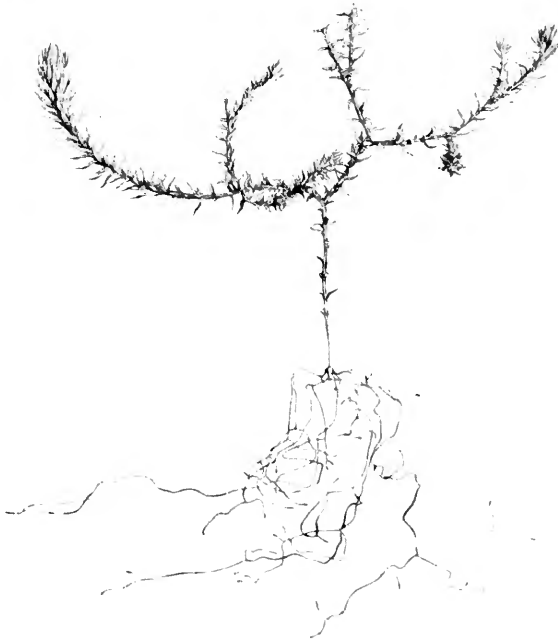

FIG. 149.

Plant of *Selaginella spinulosa*, with root-system springing from swollen knot at base of the upright hypocotyl. Natural size.

in a plant from Blanzky, named by him *Lycopodites Suissei*, where the number of megaspores was found to be 16 to 24. In these cases the reduction in number of the spores as a consequence of heterospory appears to have proceeded less far than in the modern *Selaginella*. But, on the other hand, the carboniferous plant described by Bertrand as *Miadesmia* corresponds in structure, as well as in the heterophyllous arrangement of the leaves and in the presence of a ligule, to *Selaginella*, while it appears to have progressed towards a seed-like fructification. The minute new species *Miadesmia membranacea*, Bertrand, has been directly compared with *Selaginella spinulosa* (= *S. selaginoides*, Link) by Miss Benson,² in respect of characters other than the seed-like structure

¹ *Comptes Rendus*, April, 17, 1900.

² *Proc. Roy. Soc.*, Series B, vol. lxxix, p. 473

borne by the megasporophyll. So far as it goes, then, the evidence from the fossils favours the conclusion that plants resembling *Selaginella* existed in the primary rocks, and that even the more specialised heterophyllous type of *Selaginella* dates at least from the Carboniferous period, while it seems possible that a seed-like habit had already been established.

The dendroid Lycopodiales are among the earliest known fossils, dating from the Lower Devonian period to the Trias. They include the families of the Lepidodendraceae, Bothrodendraceae, Sigillariaceae, and

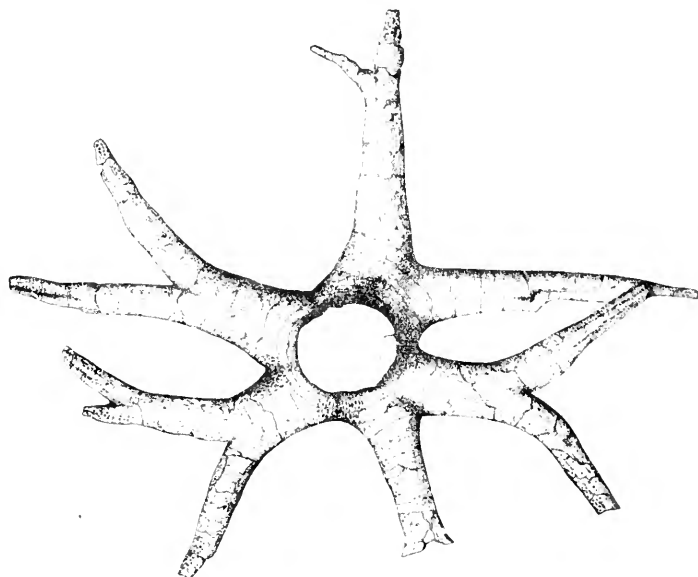

FIG. 150.

Ground plan of a Tree-stump with Stigmaria-trunks. One-sixtieth the natural size.
(After Potonié.)

Pleuromoiaceae. Underlying the differences of detail according to which these families are distinguished, there is a general unity of morphological plan: the essential features of it are as follows. The main axis was upright, rising in some cases to a height of 100 feet. It was bulky relatively to the numerous simple leaves which it bore: it branched upwards in a dichotomous manner, in most cases profusely: in some of the Sigillariaceae, however, and in *Pleuromoi*a branching may be entirely absent. The development of the branches of the dichotomy were in various cases either equal or unequal, a fact which leads to differences of habit, as is seen to be the case in *Lycopodium* or *Selaginella*. The axis was fixed in the soil by a shallow and broadly spreading system of Stigmarian trunks (Fig. 150). In *Lepidodendron* the main Stigmarian trunks usually numbered four, which bifurcated repeatedly, thus forming a

widely spreading system: from these the rootlets radiated in all directions, developing to a length of a foot or more, and showing dichotomous branching. The underground system was thus proportional to that above ground. In the Sigillariaceae similar trunks are found, but it seems doubtful whether they show the same constancy of initial type as in *Lepidodendron*. In *Pleuromioia* the base of the upright stock swells into a tuberous body, which is very *Stigmaria*-like in the fact that it is covered by root-scars, while it extends into four blunt processes corresponding in position and character to Stigmarian trunks, though much shorter (Fig. 151). It would seem probable that in this relatively late Triassic fossil (which is unfortunately known only in the form of casts, not structurally), a simple representative of the Lepidodendroid basal region is correctly recognised. In all of the dendroid forms the Stigmarian trunk appears to have been present, as a basis for the roots: but the latter were not restricted to that position: Potonié shows how the scars of their insertion may be sometimes found on the leaf-bearing axes also, associated with some degree of regularity with the leaf-scars.¹

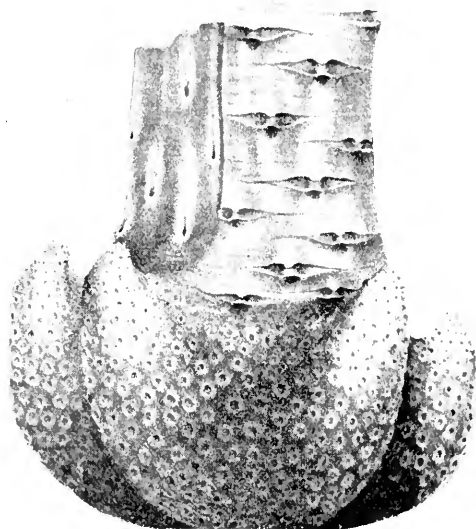

FIG. 151.

Pleuromioia Sternbergii. Swollen base of stem with root-scars, and showing part of the aerial stem, with the epidermis and leaf-scars on the right, and on the left the sub-epidermal sculpture. (After Bischof, from Engler and Prantl.) Two-thirds natural size.

The leaves of the fossil Lycopodiales were sometimes of considerable size, but unbranched and of simple form.

They expanded at the base into the well-known cushions, which in many forms occupy the whole external surface of the axis: this corresponds to what is seen among the living Lycopods. On the upper surface of the leaf, near its base, the ligule is seated: it appears to have been a constant feature in the dendroid Lycopodiales, and the occurrence of it links them rather with *Selaginella* than with *Lycopodium*. It was often seated in a deep pit—as it is in some living *Selaginellas*—and this pit persists as a marked feature in the neighbourhood of the leaf-scars, whenever the cast of a stem-surface is well preserved (Fig. 152).

The vegetative region appears to have been, as a rule, purely vegetative: the sporangia are restricted to well-defined cones or strobili,

¹ *Lehrbuch der Pflanzenpalaeontologie*, p. 212, Fig. 215.

similar in their general characters, as also in their clear definition, to those of the more differentiated types of *Lycopodium* or to *Selaginella*. The general structure of the strobilus is, as in other Lycopods, essentially the same as that of the vegetative shoot, excepting in the presence of the sporangia. These are of very large size, and are commonly extended radially outwards from the axis, being interposed between the axis and the ligule: the latter then appears on the upper surface of the sporophyll, beyond the distal limit of the sporangium (Fig. 153). In *Lepidodendron* the cones thus constructed were borne on the ends of the ordinary

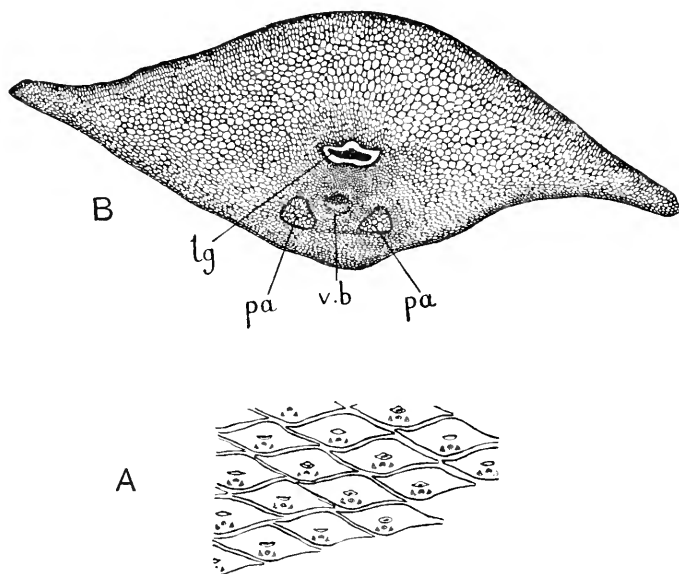

FIG. 152.

Lepidophloios, sp. A=tangential section from the outside of a stem, passing through the leaf-bases, and showing their characteristic form, slightly enlarged. B=a single leaf-base, to show details; *v.b.*=collateral vascular bundle; *pa*=the two parichnos-strands; *lg*=ligule in its pit. $\times 10$. Will. Coll., 1974 A. (After Scott.)

branches; but in *Sigillaria* they appear to have arisen laterally upon the main axis, from which after maturity they were deciduous, and each was borne upon an elongated pedicel covered with acicular bracts, while the cone itself showed a construction essentially similar to that of a small *Lepidodendron*.

Though the type with a definite cone marked off from the sterile region was usual for the fossil Lycopodiales, it was not universal. In the imperfectly known plant, *Pleuromoia* from the Trias, the whole main axis seems to have been a strobilus (Fig. 154), borne upon a Stigmarian base (compare Fig. 151). But a much more satisfactory example, from the Westphalian series (Middle Coal Measures) is that of *Pinakodendron musivum*, Weiss, specimens of which, discovered by M. Hector Delteure

at Mariemont in Belgium, are about to be described by Mr. Kidston: to him I am indebted for the information that this large Lycopod bore its sporangia associated with the leaves of certain portions of the stem, without any cone-formation, or alteration of the form or disposition of the leaves which bear them: the fertile and sterile portions are distinguished only by the presence or absence of sporangia. It is, in fact, a typical representative of the "*Selago*" type, but of dendroid dimensions. In this connection it is interesting to note that Solms Laubach mentions certain "remains of great size, remarkable for the unusual thickness of the axis — classed by Lesquereux with *Lepidophloios*. Weiss also has described a similarly colossal cone as *Lomatophloios macrolepidotus*, but, unfortunately,

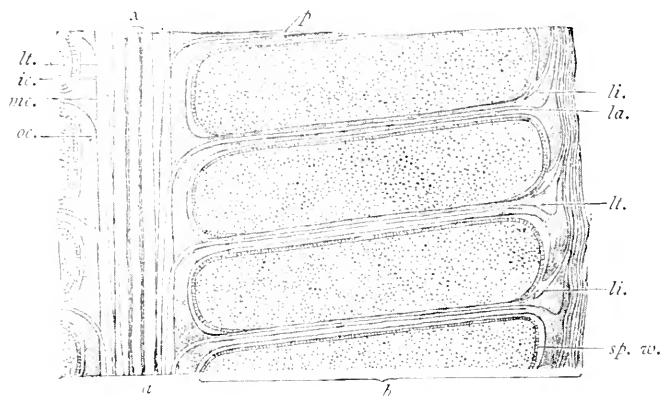

FIG. 153.

Lepidostrobus. Diagram showing axis and sporophylls in radial section. *a*=axis of strobilus; *b*=sporophylls and sporangia; *r*=stele; *i*, *c*=inner cortex; *m*, *c*=middle cortex; *o*, *c*=outer cortex; *p*=pedicel; *la*=lamina of sporophyll; *li*=ligule; *l*, *t*=leaf-trace; *sp*, *w*=wall of sporangium. (Enlarged after Maslen, from Scott, *Studies in Fossil Botany*.)

there is no detailed account of it. The enormous size of the axis in these specimens gives rise to the suspicion that the fructification was not confined to special fertile shoots, but might occasionally appear on the leaves even of the main stem, which then increased in thickness, much as we see in the present day in the female flower of *Cycas*, and *mutatis mutandis* in *Lycopodium Selago*. We naturally ask, on what sort of scars could such cones be seated as lateral organs?"¹ Kidston's description of *Pinakodendron* shows that the "*Selago*" condition did actually exist in dendroid types, and thus resolves the difficulty. A similar condition is shown by the small *Lycopodites ciliatus*, Kidst., from the Middle Coal Measures,² while the still earlier *Lycopodites Stockii* (compare Fig. 147 above) also has its sporangia associated with leaves of the foliage type. Finally, the imperfectly known *Lycopodites Reidii*, from the Devonian of

¹ *Fossil Botany*, Engl. edn., p. 235.

² *Trans. Nat. Hist. Soc.*, Glasgow, vol. vi., p. 37.



FIG. 154.

Pleurozia Sternbergi. Axis, with the lower part of the terminal strobilus. Two-thirds natural size. After Bischof. (From Engler and Prantl.)

Scotland, has been compared by Penhallow with *Lycopodium Selago* as regards the undifferentiated shoot.¹ Without attaching too much importance to the last example, it appears certain that Lycopods, even of large size, existed in very early times, in which there was no clear differentiation of vegetative and fertile regions: in fact, the "*Selago*" condition dates back to the Primary Rocks.

There can be no question of the Lycopodinous affinity of the fossils thus described briefly in their general morphology: it remains then to indicate where the nearest correspondence is to be found between them and living forms. They are plainly related to the Ligulate Lycopodiales, and, being of a radial type of shoot, and usually, if not always heterosporous, the correspondence is nearer to the radial species of *Selaginella*: this suggests a comparison with *S. spinulosa*, from which some interesting points will emerge. In the first place, the difference of size is to be discounted: however diverse the gigantic *Lepidodendron* may seem from the minute *S. spinulosa*, the comparison really relates to the relative position and character of the parts composing the plant-body. The parts which form the shoot—axis, foliage-leaf and sporophyll, the ligule, and the sporangium—are identical in both as regards their relative positions, though differing greatly in their number and dimensions: in the dichotomous branching, and in the relation of the resulting shoots to the upright main axis they are alike: also in the dependence of the whole plant for its water-supply upon the base of the primary axis. In fact, *Selaginella spinulosa* is like a *Lepidodendron* in miniature, as regards the scheme of its construction. The comparison extends also to that curious knot which is

found at the base of the main axis in *S. spinulosa*: here the origin of the roots is strictly localised: they appear endogenously on indeterminate

¹ *Cavation Record of Science*, 1892, p. 8.

outgrowths from the axis itself, which have been regarded as rudimentary rhizophores. It does not seem an undue strain of comparison to suggest that in this basal knot is still to be seen, on a minimal scale, a living representative of those larger growths known as the Stigmarian trunks. These would thus be in their nature indeterminate outgrowths of the hypocotyl, as are these rudimentary rhizophores; but like them, strictly localised in origin, instead of being dispersed over the branch-system, as are the rhizophores in most modern *Selaginellas*. It is thus possible to bring the general morphology of *Lepidodendron* into relation to that of the modern *Selaginella*, a type which there is reason to believe itself dated from the Carboniferous period.

On the other hand, there are obvious relations between the dendroid Lycopodiales and the living genus *Isoetes*: this type has been found fossil in the Tertiaries, and back as far as the Lower Chalk, while in the Trias the curious fossil *Pleuromoia* is represented: but there is no sufficient evidence of the genus *Isoetes* having itself figured among the earliest fossils.

The plant of *Isoetes* consists of a short upright axis covered by relatively large leaves (Fig. 155): the axis is usually unbranched, though bifurcation occasionally occurs, a fact that has its interest for comparison with the Lycopods.¹ The leaves are essentially of one type, with broad base and acicular upper part, while seated in a pit on the upper surface, at some little distance from the base, is the ligule. The leaves may be either sterile or fertile, and in some species there is a difference in size, the sterile leaves being the smaller. The plant is heterosporous. Where the leaf is fertile the large cake-like sporangium lies in a depression of the leaf-surface, between the ligule and the leaf-base, that region being elongated to accommodate it: in the sterile leaves it is shorter. An examination of the sterile leaves of *I. lacustris* (and Wilson Smith made similar observations in *I. echinospora*) shows that sporangia in various degrees of abortion may be found upon them: in some of these spores are developed, but in smaller numbers than the normal: other sporangia may remain quite small, and produce no spores. Dissections show that, in the majority of leaves that are apparently sterile, a rudimentary sporangium is really present in a normal position. It is stated that a regular seasonal sequence is followed in the distribution of the megasporophylls, the microsporophylls, and the foliage leaves: that the megasporangia are borne on the first or outermost leaves of each annual increment, then follow leaves with microsporangia, while the sterile leaves form the transition from one year's increment to the next. It is thus seen that in the distribution of its sporangia *Isoetes* shows a condition similar to that of *Lycopodium Selago*, but that the various degrees of their abortion are better represented. It follows from the facts that after the embryonic stages are past—in which no sporangia are produced—the whole plant is

¹ Solms Laubach, *Bot. Zeit.*, 1902, p. 179.

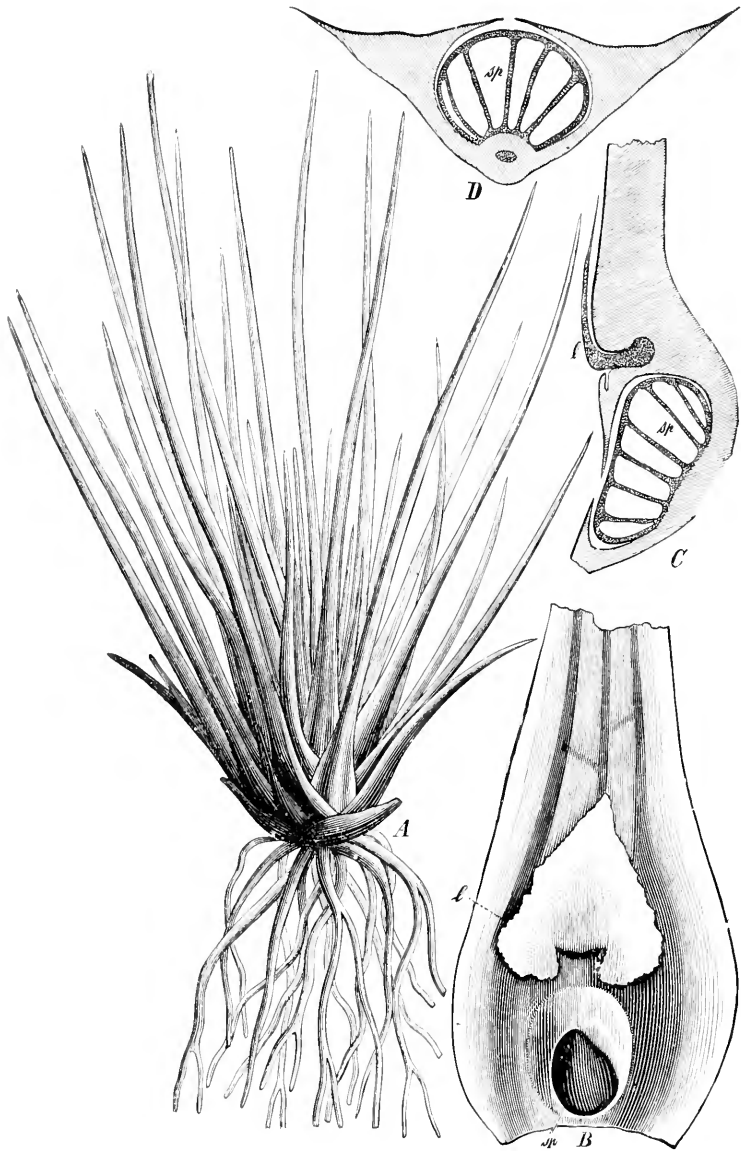

FIG. 155.

Isoetes lacustris, L. A=plant of natural size. B=base of a fertile leaf with ligule (*l*), and sporangium (*sp*) seen from above. C=longitudinal and D transverse sections of the leaf-base; *sp*=sporangium; *l*=ligule. (From Rabenhorst's, *Krypt. Flora*.)

potentially a fertile strobilus, in which the vegetative and reproductive systems are not differentiated from one another. This, together with its prevalent absence of terminal branching, points out *Isoetes* as a near approach in its general construction to the strobiloid type theoretically primitive for the Lycopodiales: this it shares with the simplest *Selago*-forms of *Lycopodium*. But it is with the dendroid Lycopodiales that *Isoetes* shows common characters of the sporangia themselves: there is also some similarity to them in the structure of its abbreviated but bulky stock: on this also the very similar bifurcating roots are inserted, but in *Isoetes* their origin is localised in the depressed grooves which traverse the stock longitudinally, instead of their being borne on Stigmarian outgrowths, as in the fossils. The *Isoetes* plant is then like a partially differentiated *Lepidostrobus* seated upon a Lepidodendroid base: in fact, like a stunted *Lepidodendron*, with its preliminary vegetative phase very short. Its mature shoot still carries on both vegetative and propagative functions, and in this lack of differentiation a primitive character is to be recognised.

The account thus given of the general morphology of the mature sporophyte in the Lycopodiales, living and fossil, shows the essential identity of their plan of construction throughout the phylum, and how in the two series, the ligulate and the eligulate, parallel conditions of differentiation are represented. In both the structure of the shoot is essentially strobiloid, with a constant numerical relation of the sporangium to the subtending sporophyll. In both series the branching of the axis is primarily by dichotomy, with a deviation in the more specialised types, and especially in the higher ramifications to the monopodial branching: but in certain simple types branching is rare, or even absent. The shoot is fixed in the soil by roots, formed chiefly, or even exclusively, at the base of the axis in the simpler types; but in the more specialised they may be formed at various other points on the shoot-system, or on outgrowths from it of an indeterminate character. In both series there is evidence of abortion of sporangia, leading to a segregation of definite tracts of the shoot-system devoted to nutrition and to propagation respectively: in the higher types the strobilus becomes a definite cone of limited growth, clearly marked off from the lower vegetative region: the production of spores is thus deferred in the individual life, and a more lengthy vegetative phase intercalated before that event. This progressive differentiation is best illustrated in the eligulate series, which is also the more primitive in respect of its homosporous condition. We are thus led by comparison of the Lycopodiales, living and fossil, to contemplate as a fundamental type of their shoot a simple unbranched strobilus with unlimited apical growth, bearing undifferentiated leaves, and having one sporangium associated with each leaf. This may not improbably have been the primitive type from which, by branching, by formation of a root-system, by differentiation of the sterile from the fertile region, and, finally, by

cessation of apical growth in the fertile branches, the whole series of forms included in the Lycopodiales arose. It will remain to be seen how far the detailed study of the sporangia, and especially of the anatomy and embryogeny of the Lycopodiales, will support this hypothetical origin.

CHAPTER XXIV.

SPORE-PRODUCING MEMBERS OF THE LYCOPODIALES.

THE normal sporangia in the Lycopodiales are always non-septate sacs, excepting that in the megasporangia of *Isoetes* there may be an isolation of the megaspore-mother-cells (see p. 320). The form is that of a kidney, of which the curvature and proportions are liable to considerable variation. The position is, as we have seen, essentially constant, each sporangium being subtended by, or inserted in a median position relatively to its sporophyll; the curvature is in the tangential plane, showing in tangential section a more or less pronounced fan-like outline. A series of examples of sporangia will be selected as illustrating the structure and mode of development, and the degree of variation in form and proportion which exists within the phylum.

The genus *Lycopodium* will be taken first, and the sporangia compared in a number of species. It will become

apparent from this comparison that the differences which they show are not at haphazard, but that they follow with some degree of accuracy those lines of external differentiation, upon which the systematic arrangement of the genus has been based. In order to make this clear the description will follow the accepted systematic order, beginning with the least differentiated types. In *L. Selago*¹ the sporangium originates at the base of the sporophyll,

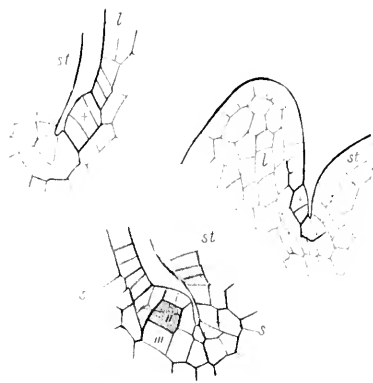

FIG. 150.

Radial sections through young sporangia of *Lycopodium Selago*. In the youngest the whole sporophyll is shown (*l*), and the axis (*st*), and it is seen that the sporangium arises upon the surface of the sporophyll. The older stages show the segmentation of the sporangium. $\times 200$.

¹ *Studies*, i., p. 511.

but clearly upon its upper surface as a transversely extended cushion (Fig. 157 A). In median radial section it appears as a convex growth, in which a central row of three cells, the result of periclinal division of one parent cell, is dominant (Fig. 156): of these the middle cell is of archesporial character. A tangential section of a sporangium of similar age (Fig. 157 B) shows that there are a number of these archesporial cells: in the example shown there are seven: but the number is not constant, as is shown by comparison of various tangential sections, and supported by sections cut transversely (Fig. 157 C). The young sporangium consists thus of a single tangential row of archesporial cells, covered in completely

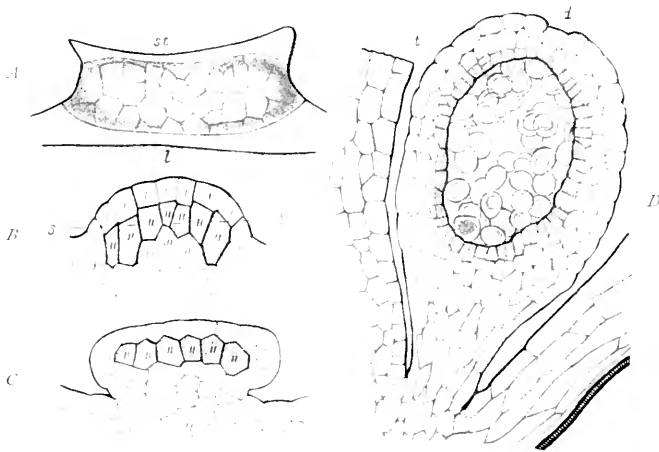

FIG. 157.

Lycopodium Selago. A=young sporangium seen in superficial view: *st*=stem; *l*=sporophyll. B=tangential section of a similar sporangium, the cells numbered i, ii, iii correspond to those similarly marked in Fig. 156. C=a sporangium of like age in transverse section, as along a line *s, s'* in Fig. B. The archesporial cells are shaded. D=an older sporangium, in radial section, showing the spore-mother-cells separated, before tetrad-division. A, B, C \times 200. D \times 100.

by a single layer of cells forming the sporangial wall, and supported below by cells which grow more actively in the middle region of the sporangium, thus leading to the curved form which it assumes later. It is clear also that all the essential parts of the sporangium originate from several superficial cells of the sporophyll, and that it is impossible to refer them in origin to any single parent cell.

At first the parts thus laid down often grow uniformly, so that their mode of origin may still be traced in a more advanced state: but later the more numerous divisions are less regular. Superficially they result in the formation of a sporangial wall, composed of three layers, or of more towards the base of the sporangium (Fig. 157 D): of these the innermost is the transitory tapetum: the tapetal investment of the sporogenous tissue is completed by development of the adjacent cells of the sub-archesporial

tissue also as tapetum. The dehiscence is along a transverse line, and the preparation for this is already indicated at the distal end in Fig. 157 D, d. Meanwhile, the sporogenous group within, in the formation of which the whole products of the archesporium are involved, has been subject to repeated cell-division: its cells finally separate, round themselves off, and all of them, as a rule, undergo the tetrad-division. In the mature sporangium the form is less strongly curved in *L. Selago* than in many other species, while the stalk is a relatively narrow one. The general proportions, as well as the imperfect protection of the sporangium afforded by the rather narrow sporophylls, are shown in Fig. 158 d, e, f.

The type of sporangium thus described for *L. Selago*, with its single row of archesporial cells, relatively narrow stalk, and imperfect protection while young, appears to be characteristic, with relatively slight modifications, of the sub-genus *Urostachya*: other species of the sub-genus which have been examined, viz., *L. dichotomum*, Jacq., *carinatum*, Desv., *nummularifolium*,

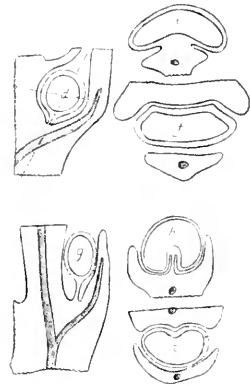

FIG. 158.

d, e, f=sections radial, tangential, and transverse of mature sporangia of *Lycopodium Selago*. g, h, i= similar sections of mature sporangia of *Lycopodium Phlegmaria*. $\times 12$.

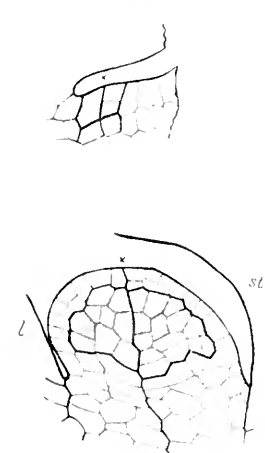

FIG. 159.

Lycopodium inundatum, L. Radial sections of sporangia. In the upper, younger figure periclinal divisions are shown in two cells, and the archesporial cells are shaded. In the lower, older figure the product of division of these cells is shown. $\times 200$.

Blume, and *Phlegmaria*, L., are all alike in showing an archesporium consisting of a single tangential row of cells, though the number of these in the row may vary; the simplest case observed was that of *L. Phlegmaria*, where the single series consisted of certainly not more than five cells, and perhaps of less. The further development in these species was also the same as in *L. Selago*, though the proportions were different. In *L. dichotomum*, however, there is the peculiarity that the sporangial wall is found to be more massive, consisting of 4-7 layers. Putting such differences aside there seems reason to regard the single tangential series of archesporial cells as a common feature of the sub-genus *Urostachya*: further, the sporangia are inefficiently protected by the sporophylls (Fig. 158 g, h, i).

In Pritzel's arrangement of the genus the section *Inundata* is separated from *Phlegmaria*, and placed in the second sub-genus *Rhopalostachya*. We shall see that the sporangial character upholds this change. The sporangia are from the first more bulky than in *Urostachya* (Fig. 160 k, l, m),

and this has been found in *L. inundatum* to go along with a more bulky origin. The sporangium as seen in radial section arises as a broad swelling, while two cells have been seen to divide periclinally, indicating at least two tangential rows of archesporial cells in place of the single row in *L. Selago*. This origin of the sporogenous tissue may still be traced in the older stages (Fig. 159). It may be that this condition is not actually constant in all cases, but it has certainly been observed to exist in *L. inundatum*.

Of the rest of the sub-genus *Rhopalostachya*, *L. clavatum* and *L. alpinum* have been examined, and they both show a still more massive type of

sporangium. This is seen in the mature state (Fig. 160 *q, r, s*; *t, u, v, w*), where the stalk appears to be short and thick: moreover, it is seen that the strobilus is constructed in these species so as to afford more complete protection to the sporangium while young, than is the case in the simpler type of *L. Selago*. This is effected by special development of the lower parts of the sporophylls (Fig. 22 *D, E*): in some

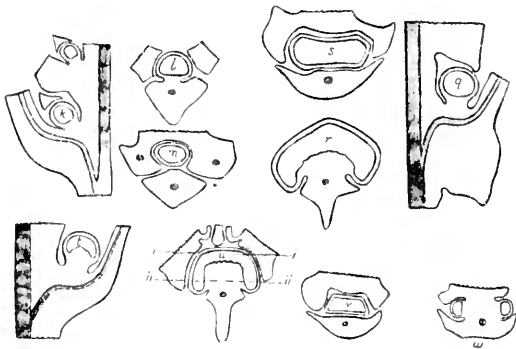

FIG. 160.

Drawings to illustrate the form and manner of protection of the sporangia in the sub-genus *Rhopalostachya*, of *Lycopodium*. *k, l, m*, sections of *L. inundatum*; *q, r, s*, of *L. alpinum*; *t, u, v, w*, of *L. clavatum*. $\times 12$.

cases, as in *L. cernuum*, the sporophyll takes a peltate form. Radial sections of the young sporangium show, both in *L. clavatum* and in *L. alpinum*, that from the first the form is broader still than in the types previously described. At least three cells in each radial section are involved in the origin of the archesporium, sometimes even more than three (Fig. 161 *A, B*). Occasionally periclinal divisions appear in the superficial cells, by which subsequent additions may be made to the archesporial tissue (Fig. 161 *B*, cells marked *x*). The tangential sections also show an advance on the *Selago* type: for twelve is not an uncommon number of the archesporial cells in one tangential row as against seven in *L. Selago*, or five in *L. Phlegmaria*. Countings of the sporogenous cells laid bare in sections of sporangia at an age approaching the tetrad-condition show that their number is far in advance of those of the *Selago* type: this is the condition to be anticipated from the bulky character of the sporangia (Fig. 161 *C, D*): moreover, their thicker and shorter stalks would be well fitted to transfer the necessary nourishment for the larger spore-output. It may be noted that in these large sporangia occasional irregular processes project upwards from the base of the sporangium into its cavity, which would

assist in conveyance of nourishment to the large mass of developing spores. Thus in the main features of form and dehiscence the sporangia of *Rhopalostachya* conform to the type of *L. Selago*, but are larger and more productive; while the sporophylls have a more elaborate form for purposes of protection. This goes along with the differentiation of the vegetative from the propagative regions, the steps of which have been traced above in the genus *Lycopodium*. The conclusion seems justly to follow that with this differentiation, which has apparently involved a diminution in the actual number of sporangia by abortion, there has come

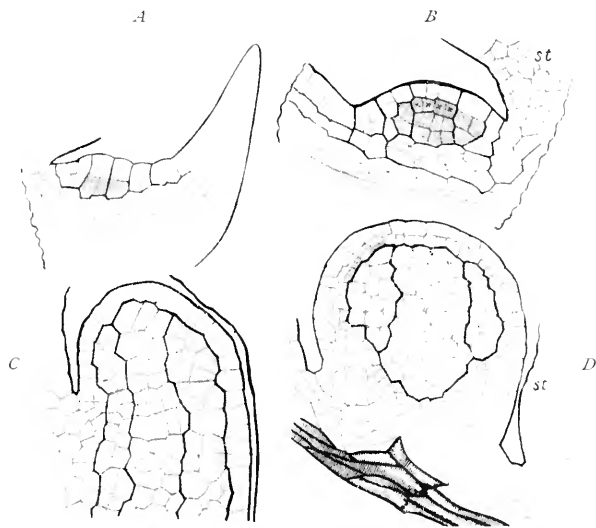

FIG. 161.

Lycopodium alpinum, L. A=Radial section through a sporophyll and young sporangium. B=the same older; in both the sporogenous tissue is shaded. D=radial section of an older sporangium; st=stem. C=tangential section of a sporangium of *Lyc. clavatum*, of similar age to D; in both these figures the sporogenous tissue is referable in origin to three rows of cells. A, B, C×200. D×100.

into existence a more massive type of sporangium, together with a more extensive spore-output from each of them, and a more specialised protection of them while young.

It has been seen that the strobilus of *Phylloglossum* resembles that of the sub-genus *Urostachya*, rather than that of *Rhopalostachya*. An examination of the developing sporangium supports this comparison, for only a single row of about six archesporial cells is found; but, on the other hand, the outline of the sporangium, and the relative thickness of the stalk, show some similarity to *L. inundatum*.

The sporangium of *Selaginella* corresponds in general type to that of *Lycopodium*. It is usually described as arising from the surface of the axis: in some species it does so (*S. Martensii*) (Fig. 162), but in others it is seated more nearly upon the surface of the leaf; in fact its position

may vary in different species though the numerical relation of one to each subtending leaf is strictly maintained. There is considerable divergence of opinion as to the details of its early development, which not improbably arises in part from want of exact uniformity in different species, partly from difficulty of observation, owing to the small size of the cells in young stages.¹ It has been seen above that *S. spinulosa* is among the least differentiated species, as regards external form, and on that account it deserves special attention. The description here given will be based on that species. According to Goebel the whole sporogenous tissue, as seen in the radial section in *S. spinulosa*, is referable in origin to a single archesporial cell, which is, however, one only of several forming a tangential series. I do not deny that this may sometimes be the case; but in my sections two primary archesporial cells were usually present (Fig. 163 A, B), somewhat as in *Lycopodium inundatum*.

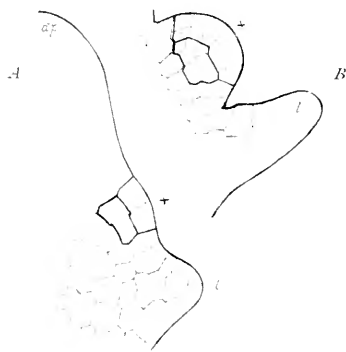

FIG. 162.

Selaginella Martensii, Spring. Sporangia in radial section. A traverses the stem apex (ap) the sporophyll (l), and sporangium (x); in the latter two archesporial cells are seen, shaded. B shows an older stage. $\times 350$.

Tangential sections show that these represent two rows of archesporial cells, with about four cells in each (Fig. 163 D).

Thus the correspondence in sporangial type with that of *Lycopodium* is very striking, as regards early development: the chief difference is in the origin of the tapetum, for this in *Selaginella* is cut off by tangential divisions from the sporogenous tissue (Fig. 163 C, E), of which it is thus a sterilised part. There is reason, however, to think that the first periclinal divisions in the young sporangium do not always

¹Observations have been made on various species of the genus: Goebel (*Bot. Zeit.*, 1881, p. 697) investigated *S. spinulosa*, *helvetica*, and *Wallichii*, and his results are restated in his *Organography*, vol. ii., p. 600; allowance is, however, made by him for some degree of variation in details. My own observations on *S. spinulosa*, and *Martensii* are described in my *Studies*, i., p. 522. Campbell, in his *Mosses and Ferns*, 2nd edition, p. 530, describes the development for *S. Kraussiana*, but his figures are by no means convincing that his reference of the whole sporogenous tissue to a single parent cell in the radial section is correct. Miss Lyon (*Bot. Gaz.*, xxxii., p. 124) has made a careful study of the development in *S. apus*, and *rupestris*, and traces the sporangium frequently if not always to a single superficial cell, which she designates the archesporium; but as the results from radial sections were not accurately checked by comparison of tangential or transverse sections, the point of ultimate origin of the whole sporangium from a single superficial parent cell cannot be regarded as demonstrated for this species. Before the details for the genus as a whole can be properly understood, the development will have to be studied in tangential as well as in radial sections, in a number of different species selected from different sections of the genus; meanwhile the substantial agreement of the sporangial type between the less differentiated *S. spinulosa* and the genus *Lycopodium* is the main point of interest for the present discussion.

define the future sporogenous tissue from the sporangial wall, but that by further periclinal divisions of the superficial cells additions may be made to it. If this be so, then the distinction between the two sources of origin of the tapetum does not appear so marked as at first sight it might appear to be.

In the microsporangia all the cells of the sporogenous group may undergo the tetrad-division, and form microspores; but Miss Lyon found that in *S. apus* not more than five-sixths of them were fertile, the rest disappear. In the megasporangia, as a rule, a single cell is early differentiated by its denser protoplasm from the rest: this alone undergoes the tetrad-division, and forms

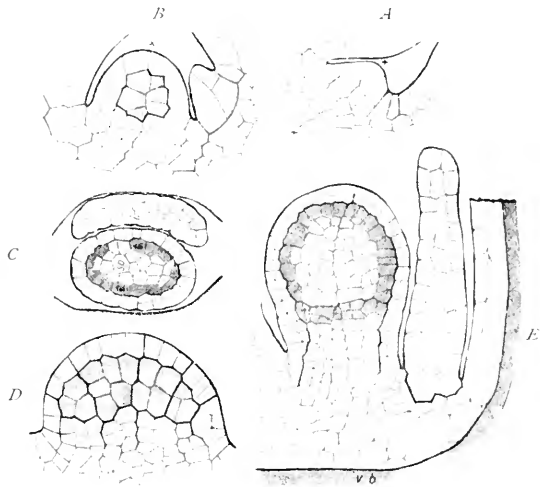

FIG. 163.

Selaginella spinulosa. A, B=radial sections through young sporangia of successive ages. C=a transverse section of one more advanced. D=a tangential section. E=a radial section of an older sporangium showing all its essential parts, together with the ligule and part of the sporophyll. A, B, C, D $\times 350$. E $\times 200$.

megaspores (Fig. 164). But in *S. rupestris* a smaller number of megaspores, or even only one, may come to maturity: in *S. apus*, however, two mother-cells may become matured, and eight megaspores be thus formed in one sporangium. These fluctuations have their interesting bearing upon the origin of the heterosporous differentiation, showing that there is some margin of variation in the number of spore-mother-cells which are fertile even in forms now living.

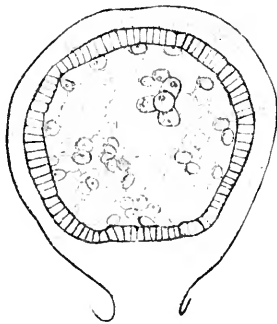

FIG. 164.

Selaginella spinulosa, A. Br. Section of megasporangium showing the single fertile tetrad still very small, and the rest of the sporogenous cells arrested. $\times 100$.

The facts relating to the sporangium in *Selaginella*, though imperfectly known for the genus at large, show that in position and in general plan the sporangium is of the usual Lycopod type; but that its dimensions are smaller than is usually the case in *Lycopodium*: the difference in origin of the tapetum is probably related to the smaller size of the whole sporangium. The heterosporous condition appears to have brought with it only minor modifications of the original sporangial type.

In *Isoetes* the position of the large sporangium, between the ligule and the axis, corresponds to that in *Selaginella*, though it is here more definitely inserted on the leaf-base, and is sunk in a deep depression of its upper surface (Fig. 155 B, C, D): but these differences of detail do not obscure the essential unity of the plan in the two genera. Instead of being a body more or less flattened between the sporophyll and the axis, as in *Lycopodium* and *Selaginella*, the sporangium is here extended radially outwards from the axis into a broad cake-like body. It may best be regarded as a result of such variation of dimensions as has been

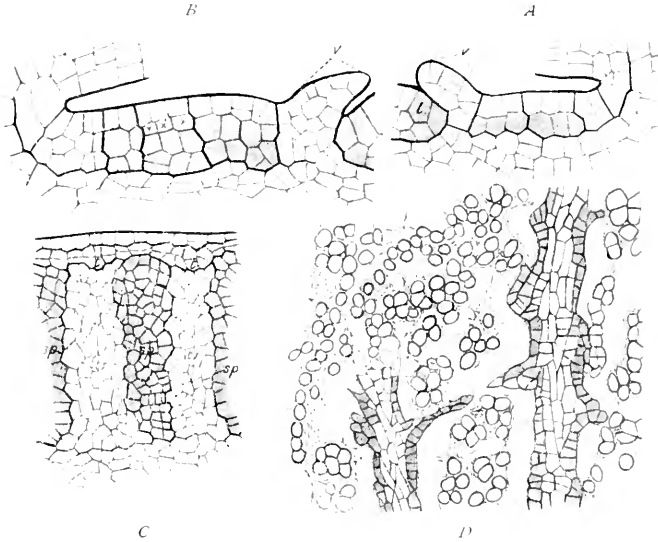

FIG. 165.

- *Isoetes lacustris*, L. A = radial section through base of sporophyll with ligule (l), velum (v), and sporangium, in which the archesporium is shaded. B = a similar section of an older sporangium. C = part of an older microsporangium, showing the potential archesporium differentiated into trabeculae (tr), and sporogenous tissue (sp), while the tapetum (t) is clearly defined. D = an older stage with spore-mother-cells separated, and tapetum shaded covering the trabeculae. A, B $\times 250$. C, D $\times 100$.

seen in minor degree within the genus *Lycopodium*, but here carried to greater lengths. The developmental details harmonise readily with this view. The microsporangium is naturally a better basis for comparison with the homosporous Lycopods than the megasporangium, and it will therefore be taken first. The mature structure of a microsporangium is shown in Fig. 155 D, which indicates how the very large internal space is traversed by the sterile trabeculae: these extend, with many irregularities of branching and wing-like expansions, which are not shown in the figure, from the sub-archesporial tissue to the covering wall. The type of the megasporangium is the same, though the trabeculae are here fewer in number but more massive, so that the proportion of sterile tissue to the fertile is much larger in the megasporangium. As the development shows,

the trabeculae have a common origin with the fertile sporogenous cells: there has in fact been a sterilisation of potentially fertile tissue, which proceeds to a greater length in the megasporangium than in the microsporangium. The early development of both types of sporangia is alike up to a fairly advanced condition, as is the case also in *Selaginella*; this fact has its bearing on the origin of their differentiated state.

The sporangium of *I. lacustris* originates from superficial cells of the leaf-base of small number, lying below the ligule (Fig. 165 A.) The cell seen immediately below the ligule in the longitudinal section of the young leaf forms the velum: the rest show some evidence of common origin by earlier anticlinal segmentation: this may very well have been so, but the comparative interest begins with their periclinal divisions, and it is then that a basis appears for comparison with what has been seen in *Lycopodium*. The periclinal division appears first in the central part of the young sporangium, and thence it extends in either direction: in the longitudinal section some four or five cells are involved in *I. lacustris*, though apparently the number may be smaller in *I. echinospora*.¹ Comparing this with the condition as seen in *Lycopodium*, it appears to be an advance on even the most complex type, such as *L. alpinum*; and this is completely in accordance with the radially extended form of the mature sporangium of *Isoetes*. Moreover, the differences between Wilson Smith's description for *I. echinospora* and my own for *I. lacustris* suggest that differences of radial extension of the sporangium exist in different species of *Isoetes* similar to those which have been shown to occur within the genus *Lycopodium*. But there does not appear to be any such correlation of them with the morphological differentiation of the plant at large as that which was traced in *Lycopodium*, and gave a special interest to the sporangial differences in that genus.

The internal cells thus cut off by the first periclinal divisions are destined to be sporogenous; but the first periclinal divisions thus initiated do not absolutely define the future sporogenous tissue: it has been repeatedly seen that additions to it may be made by subsequent periclinal division of the superficial cells, especially in the middle region of the

¹ Wilson Smith found in *I. echinospora* that he was able to trace the origin of the sporangium back in longitudinal sections of the leaf to a single cell lying between the ligule and the leaf-base: this corresponded to a transverse row of three to five cells, which formed the rudiment of the sporangium; but the cell thus recognised in the longitudinal section also formed the velum, which on that account he accepts as a sterilised part of the sporangium. Doubtless this is a logical outcome of a last analysis of cell-origins, provided it be assumed that all things are homologous which have a common origin from ultimate parent cells (see Chapter VIII.). But is there any other line of evidence than that of cell-origin to show that the velum was ever a part of a sporangium, or anything but sterile? Without such evidence the mere fact of common origin from a very early segmentation seems a somewhat shadowy ground for the conclusion which Wilson Smith proposes. If this criterion of homology be accepted, then all parts of the plant are ultimately homologous, for they all originate from the ovum. (See Wilson Smith, *Bot. Gaz.*, 1900, p. 225).

sporangium (Fig. 165 B). The potential sporogenous tissue thus produced, after successive sub-divisions, forms a very considerable sheet of tissue, several cells in thickness. Of this, however, only a portion develops into spores: in the case of a microsporangium certain tracts of cells of this tissue assume dense protoplasm, and the cells, ultimately separating from one another, undergo the tetrad-division, producing microspores (Fig. 165 C, D); but other tracts of cells, neither showing any regular outline or arrangement, nor referable in origin to pre-determined cells of the genetic tissue, become less densely protoplasmic, and form the sterile trabeculae: a tapetal tissue invests the fertile tracts: it is derived partly from the innermost layer of the sporangial wall, as in *Lycopodium*, partly from the superficial cells of the trabeculae.

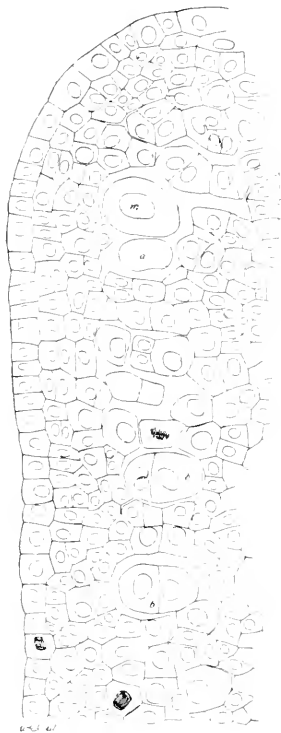

FIG. 166.

Part of a section of a megasporangium of *Isoetes*. The cell marked (*m*) is the only fertile spore-mother-cell, the rest are undergoing vegetative divisions, including the cell (*a*) as shown by other sections of the series. Thus sterilisation affects the large majority of the cells of the sporogenous group. $\times 245$. (After Wilson Smith.)

A similar differentiation of the potentially sporogenous tissue is found also in the megasporangia, the early stages of which are quite indistinguishable from those of the microsporangia; but in the former a relatively smaller number of cells, usually lying isolated in the potential sporogenous tissue, and distributed with no constant relation to their ultimate parent cells, enlarge and divide to form the megaspores (Fig. 166). As there is no opening mechanism in the submerged sporangia of *Isoetes*, no basis for comparison is yielded from that source. The study of the development in *Isoetes* thus leads clearly to the conclusion that there has been a differentiation, within the sporangia, of tissues at first of uniform character: that part of the potential sporogenous tissue remains fertile, but a large proportion in the microsporangium, and a still larger proportion in the megasporangium, is diverted to other uses, and remains sterile. As regards the origin of the potential sporogenous tissue, and the form and position of the sporangium, there is clear correspondence to the Lycopod-type, and especially to those forms with the more bulky sporangia: in fact if we imagine a heterosporous Lycopod, with its sporangium widened out radially along the leaf-surface and its enlarged sporogenous tissue partly sterilised so as to form trabeculae, the result would be practically what is seen in *Isoetes*.

A study of the sporangia of the fossil Lycopods is a necessary adjunct to that of the modern forms, though the usual absence of developmental

details in them restricts the comparison to the basis of mature structure. On this footing it appears that the type of sporangium characteristic of the sub-genus *Urostachya*, and showing special resemblance to that of *Lycopodium Phlegmaria*, dates back at least to the calciferous sandstone, for it is seen in *Lycopodites Stockii* (compare Fig. 147). Sporangia apparently of the same type have been recognised also in other early fossils referred to *Lycopodites*, but their small size and the state of preservation do not

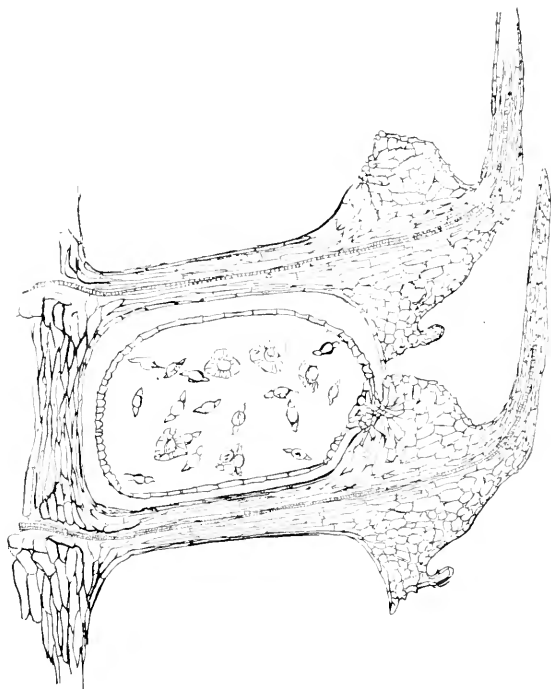

FIG. 167.

Spencerites insignis. Somewhat diagrammatic radial section of part of the cone, showing two sporophylls in connection with the axis. On the lower sporophyll the sporangium is shown attached at its distal end to the ventral outgrowth of the sporophyll: within the sporangium some of the characteristic winged spores are shown. (After Miss Berridge.) From Scott, *Progressus rei Botanicae*, vol. i.

allow of any exact comparison. Of other apparently non-ligulate types one of the best known as regards the details of the strobilus, though its vegetative region is still unknown, is *Spencerites* (Fig. 167), which has been described by Scott and others from specimens showing microscopic structure. Here the verticillate or spiral sporophylls consist of a narrow pedicel bearing an upturned lamina; at the base of the lamina is a massive ventral outgrowth, to which the distal end of the sporangium is attached by a narrow neck. The presence of the ventral sporangiferous lobe has suggested to Dr. Scott a comparison with the Sphenophyllales, though the absence of any vascular supply to the "ventral lobe" renders the analogy somewhat remote. It

is doubtful what is the evolutionary relation between the distal and the basal insertion of the sporangium upon the sporophyll; whether the one or the other is the more primitive in the *Lycopodiales* must be left for the present open, but it is evident that such differences as these are of degree only, in a type which is constant as regards the numerical relation of the sporangia to the sporophylls, and in the coincidence of the median planes of both of those parts. There seems little reason to hold that these peculiarities of *Spencerites* are archaic relatively to those of the ordinary Lycopodinous type. Comparison does not make it necessary, nor even probable, while stratigraphically the ordinary Lycopod type is quite as early as *Spencerites*.

The same relation of sporangium to sporophyll as is seen in the living Lycopods is maintained in the Lepidodendroid cones, which are

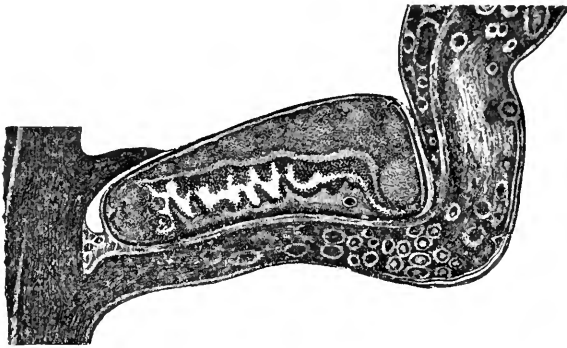

FIG. 168.

Lepidostrobus Broevnii. A radial section traversing the axis, a sporophyll, and a sporangium. In the latter numerous spores are seen partially filling it, while sterile processes project upwards into the cavity. (From Sowerby's drawing.)

known in many cases to bear ligules, and to be heterosporous, thus corresponding more especially to the ligulate series of the Lycopodiales; but this may possibly not be the case for all of them. An examination of the details of the sporangium will naturally be best carried out in the best preserved specimens, though these may not be generally typical of all others. *Lepidostrobus Broevnii*, Schpr., is probably the best preserved of Lepidodendroid cones, and it will therefore be taken first. The large silicified specimen in the British Museum was first described by Robert Brown, with drawings by Sowerby.¹ The original specimen was about two inches in length, and of about the same diameter: it was evidently only the upper half of a strobilus, as the internal structure, which is preserved with singularly little distortion, shows to be the case. It has been cut into transverse, radial and tangential sections, and consequently a very adequate knowledge of the details can be obtained. The central axis

¹ *Linn. Trans.*, vol. xx. See also *Misc. Bot. Works of Robert Brown*, vol. i., p. 583.

shows a structure similar to that of *Lepidodendron Harcourtii*,¹ and though there is no direct indication of the source of the cone, comparison of the structure with that of *Lepidodendron* stems, and with other Lepidodendroid cones, leaves no doubt of its being the strobilus of a *Lepidodendron*. The axis bears numerous sporophylls, of which thirteen are usually represented in each transverse section: the basal region of each extends horizontally from the axis, and supports the sporangium, which may extend for fully half an inch along its surface (Fig. 168). The distal end of the sporophyll turns upwards, without any peltate expansion.

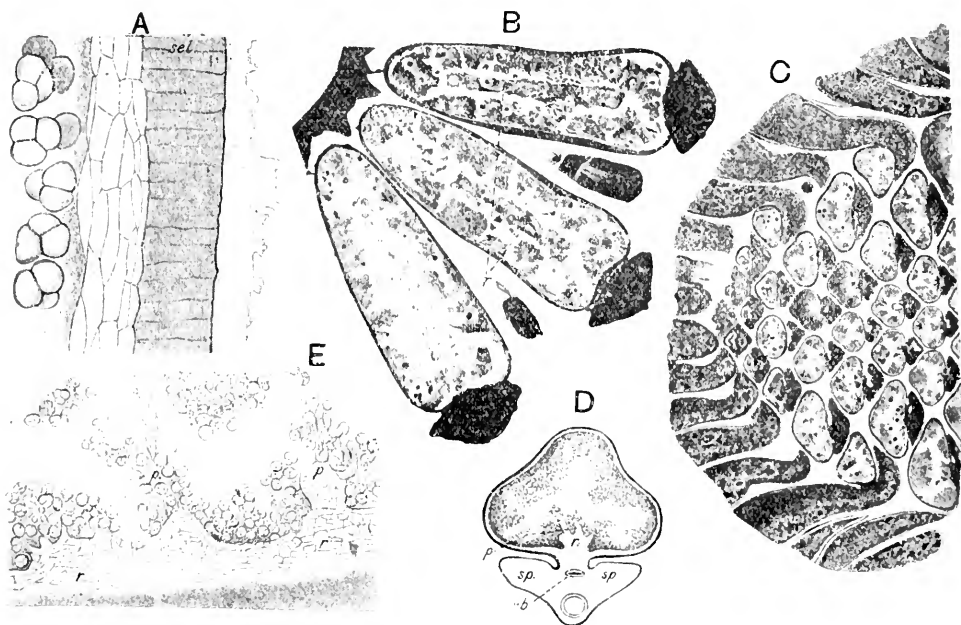

FIG. 169.

Lepidostrobus Brownii. A=wall of sporangium, showing outer sclerotic cells (*sel*), with several thin-walled layers within. $\times 100$. B=three sporangia in transverse section of the cone; *r*=median ridge. $\times 3$. C=cone in tangential section. D=sporangium in tangential section of cone, slightly diagrammatic; *sp*=sporophyll; *r*=sub-archesporial ridge; *v*, *b*=vascular bundle; *p*=processes rising from the ridge. $\times 6$. E=small part of a sporangium in radial section, showing the processes *p*, *p*, which rise from it. $\times 20$.

Comparison of transverse and tangential sections of the cone (Fig. 169 B, C) gives a clear idea of the form of the very large sporangium, which is a radially extended body, broader and deeper at the distal end than at the proximal; it is attached throughout its length by a relatively narrow median, flange-like insertion to the upper surface of the sporophyll, and immediately above the course of its vascular bundle. Comparison of its outline with that of the sporangium of *Isoetes* shows a very striking similarity; but this is not limited to the form only: in *L. Brownii* above

¹Or to that of *L. Williamsoni*, according to Solms Laubach, *Fossil Botany*, Engl. ed., p. 226.

the flange of insertion an internal ridge of sterile tissue extends upwards into the sporangium, just as in *Isoetes* (r. Fig. 169 B, D), while from it sterile processes project further upwards, extending far into the cavity, and traversing the mass of the spores (Fig. 169 E). In the mature sporangium they stop short of the upper sporangial wall, but in the young state—as seen in the arrested sporangia towards the apex of the cone—they may extend completely across the cavity: in position and in number they are irregular, as are the trabeculae of *Isoetes*, to which they show a striking similarity. It seems probable that they are truly comparable to the trabeculae of *Isoetes*; but, on the other hand, it is possible that they may correspond rather to those irregular upgrowths from the sub-archesporial tissue mentioned as occurring in some of the larger sporangia of *Lycopodium*. The large cavities of the sporangia are filled with small spores, arranged in tetrads, and it is probable that the trabeculae were of importance in the nourishment of the large sporogenous mass, as also mechanically. The wall of the sporangium in *L. Brownii* consists of an outer layer of indurated prismatic cells, supported by four or more layers of thin-walled cells (Fig. 169 A). It is impossible to miss the general similarity of this large sporangium to the microsporangium of *Isoetes*: the size, the position, the outline, and the presence of trabeculae all point to the close correspondence: a ligule has, it is true, not been noted in the fossil; but as only a few sections have been available, and as the ligule in other *Lepidodendrons* is only small, it would be rash to lay any great stress upon this negative observation. The points of similarity of this remarkable fossil to the fertile plant of *Isoetes* are such as can hardly have been the result of parallel development: they strongly support the view expressed above, that the plant of *Isoetes* is like a stunted *Lepidodendron*.

On the other hand, Brown's cone shows only microsporangia, while *Isoetes*, like certain other *Lepidostrobi*, is heterosporous. But the specimen itself was incomplete: only the upper part of the cone is represented, and it is now known that in other species the apical region bore microsporangia, while the lower bore megasporangia, as in *L. Veltheimianus* (Fig. 170): it is quite possible that the lower portion, which is missing from Brown's cone, bore megasporangia; but on this point there is no positive evidence.

In other *Lepidostrobi* the general form of the sporangium is the same as that above described: there is great radial extension, while in a number of cases a ligule has been found at the distal end, thus corresponding in position to that in *Isoetes*. The sporophylls are liable to peltate expansion at the apex: they are then so disposed that the downward-turned lips of the upper sporophylls are enveloped by the upturned lips of the lower, thus giving very complete protection to the sporangia. This may be held to be a secondary adaptation of their form, comparable to that seen in some of the more specialised cones of *Lycopodium* belonging to the

sub-genus *Rhopalostachya*, while in the simpler *Selago*-forms the sporophylls are as in *L. Brownii*, or, better still, in *Pinakodendron*. The wall of the mature sporangium is frequently represented by the single prismatic outer layer alone, the inner thin-walled layers seen in *L. Brownii* being absent: this difference is comparable to that seen in *Lycopodium*, where the mature wall usually consists of a single layer, but in *L. dichotomum* of several layers. There is also some divergence in detail of the internal upgrowths from the basal ridge: in most *Lepidostrobi* these take the form of longitudinally disposed plates, of which one or more project upwards into the sporangial cavity. Lastly, there is the fact of heterospory, which has now been established in a number of examples, though it must not be assumed for them all without actual demonstration. Such differences as those mentioned are, however, of secondary importance, and in the general morphological character of the Lepidodendroid cones there is substantial uniformity as regards the relation of sporophyll and sporangium, as well as in their form.

The fructifications of *Sigillaria* appear as cones sometimes sessile, but more commonly borne on long lateral branches, which are covered below with acicular

bracts: such strobili are thus more strongly differentiated from the vegetative axes than is the case in *Lepidodendron*. The plan of construction of the cone itself appears to have been the same, and though its preservation is commonly imperfect, it seems that the sporangia of *Sigillaria* resembled those of *Lepidodendron* in their form and mode of insertion, as also in the existence in them of a heterosporous condition. They were sometimes of large dimensions: frequently, however, of smaller size. Among them a small cone, described by Zeiller as *Sigillariostrobus Crepini*, differs from

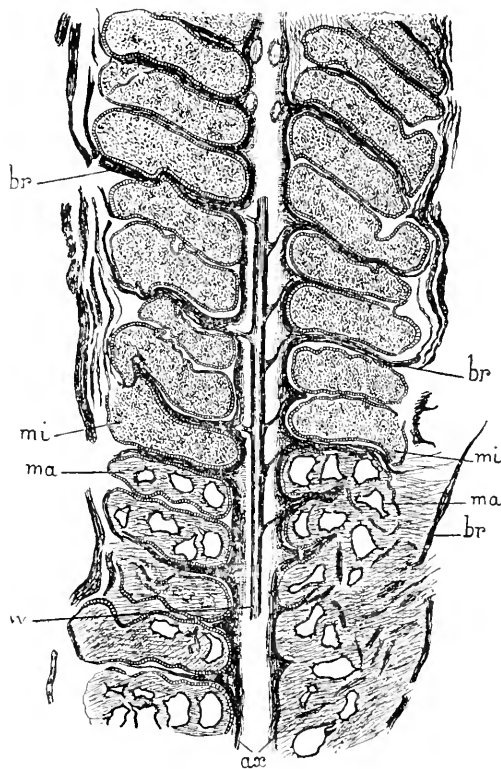

FIG. 170.

Lepidostrobus Veltheimianus. Longitudinal section of cone, showing microsporangia above and megasporangia below. *ax*=axis of cone, showing stele, *ze*, and leaf-traces, passing out to sporophylls. *br*; *mi*=microsporangia; *ma*=megasporangia containing a few spinose megasporangia. \times about 4. (From Scott's *Studies in Fossil Botany*.)

the rest in the distal insertion of the sporangium upon the sporophyll, corresponding in this respect to *Spencerites*.

Taking a general view of the fructifications of the Lycopodiales, the most salient feature is the constancy of the numerical relation of sporangium to sporophyll. In the whole phylum of the Lycopodiales each sporangium is subtended by its sporophyll, while the median planes of both those parts coincide. In most cases the sporangium is in close proximity to the axis, or it may even be inserted upon it: occasionally its position is further removed from the axis and inserted towards the distal end of the sporophyll: these differences are of secondary importance so long as the median position is regularly preserved. It is to be noted that such extreme conservatism in number and in place of the sporangia is peculiar to this phylum of Vascular Plants, in which also the closest relation exists between the sporangia and the axis: in all other types the sporangia show not only a less close relation to the axis, but also less definiteness in number and in position: there is often, indeed, some rough proportion between the size of the appendages and the number of the sporangia which they bear.

The type of the sporangium itself is constant, though liable to differences in proportion: it is always more or less fan-shaped in tangential section, but the angle of spread of the fan is liable to considerable variation. It is, however, in the extension radially outwards from the axis that the greatest differences of proportion are seen, and it has been shown above that in the living species of *Lycopodium* the differences may be correlated with the degrees of differentiation of the strobilus from the vegetative region; the narrow compressed form of sporangium with relatively thin stalk is found in the less differentiated, the sporangium more radially extended with short thick stalk in those with more clearly differentiated strobili. The extremes of radial extension are seen in the dendroid fossils, as well as in *Isoetes*. It would seem probable, as suggested by the comparative study of the living species of *Lycopodium*, that the larger sporangia are derivative types, and that the enlargement was consequent upon increased facilities of nutrition: such increased facilities are afforded by the large size of the assimilating leaves in *Isoetes*; but in the more differentiated species of *Lycopodium*, and in still higher degree in the dendroid fossils, by the extensive vegetative system which precedes the production of cones. The abortion of sporangia, and consequent reduction of their number in proportion to the foliage leaves, would tend in the same direction. Such circumstances would encourage enlargement of the spore-output, which is most readily and directly secured by increase in size of the individual sporangium in so hide-bound a type as that of the Lycopodiales. The extreme enlargement led to mechanical and nutritive difficulties, which were met, perhaps independently, in *Isoetes* and in some *Lepidodendrons* by the formation of trabeculae: these originated in *Isoetes* by partial sterilisation of sporogenous tissue. But though

there is thus evidence of great fluctuation in size of the sporangia, and though the presence of the sterile trabeculae indicates that the limits of convenience as regards nourishment and mechanical support are approached, still there is no evidence that within the Lycopodinous phylum (as now limited by the exclusion of the Psilotaceae) any actual septation has occurred. The relation of one sporangium to each sporophyll, and no more, is maintained throughout with some rare exceptions, which as they never became characters of a race may be held as abnormalities. There is, moreover, no evidence of interpolation of sporangia, those which exist are all found to arise in strictly acropetal order.

Finally, it would seem probable that the heterosporous condition, where it occurs, supervened after the individual sporangia had already acquired approximately the dimensions and characteristics seen in the different types in which it appears.

CHAPTER XXV.

COMPARATIVE ANATOMY OF THE LYCOPODIALES.

It has been already noted that the Lycopods are marked off from other Vascular Plants by the simple and regular arrangement of their sporangia in relation to the other parts of the shoot: also that the characters of the shoot themselves suggest in their simple form and arrangement a primitive state. The Lycopods are no less notable for their anatomical characters, and especially those of the Vascular System. They stand apart from almost all other Vascular Plants in the presence in their mature axes of a stele having peripheral protoxylem, and often showing the solid xylem-core characteristic of the protosteles. The leaf-traces insert themselves with the minimum of local disturbance upon the periphery of the columnar stele, which is further shown by its development to be cauline (compare Fig. 67, p. 125). Exceptions from this simple vascular construction occur within the phylum: but a comparative examination of the various forms will show that the non-medullated monostele may be accepted as a central type of construction for them all, upon which certain modifications and variants have arisen: some of these are exemplified in the fossils, some in plants now living. The comparisons will be primarily based upon the structure of the mature shoot. The same order will be maintained as in the description of the external morphology, and it will be found that the anatomical complexity follows, with some degree of exactness, that of the external form.

Taking, therefore, first the less differentiated *Selago* section of the genus *Lycopodium*, as seen in *L. Selago*, *serratum*, or *lucidulum*, the cylindrical stele is there found to consist of a connected central mass of xylem of irregularly star-like form: the rays of the star vary in number in different species, as well as in different regions of the same plant, and are specially characterised by the form of the periphery of the rays: these expand outwards into a wide-spread, almost fan-like outline, as seen in the transverse section (Fig. 171 c). Small tracheides forming the protoxylem lie at the extreme periphery, while the centrally-disposed metaxylem is composed

of larger elements without any parenchyma interspersed between them. The spaces between the xylem-rays are occupied by the sieve-tubes, with the protophloem lying at the periphery, while conjunctive parenchyma forms a complete sheath intervening between the phloem and the xylem. The whole is invested by a parenchymatous sheath resembling a pericycle, but derived, according to Strasburger,¹ from the cortex: outside this is the endodermis, recognisable while young as a single layer, but later obscured by extension of the corky development. A very similar structure to the above is seen also in the thinner branches of *L. inundatum*, a species, which as we have seen above, stands in its external morphology in near relation to the section *Selago*. These species may be taken as representing the structure usually found in the simpler upright, ground-growing members of the genus.

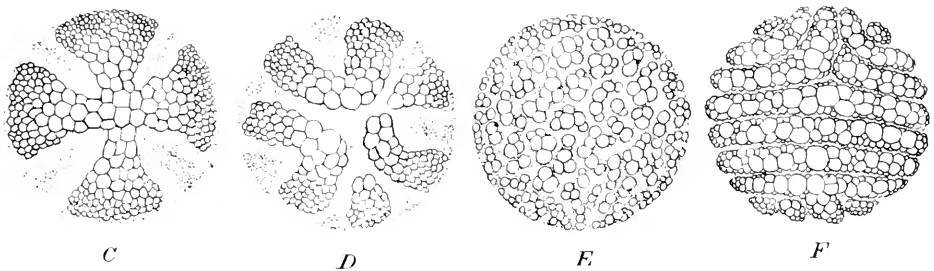

FIG. 171.

Diagrammatic transverse sections of the stele of various species of *Lycopodium*: the phloem is dotted, the xylem drawn as tracheides. *C*=*Lyc. serotum*, Thbg., with stellate arrangement. *D*=upright stem of *L. annotinum*, L., with somewhat stellate arrangement. *E*=*L. cerinum*, L., with uniform distribution of the small groups. *F*=*L. volatile*, Forst., with strongly bilateral structure. $\times 80$. (From Engler and Prantl.)

But a more elaborate construction of the stele is found to accompany the greater differentiation of external form. In creeping and climbing stems there is apt to be an increase in the number of the protoxylems, accompanied by a development of alternating bands of xylem and phloem: the xylem becomes isolated into distinct masses as seen in the transverse section, and these are roughly disposed parallel to the surface of the substratum (Fig. 171 *F*). In other cases, and especially in the epiphytes, the xylem and phloem are more uniformly distributed, the former as patches embedded in the latter, as seen in transverse section (Fig. 171 *E*). Both these conditions may be connected by intermediate steps with the simpler type seen in *L. Selago*, and as they occur in plants with more specialised form and habit, it may be concluded with some degree of certainty that the type with a connected xylem-tract shows the more primitive state.

It would seem hardly necessary to insist on this rather obvious outcome of comparison within the genus *Lycopodium*, were it not that a certain misconception, which dates back to the Text-book of Sachs, still survives

¹ *Leitungsbahnen*, p. 460.

as to the nature and origin of the more complicated steles of *Lycopodium*. Comparison of these with polystelic stems of *Selaginella* long ago suggested that the former structure was derived phylogenetically from the latter, by the lateral fusion of several distinct steles; and thus that the stele of *Lycopodium* is in reality a compound one.¹ But the polystelic condition seen in some *Selaginellas* is not uniform for that genus, as we shall see below: moreover it seems improbable that the simpler, homosporous *Lycopodium* should show structural derivation from the heterosporous *Selaginella*, while it is only in the more complicated *Selaginellas* that the polystelic condition appears: again, the species of *Lycopodium* which show distinct xylem-plates are in our view morphologically more advanced than those with the xylem more closely connected. Such considerations go far to negative any idea of the more complex steles of *Lycopodium*, being compound in their origin. Comparison within the genus is usually a safer guide in such questions than more far-fetched references; and in the present case it suggests a different explanation, which is as follows: that, in a primitively protostelic Lycopod-stock with cylindrical solid xylem, the phloem became progressively intrusive as the morphological differentiation of the plant increased: at first it appeared in the transverse section as occupying a few narrow involutions of the margin of the still connected xylem, this then showing the stellate outline, with fan-like peripheral arms, as seen in the *Selago* type. But in others the number of the involutions and their depth became greater, till the coherence of the xylem-tract as seen in the single transverse section became interrupted, and the appearance of more or less isolated plates with narrow peripheral edges was attained, as in *L. clavatum*. The origin of the xylem-islands as seen in *L. squarrosum* or *L. cernuum* was substantially the same, the difference being that they are not merely intrusive from the margin, but the xylem-tracts are actually for some distance occluded in the phloem. In point of fact these two types of more complicated derivative structure are not strongly differentiated from one another. Thus, from comparison within the genus, it may be figured how from the condition of a primitive protostele with phloem about its periphery the Lycopod-stele became in the more advanced cases a sort of xylem-sponge, with phloem and conjunctive parenchyma occupying the interstices. It will be seen later that the simple protostelic state without intrusive phloem is represented among the fossil Lycopods.

The relation of the leaves to the central stele in *Lycopodium* is interesting, both in respect to the young and to the mature condition. If the apex of the shoot be investigated, the plerome-cylinder is seen to extend beyond the youngest leaves, to a point immediately below the apical group of cells; and thus the central region of the stele is cauline in its origin (Fig. 172). The leaves originate from the three or four outer layers of cells of the growing point, quite apart from the plerome, while procambium-

¹This is specifically stated in Strasburger's *Leitungsbahnen*, p. 458, and the view has been retained in his Text-book, in the German edition of 1906.

strands become differentiated in the intervening tissue, which form a connection with the central cylinder: upon this they are inserted laterally. It is thus clear that in the ontogeny of the shoot the leaf is an accessory which arises after the stele is already in existence. Its relative unimportance is not only apparent from this late origin, but also from the fact that the arrangement of the leaves upon the shoot does not dominate the number or position of the protoxylem-groups of the stele. It has long been known that the number of the xylem-rays is independent of the position of the leaves. In *L. clavatum* Jones has found that though in shoots with simple leaf-arrangement it is usual for the protoxylems to correspond to the leaf-insertions, still, where the number of protoxylems is beyond six, there is no apparent relation between them and the leaf-insertions.¹

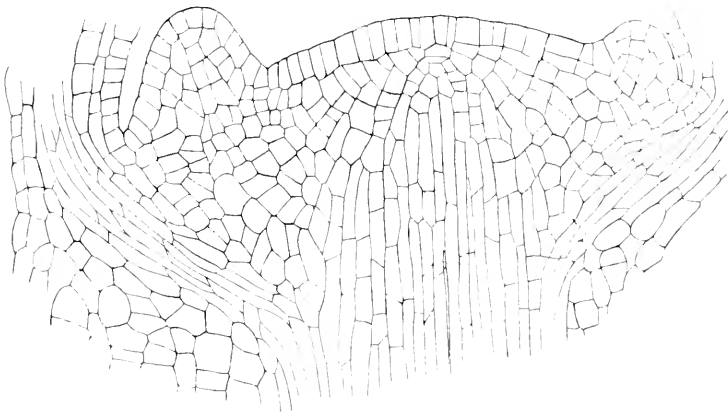

FIG. 172.

Longitudinal section through the apical cone of the stem of *Lycopodium Selago*. $\times 160$.
(After Strasburger.)

When the above facts are taken together, it is apparent that the leaf in *Lycopodium* is but an accessory appendage, and that the axis is the dominant feature of the shoot. This conclusion probably applies for Lycopods at large, and it has its important bearing on the relation of leaf to axis, discussed in Chapter XI.

Hitherto no definite knowledge of the anatomy of the smaller fossil eligulate Lycopods included under the name *Lycopodites* has come to hand: whenever such facts are available they will provide interesting material for comparison with the modern species of *Lycopodium*. The ligulate and heterosporous forms would be equally important for comparison with *Selaginella*.

The discussion of the external morphology of the latter genus has led to the recognition of the radial type as relatively primitive, while those species with dorsiventral shoots are held to be more specialised and

¹ *Linn. Trans.*, 2nd series, vol. vii., p. 19.

derivative. Of the former *S. spinulosa*, A. Br., is the best known, and it will be seen that its vascular anatomy, which differs from that of all other *Selaginellas*, shows points of interesting comparison on the one hand with *Lycopodium*, and on the other with the dendroid Club-Mosses. The hypocotyl, and the lower parts of the axis, with its branches, are traversed by a cylindrical stele, which is peculiar in having a central

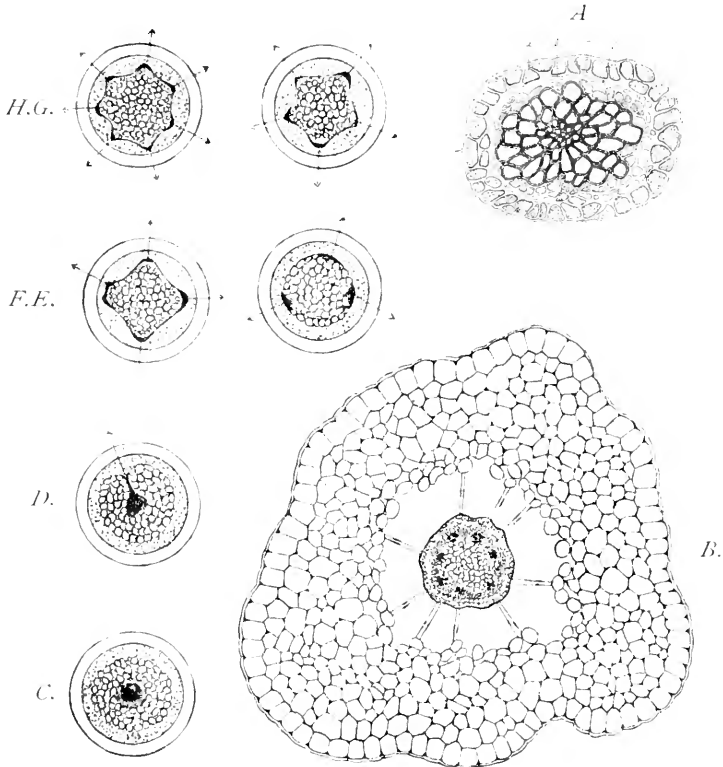

FIG. 173.

Selaginella spinulosa. A. Transverse section of the trailing stem showing central protoxylem. *a*=pericycle; *b*=protophloem; *c*=phloem parenchyma; *d*=metaxylem. $\times 275$. B=transverse section of upper part of axis, showing seven protoxylems. $\times 350$. C-G=scheme of arrangement of the protoxylems in sections taken successively from below upwards. (After Harvey-Gibson.)

strand of protoxylem surrounded by metaxylem: this is further invested by a narrow band of phloem surrounded peripherally by a sheath resembling a pericycle, and by the trabecular endodermis so characteristic of *Selaginella* (Fig. 173): according to Strasburger both of the latter layers are derived from the cortex, as they are also in *Lycopodium*.¹ In passing upwards in the strobilus the stele loses its peculiarity of having a central protoxylem: for the strand divides, and the branches diverge outwards to the periphery of the wood, where they appear in

¹ *Leitungsbahnen*, p. 458.

number from three to eight, as slightly projecting groups of small spiral tracheides. The condition thus attained is very similar to that seen in the simpler types of *Lycopodium*: or a better comparison may perhaps

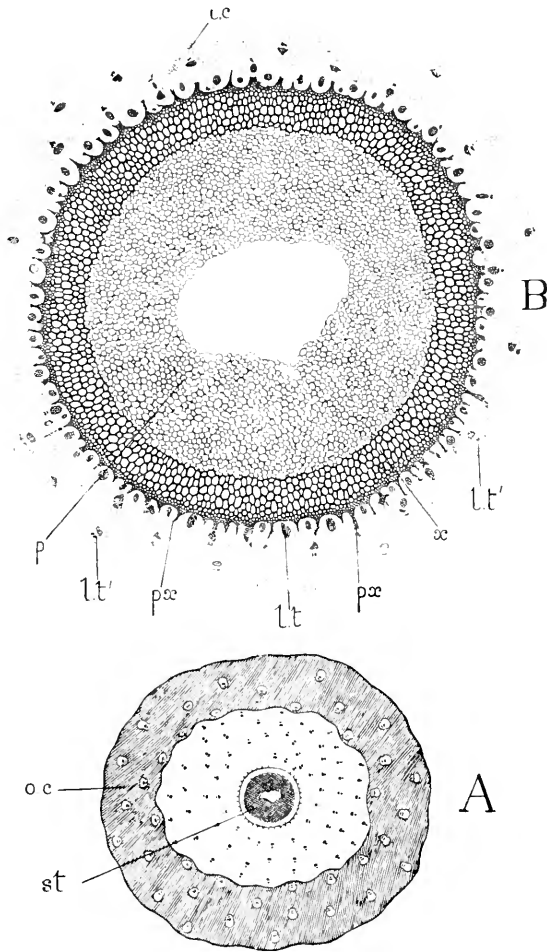

FIG. 174.

Lepidodendron Harcourtii. *A* = transverse section of stem; *st* = stele; *oc* = outer cortex; both here and in the outer cortex the leaf-traces are shown about natural size. *B* = stele of same; *p* = pith, hollow in the middle; *r* = xylem-ring; *pα* = protoxylem-points. The leaf-traces join the stele between them; *lt* = leaf-trace bundles, of which the outer, *lt'*, show xylem and phloem; *lc* = inner cortex. $\times 7$. (From Scott's *Studies in Fossil Botany*.)

be drawn with certain stems of *Lepidodendron*. The presence of central and peripheral protoxylem in different parts of the same shoot should be a warning against too great reliance upon such characters: it may, perhaps, indicate that the central position was the more primitive, as is believed by some on general comparative grounds. At the same time it is of

interest for comparison with the *Lepidodendroid* fossils, in which a peripheral protoxylem is found in the shoot, while a central protoxylem, adjoining the medulla, is found in the *Stigmarian* trunks.

Other species of *Selaginella* show further elaboration along distinct lines. The simpler dorsiventral species, and even such radial species as *S. rupestris* and *oregana*, show ribbon-like steles with marginal protoxylems, upon which the leaf-traces are inserted. In the more complex cases the axis becomes polystelic (*S. inaequalifolia* and *Willdonovii*), or in some cases solenostelic (rhizome of *S. laevigata*), thus resembling similar vascular complications seen in the stems of Ferns. These may be held to be relatively late, and special developments from the non-medullated, monostelic type: their origin shows parallelism of development rather than any nearer relation with the similar structure seen in the Ferns.

The near correspondence of the ancient *Lepidodendron*-type to that of the modern Lycopodiales appears not only in their external form, but also in their internal structure, though special modifications of type, different from those of the modern forms, appear in accordance with the larger dimensions so prevalent in the fossils. The similarity consists in the presence of a single cylindrical stele, with a centripetal wood, and peripheral protoxylem, in relation to which the leaf-traces are inserted with the minimum of local disturbance.

The general structure of one of the more simple types may be gathered from Scott's figure of *Lepidodendron Harcourtii* (Fig. 174), which shows (A) the relatively small proportion of the stele to the whole axis: (B) the peripheral protoxylem, with its relation to the incoming leaf-traces, and the uninterrupted metaxylem, not separated into strands: while centrally a large pith is seen hollow in the middle. The steles of *Lepidodendron* varied in structure towards the centre: in some cases such as the very ancient *Lepidodendron rhodumnense*, Renault, and *Lepidodendron saalfeldense*, Solms, from the Culm, there was a solid stele, without secondary thickening; or, as in *Lepidodendron Petticurensis*, Kidston (*Roy. Soc. Edin. Proc.*, 1906-7, p. 207), the solid xylem-core was surrounded by secondary wood. But often, and especially in more recent forms, the xylem was medullated, and in this they differ from modern Lycopods. It is obvious in some cases that the pith originated by incomplete development of tissue originally tracheidal: this is clearly indicated in Fig. 175. This drawing also shows that outside the xylem came a narrow band, probably of phloem, which is usually ill preserved, while in some cases there is evidence of an endodermis, as in the present case. Thus, putting aside the larger size, and the medullation which is its frequent concomitant, there is substantial similarity in the structure of the stele to that of a simple *Lycopodium*, or of *Selaginella spinulosa* at its distal region.

A more striking concomitant of the larger growth was, however, the secondary thickening represented in the majority of the known species of *Lepidodendron*, though absent from some of the earliest. It was carried

out by two distinct zones of cambial activity, the one immediately surrounding the primary xylem, and resulting in a band of radially seriated secondary wood, contiguous usually with the protoxylem of the primary development. Externally an exiguous secondary phloem appears (Fig. 176). Outside the thickening ring of the stele a second zone of cambial activity arises in the cortex, below the persistent bases of the leaves: this results in the formation of a broad band of secondary cortical tissue, or periderm.

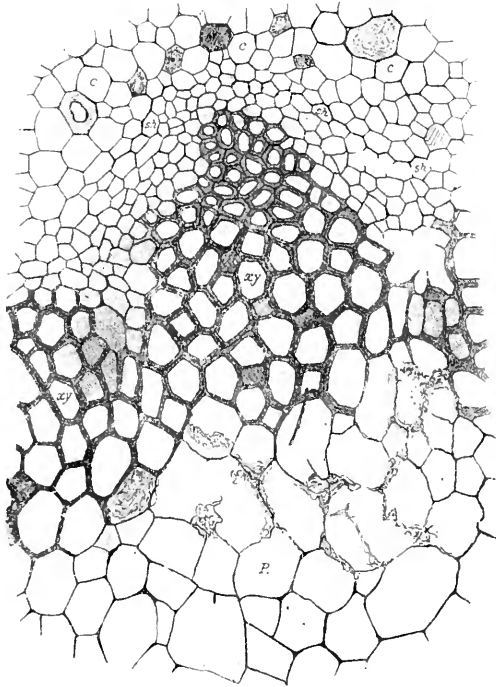

FIG. 175.

Lepidostrobus Brownii. Part of a transverse section showing the central parenchymatous pith (β), the wood (xy), the innermost band of cortex (c), the endodermis (e) (sh).
X 200.

Such secondary activity extended from the main trunk into the branches, and in some cases into those of quite moderate dimensions. Comparison of the various known types of *Lepidodendron* suggest unmistakably that even the most elaborate are the result of expansion of a non-medullated monostelic construction, to serve dendroid purposes. A first step, following on the increasing size of the stele, would be the formation of a parenchymatous pith: this probably originated directly, by the incomplete development of a primitively solid tracheidal core, as is suggested in the case of *L. Brownii*: and in support of this it is found that tracheides and parenchymatous cells may be intermixed in the central region, a condition held to represent an imperfectly formed pith: it is seen in

L. selaginoides. It would seem probable that the non-medullated condition, so persistently maintained in the smaller living Lycopods, was the primitive state also for the larger dendroid fossils. The other factor of expansion, by cambial activity, appears to have originated independently of medullation, since it occurs both in medullated and in non-medullated axes. Physiologically it counterbalanced medullation where both occur together, for it

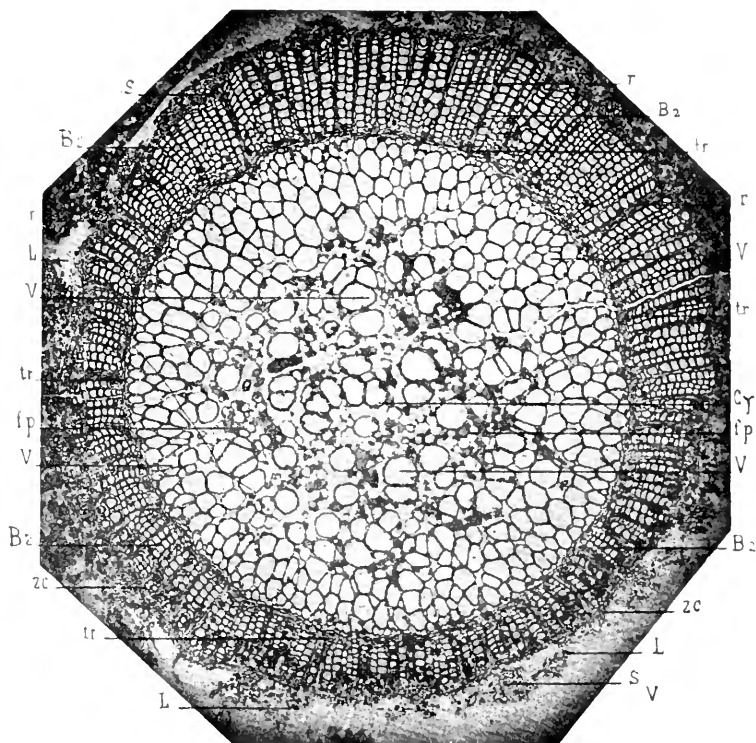

FIG. 176.

Transverse section of an axis of *Lepidodendron selaginoides*. *Cy*=centre of the vascular system; *tr*=tracheae; *V*=vessels of the primary cylinder; *fp*=primitive fibres of the primary wood; *B₂*=tracheids of the secondary wood; *r*=ray of the secondary wood; *B₂*=secondary parenchyma; *zc*=cambial zone; *L*=liber; *s*=foliar traces detached from the primary cylinder. (After Hovelacque.)

substituted an enlarging peripheral vascular supply for the reduction in efficiency in the limited central system. This was indeed a necessary condition for dendroid development.

However large the proportion of pith to the primary wood became in *Lepidodendron*, the continuity of the ring was as a rule unbroken, and the leaf-traces were simply inserted upon the primary xylem with the minimum of local disturbance. But in *Sigillaria*, in which the leaves sometimes attained a very large size, the case is different: though they show in all

essentials the same construction of the stele as in *Lepidodendron*, they illustrate steps towards the breaking up of the primary wood of the medullated stele into separate bundles. The details derived from various Sigillarian fossils have lately been put together in stratigraphical sequence by Kidston,¹ and his conclusion has already been quoted above (Chapter XVIII., p. 230): he has shown a strong support for the view that the condition with primary xylem forming a closed ring surrounding the large medulla was the most primitive for *Sigillaria*: such a structure is found in the more ancient specimens from the Lower Coal Measures (*S. elongata*, Brongn., and *S. elegans*, Brongn.): those from the lower Permian, however, (*S. menardi*, Brongn., and *S. spinulosa*, Rost. sp.) show the primary xylem as a circle of separate bundles, though some of them may cohere laterally in the last-named species. This indicates an evolutionary progression from a concrete primary xylem to a condition where it is separated into strands. In such forms the pith, being of relatively very large size, the primary wood is reduced to a comparatively narrow investment round it, liable as we have seen to be broken up into distinct strands. The secondary tissues make their appearance, however, as in *Lepidodendron*; there being in *Sigillaria* a broad zone of secondary xylem, and a highly organised periderm. It is thus seen that the later *Sigillarias* have departed further in their structure from the simple protosteles than other dendroid Lycopods, for they show not only medullation, and a secondary thickening, but breaking up of the primary xylem as well.

It has been concluded above, on the basis of external comparison, that the plant of *Isoetes* is like a partially differentiated *Lepidostrobus* seated upon a *Lepidodendroid* base. The question will now be how far its anatomy will countenance such an opinion. There has been some confusion in the descriptions given by various investigators, owing doubtless to the difficulty in decyphering a complex mass of tissues affected by the reduction which follows on an aquatic habit. But this has been in great measure cleared by Scott and Hill in their Memoir on *Isoetes lystrix*, one of the few land-growing species.² Nevertheless the terrestrial habit of this plant does not greatly affect its structure as compared with other species, a circumstance which is held to point to the conclusion that *Isoetes* is a genus which has long hovered about the limits of terrestrial and aquatic life. The statement here given is based upon the Memoir of Scott and Hill.

The stele of the mature plant is not composed merely of the united leaf-traces, but is best interpreted as a cauline structure, comparable to that of the simpler monostelic Lycopods, but much shorter than is usual in them. The crowded leaf-traces are inserted upon it, the stelar wood serving to join up the xylem of the leaf-traces, but it does not belong to one trace more than another, and in structure it differs from them. The

¹ *Trans. Roy. Soc., Edin.*, vol. xvi., Part iii., No. 23.

² *Ann. of Bot.*, vol. xiv., 1900, p. 413.

differentiation of the primary wood is nearly simultaneous over its whole area, but with indications of centripetal succession. The cambial activity starts early, being continuous from that of the primary meristem. As a rule the same cambium is active throughout, producing secondary ground tissue, wood, and phloem on its inner side, and cortical parenchyma only towards its exterior; but other arrangements are found, while in some cases a second cambial activity may arise inside or without the first. The adjoining diagram, quoted from Scott and Hill (Fig. 177), shows the relation of the primary and secondary tissues usual in *I. hystrix*, and it will be noted that the secondary phloem is internal to the secondary xylem; the cambium lies outside the latter in direct contiguity with the

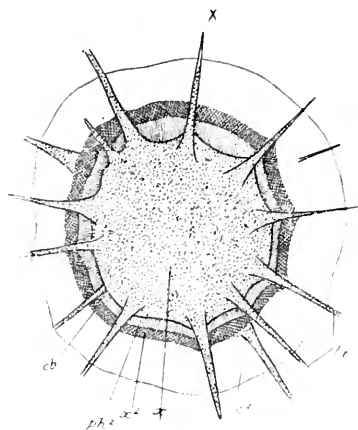

FIG. 177.

Diagrammatic transverse section of the upper cylindrical part of the stele of *Isoetes hystrix*. x = primary wood; ph^2 = region in which secondary phloem has developed; x^2 , that in which secondary xylem has developed; cb = cambium; ca = secondary cortex; lt = leaf-traces. $\times 42$. (After Scott and Hill.)

secondary cortex, which arises externally from it. The stele which is cylindrical above becomes in *I. hystrix* triquetrous below, in *I. lacustris* it is usually flattened bilaterally: the change of form is a secondary consequence of the abutment of the numerous, successively formed root-bases upon it, and does not affect the general comparisons. Scott and Hill conclude that the anatomy of the stem with its solid stele, from which the densely crowded small and simple leaf-traces pass off, is just what might be expected in a stunted Lycopod, while the anomalous character of the secondary thickening in *Isoetes* agrees in some measure with that in certain fossil Lycopods. Scott¹ has remarked on the stem of *Lepidodendron fuliginosum* as having an anomalous cambium producing a

good deal of secondary parenchyma, among which there are scattered groups of wood; and he regards this species as exhibiting a primitive and rudimentary form of secondary growth. It seems to offer a distinct analogy with *Isoetes*. On the other hand, the slight cambial increase discovered in *Selaginella spinulosa* by Bruchmann affords some link as regards secondary thickening, though a feeble one, with a living Lycopod. The general result of this anatomical examination and comparison of *Isoetes* is accordingly to strengthen its position among the Lycopodiales, and to show that its primary vascular arrangement corresponds in essentials to the type as exemplified in living species of *Lycopodium*, but much abbreviated, and with the xylem reduced in accordance with the aquatic or amphibious habit prevalent in the genus. It also appears that the secondary development, though showing fluctuating

¹Studies, p. 143.

anomalies, finds its nearest parallel in certain fossils belonging to the Lycopodiales.

It may thus be concluded from comparative examination of all the leading types of the Lycopodiales that the vascular structure of the mature shoot is referable in origin in all cases to the non-medullated monostele. This is actually seen existent in the stems of *Selaginella spinulosa*, though in its lower portion the protoxylem is central; but it is also shown more amply developed, and with the protoxylem in the accustomed position at the periphery in the upper region of that plant, as well as in certain stems of *Lepidodendron*. Comparative study of the Lycopodiales shows that all the variants of vascular structure known in them may be referred in origin to this simple type. In *Lycopodium* the modification has been by intrusion of the phloem more or less deeply into the xylem-core, till this may at last be divided into distinct plates, or riddled like a sponge. In *Selaginella* there is amplification in various ways, the most obvious being by the adoption of a solenostelic structure, or more commonly by segregation of the enlarging stele to form a varying number of meristemes. Among the dendroid fossils, where the demands on the conducting system were large in consequence of the large size of the plants, the extended stele became first medullated, as seen in most stems of *Lepidodendron*: and then in the later *Sigillarias* the residual ring of xylem became broken up into more or less distinct strands. In these types additional vascular tissue was supplied by the potentially unlimited developments from an external cambium. Finally, in *Isoetes* a complicated structure, partly primary, partly secondary, is found, which would be hardly intelligible except when studied in the light of the dendroid fossils; but even this, in common with the rest, is referable in origin to the non-medullated monostelic type, together with the results of secondary thickening. The bearing which this constant reference to a primitive monostele has upon a strobiloid theory is plain: as is also the fact that throughout the Lycopodiales the foliar traces are inserted peripherally, and with only slight local disturbance upon the periphery of the cauline xylem-core: for this indicates structurally that the leaf is in them all the minor, while the axis is the dominant feature of the shoot.

Scott and Hill rightly point out that the view of the central cylinder as cauline applies only to the adult stem of *Isoetes*: in embryonic stages the construction of the vascular system is from the union of definite leaf-traces: this is the case also in the embryonic stages of certain other Lycopods. The question of the relation of these facts to a theory of the strobilus will be taken up in connection with the embryology of the Lycopods, which forms the subject of the next chapter.

CHAPTER XXVI.

EMBRYOLOGY OF THE LYCOPODIALES.

(A) ELIGULATE LYCOPODIALES.

IN Chapter XIV. the modern aspect of comparative embryology of the sporophyte has been discussed. For reasons there stated it was concluded that only a minor place in comparisons is to be conceded to the details of the initial embryology of the sporophyte: the characteristic form of the mature plant, established after the earlier and in considerable degree adaptive phase of development is past, is held to give a more reliable basis for argument than does the embryonic state. Especially is this the case among the Pteridophyta, and it happens that the Lycopods supply examples of peculiar interest in relation to such questions; they will serve at once as an illustration, and as a test of the principle thus briefly stated. For in the general conformation of their mature sporophyte there is a remarkable uniformity throughout the whole phylum: the differences are those of secondary detail: the main facts of plan and proportion of their shoot- and root-systems, of their branching, and of the relation of the sporangia to the other parts, leave no doubt of a natural affinity as based on the character of the mature sporophyte. But in the embryology there are points of marked divergence, which may be more or less clearly correlated with differences of character of the parent prothallus. There is reason to think that within the genus *Lycopodium* the prothallus and embryo have undergone a cognate divergent development from a central type, though the mature sporophyte has still retained a substantial uniformity.

The differences in character of the prothallus within the genus *Lycopodium* are found to be those of habit and of mode of nutrition rather than of fundamental structure. According to their mode of life three main types may be distinguished, which, however, graduate into one another in such a way as to suggest their intimate connection by descent from some common source. The type shown by *L. cernuum*, and shared also by *L. inundatum* and *salakense*, consists of a massive cylindrical thallus, of which the conical lower part is sunk in the soil, while the upper part is

exposed freely above ground, and is of a green colour: in *L. cernuum* and *inundatum* it bears numerous irregular leaf-like lobes, though in *L. salakense* the lobes are rudimentary or absent (Fig. 178). The prothallus is evidently in the main a self-nourishing body, though an endophytic fungus is almost constantly present, indicating a second but subsidiary line of saprophytic nutrition. As the prothallus grows a merismatic zone is localised surrounding the upper part of the cylindrical body, but below its apex: this contributes to increase both the upper and



FIG. 178.

Young leafy plant of *Lycopodium cernuum*, L., with the prothallus, bearing its irregular assimilating lobes, attached on its left-hand side. \times about 20. (After Treub.)

lower regions, while above it the green expanded lobes are formed. The sexual organs appear between the latter, the youngest being nearest to the merismatic zone.

A second type shows in the ascendant that method of nutrition which was subsidiary in the first: it is exemplified by the large subterranean prothalli of *L. complanatum*, *clavatum*, and *annotinum*: being shut off from light these prothalli are colourless, and the leaf-like lobes are absent. The massive prothallus is composed of a lower region which takes a conical form, the angle of the cone being greater in *L. clavatum* and *annotinum* than in *L. complanatum*: it is in this region, as in *L. cernuum*, that the endophytic fungus is present. The merismatic zone is active as before at its upper limit, and above it is the part which bears the sexual organs, but without any vegetative lobes as in *L. cernuum* (Fig. 179 b). It is clear

that the general plan of construction of the prothallus is the same as in the *L. cernuum*-type, but modified in accordance with the saprophytic method of nutrition.

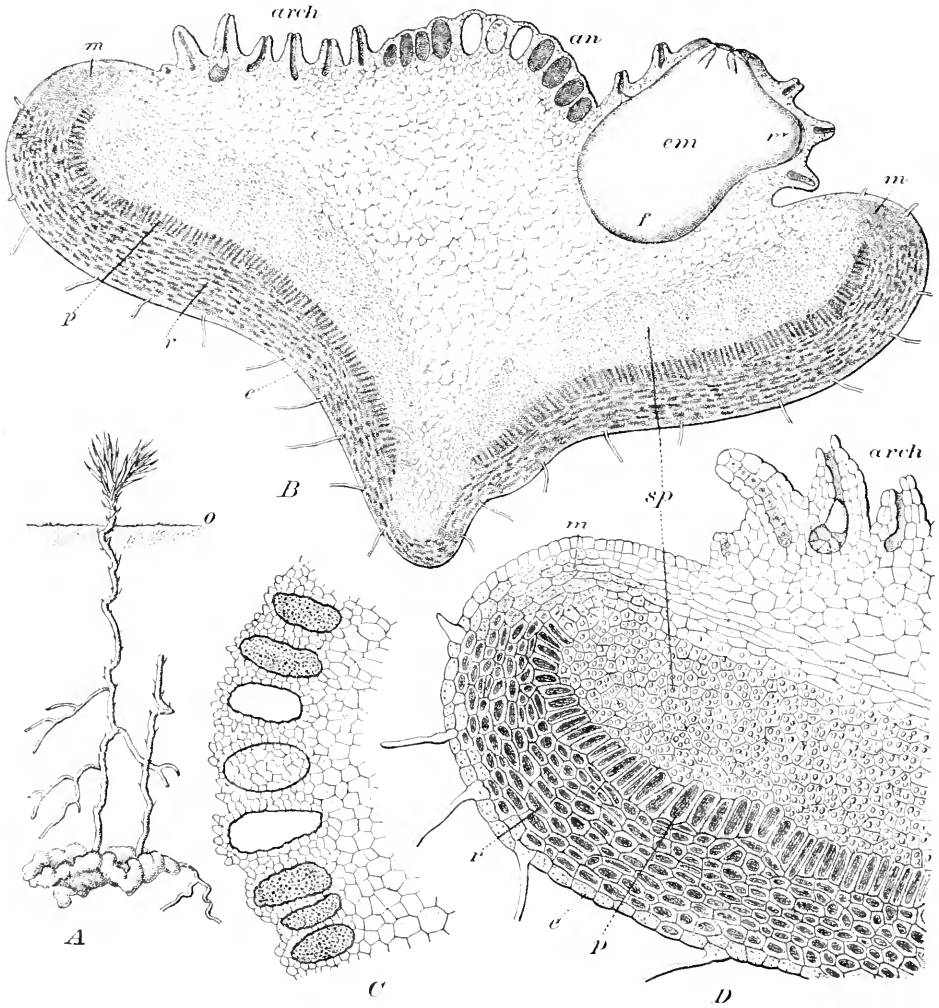

FIG. 170.

A—old prothallus of *Lycopodium annotinum*, L., with young plant projecting beyond the earth-surface (*o*). Natural size. *B*—median section through a young prothallus of *Lycopodium clavatum*, L., about 30. *C*—part of this from the middle region of the upper surface, with antheridia in different stages. $\times 52$. *D*—part of the margin of the median section, with meristem and archegonia. $\times 52$. *e*—the epidermis devoid of fungus, with rhizoids; *r*—cortical layers, with their cells filled with hyphal coils; *p*—the palisade layer, also filled with hyphae; *sp*—the storage tissue; *m*—the meristem; *an*—antheridia; *arch*—archegonia; *em*—an embryo; *f*—its foot; *a*—its root. (After Bruchmann, from Engler and Prantl.)

In the third type, exemplified by *L. phlegmaria* and other epiphytic species, the prothallus is more attenuated, and repeatedly branched. The delicate colourless branches extend widely through the dead bark on

which the prothalli grow, and they are attached by hairs which project in all directions. Here again a fungus plays an important part in the nutrition, which is exclusively saprophytic. The prothalli reproduce readily by gemmae, as also by progressive decay, which separates the ultimate branches as distinct individuals. The sexual organs are borne upon the upper surface of enlarged branches of the thallus, and are always accompanied by paraphyses.

Such different types of prothallus, when studied separately, appear widely divergent: and at first the underlying unity of their construction was less appreciated than the differences which they show; so little indeed that Bruchmann, to whose labours so many of the important facts are due, was disposed to make those differences the basis of a division of the genus *Lycopodium* into distinct groups, or even genera.¹ But Lang, who had simultaneously with him been at work on the prothallus of *L. clavatum*,² pointed out clearly the relation of the divergent types to one general plan, recognising especially how the prothallus of *L. Selago*, one of the species described by Bruchmann, gives the clue to their connection. For its prothallus appears to be variable in its mode of development (Fig. 180). It is usually a pale underground body; but at other times



FIG. 180.

Prothalli of *Lycopodium Selago*, bearing seedlings. *o, o* shows the level of the soil, and the seedlings in their development show varying proportions so that the first leaves shall be exposed above ground. (After Bruchmann.)

it grows above ground, and is coloured a full green. The spores appear to germinate either at the surface or below it. The form of the prothallus is determined largely by the soil in which it develops: thus, the elongated cylindrical form is usually found in firm ground, though less deeply buried than in the *annotinum*-type: the thallus seems, in fact, to stretch upward as though to bring as near to the surface as possible the seedling unsuited for subterranean growth. The subterranean prothalli may be simple, or be branched so as to take a coral-like form. In more open soil, however, and especially near to the surface, the prothalli are more compressed and flattened. Each prothallus tapers off as in the other types at its lower end into a conical point, which indicates where it issued from the spore, while towards its upper end the sexual organs are formed. In the half-saprophytic prothalli, grown to the surface of the soil, the conical form similar to that of other types is clearly seen (Fig. 181): the saprophytic lower region, the meristem, and the crown bearing the sexual organs and paraphyses holding the usual positions.

¹ *Ueber die Prothallien und die Keimpflanzen mehrerer europaischen Lycopodien*, Gotha, 1898, p. 108.

² *Annals of Botany*, xiii., p. 279.

In considering these various prothalli it is then clear that they are all modifications of the same conical form: that the several parts, though differing in proportion, have the same positions relative to one another and to the sexual organs which they bear, while the differences are closely related to the differences of circumstance and of nutrition. There is reason to believe that the full chlorophyll-nutrition was the primitive state for them all, and the saprophytic nutrition, seen in the subterranean or

the epiphytic types, a derivative state. On this basis the *cernuum*-type would be recognised as relatively primitive, while *L. Selago*, being less specialised than the *annotinum* or *phlegmaria*-types, would approach it more nearly than they do. But it does not follow necessarily that a species which is recognised as primitive in respect of one prominent feature, is to be held as primitive in all its features. This applies to *L. cernuum*: it is true that its prothallus is green and assimilating, and in this respect probably primitive; but its sporophyte is a fairly advanced one, with definite strobili, and with peltate chaffy sporophylls strongly differentiated from the assimilating leaves: its axis, too, shows an advanced condition of the stele. Thus in its general characters *L. cernuum* cannot be held as a consistent prototype of the genus. But, on

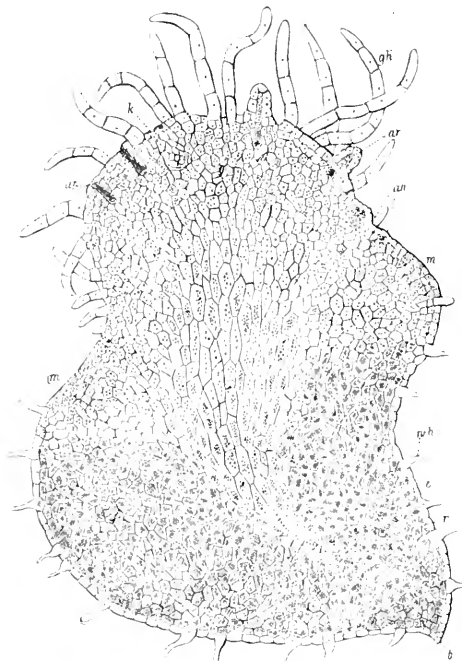

FIG. 131.

Median longitudinal section through a young prothallus of *Lycopodium Selago*. *b*=basal cell; *wh*, root hairs; *c*=epidermis; *r*=the investing tissue, stored with reserve materials, and harbouring an endophyte; *e*=the central; *g*=the generative tissue; *ar*=archegonium; *k*=young embryo; *an*=antheridia beginning to develop; *gh*=sexual hairs. $\times 35$. (After Bruchmann.)

the other hand, *L. Selago* has a prothallus little removed from the condition seen in *L. cernuum*, while in addition the sporophyte of that species has been seen to represent the least differentiated type in the whole genus. On the general sum of its characters it would accordingly take a place as a relatively primitive form. But its prothallus shows distinct plasticity in the directions along which specialisation has extended to produce the more extreme types: on the one hand, its subterranean specimens, with elongated cylindrical form, prefigure the more specialised developments of *L. complanatum* and *annotinum*: the compressed and flattened form

developed in more open soil suggests the origin of the *phlegmaria*-type: while its green sub-aerial forms are reminiscent of the *cernuum*-type. A plant which shows such plasticity is clearly not far removed from the self-nourishing condition of the prothallus, which was probably the primitive condition for them all.

These remarks upon the curiously divergent development of the prothallus in the genus *Lycopodium* are a necessary preliminary to the study of the embryogeny in the genus: for it is impossible to understand the comparisons of the different forms of embryo without some knowledge of the prothalli which produce them. In all the species of *Lycopodium* in which the embryogeny is accurately known, an early stage of the embryo is found in which it consists of a suspensor, and of two tiers, each composed of four cells (Fig. 182). The first cleavages are variable in their succession, as is found to be the case also in other embryos; but their position shows considerable constancy.

It is stated that from the lower tier of cells, *i.e.* that adjoining the suspensor, the structure designated the foot arises, while the upper tier gives origin to all the other parts of the embryo, and the correctness of the statement is borne out by numerous drawings. But after the first stages are past there is usually no sharp limit between the tissue composing the foot and that of the other parts: in the simplest cases it appears as though the foot were merely a region of tissue lying between the suspensor and the upper tier, rather than a definite organ or part. Functionally, the foot does not appear to be differentiated from the suspensor in the genus *Lycopodium*, and it shares with it the office of maintaining connection with the prothallus. Notwithstanding the initial similarity which thus rules in the embryos of the genus, the further steps of the embryogeny differ according to the different forms of prothallus above described; and it becomes a question which of the divergent types is to be held as the most nearly reflecting the original condition, and which as later and derivative.

The type of *L. Selago* may be taken first, since it does not show any high degree of specialisation in its variable gametophyte, while it has been seen above that its mature sporophyte is one of the least differentiated in the genus. Its early embryogeny, so far as is known, conforms to the usual type, as above stated. The foot originates from the lower tier, and the various parts of the embryo from the upper.¹ But the foot is only slightly developed. The upper tier of cells soon assumes a green colour and unsymmetrical form, owing to the lateral upgrowth of the first leaf or cotyledon, while the apex of the axis also originates early, near

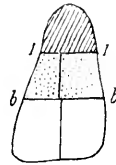

FIG. 182.

Diagram illustrating the primary segmentation of the zygote in *Lycopodium*. *l, l* = first segmentation wall which separates the suspensor, here cross-hatched. *b, b* separates a lower tier (foot-tier) here dotted, from an upper tier (stem-tier) left clear; each tier consists at first of four cells. The wall *b, b* corresponds to the wall IV.-IV. in Figs. 183, 186, and to wall II.-II. in Fig. 185.

¹ Bruchmann, *l.c.*, pp. 97-103.

to its base: it is clear that the relation of the apex to the intersection of the first walls has been a close one (Fig. 183 A). The axis soon proceeds to form successive leaves spirally arranged. The cotyledon and subsequent leaves have the ordinary characters of the foliage leaves of the species. The tissue below soon becomes elongated as the hypocotyl, the length of which is determined by the level at which the prothallus lies in the soil: where it is at or near to the surface the hypocotyl may be quite short: where deeply seated it lengthens, so that the first leaves are exposed

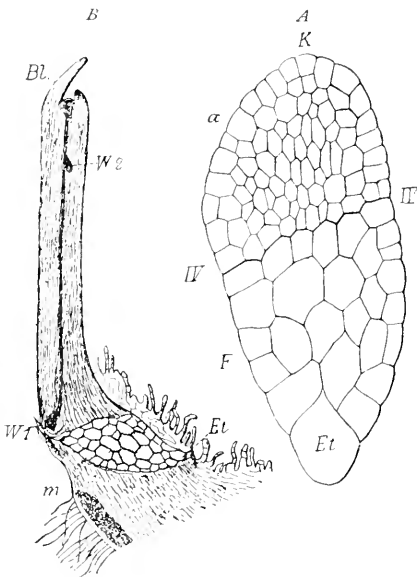

FIG. 183.

Lycopodium Schleg. A = young embryo. $\times 150$. F = foot; IV-IV = wall separating the foot from the stem-tier; K = cotyledon; α = apex; Et = suspensor. B = embryo more advanced, with prothallus still attached; Bl = cotyledon; W_1, W_2 = young roots; Et = suspensor attached to the foot, which is clearly defined from the base of the axis. $\times 20$. (After Bruchmann.)

above ground (Fig. 184). It is traversed by a vascular strand, which is monarch below, but near to the first leaf, or later, it becomes diarch, and shows two lateral tracheidal strands. The first root originates exogenously from the upper tier, just above the foot, and is succeeded by other roots of endogenous origin at higher points (Fig. 183 B).

Here, then, is an embryogeny characterised by its great directness and simplicity. The only complication is the varying elongation of the hypocotyl according to the level of the prothallus in the soil; and there is good reason to think that this is an immediate adaptation to meet the varying levels of development of the gametophyte in the soil, in an embryo which is pertinaciously subaerial. The nursing of the embryo by the prothallus is not long continued, nor is it structurally provided for, there being no development of an elaborate "calyptra," as in some other species: the embryo soon escapes from the prothallus, and fends for itself. The whole condition of the embryo is such as bespeaks a simple and primitive state. Probably this view would never have been in doubt had it not been for the existence of different arrangements seen in other species of the genus, which happened to have been described some years earlier.

Of these the type which corresponds most nearly to *L. Schleg* is that of *L. Phlegmaria*, so accurately described by Treub.¹ Here the segmentation of the embryo, as well as the origin of all the parts and their proportions while young, have been fully made out, and appear to be

¹ *Ann. Jard. Bot. de Buitenzorg*, vol. v., p. 87, etc.

substantially the same: the hypocotyl becomes elongated as the seedling develops, and the whole appearance of the seedling resembles that of *L. Selago*. The primary segmentation in *L. Phlegmaria* is according to the scheme (Fig. 182), and the lower tier, as in *L. Selago*, forms only the foot, which attains no great size (Fig. 185). The upper tier develops unsymmetrically from the first, the side which will form the first leaf growing more strongly; close to the base of the cotyledon, and apparently lateral owing to the stronger growth of the latter, but in reality terminal, arises the apex of the axis (T, Figs. 185 A, B); it is, in fact, initiated in close proximity to the organic centre of the upper tier. The root (R, Fig. 185 B) also originates from the upper tier. A comparison of Treub's drawings of *L. Phlegmaria* with Bruchmann's less complete series for *L. Selago* shows clearly the substantial similarity of the embryogeny in the two species. It will be remembered that the flattened prothalli of the latter species, formed near the level of the soil, have been held to prefigure the strap-shaped sexual branches of the *Phlegmaria* prothallus, though the latter shows its higher specialisation for a saprophytic habit in its filamentous development and in its frequent branching. On the other hand, as regards the sporophyte, it has been seen that the *Phlegmaria* type is not one of the highest developed, but is associated with *Selago* in the subgenus *Urostachya*. This being so, it is natural to find their embryos so similar, notwithstanding the difference in specialisation of the prothalli themselves. Lastly, both embryos are from the first subaerial: their first leaves are green assimilating organs, and differ in no essential degree from the normal foliage leaves. This may probably be held to be a primitive condition.

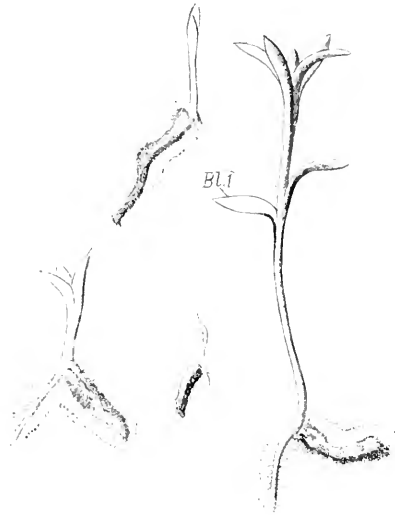

FIG. 184.

Prothalli of *Lycopodium Selago* with seedling plants.
 × 3. (After Bruchmann.)

But in the *clavatum-annotinum*-type the case is different. It has been seen that there the prothallus is developed underground, often at a considerable depth, and this brings with it modifications of the embryogeny. The first steps in the development are the same as in the types described above (Fig. 186 A); but very soon there is a conspicuous enlargement of the tissue of the foot, derived from the lower tier, adjoining the suspensor (Fig. 186 B): a large spherical swelling is thus formed, which remains as an intra-prothallial haustorium (compare Fig. 179 B with Fig. 186 C). The

upper tier meanwhile progresses only slowly: two opposite leaves, one on either side of the stem-apex, appear late as compared with other species,

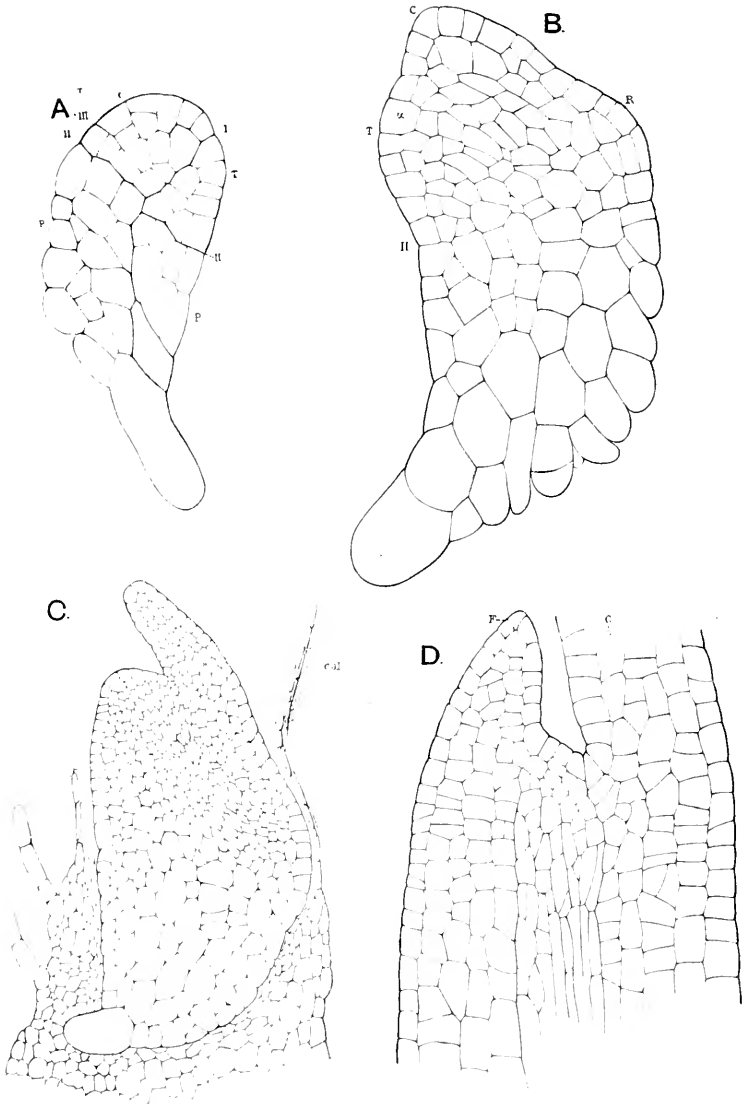

FIG. 185.

Embryos of *Lycopodium Phlegmaria*, in longitudinal section. *f* = foot; *c* = cotyledon; *T* = apex of axis. The wall marked II, in *A* and *B* corresponds to the wall marked IV, in Bruchmann's drawings (Figs. 183, 186) and to the wall *b*, *b* in Fig. 182. *C* and *D* represent older stages: in *D*, the cotyledon (*c*) has been followed by a plumular leaf *F*, and the apex of the axis lies between them. *A* and *B*: 200. *C*: 37. *D*: 200. (After Treub.)

their position relatively to the foot and to the suspensor not being constant (Fig. 186 *c*). This is ascribed by Bruchmann¹ to inconstancy of the foot:

¹ *l.c.*, p. 46.

its greatest development is not always in the plane of the median wall, but on that side from which the greatest quantity of nutriment flows from the prothallus, and this brings about a torsion which the suspensor does not prevent. In fact, the "foot" is here an opportunist growth, inconstant in position itself, and distorting in a variable manner the rest of the embryo. Soon after the origin of the first two leaves follows the origin of the first

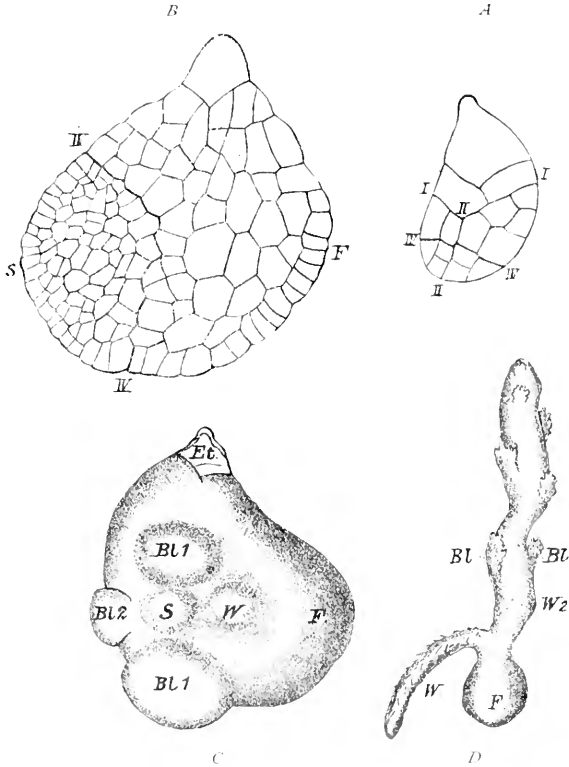

FIG. 126.

A—young embryo of *Lycopodium annotinum*. I-I,=the basal wall; II-II,=the transverse wall; IV-IV,=the wall separating the foot-tier from the stem-tier. *B*=an older embryo of *L. clavatum*, showing more advanced development of the two tiers, and especially of the foot-tier. *C*=an older embryo detached, with cotyledons (*BL*1), a further leaf (*BL*2), and the first root (*W*), and foot (*F*). *D*=young underground, colourless seedling; *F*=foot; *W*=root; *W*2=origin of a second root; *BL*=leaf-scales, of which the first pair are the cotyledons. *A* and *B* × 150. *C* × 52. *D* × 10. (After Bruchmann.)

root, in a position variable relatively to them (Fig. 186 c). The embryo then bursts the tissue of the prothallus, as a consequence of active intercalary growth of the hypocotyl, which emerges upwards, while the root enters the soil downwards (Fig. 186 d). The axis while growing through the soil is pale, and bears only colourless scale-leaves, but on emerging ultimately at the surface these pass into green leaves of the ordinary foliage type (Fig. 179 A). The embryology thus described is more complex than that of the *Selago* type: its details are plainly in accordance with the saprophytic specialisation of the prothallus, and with its position deeply

sunken in the soil. The embryo is long dependent for nourishment entirely upon the large prothallus; hence its swollen haustorial foot, which is developed most strongly in the direction of the largest nutritive supply, reacting meanwhile upon the disposition of the other parts of the embryo: in point of origin this is the consequence of unequal turgid distension and division of cells of the foot-tier, which in the *Selago*-type remain small. The first



FIG. 187.

Lycopodium cornutum. Young embryo emerging from the prothallus. *ar*=neck of archegonium; *s*=suspensor; 1, 1, basal wall, corresponding to *b*, *b* in Fig. 182, to II-II, in Fig. 185, and to IV-IV, in Figs. 183 and 186; *cot*=cotyledon; *tub*=tubercle of protocorm. $\times 300$. (After Treub.)

leaves—here an opposite pair, though in other species there is a single cotyledon—are only scale-leaves, which may serve for protection of the apex in forcing its way upwards through the soil; but this is only a derivative function, and it can hardly be doubted, after comparison with the embryo of *L. Selago*, that the foliage character of the first leaves was the prototype, and that the early formation of colourless scale-leaves in the *clavatum-annotinum*-type is a concomitant of the subterranean habit adopted by their prothalli.

There remains the type of embryogeny of *L. cernuum*,¹ shared in all essentials by *L. inundatum*.² Here the initial steps appear to be like those of other species, but the lower tier of cells which elsewhere forms the foot remains small, and as a body consisting of but few cells it serves to maintain a connection with the parent prothallus (Fig. 187). The upper tier as usual originates the several parts of the embryo: breaking through the prothallial tissue it emerges early as a free-growing structure; but it swells early into an undifferentiated tuberous body, the "protocorm," which is roughly spherical in form, composed exclusively of parenchyma, and attached to the soil by root-hairs. It is occupied by a symbiotic fungus. However similar to the swollen foot of the *clavatum*-type this "protocorm" may be, it is essentially a body of different origin: the foot springs from the lower tier of the embryo, and remains intra-prothallial: the protocorm originates from the upper tier, and is extra-prothallial. It was at first regarded as a foot which had quitted the prothallus; but developmentally it is distinct, while there is no evidence that an escape of the foot from the prothallus ever took place. The protocorm must therefore be held to be a body different in origin and nature from the foot in the *clavatum*-type. The part of the "protocorm" directed upwards bears a conical papilla of tissue, which develops into a cylindrical cotyledon: this is a green assimilating organ, with or without vascular tissue: it is succeeded by other leaves of similar type, which are, however, indefinite both in number and in position (Fig. 188). Relatively late the apex of the axis is recognised: its position is described as being near to the latest formed leaf, and the subsequent leaves arise from it in the usual aeropetal succession, thus constituting the normal shoot. Close to its base the first root is also formed, and thus the normal plant is at length established.

The existence of a tuberous stage, prior to the establishment of the normal sporophyte in these species, has given rise to Treub's well-known Theory of the Protocorm, while the very similar structure which is found perpetuated, and annually repeated in the life of *Phylloglossum*, added interest to the question of the real nature of the tuber in *L. cernuum*; but before its nature is discussed, it will be well to describe the leading facts in *Phylloglossum*. The prothallus of *Phylloglossum* appears, from the description of Thomas,³ to be of the *cernuum*-type, but it resembles most nearly that of *L. inundatum*: it has, however, no leaf-like assimilating lobes on the green crown, which projects above the soil. The archegonia appear upon the assimilating crown, and produce an embryo which is similar to that of *L. cernuum*: it projects early from the prothallus, the cotyledon being the first part to emerge: this develops as a green assimilating leaf similar to those of subsequent years. A "protocorm" is formed at once below the first leaf, and apparently in the same manner as the adult plant forms its tuber. No root has been observed during the

¹Treub, *Buit. Ann.*, viii., p. 1.

²Goebel, *Bot. Zeit.*, 1887, p. 183.

³*Proc. Roy. Soc.*, vol. lxix., p. 285.

first year's growth. From the description of Thomas it thus appears that the embryology is just what would be expected of a plant which had already been recognised as repeating in its annual cycle a development similar to that of *L. cornutum*.

The yearly growth of *Phylloglossum* resembles in many features that of the embryo: it originates at the apex of the storage-tuber formed during the preceding year, and its *punctum vegetativis* retains its identity as the centre of the new growth. Sometimes only a single leaf is formed,

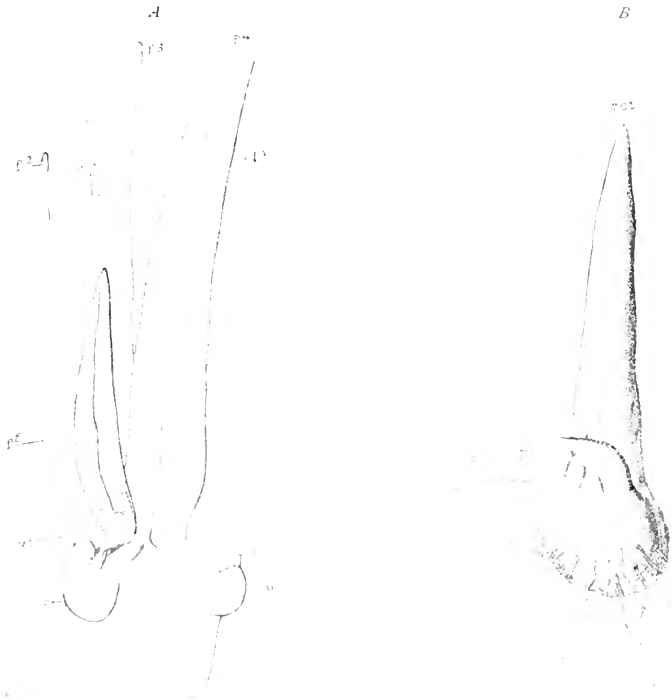

FIG. 188.

A and *B* embryos of *Lycopodium cornutum*, showing protocorm. *s*=suspensor; *f*=foot; *cot*=cotyledon; *f*¹, *f*², etc.=successive leaves; *r*=root; *vt*=*punctum vegetativis*. $\times 35$. (After Freub.)

but usually several more in strong plants: they arise in succession laterally around the apex, but are definite neither in number nor in position. In those cases where the plant does not form a strobilus, the apex, which lies centrally among the leaves, becomes depressed, while the tissue surrounding it, continuing to grow actively but unequally, a process is formed which develops into the new tuber (Fig. 189 *A*, *B*). Where a strobilus is formed it arises directly from the apex (Fig. 189 *C*, *D*, *E*), and a new provision has to be made for the formation of the new tuber. This appears adventitiously at the base of the peduncle, as a depression which is carried outwards on an elongating process due to active and

unequal growth, as in the previous case (Fig. 189 F, G). Comparing the tuber of *Phylloglossum* with the protocorm of *L. cernuum*, it is clear that the relations of both to the protophylls and to the definitive axis are the same: further, the relation of the foot in the embryo to the protocorm is as that of the stalk to the tuber in the perennating *Phylloglossum*. It follows that the tuber in *Phylloglossum* may be held to be a "protocorm" repeated annually in the life-cycle.

In Treub's description for *L. cernuum*, the origin of the definitive apex of the axis is not brought into relation to the primary segmentation of the embryo. His account of it is that "at the end of the second phase the tubercle ceases to grow, and its point of vegetation gives rise to the vegetative cone of a leafy Lycopod-shoot," etc.¹ Nor is the origin of the axis clearly made out by Goebel for *Lyc. inundatum*, though its close relation to the cotyledon is again recognised.² But the continuity of existence of the apex, which may be traced throughout the development in *Phylloglossum*, suggests a similar continuity in *L. cernuum* and *inundatum*. I venture to think that a

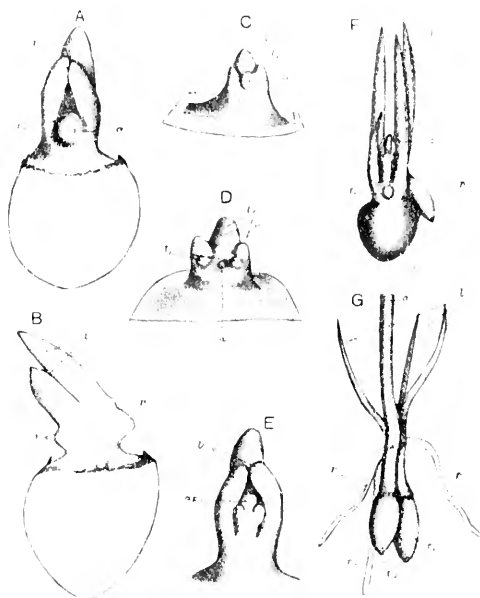

FIG. 189.

Phylloglossum Drummondii. A, B, frontal, and side views of young plant which will not form a strobilus. C, D, similar plants, showing arrangement of the protophylls. E, a plant forming a strobilus. F, G, similar plants, older, showing mode of origin of new tuber; t=protophylls; a=apex; r=root. A-E $\times 14$. F $\times 3$. G $\times 2$.

renewed investigation of the embryology of these species, especially in their simpler types, would bring them into line with other Lycopods, and show that the apex originates as in them from the central point of the upper tier of the embryo: but that the assertion of its characters is correlatively deferred, and its identity disguised by the early prevalence of the tuberous swellings and consequent irregularity of the first leaves.

Treub's theory of the "protocorm" has already been considered in Chapter XVII. Reasons were there given for not sharing the opinion that the tuberous developments seen in the embryogeny of *L. cernuum* and *inundatum* represent a primitive condition once wide-spread. The position was not accepted that the "protocorm" embodies an early evolutionary step towards the establishment of a free sporophyte prior to the formation

¹ *L.c.*, p. 11.

² *L.c.*, p. 184.

of a root. An alternative view was there propounded that the Lycopod embryo is a body prone to parenchymatous swelling, and that the "protocorm" is a consequence of secondary specialisation. It remains to group the facts of embryogeny in the eligulate Lycopods in accordance with that alternative view.

The simplest type of embryogeny in the genus is that of *L. Selago*, a species already recognised as primitive in the characters of the sporophyte. The embryo accommodates its growth in length to the level of its parent prothallus: excepting for this the embryo is of a constant type, without any complications of parenchymatous swelling. I regard this as a primitive condition for the genus, and the main features are these: a suspensor and foot of moderate size, passing directly into the primitive shoot, which escapes early from the prothallus, and expands its first leaves as green assimilating leaves. The apex of the axis, which provides a definite leaf-succession, is established early at the centre of the upper tier; the first root is formed early and exogenously, and it is followed soon by others of endogenous origin. Thus the young plant is simply and directly set up as an independent unit (Figs. 183, 184). The type most nearly corresponding to *L. Selago* is that of *L. Phlegmaria*. Notwithstanding the pronounced saprophytism of the prothallus, the embryogeny is practically identical in all essentials with that of *L. Selago*, though more exactly worked out (Fig. 185). But it is different with the *clavatum-annotinum*-type. Here the primary embryogeny is the same as in *L. Phlegmaria*, but the deeply underground position of the saprophytic prothallus necessitates longer and more efficient nursing of the embryo before it can establish its physiological independence. The absorptive surface and storage capacity of the embryo are accordingly enlarged by parenchymatous swelling of the foot. The directness of the adaptation is here indicated by the fact that the enlargement is on whatever side is nearest to the greatest source of supply. The late differentiation of the several parts, and the tardy emergence of the embryo from the prothallus, are all in accord with the necessarily longer nursing period: while the colourless scale-character of the earliest leaves is also a natural and secondary consequence of the subterranean embryogeny. It is not difficult to see in the *clavatum*-type an embryogeny essentially like that of *Selago*, but secondarily modified in relation to the subterranean habit of the prothallus. This accords well with the fact that the species included are more highly specialised than *L. Selago* as regards the characters of the sporophyte (Fig. 186).

The *cernuum-inundatum*-type on general characters of its prothallus and sporophyte takes a middle position. The embryogeny opens as in other Lycopods: but the foot-tier, which is enlarged in the *clavatum*-type, here remains small. The origin of the cotyledon is as in *L. Selago*, but the swelling in the upper tier, which begins early on the side directed downwards, profoundly disturbs the subsequent arrangements, so that detailed comparisons become difficult, and, as a consequence, the origin of the axis

is still obscure. The type of leaf seen in the cotyledon is repeated in the "protophylls," but without definiteness of position or number upon the enlarging tuber: their sequence is closed at last by the activity of the stem-apex, close to which in time and in position the first root appears. It is as though a rootless phase of morphological anomaly, initiated by the parenchymatous swelling in the upper tier, were intercalated in the regular embryogeny of the *Selago* type, immediately after the origin of the cotyledon: and after a period of digression the normal embryogeny were then resumed. The swelling is associated in *L. cernuum* and *inundatum* with the entry of a mycorrhizal fungus, which occupies the tuber: it must at present remain uncertain whether or not this symbiotic state is the cause or a mere concomitant of the tuberous condition: and what the relation of it to the late appearance of the root; but given the tuberous state, the other anomalous foliar conditions readily follow. The proneness of the Lycopod-embryo to such secondary swelling as contemplated is seen also in the embryos of the *clavatum*-type: it is also shown by the repetition of such swelling upon the roots in *L. cernuum* itself, as have been fully described by Treub.

The *cernuum*-type of embryo is shared by *L. inundatum*, but not in its extreme form. It is this species rather than *L. cernuum* itself which gives the link to *Phylloglossum*. The strobilus of the latter is like a very simple strobilus of *L. inundatum*: this species, as is well known, perishes in winter, excepting the tip of the trailing stem, which perennates. If such a condition were still further prepared for, and condensed by the formation of an adventitious protocorm in cases where the plant has been fertile, or of a similar body as the product of direct apical growth where the plant of the previous year was sterile, the condition of *Phylloglossum* would be attained. It is interesting to note in this connection that Goebel has found that adventitious protocorms are formed in *L. inundatum*, a fact which strengthens the suggestion here made.¹ It would thus appear that *Phylloglossum*, so far from being a prototype of Lycopodinous development, is more probably a specialised offset from it. I still adhere to my thesis as stated in 1885, that "it is a permanently embryonic form of Lycopod." But it may now be added that the characters which it repeats each year appear to be those of a secondary rather than of a primitive embryonic type.

And thus the embryogeny of the Eligulate Lycopods, so far as at present known, conforms to a single central scheme with variations upon it. The type of *L. Selago*, the only species of the "*Selago*" section of the genus in which the embryo has hitherto been observed, is held to be the most primitive, as it is certainly the simplest. The rest may be held to be secondary variants on that type, due to changes for the most part biologically intelligible.

¹ *Bot. Zeit.*, 1887, Plate II., Fig. 32.

(B) LIGULATE LYCOPODIALES.

It is an unfortunate circumstance that the embryogeny of fossils is usually inaccessible, for that of the dendroid Lycopods would greatly strengthen views as to their relation to modern forms. As it is, *Selaginella* and *Isoetes* provide the only facts of the embryogeny in the Ligulate Lycopods: it will be seen that they are strangely divergent in the form of the embryo.

It has been pointed out that *Selaginella spinulosa* may be held to be more primitive as regards the morphology of the mature plant than the dorsiventral species of the genus; and further, it has been seen that it differs from them anatomically, showing a vascular structure which is probably more primitive also. This gives a special interest to its embryology, which has been fully worked out by Bruchmann.¹ The early stages are essentially as in *Lycopodium*, resulting in a suspensor, and two tiers of four cells each, forming the embryo: the whole structure is at first straight, with the apex flattened (Fig. 190 A, B). The suspensor remains as in *Lycopodium*, and is a means of thrusting the embryo downwards into the tissue of the prothallus. The lower tier of cells of the embryo (*i.e.* that between walls I., I. and IV., IV. in Fig. 190 A and C) itself forms the hypocotyl, which may here be greatly elongated and curved, and becomes thus a prominent feature of the embryo: at its base, in close relation to the suspensor, the first root arises in a lateral position. The products of the upper tier at first remain small (*i.e.* above wall IV., IV., Fig. 190 A, C): the formation of the first cotyledon may in some cases be long delayed, sometimes it may still be wanting even when the axis has already curved obliquely to the suspensor. The second cotyledon may be even longer delayed: in some cases it only appears after the shoot issues from the spore. But sooner or later two opposite but unequal cotyledons successively make their appearance. Their orientation relatively to the suspensor is liable to vary. The apex of the axis, which has no single initial cell, lies between them, originating from the centre of the flattened apex of the embryo (Fig. 190 A, C, D). As the hypocotyl elongates the embryo curves so that the axis takes a vertical position, while the suspensor is pushed to one side by the growing root. Finally the shoot emerges above ground, and the two cotyledons, developing at last to equal size, appear as green assimilating leaves (Fig. 190 G, H). According to Bruchmann, no enlarged "foot" is formed in this species, and the same appears to be the case in *Selaginella apus*.

Comparing this embryogeny with that so well known in *S. Martensii*, there is essential similarity in the disposition of the parts. The chief difference lies in the presence of an haustorial swelling of the hypocotyl in *S. Martensii*, which has been called a "foot," and in the fact that single initials are found at the apices of stem and root: this accords

¹ *Unters. ueber "Selaginella spinulosa,"* Gotha, 1897.

with the mode of development of these parts in mature plants. For the variability in haustorial development within the genus the study of the embryology of *Lycopodium* has already prepared the way. Both genera demonstrate the inconstancy of the haustorial organs of the embryo, and justify my conclusion of more than twenty years ago, that these swellings

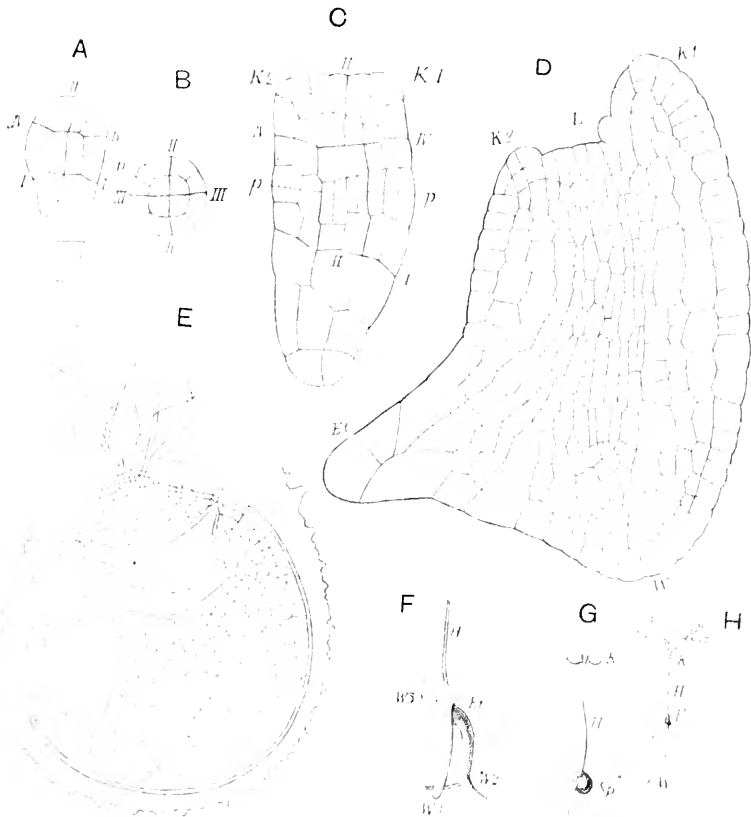

FIG. 106.

Embryos of *Selaginella spinulosa*. A-D illustrate the segmentation. I, L, first wall, separating the suspensor; IV, IV₁, corresponds to wall similarly marked in Figs. 183, 186, and to wall *b*, *b'* in Fig. 182; *p*=wall marking off the vascular strand of the axis. *K*₁ *K*₂=cotyledons; *L*=ligule; *W*=root. *E*=section of germinated spore with embryo *in situ*. *G*, *H*=seedlings. *H*, natural size; *G*, enlarged. *F*=the basal part of the seedling; *Et*=suspensor; *W*₁ *W*₂=roots. (After Bruchmann.)

of the hypocotyl arise when and where they are required, and are not to be held to be clearly defined or constant morphological members.¹ In both of the points named it would seem probable that *S. spinulosa* represents a more primitive type than *S. Martensii*.

Comparing this embryogeny with that of *Lycopodium*, it seems remarkable that the similarity of detail should be so great when the difference

¹ *Quart. Journ. Micr. Sci.*, xxii., p. 292, etc.

of the parent prothalli is so marked; the difference being between a free-growing, self-nourishing bisexual prothallus in *Lycopodium*, and an endosporic, unisexual, storage prothallus in *Selaginella*. The early form and structure of the embryo, consisting of a pluricellular suspensor and two tiers of cells of the embryo, is virtually the same in both cases. In the later development the nearest similarity is between *L. Selago* and *S. spinulosa*: there is in both a marked elongation of the hypocotyl, with the first root originating laterally near its base: there is the same absence of any determinate foot: and as a rule the same origin of a first cotyledon laterally, with the apex of the axis between it and the next-formed leaf. The axis thus originates in both in close relation to the intersection of the primary segmentation-walls of the upper tier of the embryo.¹ One point of difference is in the part played by the lower of the two tiers of cells of the embryo: in *Lycopodium* it remains in close relation with the suspensor, and may be more or less swollen into a foot in some species; but it does not elongate, or form any permanent part of the embryo, the whole of which originates from the upper tier. But in *Selaginella* the lower tier elongates to form the greater part of the hypocotyl, while the first root originates from its base. The position of the root relatively to the other parts is otherwise alike in *L. Selago* and in *S. spinulosa*. The similarity of the embryogeny of the genus *Selaginella* to that of *Lycopodium* is thus established by comparison of species both of which are held to be primitive in their respective genera, on the basis of comparison of their mature sporophytes.

At first sight the embryogeny of *Isoetes* seems to differ radically from that of *Selaginella*, notwithstanding that the endosporic prothallus is so similar in both cases. The key to the difference is first the inversion of the embryo, as compared with *Selaginella*, and secondly, the entire absence of any representative of the suspensor: what remains in *Isoetes* may be held to correspond to the product of the two upper embryonic tiers only.²

The first division of the zygote is by a wall more or less inclined to the axis of the archegonium, but occasionally almost including it (Fig. 191 B): this indeterminate position of the "basal wall" is theoretically important, as bearing on the inversion of the embryo in the archegonium as compared with that in *Lycopodium* or *Selaginella*: the variations seen in *Isoetes* suggest how that inversion may have come about. The two tiers thus initiated are usually called the hypobasal and the epibasal; but the octant divisions commonly seen in other embryos are not always clearly defined in *Isoetes*. The hypobasal tier here forms the foot only: all the

¹ On this point the facts have been better made out in *L. phlegmaria* and *L. clavatum* than in *L. Selago*; but the facts for the latter, so far as they go, are consistent with the same conclusion.

² See Campbell, *Mosses and Ferns*, p. 545, etc. Also Kienitz-Gerloff, *Bot. Zeit.*, 1881, p. 761.

other parts originate from the epibasal tier: the cotyledon with its ligule is the first part to be organised: it is followed soon by the first root, which arises at the opposite side of the epibasal tier to the cotyledon (Fig. 191 C, D, E, F). Between these parts a slight depression is formed, and it is surrounded by a semicircular ridge: within this the apex of the axis is at last organised, and it soon gives rise to the second leaf, which

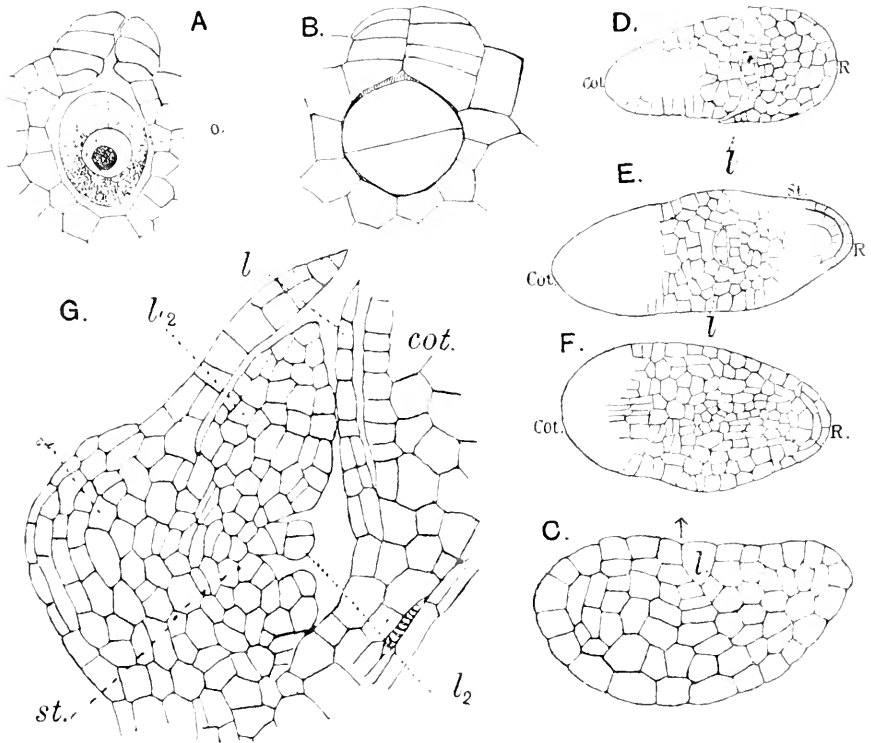

FIG. 191.

Isoetes echinospora, var. *Braunii*, Dur. $\times 365$. A=an archegonium. B=a two-celled embryo within the archegonium. D, E, F=three successive horizontal sections of a somewhat advanced embryo: R=root; cot=cotyledon; st=stem; l=ligule. $\times 175$. C=median longitudinal section of a young embryo; l=ligule. $\times 200$. G=median section of a young sporophyte with second leaf, l₂, already formed; r₂=second root; st=stem apex. $\times 150$. (After Campbell.)

faces the cotyledon: the very exiguous apical cone lies between them (Fig. 191 G). And so the shoot is established, bearing successive leaves with spiral arrangement, and successive roots, of which the second is below the base of the second leaf.

Comparing this apparently divergent embryogeny with that of the Lycopods above described, if the whole embryo be imagined inverted in its orientation relative to the archegonial neck, and their suspensor be imagined entirely away, then the two embryonic tiers may be con-

pared with those seen in *Isoetes*. Here, as in *L. Selago* and *L. Phlegmaria*, the hypobasal tier forms the suctorial organ only, and takes no direct part in the establishment of the plant. The epibasal tier is like that of *L. Selago* as regards the parts which it initiates and in the positions which they severally hold, but differs in its growth in length being stunted, and in the early ascendancy of the cotyledon, which condition it shares, however, in some measure with *L. Phlegmaria*: it differs also in the late definition of the apex. But the position of the latter relatively to the whole embryo is the same, for the stem originates in close relation to the centre of the upper tier of the embryo, as it does in all the Lycopods where the embryogeny has been exactly followed. The apical cone is small in bulk and late in appearance, these being probably correlative consequences of the early advance of the cotyledon. It is thus possible to see even in the embryo of *Isoetes* some clear relation to the plan which, with such curious modifications, underlies the embryogeny of the Lycopods.

We are now in a position to enunciate a comparative view of the embryogeny as known in the Lycopodiales, and to state it so as to place the several curiously divergent types in what is believed to be their natural relation to a probable primitive embryogeny. In so doing prominence is given to the more constant features, while only a subsidiary place is given to those characters which are less stable.

In those Lycopods in which the embryogeny has been exactly followed, the embryo consists of a suspensor and two tiers of four cells each composing the embryonic body: the two tiers are separated by a wall which may be called the "basal" wall (Fig. 182 *b*, *b*). This seems to be a general condition, subject only to minor modifications: in *Isoetes*, however, the suspensor is entirely wanting. In the very various developments which follow, the most constant feature is undoubtedly the close relation of the stem-apex to the point of intersection of the octant-walls in the epibasal tier. In the simplest cases the axis of the embryo is thus defined at once as lying between that point and the base of the suspensor. The whole embryo is thus primarily a spindle-like body, and this may be held to have been the primitive condition for them all.

But this simple form is subject to early modifications, which disguise the position of the axis by delaying its apical growth, and by distorting the form: so much so that the position and identity of the apex is liable to be lost. The least distorted types are those of *L. Selago* (Figs. 183, 184) and *Phlegmaria* (Fig. 185), and of *S. spinulosa* (Fig. 190), all plants which are relatively primitive in their genera as recognised by the characters of the mature sporophyte. In *L. Selago* and *Phlegmaria* no haustorial swellings exist. The early development of the single cotyledon at first throws the apex of the axis to one side, but this is rectified later when the second leaf appears on the side opposite to the first. The apex thus

"righted" is then carried up together with the two leaves by the elongating hypocotyl, while the first root appears laterally at its base. The whole arrangement is relatively simple, but illustrates a slight degree of distortion of the apex, which is, however, temporary only.

In the *claratum*-type (Figs. 170, 186) the hypobasal tier is enlarged, and curved to one side, with correlative late differentiation of the epibasal region, and absence at first of localised intercalary growth. The orientation of the foot is not constant, but it is directed towards the chief source of nutriment, a fact which indicates its opportunist character. In the epibasal region the apex of the axis is clearly of central origin, between the two small but equal cotyledons, which appear relatively late. The root originates in a position corresponding to that of the former type. The whole embryo may be held to be a biologically intelligible modification of the *Selago*-type consequent on the underground habit of the large mycorrhizal prothallus. The enlargement of the haustorial foot leads correlatively to slow development of the epibasal region, while the first leaves, having no nutritive function, are not hurried on in their development so as either to distort or to produce correlative reduction of the apical cone.

In the *cernuum*-type (Figs. 187, 188) the tuberous swelling is not in the hypobasal but in the epibasal region, and it profoundly disturbs its development. The biological cause of the swelling, which is extra-prothallial and liable to repetition, may be the intrusion of the symbiotic fungus which is present, or there may be some other reason for the tuberous development, associated as it is with the late origin of the root. But whatever the cause, the form is such as might be expected in a secondary tuberous modification of a green leafy shoot of a young Lycopod. The bulky development below, and the rapid enlargement of the assimilating leaves act correlatively in keeping the stem-apex inconspicuous. Its identity throughout the embryogeny of *L. cernuum* itself is not yet demonstrated; but in *Phylloglossum* the definitive apex of the shoot has been seen to coincide with the apex of the tuber (Fig. 189); it is therefore probable that in the embryogeny of *L. cernuum* the apex of the axis is present in the very young embryo in the usual position, but has escaped recognition owing to its correlative diminution. The protophylls would then be leaves of the normal type, altered in relation to the gouty habit of the axis which bears them, and disposed in an apparently irregular and isolated fashion upon the swollen axis. The root is long deferred, perhaps in relation to the mycorrhizal habit; but when it does appear, its relation to the leafy shoot is like that which it has in the other types of the genus. The normal leafy shoot and the root-system, thus delayed by the gouty interlude called the "protocorm," ultimately continue their development as in other Lycopods. Thus the different types of the genus appear to start alike, and when established in the soil continue alike, but show divergent intermediate phases. The simple development of *L. Selago* and

Phlegmaria is believed to be primitive, the turgid developments of *L. clavatum*, *cernuum* and *inundatum*, and also of *Phylloglossum*, are believed to be secondary.

The embryogeny of *Selaginella* (Fig. 190) corresponds in all essentials to that of *Lycopodium*, and shows only minor distortion or swelling. In the simple case of *S. spinulosa* the apex of the axis originates as before from the centre of the upper tier: the active growth of the first leaf throws the apex of the axis to one side: but it is "righted" again on the appearance of the second, and the identity of the apex is clearly maintained throughout. The whole epibasal tier is then carried upwards by intercalary growth of the hypobasal region, but the hypocotyl thus formed is without lateral swelling, and the first root originates laterally at its base. As regards distortions, this case is quite similar to that of *L. Selago* or *Phlegmaria*. But in other *Selaginellas*, as exemplified by *S. Martensii*, the cotyledons arise equally, as indeed they sometimes do in *S. spinulosa*, and the temporary distortion of the apex does not appear: but a lateral swelling, absent in *S. spinulosa*, constitutes the "foot." Thus *Selaginella* shows only minor and inconstant deviations from the simple type.

The embryogeny of *Isoetes* is less easily compared, but the following tentative suggestion is given (Fig. 191). The suspensor is entirely absent, and the embryo, composed only of the two tiers corresponding to those of other Lycopods, is usually orientated so that its apex is from the first directed towards the neck of the archegonium. That the rotation necessary to bring this about may occur is indicated by the differences of position of the basal wall noted by Campbell. The product of the hypobasal tier is the haustorial foot only: the upper tier hastens at once to form the large cotyledon, with the effect that the stem-apex is delayed, and remains minute: it only becomes clearly recognisable after the appearance of the second leaf opposite the first. In relative position, however, these parts of the shoot correspond to those of *S. spinulosa* or *L. Phlegmaria*. The first root originates from the epibasal tier as in *Lycopodium* rather than *Selaginella*, and unlike *L. Phlegmaria* and *S. spinulosa* on the side opposite to the cotyledon: but the orientation of the root relatively to the cotyledon has been seen to vary within the Lycopodiales, so no great importance need attach to this discrepancy. The primary embryogeny of *Isoetes* may thus be held as related to that of the other Lycopodiales, but without a suspensor, and greatly abbreviated, and with the apex of the axis correlatively reduced and delayed in its development, owing to the early production of the cotyledon and the root. Nevertheless, its position at the centre of the epibasal tier is maintained.

It is thus seen that the embryos of all the Lycopodiales may be held as variants on a single type, and fundamentally of spindle-like form.

SUMMARY OF THE COMPARATIVE EXAMINATION OF THE
LYCOPODIALES.

The sporophyte of the Lycopodiales has now been studied comparatively as regards its external form, its spore-producing members, its anatomy, and embryology. The conclusion arrived at from all these quarters is favourable to a strobiloid origin, with subsequent specialisation along lines variously divergent. By the comparison of known representatives of the Lycopodiales, living and fossil, certain characters have been recognised as relatively primitive, others as derivative: and thus a general idea has been obtained of a primitive type of Lycopod-sporophyte, which forms the basis of a theory how such a sporophyte came into being. In form this primitive sporophyte was probably a simple, unbranched, radially constructed shoot, endowed with unlimited apical growth, while local intercalary growth might also occur. The axis bore undifferentiated leaves, each of which had one sporangium associated with it in a median position. It was rooted at its base, but the origin of the root may be held to have been accessory in evolution, as it is seen to be late and variable in the individual development. The internal construction of the shoot showed a non-medullated monostele, continuous as a cauline column to the apex of the axis, while the foliar strands were inserted with but slight local disturbance upon its periphery. Its sporangia were kidney-shaped, and not greatly extended radially. The primitive body thus sketched in its broad outlines was derived from a spindle-shaped embryo, without any haustorial swelling, or tuberous protocorm. The theory of the strobilus, as enunciated in Chapter XI., would adequately account for the origin of so simple a sporophyte as this, from a still more primitive body, with sterile base and fertile apical region, by segregation of the fertile tissue into separate sporangia, and by enation of sporophylls.

The nearest living representative of such a sporophyte which has been adequately investigated is *Lycopodium Selago*: but it is to be remembered that this is the only one of 39 species of the *Selago*-section of the genus so examined, and there are indications, derived as yet from external characters only, that other and more primitive types than *L. Selago* exist among them: these await further investigation. The first leaves formed on the embryo of *L. Selago* are lateral in origin, and become aerial and green, but are sterile: sporangia were noted by Bruchmann,¹ as first appearing after the second branching of the axis, which, however, is early as compared with the other European species, though not as compared with the large Andean forms. Their early appearance, as well as the similarity of the sterile and fertile leaves, coupled with the evidence of abortion of sporangia in the upper region, all point to the conclusion that originally all the leaves were sporophylls, while all arose laterally upon the axis.

¹ *L.c.*, p. 100.

From such a starting-point various lines of elaboration may be traced, open often to ready biological explanations: and these appear to have run in some degree parallel in the ligulate and non-ligulate series. The steps which may be traced on a basis of comparison are as follows: First, the progressive sterilisation by abortion of sporangia increased the vegetative region: this led to more definite specialisation of the strobilus: in the more advanced forms the sporophylls are no longer nutritive, but only protective in function, so that the differentiation of the nutritive from the vegetative tract has become clearly marked. The vegetative shoot once distinct from the propagative strobilus was susceptible of various specialisation. In the dendroid fossils it attained large size, with secondary increase of its tissues, both stelar and extra-stelar, but still it maintained its radial symmetry. In the smaller forms, the straggling or climbing habit led not uncommonly to dorsiventral development, which occasionally extended to the more conservative strobilus itself. Such advances were accompanied by various elaboration of the vascular tissues, such as medullation, disintegration into separate strands, or even into meristeles. But these are all referable back in origin to the primitive monostele, just as the variations of external character are referable by comparison to the primitive strobilus.

The sporangia all conform to one general fan-shaped type, with singular constancy of number and position relatively to the leaves. But the dimensions vary, and at least in *Lycopodium* there is a relation between the size of the sporangium and the definition of the strobilus: where the shoot is undifferentiated, as in *L. Selago*, the sporangium is radially compressed: where the strobilus is clearly defined, and the vegetative region more specialised, as in *L. clavatum* or *alpinum*, it is radially elongated. The most extreme cases of this are found among the ligulate forms, as in the dendroid fossils with their ample vegetative system. But, on the other hand, this relation is not constant, for the sporangia of *Isoetes* are radially elongated, though there is no differentiation of the strobilus, while the sporangia of *Selaginella* are compressed, though the strobili are clearly defined. One of the most interesting points in these large sporangia is the partial sterilisation of their sporogenous tissues, probably to meet mechanical and nutritive requirements: sterile trabeculae are thus formed in the sporangia of *Isoetes*, and in certain *Lepidostrobi*. This leads towards a condition of septation, but in the Lycopods the step is never taken to complete partition of the sporangium. Finally, the heterosporous differentiation is probably a condition assumed after the character of the sporangium was already defined, and it has not greatly affected the general morphology of the shoots where it has occurred.

In the eligate series the embryo is simple and spindle-shaped. In *L. Selago*, which on other grounds is regarded as a primitive type, it grows directly and without complications into the seedling, with its green

assimilating leaves. In other cases it shows various modifications. Where the thallus is buried deeply underground, as in *L. clavatum*, the lower tier of the embryo enlarges as an haustorial foot, while the first leaves are modified into colourless protective scales, evidently a secondary condition. In the *cernuum*-type and in *Phylloglossum* a distinct extra-prothallial swelling appears in the upper tier of the embryo, disturbing the position and even the arrangement of its parts. Since the first stages of this embryo resemble those of other Lycopods, and since the normal shoot, when ultimately established, is also of the usual Lycopod type, it is concluded that the swollen stage, styled the "protocorm" by Treub, is a gouty interlude, introduced secondarily into the normal development, and not a stage of general significance. In the ligulate series, *Selaginella spinulosa*, which is held as a relatively primitive type on comparison of its mature sporophyte, the seedling is very similar to that of *L. Selago*, notwithstanding the striking difference of their prothalli. But the simple spindle-form which it shows is departed from in other species, by the lateral formation of a swollen haustorium: this "foot" is again held to be a secondary development. The apparently divergent embryogeny of *Isoetes* is carried out without a suspensor, but the position of the parts in relation to the greatly abbreviated axis is essentially similar to that in *Selaginella*. It thus appears that in both series the most primitive type has an embryo in the form of a simple spindle: it forms its first leaves as normal green foliage leaves, and those species in which this is departed from are held as the result of secondary modification. The first foliage leaves in these simple forms differ in no essential respect from the subsequently formed sporophylls, except in the absence of the sporangium. Hence the observed facts support the view that all the leaves were originally sporophylls, and the whole plant originally a simple strobilus.

It has thus been seen that a strobiloid theory is applicable to all known types of the Lycopodiales. This matter has been dealt with at considerable length because, in the first place, this phylum of Vascular Plants dates back fully as far as any other in the Palaeontological record. Secondly, because it is represented by many living species susceptible of minute investigation throughout their life-cycle: and, thirdly, because these and the fossils together show gradual, and at the same time considerable divergence of detail in the one uniform scheme. They thus provide a better basis for comparison than any other series of Pteridophytes of equal age. The conclusions arrived at will be susceptible of comparison with those relating to other phyla of Vascular Plants. But though the application of the theory of the strobilus may be extended to other phyla, it must be remembered that the arguments and conclusions relative to the Lycopodiales stand by themselves, and would still be equally cogent if no other Vascular Plants existed on the earth's surface.

CHAPTER XXVII.

SPORANGIOPHORIC PTERIDOPHYTES.

I. EQUISETALES.

UNDER the common designation of the "Sporangiophoric Pteridophytes" may be grouped together those forms whose sporangia are disposed, either singly or in larger numbers, upon more or less elongated vascular stalks, which are enlarged as a rule at their distal ends. The existence of the sporangiophore clearly distinguishes these plants from the Lycopodiales, though it may for the present remain an open question whether any genetic connection existed between the latter and the sporangiophoric types. Under this designation are included the Equisetales and the Sphenophyllales (incl. Psilotaceae), while, according to the view which will be developed below, the Ophioglossales will also appear as an outlying group sharing the same character, though in a more elaborated form. It will be a matter for later discussion how far the existence of the sporangiophore as the immediate sporangium-bearing member will supply a valid basis on which to trace affinity: the decision must rest on the degree of correspondence of the sporangiophoric types in other characters, such as the external morphology and anatomy of the vegetative organs, and the details of the gametophyte. Unfortunately these are often so imperfectly known that we are thrown back in great measure upon the spore-producing members: but on grounds previously explained these are held to be the most important of all.

The Equisetales, which are taken first of the sporangiophoric types, are distinguished from the rest by the fact that their sporangiophores are inserted directly upon the axis, not on appendicular parts: in some cases they show a definite relation to the bracts which subtend them: in others no such relation exists. Other less distinctive characters of the vegetative organs are the constantly radial construction of the shoot: the elongation of the internodes which are longitudinally striated, the verticillate arrangement of the leaves, a high degree of branching, and a structure of the stele with a ring of isolated vascular strands; these

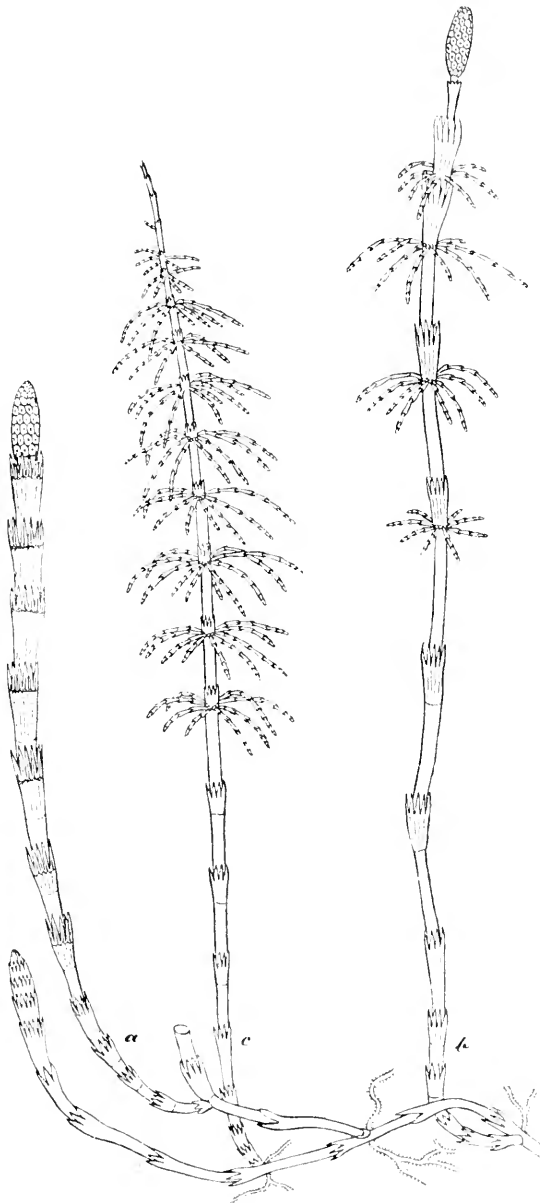

FIG. 192.

Equisetum pratense, Ehrh. Rhizome with unbranched fertile shoots (a), a fertile shoot which has begun to form branches (b), and a young sterile shoot (c). Natural size. (After Duval-Jouve, from Rabenhorst's *Krypt. Flora*.)

collectively characterise the group as a definite one. As regards its past history, the evidences of the existence of the Equisetales extend back to the Devonian period, where they already showed a high degree of elaboration. But these plants formed a more conspicuous feature in the Carboniferous Flora, where they attained their maximum development in

point of numbers as well as in size. Subsequently the type became less prevalent, till at the present day it is represented only by the cosmopolitan genus *Equisetum*, with its twenty-four species, showing remarkable uniformity of type. The essential characteristics of the living genus will be taken first, as it is susceptible of more complete study than the fossils: these will be worked in on a basis of comparison with what is seen in *Equisetum* itself.

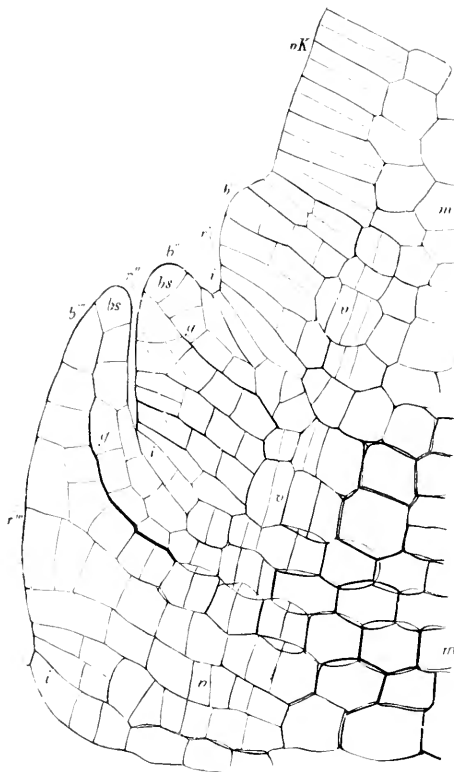

FIG. 193.

Equisetum maximum, Link. • Left half of a radial longitudinal section below the apex of an underground bud (in September). *K*, lower part of the apical cone; *b*, *b'*, *b''*—leaves; *m*—pith; *r*, *r'*—meristematic ring; *g*, *s*—cell-layer from which the bundles of the leaf-teeth arise; *t*, *t'*—the first beginning of a branch. (After Sachs, from Engler and Prantl, *Nat. Pflanzenfam.*)

the dominant feature of the shoot, and it is always of radial construction: it is terminated by a conical apex with well-marked initial cell. Upon the vegetative axis the leaf-sheaths arise laterally, in close acropetal succession: they are webbed from a very early stage, and when mature consist of clearly marked leaf-teeth projecting upwards from the webbed sheath below (Fig. 193). As the developing internodes lengthen by intercalary growth of the bud thus constructed the leaf-sheaths separate, while the internodes themselves are then seen to be marked by flutings corresponding to the

EXTERNAL CHARACTERS.

It will be unnecessary to describe the characters of the shoot in *Equisetum* in full detail, or the comparatively slight modifications of it upon which the species are distinguished: a brief account will suffice to indicate the essential features, for beneath them all lies a general unity of plan which is closely followed, whether the shoot be underground or exposed to the air (Fig. 192). The axis is plainly

markings of the leaf-sheath next above: at the nodes it is clearly seen that the teeth of the successive leaf-sheaths alternate. The leaves themselves are mostly dry and chaffy, while the tissues of the stem contain chlorophyll, and constitute the chief assimilating tissue of the plant. The number of teeth in the sheath, their proportions, and their permanence or deciduous character may vary: the internodes may be swollen for storage purposes in underground stems, while on the aerial stems the extent of the chlorophyll-parenchyma, and the number and disposition of the stomata may fluctuate: but, putting aside such differences, which are only of secondary importance, the plan of the shoot is the same in all living Horsetails. It is a notable fact that in none of them is there any departure from the radial symmetry of construction of the shoot, or from the verticillate disposition of the leaves.

The normal branching of the shoot is exclusively monopodial,¹ and originates from cells lying immediately above the leaf sheaths, and in a position alternating with its teeth (cells marked *i*, *i*, in Fig. 193); the branches are therefore not axillary. The shoots thus initiated burst through the subtending sheath, giving the appearance of an endogenous origin, and on further development they repeat, though usually on a simplified scale, the characters of the original shoot. Such branches are not initiated at every available point intervening between the leaf-teeth: moreover, where they are initiated, they are frequently not developed beyond the earliest stages, in which case there may be no external sign of their presence. The branches thus formed are plainly accessory to the parent shoot, while they repeat its characters: they are not to be held as any necessary constituent part of the parent shoot, but as parts added to those of the simple shoot itself.

The roots, excepting the primary root of the embryo, are formed in regular relation to the accessory buds above described: one root is initiated at the base of each bud, and thus the roots, though formed like the buds in definite positions relative to the other parts, are held none the less to be accessory also. Their further branching is monopodial.

Both roots and shoots are susceptible of different degrees of development according to circumstances, with results which lead to striking external differences: and upon these the specific distinctions are partly based. Either shoots or roots may remain dormant though initiated: this is especially seen in the case of the roots in aerial parts, and of the lateral shoots in the parts that are underground. This circumstance provides specific characters: thus, in some species many or all of the branches may remain dormant, even on the aerial stems (*e.g.* *E. limosum* and *hiemale*). It also contributes largely to the general aspect of the individual

¹Occasional terminal branchings have been described, especially in the region of the strobilus, which would be comparable with the terminal branchings in the Lycopodiales, but they are sufficiently uncommon to be held as abnormalities.

organism, as is clearly seen in the case of such species as *E. pratense* (Fig. 192). In other species again the development or non-development of the branches differentiates the vegetative axes from those which are fertile, as in *E. arvense* and *maximum*: in others the lateral branches on fertile axes are only delayed in their development, as in *E. palustre* and *sylvaticum*: in others again there is little difference as regards branching between the fertile and sterile shoots. But it has been shown experimentally by Goebel¹ that even in so pronounced a case of the absence of lateral branches as the fertile axis of *E. arvense* the development of green lateral branches could be induced: this was done by culture of the lower internodes in a moist chamber, when green assimilating branches were put out from the nodes, as in the vegetative shoot. The apparently branchless fertile shoot was thus brought into line with the ordinary branched type prevalent in the genus. Such facts indicate that the branched condition was probably common for the genus, but in certain cases a late differentiation has arisen between the colourless fertile shoots where the branches are dormant, and the branched green assimilating shoots.²

The fertile strobilus of *Equisetum* is normally terminal on the axis, and is usually borne on the relative main axis only. Many cases exist, however, of the development of the strobili on lateral branches: this may be normal for certain species, such as *E. myriochaetum*, Cham, of the sub-section *Pleio-stachya*, Milde, well shown in Engler and Prantl, *Pflanzenfamilien*, i., 4, Fig. 343, p. 547; but it also occurs occasionally in others, where a single terminal strobilus is normally present ("*forma polystachya*").³ In the case of *Equisetum sylvaticum polystachyum* (Fig. 194), where numerous lateral branches normally sterile bear small strobili, Luerssen has been able to correlate the change with external conditions:⁴ this is the next step to bringing its determination within the limits of experiment. On the other hand, numerous cases have been recorded of the continued growth of the strobilus, at its apex, with a return to the ordinary vegetative characters. Such facts show that the lateral branches are not essentially different from the relative main axis, as regards the final end of spore-production: also, that there is no absolute barrier between the vegetative and the fertile regions in *Equisetum*. Speaking generally, the fertile strobilus is not restricted to axes of any definite order. Thus it requires no great effort of imagination to see in the shoot-system of *Equisetum* the result of amplification of a simple unit, the shoot, composed of axis and successive

¹ *Ber. d. Deutsch. Bot. Gesell.*, 1886, p. 184.

² For an interesting discussion of the biological relations of the sterile and fertile shoots in living species of *Equisetum*, see Goebel, *Organography*, vol. ii., p. 501.

³ For records of such developments in European species, see Rab. *Krypt. Flora*, iii., p. 622, etc.; and especially Luerssen, "Beitr. z. Kenntn. d. Flora, W. and Ostpreussens," *Bibl. Bot.*, 1894, Heft 28.

⁴ *L.c.*, p. 13.

leaf-sheaths, and capable of spore-production by a terminal strobilus. The branching, however complex, may be held as accessory, as also the formation of roots so closely associated with the branches. The fundamental idea of the plant is thus carried back to the first shoot which originates with the embryogeny. It may be held that from this, by successive accessory branchings, the complex shoot-system arose, while the spore-production was deferred to the later branchings: it is on these that the fructification ultimately appears in the living species, while the primary axis and earlier branchings are normally sterile.

The strobilus itself consists of a continuation of the axis which bears it, and upon this the sporangiophores are disposed, but often with less regularity than rules in the case of the leaf-sheaths. The whole strobilus is normally occupied by the sporangiophores, without any intervening bracts (Fig. 195 A). The sporangiophore itself consists of a central stalk supporting a polygonal distal end: from the margin of this the sporangia hang in variable number, forming a series surrounding the stalk (Fig. 195 B). The spores are all of one type (Isosporous). At the base of the strobilus a ring-like structure is found—the annulus—which is like a reduced leaf-sheath, and it has usually been held to show a transitional stage between the vegetative leaf-sheaths and the first whorl of the sporangiophores, these being recognised as equivalent parts. Reasons will be advanced below for not accepting this apparently simple view. The strobilus of *Equisetum* is liable to variations of development, which have their importance in relation to certain fossil forms. The most notable of these is proliferation, the apex of the strobilus being continued as a vegetative shoot: the effect is thus gained of a fertile zone bearing sporangiophores, threaded upon an axis, or of a succession of such zones,

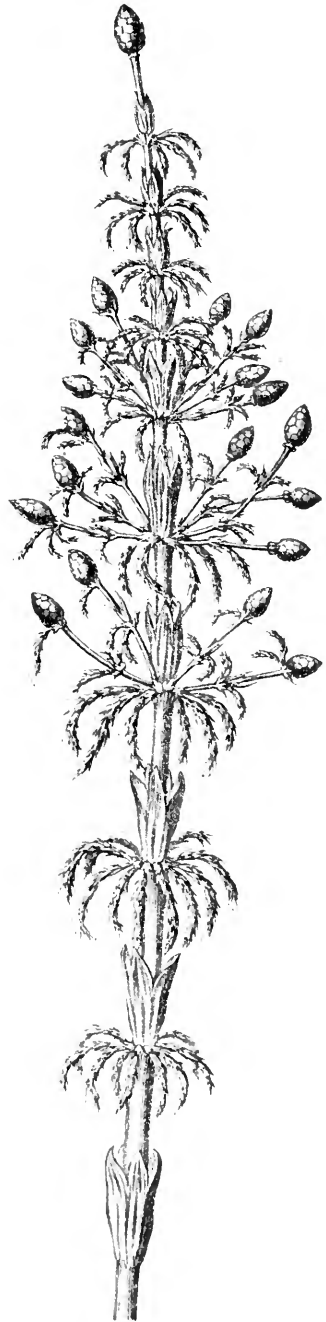

FIG. 194.

Equisetum sylvaticum, L., form *polystachya*, Mille. Plant with 13 secondary strobili, in three whorls of branches which are normally sterile. Natural size. (After Lurson.)

separated by leaf-sheaths (Fig. 196). It is thus seen that the strobilus of *Equisetum* is not always that circumscribed terminal body which is typical for the living species.

The *Equisetum*-type has been recognised, though with some uncertainty, and only in few specimens, as far back as the Middle Coal Measures:¹ but it is seen represented more commonly, and by large forms, in the Mesozoic rocks. Related to it are two other fossil forms: the genus *Phyllothea* of Permian age resembles *Equisetum* in the general features of the shoot, with its cup-like leaf-sheaths webbed at the base, but differing in the form of the leaves and in the fertile region: this is constructed on the general plan of *Equisetum*, but with the strobilus interrupted at intervals by sheaths of sterile leaves, as in some abnormal conditions of *Equisetum* (Fig. 197). Some specimens of *Phyllothea* have, however, been described by M. Zeiller as having strobili like those of *Annularia*, that is, of the *Calamostachys*-type.² The other genus is *Schizoneura*, of Triassic age, characterised by the whorled leaves being associated in webbed sheaths, which may, however, be slit longitudinally to the base. They thus form leaf-like lobes which stand off at a considerable angle from the axis (Fig. 198). The axis is marked by longitudinal grooves, which are continuous longitudinally from internode to internode, thus showing that the leaves of successive whorls did not alternate. The fructification is unknown.

Equisetum maximum, Link. *A*, the upper part of a fertile axis, with the lower half of the strobilus. Natural size. *b*=the leaf-sheath. *a*=annulus. *x*=stalks of sporangiophores cut off. *y*=transverse section of axis. *B*=sporangiohores in various positions, slightly enlarged. *st*=stalk. *sg*=sporangia. *s*=enlarged distal end. (After Sachs.)

with secondary thickening of the stem, but with a similar primary construction of the shoot to that seen in *Equisetum*. The leaf-whorls are frequently webbed at the base, though often only slightly, as in *Annularia*; but in *Asterophyllites*, which is traced back to the Devonian period, the leaves appear quite separate, in widely divergent whorls.

¹Kidston, "On the occurrence of the genus *Equisetum*, etc.," *Annals Mag. Nat. Hist.* ix., p. 138, 1892.

²Zeiller, *Palaeobotaniqu*, p. 164.

The leaves themselves were usually simple, as in *Equisetum*, though of greater dimensions, and accordingly more effective as assimilating organs; but among the earliest forms, such as *Asterocalamites* (Schimper), from the Culm, the leaves were branched in repeated dichotomies (Fig. 199). In the very early *Pseudobornia*, from the upper Devonian of Bear Island,¹ the foliage was forked in a fan-like fashion, and of considerable dimensions. Another feature, in which certain of the earliest forms differed from the later, was in the fact that the members of successive whorls were superposed, and did not alternate (e.g. *Asterocalamites*). Such forms have been



FIG. 106.

Equisetum pratense, Ehrh. Shoots showing recurrent whorls of sporangiophores and of bracts. (After Milde.)

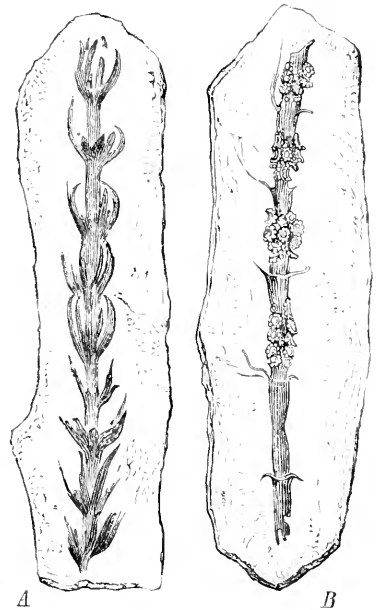

FIG. 107.

Phyllotheca, Zigno. A, *Ph. equisetiformis* from Rovere di Velo, near Verona. B, inflorescence from Siberia, placed by Schmalhausen with *Phyllotheca*. (After Solms.)

associated by Potonié as a family of "Protocalamariaceae." The facts would seem to indicate then a primitive construction of the Equisetoid shoot as having relatively large whorled and superposed leaves, effective as assimilating foliage: these were also separate from one another, and liable to bifurcation. The condition, as seen in the present *Equisetum*, might be understood as attained by reduction of the coalescent and simple leaves, which became also alternate instead of superposed, while the assimilatory function was relegated almost entirely to the axis. But there is no certain proof that the actual evolution of *Equisetum* itself was along such a line as this.

¹ Nathorst, *Z. Foss. Flora d. Fälarländer*, i., Lief. 3, Taf. 7, 8.

The Calamarian strobili were terminal on the axes, but they had a more elongated form than is usual in *Equisetum* (Fig. 200): sometimes they

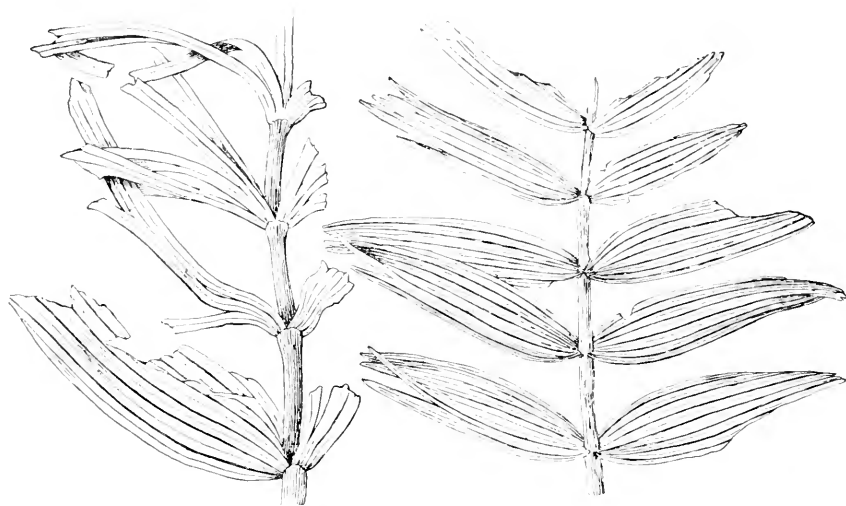

FIG. 198.

Schizoneura Godwanensis. Two-thirds the natural size. (After O. Feistmantel, from Engler and Prantl, *Nat. Pflanzenfam.*)

extended to a length of 30 cm. (Potonié). They differed also in their construction: the nearest to the *Equisetum*-type is the ancient *Archaeocalamites* (*Bornii*),¹ characteristic of the oldest Carboniferous strata, and of the upper Devonian

(Fig. 201). Its strobilus is essentially like that of *Equisetum*, having no sterile bracts intervening between the whorls of eight to ten sporangio-phores. These whorls did not alternate, but neither did the whorls of branched leaves in this early type. Here it would appear that there is a more complete differentiation of the reproductive from the vegetative region than is the case where, as in other Calamarians, sterile bracts are distributed throughout the strobilus.

The latter was the more prevalent type among the early Equisetales: in them the sterile leaf-whorls and the whorls of sporangio-phores regularly succeeded one another, as it is seen

in *Calamostachys*, and is well shown in *C. Binneyana*, which is the best known type (Fig. 202). The sterile whorls are commonly composed

¹ Renault, *Bassin Houiller et Permien d'Autun et d'Épinac*, vol. ii., p. 80, Plate 42.

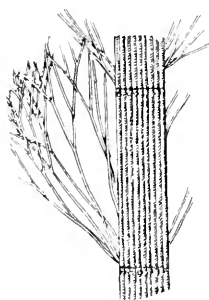

FIG. 199.

Astrocalamites scrobiculatus. Schlotheim (sp) from the culm. Fragment of a leafy shoot, reduced to half its natural size. (After Stur, from Zeiller, *Paläobotanique*.)

of twelve coherent leaves, but thirteen have been counted: the sporangiophores are usually six, that is, half the usual number of the leaves of the sterile whorls: but seven and eight have been seen in a single whorl of them, while no whorl of sixteen bracts has been seen. Hence it is clear that the sporangiophores bear no strict numerical relation to the sterile bracts. The position of the bracts in successive whorls of them alternates: the successive whorls of sporangiophores, on the other hand, do not alternate, "but are placed one above the other in vertical rows. Hence it is evident that their position can bear no constant relation to that of the bracts."¹

This absence of a strict relation of the sporangiophores to the bracts comes out also in *C. Ludwigi*, described in detail by Weiss.² He remarks of this species that the number of leaves in the sterile whorl is evidently variable: he made several countings, and concludes, "accordingly it may be accepted that there were sixteen leaves in the whorl, but that they might be reduced to twelve (or thirteen?) by abortion of some of them." The leaves of the neighbouring whorls certainly alternated. Of the sporangiophores he says, the number in each whorl is six, and the successive whorls of sporangiophores stand vertically above one another: but he notes slight deviations from this, perhaps due to torsion. A still further step is depicted by Weiss,³ in the case of *Calamostachys germanica*, where apparently the narrow bracts are approximately three times the number of the sporangiophores: but this is not specifically stated to be the case in the text.

On the other hand, it has been shown clearly in the case *Palaeostachya vera* that the number of bracts approximately corresponded directly to the number of sporangiophores, though possibly in some cases they somewhat exceeded



FIG. 200.

Palaeostachya pedunculata. Specimen from the coal-shales, showing a fertile shoot bearing about a dozen cones, and a few leaves. *k*=stem. About two-thirds natural size. (After Williamson, *Phil. Trans. Will. Coll.*, 1869.) From Scott's *Studies in Fossil Botany*.

¹ Williamson and Scott, "Further Observations on the Organisation of Fossil Plants, etc.," part i., *Phil. Trans.*, 1894, B, pp. 902-3. See also Scott, *Studies*, p. 47, etc.

² *Abhandl. z. Geol. Spezialkarte*, vol. ii., part i., p. 38.

³ *L.c.*, vol. ii., part i., Taf. xvi., Fig. 3 B.

it. In fact it is to be recognised that, speaking of the bracts, "a tendency to multiply the number of appendages in each whorl seems to have been

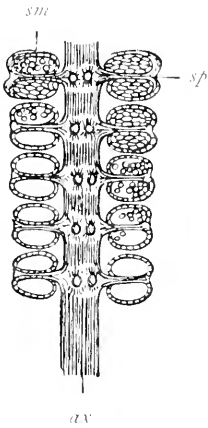

FIG. 201.

Archaeocalamites. Part of cone showing the axis (*ax*) in surface view, bearing superposed verticils of peltate sporangiophores (*sp*) without bracts. *sm*=sporangia. (After Renault.) From Scott.

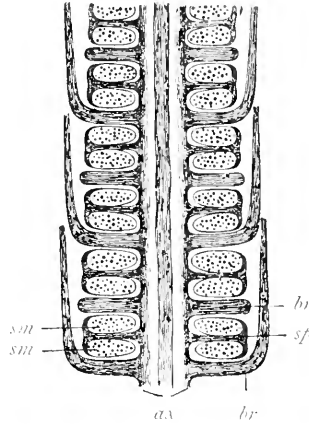

FIG. 202.

Calamostachys. Diagram of cone in radial section. *ax*=axis, which bears successive verticils of bracts (*br*), and peltate sporangiophores (*sp*). *sm*=sporangia borne on the sporangiophores. As the bracts are alternate with one another their upturned tips are only shown in every alternate verticil. (After Scott.)

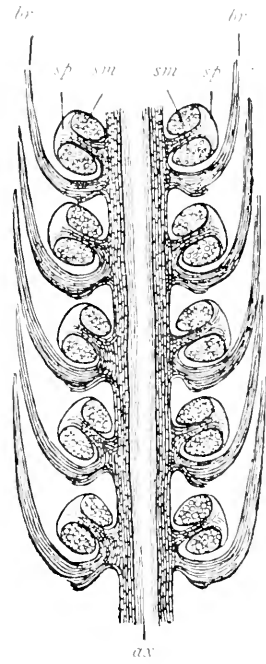

FIG. 203.

Palaeostachya. Diagram of cone in radial section. *ax*=axis, which bears verticils of bracts (*br*) with peltate sporangiophores (*sp*) in their axils. *sm*=sporangia. (After Renault.) From Scott.

a characteristic Calamarian feature."¹ There appears, consequently, to have been no constant relation either of number or of radial position between the bracts and the sporangiophores.

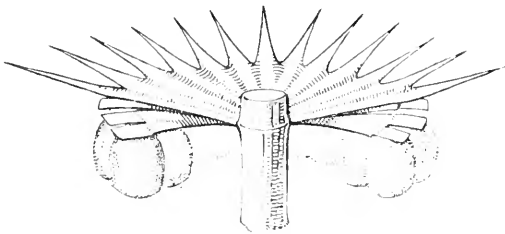

FIG. 204.

Cingularia typica, Weiss. From the Westphalian. Diagrammatic drawing of part of a shoot. 1, about 2. After Weiss.

The relation of these two parts as regards vertical position is also variable within the fossil Equisetales: for, as is well known, the sporangiophores occupy in *Palaeostachya* a position at the base of the internode (Fig. 203), in *Calamostachys*

¹Hickling, *Ann. of Bot.*, 1907, p. 882.

in the middle of the internode (Fig. 202), and in *Stachannularia* or *Cingularia* at the top of the internode (Fig. 204). Such facts as these, here only briefly sketched, must be taken into account in discussing the morphology of the strobilus of the Equisetales, and in deciding the true character of the sporangiophores. But before this is entered upon their detailed structure and development must be examined.

SPORE-PRODUCING MEMBERS.

Naturally the development of the spore-producing members can only be followed in the living genus, though from the similarity of their mature features to those seen in the fossils it is probable that there was substantial similarity in these also. In *Equisetum* the axis, which is about to produce a strobilus, ceases active growth in length, retaining a conical form: the sporangiophores arise upon it in acropetal order, as convex swellings (Fig. 205). The details show some variation in different species: they are here described for *Equisetum arvense* and *limosum*.¹ In the first stages the sporangiophores are not unlike the sterile leaf-sheaths, involving, as seen in longitudinal section, some six cells, which grow out with a fan-like tracery and repeated anticlinal walls (Fig. 206 A). This similarity has been used as an argument favouring the view that the sporangiophore and the bract-leaf are results of "metamorphosis" of essentially the same part, a point which will be taken up later. Single superficial cells near the margins of the convex outgrowths are early recognisable as the parent cells which give rise to all the essential parts of the sporangia, though adjoining cells also grow out together with these to form the sporangial body: the origin of the sporangium is thus of the eusporangiate type (Fig. 206 A, B). At an early stage there is active growth in the middle region of the sporangiophore, which results in an inversion of the young sporangia, so that they come to point with their apices towards the axis. Each parent cell first divides periclinal (Fig. 206 A): the inner cell gives rise only to a portion of the sporogenous tissue, the outer undergoes further division, first by anticlinal, later by periclinal walls (Fig. 206 B, C, D). The inner

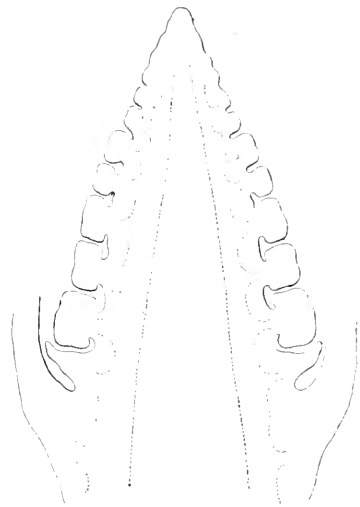

FIG. 205.

Half-developed strobilus of *Equisetum arvense*, in longitudinal section, taken at end of October. $\times 50$. (After Hofmeister.)

¹ *Studies*, i., p. 496, etc.

products thus formed share with the product of the inner cell already described in constituting the large sporogenous tissue, which, though entirely derived from the single parent cell, is not defined by its first periclinal wall: it is indicated by shading in the figures, while the products of the subsequent periclinal divisions are marked with a cross. Transverse sections at the stage represented in Fig. 207 A show the sporogenous tissue in a central position surrounded by several rather irregular layers forming the sporangial wall (Fig. 207 B). The size and construction of the sporangia, even of those in near juxtaposition, may vary greatly: this has been especially seen in the case of *E. limosum*. As the sporogenous group enlarges a layer of cells immediately adjoining it externally becomes glandular

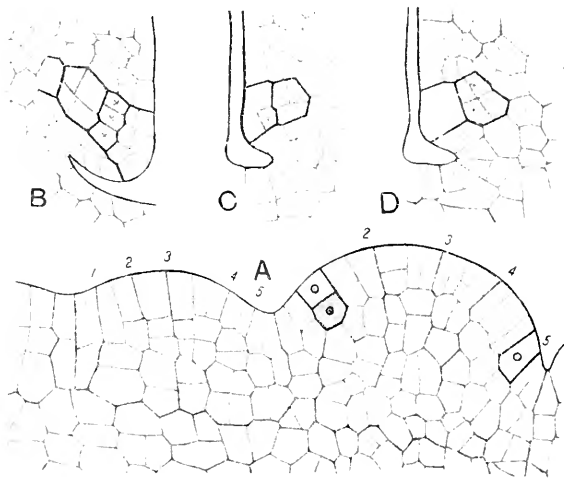

FIG. 206.

Equisetum arvense, L. A, radial longitudinal section of part of young strobilus, showing two sporangia in a very young state. B, C, D, individual sporangia, in older states, cut in median section. $\times 200$.

in appearance and develops as the tapetum (Fig. 208 A). Later the cells of the sporogenous tissue itself separate, and round themselves off as spore-mother-cells: but it is only about two-thirds of these cells which undergo the tetrad-division, about one-third of them shrivel, and become disorganised, their substance mingling with that of the tapetum, which becomes intrusive as a multinucleate plasma into the interstices between the spore-mother-cells (Fig. 208 B): the fertile cells which remain are nourished by this as they develop into the mature spores. Finally the superficial cells of the wall become indurated and spirally thickened, while those within it, excepting at the base of the sporangium, are disorganised. The mature sporangium, consisting thus of a single layer of cells of the wall, and containing the ripe spores which are all alike, dehisces along a longitudinal line facing inwards towards the stalk, which line had previously been defined by the cell-structure.

Each of the sporangiophores, from which the sporangia thus depend, is traversed from the stalk upwards by a vascular strand, which branches in the enlarged head, and each branch terminates immediately below the base of one sporangium. The sporangiophores are in close juxtaposition while young, and thus the sporangia are effectively protected. At the base of the strobilus lies the annulus, which completes the investment of the lowermost series of sporangiophores: it has as a rule no vascular supply (Fig. 209). Goebel has pointed out the protective biological use of the annulus:¹ also that at the apex the highest sporangiophores may be imperfectly developed and conrescent, thus forming a terminal cap: the protection of the young sporangia is thus very complete.

The number of sporangiophores in the *Equisetum*-strobilus is not strictly defined, while the number of sporangia on each sporangiophore is also variable: it is usually larger in *Equisetum* than in the Calamarians: this raises the question of evidence of variability of number of sporangia. There is in *Equisetum* no structural evidence of the septation of sporangia such as might lead to their increase in number, nor is there any interpolation of later sporangia between those first formed. In some of the larger cones, such as *E. maximum*, branched sporangiophores are commonly found, which appear to indicate a possible increase in their number by fission: the irregularity of their number and arrangement in these large cones would seem to support this (compare Fig. 195.) Excepting for such indications there is no evidence among living species of methods of increase in number of sporangia. Even the apical growth of the strobilus itself is, as a rule, strictly limited. Of reduction in number of sporangia there is as little direct evidence, but it is to be remembered that complete abortion leaves no trace of what has occurred (see Chapter X.). On grounds to be mentioned below it would seem probable that such complete abortion of sporangiophores has figured in the evolution of the Equisetales, contributing to the origin of the initial vegetative system of the individual plant.

The structure of the mature sporangiophore and of the sporangia in the Calamarians is so similar to that of *Equisetum* that, taken together

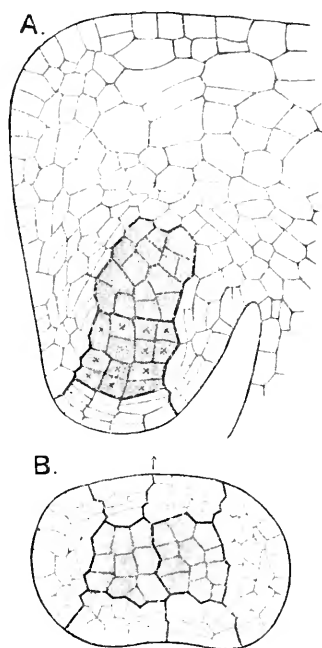

FIG. 207.

Equisetum argense, L. A, section traversing a sporangium in median longitudinal plane: the cells marked (x), like those in Fig. 206, are traced in origin from segmentation of superficial cells subsequent to the first perichlial division. B, a similar sporangium cut transversely. $\times 200$.

¹ *Organography*, ii., p. 500.

with their insertion directly on the axis, there can be no doubt of their true homology.¹ This is illustrated by Scott's figure of the sporangiophore of *Calamostachys Casheana* (Fig. 210), which shows the position and structure of the sporangia; but the number of the sporangia on each was, as a rule, only four. In some species there was heterospory, megasporangia and microsporangia being found even upon the same sporangiophore: this is illustrated by Scott in *Calamostachys Casheana*.² He has also noted in *C. Binneyana* the abortion of certain spores of the tetrad:³ this, taken with the condition as seen in *C. Casheana*, indicates that in the palaeozoic genus "we are able to trace how heterospory originated. The facts suggest that in the first instance a certain number of spores became abortive, and



FIG. 208.

A, apex of sporangium of *Equisetum limosum*, L., showing the sporogenous cells, surrounded by the tapetum (*t*), and sporangial wall. *B*, shows part of an older sporangium with its tapetum (*t*) still clearly defined, though the individuality of the cells is lost: within this the sporogenous tissue, of which certain cells (*a*) are abortive. $\times 200$.

so allowed of better nutrition for the remainder: this process, going on more freely in some sporangia than in others, may ultimately have rendered possible the excessive development of those spores that survived at the expense of the others, and may thus have led to the development of specialised megaspores.⁴ In this respect *Calamostachys* was in advance of *Equisetum*.

It has been shown above how completely the young sporangia are protected in the strobilus of *Equisetum* by the close aggregation of the sporangiophores, together with the covering afforded by the basal annulus and terminal cap. In the more lax strobili of the Calamarians the protection must have been chiefly carried out by the intermediate whorls of bracts, which overtopped the sporangiophores, a condition more nearly comparable with what is seen in other strobiloid types.

¹The relation of the strobili of the type of *Calamostachys* as regards their anatomy to the Calamitean stem has been pointed out by Scott; it will be unnecessary here to enter into the evidence on such questions: it suffices to refer to Scott, *Studies*, pp. 45, etc.

²Scott, *Studies*, Fig. 22.

³*L.c.*, p. 51.

⁴*L.c.*, p. 53.

It remains now to consider the morphological character of the sporangiophore in the Equisetales. The current view of the strobilus of *Equisetum* is that it is a product of metamorphosis of the sterile shoot, and that the sporangiophore is an altered sterile leaf. This has been re-stated lately by Goebel,¹ on the basis of development of the individual, but without bringing the fossil Calamarian strobili into the comparison. It may, however, be safely asserted that if *Equisetum* and *Equisetites* had never existed, a comparison of the Calamarian strobili with those of other Pteridophytes would have led to a different view: it will be necessary therefore to examine this natural group of the Equisetales as a whole, and not only one isolated genus, even though that type be the well-known one now living.

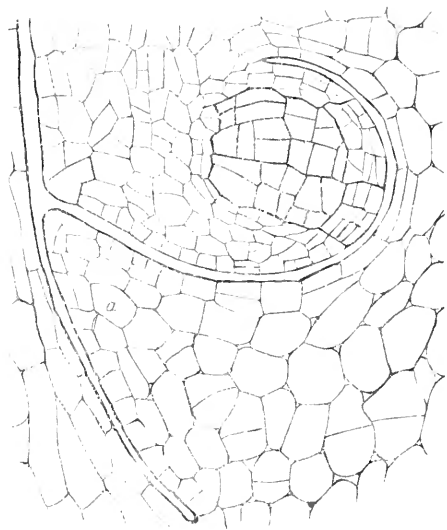

FIG. 209.

Equisetum limosum, L. Median longitudinal section of a sporangium at the base of the strobilus, together with the annulus (a). $\times 200$.

Taking first the developmental evidence derived from *Equisetum*, as

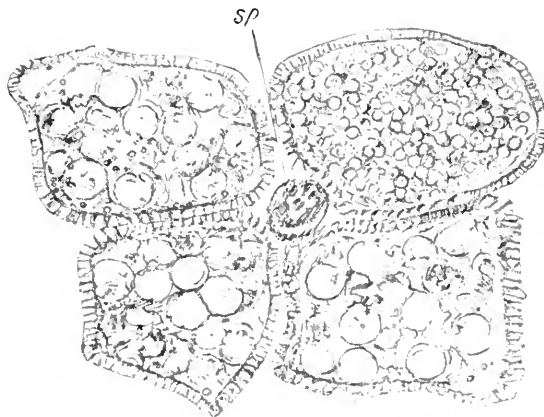

FIG. 210.

Calamostachys Cashiana. Tangential section, showing four sporangia grouped around their sporangiophore (sp). Three contain megaspores and one microspore. *Phil. Trans. W. and S. Wild. Coll.*, 1857. (From Scott, *Studies in Fossil Botany*.)

given by Goebel,² it is found that, notwithstanding the difference in mature form (which Goebel notes, and from which he concludes that the distinction

¹ *Organography*, vol. ii., pp. 490-503.

² *Loc.*, p. 500.

arose at an early date), the origin of the two bodies is alike: but the sporangiophore, which is the more bulky, soon adopts a mode of growth which leads to a shield-like form. He concludes that the simpler development of the sterile leaf was the more primitive type, and that the stronger growth of the lower surface of the sporangiophore, so as to give it the hypo-peltate form, is a new development. He also alludes to the transitional forms between the two types, such as have been described by Glück and others.¹

Before the homology of the leaf-teeth with the sporangiophores is accepted, the grounds upon which it is based are to be examined; they appear to be these:

- (1) Similarity of the cell-structure on first origin.
- (2) Similarity of position relatively to the axis.
- (3) Transitions, through the annulus and its malformations, from the one type to the other.

The similarity of structure of the two as shown in vertical sections was pointed out by Glück, though, as he himself remarks (p. 362), it holds only for the very earliest stages. But similarity of segmentation has long ago been shown to be no proof of morphological identity in the case of embryos and hairs: without going so far afield as this, a comparison of a vertical section through the leaf-margin of *Angiopteris*,² with a vertical section through its sorus,³ shows a near similarity of the cell-net: yet this does not suggest any homology of the leaf-margin with the lip of the sorus: and no more can the similarity of segmentation at the outset of that of the bract be held to prove the foliar nature of the sporangiophore.

Both sporangiophores and sterile leaves are lateral appendages of the axis, but this does not of itself prove the point—for instance, in plants which bear prickles, the prickles and the leaves occur together on the shoot: and the former arise not much later than the latter, while similar tissues take part in the formation of both. If both arose simultaneously close to the apex, the early distinction of them would be a matter of difficulty, though they are parts of different morphological character. It is possible thus to contemplate the origin of parts of similar cellular structure, but not morphologically comparable with one another, laterally upon the same axis.

The occurrence of middle forms between the teeth of the normal annulus and sporangiophores appears at first sight important evidence: but, as is well known, intermediate forms occur between ovules and foliage leaves, and, nevertheless, the opinion is widely, and in my view rightly,

Glück, "Die Sporophyll-Metamorphose," *Flora*, vol. LXXX., 1805, p. 364, and Plate 5. References are there given also to Milde and other writers.

² *Annals of Botany*, vol. iii., Plate 23, Fig. 71.

³ *Phil. Trans.*, B, 1807, Plate 10, Fig. 66.

accepted that the ovule, like other sporangia, is an organ *sui generis*, and not the result of modification of a leaf or leaf-segment. The occasional existence of sporangia, or even of imperfect sporangiophores upon the annulus, is not necessarily a proof of evolutionary transition from the one structure to the other, but is rather to be held as indicating that the primordium in its ontogenetic origin was not defined in its character.

The strength of the view stated by Goebel lies in the fact that it is supported by all three lines of argument above noted, and if it were not for the fossils, which he does not introduce into his discussion of the matter, it would probably not be called in question. But comparison with them suggests an alternative view, viz. that the sporangiophores are not of the nature of phyllomes, but are comparable rather with the sporangiophores of the Psilotaceae or Sphenophylleae; these they certainly resemble in form and function, though they differ from most of them in maintaining no strict relation of position to the true leaves. This suggestion must now be examined.

It is based primarily upon those Calamarian strobili in which each leaf-whorl is regularly succeeded by a whorl of sporangiophores. In the strobili the leaves of successive whorls show a radial alternation, as in the vegetative shoot, and it seems natural to suppose that they accordingly correspond to the ordinary succession of them in the vegetative region. But in addition to the sterile leaves the sporangiophores are present, and their presence does not disturb the alternate succession of the leaves. If the sporangiophores were rightly regarded as leaves, it might be anticipated that the alternate succession of the sterile leaves would be disturbed where the sporangiophores intervene between their whorls, but it is not. Again, though the number of the sporangiophores is frequently half that of the sterile leaves, that numerical relation is not strictly maintained, while their disposition in vertical, non-alternating series is on a plan apart from that of the alternating whorls of sterile leaves. Their position on the internode also, sometimes at the base, sometimes at the upper limit, often in the middle, again shows their independence of the sterile leaves. These facts together point to their being structures of a different nature from the leaves of the strobilus.

It may be asked how this non-phyllome theory of the sporangiophores is compatible with the facts in *Equisetum*, in which the annulus has usually been accepted as a transition from the foliage-whorls to the sporangiophores. It is true the annulus lies at the boundary between the sterile and fertile regions, and that in *Equisetum* no vestiges of leaf-whorls are found higher up among the sporangiophores. Goebel has pointed out an obvious protective use for the annulus, which would sufficiently account for its constancy and limited size in the genus.¹ A comparison of other types of Equisetineous strobili affords the following explanation of the *Equisetum* strobilus in terms of the fossils. In the genus *Archaeocalamites*

¹ *Organography*, p. 681.

(*Bornia*) Renault describes¹ for *B. radiata*, Brongn., how the fructifications are simple, or interrupted in their length by verticils of leaves, which render the spike itself, so to speak, articulated and of very variable length. The condition of these spikes is then different in proportion, rather than in essential points from that described for *Phyllothea* (Fig. 197), and so curiously reproduced in the abnormal *Equiseta* described above (Fig. 196). This again differs from *Calamostachys* mainly in the number of the sporangiophores which intervene between the successive leaf-whorls. The tracts which bear the sporangia being thus variable, it would appear that the *Equisetum*-type is merely an extreme case, in which the whole series of sporangiophores which form the terminal strobilus are collectively above the last leaf-sheath, and that last leaf sheath is of a reduced type, and appears as the annulus.

It is obvious that in the present state of our knowledge the case is not proved either for the phyllome-theory of the sporangiophore in the Equisetales, which is out of harmony with the known facts in the fossils, or for the non-phyllome theory, which is certainly a less obvious explanation of the simple strobilus of *Equisetum*. But the balance of evidence is strongly in favour of the latter, as without undue pressure it covers the whole area of facts, including those relating to the fossil Equisetales.²

¹ *Bassin Houllier d'Autun et d'Épinac*, p. 81.

² It is necessary briefly to mention another view, advanced by Jeffrey (*Mem. Boston Soc. of Nat. Hist.*, vol. v., pp. 184-5), as applicable to those Calamitean cones where the bracts in each whorl are stated to be double the number of the sporangiophores. He suggests that the pairs of the sterile leaves were really dichotomously divided dorsal segments of sporophylls, of which the sporangiophores were the ventral segments. It is necessary to remember, however, that in the best known cones of *Calamostachys* the bracts of successive whorls alternate, while the successive whorls of the sporangiophores, considered by themselves, are strictly superposed (Scott, *Progressus*, p. 158): this fact appears to be fatal to Jeffrey's suggestion, as will be obvious if the arrangement be plotted out diagrammatically in one plane. It will then appear that the proposed scheme would only apply to each alternate whorl of bracts, not to them all. There is also against it the fact that in the Equisetales at large the arrangement of the cone with the bracts approximately doubling the number of the sporangiophores is only one among several different arrangements: the proposed scheme is quite inapplicable for *Archæocalamites* or for *Equisetum*, and equally so for *Palaeostachya* (cf. Hickling, *l.c.*).

Akin to Jeffrey's theory, though not coincident with it, is that of Lignier (*Bull. de la Soc. Linn. de Normandie*, Caen, 1903, p. 162, etc.), which also is based primarily on the data for the cone of *Calamostachys*, and upon comparisons with the Sphenophylls. His view is that the sporangiophores in *Calamostachys* are the result of concrescence in pairs of fertile lateral lobes of the leaves forming the verticil. The anatomical facts are derived from Renault (*Bassin Houllier et Perm. d'Autun et d'Épinac*, iv., 2, p. 130, and Pl. ix.); the details shown in his figure, 6, of the single transverse section partially depicted would accord with the theory; but the evidence seems insufficient, and there are the following positive objections to it. First, there is no structural evidence in the sporangiophores themselves of *Calamostachys*, or in any other of the Equisetales, of the presumed fusion. Secondly, in the single drawing of a complete transverse section of the cone of *C. Zölleri* by Renault (*l.c.* Pl. ix., Fig. 5) there are 14 sporangiophores, but only 27 sterile bracts: so that the numerical relation does not hold in the one case on

ANATOMY.

For the purposes of the present discussion the chief points of importance in the anatomy of the Equisetales relate to the structure of the axis: the leaves and roots carry only a minor interest. It will suffice to say of the former that their structure in *Equisetum* points to a probability of reduction from a condition more effective in assimilation, which was their state in some at least of the Calamites. The roots of *Equisetum* are essentially of the Fern-type, though with some peculiarities of detail of their own: the roots of the Calamites show in their primary structure striking similarity to those of *Equisetum*, including the peculiar double endodermis; but they show in addition a cambial thickening, which is quite in keeping with the secondary growth of the axis which they support.

In discussing the structure of the axis the same order may be observed as in the external morphology, and the living genus *Equisetum* will be taken first. Transverse sections of the internode show the well-known disposition of the chief tissue-tracts, though with varying proportion and structure of the several tissues according to the species and the grade of the axis cut: viz. a peripheral epidermis, a broad cortex, and a central stelar region. The chief interest naturally centres in the tissues of the stele, and indeed it is unnecessary to discuss here the special characters of the superficial tracts. It may be noted first that the outer limit of the stele is not defined by the first apical segmentations: the inner cell cut off by the first periclinal wall in each segment of the apical cell forms only the pith, while the vascular tissues originate together with the cortex from the outer products of each segment.¹ But it has been seen that early segmentation is not a constant index of morphological character, and, accordingly, the stelar condition of *Equisetum* may properly be compared with that of other Vascular Plants, irrespective of its origin in the primary segmentation. The stele consists of a

which the whole theory is based. Thirdly, the same difficulty will arise from the alternation of the whorls of bracts, and the superposition of the sporangiophores as opposed to Jeffrey's suggestion. Fourthly, the theory is quite inapplicable to the Equisetales at large, as is admitted by Lignier (*l.c.*, p. 131). He himself suggests a different origin of the sporangiophore for *Equisetum* and *Archaeocalamites*, where they are held to represent whole leaves. These two hypotheses of origin of the sporangiophore put forward by Lignier seem too divergent to explain satisfactorily the nature of substantially the same part within the same natural phylum. Such difficulties are sure to arise where the attempt is made to reduce variable forms to a strict morphological scheme. This Lignier has done with some ingenuity for the individual case; but the more elastic view of the sporangiophore as a part *sui generis* appears to accord better with the natural facts. The sporangiophore may have a more or less definite relation to the sterile bracts, and it often has; but the facts for the Equisetal phylum do not indicate this as an obligatory relation. The nature of that relation will be best considered when corresponding facts from other sporangiophoric types are available (see part iii.).

¹ Campbell, *Mosses and Ferns*, p. 460.

large pith with a central cavity interrupted by diaphragms at the nodes: around it is disposed a ring of vascular strands of number varying according to the species, or according to the rank of the axis in question. They are separated laterally by broad parenchymatous rays, while the whole is surrounded in most species by a continuous endodermis (Fig. 211 A, B). There is, however, a good deal of difference in the disposition of the endodermis in various species, and these differences are of such a nature as to raise questions as to the validity of the simple character of the stele itself. The simplest case is that above described, and it may be seen in the aerial shoots of *E. arvense* and *palustre*, where there is a simple endodermal sheath of sinuous outline, formed from the innermost layer of the cortex: in fact, the arrangement is that most usual in Vascular Plants. In this case the term "stele" will naturally connote all that lies within that sheath. A second type is that seen in the rhizomes, but not in the aerial shoots of *E. sylvaticum* (Fig. 211 C, D), in which a second endodermis is present as a sinuous layer, forming an inner barrier of demarcation from the inner-lying pith. A third type is seen in the rhizomes of *E. hiemale* and some others, but not in the aerial stems of those species: it is characterised by each single strand being individually surrounded by a closed endodermal sheath (Fig. 211 E, F), while there is no general endodermis delimiting the whole stele. Such individual endodermal sheaths also surround the strands in the tubers of *E. arvense*, *sylvaticum*, and *palustre*, species in which, however, a general endodermis is found in the ordinary axes. The inconstancy of the arrangements thus seen, even in the different regions of the same plant, indicates them as special and secondary peculiarities, which need not seriously affect the conception of the stem as essentially monostelic. The fact that the differences of the endodermis do not otherwise affect the anatomy confirms this conclusion. It may then be held that the stem of *Equisetum* is monostelic throughout, but subject to disintegration of the stele.

The structure of the individual vascular strands, as seen in the transverse section of the internode, is fairly uniform in the different species. Each strand shows towards its central limit a canal designated "carinal," because it is on the same radius as one of the keel-flanges which mark the fluted internode externally (Fig. 211 C). These canals indicate the position of the protoxylem-strands, which become obliterated as the surrounding tissues expand in development: for the primary tracheides are unable to keep pace in their own growth with the expansion of the surrounding tissues, and accordingly break down. Close on either side of the margin of each carinal canal the annular thickenings of one or two or more tracheides remain to maturity, and permanently record the position of the protoxylem. As we shall see later, these are directly continuous with the protoxylem of the leaf-trace. Further out from the centre than the canal, and right and left of it, two other groups of xylem arise later:

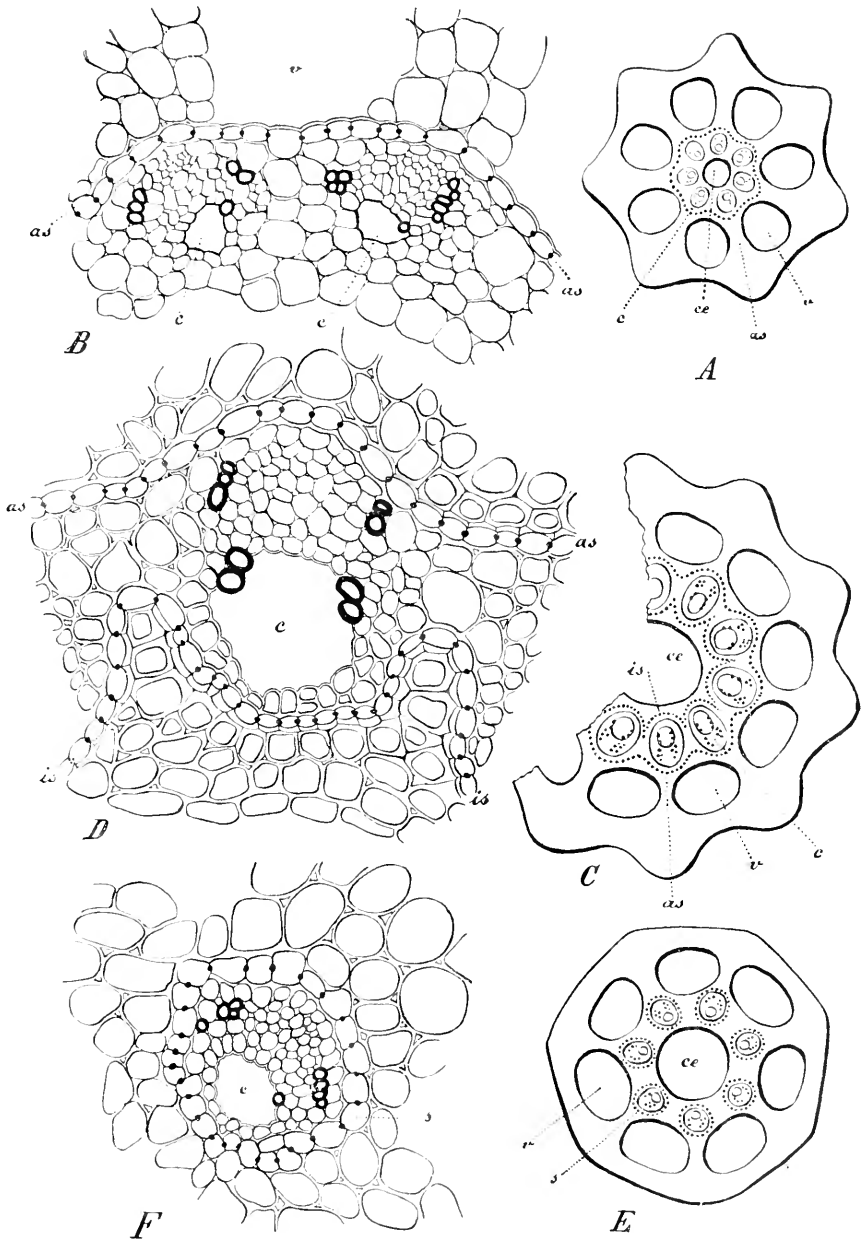

FIG. 211.

A, transverse section of the stem of *Equisetum palustre* ($\times 26$), and *B*, part of it $\times 100$. *C*, transverse section of the rhizome of *Equis. sylvaticum* ($\times 26$), and *D*, part of it $\times 100$. *E*, transverse section of the rhizome of *Equis. litorale* ($\times 26$), and *F*, part of it $\times 100$. *ce*=central cavity, *v*=vallecular canals, *c*=carinal canals, *s*=sheath of separate strands, *as*=outer, *is*=inner general endodermis; in *A*, *C*, and *E* the endodermis is indicated by a dotted line. (After Pfitzer.) From Rab. *Krypt. Flora*.

the number of the tracheides in these varies in different species (Fig. 211 B, D, F). It will be shown that these are not directly continuous with the xylem of the leaf-trace. The phloem lies between them, and consists of sieve-tubes and parenchyma.

If the vascular tissues be followed onwards into the nodes, the structure there displayed will give ground for a proper understanding of the internodal strands. Hitherto it has been customary to treat these as integral "vascular bundles" of the collateral type, comparable with the leaf-trace bundles of Phanerogams: they have been assumed to enter the axis from the leaves as integral bundles, and to pursue their course down one

internode, maintaining their identity as integral bundles to its base: there each was held to bifurcate, and the shanks to affix themselves right and left on the nearest lateral bundles which pass in at the lower node. This was the scheme contemplated by De Bary;¹ but it is a scheme characteristically Phanerogamic, and it has always presented difficulties of comparison with other Pteridophyte-types. An advance to a more intelligible view, based upon more exact analysis of the nodal structure, has been the result of the investigations of Gwynne-Vaughan.² to whom I owe the use of hitherto unpublished drawings, as well as the description which follows. He found that in *E. Telmateja*, of the three strands of xylem present in each bundle of the internode the carinal strand alone

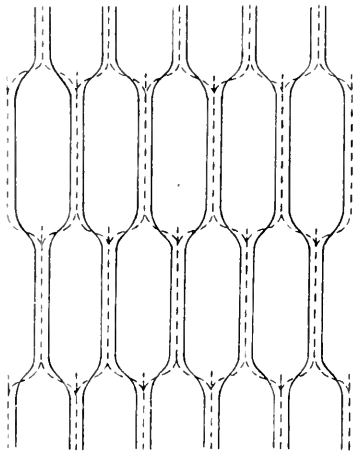

FIG. 212.

Diagram constructed by Mr. Gwynne-Vaughan to represent a tangential view of the vascular system of *Equisetum*. The dotted lines indicate the course of the true leaf-trace strands: the continuous lines indicate the cauline strands.

passes out at the node as a leaf-trace. The two lateral strands join on to the xylem of the nodal ring, where the xylem is much more amply developed than in the internode, and even shows some slight degree of secondary increase.³ In certain species (*E. hiemale*, and better still in *E. giganteum*) the lateral strands of the internodal bundles may be traced as externally projecting ridges over the nodal xylem into the internode above. In passing through the node they diverge from one another, so that in the internode above they are found on the adjacent sides of two different bundles. At the node above they approach each other, and in the next internode they both occur in the same bundle once again. The

¹ *Comp.-Anat.*, pp. 279 and 327.

² Gwynne-Vaughan, *Report Brit. Ass.*, Glasgow, 1901, p. 850; also *Ann. of Bot.*, 1901, p. 774.

³ Cormack, *Annals of Botany*, vii., p. 63.

leaf-trace protoxylem, having entered the bundle, runs downwards for one internode between but internally to the two lateral strands: at the node below it divides into two branches, which curve to the right and the left in order to fuse with the neighbouring leaf-traces that enter at this node (Fig. 212). So the xylem of the so-called vascular bundle of *Equisetum* consists of three strands, two of which are lateral and cauline, while the median or carinal strand is common to both stem and leaf. The fact that only a small portion passes out as a leaf-trace, and not the bundle as a whole, constitutes an essential point of difference between it and the bundle of a Phanerogam. The general conformation of the vascular tissue at the node, according to the above description, is shown in the diagram (Fig. 213).

The tracheides in each strand are very few, and consequently it is difficult to determine the direction of their development. However, as regards the leaf-trace and the carinal strand it appears clear that they are not exarch but endarch, or perhaps slightly mesarch on the adaxial side. The lateral strands, as a whole, are differentiated later than the carinal strand, but they do not seem to be a continuation of its centrifugal development. On the contrary, in *E. giganteum*, where as many as ten to fifteen elements are present in each lateral strand, the smallest of them are invariably at the outer extremity, and they gradually increase in size inwards. Longitudinal sections show that the largest tracheides are coarsely reticulate, with large pits and very broad bands of thickening between them: in the smaller elements the reticulation becomes finer and more regular, and in the smallest it closely resembles true spiral thickening. To state definitely whether the lateral strands are exarch or not was not possible in this species, because no incompletely differentiated portions of the stem were available: so the question must remain at present undecided, although the mature structure certainly gives a strong impression of centripetal development.

It is suggested by Gwynne-Vaughan that the lateral xylem-strands in the vascular bundles of the existing species of *Equisetum* may perhaps be taken to represent the last remnants of a primitive central mass: this would be in entire agreement with their apparently centripetal development, and in particular with their cauline course. The probability of this suggestion can best be gauged by comparison with the fossil Equisetales, and with other Pteridophytes. For *Calamites* the case has been succinctly



FIG. 213.

Diagram constructed by Mr. Gwynne-Vaughan to represent the conformation of the vascular tissue at a node of *Equisetum*. Above and below the node the groups of three strands, the median leaf-trace and the lateral cauline strands, are shown. In the centre the entry of a leaf-trace is shown, and its passage inwards to take its place nearest to the pith, while the cauline strands are lateral, and form the external parts of the composite vascular bundle.

stated by Scott:¹ he remarks that "the Calamite, so far as anatomy goes, is simply an *Equisetum* with secondary thickening." The secondary increase commences at the nodes, and extends thence through the internodes. This again adds point to the similarity with *Equisetum*, since the trace of secondary increase present in *Equisetum* is seen at the nodes, though it does not extend into the internodes. The result of the secondary growth in *Calamites* may be a woody mass of great bulk, and varying in the details of its structure: into these matters it is unnecessary to enter here: it will suffice to quote further from Scott² that "we may therefore express the general characteristics of the Calamarian vascular system by the statement that the whole arrangement is of the type of *Equisetum* but more varied, and sometimes more complex"; and, further, that³ "the position of the branches with reference to the nodes and leaf-traces was precisely the same in *Calamites* as in the recent *Equisetum*." Thus, as regards stelar problems the two stand together, and the hypothesis put forward by Gwynne-Vaughan for the elucidation of the stelar structure in *Equisetum* should find its application in *Calamites* also. It will now be shown that certain facts derived from these fossils strongly support it.

In his *Pflanzen-palaeontologie* (p. 205) Potonié established a comparison between the secondary vascular tissues of the Calamariae and the Sphenophyllaceae by mentally doing away with the central mass of primary xylem that exists in the latter. Gwynne-Vaughan suggested that by inverting this procedure, and considering it possible that the ancestors of *Equisetum* may have possessed a xylem that extended to the centre of the stem, one is led to derive their structure, as it exists at present, from the modification of a stele with a solid central mass of centripetal xylem such as that of *Sphenophyllum* or of certain *Lepidodendreae*. To illustrate the nature of the modifications that such a stele would have to undergo, a series of parallel developments was pointed out by Gwynne-Vaughan within the latter group, viz. *Lepidodendron Rhodumnense*, *Selaginoides Harcourtii*, *Sizyliaria spinosa*, and *Menardi*: here parenchyma appears in the xylem, and gradually increases in quantity until only an attenuated peripheral ring of xylem remains, which then becomes more or less broken up into separate strands. This suggestion raises the question whether any Calamarian stem is known in which the hypothetical primary xylem is better represented, and is shown to be centripetal in its development?

At the very same meeting at which Gwynne-Vaughan developed his theory Scott described a new species, *Calamites pettycurensis*, which gave the requisite answer. It comes from the Calceiferous sandstone of Burnt-island.⁴ The interest depends on the fact that each vascular bundle possesses a distinct arc of centripetal wood on the side next the pith. The carinal canals are present as in an ordinary Calamite, and contain, as usual, the remains of the disorganised protoxylem. They do not, however,

¹ *Studies*, p. 23.

² *L.c.*, p. 25.

³ *L.c.*, p. 31.

⁴ Scott, *Brit. Ass. Report*, 1901, p. 849.

as in other Equisetales, form the inner limit of the wood; but xylem of a considerable thickness, and consisting of typical tracheides, extends into the pith on the inner side of the canal, which is thus completely enclosed by the wood. Hence, starting from the spiral tracheides of the protoxylem, there was here a considerable development of the xylem in a centripetal as well as a centrifugal direction. This appears to be the first case of centripetal wood observed in a Calamarian stem; it serves to furnish a new link between the Palaeozoic Equisetales and the Sphenophyllales, and through them also with the Lycopods.

The question remains whether the young plant of *Equisetum* shows in its axis a structure indicative of a protostelic origin. Jeffrey¹ has traced the details for *E. hiemale*, and finds that the central cylinder of the first shoot makes its appearance as an unbroken tube of reticulated tracheides. There are no protoxylem elements, although the internal tracheides are formed first. The primitive axis, in fact, starts out with a similar organisation to that which is subsequently found to recur in the nodes. These facts, though not in themselves conclusive, would tally well enough with an origin of the shoot from a protostelic ancestry.

The facts and arguments contained in the preceding pages clearly indicate the line of comparison of the stelar state of the Equisetales with that of the other Pteridophytes. The axis is monostelic, as in other primitive forms. It presents the appearance of a mere attenuated remnant of the probable archaic state of the protostele. Comparison makes it probable that in place of the solid xylem-core, which is seen in other phyla to be the primitive condition, the central part has become parenchymatous: in the early fossil, *Calamites peltocurensis*, the change had advanced so far as to reduce the volume of the xylem, though a centripetal remnant still persisted, and serves to indicate the probability of a protostelic origin, comparable to that condition seen in some Lycopodiales and in the Sphenophyllales. In the ordinary *Calamites*, as well as in *Equisetum*, the change has advanced so far that only minute remnants of the centripetal wood are to be recognised, and that recognition would itself be uncertain were it not for the confirmation brought by the fossil from the Calcareous sandstone. But together the evidence appears conclusive, and the result is to place the Equisetales, which have so long been a structural problem, in line with other strobiloid forms: they, like the rest, have probably sprung from a protostelic ancestry. Physiologically the changes involved appear as a natural result of life in a semi-aquatic and muddy habitat, while the reduction of the leaves from effective assimilatory organs as they appear to have been in the early *Calamites*, to the protective sheaths of *Equisetum*, would also harmonise with the anatomical change contemplated.

The leaves and the sterile bracts of the strobilus in the Equisetales are supplied with simple strands, which call for no special remark. But

¹ *L.c.*, p. 171.

some curious features have lately been disclosed for the strands entering the sporangiophores. In the case of *Palaeostachya vera*, where the sporangiophores in each whorl approximately equal the bracts, and are apparently axillary, the strand for each originates immediately above the bract-bundle; it does not, however, pass out, but ascends with the main bundle of the axis through half the internode: it is then sharply reflexed, and drops again to the upper limit of the nodal disc, whence it passes outwards to the sporangiophore.¹ In *Calamostachys* the course seems to be the same, but with the points of difference that the sporangiophore-trace drops less than in *Palaeostachya*, in accordance with the position of the sporangiophore, and that *Calamostachys* has commonly two bracts to each sporangiophore, the latter being inserted in a plane between them. The anatomical condition in *Stachannularia* and *Cingularia* is unfortunately unknown: so far as the facts are available they indicate that the vascular supply of the sporangiophore is regularly derived from the bracteal node next below. This suggests a certain anatomical relation of the sporangiophores to the bracts in Calamarians at large; but the details of that relation are variable, and they cannot be held to support any general theory of lateral fusion of leaf-segments to form the sporangiophores, such as that suggested by Lignier in the case of *C. Zeilleri*. As regards the position of the sporangiophore on the internode, the anatomy, so far as known, appears to indicate the condition of *Calamostachys*, with its sporangiophore halfway up the internode, as a central type: and that while *Cingularia* probably shows an exaggeration of this displacement, so that the sporangiophores appear immediately below the bracts of the next upper whorl, *Palaeostachya* is a modification of the *Calamostachys* type in the opposite direction, so that the sporangiophores are axillary in position.²

EMBRYOLOGY.

The archegonium of *Equisetum* lies with the neck directed upwards. The basal wall, which first segments the zygote, appears approximately horizontal: the embryo is thereby divided into epibasal and hypobasal halves: the shoot arises from the former, the foot from the latter. There is some conflict of evidence as to the place of origin of the first root: it is referred by Sadebeck to the hypobasal half in *E. arvense* and *palustre* (Fig. 214);³ but Jeffrey traces the origin of the root to the epibasal half in *E. hiemale*, though with some uncertainty; but in any case it arises high up on the side of the embryo in that species, and in close relation to the primitive shoot.⁴ The absence of a suspensor simplifies the embryogeny. As in the Lycopodiales, so here also it will be found

¹Hickling, *loc. cit.*, p. 375.

²Compare Scott, *Progressus*, i., pp. 160-161.

³See Engler and Prantl, *Nat. Pflanzenfam.*, i. 4, p. 520, where the literature is cited.

⁴*Mem. Bot. Soc. of Nat. Hist.*, vol. v., No. 5, p. 108.

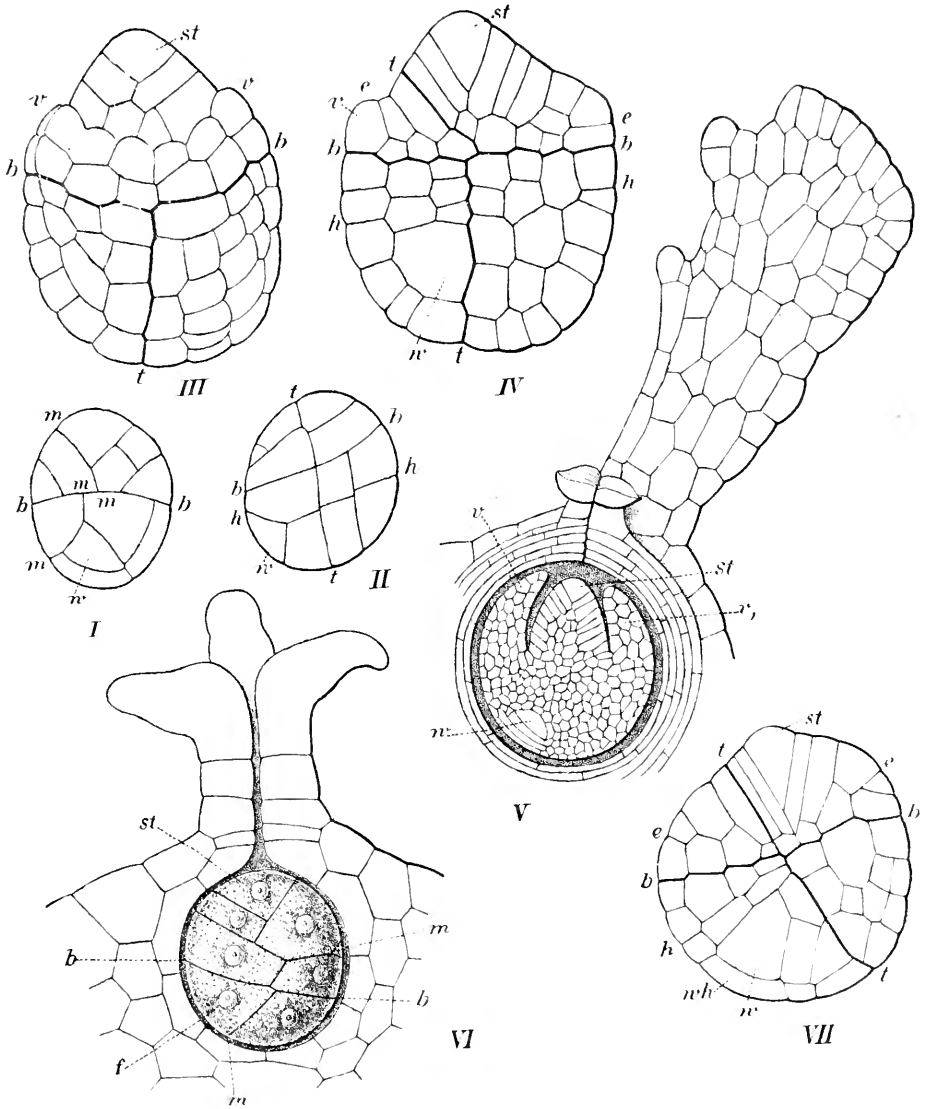

FIG. 214.

Embryo of *Equisetum*. I-IV., *Equisetum arvense*, L. I. and II., the same embryo in different positions; in I. the median wall is visible, in II. the transverse wall. $\times 250$. III-IV., a more advanced embryo showing development of the stem and leaf-sheath. $\times 250$. V., an embryo still further developed, but not dissected free from the prothallus, and showing the orientation relatively to the archegonium. *st* = the stem apex; *v* = the first leaf-sheath; *n* = the root. $\times 68$. VI. and VII., *Equisetum palustre*, L. VI. = young embryo still in the archegonium, stem and foot are visible. $\times 300$. VII. = an embryo further advanced, and dissected free, and orientated 90° as compared with VI. The root (*n*) and stem (*st*) are visible. $\times 300$. *b* = basal wall; *T* = transverse wall; *m* = median wall; *e* = epibasal and *h* = hypobasal region; *v* = the first leaf-sheath. (After Sadebeck, in Engler and Prantl. *Nat. Pflanzenfam.*)

essential to a proper understanding of the embryogeny to fix the attention primarily upon the origin of the apex of the axis, which is defined at a very early stage in *Equisetum*. The epibasal half of the embryo is described as dividing into octants by walls at right angles to one another: one of the octants then takes the lead over the others, and it is this one which gives rise to the axis, with its tetrahedral apical cell like that in the mature plant: the product of this octant soon constitutes the greater part of the epibasal region (Fig. 214 IV.). A little consideration of the facts thus stated will show, first, that the octant-walls are the natural preliminary steps to the definition of a tetrahedral initial cell centrally in the epibasal hemisphere: the octant-walls might even be held to be themselves the first segmentations in the definition of that cell; secondly, that, consistently with the initiation of a conical initial cell, the origin of the axis is in the closest possible relation to the point of intersection of the octant-walls, just as it is found to be in the Lycopodiales. There is, however, this difference, that the apex asserts itself very early in *Equisetum*, which is in accord with the early dominance of the axis over the appendages. These arise as three (or sometimes only two) leaf-teeth, borne upon a coalescent sheath, which is described as originating partly from the remaining three octants of the epibasal half, but partly also from the lower portion of that which gives rise to the apex of the axis itself. It seems quite unnecessary in such a case as this to attempt to allocate the several parts to definite octants: clearly if the leaf-sheath be partly derived from the stem-octant, this is not rightly so named. Probably the allocation of parts to definite octants would not have been attempted in *Equisetum* had it not been found to apply with apparent success elsewhere, and especially in the Ferns. In the present case it seems more natural to regard the whole epibasal hemisphere as formative of the shoot: from this the stem-tip originates at the central point by the simplest course of segmentation, which happens to involve octant-walls, while the peripheral region of the epibasal hemisphere gives rise to the first leaf-sheath with its three teeth. The shoot thus established continues its apical growth directly upwards, forming successive three-leaved sheaths, followed soon by the appearance of accessory branches. The hypobasal half of the embryo meanwhile becomes slightly distended, as the "foot," which remains in contact with the prothallus after the young plant emerges. The root originates laterally in the hypobasal hemisphere in *E. arvense* and *palustre* (Fig. 214), but in *E. hiemale* it appears to be formed laterally at some distance from the base, and even from the epibasal hemisphere.

This embryogeny accords readily with a strobiloid theory. The apex of the axis arises early at the usual point in close proximity to the intersection of the first octants, and it is dominant from the first. The leaves, which are minor appendages in the mature shoot, arise relatively late, and are not prominent features in the embryogeny. The branching is clearly accessory, as it is also relatively late in the time of its appearance.

It has been seen in the Lycopods that the root is constant neither in the time nor in the place of its appearance: it has been also seen that it originates in the epibasal region in *Lycopodium* and *Isoetes*, but in *Selaginella* in the hypobasal. It need therefore be no cause for surprise, but rather of increased interest that the point of origin of the first root should fluctuate within the genus *Equisetum*. Its indefinite position in different cases stamps upon it with special clearness the character of an accessory to the shoot itself, which its late appearance in certain Lycopods seems further to confirm. The whole embryo thus consists of a spindle-like axis with continued apical growth; its base is like that of *Isoetes* without any suspensor. The leaves and roots appear as appendages upon this spindle-like axis.

Naturally, the embryogeny of the fossil Equisetales is not accessible for comparison.

From the account of the Equisetales given in the above pages, it is possible to form some idea of a primitive general type for the phylum. They were probably, from the first, organisms with a prominent axis, while the leaves, of moderate size, were arranged in whorls, with elongated internodes between them. The root was an accessory addition to the shoot. Spore-production, which is so important an event in the antithetic alternation, does not figure in the early stages of life in any known Equisetal type, but appears only late in the individual life. There is little direct evidence among the Equisetales of any deferring of spore-production, by abortion of sporangia or of sporangiophores, comparable with that which is so clearly indicated in the Lycopodiales. But comparative evidence shows that in the Equisetales spore-production is not restricted to branches of any definite rank, and transfers of the reproductive function from branches of one rank to those of a higher rank may occur in nature, and are illustrated in various living species of *Equisetum*. This, coupled with the fact that there is essential structural similarity between axes of all ranks in these plants, makes it seem probable that axes of lower rank, and finally even the primary axis itself, may have been fertile in a primitive Equisetoid type: that a deferring of spore-production by transfer from axes of lower to those of higher order occurred, and that thus the initial vegetative system was greatly extended. In the Calamarians a secondary development of tissues in the axis accompanies the enlargement of the vegetative system, which thus attained dendroid characters, now only faintly reflected in the smaller living forms.

It would appear from the elongated form of the lax cone in such types as *Calamostachys*, and especially from the usual intermixture of bract-leaves and sporangiophores in them, that among early Equisetal types a condition existed not unlike that of the undifferentiated Lycopod shoot of the *Selago* type: that is, a general-purposes shoot, in which the office of spore-production was not strictly differentiated from the function of nutrition,

in point of fact bract-leaves and sporangiophores are associated together in Calamarian strobili: these may typify the primitive shoot as the strobilus of *Lyc. selago* does that of the Lycopods. A separation of these appendages might be effected in ways which are here suggested by analogy with other phyla, rather than by direct observation in this. In the Lycopodiales it has been seen that abortion of sporangia occurred in certain regions, which thus became more effectively vegetative: such abortion of sporangiophores would produce a vegetative region in place of a Calamarian strobilus. On the other hand, abortion of the bracts in the strobilus would produce the condition seen in *Archaeocalamites* or in *Equisetum*: moreover, in the Equisetales, where the sporangia are borne upon sporangiophores with enlarged distal ends, such protective structures are not required in cases where the sporangiophores are crowded; in fact the abortion of the whole bract-leaf in the specialised strobilus would bring with it no biological difficulty. It seems probable that both of these factors may have been effective in producing the conditions shown among the Equisetales. In the Calamites the chief distinction between the strobilus and the vegetative shoot is in the absence of the sporangiophores in the latter. It is true that no observations of vestigial sporangiophores have been recorded, but it is to be remembered that where abortion is complete no record remains of what has happened, and that this is the case in many Lycopods where there is good reason to hold that abortion of sporangia has occurred. It seems probable, then, from comparison of strobili and vegetative shoots, as well as from analogy with the Lycopods, that abortion of sporangiophores will account for the distinction of the strobili from the vegetative region in *Calamostachys*.

But in other cases the segregation of leaves and sporangiophores was more fully carried out. In *Phyllothea* successive fertile zones appear, interrupted by whorls of sterile bracts. On the other hand, the strobilus of *Equisetum* is without sterile bracts at all: this condition, which may be held as the more advanced, is shared by *Archaeocalamites*. It is, however, uncertain how the Equisetoid type of strobilus arose: possibly it was without bracts from the first: but more probably it originated by the complete disappearance, from the fertile head, of bracts originally present: in this case the annulus, which survives as having a biological value for protective purposes, may be held to represent the last remnant of the series of abortive bract-whorls. The evidence for such progressive separation of the vegetative and reproductive functions is not so conclusive in the Equisetales as it is in the Lycopodiales: but the facts, so far as they go, are at least in accord with a theory of such a process acting on a shoot in which the two functions were originally combined in a manner similar to that seen in other primitive Pteridophytes.

As in many other phyla, terminal bifurcation of the axis is seen, but here it appears only as a rare abnormality. The normal branchings are accessory in their origin, and are effective as reduplications of the

original shoot. The appendages spring laterally below the apex of the axis, but even in extreme types they never attain to very great dimensions. An interesting point is the dichotomous branching of the leaf in early forms: this is important for comparison with other phyla, and will have its place especially in the comparative morphology of the strobili.

It is possible to account for even the most complex types of the Equisetales as resulting from advances along the lines of ramification and of progressive sterilisation above indicated, but starting from the simple shoot with its appendages. With this view of the general Equisetal morphology the development of the embryo of *Equisetum* coincides, the axis taking the lead from the first, while the variability of position of the first root is a further indication of its accessory character. Finally, the vascular anatomy, so long held to be Phanerogamic in its character rather than Pteridophytic, is now shown to be referable in origin to a primitive monostele: the structure in the known forms is far removed, it is true, from the condition of a solid xylem-core; but it has been shown that the structure of the xylem that remains is clearly indicative of origin from a primitive type of monostele. These characters taken collectively point in no uncertain way to a strobiloid origin of the Equisetal sporophyte.

CHAPTER XXVIII.

II. SPHENOPHYLLALES.

THIS second phylum of the sporangiophoric Pteridophytes includes the title-family of extinct fossil plants, the Sphenophylleae, and associated with them, though perhaps somewhat aloof, as differing in certain important features, is the living family of the Psilotaceae: this contains the genera *Psilotum* and *Tmesipteris*. Certain other imperfectly known fossils may also find their best place in this relationship. The Sphenophyllales are characterised by having a dominant axis, with protostelic structure, which bears leaves of moderate size, with more or less furcate branching, and arranged either in whorls (*Sphenophyllum*) or alternate (Psilotaceae). An important distinctive character is the insertion of the sporangiophores not directly on the axis, but upon the appendages: they are thus marked off clearly from the Equisetales, notwithstanding that they have many points of resemblance to them: these points are more marked in the Sphenophylleae, while the relation of the Psilotaceae is rather towards the Lycopodiales. The whole phylum thus occupies an intermediate, or perhaps a central position, which gives its study a very special interest.

A. SPHENOPHYLLEAE.

This ancient and long extinct family is represented according to present knowledge by the undivided genus *Sphenophyllum*: but associated more or less distinctly with it is the complex strobilus known as *Cheirostrobus*. The Sphenophylleae as at present known dated from the Calciferous Sandstone series of the Lower Carboniferous formation, and extended upwards to the Permian. They were plants of straggling habit, with the usual vegetative region preceding the spore-producing parts: these were commonly borne upon definite terminal strobili, but at least one case is known where the definition of the vegetative and reproductive regions was less clearly marked. In the case of *Cheirostrobus* the vegetative region is still unknown

The vegetative system of *Sphenophyllum* consisted of a slender axis (Fig. 215), with elongated and fluted internodes intervening between successive superposed whorls of leaves, which in the cone, and sometimes in the vegetative region, were more or less webbed below. The branching of the shoot was irregular and monopodial: the branches were isolated and apparently axillary,¹ though it seems uncertain whether they were not actually, as in *Equisetum*, inserted between two of the whorled leaves rather than in the axil of one.

The leaves in each whorl numbered, as a rule, some multiple of three, six being a frequent number, though as many as twelve, or even eighteen, may be found in some species. They were commonly wedge-shaped, and more or less forked in the venation, with very various cutting extending more or less deeply between the forks. In some of them, and especially in the early forms, the leaves were divided into linear or even filamentous segments (Fig. 216, A, B.). Potonié points out² that the earliest forms had narrowly linear, branched leaves, those of later occurrence had larger, more broadly wedge-shaped, and unbranched leaves: thus the size of the leaf increased in the rising geological scale, while the branching of it fell off. But, on the other hand, a striking feature illustrated in the well-known *S. cuneifolium* was the heterophyllous character.

Here on the same plant finely cut leaves may be found below and broader, wedge-shaped leaves above, while in the strobilus the leaves are again finely cut (compare Fig. 215). Commonly the members of one whorl were equally developed, but in the forms from the Glossopteris Flora, named *Trizygia*, they were unequal. Examples of the leafage of different types of Sphenophylls are shown in Fig. 216, A, B, C, D. The plants were fixed in the soil by diarch roots, which appear to have been borne on the nodes: but the details regarding them are imperfectly known.³ The whole plant seems to have been of a weak, straggling character.

The internal structure possessed greater distinctiveness than the external form, and showed a marked secondary thickening: this originated very



FIG. 215.

Sphenophyllum sp., branched stem, bearing linear and cuneate whorled leaves on different parts. The branch (a) terminates in a long and slender cone. Half natural size. (After Stur, from Scott's *Studies in Fossil Botany*.)

¹ Scott, *Studies*, p. 82. ² Engler and Prantl, i., 4, p. 516.

³ Scott, *Studies*, p. 92.

early, so that the unaltered primary state is seen only in small twigs. Here a protostelic structure is seen, without any pith or conjunctive parenchyma. The primary xylem is of triangular form, the groups of protoxylem, either single or double, being at the projecting angles; or the angles may be duplicated, and a hexarch form be attained. The vascular system is strictly cauline: it passes through the nodes without any appreciable change of structure, a point of interest for comparison with the Equisetal structure as interpreted by Gwynne-Vaughan.¹ A peculiarity of some importance for further comparison is shown in the primary wood

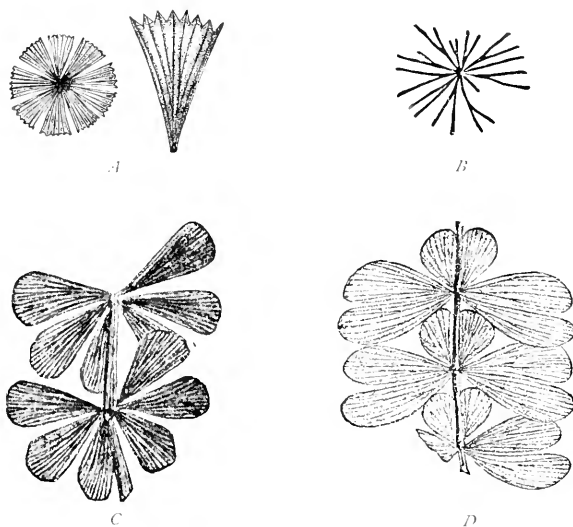

FIG. 216.

A—a leaf-whorl of *Sphenophyllum cuneifolium*, and one leaf of it somewhat enlarged. B—a leaf-whorl of *Sphenophyllum tenerrimum*. C=*Sphenophyllum verticillatum*. (From Potonic's *Lehrbuch der Pflanzenpaläontologie*.) D="Tri-zgia" *speciosa*. Royle, from the *Glossopteris*-facies, (after O. Feistmantel.)

of the ancient species, *S. insigne*, from the calciferous sandstone: here a canal is formed at each of the three angles of the primary wood, presumably by disorganisation of the protoxylem, as in the Equisetales² (Fig. 217). The cambial activity commences immediately outside the primary wood, and results in a broad zone of secondary wood, which completely surrounds the primary: it is traversed by continuous medullary rays in *S. insigne*, but in the later species these are represented only by little groups of thin-walled cells, which form, nevertheless, a continuous system. Outside the wood lie the phloem and the cortex, the latter showing a formation of periderm, which may be repeated, resulting in a scaly bark.

¹ Compare Williamson and Scott, *Phil. Trans.*, vol. clxxxv., part. ii., p. 922.

² Scott, *Studies*, p. 88.

The leaves appear both from their size and from their structure to have been the assimilating organs, while the axis took little part in that function. Their parenchymatous tissue was, however, mechanically strengthened by bands of sclerenchyma. The vascular strands given off at the nodes usually branched within the cortex of the stem into strands which passed out as the veins of the leaf, though in some cases a single strand entered the leaf.

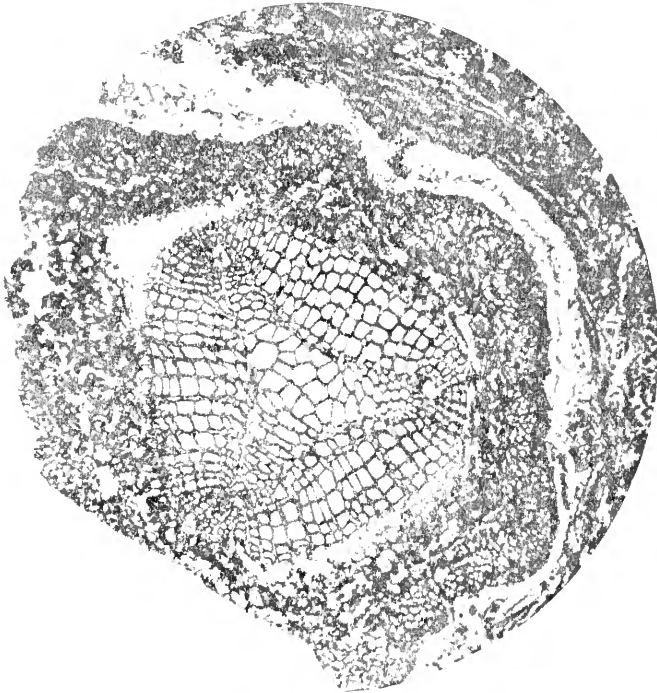

FIG. 217.

Sphenophyllum insignis. Transverse section of rather young stem, showing triangular primary wood with a canal at each angle, marking the protoxylem, then secondary wood, remains of phloem, and the primary cortex showing two of the furrows. \times about 30. From a photograph, *Phil. Trans. W. and S. Will. Coll.*, 919. (Block from Scott's *Studies in Fossil Botany*.)

The strobilus of *Sphenophyllum* was constructed on a plan similar to that of the vegetative shoot, with slight structural differences, and with the additional fact that the spore-producing parts are present. These took the form of sporangiophores, resembling in their main features those of other sporangiophoric Pteridophytes. The most obvious differences between the strobilus and the vegetative shoot are that the internodes are shorter, and the leaves, which are elongated as before, frequently show a distinct webbing below. The result is that the whole cone appears externally as a compact body, with the sporangiophores very adequately protected till mature (compare Fig. 215). The various fossils described under the generic name of *Sphenophyllum* show differences of detail in the number

and position of the sporangiophores, as well as in the number of the sporangia borne by each of them. These differences offer curious analogies to those of floral construction in Angiosperms: but the latitude of variation here shown is such as would in Angiospermic flowers form the basis of much wider distinctions than those of species, or even of genera. It is not improbable that upon this basis the genus will ultimately be broken up, as detailed knowledge of it increases: meanwhile the following types of disposition of the sporangia have been described.

The simplest is that seen in *S. trichomatosum*, Stur., from the Middle Coal Measures, where the sporangia appear solitary near to the axils of the subtending bracts, which were here of very narrow form. It is an open question whether the single sporangium was here really sessile, or was borne upon a vascular stalk, as in other species, but in this case exceptionally short. The evidence derived from impressions does not suffice to decide this point (Fig. 218). From the guarded statements of Zeiller,¹ it appears probable that a similar disposition of the sporangia is found also in *S. angustifolium* and *tenerrimum*, and it may be noted that these are all small species with

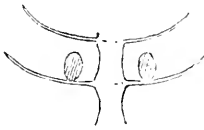

FIG. 218.

Sphenophyllum trichomatosum, Stur. Diagrammatic figure of the arrangement of the sporangia. (After Kidston.)

narrow leaves. In the well-known *S. cuneifolium*, Stern (*S. Dawsoni*, Will. and Scott), each sporangium, single as in the foregoing species, is borne upon an elongated pedicel—the sporangiophore. The sporangiophores in this case are, as a rule, twice as many as the bracts of the subtending whorl: each is traversed by a vascular strand which terminates at the base of the sporangium. The sporangiophores are inserted close to the base of the leaf-verticil, which is here webbed into a wide cup: and to this the pedicels may be adherent for varying distances upwards (Fig. 219). The vascular supply of the sporangiophores is derived by branching from that of the subtending bract, of which they thus seem to be appendages. In the regular cases the foliar strand on entering the verticil divides into three, the single lower branch supplies the bract, while the other two enter the two sporangiophores.² A further complication is seen in *S. Römeri*, Solms Laubach, for in this cone two sporangia are borne on each sporangiophore, hanging down from its peltate distal end. The sporangiophores are disposed in three concentric verticils on each whorl of bracts, and are attached by short stalks traversed by a vascular strand, which branches to supply the two sporangia (Fig. 220). The analogy with the sporangiophore of the Equisetales is more obvious here than in the previous cases, where only a single sporangium is borne on each. But it appears still more plainly in *S. majus*, Brongn., from the Middle Coal Measures, but as yet known only from impressions. This species is

¹ *L'Appareil Fruct. d. Sphenophyllum*, pp. 31, 32.

² For details, see Scott, *Studies*, p. 93, etc.

interesting from the fact that its strobilus is not a strictly definite one (Fig. 221). The number of the leaves in the whorl of the vegetative region is not constant: six to eight have been observed by Mr. Kidston.



FIG. 219.

Sphenophyllum Dawsoni. Obliquely transverse section of a cone, showing parts of three whorls of bracts. *a''* = hollow axis (stele missing); *b, d'* = cortex of axis; *c, c'* = bracts cut at different levels; *f* = sporangiophores, the innermost just springing from a whorl of bracts, which are here coherent; *f'* = sporangiophores in connection with their sporangia; *g, g', g''* = sporangia of the three whorls. $\times 7$. After Williamson, *Phil. Trans. Will. Coll.*, 1940 B. (From Scott's *Studies in Fossil Botany*.)

The branching of the leaves is variable, and even the two halves of one leaf may be unequal: the sporophylls are especially narrow as compared with the foliage leaves. The strobilus is characterised by the shorter length of the internodes, though this is variable also in the vegetative region: a gradual transition occurs at the limits of the fertile tract, but without any sudden alteration of the size or form of the leaf: the sporophylls stood out from the axis just like the ordinary foliage leaves, but

were united at the base into a narrow sheath or collar surrounding the axis. The transition to the strobilus is plainly seen at the lower limit of the large specimen from the Brussels Museum, described and figured by Kidston: towards the upper limit of the specimen, where the sporangia cease, the axis is continued in the vegetative manner, with longer internodes. These facts plainly point to the absence of a highly differentiated strobilus, and the existence in this species of a "*Selago*" condition, where the fertile region is a mere zone on a continued axis. Not

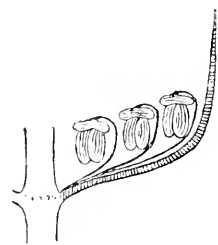

FIG. 220.

Sphenophyllum Roemerii. Diagrammatic sketch of the arrangement of the sporangia. (After Kidston.)

only does *S. majus* stand as yet alone in the genus by the indefiniteness of its cone, but also in the character of its sporangiophores. One of these is borne near to the base of each forked sporophyll (Fig. 222): the sporangia, which are 4-6 in number, but usually four, are grouped round a central attachment: and though no elongated pedicel can be seen, still the fact that when they are removed from the bracts they still remain united in groups of four to six indicates that they had a common base. In favourable cases Kidston has been able to demonstrate that a radial line of dehiscence is clearly marked,

corresponding in position to that of the synangium of *Psilotum*, to which the whole structure shows a remarkable resemblance. As a last type, and not the least remarkable of this variable genus, may be mentioned the fructification of *S. fertile*, recently described by Scott.¹ It is characterised by the fact that both the "dorsal and ventral lobes are fertile," by which is meant that the bract bears sporangia as well as the sporangiophore, which it subtends. Dr. Scott remarks that this is "more probably due to special modification than to retention of a primitive condition." With this opinion I readily concur, adding the further comparison of this condition with the common variation of *Botrychium Lunaria*, where the sterile leaf is often partially, or even completely fertile (compare Fig. 85).

Lastly, there remains to be described that remarkable cone from the Calciferous Sandstone of Burntisland, named by Scott *Cheirostrobos*, and placed by him in relation to the Sphenophyllales, while recognising also its affinities with the Equisetales and Lycopodiales.² The vegetative system of the plant of which this is the fructification is still unknown. The cone itself is of large size, and shows greater complexity than any of the known sporangiophoric types. The robust axis shows structural characters suggestive of a Lycopodinous rather than of a Sphenophylloid affinity: the central stele in transverse section has a solid star-shaped xylem-core, with twelve projecting protoxylem-groups, corresponding to the series of sporo-

¹ *Proc. Roy. Soc.*, Dec., 1904, and *Ann. of Bot.*, xix., p. 168, also *Progressus Rei Botanicae*, i. p. 151.

² Scott, *Phil. Trans.*, vol. 189 B, 1897, "On *Cheirostrobos*."



FIG. 100.

Slab showing fertile shoots of *Sphenophyllum majus*, Bronn, sp. After a photograph from the specimen in the Musée roy. d'hist. nat. de Belgique, Brussels, and here inserted by permission of the director, M. E. Dupont. The curved specimen running up the middle of the slab shows a vegetative region with long internodes above and below, and a fertile region showing short internodes between them.

phylls.¹ These were arranged in whorls of twelve, and were superposed: each consisted of three sterile lobes palmately divided, and it bore upon its upper surface, and inserted close to its base three sporangiophores: each of these was provided with four long pendent sporangia attached to its peltate distal end (Fig. 223). So far as the vascular connections are a guide, it may be concluded that the sporangiophores are appendages of the branched sporophyll, and especially of its middle segment, since a vascular strand supplying them originates from the bundle which runs into the middle segment of the sporophyll. This strand divides then into three, and one branch enters each of the sporangiophores (Fig. 224). Thus, as Scott himself points out,² the course of the vascular bundles supplying the sporangiophores and bracts is essentially the same in *Sphenophyllum* and *Cheirostrobus*, though necessarily more complex in the latter.

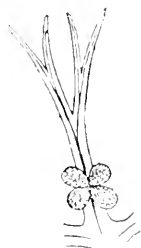

FIG. 222.

Forked sporophyll of *Sphenophyllum majus*, bearing sporangiophore. (After Kidston.)

There can be little doubt of the fundamental correspondence of the various types above described: they all coincide in the presence of spore-producing parts subtended by sterile bracts arranged in whorls: and notwithstanding their differences in number, and in the number of sporangia which they individually bear, it is safe to conclude that the sporangiophores are homologous throughout the series. Their similarity of general structure to the sporangiophores of the Equisetales is most clearly seen in *Sphenophyllum majus*, or in greatly elongated form in *Cheirostrobus*: considering this in conjunction with their correspondence in function, there is reason also to recognise a distinct relation to the sporangiophores of the Equisetales. In point of position there is the difference of their being leaf-borne, as against the axial insertion of the Equisetales: in fact the relation to the leaf is similar to that often seen in them, but closer. The conclusion seems inevitable that the sporangiophore in these two phyla is a member of similar morphological rank, though it may in both phyla show some variety in its exact position.

And here it will not be inapposite to point out in support of this view some features of structural similarity which exist between the Equisetales and the Sphenophyllales. They will be best illustrated in brief by the juxtaposition of Scott's two figures (compare Fig. 217 with Fig. 225). The former shows the transverse section of the ancient *S. insigne* from Burntisland, which differs from the later Sphenophylls in having a canal marking the position of the protoxylem at each angle of the primary wood: also in having continuous medullary rays in the secondary wood, and scalariform tracheides in place of those with numerous bordered pits.

¹A second specimen, belonging also to Mr. Kidston, to whom the original discovery was due, shows only eleven protoxylems.

²*L.c.*, p. 413.

Comparing this with Fig. 225, which is from the axis of *Calamostachys Binneyana*, there is a similarity in outline of the primary stele; but as this is not constant in the species it cannot bear weight in the comparison. The points of importance are, the similar canals, of like position to those of *S. insigne*, and like them showing the position of the protoxylem; the continuous medullary rays, and the similarity of the tracheides. These

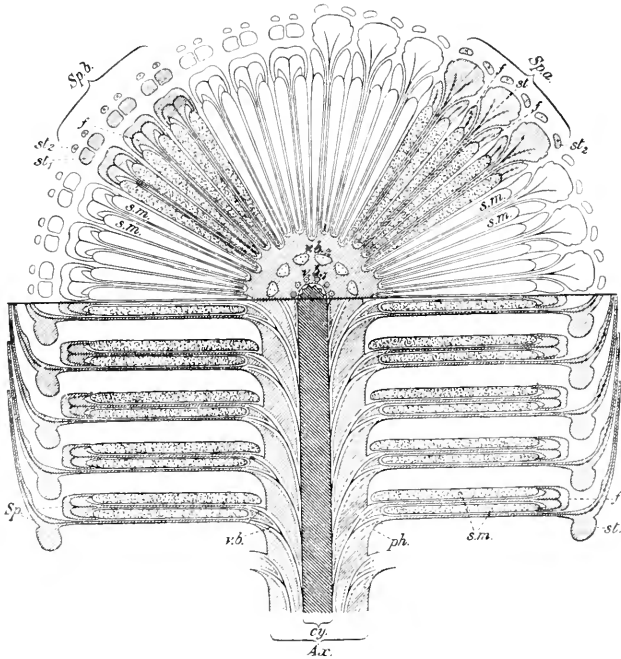

FIG. 223.

Chirostrobus Pettycoveus. Diagram. The upper part in transverse, the lower in radial section; the position of the organs corresponds in the two sections. 1. Transverse section. Six complete sporophylls, each with three segments, are shown; *Sp.a* = section passing through sterile segments; *Sp.b* = ditto through fertile segments, or sporangio-phores; *st* = lamina of sterile segment; *st1* = downward outgrowths of sterile laminae cut transversely; *st2* = their apices, transverse; *f* = peltate sporangiophores; *s.m.* = sporangia. Note that in *Sp.a* each peltate lamina, *f*, is seen in two distinct lobes, with the sterile lamina between; *vb1*, *vb2* = vascular bundles of two whorls. 2. Radial section. The sporophylls are separated from one another for clearness' sake, in nature they are in close contact. *Ax.* = axis of cone; *Cy.* = its stele; *ph* = base of sporophyll. Other lettering as in transverse section. The diagram is true to nature as regards proportions of parts, as well as their relative position. \times about 2. (From Scott's *Studies in Fossil Botany*.)

features appear to indicate a real structural resemblance, and it is important to note that the nearest approach is between the oldest of the Sphenophylls and the strobilar structure of a Calamite; for according to the views here advanced, it is in the strobilus that the more primitive structure might be anticipated.

A special interest in relation to the strobiloid theory attaches to *Sphenophyllum majus*, with its ill-defined cone. It is important to note that this state, so prominent in *Lycopodium*, is found in that species

of *Sphenophyllum* in which the arrangement of the sporangia is in a group disposed radially around a central attachment—a condition comparable with that of the Calamarians, and which was probably a relatively primitive state. Finding these two features combined in the same plant gives to both additional weight. But they are also combined in that other series which, following the suggestion of Thomas, are here included with the Sphenophyllales, viz. the Psilotaceae. These will now be described, and the general discussion of the morphology of the sporangiophoric Pteridophytes will be reserved till it can be illuminated by the facts which these living genera supply.

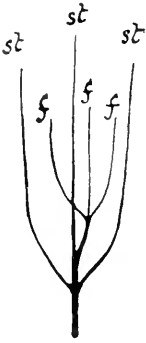

FIG. 224.

Diagram of the vascular supply to the sterile lobes (*st*), and to the sporangio-phores (*f*) in *Cheirostrobus*.

B. PSILOTACEAE.

The genera *Thesipteris* and *Psilotum* are the only living representatives of this peculiar and somewhat isolated family, while there is nothing known among Fossils which can with any certainty be ascribed to it. They have commonly been classed with the Lycopodiales, and, as we shall see, there are many undoubted points of resemblance in that

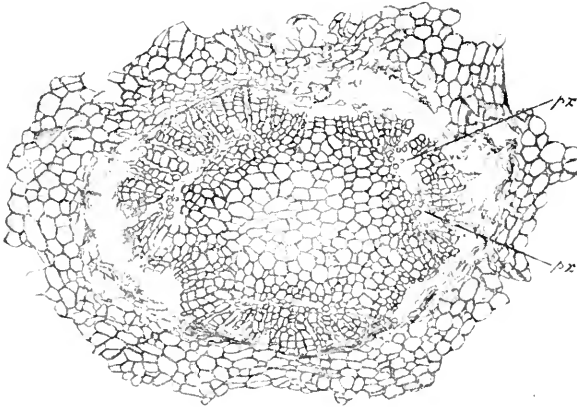

FIG. 225.

Calamostachys Binneyana. Transverse section of axis of cone, showing stele and part of cortex. Surrounding the pith there are six bundles, in groups of two, with secondary wood. *px* = protoxylem groups. \odot about 60. *Phil. Trans. W. and S. Will. Coll.*, 100. (From Scott's *Studies in Fossil Botany*.)

direction. But increasing knowledge of the Sphenophylleae, as well as of the Psilotaceae themselves, has indicated a more natural position of both together in the phylum of the Sphenophyllales. The two genera of the Psilotaceae are so similar in their general characters that there is no doubt of their close affinity: on the other hand the differences of detail

between them, as well as the variations in the individuals in either genus, afford an important basis for comparison with other forms, throwing light upon fluctuations of structure which would otherwise be more puzzling than they now appear to be.

Both genera are rootless. The green, more or less shrubby shoot, is established in the substratum, which is usually of humus character, by means of a plexus of leafless rhizomes invested with rhizoids, and penetrated by a mycorrhizic fungus. The nutrition of these plants is thus of a mixed character, partly saprophytic, partly by photosynthesis. The aerial shoots bear appendages of two sorts, described as foliage leaves, which are simple, and sporophylls, which are forked. These may be associated together irregularly on the same shoot which thus takes the character of a lax, undifferentiated strobilus.

In *Tmesipteris*, of which the single species *T. tannensis* is native in Australasia, though extending northwards to the Philippines, the structure is more simple than in *Psilotum*. Its habit is peculiar, the plant being established on the trunks of tree-ferns, though occasionally it has also been found growing upon the ground. The rhizome, which fixes it in the substratum, is repeatedly branched in a dichotomous manner and is without appendages other than rhizoids. Branches of this system turn upwards to the light, and develop as the aerial shoots: these are usually themselves

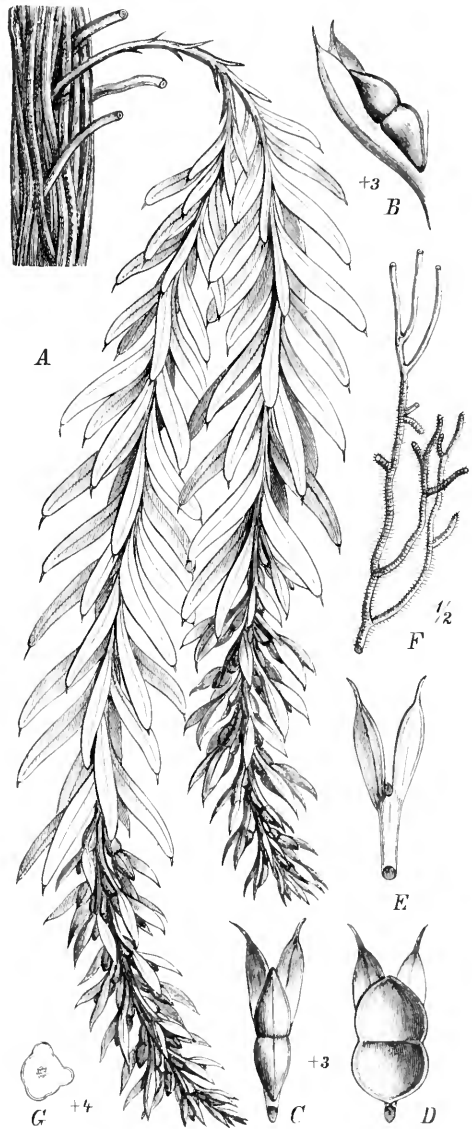

FIG. 226.

Tmesipteris tannensis, Bernh. A—Habit-figure of a whole plant (pendent form), showing a dichotomy. Natural size. B-E, sporophylls, with syngonium; B, seen from the side; C, from above; D, after dehiscence; E, from the under (dorsal) side, all \times about 3. F—rhizome $\frac{1}{2}$ natural size. G—transverse section of old stem, \times 4. (After Pritzel in Engler and Prantl, *Nat. Pflanzenfam.*)

unbranched, though occasionally a dichotomy may be observed (Fig. 226 A). The aerial shoots differ from the rhizomes in bearing appendages: first, small scale-like bodies are produced, but higher up they enlarge gradually, till the condition of the fully-formed foliage leaf is attained: this is about half an inch long, and flattened in a vertical plane. The basal vegetative region is continued directly into the fertile region: here the distinctive feature is the forked sporophyll,¹ which bears the sporangiophore seated at the fork, and on its adaxial surface: each sporangiophore supports two large and confluent sporangia (Fig. 226 B, C). The disposition of the leaves upon the mature axis is irregularly alternate, and this appears in transverse section of the apical bud (Fig. 227): here the axis shows

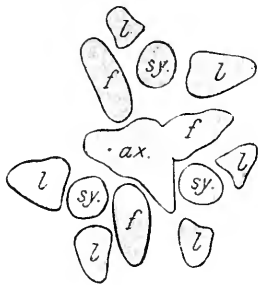

FIG. 227.

Transverse section through a sporangiferous bud of *Tmesipteris*. *ax.* = axis. *f.* = foliage leaves. *l.* = lateral lobes. *sy.* = syngonia. $\times 20$.



FIG. 228.

Tmesipteris tannensis, various unusual forms of sporophyll and sporangiophore: in i, the syngonium is abortive; in ii, and iii, one loculus is abortive; others show a larger number of loculi than two; others again, right and left on the lower row, show a single loculus, the septum being imperfect, or absent.

a very irregular outline owing to the decurrent bases of the appendages: it is also apparent that these are alternate: it may also be noted that in the case figured three foliage leaves (*f.*) are inserted above the three sporophylls (*l.*, *sy.*, *l.*).

The fertile region forms a very lax strobilus, in which the following features may be noticed. It does not differ markedly from the vegetative region in the size of the parts which it bears: it is not composed exclusively of sporophylls, but foliage leaves of the usual type may be interspersed

¹The terminology here used is that of Scott (*Studies*, p. 479). I regret having in 1893 (*Studies*, part i.) used the term sporangiophore in a wider sense than here, so as to include the bifid sporophyll itself. Such an extension of the term obscures the natural comparisons not only with the Sphenophylleae, but also with other sporangiophoric types. It is best to restrict the use of the word in the Psilotaceae to the body borne by the bifid sporophyll, often designated also the syngonium. The various opinions previously held as to the morphology of these appendages need not be discussed again here. It will suffice to refer to my *Studies*, i., p. 539, where they have been considered at some length, with references to the literature relating to them. See also Lignier, *Bull. Soc. Linn. de Normandie*, 1904, p. 95, and footnote.

among the bifid sporophylls: not uncommonly there is a reversion from the strobilus back to the ordinary vegetative state. In fact, as regards relation of foliage leaves and sporophylls, the condition is the same as that in the "*Selago*" section of *Lycopodium*, with its successive, but little differentiated, sterile and fertile zones. But not uncommonly the fertile zones of *Tmesipteris* show differences from the normal as regards the details of the spore-bearing members at the limits, or about the middle of the fertile zones:¹ about the upper and lower limits, but especially at the upper, variations of reduction from the normal, both of sporophylls and of synangia may be found: these may appear in the abortion of either loculus, or of both of them (Fig. 228 i. ii. iii.): or the two loculi may be imperfectly formed, the septum being incomplete between them, and the synangium is then replaced by a single loculus (Fig. 228 lower row). It would appear that these reductions are to be correlated with deficient nutrition at the limits of the fertile zone. Conversely, about the middle of a fertile zone, where presumably the nutrition at initiation of the parts is most efficient, certain sporophylls may be developed beyond the normal limits: in the simpler cases an additional loculus may appear in the synangium (Fig. 228); but in well-developed plants Thomas has found that not infrequently the sporophylls may show a repeated dichotomy, and two or even three normally shaped synangia, or sporangiophores, may be produced, one at each fork of the sporophyll. He has also described how the sporangiophore is not always sessile as it is normally, but may be raised up on a longer or shorter stalk: also that it may at times be replaced by a leaf-lobe of outline like those which are normal. The theoretical bearings of these several variations, which do not appear to be uncommon where the plant flourishes well, will be discussed later.

In *Psilotum* the main features resemble those in *Tmesipteris*, but with differences of detail. The genus consists of two well-marked species, *P. triquetrum*, which is upright and shrubby, with a radially constructed shoot, and *P. flaccidum*, which is weak and pendulous, with a bilaterally flattened shoot, bearing the appendages on its margins. The underground rhizomes are rootless and leafless, as in *Tmesipteris*, but are more profusely bifurcate: they are covered with rhizoids, and show mycorrhiza. They produce gemmae, which freely propagate the plant vegetatively. The aerial shoots also bifurcate much more freely than in *Tmesipteris*, in planes successively at right angles (Fig. 229). On these the minute vegetative leaves are disposed, but with no constant or definite arrangement: they appear as small subulate processes, arising from the projecting angles of the green axis, and are commonly without vascular tissue. In the upper regions of strong shoots they are replaced by sporophylls which are bifurcate as in *Tmesipteris*, though very small: each bears a short-stalked sporangiophore, which supports three synangial sporangia. Here as in *Tmesipteris*

¹ Many of the details here embodied are taken from Thomas, *Proc. Roy. Soc.*, vol. lxi., p. 343.

the fertile shoot is very lax, and does not form a definite strobilus, while foliage leaves are interspersed irregularly between the sporophylls. There

is thus a "*Selago*" condition in *Psilotum* also, and it is even more obvious than it is in *Tmesipteris*. *Psilotum* is also open to deviations of structure of the spore-producing parts: reduction of the sporangia from the normal three to two is not uncommon, though it appears frequently to be the result of arrest of one of the loculi. In other cases the number of the loculi may be increased to four or five.¹ Thus in the Psilotaceae sporangiophores may be found bearing sporangia variable in number from one to five. The observations of Thomas also show² that there are fairly numerous instances in *Psilotum* of a second dichotomy of one, or even of both branches of the forked sporophyll: in the former case two sporangiophores are present and three minute leaf-lobes, in the latter case three sporangiophores and four leaf-lobes. The synangia are in these instances closely crowded together, and in some cases at least irregular quinquelocular synangia are due to the fusion of two original primordia in close proximity. There are no statements as to the position in the fertile region which these abnormalities hold. From the above facts in *Psilotum*, as well as those in *Tmesipteris*, Thomas draws the conclusion "that repeated dichotomy of the sporophylls of the family Psilotaceae is an ancient

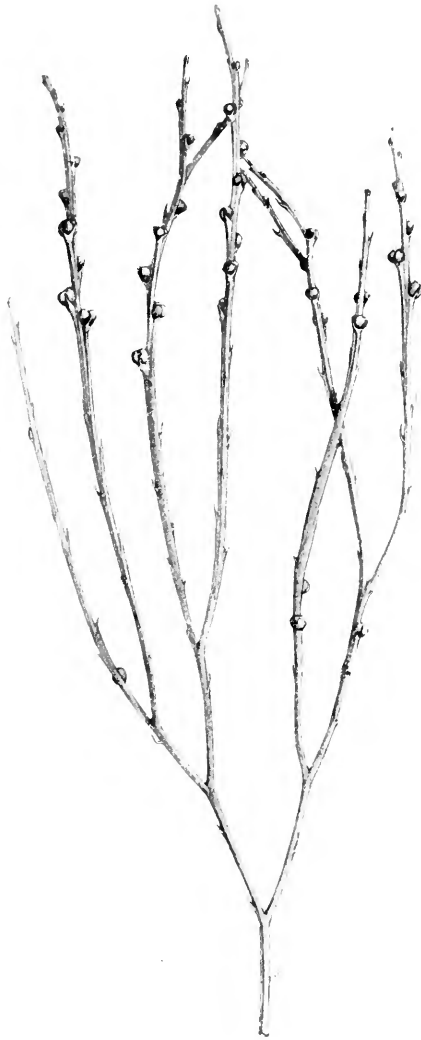

FIG. 229.

Psilotum triquetrum, Sw. Shoot showing repeated dichotomy, bearing minute tooth-like sterile leaves, and turgid synangia attached to the minute forked sporophylls. It is to be noted that a sterile region intervenes between two fertile regions. Natural size.

feature." Without accepting this position, this much at least is clear, that the present Psilotaceae possess morphological possibilities of further

¹ Solms Laubach, *Ann. Jard. Bot.*, Buitenzorg, iv., p. 174.

² *Proc. Roy. Soc.*, vol. lxi., p. 349.

amplification beyond what is held to be the normal for them. It is a different question whether these were ever effectively realised in the past, and thus figured as normal features in any ancestral race. Nevertheless it is hardly possible to avoid the comparison of the forked sporophylls of the Psilotaceae, and these extra branchings, also with forked leaves, which are so prominent a characteristic of the Sphenophylleae.

From the study of the external characters of the living Psilotaceae it appears that the sporophyte is readily referable to a strobiloid origin. The rootless condition and the leafless rhizomes present no difficulty, but rather the reverse. It may, however, be a question whether this condition was primitive in them, or the result of reduction in accordance with their peculiar habit. As regards the lax shoots, the dichotomous branching is reminiscent of the Lycopodiales rather than the Sphenophyllales. The vegetative development of the lower parts of the aerial shoots, as well as the "*Selago*" condition so clearly seen in their upper regions, corresponds to that of the simpler Lycopods, while it finds its correlative also in *Sphenophyllum majus*. The chief points of divergence as regards external form are the shape of the leaves and sporophylls, and their alternate arrangement, though they share the latter with most of the Lycopods. The reduction or abortion of sporangiophores about the limits of the fertile zones compares with the imperfect development or abortion of sporangia in a similar position in *Lycopodium Selago* and others; while the amplifications noted by Thomas about the middle of the fertile zones in *Tmesipteris* only accentuate the recognition of those zones as distinct from the sterile parts. Accordingly the general reference to a strobiloid origin will apply to the Psilotaceae with equal force to that in the case of *Lycopodium*, and this will be so upon the facts themselves, whatever the genetic relations may have been between the Psilotaceae, the Lycopods, and the Sphenophylls.

DEVELOPMENT OF THE SPORE-PRODUCING PARTS.

The apical cone of *Tmesipteris* is very variable in bulk: in strong young shoots it may be a broad dome, while in weaker specimens, or those in which the apical growth is beginning to fail, it may be comparatively narrow. Passing from the actual apex the sides of the cone are covered externally by deep prismatic cells, which are of somewhat irregular origin, depth, and arrangement. When a leaf or sporophyll is about to be formed, certain of these increase in size, and undergo both periclinal and anticlinal divisions so as to form a massive outgrowth, the summit of which is occupied, as seen in radial section, by a single cell of a wedge-like or prismatic form: it is not improbable that the latter passes over to the wedge-like form as the part develops. In these early states it is impossible to say whether the part in question will be a vegetative leaf or a sporophyll, and even when older it is still a matter of uncertainty, so

similar are they in their initial stages, though so different when mature. Those, however, which are to develop as sporophylls soon show an increase in thickness, while they grow less in length; an excrescence of the adaxial surface soon becomes apparent (Fig. 230 A), in which the superficial cells are chiefly involved: this constitutes the sporangiophore. The superficial cells at first form a rather regular series: they undergo more

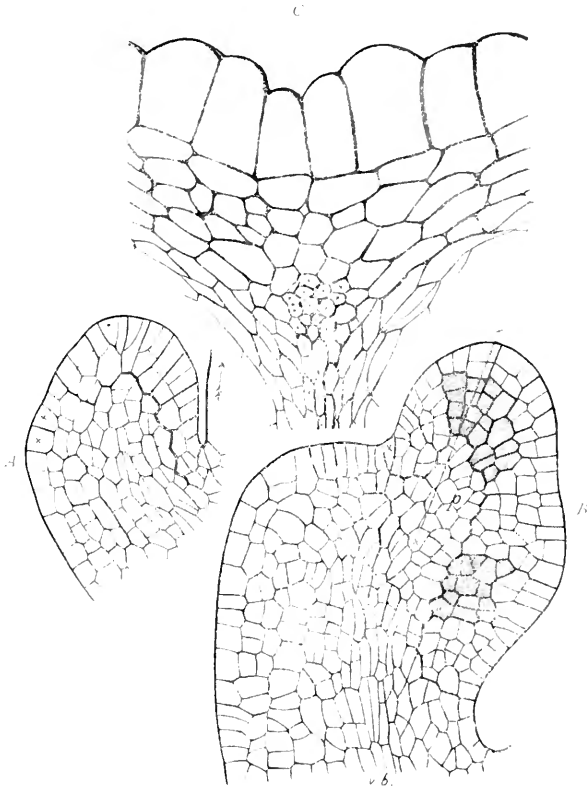

FIG. 230.

Tmesipteris tannensis. A = very young syngangium arising from the adaxial surface of the sporophyll. $\times 100$. B = a sporophyll bearing a much older syngangium; the sporogenous masses are shaded. $\times 100$. C = part of a radial section of a mature syngangium showing the insertion of the septum. $\times 100$.

or less regular divisions: a band of tissue some four or more layers in depth is thus produced. At about this period certain masses of cells assume the characters of a sporogenous tissue (Fig. 230 B): but though they can be recognised as such by the character of the cells, it is exceedingly difficult to define the actual limits of these sporogenous masses. The more superficial tissues, as well as the band intervening between the two sporogenous masses remain sterile, the latter developing into the septum, while the former develop into the walls of the syngangium: it is specially

to be noted that the origin of the tissue of the sterile septum, which separates the sporangia, seems to be similar to that of the sporogenous masses themselves.

As the development proceeds, it is still difficult to recognise with certainty the exact limits of the sporogenous masses: this is probably due to the fact that there is no very clearly defined tapetum, nor is the whole of the sporogenous mass used up in the actual formation of spores: but a considerable proportion of the cells composing it, acting as a diffused tapetum, become broken down, and disappear in a manner similar to that to be described more in detail in *Psilotum* (Fig. 231).

Finally, a strand of vascular tissue, of which the origin may be traced in Figs. 230 A, B, is formed, extending upwards into the sporophyll; on entering the sporangiophore, it passes up to the base of the septum, and there branches right and left, the two branch-bundles traversing the margins of the septum.

When mature, the wall of the synangium consists of a superficial layer of deep cells, with thick cell-walls, a band of thinner-walled compressed cells, three to four layers thick, supporting the superficial layer internally (Fig. 230 c). These cells have pitted walls, and are not definitely limited internally, but irregular tatters of cell-wall project into the cavities of the sporangia, showing thus that there is no clear limit between the wall of the sporangium and the tapetum.

The septum shows in the main a structure similar to this inner band of the wall, with which it is continuous: it consists of a firm plate of narrow tabular cells, four to six layers in thickness, with profusely pitted, woody walls. The septum is also coated by the remains of thinner-walled disorganised cells. As already noted, the branches of the vascular bundle which enters the sporangiophore pass right and left up the margin of the septum; these bundles are seen as bands of tracheides in transverse sections through the lower part of the septum (Fig. 230 c.); the bundles are not sharply differentiated from the surrounding tissues, and they appear to consist only of xylem. A number of tracheides, continuous with the bundle, extend along the central part of the septum; and from the position of the bundle, it appears to belong to the septum, rather than the external wall of the synangium. The results obtained thus from radial sections have been verified by comparison also of sections in other directions.¹

An examination of the imperfect synangial sporangiophores which occur at the limits of the fertile region shows them to be frequently unilocular: this may be in some cases due to the abortion of one or other of the two loculi, but in other cases it is clearly by imperfect development of the septum between them, as vestigial remains of it may often be found. It has been demonstrated that tissue which would normally develop as septum may in these cases develop as tapetum, or even as sporogenous tissue (Fig. 231): and thus the unilocular condition

¹See *Studies*, i., p. 543.

is attained. But the tissue of the normal septum is of common origin with the sporogenous tissue itself, and in the earliest stages does not differ from it in position or structure. The normal development, in fact, would be compatible with the view that the septum is formed from potential sporogenous tissue sterilised: the unilocular condition would then follow from reversion of that sterile tissue to its original fertile state again. This question is intimately connected with that of the origin of the sporangiophore, and opportunity will be taken later to discuss it.

The detailed study of the sporangiophore or synangium of *Psilotum* by means of sections is more difficult than that of *Tmesipteris* on account of its trilocular character. In radial sections through the terminal bud the

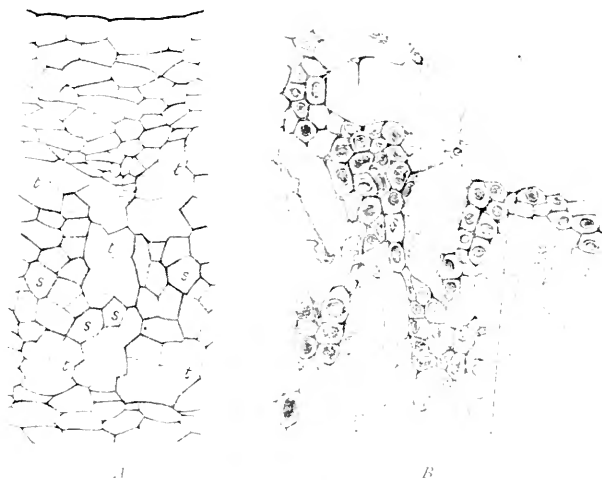

FIG. 231.

Tmesipteris taeniensis, Bernh. A, median section through synangium, showing the tissue where the septum normally is developing as sporogenous cells (s). t=tapetum. B, part of the contents of a similar synangium, rather older. z: shows the line where the septum should normally be, while a chain of fertile cells stretches continuously across it. This drawing also indicates how cells distributed through the sporogenous tissue become disorganised. $\times 100$.

young sporophylls are found to present a general outline and structure similar to those of *Tmesipteris*. Fig. 232 A shows one such: the cell (\times) is believed to represent the organic apex of the sporophyll, though it is doubtful whether it be this initial which gives rise to the whole mass of the tissue. The sporangiophore appears as an outgrowth of the upper surface of the sporophyll, while the tissue on the abaxial side of it is already growing out into a bulky projection. But it has not been possible to trace the development of the essential parts of the loculi of the synangium from the superficial cells of the adaxial side of the sporophyll in this case with the same certainty as in *Tmesipteris*: this is chiefly owing to the stalk being here narrower, and to the fact that only one loculus can be cut in a median direction in any one section: supposing this to be the median plane of the whole sporophyll, then it will be the

abaxial locus which will be thus traversed. A truly radial section of a young synangium is shown in Fig. 232 B, the arrow indicating the direction of the main axis: the cell (x) is a conical cell, which is commonly though perhaps not constantly found occupying the centre of the apical surface of the synangium. The cell shaded is believed to be the arche-sporial cell for one of the loculi, but after comparison of a large number

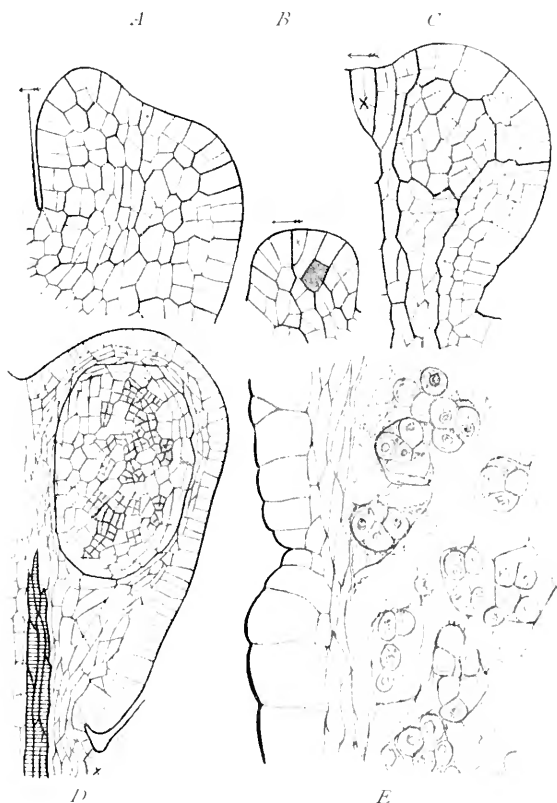

FIG. 232.

Psilotum triquetrum, Sw. Various stages of development of the synangium and sporangium. In C the sporogenous group is shaded. D shows the differentiation of its cells, the fertile cells being shaded. E shows the disorganisation of the remaining cells without forming spores. $\times 100$.

of sections I am still uncertain whether the whole of the sporogenous tissue in each locus is really referable to a single parent cell, for just the same difficulty arises here as in *Tmesipteris* in recognising the exact limits of the sporogenous masses.

The subsequent stages of development are illustrated by Figs. 232 C, D, E, and it will be seen from these how the sporogenous masses assume large dimensions, and are at first composed of uniform cells. The wall of the synangium meanwhile becomes multiseriate, and the cells of the outermost layer assume a deep and prismatic form, while the inner layers are narrow.

The same is the character of the more superficial cells of the sporogenous mass (Fig. 232 D), so that it is almost impossible to recognise the limit between the tissue of the wall and of the sporogenous mass: the superficial portions of the latter become disorganised without the formation of spores, but there is no clearly defined tapetum. Such is also the fate of a considerable proportion of the more central cells: for as the synangium develops, irregular groups of cells of the sporogenous masses assume dense granular contents, and subdivide, while the others remain paler, with more watery contents, and do not divide: the former undergo the final tetrad-division and form spores, while the latter become disorganised. The actual state of partial disorganisation is shown in Fig. 232 E: thus a partial sterilisation of cells of the sporogenous tissue, essentially similar to that in *Equisetum*, is seen also in *Psilotum*, and, as above stated, it occurs also in *Tmesipteris*.

In both genera the lines of dehiscence at maturity are defined structurally. In *Psilotum* the lines radiate from the centre, and it has been seen that a similar condition may be recognised in the sporangiophores of *Sphenophyllum majus*. Thus, in the broad outlines of structure, in function, and in position the sporangiophore of the Psilotaceae is the correlative of that in the Sphenophylleae. It remains to see how far there is a correspondence also in the anatomical structure of these plants.

ANATOMY.

The internal structure of the Psilotaceae is relatively simple, in accordance with their outward form. The axis is traversed by a stele, which is fundamentally of the protostelic type, and limited by an endodermis which is more definite in *Psilotum* than in *Tmesipteris*. The broad cortex which surrounds the stele is variously differentiated in the rhizome and in the aerial shoot: in the former it consists of starchy parenchyma, with endophytic mycorrhiza in the outer layers, while the superficial cells grow out into rhizoids: in the aerial shoot the stele is surrounded successively by thin-walled parenchyma, sclerenchyma, and assimilating tissue, while peripherally is an epidermis with stomata. Such characters, however, present little that is of comparative value; it is in the vascular tissue that a better basis for comparison is found.

The structure of the stele in *Psilotum*¹ varies according to the position and size of the part: in the rhizome there is often no protoxylem, but the xylem consists of a somewhat irregular, and exiguous group of scalariform tracheides, surrounded by an ill-developed phloem, while peripherally there is a definite endodermis. At the base of an aerial shoot the xylem increases in bulk, with interspersed parenchyma cells, and

¹These statements are based partly on personal observations, but also on the writings of Bertrand (*Arch. bot. du Nord.*, i.), of Boodle (*Ann. of Bot.*, xviii., p. 505), and of Miss Ford (*Ann. of Bot.*, xviii., p. 589).

protoxylem makes its appearance: where the protoxylem is clear it is evident that the differentiation of the primary xylem is centripetal, as it is, with local exceptions, throughout the aerial shoot. Passing upwards along the aerial shoot, the peripherally projecting protoxylems increase in number, the whole stele enlarging: finally, in transverse section the xylem appears as a hollow, many-rayed star, while the centre is occupied by sclerotic tissue. Peripherally as before lie the phloem and the endodermis (Fig. 233). An examination of the lower part of the aerial shoot, and of some adjoining parts of the rhizome, shows a feeble secondary formation of xylem: there is no definite cambium, but the additional tracheides which arise from the tissue outside the primary wood often show signs of a radial arrangement. The secondary development fades off as the stellate structure of the upper region is attained. Thus

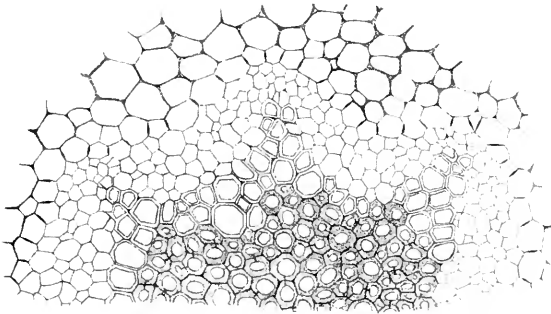

FIG. 233.

Psilotum triquetrum. Part of a transverse section of the central stele. $\times 100$.

structurally the base of the stem of *Psilotum* recalls the stem of *Sphenophyllum*, though with very feeble secondary growth, while the upper part of the stem resembles the axis of the cone of *Cheirostrobis*, though on a simple scale, and with fewer xylem-rays.

In the stem of *Tmesipteris* no secondary development has hitherto been found. The rhizome exhibits much the same structure as that of *Psilotum*, with a solid group of tracheides at the centre, or in weaker branches an irregular xylem-ring, surrounded by phloem, and a very ill-defined endodermis. Often there is no distinct protoxylem: but, as the passage is made to the aerial stem, protoxylem may appear: its position in all the upper region is mesarch. In weaker shoots, and especially in the upper regions, the cauline tissue of the stele fades out: the leaf traces become the main feature of the vascular system, which in transverse sections is then represented by a ring of separate strands: each of these has its mesarch protoxylem corresponding to that seen in the leaf-trace (Fig. 234): in point of fact this becomes a phyllosiphonic type of structure. In strong axes, however, the xylem may still form a

coherent ring surrounding a central pith, but with the protoxylem mesarch.

The chief anatomical difference between the two genera appears thus to be in the position of the protoxylem. But Boodle points out that locally a mesarch position may be found in *Psilotum* also, and he concludes that both genera might be referred to a common parent form, in which the aerial stem had a rayed mesarch xylem-mass, the suppression of leaf-traces having caused the loss of centrifugal wood in the one genus, and the influence of the leaf-traces in the other genus having broken up

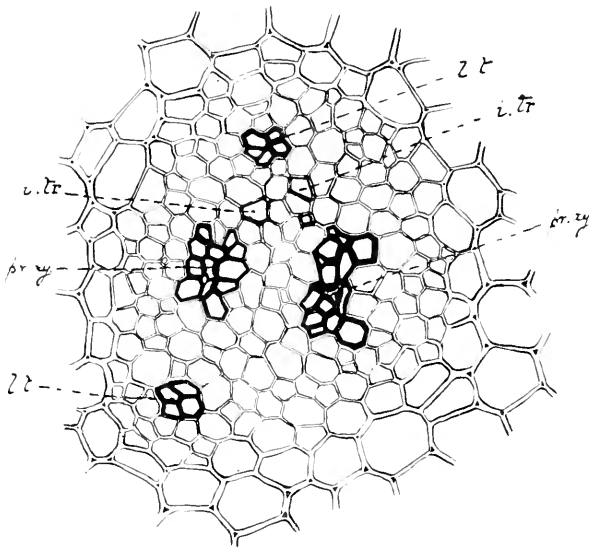

FIG. 234.

Tmesipteris tannensis. Transverse section of the sterile region, high up. The protoxylem (*p.r.*) is mesarch. The xylem of the stele is fading out, and being replaced by parenchyma; three of the tracheides (*i.t.*) show incomplete development; there is no longer a complete ring, and the leaf-trace bundles (*z.t.*) enter the gaps which result, in much the same way as in a phyllosiphonic type. There is no definite endodermis.
 × 150.

the xylem into distinct bundles.¹ He further recalls the fact that in *Cheirostrobis* there are indications of a mesarch structure, while parenchyma is present among the tracheides towards the centre of its stele: such cells in response to mechanical requirements might readily be converted into mechanical tissue, as in *Psilotum*. It thus appears that the Sphenophylleae and Psilotaceae show uniformity in the general type of their vascular construction, though the details are subject to considerable fluctuation. This result adds point to the comparisons already based upon the external characters and the spore-producing parts. At the same time, it is to be remembered that a structure resembling that of *Psilotum* and *Cheirostrobis* is seen in certain of the Lycopodiales; in

¹ *L.c.*, p. 515.

particular it is found in *Lepidostrobos Brotenii*, where also the leaf-trace bundles are of the mesarch type. The comparison has also been made by Miss Ford with *Bothrodendron mundum*: in this case the correspondence seems to be rather with the rhizome of *Psilotum* than with its aerial shoot.

EMBRYOLOGY.

Of the embryology of the Psilotaceae nothing is at present known. Even the prothallus has not been recognised with certainty, though Dr. Lang¹ has described the structure of one which may with a reasonable degree of probability be referred to *Psilotum*. It was closely associated with a plant of *Psilotum*, in a locality where no species of *Lycopodium* (with which a mistake of identity might occur) were observed growing in the same situation. This, as well as certain comparative reasons, made Lang regard it as probable that his prothallus is really that of *Psilotum*. It was a prothallus of the wholly saprophytic, subterranean type, corresponding to that of *L. clavatum* or *complanatum*: it bore antheridia, but no archegonia or embryos.

The initial embryology of the Psilotaceae is thus a complete blank. It is to be hoped that ultimately this blank may be filled: meanwhile the following remarks may be made as indicating the nature of the problem which the further data may be expected to solve. The relationship of the Psilotaceae to the Lycopods, long recognised on characters of the mature sporophyte, has lately been in a measure discounted by a better knowledge of the Sphenophylleae, though the prothallus provisionally attributed by Lang to *Psilotum* would appear to point to a strengthening of the former relationship. A connection also with the Equisetales is now more clearly recognised than formerly; and it will be remembered that in these the axis asserts itself early, while the first leaf-sheath appears relatively late, as a subsidiary appendage. In the sporophyte of the Psilotaceae we see a rootless plant, with branched, leafless rhizome, while the appendages appear first on the aerial shoot. It may be expected that the embryology should show some evidence bearing on the question whether the leafless and rootless condition of the lower parts is primitive or the result of reduction. If the embryo showed, like that of *Lycopodium*, cotyledons and a primary root, that would be positive evidence that the rootless and leafless condition seen in more advanced stages of the plant was a result of reduction. If, on the other hand, the embryo developed without appendages directly into the rootless and leafless rhizome, then either of two interpretations would be possible: either that reduction had been effective back to the earliest phases of the individual: or that the sporophyte at first represented that primitive state of an axis without any appendages, which a strobiloid theory contemplates in the far back ancestry: it is significant that some remote approach to this is seen

¹ *Ann. of Bot.*, xviii., 1904, p. 571.

in the embryo of *Equisetum*, with its direct and early assertion of the axis, and the relatively late and subsidiary character of its first leaves. It is naturally impossible to express any opinion on such points at present: but it is to be remarked that the facts relating to the mature plants of the Psilotaceae as they stand would bear either of those interpretations. So far as expressed, current opinion appears to favour the probability of reduction in accordance with habit, and especially so in the case of *Psilotum*, where the leaves lend themselves readily to an interpretation as reduced structures. But whichever view be ultimately taken, a strobiloid theory would meet the facts more readily than any phytotic theory of the shoot.

CHAPTER XXIX.

SUMMARY FOR SPHENOPHYLLALES AND FOR SPORANGIOPHORIC PTERIDOPHYTES GENERALLY.

It has now been seen that the two living genera of Psilotaceae, though differing in the number of sporangia on each sporangiophore, as well as in the size of the appendages, correspond nevertheless in the essential characters of form; they are alike in the rootless and leafless rhizome, in the irregular alternate arrangement of the appendages, and in the relation of the sporangiophore to the forked sporophyll. The anatomical characters also correspond, though with differences open to biological explanation. No one will therefore doubt the natural affinity of these two genera.

The relation of the Psilotaceae to the Sphenophylleae has been only lately recognised. Previously they were placed with the Lycopodiaceae, and in the above pages points of similarity to these plants have been repeatedly noted; such as the dichotomous branching of the primitive monostelic axis, the imperfect differentiation of the vegetative and fertile regions, and the relation of the sporangiophore in the one and of the sporangium in the other to the sporophyll. It was Dr. Scott who first indicated the closer relation between the Psilotaceae and the extinct Sphenophylleae, on the ground of anatomical resemblance, as well as the similarity of the spore-producing parts;¹ this view was further developed by Thomas, on the basis of observation of many specimens in their native habitat.² The chief difference seems to lie in the fact that the appendages of the former are irregularly alternate and distinct, while in the latter they are in regular whorls, and webbed at the base. But the genus *Lycopodium*, which includes species with whorled and others with irregularly alternate leaves, shows that too much weight must not be attached to such a distinction relating to kindred forms.³ There is also the difference of branching, which is terminal and dichotomous in the

¹ *Studies*, p. 499.

² *Proc. Roy. Soc.*, vol. lxi., p. 343.

³ Compare Scott, *Progressus*, i., p. 166.

Psilotaceae, and apparently axillary in the Sphenophylleae. But the analogy of *Equisetum* is interesting in this relation, for there, though the normal branching is monopodial, a terminal branching of the strobilus sometimes occurs. Thus the points of resemblance appear greatly to outweigh the differences, and the Psilotaceae and Sphenophylleae may well be grouped together as representing one phylum—the Sphenophyllales.

Examining the plants thus designated from the point of view of a strobiloid theory, the Psilotaceae show in the most pronounced way the "Selago" condition, while about the limits of the fertile zone in *Tmesipteris* imperfectly formed sporangiophores are often seen, which bear a similar interpretation to the abortive sporangia in *Lycopodium*. The matter is complicated here, it is true, by the marked difference between the simple sterile leaf and the forked sporophyll: it has been shown, however, that in the first stages of the individual development these parts are indistinguishable. Though in *Sphenophyllum* the strobilus is definitely marked as a rule from the vegetative region, it is important to note that *Sphenophyllum majus*, which most nearly resembles the Psilotaceae in the form of its appendages, has also an indefinite strobilus, with continuation again upwards into a vegetative state. Thus in both families the shoot shows examples of imperfect differentiation. This goes along with a development of the sporophyll, both in *Tmesipteris* and in *Sph. majus*, as an effective organ of assimilation, which is a further mark of a low differentiation. These facts may be held as justifying for the Sphenophyllales a line of argument similar to that for the Lycopodiales: that a definite strobilus has been the result of differentiation in a shoot in which the vegetative and reproductive functions were not originally separate. It is true that the case is not so clear for the Sphenophyllales as for the Lycopodiales: this is consequent on the number of the known species and of individuals available for comparison being much less, and the knowledge of the fossils more limited. It will perhaps be objected that the earliest known cone of this series, *Cheirostrobos*, was perfectly definite and highly specialised, while the earliest indication of a less specialised type is in *Sph. majus*. But the fact that so often the earliest known fossils of any phylum are very complex does not prove that such types were earliest in evolution. Thus *Cheirostrobos* among the Sphenophyllales and *Pseudobornia* among the Equisetales, though respectively the oldest representatives known, are both extreme forms, as compared with the other members of the phyla to which they respectively belong. In estimating such facts we should reflect that at the present day primitive and recent forms grow side by side, and both or either might be preserved as fossils; also that the chances of this happening depend upon many varied factors, of opportunity, texture, habitat, etc. The chances of discovery at the present day are equally varied. When these points are fully considered it will be clear that stratigraphical position of those isolated fossils which happen to have been discovered and described should not suffice to prove an

evolutionary priority in face of strong comparative evidence to the contrary. Accordingly the existence of the complex and definite cone of *Cheirostrobus* as the earliest of the Sphenophyllales cannot be held as invalidating the conclusion above stated.

In all these sporangiophoric Pteridophytes the axis is the dominant part of the shoot, and takes the lead in its development. This is shown anatomically by the typically protostelic structure of *Sphenophyllum*, while the foliar strands insert themselves marginally upon it. In the Psilotaceae the type of stem-structure is the same, but the xylem becomes hollow and medullated in the upper region, and in *Tmesipteris* it may break up into separate strands. Even in the apparently divergent case of the Equisetales it has been shown that the vascular system is referable to a primitive type of monostele, though greatly reduced in accordance with a semi-aquatic habit. Notwithstanding such changes the structure of the axis in all these forms indicates origin from a type in which the axis is predominant over the appendages, the vascular supply of these being inserted with the minimum of disturbance upon the cauline stele (Cladophonic type of Jeffrey). This confirms the theory of a strobiloid origin, with pre-existent axis and subsidiary appendages.

The differences in number of the sporangia on the individual sporangiophore call for remark. In the Sphenophylleae they have been observed to vary from six in *Sphenophyllum majus* to one only in *S. Dawsoni*, while *Psilotum* and *Tmesipteris* take a middle position with three and two respectively. In the Equisetales the number in the fossil form appears to be commonly four, but in recent species of *Equisetum* the number may be much larger and variable.¹ In the Sphenophyllales the variations present some points of interest: the number six occurs only occasionally in the one species named, while four is the usual number in that species, which it shares with *Cheirostrobus*. But in the species of *Sphenophyllum* with compact strobili the number may be two, or only one. These low numbers go along with a larger number of the sporangiophores, which may be twice (*S. Dawsoni*), or three times (*S. Römeri*) the number of the subtending bracts. In the former species the frequent juxtaposition of the stalks, and the insertion of the vascular supply of the stalks upon the strands supplying the bracts, suggests that fission has been operative, as in the chorisis of stamens: and it seems probable from the facts that with an increase of number of the sporangiophores, however brought about, there has gone a decrease in the number of the sporangia which each bears. Accordingly *S. Dawsoni* and *S. Römeri* may be held to bear sporangiophores of a type reduced from the original: and a central type of sporangiophore would appear to be one with about four sporangia.

The typical position which such a sporangiophore holds in the Sphenophyllales is one of attachment in a median position to the upper

¹ In *Calamites paleaceus* the pendulous sporangiophore bears a solitary sporangium.

surface of the sporophyll. This is illustrated by the living Psilotaceae, and by some species of *Sphenophyllum*, notably *S. majus*, which shows other characters held to be primitive. But it is departed from in *S. Daxsoni* and *S. Römeri*, where the number of the sporangiophores is in excess of the sporophylls, while the leaf-whorls are deeply webbed into a cup: *Cheirostrobus* is also an exception, but there the three sporangiophores correspond in position and number to the lobes of the tripartite sporophyll: this condition, together with the vascular connections, suggests a parallel amplification of the sporophyll and of the sporangiophore, to which we shall see modern correlatives later among the Ophioglossaceae. Thus, though liable to modifications, the characteristic position of the sporangiophore in the Sphenophyllales is in a median position on the upper surface of the subtending bract.

Here I must enter my dissent from certain "interpretations" which have been given of the leaf-borne sporangiophore. In cases where it is inserted on the upper surface of the leaf, as in the Sphenophyllales, it has been designated a "ventral lobe." If "ventral lobes" were of common occurrence on the vegetative leaves of these or of other Pteridophytes, there might be some meaning in the term. It lies with those who use this expression to show that such "ventral lobes" exist normally, other than these spore-producing bodies which they so designate. If they do not normally exist, then calling a leaf-borne sporangiophore a "ventral lobe" merely leads to confusion, and provides no explanation of its real nature. It introduces the idea that the sporangiophore is a result of "metamorphosis" of some pre-existent vegetative structure, of the nature of a "ventral lobe," an opinion untenable in the absence of proof that such bodies existed in the vegetative state.

But, on the other hand, it has been shown above that in the Equisetales, a series undoubtedly related to the Sphenophyllales, parts similar to the sporangiophores of the Sphenophyllales in structure and in function are borne upon the axis and have no constant relation to the bracts: for reasons assigned above (p. 382, etc.) these are not themselves to be held as foliar. Study of such sporangiophoric types, not separately but collectively, thus leads to a conception of the sporangiophore as a non-foliar structure, which may be inserted either on the axis or on the leaf, though in certain groups it shows a regular relation to the latter. It is, in fact, a part *sui generis* as much as the sporangium is, and not the result of modification of any other part.

The history of individual development of the sporangiophore, as traced in *Tmesipteris* and *Psilotum* for leaf-borne types, and in *Equisetum* where they arise directly from the axis, gives a clue to their nature. The sporangiophore first appears as a broad cushion of tissue, in the peripheral parts of which the sporangia are early initiated: these are from the first orientated outwards from the centre of the outgrowth. In the Psilotaceae (as also in *S. majus*) they maintain this, which may probably have been their

primitive position till maturity. But in the Equisetales the pendulous position is gradually assumed, the inversion of the sporangia being brought about by active growth of the middle region of the sporangiophore. This inverted position was probably a derivative state, as indeed its gradual appearance in the development of the individual would seem to indicate. The result presumably of a similar inversion is seen in *Cheirostrobus* and in *S. Römeri*, while it appears to have been general in the Equisetales.

This discussion leads naturally to the question whether in the cases before us the synangial state, as seen in the Psilotaceae and in *S. majus*, is the more primitive, or that with separate sporangia, as seen in *Equisetum* or in *Cheirostrobus*. So far as individual development can serve as a guide it would point to the former, for in their first stages all sporangiophores are synangial, and the state as seen in the Psilotaceae is merely the consequence of maintaining to maturity the relation of the loculi as at first initiated. The condition seen in *Equisetum*, on the other hand, is a consequence of the individual projection of each developing sporangium. When this is considered together with the inversion which goes along with it, it would appear probable from the story of development that the erect synangial condition was relatively primitive, and the condition with separate inverted sporangia a derivative state.

In view of the initial synangial condition of all young sporangiophores, the further question arises of the origin of the whole structure in descent. It has been designated a placental growth: is there any clue from development how it came to be? It has been pointed out (p. 414) that in the young sporangiophore of *Tmesipteris* the origin of the tissue of the sterile septum which separates the sporangia is similar to that of the sporogenous tissue, while in certain reduced sporangiophores the septum may itself be sporogenous. These facts point, in the simple case of *Tmesipteris*, to the conclusion that the septum is not essentially different from fertile tissue, and suggest that the whole body arose from the subdivision of a single sac, together with upgrowth of the adjoining tissues. In fact, that the sporangiophore is really a form of sorus, resulting from septation of a primitive fertile loculus, together with upgrowth of its receptacle or placenta: the separate loculi would thus be carried outwards with its growth. The facts of development as well as of distribution of the sporangiophores readily coincide with this view of its probable origin. There is a biological probability that this mode of progression to a more complex state should occur, for the nourishment of separate loculi is more readily carried out than that of one large one, while the scattering of the ripe spores is more certain where the sporangia project. Lastly, there is precedent for the conversion of sporogenous tissue into sterile in *Isoetes*, and apparently also in *Lepidodendron*, while numerous Angiosperms show septa in the anther, formed by sterilisation of fertile tissue in the manner here suggested.

On the grounds thus stated it appears probable that in the Sporangio-phoric Pteridophytes the sporangiophore is a non-foliar structure, arising either on axis or on leaf: that it is of placental origin, and bears outwards as it grows the sporangia, which may be regarded as the results of disintegration of a single primitive locus: that the syngial condition of these was the prior state, but that in most cases the sporangia have shown independent growth, and now project as separate sacs, often becoming inverted during development, a change which brings advantages of protection while young.¹

The general features of the shoot common to the Equisetales and Sphenophyllales may be summarised as follows:

1. The axis is the predominant part of the shoot: it is traversed by a monostele, which frequently shows the protostelic state, with solid xylem-core. All known types of vascular system in these phyla are referable in origin to that primitive structure.

2. The lower part of the plant is vegetative: there is a more or less definite and compact strobilus above, usually terminal: but in some there is an indefinite "*Selago*" condition, characterised by being more lax, and often also more effective for assimilation.

3. The leaves are simple or branched, in whorls (Equisetales and Sphenophylleae), or alternate (Psilotaceae).

4. The sporangia in variable number are disposed radially on the sporangiophores, which may be inserted either on the axis (Equisetales), or on sporophylls (Sphenophyllales), but still have an essentially uniform character in both types. They are held to be organs *sui generis*, of the nature of placental growths.

5. The sporangia are eusporangiate, and dehiscence by slits radially disposed and structurally defined.

6. In all cases which have been examined developmentally a considerable portion of the sporogenous cells distributed through the mass are disorganised without undergoing tetrad-division.

The plants thus characterised lend themselves readily to interpretation on a hypothesis of a strobiloid origin. The predominance of the axis in the embryology of *Equisetum* (the only sporangiophoric type in which it has been followed), as well as in the mature shoot of them all, is very striking, while the sporangiophores and leaves figure only as minor appendages: the primitive monostelic structure of the axis, with more or less definite cauline xylem-core, and insertion of the leaf-traces upon its periphery, also supports a strobiloid hypothesis from the point of view of internal structure. The existence of the undifferentiated "*Selago*" condition brings these plants into line with the Lycopods: the facts showing the relation of the sterile to the fertile regions would here be insufficient

¹With the above paragraphs, compare Scott, *Studies*, pp. 496-500: also *Progressus*, vol. i., p. 163, etc.

for consecutive argument, but their correspondence with those in *Lycopodium*, where the argument can be more fully developed, points to a clear analogy. Accordingly the facts may be held to indicate a probability that here also a progressive differentiation of sterile and fertile regions from an indifferent shoot which performed both functions has been effective, and that abortion of sporangia has played its part. That the strobilus which we see is the residual and now specialised fertile tract, while the vegetative system below has been initiated, or at least extended, by abortion of sporangia: this results in deferring the spore-production to a later period. Appendages of two sorts are recognised throughout, viz. the leaves and the sporangiophores: the former remain effective for assimilation or for protection in the lower vegetative region: in the strobilus the two may exist together, and even show intimate relations: or the sporangiophores only may be present, as in *Equisetum*, the true leaves being absent, perhaps by abortion.

As regards spore-output, continued apical growth and branching have served as a set-off against the progressive sterilisation in the region below. But in addition these plants illustrate a probable amplification of the spore-producing members themselves, by septation and upgrowth of the vascular placenta, resulting in the sporangiophore itself: this is a more effective spore-producing member than a single sporangium. Another method of advance has probably been by fission, which increases the number of sporangiophores; but this appears to have brought in its train a corresponding reduction in the number of the sporangia, as seen in *Sphenophyllum Dawsoni*. Thus both evidences of increase and of decrease in number of sporangia are illustrated in this, as in most other phyla of Vascular Plants.

Some idea of the probable origin and nature of the sporangiophore has been gained by the study of the Equisetales and Sphenophyllales. It is a member attaining a considerable size, and endowed with a vascular system, while it carries out the important function of spore-production. There is no *prima facie* reason why such a member should show any strict limitation of size. The larger it grew, the greater would be its capacity for producing fresh germs: there would thus be an inherent probability of its increase, rather than the reverse. When the question is asked whether such increase is illustrated in any forms of Vascular Plants, a debatable ground is reached in which the Ophioglossales are the subject of dispute. It is only by a careful study of their details that an opinion can be formed: this will now be taken up.

CHAPTER XXX.

OPHIOGLOSSALES.

THE Ophioglossales include three¹ genera of living plants: *Ophioglossum*, with ten species as described in Hooker's *Synopsis Filicum*, though Prantl distinguishes twenty-nine: *Botrychium* with about six, or according to Prantl fifteen species: and *Helminthostachys* with only one. The three genera have well-marked characters in common, so that there is no doubt of their natural affinity. The most distinctive is the fertile spike, a process which rises from the adaxial surface of the leaf, and serves as a basis for insertion of the sporangia: these are of the eusporangiate type, and are without any annulus. There is no early fossil that can be attributed with any certainty to this family, and thus, notwithstanding that the appearance of these plants is commonly held to be archaic, there is no direct evidence of any great antiquity. They have usually been classed with the Ferns, of which they have been held to be an outlying group. Other authors recognise certain characters as linking them with the Lycopodiales. A careful consideration of the evidence leads to the conclusion that they are best in place as an independent phylum of the Ophioglossales, and the justification of this will appear from the account of them now to be given. Any decision on the point of affinity is closely related to the question whether the organisms constitute an upgrade or a downgrade sequence. In the description which follows the various types of the family will be traced from the simpler to the more complex, and the discussion of their relationships will be left over to the conclusion, when the facts necessary for forming an opinion shall be before the reader.

¹The foundation of a fourth genus "*Scoptridium*" has been suggested by H. L. Lyon (*Bot. Gaz.*, Dec., 1905). It is based mainly upon embryological detail. I prefer for the present to suspend any decision as to the validity of this proposal, awaiting the detailed statement of the facts.

EXTERNAL CHARACTERS.

The plants of this cosmopolitan family are all perennials, and are for the most part underground-growing organisms, though some few are epiphytic. The method of their perennation is closely connected with their external form. Given a leafy shoot in an underground-growing organism, there are two ways in which it may be specialised so as to secure perennation, and often the arrangements are such as to fit in conveniently with alternating seasonal periods of activity and of rest. The one is by elongation of the internodes, accompanied by repeated branching: in this case the terminals of certain branches themselves appear above ground in the active season, and may die off at its close, the perennation being effected by the branching stock which remains in the soil: such shoots are usually small-leaved, and examples are seen in *Equisetum*, and in some of the more specialised species of *Lycopodium* and *Selaginella*, where the primitive upright habit of the main shoot has been discarded. The other method is by enlargement of the individual leaf, while the stock, which is sparsely branched or even unbranched, remains protected below: this is exemplified by *Isoetes* in a less pronounced form, but in its most extreme type by the Ophioglossaceae, and by some Ferns of such habit as *Pteris aquilina*. The stock itself in such plants is provided with sufficient storage-tissue, and may in some species be specially distended and tuberous (*O. crotalophoroides*, Walt., and *O. opacum*, Carmich.). This type tends to become monophyllous, with only one large leaf expanded in each season. The chief biological advantage in the monophyllous habit in a plant with a perennial stock lies in the fact that the soil presents an obstacle to the upgrowth of the tender young leaf: the difficulty of overcoming this is minimised by the production of only one leaf in each season, and that a large one. This would apply equally to the case of *Pteris*, and to that of the Ophioglossaceae.

It is then as organisms showing a peculiar specialisation for a perennating habit that the Ophioglossaceae are to be studied. There is one further point on which it is necessary to be clear at the outset: the Lycopods and the Horse-tails are small-leaved forms and show a similar method of perennation: but still they are held to represent distinct phyla. Similarly, though the Ophioglossaceae and the Ferns may show in common another mode of perennation, accompanied by large foliar development, still this does not in itself indicate any near relationship: for clearly leaf-enlargement is not the prerogative of one phylum only.

Taking first the genus *Ophioglossum*, the well-known species *O. vulgatum* occupies a middle position in the genus (Fig. 235): it consists of a short upright stock, covered externally by the scars of leaves expanded in previous years: thick roots, which are commonly unbranched (though occasionally showing dichotomy), and hairless, radiate from it, one being inserted as a rule below the base of each scar: but this arrangement is not rigidly

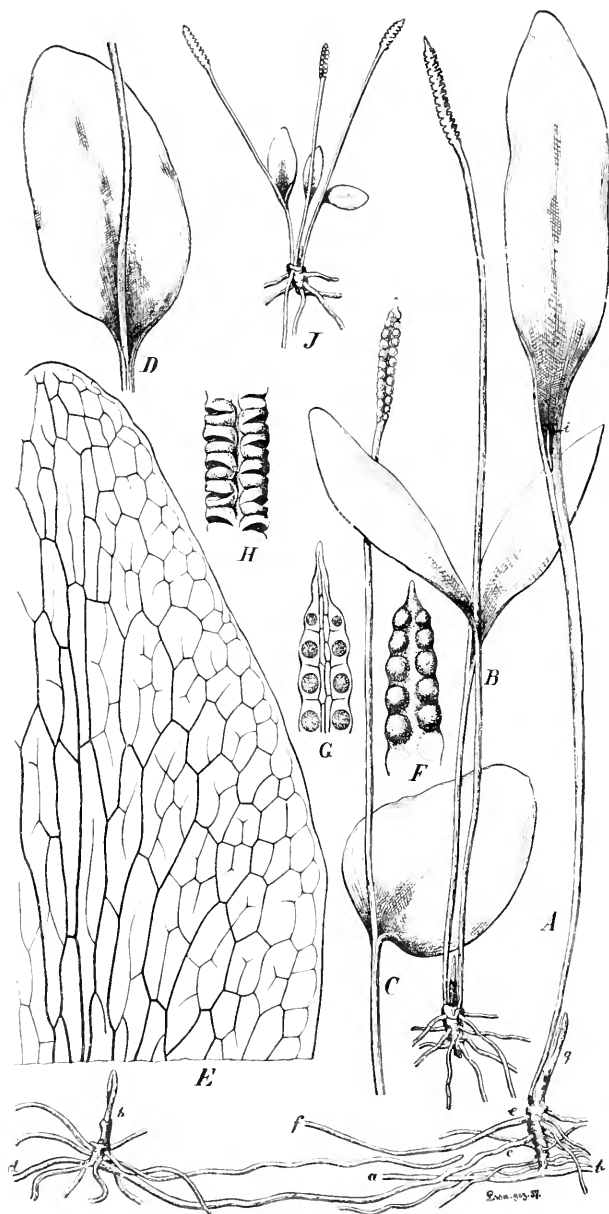

FIG. 235.

Ophioglossum vulgatum, L. A = old plant sprung as an adventitious bud from the root (a-b); from its stem have sprung further roots (c-d and e-f), from one of which again an adventitious bud (G) has arisen; g = the leaf for the next vegetative period, still unfolded; i = an abortive spike attached to expanded leaf. (After Stenzel.) B = an old plant with one sterile and one fertile leaf. C and D show form of leaf, with spike, and E, the venation. F, G, H = details of spike. J = *Ophioglossum vulgatum* var. *polyphylla* A. Br. The figures A-D and J are half the natural size. From Rabenhorst's *Krypt. Flora*.

maintained here, and is departed from in other species. The apex of the stock is occupied by a bud, and according to the season the outermost leaf (or sometimes two or more of them) may be extended above ground, or it may be still enveloped by the ochrea-like stipule of the preceding leaf (Fig. 236. 1, 2, 3). The bud on dissection shows that the apex of the axis is buried deep down among the successive leaves of the bud: each of these is provided with a large stipular sheath, which covers the bud, including all the succeeding spirally arranged leaves. There is no circinate venation. Each leaf develops slowly in the bud for three years, and expands in the fourth year. In spring the young leaf of the year, bursting the sheath of the preceding leaf, extends with an elongating petiole upwards, forcing its way through the soil: and the broadly ovate sterile lamina finally unfolds as a fleshy, undivided expansion, with reticulate venation. From its upper surface, at the point of junction with the lamina springs the fertile spike, a body which is stalked, and bears on either lateral margin of its upper part a dense row of sunken sporangia (Fig. 235 B, C, E, G): the tip of the spike is sterile. Terminal branching of the shoot is exceedingly rare: a case is recorded by Poirault. But that deficiency is made up by the frequent formation of adventitious buds: these may appear in relation to the axis (Fig. 236. 8), but more frequently upon the roots, where they arise in close proximity to the apex (Figs. 235 A, 236. 7).

These external characters of the mature plant of *O. vulgatum* represent typically the salient features of the Adder's Tongues; but to obtain a conception of the genus as a whole, it is necessary to examine other species, and they will here be taken in a sequence which is held to illustrate a morphological progression. The species are not all habitually monophyllous: several small species are found to be polyphyllous, showing constantly that condition which is exceptional in *O. vulgatum* (Fig. 235 B, J). Conspicuous among them is *O. Bergianum*: this rare little plant differs externally from other species in the fact that the fertile spike is inserted very low down upon the narrow linear sterile leaf, of which three or four are commonly expanded at once (Fig. 237). The number of sporangia on each spike may also be very small; but notwithstanding these differences, the general disposition of the parts is that usual for the genus. The polyphyllous condition which it shows is shared also by *O. bulbosum*, Michx (= *O. crotalophoroides*, Walt.), and especially by *O. nudicaule*, L. fil., where it appears to be common, and even habitual, four to six leaves being simultaneously expanded, and most of them bearing fertile spikes. In *O. lusitanicum* also, as well as in several other species, a plurality of leaves simultaneously expanded is the rule. That condition is most frequent in the smaller-leaved forms, and it may be held to connect the monophyllous habit as seen in the Ophioglossaceae with the polyphyllous strobiloid type common in other Pteridophytes.

But the genus shows a capacity for amplification of the parts of the

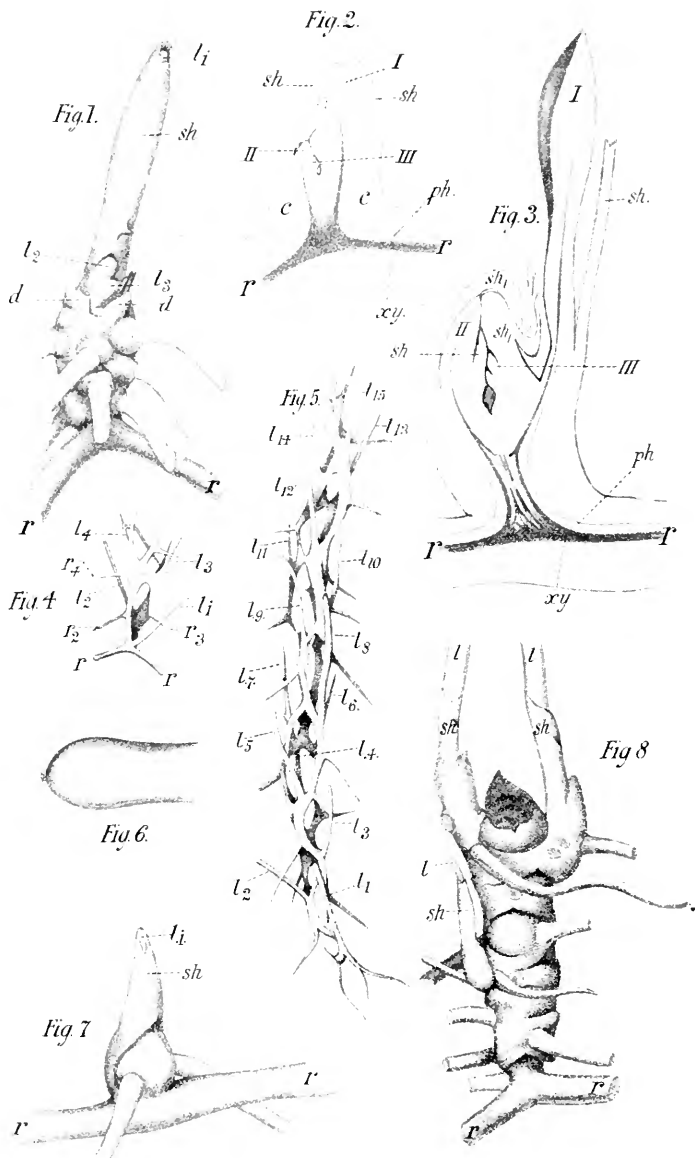

FIG. 236.

Fig. 1. Adult plant towards end of autumn; l_1 leaf of succeeding summer; sh its sheath; l_2 second leaf; l_3 third leaf; d debris of dead leaves; r parent root.

Fig. 2. Longitudinal section of a very young bud. I, II, III , leaves; c cortex; sh sheath; ph phloem.

Fig. 3. Longitudinal section of an older bud, where the first leaf (I) is expanded; sh, sh_1, sh_2 sheaths of successive leaves.

Fig. 4. Central cylinder of a very young bud prepared by maceration; r parent root; l_1, l_2, l_3 traces of successive leaves; r_2, r_3 successive roots.

Fig. 5. Central cylinder of an adult stem; l_1-l_{15} the traces of successive leaves.

Fig. 6. Enlarged apex of a root; the first phase of appearance of a bud.

Fig. 7. Bud slightly developed, where the first leaf has just pierced the sheath.

Fig. 8. A false branching.

individual leaf beyond what is typically seen in *O. vulgatum*, though characters which are usual in such species as *O. pendulum* or *palmatum* appear as occasional abnormalities in *O. vulgatum* and other species. The large series of examples in the Herbaria of Kew and the British Museum have been examined in order to elucidate these amplifications, and among the specimens compared gradual steps of progression are illustrated from the condition with a single spike to the most complex types of *O. palmatum*. Some of these are here illustrated. Fig. 238 A shows a specimen in which a single fertile spike rises from the adaxial surface of the frond, and it may be seen that the vascular bundles directly below its insertion continue upwards, and supply the centre of the sterile frond; the position appears to be exactly median, as in *O. vulgatum*. The specimen shown in Fig. 238 C also has a single fertile spike, but its position relatively to the two-lobed sterile frond is not so clearly median as in Fig. A. Fig. 238 D shows two fertile spikes of equal size, inserted almost symmetrically on the adaxial face of the four-lobed sterile frond; such a specimen, when looked at alone, might be thought to support the view suggested by Roeser, and adopted by others, that the fertile spike is the result of coalescence of two lateral lobes or pinnae; but a comparison of other specimens shows that no such view can be consistently supported, and Fig. 238 E shows a case which it would be difficult to bring into harmony with it; for here there are three fertile spikes of almost equal size, all inserted clearly on the adaxial surface of the sterile frond. The next specimen (Fig. 238 F) shows a larger number of fertile spikes, eight in all; every one is inserted well within the margin, on the surface of the frond, and in close relation to vascular bundles which supply the central part of it. Of the eight spikes, six are associated in pairs upon a common stalk, a character which is frequent in specimens where the number of spikes is large. Fig. 238 G shows one of the most elaborate specimens in the whole series, with 14 fertile spikes, of which only one is really marginal. Here again certain of the spikes are associated together, especially the lowest group of three, which have a common stalk of insertion. Sometimes, however, the fertile spikes are distributed with some nearer approach to regularity than in the above samples, and it is doubtless upon such specimens as that shown in Fig. 238 B that the descriptions of previous writers have been based. But it is to be remarked that such specimens are by far the least common among the herbarium plants examined. I was permitted to soak out the specimen shown in Fig. 238 B, preserved in the British Museum, and to arrange it so that the position



FIG. 237.

Ophioglossum Bergianum,
Schlecht. Whole plant,
slightly reduced.

and insertion of the parts could be accurately drawn. Now it is to be noted that not one of its spikes is actually marginal, but each is inserted upon the upper surface, just within the margin; that is most clearly so in the lower spikes, while the two lowest are seated near to the median line, and with their stalks so near to one another as to be even slightly united at the base. From the above specimens it will be sufficiently

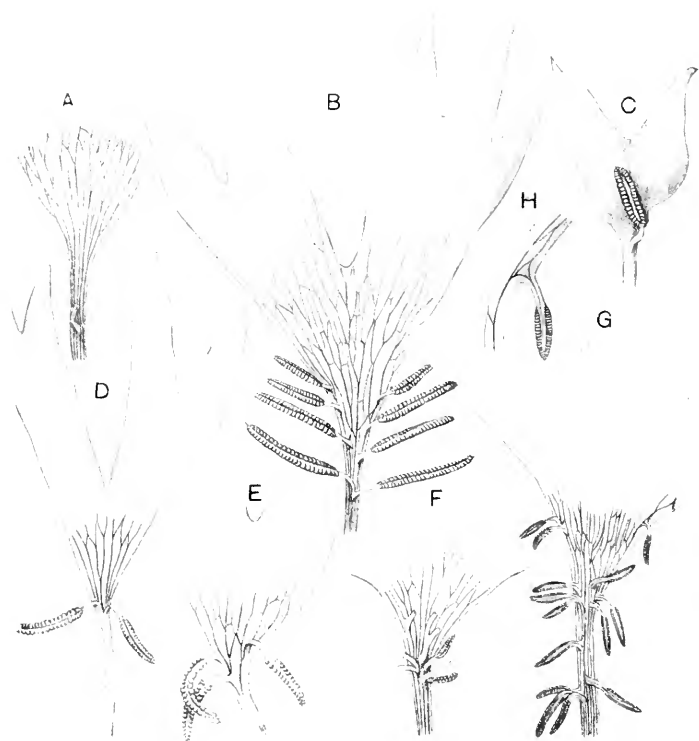

FIG. 238.

Ophioglossum palmatum, L. Drawings, slightly reduced, of specimens in the Kew Herbarium (excepting *B*, which is in the British Museum), showing the various arrangements of fertile spikes, and their insertion as a rule intra-marginal.

clear that though the fertile spikes may occasionally be marginal, the large majority of them are inserted upon the upper surface of the sterile frond, while the lowest are commonly most near to the median line.

There is a rough, though not exact, parallelism between the number of fertile spikes on a frond and the number of lobes of the sterile portion. In Fig. 238 *c* there are two lobes of the latter, and a single fertile spike; in Fig. 238 *d*, four lobes of the sterile (two incompletely separate), and two fertile spikes; in Fig. 238 *e*, two lobes of the sterile frond, and two fertile spikes; in Fig. 238 *f*, seven ill-defined lobes of the sterile and eight fertile spikes; in Fig. 238 *g*, eight lobes of the sterile frond,

and fourteen fertile spikes. Of 70 specimens examined in Kew and the British Museum, ranging from those with a single sterile lobe to eleven, and from one fertile spike to seventeen, the totals came out as follows :

Specimens observed, - - - - -	70
Sterile lobes, - - - - -	328
Fertile spikes, - - - - -	373

When these figures are taken together with observation of special cases as illustrated in the drawings, they demonstrate a substantial parallelism between the number of sterile lobes and of fertile spikes, though this parallelism cannot be pursued into exact numerical detail. It is plain, also, as illustrated by the above figures, that the leaves with most lobes are those which are broadest and have the largest assimilating surface ; thus, speaking generally, the number of fertile spikes increases with the increasing leaf-area.

It has already been pointed out that spikes in a truly marginal position are rare ; they do, however, occur, and Fig. 238 H shows one, together with its vascular connection with the marginal bundle of the sterile frond. The individual spikes correspond in form and general structure to the single spike of *O. vulgatum*. But many of them show various stages of branching. The following drawings (Fig. 239) illustrate such steps as may be seen in *Ophioglossum palmatum* : In Fig. 239 A are two spikes, each with an imperfect lateral branch, but in both the series of sporangia is continuous over the lateral protuberance. At the apex of each of the spikes of Fig. 239 D is an indication of branching of the same nature. The branching may be more elaborate, as in Fig. 239 B, where there are three borne upon one stalk, the series of sporangia along the margins of them all being interrupted, while it may also be noted that the vascular bundles are united below in the common stalk. But in other cases the series of sporangia may be interrupted (Fig. 239 C), so that the two branches now appear as two distinct spikes seated upon a common stalk, though the central vascular bundles unite below into a common bundle before their insertion on the vascular system of the sterile frond. Figs. 239 D and E are substantially similar, but show a more complete separation of the vascular supply for the two spikes ; while Fig. 239 F shows two spikes in which the stalks are completely separate to the base, though the two are inserted close to one another, and in the same relative positions as the branches in Figs. 239 C, D, and E.

The above series thus illustrate successive stages leading up to complete branching of the fertile frond. It has been suggested by Bitter¹ that the simpler examples are really young plants of *O. palmatum*, and it seems not improbable that this may actually be the case, and the progression be illustrated in the advancing life of the individual. However that may be, it is by comparison of *O. pendulum* and of abnormal cases of

¹ Engler and Prantl, i., iv., p. 456.

O. vulgatum that an understanding may be arrived at as to the true morphology of *O. palmatum*. The fertile spike in *O. pendulum* is commonly simple, and its insertion is very constant at a median point on the upper

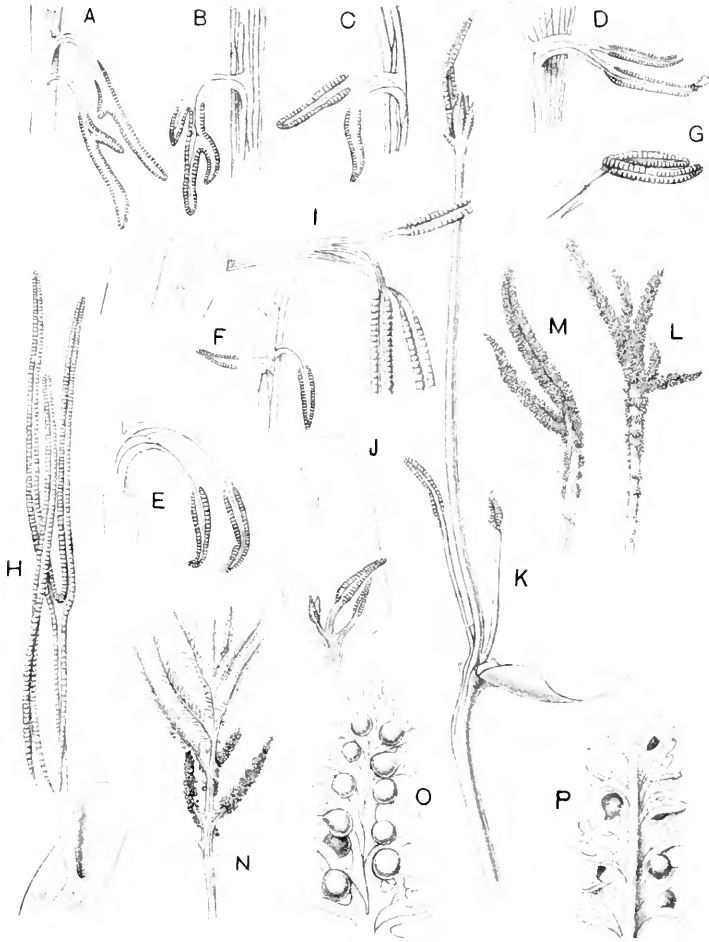

FIG. 239.

A-F=Various spikes of *O. palmatum*, showing details of branching and insertion. G, H, I=spikes of *O. pendulum*. J, K=abnormalities of *O. vulgatum*. L-P=abnormalities of *Helminthostachys*. O and P are from drawings by Prof. Goebel. A-V are one half natural size.

surface of the frond: it appears that there is no close parallel in this species between the lobing of the sterile and the branching of the fertile portions. The mode of branching of the spike, when it occurs, is substantially similar to that in *O. palmatum*. Figs. 239 G and H illustrate branchings in which the series of sporangia is almost or completely continuous over the branches, but in Fig. 239 I the series is interrupted,

and the three separate spikes are inserted by sterile pedicels upon a common sterile stalk. Thus the branching, though less common, appears to be similar in kind to that in *O. palmatum*.

Somewhat similar branchings, though less complete, are not uncommon in *O. vulgatum*. In the Kew Herbarium there are certain abnormal specimens which are of some interest in this connection. Fig. 239 J represents a plant of *O. vulgatum* taken in wet fields at Farnham, Surrey; from the upper surface of the sterile frond arise three fertile spikes, one of which is branched, while the point of insertion of another is at some little distance from the remaining two, which are seated close together. Though the details of insertion are not identical, this may be compared with the Fig. 238 E of *O. palmatum*, or as regards insertion of the spikes with Fig. 238 D. Another, and much larger specimen, showing a somewhat similar abnormality of *O. vulgatum*, is seen in Fig. 239 K; there are two leaves from the same plant, each bearing three fertile spikes, which have, however, a common insertion. Somewhat similar monstrosities are mentioned, as occurring rarely, by Luerssen.¹

In the Kew collection specimens of *O. reticulatum* also show abnormalities of a similar nature, though the branching is less complete: and these specimens will serve to show that such abnormalities cannot be used to support the view that the fertile spike is a result of fusion of two pinnae. One specimen from the Society Islands (Bidwell, Herb, Hook) shows an equally bifurcated fertile spike, with a long sterile stalk: this might appear to support the hypothesis of coalescence: but another specimen from Java (Lobb, Herb, Hook) shows three branches, of which the central one is the strongest; comparison should also be made of Figs. 239 J, K of abnormalities in *O. vulgatum*; such cases as these would be entirely inconsistent with the theory of coalescence as supported by abnormalities. It must therefore be concluded from the genus, as we should already have judged from the cases of *O. palmatum* and *O. pendulum*, that the forms which the fertile spike occasionally assumes, gives no constant support to the hypothesis of coalescence of lateral pinnae. This being so, and taking also into account generally the facts of branching and insertion of the fertile spike or spikes in the genus, the hypothesis that the fertile spikes are of the nature of pinnae or leaf-segments appears to receive no consistent support. On the other hand, all the facts are consistent with an hypothesis of chorisis of a single original spike, holding a median adaxial position: and it may be concluded that in *Ophioglossum* a fission, occasionally seen in such species as *O. vulgatum*, has become habitual in *O. palmatum*, and in less degree in *O. pendulum*. This is interesting for comparison with what is seen in certain of the Sphenophyllales, where fission of the sporangiophore appears to have occurred.

But besides such probable amplifications within the genus, there is also a line of probable simplification: it is seen in the new species,

¹ Rab. *Krypt. Flora*, vol. iii., p. 544.



FIG. 240.

Botrylium simplex, Hitchc. Developmental series of forms in alphabetical succession; a-f—*forma simplicissima*, Lasch, that is young stages of development; g-k—*forma incisa*, Milde; and l—transition to *forma subcomposita*, Lasch. m and n; m has an enlarged fertile basal segment of the sterile leaf; o-r—*forma composita*, Lasch; r with four primary segments of the sterile part. The description is from Luerssen in Rabenhorst's *Krypt. Flora*, and the drawings were from specimens in his herbarium. Natural size.

O. simplex, Ridley.¹ This ground-growing mycorrhizal plant has tall fertile spikes, without any sterile lamina. Anatomically as well as in form it resembles *O. pendulum*; but more especially in its external characters and its habit it resembles the rare *O. intermedium*, Hook, which is also a ground-growing species. For reasons explained at length in the paper above quoted, it is thought that *O. simplex* forms the end of a series of reduction of the vegetative system consequent on a mycorrhizal habit and shaded habitat: that as *O. intermedium*, when compared with *O. pendulum*, shows a relatively large spike but only a reduced lamina, so in *O. simplex* the reduction having proceeded further has resulted in the complete elimination of the sterile blade.

In the genus *Botrychium* the construction of the upright stock is essentially similar to that of *Ophioglossum*, and the plants are habitually, though not always monophyllous. The main external difference lies in the branched form both of the sterile leaf and of the fertile spike: these parts show a similar parallelism of ramification to that which is present though less regular in *O. palmatum*. According to the complexity of the two parts the species may be arranged, starting from those very small and simple forms included under the name *Botrychium simplex*. These are held by Luerssen not to be actual varieties, but rather plants of various ages, and therefore in different stages of development which pass into one another, a point which greatly increases their interest (Fig. 240). The sterile leaf in the smallest of these may be entirely unbranched, as in a small *Ophioglossum*, while the fertile spike is also unbranched, and bears a very small number of sporangia (Figs. 240 A-F): these appear in the simplest cases as individual lateral projections from the spike, but here, as in the whole genus, they are disposed along its lateral margins, in the same relative position as in *Ophioglossum*. The steps from this simple condition are clearly shown in Luerssen's drawings (Figs. 240 G-L), lobation of the sterile leaf progressing in marked parallelism with branching of the fertile spike: first a simple pinnation, and then an incipient double pinnation. The condition is thus attained which is seen in the common *B. Lunaria* (Fig. 241), where the pinnation in its different forms may be single or double. And so onwards through the species, the sterile leaf may be three (*B. daucifolium*), or even four times pinnate (*B. virginianum*), the fertile spike showing a corresponding complexity. The whole genus from the simplest to the most elaborate, shows such gentle gradations of change that the unity of type throughout is unmistakable.

Various abnormal modifications have been described for *Botrychium*, some of them involving the formation of accessory parts, such a doubling of the sterile leaf, or increase in number of the fertile spikes, as in *Ophioglossum*; but no species of *Botrychium* is recognised in which this is established as a permanent character. The abnormalities involving distribution of the sporangia are the most important: all stages of vegetative

¹ See *Ann. of Bot.*, 1904, p. 205.

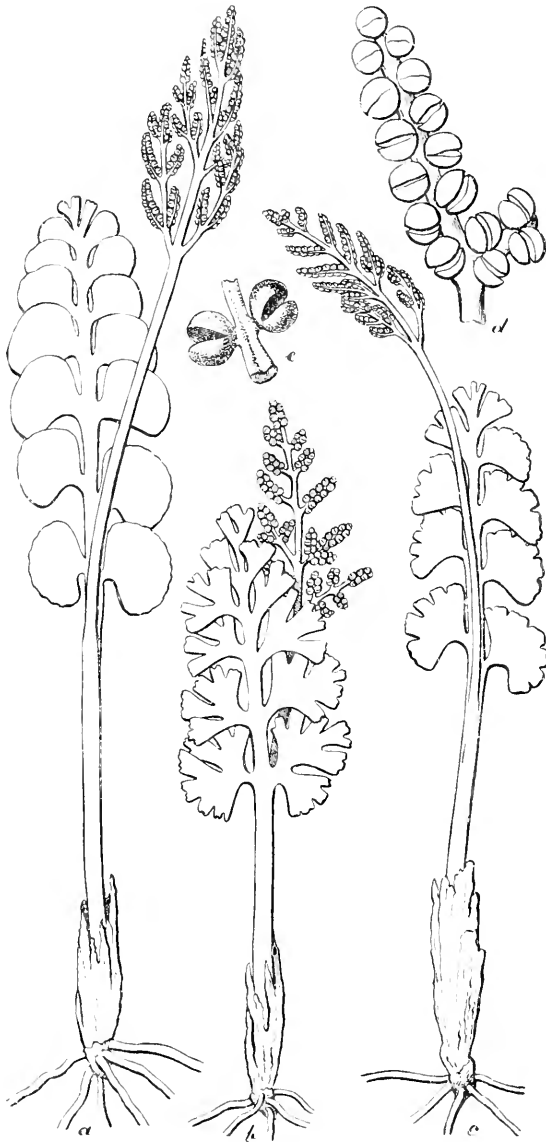

FIG. 241.

Botrychium Lunaria, Sw. *a*—*forma normalis*, Roeser. *b*—var. *incisa*, Milde. *c*—var. *subincisa*, Roeser. All of natural size. *d*—part of the fertile spike, with open sporangia, enlarged. *e*—two open sporangia somewhat bent asunder, to show their attachment, enlarged. From Luerssen in Rabenhorst's *Krypt. Flora*.

development of the fertile region have been described, even up to its complete replacement by a sterile structure quite like the normal sterile leaf: this will rank as "phylloidy." But, on the other hand, it is

not an uncommon thing for sporangia to appear upon the sterile leaf: an example of this is shown for *B. simplex* in Fig. 240 M, but it is more clearly shown in specimens of *B. Lunaria* (Fig. 242). Moreover, not a part only, but even the whole of the normally sterile lamina may be thus occupied, and Goebel quotes a locality on the Ostsee where this condition has become constant.¹ The importance of this from a theoretical point of view will be discussed later.



FIG. 242.

Botrychium Lunaria. Sterile laminae, which occasionally produce sporangia (*sp*) on certain pinnae, and have partly or wholly assumed the form of the fertile spike: *f* in *B* and *C* is the fertile spike itself. Natural size. (After Goebel.)

The third genus, *Helminthostachys*, differs from the others in having a creeping rhizome, which is markedly dorsiventral, bearing the leaves in two rows on its upper surface, while the roots spring from its flanks and under surface (Fig. 243). The individual roots are not definitely related to the leaves either in number or position, a condition comparable with *Botrychium* rather than with *Ophioglossum*: they branch monopodially, and are hairless. The rhizome is normally unbranched² and perennial, serving

¹Schenk's *Handbuch*, vol. iii., p. 112.

²Farmer (*Ann. of Bot.*, xiii., p. 423) found that adventitious branches were frequently seen on old, almost decorticated parts of the rhizome of *Helminthostachys*. Gwynne-Vaughan (*Ann. of Bot.*, xvi., p. 170) has described how in the axil of each leaf, and even of the leaves of young seedlings, a narrow oblique invaginated channel leads through the cortex to a point just outside the stele, at the upper limit of the leaf-gap. A mass of parenchyma, covered in except at its apex by an extension of the endodermis, and terminated by a small, obliquely truncated, conical projection extends outwards from the stele to meet this invaginated channel. He suggested that these structures represent vestigial axillary buds, and that possibly the ancestors of *Helminthostachys* branched more copiously than the present plant. Gwynne-Vaughan's recognition of their bud-character received its full justification by the discovery of similar bodies in *Botrychium Lunaria* by Bruchmann (*Flora*, 1906, p. 226), which actually develop into lateral branches. He found them present chiefly upon young plants, and traced their origin each from a single superficial cell of the rhizome: they occur especially where the axis

as a storage-body. The leaves are inclined right and left of the median line in acropetal succession, one as a rule but sometimes more rising above ground in each season. The leaf shows a similar stipular structure to that seen in others of the family: upwards it consists of a stout petiole, with a large lamina usually ternate, each of the divisions being again subdivided. From their point of junction rises the fertile spike, which is adaxial as in other Ophioglossaceae. But the chief distinctive point is in the structure of it: for numerous sporangiophores each bearing several sporangia are disposed in dense serried ranks right and left—that is, in positions corresponding to the rows of sporangia in *Ophioglossum* (Figs. 244 and 83).

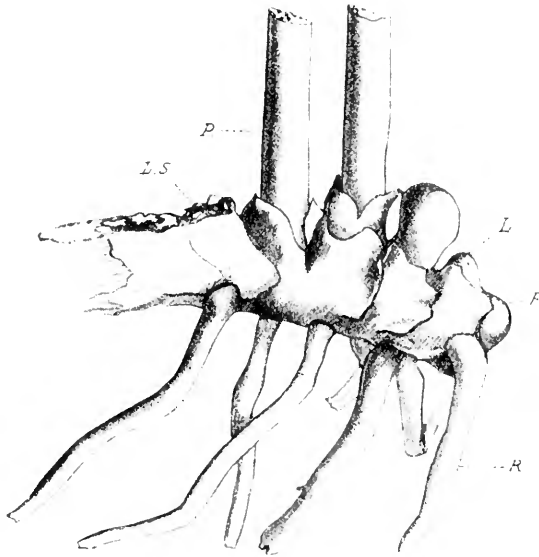

FIG. 243.

Helminthostachys zeylanica, Hook. Rhizome. Natural size. *F*=flap; *R*=root; *L*=leaf; *P*=petiole; *L.S.*=leaf scar. (After Farmer and Freeman.)

The spike of *Helminthostachys* not uncommonly shows irregular accessory branchings, such as those seen on Figs. 239 L, M. These may be combined as in *Botrychium* with correlative vegetative growth where sporangia are absent (Fig. 239 N), while the details of these show in a beautiful manner

becomes elongated as an internode: the initial cell is gradually overarched by upgrowth of the surrounding tissue, while by its sunken position it remains in close relation to the vascular system of the rhizome. The single cell meanwhile divides into a cell-group, and may continue to grow, forming a leafy bud. Bruchmann compares this bud-formation with that of lateral buds in many Ferns. The comparison may also be made with the lateral buds of *Equisetum*: the deeply sunken position compares not only with these, but more particularly with that seen in the tuber of *Phylloglossum*: in fact, the sunken character in the Ophioglossaceae has probably, as in these plants also, been assumed in relation to the underground habit.

the balance which may subsist between the vegetative and sporangial development (Fig. 239 o, p). Such changes are in line with those observed in other Ophioglossaceae, and will with them have to be considered in relation to general questions below.

It is easy thus to arrange the Ophioglossaceae in sequence, starting from simple beginnings and proceeding to those which show greater complexity,

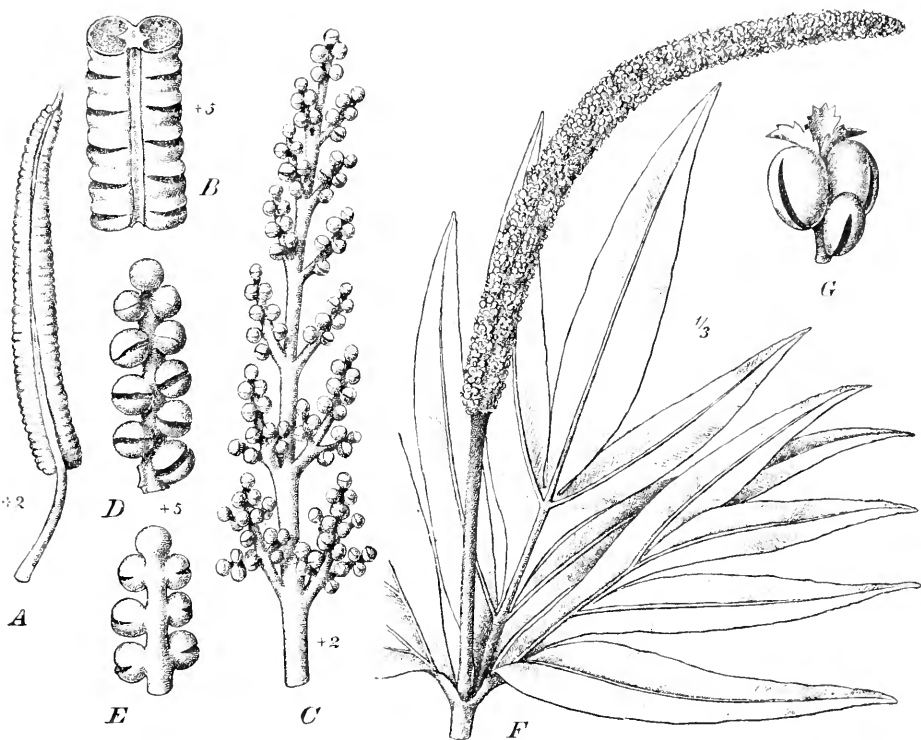

FIG. 244.

A, B, Ophioglossum palmatum, L. *A* = a single fertile spike with sporangia still closed. *B* = part of the same with sporangia ruptured. *C-E* = *Botrychium Lunaria*, Sw. *C* = a fertile spike. *D* = a branch of the same with ruptured sporangia, seen from within. *E* = the same seen from without. *F, G* = *Helminthostachys zeylanica*, Hook. *F* = sterile and fertile regions of the leaf. *G* = branch of the latter with a group of sporangia, and at the apex the lamina-like terminals of the fertile appendage. (After Bitter in Engler and Prantl, *Nat. Pflanzenfam.* *D* after Luerssen. *F, G* after Hooker-Baker.)

whether of the vegetative or reproductive parts. It will remain to be seen whether such sequences have any probable relation to truly phyletic lines when the internal structure and development have been considered, together with the comparison of the details with those of other Pteridophytic types. But, meanwhile, it appears certain that the three genera form a natural group: the sterile leaf and the fertile spike are homologous throughout, so also is the stock, notwithstanding that it is upright and radial in *Ophioglossum* and *Botrychium*, but creeping and dorsiventral in

Helminthostachys. Such a difference is of common occurrence within near limits of affinity. For reasons given in Chapter XVI. the upright radial type will be held to be the primitive, and the dorsiventral as seen in *Helminthostachys* the derivative: it is interesting to note that this goes along with a large and heavy leaf-development.

While, however, there may be no doubt of the homology of the spike in all the three genera, it is to be noted that the level of its insertion upon the adaxial face of the sterile leaf is not constant. In most species of *Ophioglossum*, as also in *Helminthostachys*, it is at the base of the sterile lamina; but in *O. Bergianum*, where there is no differentiation of petiole and lamina, it is but a short distance above the insertion of the leaf itself upon the axis. In *O. palmatum* it has been seen that the numerous spikes may be distributed over a considerable length of the basal region of the lamina. In *Botrychium* the differences in respect of level of insertion are more marked: in *B. Lunaria* it is usually a short distance below the lowest pair of pinnae; in *B. ternatum* it may be about four inches below them, and about two inches from the base of the frond: in *B. daucifolium* the insertion may be close to the base of the frond; but in *B. virginianum*, on the other hand, it may be above the second pair of sterile pinnae. The chief question in the morphology of the Ophioglossaceae will be as to the real nature of this member, which shows so variable a level of insertion, though it maintains in a remarkable degree its constancy of character, as well as its position upon the upper face of the leaf. A knowledge of its development and internal structure will be essential before arriving at any definite conclusion.

Lastly, in comparing the shoot of the Ophioglossaceae as a whole with that of the strobiloid types, the essential relation of leaf to axis is the same. The nearest resemblance as regards general proportion is with *Isoetes*, both having the stunted axis and spiral arrangement of the relatively large leaves: one main difference lies in the tendency to the monophyllous habit in the Ophioglossaceae, which may be held to be a consequence of its perennation underground. It has been seen that in *Isoetes* all the leaves of the mature plant show evidence of being potentially fertile, but that an early abortion of the sporangia leaves some of them sterile. A similar abortion is seen in the Ophioglossaceae: in *O. vulgatum* a rudimentary spike is often to be seen on apparently sterile leaves, as a small peg-like growth in the place where the normal spike would be inserted: it is shown in Fig. 235 A, letter *i*. In other cases it may be found that no vestige of the spike remains. Similar abortive spikes have been seen in *O. reticulatum* and *pendulum*. In *Botrychium Lunaria* and *simplex* extraordinarily small plants are found to bear fertile spikes, proportional in size to the sterile lamina: but in some cases of small, weak plants the fertile spike appears to be entirely absent. In *Helminthostachys* Lang observed that abortive fertile spikes are commonly found, subtended in each case by a fully developed sterile lamina. It thus appears that the

fertile condition of the leaf is normally the rule in the family; but that the fertile spike of the Ophioglossaceae behaves like the sporangiophore of the Psilotaceae, or the sporangium of *Isocetes* or *Lycopodium* in the matter of its abortion: this is complete in some leaves, while in others a vestigial structure remains to show what has occurred. Further, though their tendency towards a monophyllous habit may make such a comparison less obvious, the Ophioglossaceae show essentially a "*Selago*" condition of the shoot, that is, an imperfect differentiation of the vegetative and reproductive functions. Their condition would, in fact, be consistent with a strobiloid origin, modified in further development by enlargement of the appendages, all of which were originally fertile. This matter will be referred to again in connection with the early appearance of the fertile spike in the young seedling plant.

SPORE-PRODUCING MEMBERS.

The development of the fertile spike has been traced in *Ophioglossum* from its first beginnings.¹ The leaf itself originates very close to the initial cell of the deeply depressed apex of the axis. The sheathing stipule which envelopes the growing point as well as all the later leaves, is formed early: the spike appears above it in a median position on the adaxial face of the leaf, but near to its base (Fig. 245). The outgrowth is at first bluntly rounded, but it soon becomes more acute and turned upwards: it consists of several cells, and of these the uppermost, which is already the largest (*x* in the Figs. 246 A, B, C, E), undergoes further segmentation with some degree of regularity: its segments go to form the bulk of the free portion of the spike. The form of the initial cell is that of an irregular four-sided pyramid, but in some cases at least its identity is soon lost, and the type of construction passes over to that with four initials (Fig. 246 F, G). As a consequence of further subdivisions, whichever be the type of the initial segmentation, the spike comes to be composed of four quarters, separated by walls at right angles, as seen in the transverse section: its form is that of an elongated cone, slightly flattened on its adaxial and abaxial sides. Sections of it, transverse, radial, and tangential, are shown in Figs. 247 A-D: from these it appears that a special band of cells, the sporangiogenic band, runs along the lateral margins of the slightly flattened

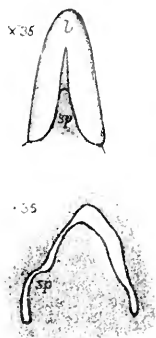

FIG. 245.

Ophioglossum vulgatum. The lower drawing shows a longitudinal median section of a young leaf, with the spike (*sp*) arising about half-way up its adaxial face. The upper drawing shows a rather older leaf in frontal view. $\times 35$.

¹ The account here given is condensed from the full statement (*Studies*, ii., pp. 10-27), where the literature is quoted. The development has been worked out for three species: *O. vulgatum*, *reticulatum*, and *pendulum*.

spike, in the position ultimately to be occupied by the series of sporangia: it is derived from two regular rows of cells, which form part of the two abaxial quarters of the spike; but the usual regularity of their arrangement is liable to interruptions. It is from this band that the sporangia arise, constituting when mature the continuous, linear series of them seen in the drawings of the mature spike. But they are not always regular, and exceptions may be seen where the sporangia are imperfectly partitioned or of anomalous outline. This is not surprising in bodies so nearly related to one another from the first.

The two series of superficial cells composing the sporangiogenic band soon divide periclinally, as well as in other directions, and form a broad

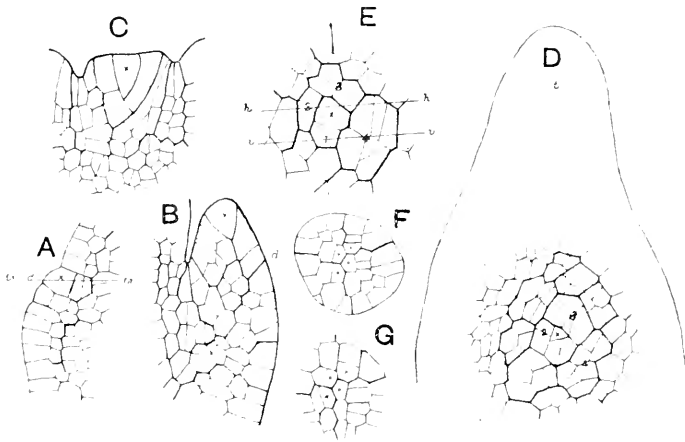

FIG. 246.

Ophioglossum vulgatum, L. *A*=median-radial section through a very young spike showing an initial cell (*v*). *B*=similar section of an older spike. *C*=transverse section of a leaf, as along a line (*tr*) in *A*, traversing the young spike. *Ophioglossum reticulatum*, L. *D*=tangential section of leaf (*l*) traversing the young rudiment of a fertile spike. *E*=another section from the same series, including the outer surface of the projecting spike. *F*, *G*=transverse sections from the apex of a young spike of *O. vulgatum*, showing a construction with four initials. All Figs. $\times 100$.

and deep tract of tissue from which the sporangia are differentiated. In position and origin they compare with those superficial cells which in other Pteridophytes give rise to the essentials of the sporangia. The differentiation shows various successive steps leading to the final definition of those cells which are to form the spores. It will be readiest understood from the structure seen in the large spike of *O. pendulum* (Figs. 248, 249). Here certain cell-groups derived from the inner products of the sporangiogenic band soon begin to show more dense protoplasmic contents: these are recognised as sporogenous groups, and are seen in transverse section in Fig. 248 *A*, in radial section in Fig. 248 *B*, and in tangential section in Fig. 248 *C*. The result is that the inner product of the band is segregated into alternate blocks of sterile and

fertile tissue, while the outer tissue begins to constitute the protective wall. But the whole of the cells composing these sporogenous groups do not become matured into spores: for a peripheral part of each group takes the character of tapetum, and becomes disorganised as the development

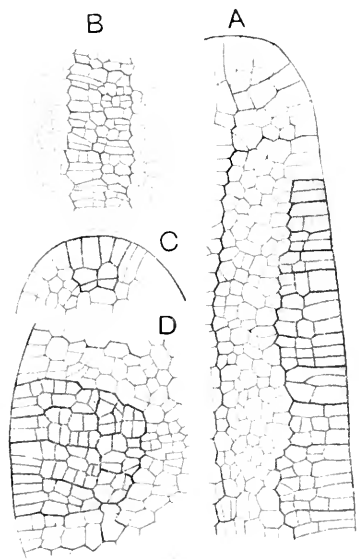

FIG. 247.

Ophioglossum vulgatum. *A*=part of a longitudinal section including the apex of the fertile spike, and traversing the sporangiogenic band longitudinally. *B*=tangential section, following the sporangiogenic band, and showing the regularity of its cells. *C*=lateral part of a transverse section of a spike; the cells shaded are recognised as the sporangiogenic band. *D*=a similar section showing an older state. $\times 100$.

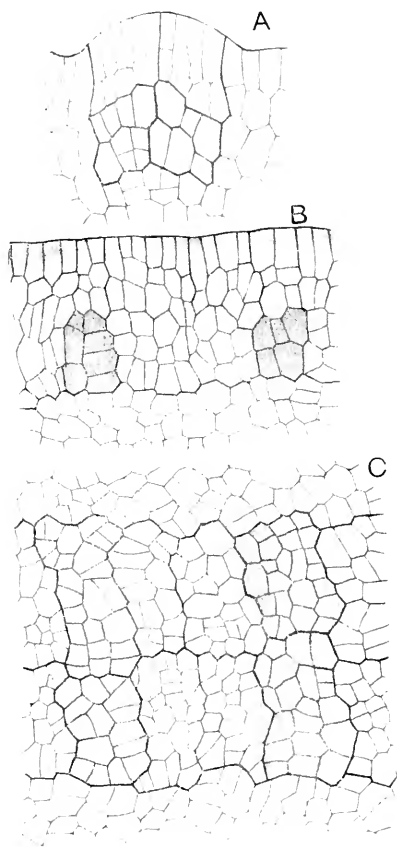

FIG. 248.

Ophioglossum (Ophiocerna) pendulum, L. *A*=transverse section of spike showing sporangiogenic band. *B*=longitudinal section following it, and showing it already differentiated, with sporogenous groups. *C*=tangential section of a spike of like age, also showing two sporogenous groups. $\times 100$.

of the spores proceeds. The outline of the definitive sporogenous group which remains is very variable: sometimes it is relatively regular, as in Fig. 249 D: but in other cases, which may even occur in the same sections as the regular ones, the disposition of the cells is less regular. These have probably arisen from parts of the sporangiogenic band which

were of irregular construction from the first, as above described. It is thus seen that in *O. pendulum* only a comparatively small residuum of the original sporangiogenic band finally remains as fertile tissue. Meanwhile, in the broad bands of sterile tissue which have thus been initiated between the sporangia, vascular bundles make their appearance, connected as branch-bundles with the general system of the fertile spike (*cf.* B, Fig. 249 D, and Fig. 250): in those cases where the arrangement is regular they may occupy a definite position, corresponding very nearly to the point of

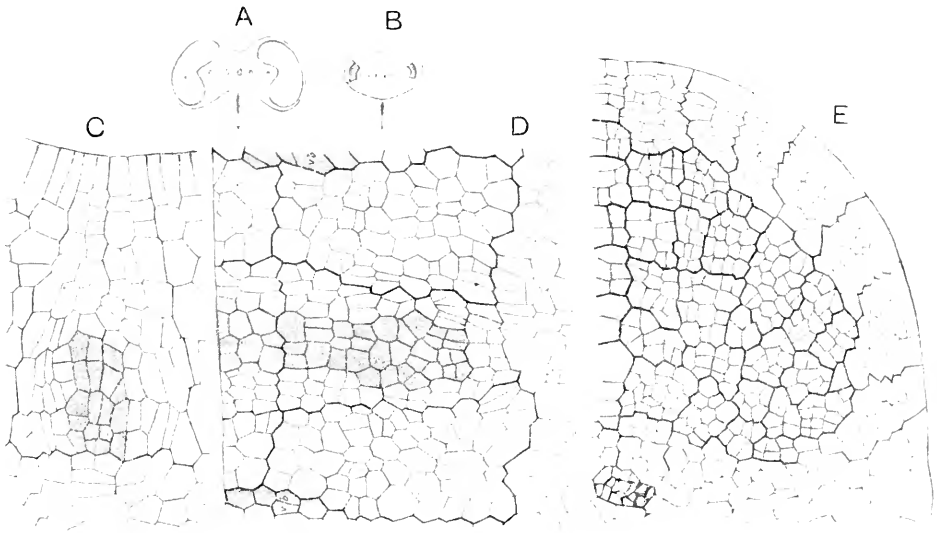

FIG. 249.

Ophioglossum (Ophioderma) pendulum, L. A, B—transverse sections of spikes of different ages to show sporangia and vascular bundles, slightly enlarged. C—a single sporangium, older than in Fig. 248, seen in longitudinal radial section; the tapetum lightly shaded surrounds the darker sporogenous mass. D=tangential section of corresponding age, showing one sporogenous mass shaded; the smaller shaded groups will form the vascular strands. E=part of a transverse section of an older sporangium of *O. reticulatum*. $\times 100$.

intersection of the lines limiting the cell-groups of the original sporangiogenic band. In certain cases, where the segmentation is regular it appears that one sporangium is referable in origin to two of those cell-groups, but it cannot be said that it is always so: frequently the arrangement is irregular, and in any case the single sporangium cannot readily be referred in origin to a single parent-cell.

Examination of the young spikes of *O. vulgatum* and *reticulatum* shows that in all essentials the development is the same, though naturally with differences of detail and proportion in those less bulky species. In them it is also impossible to refer each sporangium to a single parent cell. Further, it has been shown in them that the archesporium is not hypodermal in the strict sense, that is, that it is not cut off once for all by one periclinal wall or walls, but that successive additions may be made

to it, as in certain other Pteridophytes, by successive periclinal divisions. The structure of the sporangium as it approaches the stage of separation of the spore-mother-cells and of the tetrad-division is shown in Figs. 249 and 250: in the latter the relation of the vascular strands to the sporangium is already clearly indicated, especially of those which pass outwards in the thickness of the septum. The tapetum appears to be variable: in *O. vulgatum* it consists of several ill-defined layers of cells. This is seen in Fig. 251 A, B, which illustrates the steps leading to tetrad-division in that species: the cells of the tapetum first lose their identity, their protoplasts fusing into a continuous plasmodium surrounding the sporogenous cells, while the nuclei persist, and apparently increase in number by fragmentation. The plasmodium penetrates between the sporogenous cells, the whole mass being first broken up into irregular blocks (Fig. 251 A), and later into individual cells (Fig. 251 B). Normally all these spore-mother-cells undergo tetrad-division, and form spores.¹ When ripe each sporangium bursts by a horizontal slit, already defined structurally in the tissue of the wall: it gapes as the tissues dry up, but there is no mechanical annulus.

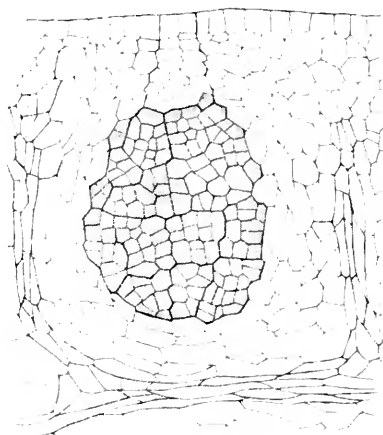

FIG. 250.

Ophioglossum reticulatum, L. Longitudinal section through a sporangium before separation of the spore-mother-cells; the walls of the vascular tissue are drawn in rather more heavily. $\times 100$.

The origin of the leaf in *Botrychium*, as well as that of the fertile spike which it bears, has been described by Bruchmann for *B. Lunaria*.² He found that the fertile spike originates in the same position relative to the sterile leaf as in *Ophioglossum*, but much nearer to its apex; indeed, at the period when they may first be recognised by their respective initial cells, these are in close proximity to

¹The statement of Rostowzew that a large number of spore-mother-cells are disorganised, and contribute with the tapetum to the nutritive plasmodium, was adopted by me in *Studies*, ii., p. 20, as it appeared to accord with my own rather limited observations. A re-examination of the question, for which a number of slides of *O. vulgatum* were lent by Professor Farmer, has shown that this is an error: as had been already noted for *O. reticulatum* by Burlinghame (*Bot. Gaz.*, July, 1907, p. 34). Occasional cells may be disorganised (Fig. 251 B), as may happen in any large sporangia; but normally there appears to be no systematic disorganisation, such as is seen in *Equisetum* or the Psilotaceae.

²*Flora*, 1906, p. 213.

one another, that of the spike probably originating from one of the latest adaxial segments of the leaf-initial (Bruchmann, *l.c.*, Fig. 55). Though this close proximity of origin of the fertile body to the apex of the sporophyll differs from what has been seen in *Ophioglossum vulgatum*, still it has its parallel in the case of *Tmesipteris*, as already described: the details of segmentation are not the same, but the relation to the whole leaf is similar. Both parts in *B. Lunaria* retain their active initial cells till about the time of origin of the lateral pinnae: and it is specially to be

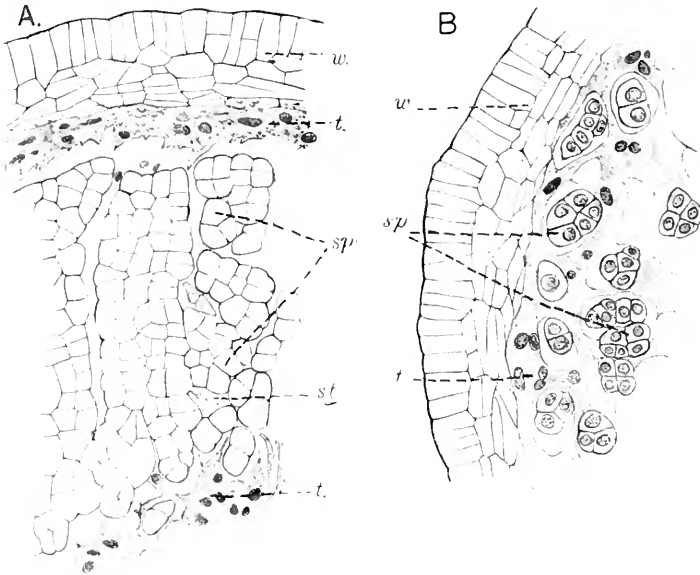

FIG. 251.

Ophioglossum vulgatum, L. Portions of sporangia showing the sporogenous tissue in two stages of disintegration. In *A* the tapetum (*t*), evidently derived from more than a single layer of cells, has formed a plasmodium with many nuclei, which is beginning to penetrate the sporogenous tissue, in which an occasional cell (*st*) is seen disorganised. *B* shows a more advanced state, where the sporogenous cells (*sp*) appear in small clusters, or isolated, embedded in the tapetal plasmodium (*t*); *w*=sporangial wall. $\times 100$.

noted that the origin of these in *Botrychium* is by a process quite distinct from that of the fertile spike: the latter appears in a median position with a definite apical cell from the first: the pinnae arise in acropetal succession by marginal growth.¹

The disposition of the sporangia on the fertile spike of *Botrychium* is essentially similar to that in *Ophioglossum*, but they differ in being further apart, and not laterally coalescent, except in individual cases. The similarity is most readily recognised in the simplest examples (Figs. 252 *A*, *B*, *C*), in which the number of sporangia may be very small: these are disposed in lateral rows, obliquely facing the sterile frond: their position

¹*L.c.*, p. 218.

is shown by comparison of Fig. 252 A and D. The similarity of these simple fertile spikes to those of the smaller species of *Ophioglossum*, such as *O. Bergianum*, is plain enough: if we imagine the sporangia in this plant to be somewhat more prominent, less bulky, and their position slightly altered, so as obliquely to face the sterile frond, the result would be such a type as is seen in the simplest forms of *Botrychium*. From these simple forms to the more complex, even to those in which the spike attains its largest development, is a progression which may be traced by very gradual steps: the first of these steps is illustrated by the Figs. 252 A, B, C: in the first figure (A) two lateral rows of simple sporangia are seen: in (B) the place of one sporangium is taken by two coherent together, while in the third (C) there are at the base of the spike, which is simple above, two "branches," the one with two sporangia and the lower one with three. These specimens will illustrate the gradual steps towards branching of the spike which are to be found in the simplest types of *Botrychium*. Sections also bring out some interesting points: Fig. 252 E represents in outline under a low power a transverse section of a spike of *Botrychium Lunaria* traversing two of its lower branches longitudinally, and following the series of their sporangia: this shows the acropetal succession of development of the sporangia, while it will be noted that the two lowest on the right are coherent to form a synangium—a matter of common occurrence, and corresponding to what is seen in Fig. 252 B.

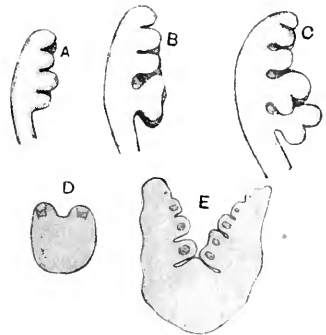

FIG. 252.

Botrychium Lunaria, L. A, B, C = three very simple spikes. A shows no branching, but only two rows of sporangia, of arrangement like those of *Ophioglossum*, but projecting further. B and C show simple cases of branching enlarged. D, E show transverse sections of spikes; D close to the apex, E lower down; the latter follows two branches longitudinally, and traverses their sporangia. Note the synangium on the right-hand branch. X about 20.

Such simple observations as the above, which might readily be extended into further detail, will suffice to show that it is possible to illustrate, from simple though otherwise normal specimens, how a transition may have taken place from the condition of the spike similar to that of a small *Ophioglossum*, through the simpler types of *Botrychium* to the more complex branched spikes.

But it is in the large *B. daucifolium* that a better opportunity has been found of observing intermediate steps between the single normal sporangium and a twin pair of them: the series Figs. 253 A-G illustrate this: Figs. A, C show sections of young sporangia of normal type, with sharply curved contour: others are of broader form, and show a considerable mass of tissue on either side of the sporogenous group (Figs. D, E): in these there may be seen cells laterally adjoining the latter, and obviously of similar origin and position (x in Fig. D), which, though

corresponding in every other respect, do not assume the dense protoplasm of sporogenous cells. These more bulky sporangia lead on to such as that shown in Fig. 253 E, in which it is possible that the whole sporogenous group is referable to a single parent cell, though the proportions of the whole group are quite different from those of the typical sporangia: the sporogenous cells appear, however, to form two groups, and probably originated from two similar cells side by side. The interest of this lies in the fact that these broad sporangia approach

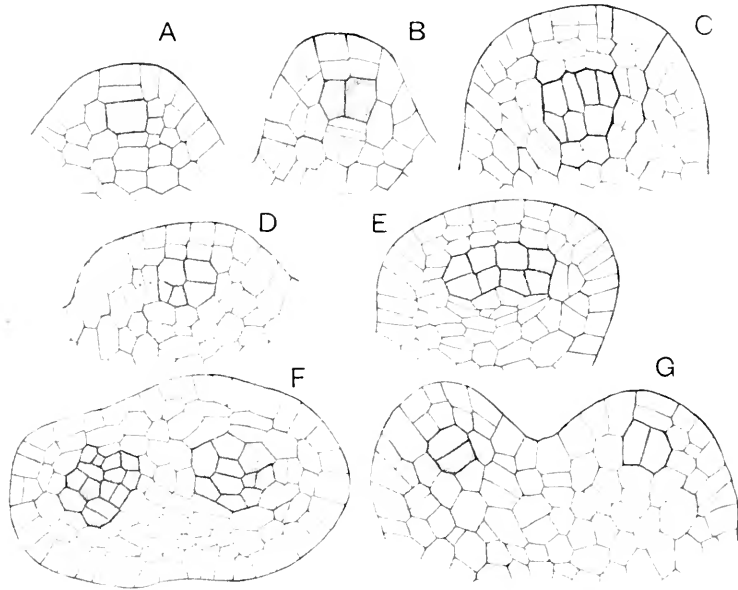

FIG. 253.

Botrychium daucifolium, Wall. A and C, successive stages of the most common type of sporangium. B=a small sporangium of narrow form. D=a very broad sporangium; the cells marked (x) correspond to the sporogenous group, but showed no signs of developing further as such. E=a still broader sporangium with wide sporogenous group, referable to two parent cells, possibly ultimately to one. F, G=synangia cut transversely and vertically. $\times 200$.

in their form and bulk to the synangia which, as above noted for *Botrychium Lunaria*, are not unfrequently found: one of these, cut through transversely, is shown in Fig. 253 F; here there is a zone of three layers of sterile tissue forming a septum between the two sporogenous groups. The septum is, however, commonly broader than this: if a comparison be made between this and the young synangia of *Thesipteris* the similarity will be readily seen. Such examples as these, which can easily be found in sections of the fertile spike, illustrate the gradual transitional forms which may be traced between the simpler and more complex spikes of the genus. Whether these steps will bear an evolutionary interpretation, as illustrating the manner of advance from a

simpler, or reduction from a more complex type, may be a question for discussion; but it is clear that the gradually transitional forms do exist.

As regards the first appearance of the sporangium, the essential parts of it, though not the whole body, are normally referable to a single parent-cell, and the first periclinal division delimits the sporogenous tissue (see Figs. 43, 44, p. 88). It appears that here all the sporogenous cells undergo the tetrad-division, and the nourishing tapetum, which is entirely derived from the surrounding tissue, makes its way inwards between the fertile cells.¹ As regards vascular supply, a strand extends to within two cells of the base of the cavity, and there terminates. Finally, the dehiscence is as in *Ophioglossum*. It thus appears that the whole sporangium of *Botrychium* is of the *Ophioglossum* type, but it is more definite and specialised in its characters, and this goes naturally along with its smaller size, which is most marked in *B. virginianum*.

It has already been noted that the position of the fertile spike in *Helminthostachys* is similar to that of *Ophioglossum*: it may further be added that the origin of it is similar, and its structure in early stages not unlike. It appears first as an outgrowth on the adaxial side of the sterile frond, and it is eurved over while young, so that the actual apex is pointed downwards: the whole of the spike is at first covered and protected by the segments of the sterile frond, which again are protected by the stipular sheath. Since then, as regards position, and the main facts of origin, the whole spike of *Helminthostachys* may be regarded as homologous with the whole spike of *Ophioglossum*, a special interest will attach to the origin and development of those bodies which directly bear the sporangia in this genus, viz. the sporangiophores.

Transverse sections of the fertile spike show at the lateral regions corresponding to the sporangiogenic bands in *Ophioglossum*, a fan-like tracery of the cell-walls, while the surface is covered by a rather regular series of deep cells: it is from these that the sporangiophores originate, as outgrowths of very irregular size and arrangement (Fig. 254 A). Growing first deeper, these cells divide by periclinal and anticlinal walls: the growth, however, is not uniform, but is localised at points so that rounded processes, often of very unequal size, make their appearance

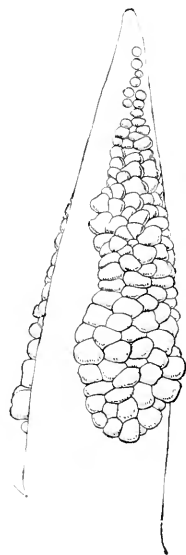

FIG. 254.

Helminthostachys zeylanica.
Young spike in oblique profile: the primordia of sporangiophores are densely clustered on the margin. Magnified. (After Goebel.)

¹Holtzman, *Bot. Gaz.*, xvii., p. 214; Cardiff, *Bot. Gaz.*, xxxix., p. 340; also *Studies*, v., p. 197.

(Fig. 255 A). There seems to be no fixed type of segmentation of the cells which leads to the formation of these sporangiophores, and though, as they increase in size, their apex may sometimes be occupied by a wedge-shaped cell, more frequently no such cell can be found (Fig. 255 B). The subjacent tissue may sometimes increase to a slight degree below a young sporangiophore, but it is obvious from the drawings, both of transverse and of longitudinal sections, that the sporangiophores are derived essentially from the superficial cells. Now this is also the case with the sporangia of *Ophioglossum*, in which the sporangiogenic band is

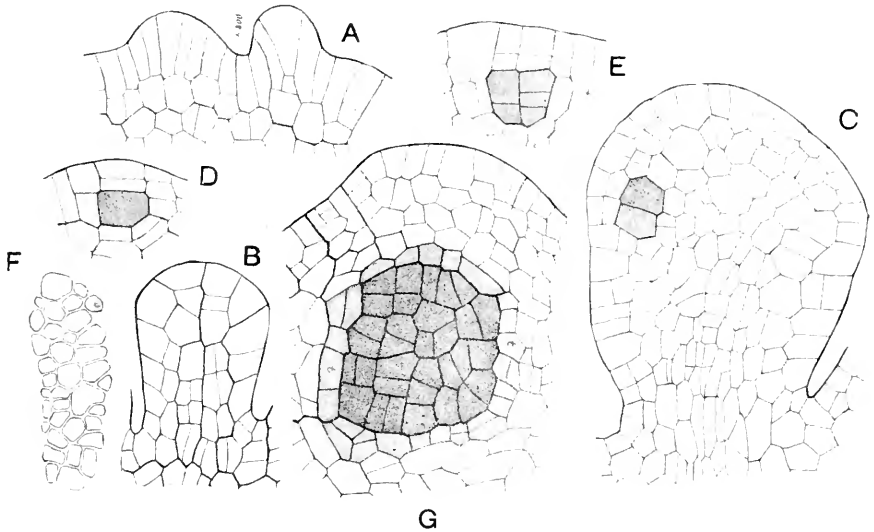

FIG. 255.

Helminthostachys zeylanica, Hook. A = early phases of sporangiophores. Note the variability of size, shown also in the tangential section F. B and C = older sporangiophores. C, D, E and G show stages of development of the sporangium, with the sporogenous cells shaded. $\times 200$.

in the first instance composed of superficial cells: thus there appears to be correspondence as regards the place of origin of the spore-producing members of the two genera.

Fig. 255 B illustrates the most regular type of these very variable organs: already in the central part longitudinal divisions are taking place which indicate the position of the central vascular bundle. The great differences in size which they show when young are suggested by the tangential section shown as Fig. 255 F. As they develop further the sporangiophores may become irregularly lobed or branched. Thus, though disposed with some regularity along the margins of the fertile spike, they are themselves very variable in size, form, and mutual arrangement.

It has already been noted also that the position and number of the sporangia which they bear is inconstant. In early stages it is impossible

to distinguish the cells which will give rise to the sporangia (Fig. 255 B), but from rather older stages it appears that the sporogenous group, together with the superficial cells which cover it, is referable in origin to the segmentation of a single superficial cell (Figs. 255 C, D, E). Moreover, the first periclinal division of that cell defines the whole of the sporogenous tissue from the protective wall. As the sporangia grow older they project from the surface of the sporangiophore; the sporogenous mass increases rapidly in bulk, while the cells surrounding the sporogenous mass, to the extent of several layers, assume the character of a tapetum (Fig. 255 G), which gradually becomes disorganised; finally the sporogenous cells separate, and divide into tetrads.¹ As the sporangia approach maturity, the upper part of the sporangiophore may grow out into an irregular rosette of laciniae of vegetative tissue. These are seen in Fig. 244 G.

Comparing the development of the sporangia in the three genera, it appears that with the larger size goes less definite segmentation, while greater definiteness is seen in the smaller types. It has been shown that the essential parts of the sporangium of *Ophioglossum* cannot be referred in origin to a single cell, while those of *Botrychium* and *Helminthostachys* can in normal cases. Also, that the large sporogenous mass of *Ophioglossum* throws off its superficial tissues as tapetum, which is of variable bulk:² in the other two genera the tapetum originates from the adjoining tissue, entirely outside the sporogenous mass. Further, when the definitive sporogenous tissue is clearly marked off, there is reason to believe that all the cells normally undergo the tetrad-division in all the three genera. The Ophioglossaceae may in fact be arranged in sequence, from those with large and indefinite sporangia to those with smaller and more definite, *Helminthostachys* taking the middle position.

The same sequence emerges also from the comparative study of their fertile spikes. The least elaborated type is that of *Ophioglossum*, with its two series of sunken sporangia. Its spikes are liable in many species to occasional bifurcation, or even complete fission, and in *O. pendulum* and *palmatum* this may become habitual: but these are only cases of repetition of the same unelaborated part. In *Helminthostachys* the external form as well as the development show that the sunken sporangia of *Ophioglossum* are replaced by sporangiophores, with separate and smaller sporangia, which at the same time are more numerous. In *Botrychium* the elaboration of the spike takes a different line: the occurrence of synangia has been shown to be closely related to the branching of the spike, which extends to a high degree, while the numerous separate and relatively small sporangia continue to hold the same relative position as in *Ophioglossum*.

It is possible, as in the case of almost all organic sequences, to regard this series as either an upward one of progressive elaboration or a

¹ Beer, *Annals of Bot.*, xx., p. 177.

² Stevens, *Ann. of Bot.*, vol. xix., p. 472.

downward one of reduction. Before discussing these two alternatives, it will be necessary to look into the anatomy of these plants, since arguments on that ground have been held to be very material to a decision.

ANATOMY.

The roots of the Ophioglossaceae show a wide range of internal structure.¹ In *Helminthostachys* they are tetrarch to heptarch, and most commonly hexarch, with central pith, alternating phloem, a large-celled pericycle, and endodermis. In *Botrychium* the number of protoxylems

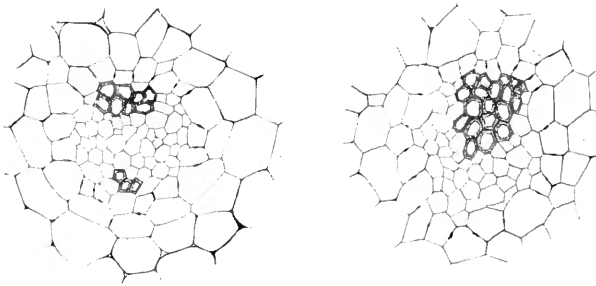

FIG. 256.

Ophioglossum Bergianum, Schlecht. Transverse sections of the stele of a root, the one showing two unequal groups of xylem, the other only one. $\times 200$.

varies a good deal, common numbers being two and three, but it has been shown in *B. Lunaria* that roots which are diarch distally may be monarch near the base. In *Ophioglossum*, also, there is some variety, for in *O. pendulum* diarch, triarch, and tetrarch roots have been described, while in this species also a monarch structure has been seen at the base of a rootlet: *O. decipiens* has triarch structure: *O. palmatum* is diarch. Most of the species of *Euophioglossum* have monarch roots, and this is conspicuously so in *O. vulgatum*. In *O. Bergianum* the structure may be diarch or monarch, the latter having been observed in roots close to their base (Fig. 256). With the monarch structure goes bifurcate branching, while monopodial branching is seen where the structure is more complex, as in *O. pendulum*, *Helminthostachys*, and *Botrychium*. Thus both dichotomous and monopodial branching are found in the same genus. Possibly dichotomy is restricted to the monarch roots: this was suggested by Van Tieghem, who remarks that, if the monarch root divides, we know beforehand that it will dichotomise.²

It is the fashion of the time to hold that all monarch roots are

¹ Compare Boodle, *Ann. of Bot.*, xiii., p. 377, where the literature is fully quoted.

² *Ann. Sci. Nat.*, V. Serie, T. xiii., p. 108.

reduced from some more complex structure:¹ in the observations relating to the Ophioglossaceae there is no necessity to adopt this view, which does not readily accord with the fact that the monarch condition appears at the very base of the root, both in *Botrychium* and in *Ophioglossum*. I am disposed to regard the monarch state as primitive. But whether they be primitive or reduced does not materially affect comparison: the family is clearly one with great instability of root-structure, and there are in a number of cases monarch roots which dichotomise. In these respects the Ophioglossales find their nearest correlatives among the Lycopodiales. Comparison should also be made with the Sphenophyllales: but the Psilotaceae are rootless, and the knowledge of the root-system of *Sphenophyllum* is still very obscure: apparently they were diarch, with secondary thickening,² a condition not far removed from that described for the roots of *Ophioglossum*, but still more clearly seen at the base of the roots of *Botrychium*; for here it has been shown by Boodle that secondary thickening of the root may occur.³ Thus in the Ophioglossaceae there are unmistakable points for comparison with the Lycopodiales and Sphenophyllales. On the other hand, the larger polyarch roots in the family show structure reminiscent of certain Ferns, and especially of the Marattiaceae.

The stock of the Ophioglossaceae originates directly from the embryo, or it may be formed indirectly as a result of adventitious budding. The young axis has been examined in all three genera, and in the first instance the vascular tissue is found to be centroxylic, either with a quite solid core, as in some seedlings of *Helminthostachys*,⁴ or in others it may have a central pith from the first, and this seems to be the case in *Botrychium*.⁵ In *Ophioglossum* the axis of the embryo, as described by Bruchmann in *O. vulgatum*,⁶ is very short, and no facts are at hand as to its stelar structure. But Bruchmann states that the development of the embryo coincides in all its later particulars with that of the adventitious buds, and these have been described and figured by Rostowzew.⁷ The vascular tissue, on entering one of these buds from the parent root, "forms a central cylinder, which dilates and becomes concentric (Fig. 236, No. 4): higher up it takes the form of a funnel, which is filled with parenchymatous pith: higher again the cylinder produces on one side a mesh from the lower angle of which the strand of the first leaf arises." This description, together with the drawings (Fig. 236, Nos. 2, 3, 4), indicates at the start a protostelic state, or at least a stele with only small medulla. It thus appears

¹ It will suffice here to mention Boodle's teleological theory that the monarch structure of *Ophioglossum* is an adaptation for favouring the growth of adventitious buds on the roots. He himself quotes cases which do not bear out his view: his theory, moreover, seems to confuse cause with effect.

² Seward, *Fossil Plants*, i., p. 399.

⁴ Lang, *Ann. of Bot.*, vol. xvi., p. 42.

⁶ *Bot. Zeit.*, 1904, p. 240.

³ *L.c.*, p. 388 and Fig. 14.

⁵ Jeffrey, *L.c.*, p. 21, Fig. 61.

⁷ *L.c.*, Pl. 1, Figs. 2, 3, 4.

that all the three genera show either a solid xylem-core or a slightly medullated stele in the young axis.

Proceeding to the upper part of the shoot the medulla increases, while the vascular tissue forms a more or less interrupted cylinder surrounding it: the interruptions are the leaf-meshes, for above the exit of each leaf-trace there is a gap in the cylinder. In *Ophioglossum* the meshes are large, and as the leaves are arranged in a compact spiral, the whole system assumes a form clearly shown in Rostowzew's drawings (Fig. 236, Nos. 4, 5). In *Botrychium* a similar arrangement is found; but as the proportion of the leaf-meshes to the whole surface of the cylinder is less, it approximates more nearly to a continuous tube.

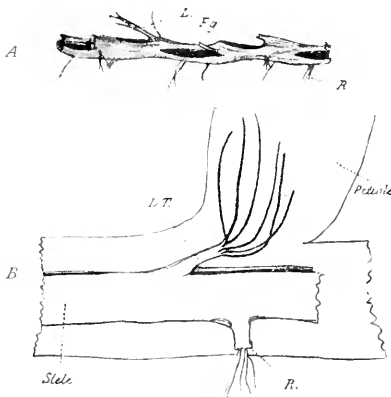

FIG. 257.

Helminthostachys zeylanica, Hook. The upper figure represents the vascular skeleton, dissected out. *L* = leaf-trace; *R* = root-strand; *Fg* = foliar gap. The lower figure shows the rhizome-stele giving off a leaf-trace, *L.T.*, which breaks up above into separate petiolar bundles. *R* = root-trace. (After Farmer and Freeman.)

there is also an inner endodermis in the pith, but it is found only at the base of the stock (Poirault). In most species of *Ophioglossum* there is no endodermis in the stock at all; but in *O. Bergianum*, *capense*, and *ellipticum*, all small species, an outer and inner endodermis are both present, though at the base of the stalk only: passing upwards they fade gradually away, the inner disappearing first.¹ In *Helminthostachys*, curiously enough, the converse is seen: here there is throughout the stock a well-marked outer endodermis, as in *Botrychium*, but the inner appears only in the older stems, the young plants being quite destitute of it.² It is difficult to draw any definite conclusions from such discordant facts: it must suffice for the moment to remark that, on the one hand, there is want of constancy of the endodermis also in the Psilotaceae, and on the other, that in the Marattiaceae the endodermis is present in

¹ Poirault, *l.c.*, p. 169.

² Farmer and Hill, *Ann. of Bot.* xvi., p. 401.

This is still more clearly seen in *Helminthostachys*, where the shoot is dorsiventral; for there the foliar gaps are disposed obliquely upon the upper side only of the cylinder, while the lower side of it is uninterrupted (Fig. 257). It would thus appear that the vascular system of the axis is essentially similar in them all, and is referable in origin to the amplification of a primitive stele, with a distending pith, and perforation of the vascular cylinder by foliar gaps.

As regards the tissues themselves, the most important of them for comparison are the xylem and the endodermis. The latter shows curious irregularity of occurrence in this family. In *Botrychium* there is a well-marked outer endodermis throughout the length of the stock:

the stem of the young plant, but fades off in the upper regions, as in *Ophioglossum*.

In transverse sections of the stock of *Botrychium*, in which the leaf-gaps are limited in area and not so closely placed as in *Ophioglossum*, the vascular ring is often seen to be complete, or where a leaf-trace issues it may be interrupted: the xylem is endarch. Much importance has been accorded to the secondary thickening seen in both stem and root of *Botrychium*. A sluggish cambium appears between the phloem and xylem, and may even be seen to be active close below the apex before either of those tissues are differentiated: it adds fresh tracheides to the xylem, but little or nothing to the phloem, while the radially seriated wood

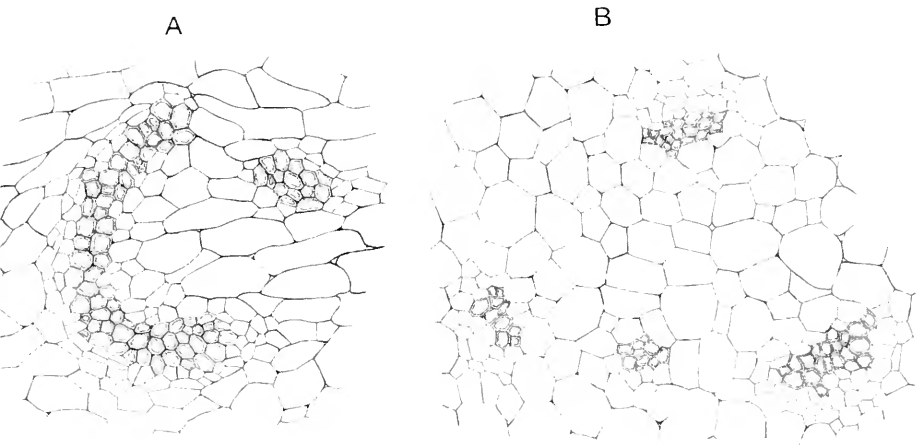

FIG. 258.

Ophioglossum Bergianum, Schlecht. A = transverse section of the stock, showing a large semilunar stele, with wide foliar gap into which a small leaf-trace strand is entering. B = another section, showing probably the result of overlapping of the foliar gaps. $\times 200$.

is traversed by parenchymatous rays. The secondary activity extends also into the basal region of the root, but it does not extend far along it. In *Ophioglossum* the transverse section of the stock shows an interrupted ring of xylem-bands, the interruptions representing the closely grouped and overlapping leaf-gaps, as will be readily understood by comparison of Fig. 236, Nos. 4, 5. But in simple cases, and especially near to the base of the stock, the ring may appear more complete (Fig. 258). The development is endarch, and there is no process of secondary thickening except that a few tracheides may occasionally be added peripherally to those primarily formed. In the root also there may be a feeble formation of secondary wood, especially in the neighbourhood of the insertion of an adventitious bud (Boodle). In *Helminthostachys* the vascular ring is interrupted only on the oblique upper side, by the leaf-gaps. The xylem is, however, mesarch, while the secondary thickening is altogether absent (Farmer and Freeman).

The facts thus stated relating to the vascular structure of the stock in the three genera are all consistent with a theory of origin from a type with primarily a solid protostele, and subsequently a medullated monostele: for the structure of the vascular system in the mature shoots of them all is in point of fact a hollow cylinder perforated by the leaf-gaps: in *Botrychium* and *Helminthostachys*, where these are less closely grouped than in *Ophioglossum*, the fundamental structure as a vascular cylinder is plainly seen. The opening of the cylinder to give exit to the leaf-trace is a characteristic of that type designated by Jeffrey "phyllosiphonic," and he distinguishes it from the "cladosiphonic type," in which the leaf-trace passes off from the axial system without any opening. It has already been pointed out that these two types are the anatomical expression of the relative prevalence in the whole shoot of the axis in the cladosiphonic, and of the leaf in the phyllosiphonic type. Supposing in any phyletic series there should be an increasing dominance of the leaf, it would be reasonable to expect evidence in the individual of a transition from the one vascular type to the other. In the young plants of the Ophioglossaceae themselves there is no indication of any such transition, for the young plants are phyllosiphonic from the first. It will, however, be shown later that on comparative grounds there is reason to think the origin of the phyllosiphonic state in the Ophioglossaceae was from the cladosiphonic, following upon an increase of proportion and importance of the leaf.

The leaf-trace itself is typically a single strand of the collateral type. This is seen in *Botrychium* and *Helminthostachys*, and in most species of *Ophioglossum*. The collateral strand may have its margins curved together on the adaxial side, so that in the petiole of large leaves it may approximate to a concentric structure, as in *B. virginianum*; but this is merely a modification of the collateral structure. Even in the large-leaved *Helminthostachys* the leaf-trace comes off as a single strand, though it branches very soon, in fact before the cortex is traversed, to form the numerous strands of the petiole (Fig. 257 B). The condition seen in some species of *Ophioglossum* is interesting for comparison with this, forming as it does an exception to the rest of the family. In the section *Euophioglossum* the leaf-trace comes off, as in other Ophioglossaceae, as a single strand, which soon branches into three; and this fact is embodied in Prantl's diagnosis as amended by myself.¹ But in the section *Ophioderma* the numerous strands of the petiole are not united into a single strand at the base: they are inserted as separate strands upon the vascular system of the stock. It is still uncertain whether or not §*Chiroglossa* shares this character. A comparison with other forms of *Ophioglossum* shows this condition to be exceptional, and it is probably a derivative state, the separation of the strands shown in other species only in the upper leaf having been continued in §*Ophioderma* down to their actual base of insertion on the

¹ *Ann. of Bot.*, xviii., p. 215.

system of the axis: comparison with the Ferns shows that in them the concrete leaf-trace is characteristic of the primitive types, and that its separation into many distinct strands is a feature of those which are later and derivative. This analogy strongly supports the view that the state of the leaf-trace in § *Ophiderma* is not primitive.

Passing up the petiole the vascular strands undergo branchings, which vary in extent according to the dimensions of the fully formed leaf. The strands arrange themselves in an approximate circle in the transverse section, while those on the adaxial side pass out into the fertile spike. The details are various: the simplest is in the small *O. Bergianum*, where the single leaf-trace strand may long remain undivided, giving off two lateral strands which fuse on the adaxial side to form the supply for the spike: further up the strands of both sterile lamina and of fertile spike may branch again. In the larger species of *Ophioglossum* the plan is the same, but with the difference that the branching is more profuse, and takes place before the lateral supply is given off right and left for the fertile spike; in the larger species the latter consists not of a single strand but of several. The same is the case for *O. pendulum*, and even for *O. palmatum* in the case of the lowest spike, though in the upper spikes the supply is less regular in accordance with the indefinite positions which they hold (Fig. 259, 14-17). In *Ophioglossum* there is a strong median strand in the leaf, which frequently holds its own throughout the complicated reticulations of the expanded blade. In *Botrychium*, however, the broad strap-shaped leaf-trace forks early; and from the adaxial margins of each limb branch-strands are given off, which form the supply of the fertile spike: subsequently both systems may branch further, showing dichotomous characters, and an ultimate "*Neuropteris*" venation. In *Helminthostachys* the first branchings of the leaf-strand are described as dichotomous: the resulting strands arrange themselves in a ring, and traverse the petiole with occasional anastomoses. Where the leaf branches complex anastomoses occur, resulting in a fairly regular vascular supply passing into each branch. The spike receives four or five strands, arranged in a circle, in its transverse section. Further branchings occur in both sterile and fertile

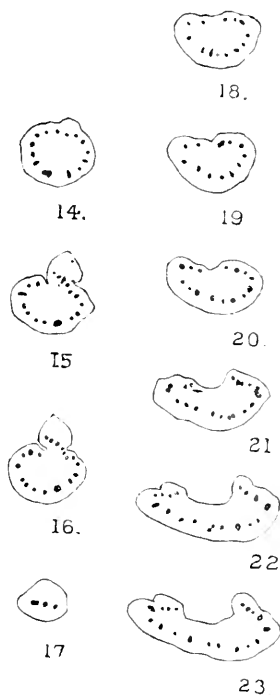

FIG. 259.

Nos. 14-16 successive transverse sections of leaf of *O. palmatum*, showing the origin of the vascular supply to the lowest of its spikes. 17=transverse section of the stalk of that spike. 18-23=successive sections higher up on the same leaf, showing the origin of the vascular supply to the second and third spikes. $\times 4$.

regions, those in the former being ultimately forked, giving a "*Neuropteris*" venation, as in *Botrychium*. All these arrangements are clearly variants upon one plan, of which the essential point is that the vascular supply of the spike is of marginal origin, right and left from that of the whole leaf. It was upon this that Roeser based the anatomical support for his theory of the spike as a result of fusion of lateral pinnae. The facts would accord, it is true, with Roeser's theory; but it is to be borne in mind that a marginal origin of vascular strands from the main system is much more usual in leaves than any antero-posterior branching. On the other hand, the origin of the vascular supply of the spike from both sides of the foliar system gives no support to the theory that it is essentially a lateral pinna which has taken a median position.

Lastly, the relation of the vascular system to the sporangia deserves notice. In *Ophioglossum* lateral branches from the anastomosing strands of the spike pass between the sporangia, traversing the septum and expanding toward the periphery into a tuft of tracheides, an arrangement which is doubtless efficient in the case of deeply sunk sporangia (compare Fig. 250). But in *Botrychium* and *Helminthostachys* the ultimate strands terminate immediately below the base of each sporangium. The condition seen in *Ophioglossum* does not appear to accord well with a theory of sporangial fusion: it points rather to an upward process of progressive septation.

Summarising the results of this anatomical examination of the shoot in the Ophioglossales, the facts are consistent with the origin of the axial system from a protostelic state, with amplification of the stele, followed by formation of a leaf-gap at the exit of each leaf-trace: the latter is typically a single strand: as it passes upwards it branches, with prevalent bifurcation in *Botrychium* and *Helminthostachys*, but not in *Ophioglossum*: these facts are consistent with an origin of the leaf from a simpler source by enlargement and branching. The vascular supply to the fertile spike originates from the lateral margins of the foliar system, and with this the simpler states of *O. palmatum* coincide, though not the more complex. The bearing of these facts, as indicating the probable origin and relationships of the Ophioglossales, will be discussed later.

EMBRYOLOGY.

Until recently the prothallus and the development of the embryo in the Ophioglossales were very imperfectly known, though observations upon them date back to the writings of Hofmeister and of Mettenius. But during the last ten years the prothalli and embryos have been discovered in a number of cases where they were previously unknown, so that it is now possible to give some approach to a comparative account of the embryology of the family.¹

¹The account here given is based upon the works of Hofmeister, *Higher Cryptogamia*, 1862; Mettenius, *Filices Horti Lipsiensis*, 1856; Campbell, *Mosses and Ferns*, 1895 and

The prothallus throughout the Ophioglossaceae is subterranean, and without chlorophyll, excepting some traces observed by Campbell in the early germination of *Botrychium*, while Mettenius, and later Campbell, have noted in *O. pedunculosum* that some branches of the thallus extended above ground, and became flattened and green. But with such exceptions as these the gametophyte is massive and colourless, and is buried underground. Its nutrition is holosaprophytic, with an endophytic mycorrhiza, which is located especially in the lower region. In *Botrychium* its form is that of a flattened cake, with the slowly growing apex in a lateral position: but in *Ophioglossum* and *Helminthostachys* there is a definite apical growth associated with the formation of one or more upward or lateral conical processes, and it is upon these that the sexual organs are borne. In *Botrychium* they appear upon the surface of the cake, where the mycorrhiza is absent. The antheridia are deeply sunk in the tissue of the gametophyte: the archegonia, which have the early segmentation as in Ferns, are deeply sunk in *Ophioglossum*, but in *Botrychium* and *Helminthostachys* the neck of the archegonium is elongated and projecting. The orientation of the archegonia does not appear to be constant, but in *Ophioglossum* and *Helminthostachys* its axis appears to be horizontal, while in *Botrychium* it is oblique or vertical. The spermatozoids are spirally coiled, and bear numerous cilia.

The development of the embryo of the Ophioglossaceae follows slowly on fertilisation, and shows peculiarities which may be held as concomitant on the subterranean habit, while the mycorrhizic state may affect not only the prothallus, but in some cases the young sporophyte also. The most marked peculiarity is the delay in the actual growth of the apical bud, while there is a very precocious development of the root-system. Also, it will be seen that there is considerable variety in detail in the different representatives of the family, and even within the generic limits. This will make it desirable to describe them separately.

In most species of *Ophioglossum* fertilisation seems to be of rare occurrence, and few embryos have therefore been available for study. The first division of the zygote is transverse to the axis of the archegonium: though Campbell specially points out that it is not regularly so in *O. pendulum*¹: this first segmentation separates the epibasal from the hypobasal region; but it has been difficult to follow the details of further segmentation owing to the scanty material, and reference of the parts to any definite relation to the initial cleavages is made specially uncertain by the fact that the embryo attains considerable size before any differentiation occurs (Fig. 260). Bruchmann states, however, for *O. vulgatum*, that the hypobasal half gives rise to the first root and the foot; the latter is

1905; Jeffrey, *Gametophyte of Botrychium*, Toronto, 1898; Lang, *Ann. of Bot.*, xvi., 1902; Bruchmann, *Bot. Zeit.*, 1904, and *Flora*, 1906; Lyon, *Bot. Gaz.*, Dec., 1905; and of Campbell, *Ann. Jard. Bot.*, Buitenzorg, 1907, p. 138.

¹*L.c.*, p. 171.

never large, but appears only as a slight swelling which remains in close relation with the prothallus. The root rushes forward in its development, and forming its apical cell early (perhaps it is rightly recognised in cell "w" in Fig. 260), it attains a considerable length: it bursts freely through the prothallus before there is yet any definite trace of the apex of the axis or of the cotyledon (Fig. 260 *bis*). Up to this time the embryo is stored with nutritive substances, but it contains no endophytic fungus. It appears that the development up to this stage occupies several vegetative seasons. The differentiation of the shoot which is thus long delayed accompanies the origin of the second root, which is formed endogenously close to the proximal end of the vascular strand of the first. Immediately above this.

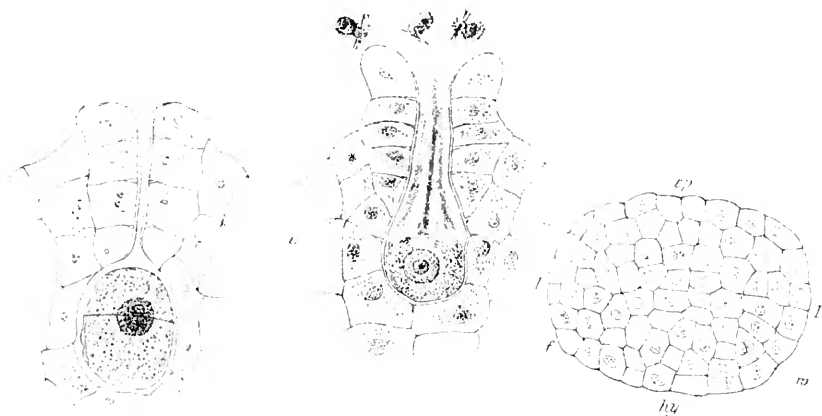

FIG. 260

Ophioglossum vulgatum, L. The central figure shows an archegonium, at period of fertilisation. $\times 225$. The left-hand figure shows the first division of the zygote. $\times 225$. To the right a more advanced embryo. *l, l*=basal wall; *ep*=epibasals; *hy*=hypobasal hemisphere; *f*=the region of the foot; *w*=root. $\times 225$. (After Bruchmann.)

and opposite the neck of the archegonium, the cotyledon and the apex of the axis appear simultaneously, the cotyledon being on the side of the axis next to the first root: surrounding both axis and cotyledon is the first sheath (Fig. 260 *bis*, *hl*₁). The cotyledon remains quite rudimentary: it is followed by a second leaf, which may develop as a small sterile leaf expanded above ground, up to which time the embryo has been growing some eight to ten years. The third leaf, expanded in the following year, may, under favourable circumstances, bear a fertile spike. The further development then follows as in the mature plant.

Campbell, having examined several tropical species, recognises three types of embryogeny in the genus, that of *O. vulgatum*, above described: that of *O. moluccanum*, described by Mettenius and by himself: and that of *O. pendulum*, on which he has added largely to the observations of Lang, and finds that the embryo is variable within the species. According to his statement, the first type is characterised (as we have seen) by an

early formation of the root, and late development of the axis and leaf: in the second, leaf and root only are developed, in the third roots only: the definitive sporophyte in both *O. moluccanum* and *pendulum* is "formed as an adventitious bud upon the root of the embryo sporophyte." It would thus appear that the genus *Ophioglossum* shows almost equal variety in its embryogeny to that seen in *Lycopodium*. It has been seen



FIG. 260 bis.

Ophioglossum vulgatum, L. 58 = longitudinal section through a young seedling. w_1 = first root with evident apical cell; f = the foot only slightly projecting; e = the epibasal region of the embryo; p = rudiment of prothallus. $\times 35$. 61 = larger, three-rooted seedling in longitudinal section; p = prothallus; w_1 = first root; h = entering fungal filament; en = endoparasitic fungus. aw = insertion of 2nd and 3rd roots; s = apex of rhizome; b_1 , b_2 , b_3 = leaves; c , c = canal; hl_1 , hl_1 = sheath of first leaf; hl_2 , hl_2 = sheath of second leaf; hl_3 = sheath of third leaf. $\times 35$. (After Bruchmann.)



in that genus how the different forms are referable to variation of a single type, and it seems probable that the same should be the case also for the embryos of *Ophioglossum*. In *Lycopodium* the variants arise through tuberous swellings and delay of root-formation: here the variants arise in relation to the precocity of the root, a feature related in all probability to mycorrhizic nutrition. We have seen that the development of the axis is delayed in *O. vulgatum*, which may be held to be a less specialised type, though still with precocious root: in *O. moluccanum*, also, the root emerges early from the prothallus and projects downwards, but the

cotyledon, which is itself green and expanded, emerges upwards, while the axis is still further delayed than in *O. vulgatum*: it may be suggested that the latter has been slipped out from the prothallus owing to the early elongation of the base of the cotyledon, and so its original genetic connection is not easily followed, and its appearance comes to be like

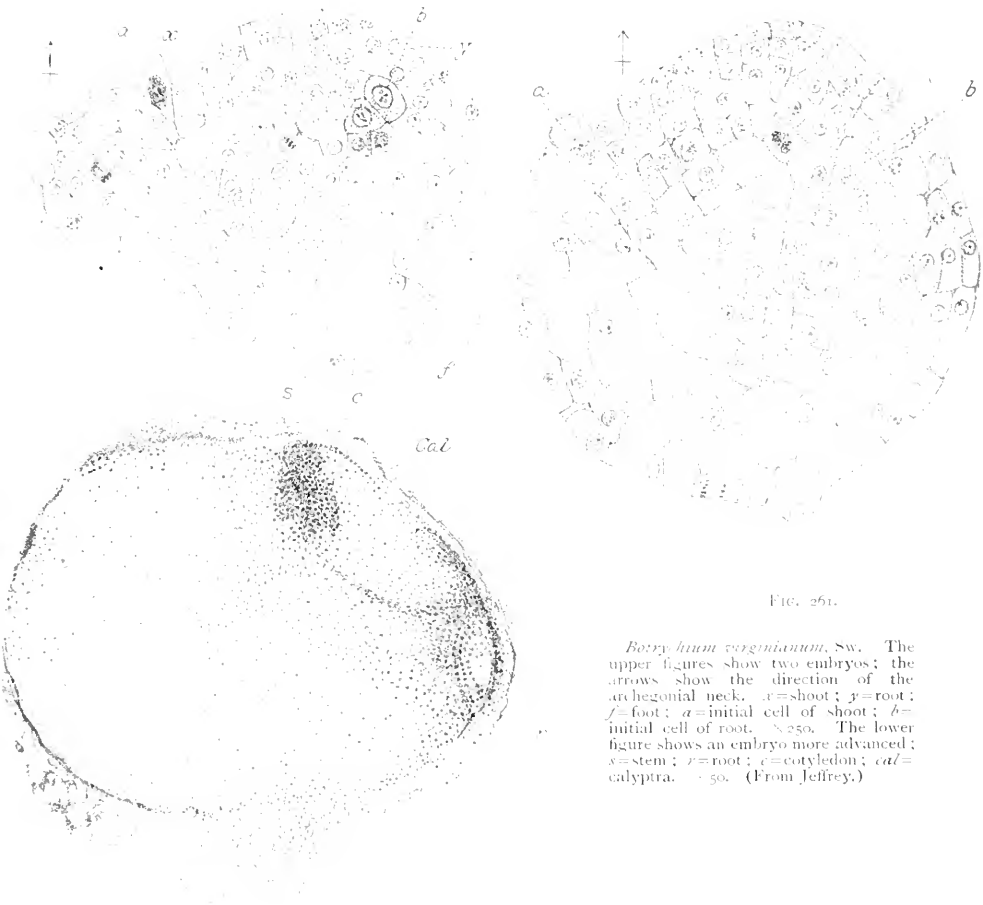

FIG. 251.

Botryllum virginianum, Sw. The upper figures show two embryos; the arrows show the direction of the archegonial neck. *x*=shoot; *y*=root; *f*=foot; *a*=initial cell of shoot; *b*=initial cell of root. $\times 250$. The lower figure shows an embryo more advanced; *s*=stem; *r*=root; *c*=cotyledon; *cal*=calyptra. $\times 50$. (From Jeffrey.)

that of an adventitious bud. Or possibly in this, as apparently in the type of *O. pendulum*, the primary axis may be arrested completely (a step in advance on the *vulgatum*-type), and the adventitious shoots described as originating on the root be actually such: in fact, early representatives of those so often found on the roots of the genus. But from the facts, as presented by Campbell, which are far from giving the complete developmental story, there does not appear to be sufficient reason to regard the

peculiarities he describes as other than extreme modifications along the lines already indicated by the less specialised embryos of the family.¹

The first detailed description of the embryo in any of the species of *Botrychium* was given by Jeffrey for *B. virginianum*, and it has been verified in many points by Campbell. The very large prothallus bears its archegonia on the upper surface: after fertilisation the zygote enlarges, and divides first vertically to the axis of the archegonium, and in the

hypobasal and epibasal hemispheres the usual octant divisions appear; but these segmentations are obscured by the less regular divisions which follow. The embryo thus appears as an ellipsoid body, in which no apical cells are at first defined.

Jeffrey states that the whole hypobasal hemisphere goes to form the foot, while the stem-apex and the root originate from the epibasal half: and his drawings certainly seem to bear this out (Fig. 261). The apical cell of the stem (*a*) is defined before the cotyledon appears: this is formed on the side of the axis next to the root (*b*), and Jeffrey records that it is derived from the shoot-

meristem. It grows rapidly, and finally becomes expanded above ground as the first assimilating leaf. The root is, however, the first part of the embryo to emerge, and a second and third root may make their appearance before the cotyledon unfolds: subsequently successive spirally arranged leaves are formed on the axis, but the earliest fertile spike observed in this species was borne on the ninth leaf.

¹This interpretation of the data of Campbell differs widely from his own. It is impossible here to enter into any full discussion of the question. It should be stated, however, that Campbell's own view is that the type of embryo of *O. moluccanum* is probably the most primitive, and shows an embryo in which no axis exists at first; he regards the definitive sporophyte as a secondary structure developed as a bud upon the primary root. In *O. pendulum*, also, the leafy sporophyte is secondary, neither stem-apex nor leaf being produced from the embryo itself (*l.c.*, p. 183). In fact, Campbell takes as the most primitive forms those which are most divergent from the type of embryo which is usual in other Pteridophytes. It would seem more satisfactory, however, in so specialised a case as this, to start from the least divergent, such as *O. vulgatum*.

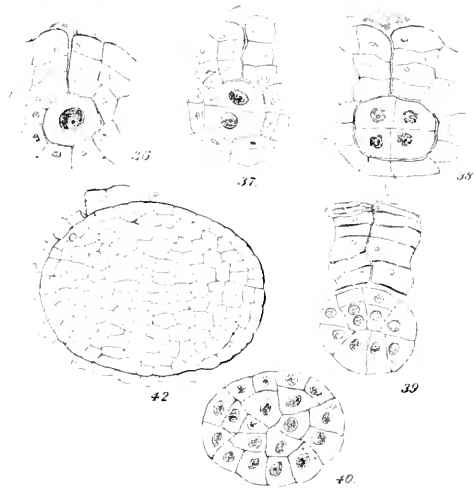

FIG. 262.

Botrychium Lunaria, L. 36=fertilised archegonium; 37=zygote, showing the first segmentation; 38=embryo of four cells; 39-40 embryos cut in direction of the axis of the archegonium; 42=an embryo breaking out of the prothallus; 36-40×225; 42×150. (After Bruchmann.)

The account given by Bruchmann for *B. Lunaria* corresponds in all essentials to the above, though it differs in certain details. The octants appear as usual, and are followed by less regular divisions which disguise them in the resulting ellipsoid body. The limits between the epibasal and hypobasal parts are lost, and owing to the late origin of the several parts of the embryo, Bruchmann found it impossible to refer them



FIG. 263.

Botrychium Lunaria, L. The lower figure represents an old embryo with well-developed foot (*f*); *w*₁=apex of the first root; *s*=apex of the rhizome, with the second root, *w*₂. The endophyte (*en*) is already in the cells. X 52. The upper figure is a diagrammatic section of a seedling, with six to eight roots, of which three are in plane of section. *f*=foot; *w*₁=first root; *w*=roots; *s*=apex of rhizome; *b*₁-*b*₂ developing leaves. X 6. (After Bruchmann.)

strictly to one or the other source (Fig. 262). The root, which is organised early, grows first in a horizontal direction, and bursts laterally out from the prothallus, but the remainder of the embryo rests within the prothallus, where a distended foot is formed. On this ovoid cellular body, and opposite to the neck of the archegonium, there arises the apical cell of the axis: it is immediately overarched by a small growth (apparently on the same side of the axis as the root), which Bruchmann takes for a rudimentary cotyledon. Up to this time the embryo has a predominant root—more so than in *B. virginianum*—while the foot serves

both for storage and as a haustorium (Fig. 263 A). Even at this early stage the embryo may contain an endophytic fungus. The formation of a succession of roots may then follow, while the growth of the bud remains almost quiescent, though it forms a succession of small leaves (Fig. 263 B): of these about the eighth appears above ground, the rest serving only for protection to the bud. It is interesting, however, to note that a rudimentary fertile spike may be found even on some of these rudimentary scale-leaves. From this point onwards the development is as in the mature plant. Comparing this development with that in *B. virginianum*, the relative position of the several parts is essentially the same: the chief differences are in their proportion. The root and foot are larger, and the axis later in definition: also there is the fact that the first few leaves are scale-leaves, whereas in *B. virginianum* the first leaf is itself expanded above ground. The same difficulty holds here as before in defining whether the root is hypobasal or epibasal in origin. It is from such differences as these existing within a narrow circle of affinity that a true estimate of the value of embryonic characters may be derived.



FIG. 264.

Botrychium (Sceptridium) obliquum, Muhl. Photo micrograph of a section through a gametophyte and young sporophyte. The root is already protruded from the under side of the gametophyte. *a* = archegonium; *s* = suspensor; *t* = stem-tip; *r* = first leaf; *r* = root. $\times 60$. (After H. L. Lyon.)

But these differences are of small account compared with the divergence from the general type of the genus shown by another species, *B. obliquum*, Muhl. H. L. Lyon has described how its zygote does not develop directly into the embryo as in other species, but first gives rise to a suspensor, which burrows into the tissue of the gametophyte in the manner characteristic of certain Lycopods. The embryo itself is formed at the tip of this suspensor, and its parts are differentiated relatively early (Fig. 264). The parts themselves are essentially similar to those of other species of the genus: the first leaf (cotyledon) appears on the side of the axis directed upwards, and it breaks through the upper surface of the prothallus: the root originates on the side directed downwards, and it emerges on its

under side. Hitherto only a preliminary account of this strange anomaly within the genus *Botrychium* has been published, and it will be necessary

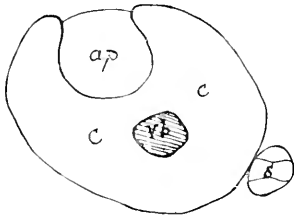

FIG. 265.

Embryo of *Botrychium obliquum*, in transverse section at the level of the stem-apex (*ap*). *cc*=cotyledon; *s*=suspensor. From a preparation lent by H. Lyon.

to await the detailed description which will supply the materials for an exact comparison. But meanwhile Mr. Lyon has most generously lent slides showing not only some advanced stages, but also the earliest stages of embryogeny, from which the following facts and drawings have been derived.¹ Transverse sections of an embryo corresponding to that in Fig. 264, showed the suspensor (*s*), cotyledon (*c*), and apex of the axis (*ap*) in the relative positions ascribed to them by Lyon, and demonstrated the correctness of his interpretation of the longitudinal section (Fig. 265).

But what is more important is that sections traversing archegonia, shortly after fertilisation, showed that the zygote, while still undivided, grows

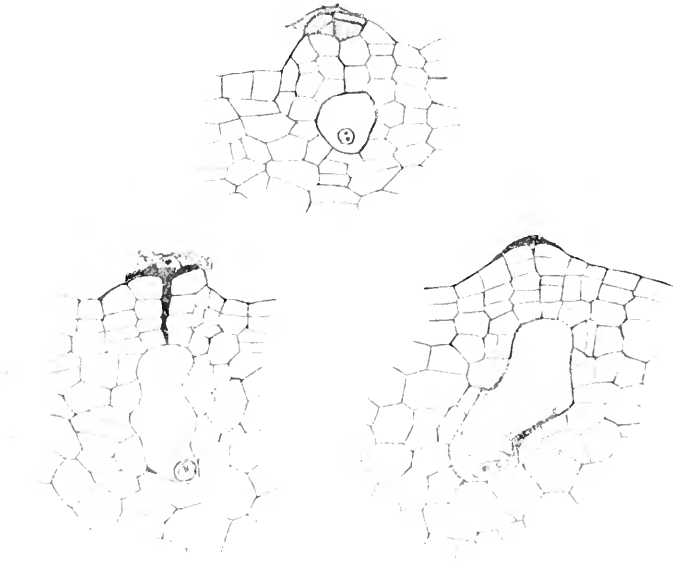

FIG. 266.

Botrychium obliquum. First stages in the embryogeny; before the first segmentation the zygote grows into an elongated tube (the suspensor), which burrows its way irregularly into the tissue of the prothallus. $\times 150$. From sections lent by H. Lyon.

into an elongated tube, which takes an irregular course downwards into the tissue of the prothallus (Fig. 266): its nucleus settles down to the

¹Mr Lyon's action in this matter deserves special recognition. When circumstances delayed the completion of his own statement, knowing the importance which the main facts bore in embryological comparison, he forwarded a set of slides to me in Glasgow, with permission to use the facts they showed in whatever way I found necessary. F. O. B.

base, and maintains that position as the growth proceeds. This is susceptible of no other interpretation than that a suspensor is formed, and that the whole embryogeny is inverted, as compared with that of other Ophioglossaceae where a suspensor is absent. The importance of this lies in its bearing on the general comparison of embryos, and on the estimate of the weight to be attached to some of those differences which have hitherto been made to bear a burden of comparative and phylogenetic argument. If we see that within a narrow circle of affinity the suspensor may be present or absent, and the apex of the embryonic axis be directed either towards the archegonial neck or away from it, then such characters become suspect. This will find its special application in the comparative study of the Lycopodiales and of the Ophioglossales.

In the third genus, *Helminthostachys*, the youngest stages have not yet been seen: but the old embryo resembles that of *Botrychium virginianum*.¹ It has a large foot derived from the hypobasal region, while the primary root, first leaf, and stem-apex appear to be referable to the epibasal half. The first leaf has a ternate lamina, and reaches the light, but the young plant remains attached to the prothallus till several leaves have been formed: one root lies below each of the earliest leaves, but in the older plant this regularity is lost (Fig. 267). An endophytic fungus is present in the first few roots, though the adult plant is normally free from mycorrhiza.

The character of the prothallus, and perhaps also the position of the archegonium upon it, have to be taken into account when making comparison of the embryology of the Ophioglossaceae. All their prothalli are typically underground and saprophytic, and the embryos show differing degrees of adjustment to the peculiar conditions thus imposed upon them. In these facts the dominating features of the embryogeny may be found, and they must be borne in mind not only in any comparison with other Pteridophytes, but also as regards the minor differences which they themselves show. The most obvious points relate to the development of the earlier leaves: in *Botrychium virginianum*, *Ophioglossum pedunculatum* and *Moluccanum*, and in *Helminthostachys* the cotyledon itself may be expanded above ground: but in both of the larger genera there are species which bear the first leaves as rudimentary underground scales: this is seen in *O. vulgatum*, where the second leaf only is effective for assimilation, and in *B. Lunaria*, where a succession of scale-leaves appear, and the eighth leaf is the first that is expanded above ground. The scaleleaves can



FIG. 267.

Helminthostachys zeylanica.
Young plant attached to prothallus. Natural size. (After Lang.)

¹Compare Lang, *l.c.*

only be held as the representatives, secondarily reduced, of leaves primitively expanded above ground.

Another feature for comparison is the balance between the root and the shoot. Owing to the saprophytic mycorrhizal habit of the prothallus—and in some of the species even of the sporophyte itself—there is no immediate need for leaf-expansion, though an effective root-system is wanted, especially where it is itself mycorrhizic. This finds its realisation in the embryogeny; for the root-development in the Ophioglossaceae is liable to be hurried forward, and the development of the shoot to be postponed. That is seen in *O. vulgatum*, where the first root may already have freely emerged from the prothallus even before the shoot is clearly initiated. *B. Lunaria* also shows the first root as predominant, and the shoot relatively backward in development, with its succession of scale-leaves. Both these familiar plants are thus relatively specialised types of their respective genera. But the case of *O. pendulum* shows a still more extreme type; and it seems not improbable that the precocious development of the root has completely upset the balance of parts in the embryo, with the result that the primary axis and cotyledon are difficult to locate, or may be even entirely arrested. Comparing the embryos of the family as a whole, it would seem probable that the primitive prothallus was above ground, and that in the original state of the seedling even the first leaf was an effective assimilating leaf, while those with one or more ineffective scales show a more advanced adjustment to their underground habit. The deferring of the period of functional activity of the shoot carries its reflection back to the early steps of the embryogeny; the relatively late appearance of the axis with its appendages is thus explained, as well as the apparently precocious development of the root. The differences in these respects shown by the various representatives of the family indicate their unusual capacity for adjustment of such details. It is through considerations of this nature that we may bring these embryos into relation with those of other Pteridophytes where the embryo shows differentiation at an earlier stage.

The late differentiation of the parts of the embryo in the Ophioglossaceae brings with it a difficulty in their exact location relatively to the primary segmentations of the zygote. There is no doubt that in the types under consideration (excluding the type of *B. obliquum*), the apex of the axis arises in them all from the epibasal hemisphere, and allowing for distortions due to unequal growth, it appears to be coincident with, or in near proximity to, the intersection of the primary octant-walls. Thus as regards the initial polarity the Ophioglossaceae resemble other types of Pteridophytes. The cotyledon appears in close relation to the apex of the axis, both in time and space, and it usually lies between the apex of the axis and the first root: but it will be remembered that in *Isoetes*, which offers some other points of analogy, the root is on the opposite side of the axis to the cotyledon. As to the exact point of origin of the first root there is some

degree of uncertainty. In *B. virginianum* it is traced by Jeffrey from the epibasal hemisphere, and his drawings seem to bear this out. But in *O. vulgatum* Bruchmann indicates a cell in the hypobasal region as the probable initial cell. It seems not improbable that in the Ophioglossaceae, as also in the genus *Equisetum* and among the Lycopodiales, the origin of the root is not uniform in position, but may in this relatively large embryo be at a point either above or below the primary segment-wall.

A very striking feature in the young seedling is the early appearance of the fertile spike. In *O. vulgatum* it may appear upon the third leaf, while it may be seen even on the first leaf of the adventitious buds of this species. In *Botrychium Lunaria* its minute representative may be found on the rudimentary underground scales of the embryo. In these cases the body actually seen does not seem to differ either in position or in origin from those produced on the later leaves. Such facts will have their bearing on the question of the morphological nature of the spike. Taken in relation to the general theory of sterilisation they indicate that the plants are but little removed from a condition where the very first leaves were fertile. On the other hand, Jeffrey figures several fairly advanced plants of *B. virginianum* as having no spikes; but this species is one of advanced leaf-complexity. In *Helminthostachys* also, in which the leaves are large and complex, Lang has depicted young plants with expanded leaves, but without spikes. One is disposed to conclude from these scanty facts that the simpler-leaved forms of this family are more early fertile than those with more complex leaves, an indication of their more primitive state: but further data are necessary to substantiate the point.

Lastly, there remains the case of *B. obliquum*, with its suspensor and its complete inversion of the polarity of the embryo. It is difficult to see how this is to be brought into relation to its biological surroundings. As the details of this aberrant embryogeny are not yet to hand, it must for the present be accepted as an objective fact, the chief interest of which lies in the demonstration that such differences as presence or absence of a suspensor, and consequent inversion of the initial polarity of the embryo, are possible within near circles of affinity: this will have its important bearing upon the comparison of *Isoetes*, where as in most Ophioglossaceae there is no suspensor, with other Lycopodiales, in which a suspensor is present and the embryogeny inverted as in *B. obliquum*.

CHAPTER XXXI.

COMPARATIVE DISCUSSION AND SUMMARY FOR THE OPHIOGLOSSALES.

THE Adder's Tongues cannot yet be considered as located in a definite position in relation to other groups of Pteridophytes. Their traditional place among the Ferns was accorded to them somewhat light-heartedly, and before the details of their anatomy or development were adequately known. They share two external characters with the Ferns, viz. that they are large-leaved, and that the sporangia are distributed over a considerable extent of the foliar organ. But to use these in themselves as a ground for ranking them as Ferns involves the assumption that the origin of a large sporophyll only occurred once in Descent, an assumption that is not warranted. On the other hand, a relationship with the Lycopodiales has been ascribed to them: this has been based in the first instance upon the position of their peculiar spore-bearing member, the spike, as it is called; and it has been urged that the insertion of this part is the same as that of the sporangium of the Lycopodiales or of the sporangiophore of the Psilotaceae, while the function of these parts is also alike. This argument, like the first, draws its cogency from an assumption, that all the appendages holding a ventral position on the leaf were of common origin. But parallel development in distinct phyletic lines may account for this common feature, as it does for so many others in the plant-body. The day is past when single characters such as these can be accepted as defining relationships, and it is in the study of all the characters that an indication of the natural position of any family is to be found. Certain recent writers have indicated a specially primitive position for the Ophioglossaceae, comparing them directly with the Anthocerotales,¹ while V. Wettstein² gives them the first position in his treatment of the Pteridophyta, with the remark that "the Ophioglossales are the only living Pteridophytes from which the rest of the Pteridophytes can be derived." With such divergent opinions before us

¹ Campbell, *Mosses and Ferns*, 1905, p. 600.

² *Handbuch d. Syst. Bot.*, p. 52, etc.

a general revision of the characters of the Ophioglossales has seemed advisable; and any such revision should involve not only their comparison with other types, but also, what is perhaps more important, a comparison of their different genera and species among themselves.

The whole question of the character and relations of this family turns upon whether they be regarded as an ascending or a descending series. The former view, that they are a series of reduction, is entertained by many botanists, but without, as far as I am aware, any full or detailed statement of the grounds for this opinion: their "saprophytic habit" has, however, been advanced as one source of their modification.¹ As regards this saprophytic habit the following considerations may be brought forward.

Mycorrhiza has been observed in *Ophioglossum vulgatum*,² in the mature plant: Bruchmann states, however, that it is absent from the young plant.³ It is present in the mature plants of *O. pendulum*⁴ and *simplex*,⁵ and is specially prevalent in the peculiarly modified embryo of the former species with its unusually precocious root.⁶ It has been seen in twelve species of *Botrychium* by Grevillius, but in varying abundance,⁷ and Kühn had previously described it for *B. Lunaria*:⁸ Bruchmann⁹ showed that mycorrhiza is present in the young plant of the Moonwort, and that since the eighth or ninth leaf is the first to be expanded above ground, the plant is saprophytic in its nourishment up to its eighth or ninth year. In *Helminthostachys* the fungus is present in the first three or four roots of the young plant, but absent in the roots later produced.¹⁰ It is thus seen that mycorrhiza is not distributed with constancy in the family: in some it may be present in the young plant but absent in the mature: in others the converse; while some are distinctly saprophytic, none have gone so far as to discard entirely the chlorophyll-function throughout life: in *Botrychium Lunaria*, however, the mycorrhizic habit appears to be obligatory.¹¹ The most peculiar case, as it is also instructive in another point, is *O. simplex*, in which the presence of mycorrhiza goes along with the apparently complete absence of the sterile leaf: here it would seem that the mycorrhiza makes the nutrition of the large spike still possible in the dense wet forest in which the plant grows, notwithstanding that the usual assimilating organ is functionally absent. Reduction is, however, not apparent in the large spike itself, for provided nutrition be kept up from whatever source, it would still retain its character, being essentially a spore-bearing organ. Thus *O. simplex* teaches what is also seen elsewhere, that it is the vegetative rather than the propagative system which is primarily

¹ Scott, *Studies in Fossil Botany*, p. 511.

² Russow, *Vergl. Unters.*, p. 122.

³ *Bot. Zeit.*, 1894, p. 241.

⁴ Janse, *Ann. Jard. Bot.*, xiv., p. 64.

⁵ Bower, *Ann. of Bot.*, xviii., p. 207.

⁶ Campbell, *l.c.*, Plate XVII., Figs. 128, 129.

⁷ *Flora*, 1895, p. 445.

⁸ *Flora*, 1889, p. 494.

⁹ *Flora*, xvi., 220.

¹⁰ Farmer, *Ann. of Bot.*, xiii., p. 421, and Lang, *Ann. of Bot.*, xvi., p. 42.

¹¹ Stahl, *Prings. Jahrb.*, xxxiv., p. 574.

affected by disturbed nutrition. This may be presumed to have been the case in *Psilotum*, where the large size of the synangium proportionally to the small bifurcate leaf indicates reduction of the latter, but not of the former in the same degree.

In estimating the effect of mycorrhiza in any family as a whole in which it occurs it is necessary to take into account in the first place its constancy; and it is seen that it is not constant in the Ophioglossaceae. Secondly, it is a matter of general observation that plants with an endotrophic mycorrhiza commonly show a structure in accordance with a limited transpiration stream: their root-system is compact, and hydathodes are absent from their rather leathery foliage.¹ The Ophioglossaceae show such structure, which should not be confused with the results of saprophytic reduction. It may have been primitive for them, and in this connection it is to be noted that mycorrhiza has been described in plants from the Lower Coal Measures, so that it is no newly adopted manner of life.² The condition of *Helminthostachys*, with its mycorrhizal embryo and non-mycorrhizal mature plant, would be consistent with a primitive mycorrhizal state, from which the plant had broken loose and passed to an autotrophic condition. But, thirdly, it is important to note that among plants at large many species in which it is present show no sign of reduction either in their vegetative or in their reproductive parts. This may be well illustrated among the Pteridophytes themselves. Thus *Lycopodium inundatum* is found to be mycorrhizic, but its general habit, especially in the large American forms, does not suggest reduction as compared with other species. *L. cernuum* is mycorrhizic in the young plant, but it is one of the most elaborate of Lycopods. *Selaginella spinulosa* is mycorrhizic, but *S. helvetica* is not; and yet *S. spinulosa* cannot be held as relatively reduced. How little the occurrence of mycorrhiza may be found to affect the morphological character of Ferns is shown in the Marattiaceae. According to Kühn³ a fungus is found in the roots of *Kaulfussia*, of *Angiopteris*, and of *Marattia alata*, but not in those of *Marattia fraxinea*; but no reduction is to be noted as the result in the former Ferns as compared with the latter. Again, *Cyathea* is stated to have mycorrhiza, while *Asplenium nidus* has not.⁴ Such facts as these clearly indicate that in Pteridophytes the presence of a mycorrhiza does not spell reduction. Accordingly it cannot be justly assumed that the somewhat inconstant occurrence of the mycorrhizic habit in the Ophioglossaceae has been a source of general reduction in the family, though reduction may have played its part in certain species. The argument in favour of their being a reduction series as a whole will have to be based on other evidence.

Pending the statement of such evidence, the Ophioglossaceae may be treated, without any preconceived idea of general reduction, in the same way as any other family of plants. The natural comparison of them

¹ Stahl, *l.c.*

² Weiss, *Ann. of Bot.*, xviii., p. 255.

³ *Flora*, 1889, pp. 491-497.

⁴ Jansen, *l.c.*, p. 64.

among themselves—and not giving undue weight to the species which happen to be the commonest—leads almost inevitably to their seriation in the way indicated above (pp. 431-446). The upright radial, unbranched shoot is the central type, and the only departure from it is in the large-leaved *Helminthostachys*, where the dorsiventral rhizome may be held as illustrating a secondary condition; the primitive stock was probably upright and radial for them all. It was also polyphyllous, as in most other Vascular Plants, while each leaf bore the characteristic spike, which is essentially identical in them all, whatever its actual nature may be held to be. Within the family it is probable that the three genera illustrate three distinct lines of descent from some common source, already provided with a body of the nature of the spike. In *Ophioglossum* the original polyphyllous state is still seen in various smaller species: and it is worthy of remark that the nearest similarity to other strobiloid types is seen in those species in which the appendages are simplest and smallest. But, as pointed out above, the monophyllous habit has biological advantages in plants with an underground stock, and with its adoption followed enlargement of the individual leaf, and of the spike, the two parts showing some degree of parallelism of dimensions. Thus the ordinary type of *O. vulgatum* is attained. Fission or chorisis of the spike is an occasional occurrence in *O. vulgatum* and other species, but it became a fixed character in *O. palmatum*. It appears probable, however, that it is only attained in this species in fully matured plants: thus the individual of this species may be held to illustrate in its own life the origin of its more complex form. Here again a parallelism exists between the irregular lobing of the sterile lamina and the number of spikes which it bears. It would be difficult to explain these characters in any other way than as an ascending series involving chorisis. A probable line of reduction does, however, occur: it is illustrated by the series *O. pendulum*, *intermedium*, and *simplex*, the latter having no functional representative of the fertile lamina.

A distinct line, also of progression, is seen in *Botrychium*, but with different details. The series of forms seen in *B. simplex* (Fig. 240), and in the young plants of *B. Lunaria*, link on by their simplest forms with the condition of a small *Ophioglossum* with simple sterile lamina and unbranched spike: by very gentle gradations they lead on to the branched sterile lamina and fertile spike characteristic of the genus, the branching of the spike being closely connected with the enlargement and fission of the sporangia. There is reason to believe, as Laerssen has indicated,¹ that these forms illustrate progress in the life of the individual, from the simpler to the more complex: and the suggestion lies near to hand that the individual in this respect "climbs up its own evolutionary tree." The continuation of this method of advance would lead onwards to the most complex forms, the spike and lamina preserving a parallelism as before.

¹Rab. *Krypt. Flora*, iii., p. 579.

On this view the two genera, starting from a common source, would be held to illustrate two distinct lines of progression to a more complex state.

The third genus, with its single highly elaborate species, gives no such suggestion of its origin by comparison of nearly allied species. It stands as the most isolated member of the family: but its normal spike is evidently similar in plan to that of a large *Ophioglossum*, supposing its marginal rows of sunk sporangia were replaced in *Helminthostachys* by serried ranks of sporangiophores. There is a biological probability that such an advance should occur in a large spike bearing many spores, for thereby the advantage is gained of more ready nutrition of the subdivided sacs, and more easy dissemination of the spores when mature.

The progressive advance thus suggested for the Ophioglossaceae is in accord with biological probability, in a series with a marked tendency to a monophyllous state, and consequent enlargement of the individual leaf. Provided the nutrition be available, an increase in numbers of spores is an advantage in any homosporous form. But an indefinite increase in size of individual sacs raises difficulties of nutrition: subdivision is thus to be anticipated in any progressive series, and that is seen in *Ophioglossum*. A projecting position of the individual sporangium is an advantage in dissemination of the spores. This is ill provided for in *Ophioglossum*, and in this respect *Botrychium* and *Helminthostachys* show a more effective state. It appears to me difficult, without special reasons assigned, to recognise this family as a series of reduction, for it would be in opposition to these biological considerations. On the other hand, comparisons within the family clearly indicate an upward rather than a downward progression, while in any case those who hold a theory of reduction would find peculiar difficulty in explaining the condition seen in *Ophioglossum palmatum*.

The next step will be to discuss the morphology of the fertile spike, and to see what are its nearest correlatives among the members of other Vascular Plants. The spike in all the representatives of the family is clearly the same part: it is in fact truly homologous, or homogenous in the strict evolutionary sense. This follows from the high degree of constancy of position and function which it shows in normal cases.

Various theoretical explanations of its morphological nature have been given by different writers. It has been suggested by Braun¹ that the sterile frond is a foliage leaf, and the fertile spike the only developed leaf of a bud seated in its axil, and coalescent with it. Somewhat later, Roeser (1843) published the opinion that the sterile spike and fertile leaf are equivalent—that is, borne by the same axis—but coalescent together. Subsequently he substituted for his old view the opinion that the fertile spike is the result of coalescence of two lateral, lower, fertile pinnae of a frond, of which the remainder is usually sterile.² Lastly, Goebel has put forward the opinion that the fertile spike is the lowest pinna of the

¹ *Flora*, 1839, p. 301.

² *Bot. Zeit.*, 1850, p. 271.

sterile frond, which however arises not laterally, but in a median position.¹ Of these various views, which all coincide in attempting to refer the spike in origin to a leaf or part of a leaf of the ordinary vegetative sequence, only that of Goebel may be considered to hold the ground at the present time.²

The arguments advanced by Goebel in support of his theory were primarily a comparison of malformations, especially in *Botrychium Lunaria*. It was pointed out that here the normally sterile leaf shows most various intermediate steps of fertility till, in extreme cases, it may be wholly represented by a fertile sporophyll (Fig. 242, p. 443). It is recognised that in these cases there has occurred a true metamorphosis of a foliage leaf into a characteristically formed sporophyll, which differs in a striking manner from a foliage leaf. The inference which Goebel drew was "that this is also the case in the normal and usual sporophyll, *i.e.* that this is produced from a part of a foliage leaf." This argument has been dealt with at length elsewhere.³ But more recently Goebel has strengthened his position by observations on the young leaf of *Helminthostachys*.⁴ He does not give any account of the first origin of the spike, which in *Botrychium* has been traced and found to be different from that of the sterile pinnae,⁵ but lays stress upon its similarity of form to the sterile lobes, upon its dorsiventral character, and upon the development of the lateral wings in abnormal cases, like those of the foliage leaves. He concludes: "We can therefore trace back the sporophyll to a specially far-reaching transformation of the vegetative leaf."

In his admirable discussion on teratology in Schenk's *Handbuch*⁶ Professor Goebel has drawn attention to the fallacious conclusions which may be arrived at, on the assumption that malformations really afford evidence of the morphological nature of the parts concerned: he has quoted as an example the malformations of the ovule, of which specimens may be selected, so as to illustrate the gradual steps of abortion of the nucellus and integuments, together with correlative vegetative growth of the funiculus, till the result is reached that the whole ovule is replaced by a simple leaflet:⁷ but he concludes that this final result shows how little justification there is in accepting the vegetative

¹ Schenk's *Handbuch*, vol. iii., p. 111; *Organography*, vol. ii., p. 481.

² Sufficient reasons for setting aside Roesper's theory have been given in *Studies*, ii., p. 46. The position of those who speak of the spike as a "ventral lobe" of the leaf appears somewhat obscure: if by this is meant a body which may exist in the vegetative state, then either it must have been marginal or ventral in origin: if the former, the view is that of Goebel: if the latter, then it lies with them to show that such vegetative parts exist in these or other plants. But the term may connote a ventral part which has been fertile throughout descent: in that case the view is coincident with my own advanced in 1891 (*Proc. R.S.*, Dec. 17, p. 270), and now submitted again in a modified form.

³ *Studies*, ii., p. 8.

⁴ *Organography*, vol. ii., p. 481-485.

⁵ Bruchmann, *l.c.*, p. 218.

⁶ Vol. iii., pp. 114-125.

⁷ *Loc. cit.*, p. 121.

development of spore-bearing parts as phenomena of reversion. This is precisely the view which I take with regard to the fertile spikes of the Ophioglossaceae; the fact that when spore-production is suspended in them a correlative vegetative growth may result, in form like that of the sterile leaf, or some portion of it, is to be compared with the similar cases of those ovules which are replaced by leaflets. In the case of the Ophioglossaceous spike, as in that of the ovule, its replacement by a body resembling a foliage leaf or leaflet does not demonstrate its homology with, or its origin from, such a part: nor does the formation of a lateral vegetative wing in place of the marginal sporangia, or sporangiophores, show that the latter were in descent the result of transformation of the former.

There is also the inherent objection to Goebel's view, that it ascribes the origin of the sporophyll to transformation of a vegetative leaf. It is doubtless possible, by assuming a megaphyllous plant with elaborate vegetative structure as pre-existent, to imagine its reduction and modification to produce such forms of spore-bearing parts as we see in the Ophioglossaceae. But to those who hold consistently to a theory of antithetic alternation, with sterilisation as one of its most important features, this assumption is not admissible: to them sporophylls are not modified foliage leaves (compare Chapter XIII.).

All the theories which would refer the spike in origin to some foliar part, modified or altered, start from the more elaborate types of the family, and assume reduction. But if the converse line be taken, quite different views emerge. And there have not been wanting those who have already approached the question of the morphology of the spike in this way, which is certainly the most direct.¹ It seems more probable that a sound view of the morphological nature of the spike should be obtained through comparison of its simpler forms than of the more complex with what is seen in other Pteridophytes:² and it is naturally with the microphyllous forms that the closest correspondence may accordingly be expected.

¹ Mettenius, *Bot. Zeit.*, 1867, p. 98; Celakovsky, *Prinzh. Jahrb.*, 1884, p. 291.

² An interesting passage from Goebel's *Organography* may here be quoted, which is specially applicable to the present case (Engl. ed., vol. i., p. 60): "Most of our phylogenetic series are reduction-series, that is to say, are those in which the changes are brought about by arrest. There is a simple psychological explanation for this. If we have a definite 'type' we obtain through it a fixed starting-point for our comparison. But this is wanting when our comparisons deal with an ascending and not with a descending series. It is specially necessary to refer to this, because arrests have frequently been assumed upon the subjective grounds above indicated without definite proof of their being existent. . . . It is only our synthetic necessity which forces us always to the assumption of reduction-series, of which, however, many can only claim to be fictions, imparting the aesthetic pleasure of bringing a series of facts into connection with one another." The "synthetic necessity" in the present case has been to bring the large-leaved Ophioglossaceae into line with the definite large-leaved type of the Ferns: the latter have been constituted a fixed starting-point chiefly because they are well known.

Among the microphyllous Pteridophytes there is sometimes no strict relation between the spore-bearing members and the bract-leaves, but in the majority of them some constant relation is found. The common type is for the former to be in the median position relative to the latter, though the level of insertion may vary. In the Sphenophyllales this position is seen in the simpler forms, such as *S. majus* and *trichomatosum*; but it is departed from in others where, probably owing to fission, the number of sporangiophores is larger than that of the subtending bracts. In the Psilotaceae the radial position is maintained, but the insertion is very close to the apex of the sporophyll. This local relation of the two parts is so constantly seen in these groups, which include some of the most ancient plants, that it suggests for them a fixed morphological character rather than a mere result of independent adaptation. The existence of a like constant relation in another group compels the exact comparison of the parts thus similarly placed and functionally identical. The criterion whether this is a mere analogy, or whether some deeper significance underlies it, will be found in the degree of correspondence which the plants show in other characters than the one in question. To apply this test a comparison will be made between the Sphenophyllales and the Ophioglossales, first as regards their spore-producing members, and afterwards in respect of the other characters of the sporophyte.

Both in *Ophioglossum* and *Botrychium* species occur with small spikes bearing few sporangia, and they are specially found in the young plants (*O. Bergianum*, *B. simplex*, and *Lunaria*): it is in these that the closest similarity exists between the two genera, while from them by gradual steps the two types diverge. These small spikes consist of a simple stalk with vascular supply, bearing towards its distal end a few sporangia marginally disposed: the insertion is median on the sporophyll: the essentials of form, position, and function are here similar to those of the sporangiophores of the Psilotaceae, and especially of those stalked sporangiophores of *Tmesipteris* described by Thomas.¹ The differences lie in the forked leaf of the Psilotaceae, while that in these simple types of the Ophioglossaceae is usually entire, and in the exact position of the sporangia.

But in both groups there may be a departure from the exact numerical and local correspondence of sporangiophores and sporophylls: and these lead to an interesting comparison. The case of *O. palmatum* has been referred to chorisis of the single spike, which seems the only explanation of the plurality of irregularly branching spikes seen in an intra-marginal position in that species. In the Sphenophylls the frequent close juxtaposition of the pedicels of the sporangiophores points to a similar chorisis, as accounting for the condition seen in *S. Dawsoni*, and possibly also in the imperfectly known *S. Roemerii*. Moreover, the vascular connections of

¹ *Proc. R.S.*, vol. lxi., p. 345.

the sporangiophores in the more isolated *Cheirostrobus* point to a similar origin of its very complex state. It would thus appear probable that the sporangiophore of the Sphenophyllales and the spike of the Ophioglossales are parts not only similar in position and function, but also susceptible of choris. This may be held by some to be only a distant analogy: but such analogies have a way of developing into convincing evidence when they prove to be cumulative.

The first appearance of the spike in *Ophioglossum* is upon the upper surface of the sporophyll, in a median position some distance from the apex, but in *Botrychium* it is close to the apex (Bruchmann, *l.c.*, Fig. 57). A comparison of the latter with what has been seen in *Psilotum* and *Tmesipteris* (Figs. 230, 232), shows a striking similarity in the position of the spore-bearing parts relatively to the apex of the sporophyll. If this similarity also be only one of analogy, it is at least a singularly close one. In the Psilotaceae only two lateral leaf-lobes are subsequently formed, but in *Botrychium* a considerable number. The pronounced apical growth of the Ophioglossaceous spike is also a point of difference from the sporangiophore of the Psilotaceae; but it naturally accords with the more elongated form when mature.

The details of development of the sporangium afford material for further comparison. It has been shown how in the Psilotaceae there is special difficulty in recognising the exact limits of the sporogenous masses at an early stage of the sporangium, and that there is no definite tapetum. In *Ophioglossum* the condition is similar: there is the same indefiniteness of the sporogenous masses when young, and the same absence of a definite tapetum. On the other hand, the Ophioglossaceae themselves show interesting gradations: for while *Ophioglossum* has the indefinite characters noted above, *Botrychium* and *Helminthostachys* show a more definite specialisation of the sporangia, which goes along with their smaller size; for here the tapetum is a definite one, and originates outside the sporogenous tissue. There is thus an approach in the Ophioglossaceae to the condition seen in the Eusporangiate Ferns. The indefinite condition of the sporangium is exceptional among the Pteridophytes: of living forms it is most prominently seen in *Ophioglossum*, *Psilotum*, and *Tmesipteris*. This similarity materially strengthens the comparison between the spore-producing members of the Psilotaceae and Ophioglossaceae.

From the development of the individual spikes of the latter some idea may be formed of the steps which probably led from the simple structure on which the comparison has so far rested to the more complex. In *Ophioglossum* the lateral rows of sporangia arise from the sporangigenic band: its cells, originally alike, differentiate into sporangial wall, septa, and sporogenous groups: in point of origin the latter are all alike, and the structural details are in accord with a theory of progressive septation, that is, a conversion of part of the potentially fertile tissue into sterile septum in the enlarging

part. Such sterilisation, amounting even to the formation of permanent septa, has been shown to take place in other plants, and the theory is not open, therefore, to *à priori* objection (see Chapters VII. and X.). The frequent absence of sporangia from the tip of the spike is probably due to abortion: they cover the apex in some species, which also show abortion of sporangia lower down (e.g. *O. pendulum*). The presence of vascular strands in the septa themselves shows how the physiological supply followed the structural advance: on a theory of lateral fusion of sporangia such a position of the vascular strands would be, to say the least, improbable. Lastly, imperfect or irregular septa have sometimes been seen. Thus the structure, so far as it goes, readily coincides with a theory of extension, and progressive septation to produce the spike of *Ophioglossum* from some simpler beginning.

The case of *Botrychium* is similar, though less obvious, owing to the isolation of the sporangia, while it is complicated by the fact that branching of the spike frequently accompanies septation. That a structure compatible with progressive septation exists is shown by Figs. 253, and its relation to the branching, which brings such conspicuous results in the spike of *Botrychium*, appears in its simplest form in Figs. 252. It only requires the repetition of the processes, which are thus illustrated in the individual, to lead from the simplest to the most complex spikes in the genus.

Lastly, in *Helminthostachys* the ranks of sporangiophores correspond in position to the rows of sporangia in *Ophioglossum*. An upgrowth from the sporangiogenic band, less regular, but of the same nature as that seen in the branching of the spike of *Botrychium*, would give the sporangiophores of *Helminthostachys*, while the individual development directly represents what this progressive theory demands. This, indeed, is the foundation upon which the present view of elaboration of the spike in the Ophioglossaceae is primarily based: without any preconceptions involving reduction or modification, the theory is founded directly upon the simple facts of individual development.

The anatomical structure of the shoot in the Ophioglossaceae with its rare dichotomy, which compares rather with the microphyllous than with the megaphyllous Pteridophytes, may next be considered. It has been seen above (p. 464), that the facts observed are compatible with an origin of the axial system from a protostelic state. The stele of the seedling or adventitious bud, is either a protostele or slightly medullated monostele: passing upwards along the shoot there is an amplification of the stele, with swelling of the central pith. In the lower region there is usually a well-marked endodermis: this may be continued throughout the length of the rhizome, but in some cases it fades out upwards, as the stele distends. The xylem in the upper region forms a hollow cylinder or funnel, more or less interrupted by leaf-gaps, where the single strands of the several leaf-traces pass off. The protoxylem is not

always well marked: it is next the pith in *Ophioglossum* and *Botrychium*, but mesoxyletic in *Helminthostachys*. The central protoxylem in the stele of the seedling is in a position corresponding to that in the medullated stele of the older stem of *Ophioglossum* and *Botrychium*; consequently, the mature state appears to be a natural amplification of the centroxylic protosteles.

The mesarch xylem of *Helminthostachys* presents a difference from the rest, and it raises a question as to the importance attaching to the exact position which the protoxylem holds, for purposes of comparison. The stele of *Tmesipteris* is mesarch also in its upper region (Fig. 268), and this is stated to be so also locally in *Psilotum*, though the position of the protoxylem in both is peripheral in the lower parts. Again, in *Selaginella spinulosa* it fluctuates in the individual stem (Fig. 173): in the seedling all conditions from the endarch below, to the mesarch, and finally to the exarch above, may be seen in sections taken successively from the same plant. The Psilotaceae and Ophioglossaceae thus show a similar instability within their respective families, and in less degree in the individual plants also, and this instability is shared by *Selaginella*. This deprives comparisons based on the exact position of the protoxylem of much of their cogency, so far as they relate to these families. Too much weight has been attached to the position of the protoxylem in the comparative study of the Pteridophytes. It is a well-known principle of taxonomy that diagnostic characters which may be good in one alliance may be so fluctuating as to be useless in another. This appears to be so in respect of the position of the protoxylem in many of the strobiloid Pteridophytes. Accordingly, a prevailing, though not constant central position of the protoxylem in any given family cannot be held as in itself invalidating comparisons on other grounds with types where the protoxylem is usually though not always peripheral. The conditions, in point of fact, overlap within certain families, or even in the individual; the position of the protoxylem as a comparative or diagnostic character must therefore be held as suspect. In the present case the prevalent centroxylic state of the Ophioglossaceae cannot in itself be held to dissociate them anatomically from the strobiloid Pteridophytes (and particularly from the Psilotaceae), since both meet on common ground in showing at times a mesoxyletic condition.

The stele of the Ophioglossaceae, amplified as described, does not remain a closed cylinder: its continuity is interrupted by foliar gaps, the vascular ring opening at the point of exit of each leaf-trace. The structure is that described as phyllosiphonic by Jeffrey, and distinguished by him from the cladosphonic type, where the leaf-trace passes off from the stele without any opening. Jeffrey has laid this distinction down as separating his Lycopsida from his Pteropsida. According to their structure, the Ophioglossales would then fall into the Pteropsida. Jeffrey remarks¹ that

¹ *Phil. Trans.*, vol. cxcv., p. 144.

“these two great stocks appear to have been separate back to the beginning of the period when the palaeontological record begins.” If this were so, the anatomical difference would, in all cases, indicate a true phyletic distinction. It is necessary to obtain a clear idea whether or not this will hold good.

The structural difference is based upon the greater or less dominance of the leaf in the whole shoot; the phyllosiphonic type going, as a rule, with a megaphyllous state. But megaphylly may have been attained along more than one line of descent. If it arose in more than one phyletic

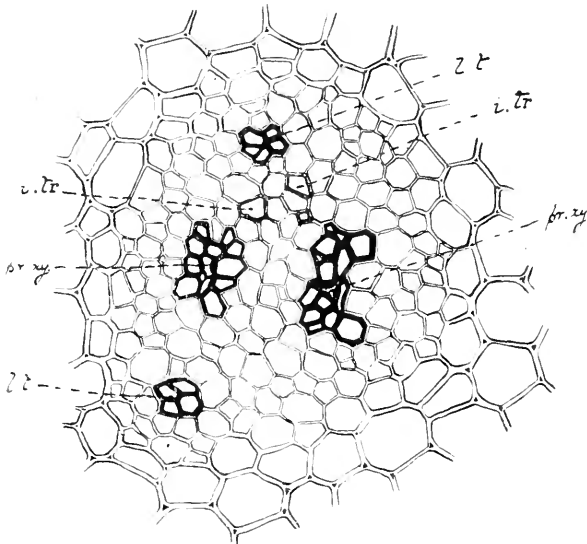

FIG. 268.

Tmesipteris tannensis. Transverse section of the sterile region, high up. The protoxylem (*pr. xy*) is mesarch. The xylem of the stele is fading out, and being replaced by parenchyma; three of the tracheides (*l. tr.*) show incomplete development; there is no longer a complete ring, and the leaf-trace bundles (*l. t.*) enter the gaps which result, in much the same way as in a phyllosiphonic type. There is no definite endodermis. $\times 150$.

line, then the phyllosiphonic state, which is its internal structural expression, will also have originated more than once. If this were so, then the phyllosiphonic structure would not necessarily indicate affinity, and the Pteropsida, as based on the structural point, could not be held to be a natural group. The question will therefore be whether there is any evidence of the origin of a phyllosiphonic from a cladosiphonic state. It might be expected either in a shoot, with increasing proportion of the leaves, or of decreasing proportion of the axis. The latter is the state of the distal region of the shoot of *Tmesipteris*, and Fig. 268 shows the condition there seen: the two larger tracts of xylem are separate; but isolated elements showing imperfect lignification link them together: the cauline stele is here seen in course of disintegration into mere leaf-traces: these enter the

axial system by foliar lacunae, after the manner of the phyllosiphonic type. But in its lower parts, *Tmesipteris* is typically cladophonic: it is thus seen that a phyllosiphonic structure may arise in a cladophonic stock, and the illustration is taken from that group of plants which show analogies with the Ophioglossaceae in other respects: on comparison of Fig. 268 with Fig. 258 of *O. Bergianum*, the essential similarity of the two cases is evident. But in the Ophioglossaceae the structural dominance of the leaf is on our hypothesis a consequence of the advance of the leaf towards megaphylly, combined perhaps with weakening of the axis which bears it. It matters little how the balance between the parts of the shoot is disturbed: the progression would be essentially the same in either case. These considerations show, in the first place, that it cannot be assumed that all phyllosiphonic plants are necessarily derived from a distinct and primitive phyllosiphonic stock, such as Jeffrey assumed for his Pteropsida: and secondly, that analogy of their structure with *Tmesipteris* indicates a possible origin of the phyllosiphonic type in the Ophioglossaceae, phyletically quite distinct from that shown by the true Ferns.¹

The leaf-trace in the Ophioglossaceae is typically a single strand, which branches within the cortex into strands which vary according to the proportions of the leaf which they serve:² these facts accord with a theory of origin of the leaf from the simpler type. It is interesting to note that "the branching of the leaf-traces within the cortex is very characteristic of *Sphenophyllum*."³ As regards the structure of the collateral strands of the leaf, those of the larger forms show similarity to the Eusporangiate Ferns, the smaller correspond rather to those of the larger-leaved strobiloid Pteridophytes.

The occurrence of secondary thickening in the Ophioglossaceae is occasional rather than typical of them. In *Helminthostachys* it is absent: in *Ophioglossum* a feeble growth has been occasionally seen; but in *Botrychium* it is a marked feature, and extends from the axis onwards to the base of the root. This inconstant occurrence of secondary activity, sometimes feebly shown, has its parallel in other affinities, both of Filicales on the one hand, as in the Marattiaceae,⁴ and of the Psilotaceae, where a development very like that of *Ophioglossum* has been seen in *Psilotum*.⁵ The

¹ It will be seen below that certain Ferns, for instance the Botryopterideae, are not phyllosiphonic: thus the anatomical distinction of Jeffrey breaks down on both sides.

² The only known exceptions to this are in *O. pendulum* and *simplex*, where the leaf-trace is inserted on the cauline system as several distinct strands. These species belong, however, to a section of the genus believed to be highly specialised rather than primitive types: and this character itself must, by analogy with the similar cases in the Ferns, be held to be derivative (see *Ann. of Bot.*, xviii., pp. 209, 215).

³ Scott, *Studies*, p. 91.

⁴ Farmer, *Ann. of Bot.*, xiii., p. 440.

⁵ Boodle, *l.c.* Scott (*Journ. Roy. Micr. Soc.*, 1906, pp. 519-521) has described under the name of *Botrychiexylon* a new genus from the Lower Coal Measures, with "radially seriated wood, apparently of secondary character." It is related anatomically to *Zygopteris* somewhat as *Botrychium* is to *Ophioglossum*.

more active development in *Botrychium* finds its correlative in the more active thickening seen in *Sphenophyllum*. These again may be mere analogies, but they are cumulative, in that they run parallel with others.

Lastly, it has already been shown that as regards structure of the roots there are unmistakable points for comparison of the Ophioglossales with the Lycopodiales on the one hand, and on the other with the Filicales, especially the Marattiaceae: the former comparison is in respect of the simpler, monarch types, the latter as regards the more complex: the latter branch monopodially as a rule, behaving thus like the roots of the Filicales: the monarch roots, however, show dichotomous branching. Unfortunately, the Psilotaceae, which show so many other points for comparison, are rootless, while the roots of *Sphenophyllum* are so imperfectly known as to give little help. Though the facts relating to the roots are not in any way decisive, they indicate, what emerges from so many other comparisons, that *Ophioglossum* shows characters approaching the strobiloid Pteridophytes, while *Helminthostachys* compares rather with the Filicales, and *Botrychium* takes a middle position.

In the embryology two distinct types have been recorded for the Ophioglossaceae, the one with and the other without a suspensor. That without a suspensor corresponds in its essentials to the type prevalent in those Pteridophytes which have the usual octant division. But there are modifications here in accordance with the underground origin from a large mycorrhizic prothallus, which nourishes itself saprophytically: the chief of these is the deferring of the period of functional activity of the shoot: consequently it is differentiated late, and though the root is not initiated early, as compared with other embryos, it very markedly precedes the appearance of the axis and cotyledon in *Ophioglossum*, and in less degree in *Botrychium*. This appears in an extreme form in those species described by Campbell, and especially in *O. pendulum*, where it is possible that the primary shoot is permanently replaced by adventitious root-buds, similar to those common in the genus. These modifications in time of development make the reference of the parts to definite positions in the embryo somewhat difficult. But it seems certain, nevertheless, that in the less extreme forms the axis arises from the epibasal hemisphere, in close proximity to the intersection of the primary octant-walls. The cotyledon appears between the stem-apex and the root, but it is late in origin. In *O. vulgatum* it appears simultaneously with the axis, and the relation is so close in *B. virginianum* that Jeffrey states that the cotyledon, like any other leaf, is derived from the shoot meristem. This is interesting in its bearing on the theory of the cotyledon, which has been held to be simply a leaf of the shoot showing anticipatory development (see p. 186-7). The foot which is not largely developed originates from the hypobasal hemisphere. The position of the first root appears to be indeterminate, as it is in some other embryos, a fact which is interesting as upholding the view that it is a mere accessory to the shoot. It is referred by

Bruchmann to the hypobasal hemisphere in *O. vulgatum*, but to the epibasal by Jeffrey in *B. virginianum*, where the whole hypobasal hemisphere goes to form the foot. In *B. Lunaria* Bruchmann found it impossible to refer it with any certainty to either. These facts, taken together with a similar uncertainty in the embryos of *Equisetum*, and the demonstration in the Lycopods that the root is variable in its point of origin, show that its indeterminate position is a frequent feature in the embryos of the strobiloid Pteridophytes, however constant it may appear to be in the Ferns.

Regarded as a whole, the Ophioglossaceous embryos without suspensor consist of a simple shoot, of which the polarity becomes apparent relatively late, but it is of the same nature as that seen in *Isoetes*, in *Equisetum*, and in the Ferns. The apex of the axis, arising in close relation to the intersection of the epibasal octant walls, is directed to the neck of the archegonium: the foot occupies the opposite pole, and the root appears as a lateral, accessory part, of indeterminate position, but of relatively early origin, and precocious growth.

The other type of embryogeny seen in *B. obliquum* shows an exactly inverted polarity: the condition appears to be comparable to that of the Lycopodiales (excl. *Isoetes*): the pole directed towards the neck of the archegonium becomes the suspensor, while the opposite pole develops the embryo, having parts quite comparable in position to those, for instance, of *Selaginella spinulosa*,¹ but with an early and strong assertion of the first root. The importance of this lies in the relaxation which such a fact brings from any rigid view of embryonic development: it seems completely to disprove any morphological predestination attaching to the primary cleavages of the zygote in the Pteridophytes.

The materials of this discussion may now be drawn together into a general hypothesis of the morphology of the sporophyte, as it is seen in the Ophioglossaceae. At the outset it has been concluded that the somewhat inconstant occurrence of mycorrhiza in the sporophyte is not a sufficient reason for assuming that the family has undergone general reduction: in the absence of any such preconception the family may be treated comparatively as an ascending series, though with the recognition of occasional reduction. The facts before us are in accord with the following account of it. The embryo sporophyte achieves an early polarity, marked by the definition of the stem-apex: the base of the shoot thus initiated is represented by the foot, or in *B. obliquum* by the suspensor. The primary axis thus defined continues its growth, with rare bifurcation, throughout the life of the stock; but adventitious or axillary buds (usually arrested) may be formed, which simply repeat the development of the primary shoot. The axis bears leaves in spiral or dorsiventral succession, and they are all of one primitive type, though liable to differentiation.

¹ Compare Bruchmann, *l.c.*, Taf. iii., Fig. 63.

The roots appear early: the first root (sometimes precocious and inordinately developed in accordance with the mycorrhizic habit) is essentially lateral upon the slowly developing axis, and the indefiniteness of its position, above or below the basal wall, indicates its accessory character. The whole shoot is, in fact, a rooted strobilus, which remains usually simple; but its strobiloid character is disguised by the abbreviation of the axis, and by the slow succession and relatively large size of its leaves.

The first leaf of an adventitious bud of *O. vulgatum*, or the third leaf in the sexually produced plant, may be fertile: in *Botrychium Lunaria* the ninth leaf has been seen to be fertile. Such data, limited as they are, show a record of early appearance of spore-producing members unequalled elsewhere. They indicate a high probability that all the leaves are of the nature of sporophylls, while abortion of the spike, so frequently seen in various degrees in later leaves, would account for its absence in those first formed. These may be expanded above ground (*Helminthostachys*, *O. pedunculosum*, *B. virginianum*), or may be arrested, and appear as mere scale-leaves. The latter is clearly a consequence of the underground and saprophytic habit of the prothallus, which diminishes the necessity of early self-nutrition of the sporophyte, and thus leads to reduction of the first leaves of the shoot as a purely secondary condition.

On the other hand, the underground habit leads, as already explained, towards a monophyllous development, with enlargement of the individual leaf. This is imperfectly realised in the smaller species of *Ophioglossum*, which on our hypothesis would be the more primitive; but it appears typically, though not universally, in the larger-leaved forms. Comparison combined with biological reasoning indicates, then, that leaf-enlargement has taken place. The anatomical facts accord with this: the solid or slightly medullated xylem of the stock widens out upwards into a funnel or cylinder, with foliar lacunae, where the single leaf trace-strands pass out: the dilating of the stele follows the increase in size of the leaves in the individual: this may be held to prefigure that of the race. Probably the original foliar supply was here, as in the strobiloid forms, a single strand, and this is still represented by the single bundle of the leaf-trace. In *O. Bergianum* the single strand may be seen continued without branching some distance upwards into the leaf. The branchings which appear in other species early in its course may on our theory have followed upon the enlargement and elaboration of the leaf. The Ophioglossaceae are phyllosiphonic from the first: but the case of *Tmesipteris* has been adduced as showing that a transition may occur from the cladosiphonic to the phyllosiphonic type: this may occur in any case where the balance between the axis and the appendage is disturbed, so as to increase the preponderance of the leaf. On our hypothesis of a strobiloid origin for the Ophioglossaceae this has been the result of the stunted development of the axis consequent on the subterranean habit,

and of the enlargement of the leaf culminating in monophylly: both these factors will have tended towards the dominance of the leaf, and so it is not surprising that the structure of the shoot should be phyllosiphonic from the first.

Reasons have been advanced above for not accepting the view of the fertile spike as a modified pinna, holding a median position. The alternative is that it is a substantive part not referable in origin to any vegetative structure previously present. Such substantive parts are seen in the Psilotaceae and Sphenophylleae, occupying a position corresponding to that of the Ophioglossaceous spike, viz. the sporangiophores. The smallest spikes of *Ophioglossum* or *Botrychium* are little in advance of these. From them, by seriation of specimens of the same species of different ages, and by further seriation of different species, the steps leading to the most complex forms of spike may be represented: while its branching, where present, is matched by the increasing complexity of the sterile leaf. The advance thus contemplated in the spike involves continued apical growth, and branching, together with growth and septation of the sporangia. Apical growth of limited duration already exists in the sporangiophore of *Psilotum*: the structure of the young spike in *Ophioglossum*, and less clearly that of *Botrychium*, is such as to be perfectly compatible with septation, a process for which there are demonstrated precedents elsewhere. Further, it has been shown that with the growth and septation of the sporangium the simplest branching of the spike of *Botrychium* is very closely allied. In *Helminthostachys* a further elaboration is present, which may be referred to the replacement of the sunken sporangia of *Ophioglossum* by dense ranks of sporangiophores: and it has been shown that this mode of origin is reflected in the individual development of the sporangiophore. Lastly, the spike, like so many other parts, is liable to fission or chorisism. The numerous sporangiophores of the Sphenophyllales seen in some species probably owe their origin to such chorisism. In *Ophioglossum* it appears occasionally in common species, such as *O. vulgatum*: branching or fission of the spike occurs not uncommonly in *O. pendulum*, but in *O. palmatum* it has become habitual, though there is reason to think that it is only attained in that species when the plant becomes fully mature. The various types of spike in the family thus readily lend themselves to interpretation as an upgrade series.

As regards the development of the sporangium the Ophioglossaceae form a series, from *Ophioglossum* with its large, ill-defined sporangia to the larger-leaved *Botrychia* and *Helminthostachys* with smaller and more definite sporangia. It has been shown that in the indefiniteness of limitation of the sporogenous tissue, and in the absence of a marked tapetum, *Ophioglossum*, *Tmesipteris*, and *Psilotum* agree more nearly than other Pteridophytes. It seems highly improbable that such indefinite characters would be the result of specialisation along parallel lines in two distinct series. This similarity may more probably be held as indicating

some degree of real affinity, and strongly confirms the initial comparison of the spike with the sporangiophore of the Sphenophyllales. Lastly, the anatomical comparison of the Psilotaceae with the Ophioglossaceae has shown not only the interesting transition from the cladosphonic to the phyllosiphonic structure, but also that in the upper region the wood of *Tmesipteris* is mesoxylic, as it is also in *Helminthostachys*, while feeble secondary development, analogous to that in *Ophioglossum* and stronger in *Botrychium*, is seen both in *Tmesipteris* and in *Psilotum*. These several characters form a cumulative body of evidence, confirming the comparison of the shoot and of the sporangiophore in the Sphenophyllales with those of the Ophioglossales: the nearest approach among living plants being between the Psilotaceae and *Ophioglossum*.¹

It would thus seem probable that the Ophioglossaceae sprang from some offshoot of the sporangiophoric Pteridophytes, allied in some degree to the Sphenophyllales, and possessing early a saprophytic habit of the underground prothallus. That this encouraged a peculiar specialisation of the sporophyte, which shared occasionally, though not generally, in the mycorrhizic habit, but not so far as to lead to the cessation of self-nutrition. That the exigencies of the underground habit were met by an enlargement of the leaves, culminating finally to the monophyllous state. A parallel enlargement of the sporangiophore with that of the leaf was a natural consequence, since in homosporous forms, as comparison shows, the spore-output usually marches with the vegetative development. If this were so, then the spike would never in its descent have been anything other than it is now normally seen to be, viz. a spore-producing part, originally of the nature of a sporangiophore, and seated in a median position on the adaxial face of the sporophyll.

Referring in conclusion to the theory of the strobilus, the Ophioglossaceae readily conform to it. The shoot, with its rare dichotomous branching, appears as a simple strobilus, while the indeterminate position of the root in the embryo bespeaks the accessory nature of that part upon it. The axis bears leaves, which are of one order only. The spore-producing parts appear earlier in the individual life than in any other group of Pteridophytes, and this indicates a probability that all the

¹I wish to state quite explicitly that the homology of the Psilotaceous synangium with the Ophioglossaceous spike is no new opinion on my part, though additional and more detailed evidence is here adduced to support it. It was accepted by me in 1891 (*Proc. Roy. Soc.*, p. 270) and more fully stated in 1893, on the basis of developmental evidence (*Proc. Roy. Soc.*, vol. liii., p. 22): this view has never been relinquished. I emphasize this here because a passage recently published appears to suggest that I do not uphold that homology (Scott, *Progressus Rei Botanicae*, i., p. 163). My position is unchanged, except in so far as I now include the Sphenophylleae also in the comparison: the suggestion of this came from Dr. Scott (*On Cheirostrobos*, *Phil. Trans.*, vol. clxxxix., 1897, p. 27), and it greatly strengthens the comparison originally drawn by Celakovsky. There may be differences of opinion as to what morphological rank these parts hold, or how ultimately they came into being: these are, however, separate questions from the recognition of their homology.

leaves were originally fertile. Abortion of the spike, partial or complete, accounts for its occasional absence, just as in *Isoetes*. These two types, so similar in their embryology, are similar also in the "Selago" condition seen in their stunted stocks. The one, however, bears a simultaneous brush of leaves, the other, for reasons biologically intelligible, tends to the monophyllous habit: this difference is only one of time, not of form or of relation, and accordingly both types are equally referable to a strobiloid origin, with enlargement of the leaf, and of the spore-producing part which it bears.

As regards factors of increase or decrease in number of sporangia, there may be some difference of opinion according to the view taken of the family as a whole. In accordance with the conclusion that the spore-producing spike illustrates an upgrade of development, there would be recognised as factors of increase, septation with continued apical growth of the spike, its branching and occasional fission: and in the case of *Helminthostachys* a further disintegration of sporangia and enation of sporangiophores. But there is no interpolation of sporangia so common a factor in Ferns. As factors of decrease there appear abortion of the whole spike, abortion of sporangia at the apex, and sometimes also at points lower on the spike, while a factor to be considered in addition is the reduction down to one in number of leaves simultaneously expanded. The factors of increase may in this case be held to have successfully counterbalanced those of decrease, and the net result is a spore-output that appears numerically to meet the requirements of the plants, though their ultimate success in propagation is limited by the exacting conditions necessary for their germination.



CHAPTER XXXII.

FILICALES.

INTRODUCTION.

Of the Pteridophytes only the Ferns now remain to be examined. They constitute a larger and more varied series than any of those which have gone before, and are especially prominent among those living at the present day. This, together with the fact that in them the observation of the complete life-cycle was first carried through, and is of all the Pteridophytes most easily followed, has given to them a peculiar position. The present-day Ferns have undoubtedly been appraised beyond their deserts as factors in the story of descent. It will be well at the outset to consider how they stand at the moment in the light of such knowledge as we possess of the vegetation of the past, and to compare their present position with the former estimates.

We have seen that the recognition of the main incidents of the life-cycle in a Leptosporangiate Fern was completed by Suminski in 1848, and it was found shortly after by Hofmeister, that the same scheme coincided in essentials with that of other Pteridophytes. Further comparison of the organs of propagation, and especially of the sporangia, disclosed the fact that those of the Leptosporangiate Ferns were structurally the simplest. In accordance with evolutionary views which became prevalent about the same time, the general assumption was made that the simplest organisms were those which were also earliest in descent, and that from them all the more complex were derived. On this foundation a superstructure of phylogeny was raised. In accordance with these views it became necessary to express the large and complex sporangia of the Lycopods or Ophioglossaceae in terms of those of the Leptosporangiate Ferns: this was effected through the theory of the sporocyst.¹ It was held that by fusion of numerous small sporangia, and elimination of their individual identity the large sporangia of the Ophioglossaceae were produced: by reduction of the whole spike the Lycopod sporangium;

¹ Strasburger, *Bot. Zeit.*, 1873, No. 6.

and finally by contraction of the whole Lycopod strobilus the synangium of the Psilotaceae. On the other hand, the origin of the simple Leptosporangiate sporangium was traced on the theory of Prantl, through the Hymenophyllaceae, directly from the Moss-sporogonium; the sorus of *Hymenophyllum* was held to correspond to the opened capsule.¹ These were doubtless extreme opinions of the time, but they show the position assigned to the Leptosporangiate Ferns in the discussions of a generation ago. These plants were regarded as the primitive Pteridophytes, and other forms as having been derived from them, while reduction was held to have been a general factor in the process.

The revolt against this position was initiated by Campbell,² who definitely gave precedence to the Eusporangiate types. Over and above the difficulties of comparison already felt, there loomed large the impossibility of harmonising a belief in the Leptosporangiate Ferns as primitive with the growing knowledge of Palaeophytology. The dearth of evidence, even of the existence of true Leptosporangiates comparable to those of the present day in Palaeozoic times, was pointed out: at the same time the existence of numerous fossils then believed to be rightly referred to the Marattiaceous affinity, indicated a priority of the Eusporangiate type. The comparative study of development of the vegetative organs and of the sporangium had meanwhile been actively pursued: on the basis of such facts it came to be held as probable that the more delicate structure seen in the Leptosporangiate Ferns was not itself primitive, but resulted from progressive specialisation.³ With the adoption of such a view the theories of Strasburger and of Prantl fell away, and the ground was open for recognising the Eusporangiate type, whether of Ferns or of other Pteridophytes, as of prior existence.

As a consequence, the Marattiaceous type of Ferns was believed to be the prevalent megaphyllous constituent of the Palaeozoic Flora. The sporangial structure, as well as the construction of the sori in many forms, agreed more or less nearly with that conclusion. The Lycopodiales, Equisetales, and Sphenophyllales, however, were held to constitute separate Eusporangiate phyla, there being no need to refer them to a Filicineous origin. The next step affecting the early history of the Fern-phyllum was the discovery that certain of those fossils which had been held to be true Ferns of the usual homosporous type were in reality Seed-bearing Plants, the male sporangia of which had been taken for the fructifications of a homosporous nature. The removal of such forms to the newly constituted Class of Pteridosperms has perhaps only commenced, and it is still impossible to say for certain how many of the fossils bearing like fructifications may follow. The question is thus raised, what is the residuum of true Ferns that actually remains among the Palaeozoic

¹ *Die Hymenophyllaceen*, Leipzig, 1875.

² *Bot. Gaz.*, Jan. 1890, and Dec. 1891. See also Bower, *Ann. of Bot.*, 1891, p. 127.

³ *Ann. of Bot.*, 1889, p. 305, and 1891, p. 127.

fossils? It will be shown in detail below that at least three types, which may reasonably be held to have been true Ferns, were represented in the Primary rocks, viz. the Botryopterideae, the Pecopterids of the group *Cyatheites* of Goepfert,¹ and also certain forms allied to some of the lowest Leptosporangiates, though there is some room for doubt how nearly they coincided with these.

On the question of detailed proof of the homosporous nature of these plants the reply for a given case has been supplied by Scott. He has found in the sporangia of *Stauropteris Oldhamia*, a fossil referred to the Botryopterideae, that the spores may germinate within the sporangium, just as they may be found to do in *Todea*, *Trichomanes*, and some other living homosporous Ferns. This leaves little room for doubt that the mode of reproduction of *Stauropteris Oldhamia* was essentially that of a true Fern.² But it is not to be expected that such evidence will be available in every case: nor indeed should it be considered necessary. The fact that such proof is accessible, even in a single instance, comes as a wholesome corrective to that tendency, which followed on the first discovery of Pteridosperms, to regard all Palaeozoic Ferns as potential Seed-Plants. The converse will, however, be the more natural position for those who view the new facts calmly, viz. to hold all Fern-like fossils as true Ferns until their character as Pteridosperms is proved. The question is mainly one of the state of advancement reached by any given fossil, for it may be presumed that the Pteridosperms sprang ultimately from a homosporous Fern-like ancestry. The *onus probandi* lies with those who are disposed to accord to any given fossil the more advanced position, however readily others will accept the proof as it becomes available. On this footing the Pecopterids, as limited above, together with the Botryopterids, and some others, may for the present be held to be Palaeozoic Ferns of the homosporous type, of which the life-history was in all probability essentially the same as that seen in modern Ferns. The early existence of homosporous Ferns, which evolutionary theory would suggest, or even demand, appears on the basis of Palaeophytological evidence to be beyond any reasonable doubt. But they are now recognised as bulking less largely in the early Flora than was once believed to be the case.

According to the arrangement and succession of development of their sporangia the homosporous Ferns have been divided into three series:³ the *Simplices*, in which the sporangia of a sorus are produced simultaneously: the *Gradatae*, in which there is a definite succession in time and space in their production: and the *Mixtae*, in which there is a succession in time, but no regular succession in space. These three types appeared successively in geological time: the *Simplices* were the characteristic Ferns of the primary rocks, though many of that type still survive: the *Mixtae*

¹*Syst. Filic. Foss.*, 1836, p. 319.

²*New Phytologist*, vol. v., p. 170.

³"Studies," iv., *Phil. Trans.*, Vol. 192 (1899), p. 122.

are the dominant Ferns of the present day, while the *Gradatae* take a middle place. This succession will be maintained in the detailed account of the several families, and consequently the description will follow in the main, though not in exact detail, the order of appearance of the several families of Homosporous Ferns upon the earth's surface. The order in which they will be taken up will be as follows :

<i>Simplices</i>	{	Botryopterideae. Marattiaceae (together with many Pecopterids). Osmundaceae. Schizaeaceae [Marsiliaceae]? Gleicheniaceae. Matonineae.
<i>Gradatae</i>	{	Loxsomaceae. Hymenophyllaceae. Dicksonieae (excluding certain genera). Dennstaedtiinae. Cyatheaceae [Salviniaceae]?
<i>Mixtae</i>	{	Dennstaedtia-Davallia series. Onoclea-Woodsia series. Matonia-Dipteris series. Pterideae and other Polypodiaceae

BOTRYOPTERIDEAE.¹

The organisms grouped under this name occur as Palaeozoic fossils, extending upwards to the Permian.² Though they are distinct from any other known family of Ferns, still there is no reason to doubt their Fern-nature: its recognition is based not only upon the external characters of the shoot, with the usual circinate veneration of the leaves, but also upon the anatomical details of axis and leaf, and upon the fact that the numerous sporangia are borne upon the distal region of the repeatedly pinnate sporophylls. Finally, in *Stauropteris Oldhamia* Scott has shown that the spores possessed the capacity for germination within the sporangium, as in some modern Ferns.

The plants had an erect shoot of radial construction: it was sometimes short, with closely aggregated leaves, as in *Grammatopteris Rigolloti*,

¹The materials for this description have been derived in the main from Renault, *Bassin Houiller et Permien d'Autun et d'Épinac*, ii., p. 33, etc.: Scott, *Studies*, p. 277, etc.: Stenzel, *Bibliotheca Botanica*, 1889, No. 12: Scott, *Progressus Rei. Bot.*, i., p. 178. I have also had the advantage of comparing specimens, chiefly those belonging to Mr. Kidston.

²Mr. Kidston has shown me a Botryopterid (*B. antiqua*) from the Petticur Beds, with axis and leaf bases showing structure. This he regards as probably the earliest record of a *Botryopteris*.

B.R. (Fig. 269), a condition comparable with that seen in a modern *Osmunda*; but in other cases the axis was more elongated, and the leaf-arrangement less dense, as in *Zygopteris Grayi*, where there is a two-fifths divergence (Fig. 270), or in species of *Botryopteris*, where the leaf-arrangement appears to have been more lax still. From the axis, which was often thin in proportion to the more robust leaves which it bears, sprang also numerous adventitious roots (*r*, Fig. 270): these seem to have acted as oblique prop-like supports where the axis was elongated. In some cases at least axillary buds arise in the axils of the leaves, very much as they do in some modern Hymenophyllaceae.

The leaves themselves were repeatedly branched, the pinnae arising alternately from the rachis, and being themselves further branched.

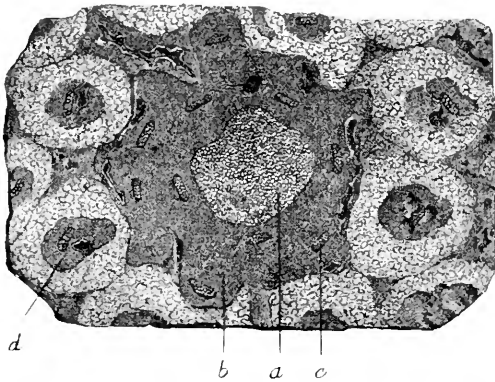

FIG. 269.

Botryopteris Rigolloti, B. Renault. Transverse section of the central part of a stem: within the axis lies the solid vascular cylinder (*a*) surrounded by a continuous band of bast; the cortex (*b*) is traversed by vascular strands (*c*) passing to the leaves; *d*=petioles surrounding the stem. Communiaux de Saint-Martin. (After Renault.)

Aphlebiae have been described on the leaves of both British and Continental specimens. The leaves were of a finely divided *Sphenopterid* type: in the sterile leaves the ultimate segments widened out into fan-like expansions: in the fertile regions the segments remained narrow, and upon the ultimate branchlets the large, pear-shaped sporangia were borne in distally directed tassels, or in some cases solitary.

Fortunately the internal structure is fairly well known in several distinct types of the family, and generic characters have been based upon the differences recognised. The simplest, and for comparative purposes probably the most important type, is that shown by *Grammatopteris Rigolloti* (Fig. 269), where there is in the axis a solid xylem-core, with the smallest tracheides at the periphery. Round this is an exiguous phloem, and a broad outer cortex. In the latter are embedded numerous leaf-trace bundles on their way out to the crowded leaves: their structure is simpler than in others of the family, the prominent feature being a strap-shaped

xylem band, flattened on its inner and outer faces. These strands branch off from the central stele with the minimum of disturbance, after the manner of the strobiloid Pteridophytes. A similarly simple origin of the leaf-trace has been seen also in species of *Botryopteris*, in which the stele is as little differentiated as in *Grammatopteris*: there is indeed an entire absence of well-marked protoxylem in the stele of *Botryopteris*. In *Zygopteris* also the origin of the leaf-trace is essentially the same, though here the matter is complicated by the curious differentiation of the xylem of the stele: there is an outer band consisting of larger, scalariform

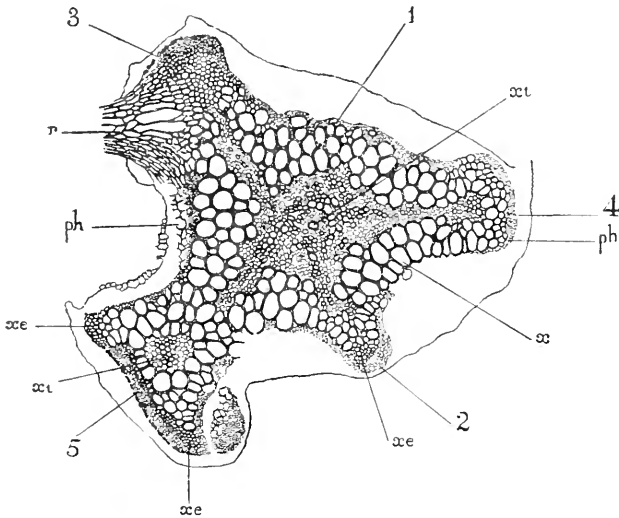

FIG. 270.

Zygopteris Grayi. Transverse section of stele, showing wood and remains of phloem. 1-5 the five angles of the wood, from which leaf-traces are given off, in order of the phyllotaxis, No. 5 belonging to the lowest of the series. x, principal ring of xylem; xi, small tracheides of internal xylem; ae, small tracheides at periphery; ph, phloem; r, base of adventitious root. $\times 14$. Will. Coll., 1919, B. (From Scott's *Studies in Fossil Botany*.)

tracheides, and a central core consisting of parenchyma together with a system of smaller tracheides: both of these contribute to the strand of the leaf-trace, which is abstracted off from the ray-like projections of the cauline stele (Fig. 270). A new genus from the lower Coal Measures has recently been described by Scott,¹ which is characterised by radially seriated wood, apparently of a secondary character: in other respects it had much in common with *Zygopteris*. This is the first evidence of secondary thickening in the Botryopterideae: the fossil has been named *Botrychioxylon*: but as the sporophylls have not yet been described, this very allusive name must be understood only to convey the fact that it is a Botryopterid showing secondary growth, just as *Botrychium* is an

¹ *Journ. R. Micr. Soc.*, 1900, p. 519.

Ophioglossaceous plant showing secondary thickening. Other axes are known, which are probably of this affinity, such as *Tubicaulis*, *Anachoropteris*, and *Asterochloea*: they show various modifications of the protostelic state. From these, as well as from the better known Botryopterideae, it is clear that a considerable series of Ferns existed in the Palaeozoic period which had a solid protostele, or some slight modification of it: their leaf-traces consisted of a single strand, and were given off without those profound disturbances of the cauline system characteristic of the "phylosiphonic" type of Jeffrey.

In *Grammatopteris* the vascular strand of the petiole was simple in outline, as seen in the transverse section. But in other Botryopterids it assumed highly complex forms, showing in some cases a tendency to radial organisation (*Stauopteris*): it is upon these that generic distinctions have been based. It is unnecessary here to follow out the structural details: it suffices to state that the relatively bulky petioles were cylindrical in form, and gave off pinnae laterally; while the upper regions have in some cases been seen to have the circinate vernation, and to be covered while young by a felt of peculiar hairs, as is the case in the more primitive types of modern Ferns.¹

The sporangia are known in *Botryopteris*, *Zygopteris*, *Grammatopteris*, and *Stauopteris*: the latter genus is now recognised as a member of the Botryopterideae, and it will be taken first.² Its sporangia have been found connected with the petiole known as *Rachiopteris Oldhamia*, Will, and are borne terminally on the finest branches of the rachis (Fig. 271). Their form is nearly spherical: the wall consisted of a superficial layer of larger cells, succeeded internally by several layers of smaller cells: no annulus has been observed, and the dehiscence is by a pore at the distal end. The spores are numerous: a moderate estimate, based upon the sections, would be 500 to 1000 for a single sporangium. It was in

¹ Since the above was written the publication of Tansley's Lectures on the Evolution of the Filicinean Vascular System has commenced (*New Phytologist*, 1907). He advocates a theory of origin of the leaf in Ferns by differentiation of a dichotomous branch-system to constitute axis and leaf, and adduces in connection with it many anatomical facts relating to the Botryopterideae. It is impossible here to review these facts in detail: it may, however, be stated that there appears to me to be nothing in them inconsistent with the leaf having been throughout a lateral member. If such a lateral member developed to a large size, it is to be anticipated that it should assimilate structurally to the axis in its lower parts, as it is seen to do in the Botryopterideae. There is no need to assume that it should retain constantly its dorsiventral character: the tendency to radial organisation seen in *Stauopteris* and some others is interesting, but not in any way decisive in the absence of all evidence how the leaf actually developed in relation to its axis in these ancient forms. Positively, however, we know that in the nearest living relatives (Hymenophyllaceae and Osmundaceae) the leaf does originate laterally on the axis. The question will be whether surmises based on observation of the mature structure in certain imperfectly known fossils are to take precedence of direct observations of development in living plants.

² See Scott, *New Phytologist*, 1904, p. 18, 1905, p. 114, and 1906, p. 170.

this species that the incipient stages of germination have been observed within the sporangium, a fact held to show its Fern-nature, while its other characters relate it to the Botryopteridae.

The sporangia have been successfully observed in *Zygopteris* by Renault (Fig. 272). They were borne in groups on the ends of the pinnules, and were pear-shaped and slightly curved. The stalk, though elongated, was fairly robust, and widened gradually into the sporangial head. The latter was composed of at least two layers of cells, the inner of which was

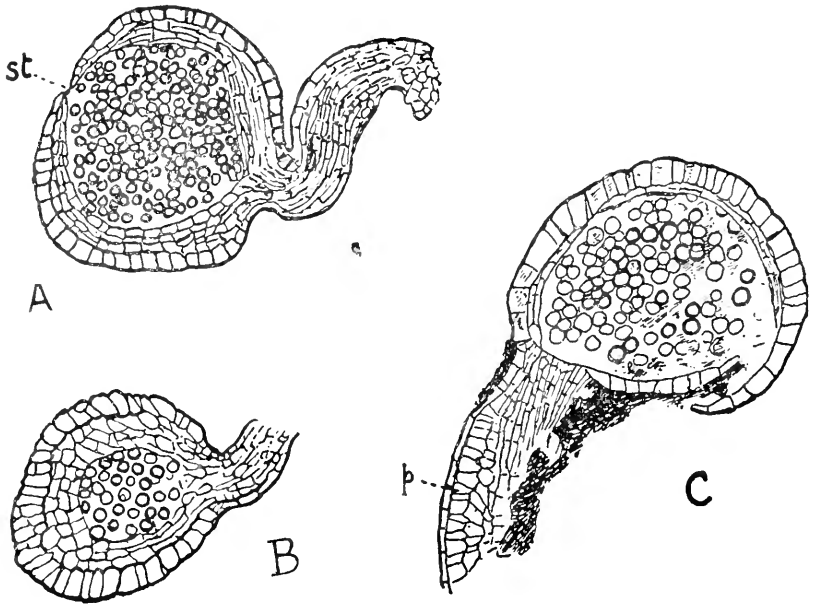

FIG. 271.

Stavropteris Oldhamia, Binney. *A* = sporangium in nearly median section, attached terminally to an ultimate branchlet of the rachis; *st* = stomium. Scott. Coll., 2213. *B* = sporangium in tangential section attached to a short piece of a branchlet. Scott. Coll., 2207. *C* = sporangium with wall burst attached as before. *p* = palisade tissue of branchlet. Scott. Coll., 2219. All figures \times about 50. (From sketches by Mrs. D. H. Scott. The specimens are from Shore, Littleborough, Lancs.)

transient, while the outer remains as the mature sporangial wall. This is differentiated to form the annulus, which appears as a broad band composed of several rows of deep cells, with indurated walls, and ran along either side of the sporangium from base to apex; the remainder of the wall is composed of smaller, elongated cells. The mechanical annulus thus composed of several rows of cells, forming a broad marginal band or hoop, resembles the similar structure seen in the sporangium of *Angiopteris* (see below, pp. 515-16). The spores are numerous: a rough estimate from the transverse and longitudinal sections drawn by Renault points to an output of 500 to 1000 spores in each full-sized sporangium: but there is considerable variation in the dimensions of the sporangia.

The spores are of approximately uniform size, and the plant appears to have been homosporous.

The sporangia of *Botryopteris forensis* have also been observed: they are of smaller size, and have the broad annulus on one side only. But in other respects they resemble those of *Zygopteris*.

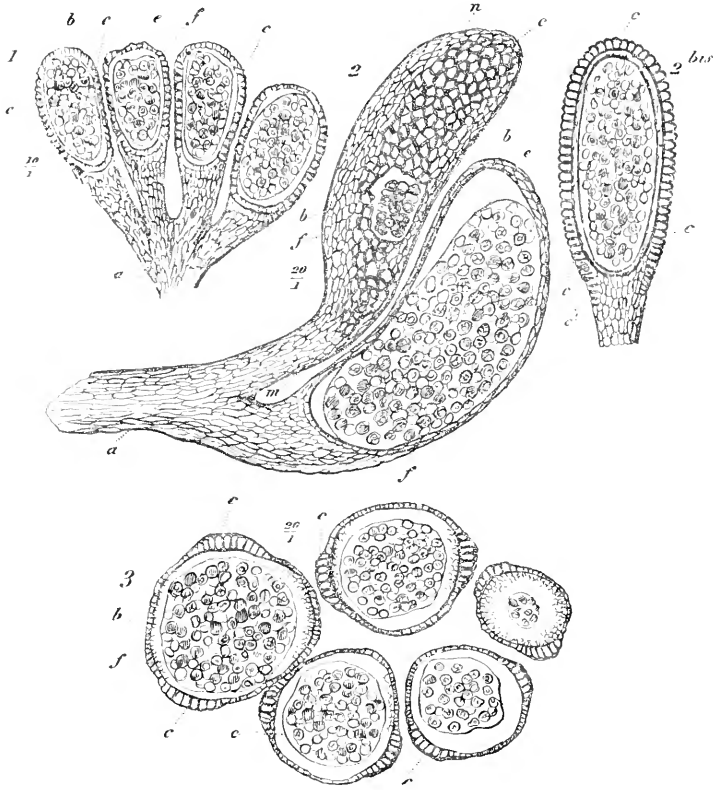

FIG. 272.

Zygopteris, sp. 1, group of four sporangia on a common pedicel (a). $\times 10$. 2, two sporangia on pedicel. The upper shows the annulus (c) in surface view, with spores exposed at f; the lower in section. $\times 20$. 2 bis, sporangium cut in plane of annulus. 3, group of sporangia in transverse section. $\times 20$. Lettering common to the figures. a, common peduncle; b, sporangial wall; c, annulus; e, tapetum (?); f, spores; m, pedicel of individual sporangium; n, probable place of dehiscence. All after Renault. (From Scott's *Studies in Fossil Botany*.)

A particularly interesting fructification attributed to this affinity is that described as *Corynepteris* (Fig. 273). Hitherto it is known only in the form of impressions. The leaves were of the Sphenopteroid, or Pecopteroid type, and the pinnules bore each a single sorus, of five to ten sporangia, grouped round a common centre. The annulus is here again a broad lateral band, consisting of several cell-rows: as the sporangia are grouped in the sorus the annulus of each sporangium is in juxtaposition with that of its next neighbour, a condition not unlike

that of the group of sporangia of *Zygopteris* shown in transverse section, which thus appear to constitute a radiate sorus (Figs. 272-3). Whether or not this is a constant feature in the latter Fern, it is clear that *Corynepteris* shows a sorus strongly suggestive of the arrangement in the Marattiaceae, a comparison already suggested by Scott.¹

The Botryopterideae have been recognised as a synthetic group, combining the characters of several known series of Ferns. The reasons for this opinion are to be found, first in their anatomical structure, and secondly in their sporangia. Though the leaves were relatively large, and much branched, and the petiolar structure often complex, the regularly radial axis remains relatively small, and its vascular structure exceedingly simple. The common occurrence of the undifferentiated protosteles is regarded as a primitive character: added to this is the

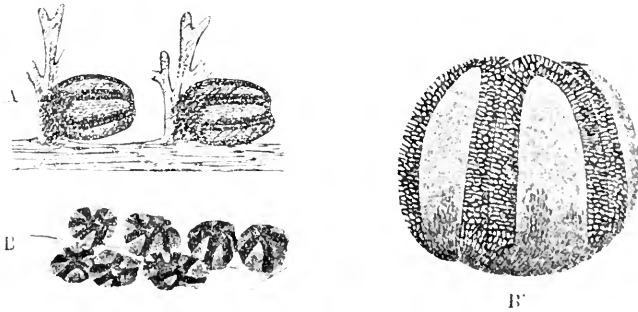

FIG. 273.

A = *Corynepteris Essenghi*, Andrae (*sp.*), from the Westphalian. Fragment of a fertile pinna. $\times 6$. B = *Coryn. coralloides*, Gutbier (*sp.*), from the Westphalian. Fragment of a fertile pinna. $\times 4$. B' = sorus of the same species seen laterally. $\times 28$. (After Zeiller.)

simple origin of the leaf-trace from it. In both these characters the Botryopterideae compare with the simpler, strobiloid Pteridophyta, rather than with the more advanced Ferns. The sporangia are clearly of the Eusporangiate type, as evidenced by their massive stalk, relatively thick wall, broad non-specialised annulus, and the large spore-output. But their arrangement has not usually been recognised as being in definite sori: it is possible, however, that the terminal tassels of sporangia may have had some degree of regularity of orientation, such as is certainly suggested by Fig. 272-3. A slightly closer grouping of them together, coupled with a definite orientation such as that seen in *Corynepteris*, leads naturally to the type of sorus prevalent among the Marattiaceae. These Ferns diverge, however, very widely from the Botryopterideae in their mature anatomy. It will be seen later that on this point interesting comparisons may be drawn between the Botryopterideae and the Osmundaceae and Hymenophyllaceae, which are held to be relatively primitive groups, while they occur very early in the geological record.

¹ *L.c.*, p. 291.

CHAPTER XXXIII

MARATTIACEAE.

THIS family is represented by five genera of living homosporous Ferns, viz. *Angiopteris*, *Archangiopteris*, *Marattia*, *Danaea*, and *Kaulfussia*. The characters of all the five genera are now well known, so that they form a sound basis for comparison with the fossils. A number of these, dating back to the Palaeozoic period, show strong similarity to the modern forms, both as regards anatomy and the characters of the sorus. Their existence indicates that the Marattiaceous type has been a very ancient one. The natural course will be first to consider the living Marattiaceae: we shall then proceed to compare with them their fossil correlatives.

EXTERNAL CHARACTERS.

The erect stock in *Angiopteris*, *Marattia*, and *Archangiopteris* is relatively short, massive, and unbranched: it is of the radial type, and is entirely covered by the persistent bases of the crowded leaves (Fig. 274). It continues directly the radial symmetry initiated in the embryo, which is probably a primitive condition. Some species of *Danaea* have also an erect radial shoot (e.g. *D. simplicifolia*): others show at first an erect position and radial construction, but it passes over gradually to an oblique position, with distichous arrangement of the leaves (*D. alata*, Fig. 275). *Kaulfussia*, on the other hand, is strongly dorsiventral, its rhizome showing distinct internodes, and being horizontal, while the leaves alternate obliquely on its upper surface (Fig. 276). It seems a natural interpretation of the facts to hold that in the last named Ferns the primitive radial and erect type of the shoot has been relinquished in favour of the derivative creeping habit, which goes along with its diminished bulk and greater elongation: in fact, the case is similar to that seen in the Ophioglossaceae, where also in *Helminthostachys* the primitive shoot with its massive stock has given way to a more elongated but creeping rhizome. (See Chapter XVI.)

The leaves are produced in the usual acropetal order, and show great diversity of outline, though conforming to a common type. The leaf-base in all cases bears stipular enlargements laterally, which are connected across the adaxial face of the petiole by a transverse commissure (Fig. 276). Though these are characteristic for all the Marattiaceae when mature, they are absent from the first, and often from the second leaf of the seedling. They remain persistent after the upper leaf decays, in close relation to the smooth scar which marks its attachment.

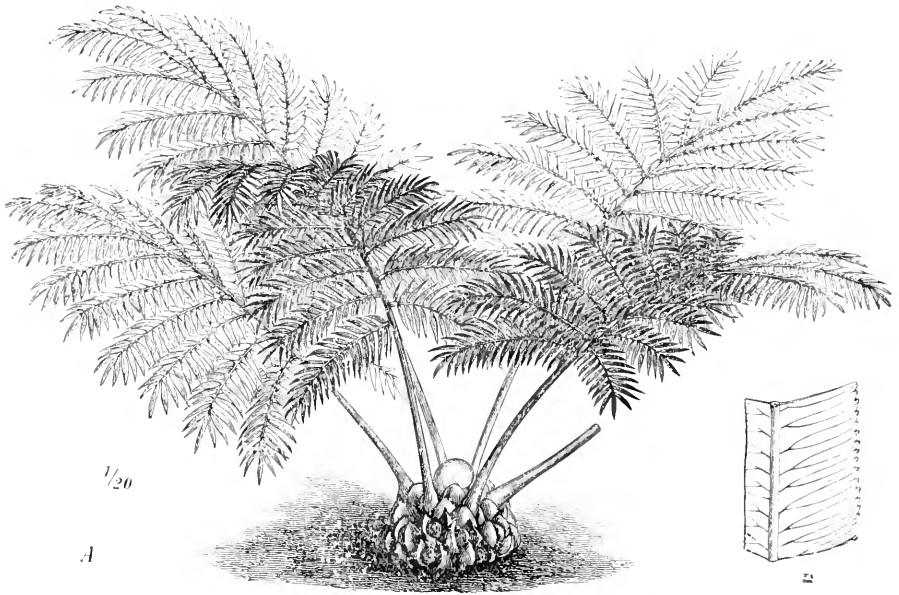

FIG. 274.

Angiopteris Teysmanniana, de Vriese. A = habit of a small plant, reduced to one-twentieth; B = part of a pinna, natural size. (From Bitter, in Engler and Prantl, *Nat. Pflanzenfam.*)

The upper leaf of the living genera varies considerably. The base of the leaf-stalk, and often the bases of the pinnae also, bear fleshy swellings or pulvini: here the stalk breaks on decay, leaving a clean scar, as above noted. The texture of the leaf is usually leathery, but *Danaea trichomanoides* shows a thin and almost filmy character of the foliage, in obvious adaptation to its moist habitat. The leaf may be simply ovate, with marked midrib and acuminate apex, as in *D. simplicifolia* (Fig. 277): or it may be simply pinnate, as in *D. alata* (Fig. 275), or *Archangiopteris*: or the pinnation may be repeated, as in *Angiopteris* (Fig. 274), or *Marattia*. In large plants the leaf may in the latter attain a high complexity of branching, while its length may be as much as fifteen feet. In *Kaulfussia* the outline of the leaf differs from all the rest:

the long petiole bears five palmately disposed lobes, of broadly lanceolate form, with a general similarity of outline to the leaf of the Horse Chestnut (Fig. 278, D). The venation, which is simple in other genera, of the Neuropterid, Pecopterid, or Taeniopterid types, is more complex in *Kaulfussia*, approaching that of the *Drynaria*-type.

The roots originate internally close beneath the growing point of the stem (Fig. 279): in simple cases there may be one root to each leaf,

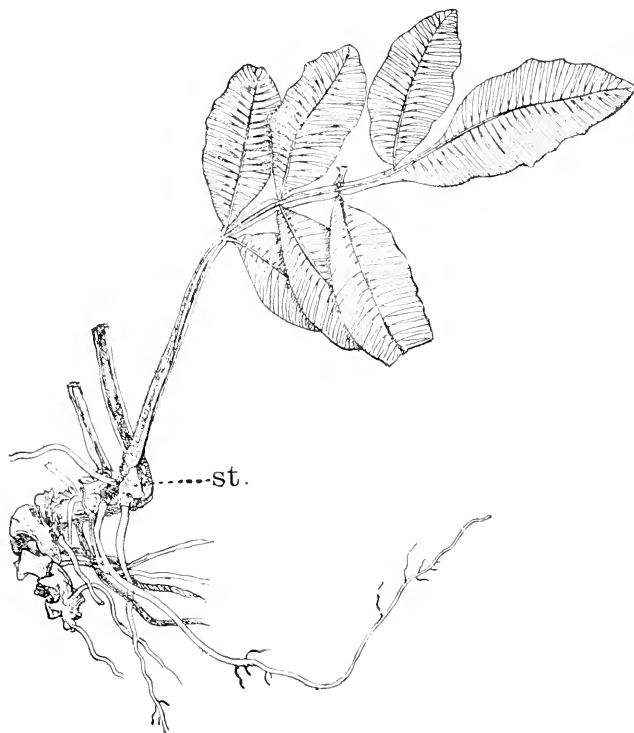

FIG. 275.

A small plant of *Danica alata*. $\frac{1}{2}$. st = stipules. (After Campbell.)

but in strong plants the roots are more numerous. They take a course obliquely downwards through the tissue of the stock, finally issuing as robust roots which branch monopodially.

Among Palaeozoic fossils radially constructed stems of greater length, but showing strong analogies with the stems of modern Marattiaceae, have long been known under the name of *Caulopteris*, when the external surface is seen in the form of impressions; or of *Psaronius* when the internal structure is preserved. Among other points of similarity which they show, the roots may be found traversing the cortex of these stems

in the same way as in *Marattia* or *Angiopteris*. Their reference to a Marattiaceous affinity has been further confirmed by the proof of their

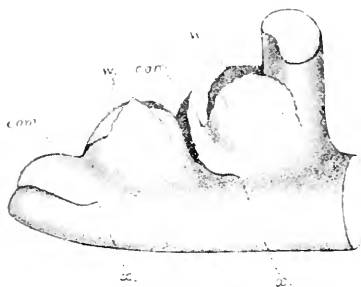

FIG. 276.

Diagrammatic representation of the end of a rhizome of *Kaulfussia*. *w*=wings of stipule; *com*=transverse commissure. (After Gwynne-Vaughan.)

relations with Pecopterid foliage, bearing characteristic fructifications.¹ Such stems were not only of arborescent stature, but also of considerable thickness. The leaves were in some cases distichous (*Megaphyton*), in others tetrastichous, in others again spiral on a more complex plan: the latter correspond more nearly to the leaf-arrangement seen in the living genera. The general character of such stems is suggested by Fig. 280. The conclusion seems clear that certain Fern-like plants, of Marattiaceous affinity, but of more aborescent habit than the living Marattiaceae, existed in Palaeozoic times, a conclusion which is borne out by the study of the leaves and fructifications.

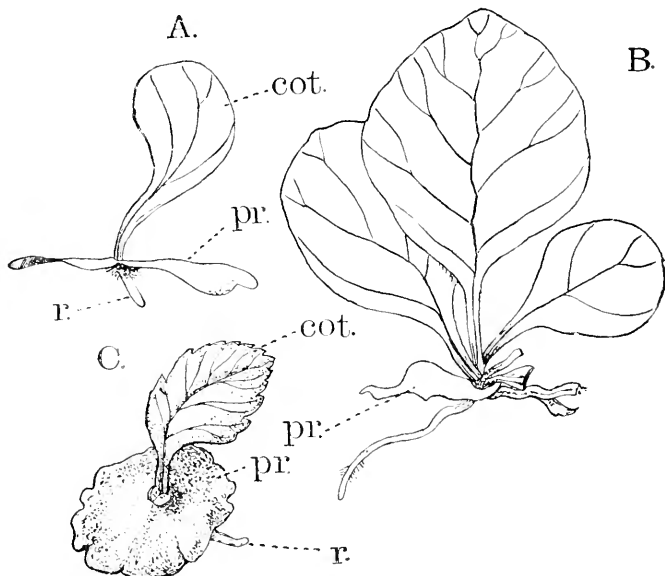

FIG. 277.

A, young sporophyte of *Danaea simplicifolia* still attached to the gametophyte. *pr.* $\times 5$. *B*, an older sporophyte of the same species. *C*, gametophyte of *Angiopteris erecta* with young sporophyte. (*A*, *B*, after Brebnér; *C*, after Farmer, from Campbell's *Mosses and Ferns*.)

The latter in the modern genera are always intra-marginal, on the lower surface of the leaf: the sori are distinct, seated each upon a vein.

¹Zeiller, *Elements*, p. 420.

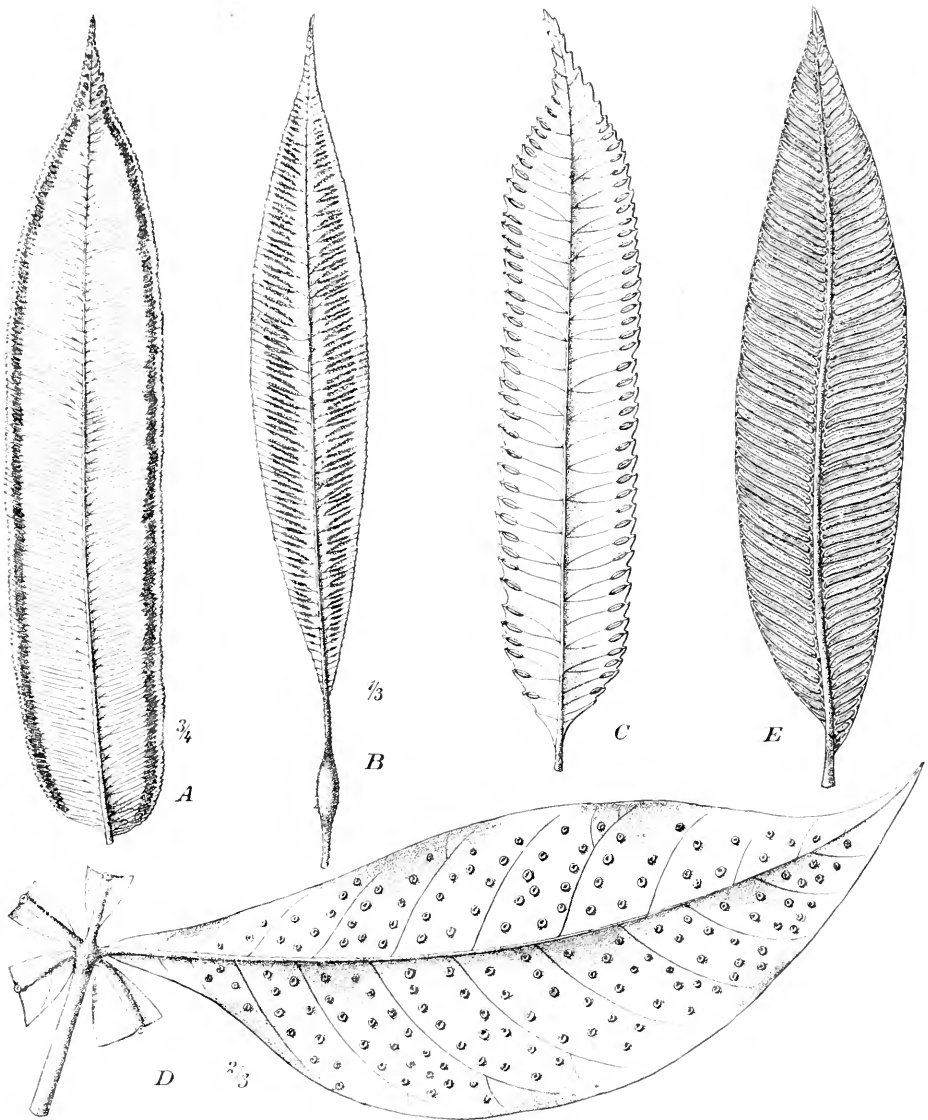

FIG. 276.

Pinnae of the five genera of the Marattiaceae, all of them lateral pinnae. *A* = *Angiopteris crassipes*, Wall.; *B* = *Archangiopteris Henryi*, Christ and Gieslen; *C* = *Marattia traximae*, Sm.; *D* = *Danaea assulifolia*, Bl.; *E* = *Danaea elliptica*, Sm. *A*, *C*, *D*, *E* after Bitter; *B* after Christ and Gieslenhagen. (From Engler and Prantl, *Nat. Pflanzenfam.*)

In all of them, except in *Kaulfussia*, and occasionally in *Danaea*, they are disposed in a single series on either side of the midrib: they may be short and compact, and be seated near to the margin, as in *Marattia*

and *Angiopteris* (Fig. 278 A and C): or they may be more extended along the veins, as in *Archangiopteris* (Fig. 278 B): or they may occupy the whole space from margin to midrib, as in *Danaea* (Fig. 278 E). But in all these cases the disposition of the sorus is essentially the same, and the differences those of detail only. In *Kaulfussia*, however, the sori are dotted over the broad under-surface without apparent order, a condition



FIG. 279a.

Vertical longitudinal section of the stem of a young plant of *Angiopteris erecta*. *b* = the youngest leaves still quite covered up by the stipules, *nb*; *st* = stalk of an unfolded leaf with its stipula, *nb*; *u*, everywhere the leaf-scars on the basal portions *f*, *f*, from which the leaf-stalks have separated; *c*, *c*, the commissures of the stipules in longitudinal section; *w*, *w*, the roots. Natural size. (After Sachs, from Goebel's *Outlines*.)

which appears widely different from the rest (Fig. 278 D): but comparison of leaves of *Danaea*, and especially of those which are only partially fertile, gives the clue to an explanation: for there the normally elongated sori are found to show occasional fissions, and the partial sori, with circular outline like those of *Kaulfussia*, appear isolated upon the enlarged leaf surface (Fig. 281 *a*, *b*, *c*). It seems probable that the condition of *Kaulfussia* was acquired during descent in some such way as this, on the gradually broadening leaf. The frequent occurrence of sori showing similar

fissions in *Kaulfussia* supports this view (Fig. 281 *a-c*, lower series). Thus the apparently aberrant genus may be brought into line with the rest. It will be seen later that this spreading of the sori over an enlarged leaf-surface has its parallels among the Leptosporangiate Ferns also.

The normal arrangement with one row of sori on either side of the midrib corresponds to what is frequently seen in the fossils which are referred to this affinity: as examples *Asterotheca*, *Scolecopteris*, and *Ptychocarpus* may be quoted (Fig. 282, also Fig. 288 A). In all of these, though the pinnules are small, the arrangement of the sori is on the same plan. But among the Fern-like plants of the Palaeozoic age many other arrangements occur which appear to have no near correlative among living Ferns.

The examples here chosen from among the fossils are those in which there is at present no reason to doubt the homosporous Fern-character. It is possible that some of them may ultimately be shown to be Seed-

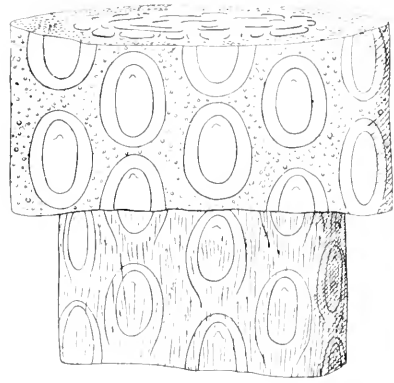

FIG. 280.

Diagrammatic view of a trunk of a Fern from the Coal, showing above the external cortex with petiolar scars (*Caulopteris*), and below the woody cylinder with scars corresponding to the foliar strands, and their sclerotic sheaths (*Ptychopteris*). Reduced to $\frac{1}{2}$ natural size. (After Zeiller).

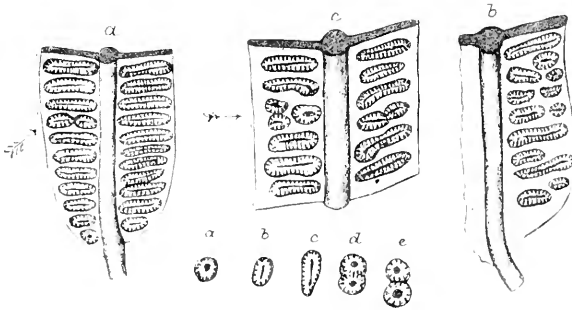

FIG. 281.

a, b, c (above), *Danaca data*, Smith. *a* = a fertile pinna with many normal sori: the arrow indicates an abnormal fission; *b, c*, show more numerous abnormal fissions, resulting in irregularly formed sori, distributed over a slightly enlarged leaf-surface. *a, c, d, e* (below), sori of *Kaulfussia aesculifolia*, Blume, showing states of partial or complete abstriction.

Plants, and the sori to represent groups of pollen-sacs. But even if they were, the structural similarities would remain, and they would then only strengthen the opinion that the Pteridosperms had an ultimate origin in a Fern-like ancestry.

SPORE-PRODUCING MEMBERS.

The sorus of the modern Marattiaceae is strictly circumscribed, and has no definite indusium: it is true that certain hairs round its periphery in *Angiopteris* have been thus described, but they hardly deserve such recognition (Fig. 283 B, D): also in *Danaea* the tissue of the leaf grows up between and partly envelops the sori where they are in close juxtaposition, and the growth has been called an indusium, but this use of the term is open to question (Fig. 283 κ). The sori are all constructed on a plan which may be described as radiate, and uniseriate, for a single series of sporangia are disposed in a radiate fashion round a central attachment.

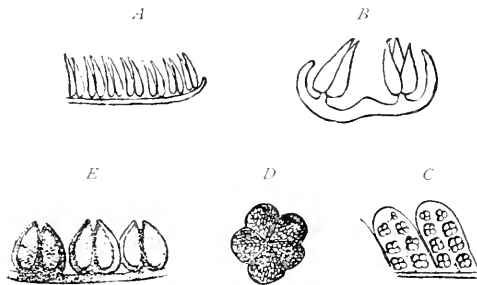

FIG. 282.

A, B, Scolecopteris elegans, Zenker, from the lower Permian. *A*—transverse section of a fertile pinnule enlarged (after Zenker). *B*—*Scolecopteris polymorpha*, Brongn, from the Stephanian, longitudinal section of a fertile pinnule enlarged (after Grand' Eury). *C, D, E, Asterothecca*. *C*—*Asterothecca Miltoni*, Astis, from the Westphalian: fertile pinnules. $\times 2$. *D*—synangium of *Asterothecca*. \times about 6. *E*—longitudinal section of a pinnule of *Asterothecca*, traversing three synangia, enlarged. (After Grand' Eury, from Zeiller's *Palaeobotanique*.)

sporangium: there may be differences of the opening mechanism, but the plan of dehiscence is the same in them all.

The structure of the mature sori of the five genera is illustrated in Fig. 283. Figs. A and E represent the sori of *Angiopteris* and *Marattia*: the plan of them is clearly the same, the difference being that in the former the sporangia are separate, in the latter they are fused into a synangium, which is of firm, almost woody texture. Each sporangium in either case opens by a slit on the oblique inner face. The question will be considered later whether the synangial condition or that with separate sporangia is probably the more primitive: meanwhile, as regards the general character of the sorus, these genera may be regarded as central types in the family, while the rest of the genera are probably derivative. Thus an elongation of the sorus of *Angiopteris*, so that it occupies a considerable length of each vein, would give the condition seen in *Archangiopteris* (Fig. 283 c, d). It is probable that this is the correct

point: when elongated, as in *Danaea*, the attachment is linear. All the sporangia of a sorus originate simultaneously, a character which is general for the *Simplices*. The sporangia themselves may be separate, or united into synangia: they are massive, with a broad base of insertion, and each produces a large output of spores. The dehiscence is in all cases by a slit or pore, in a median position at the distal end, or on the oblique inner face of each

view of its origin, since its sporangial structure is closely similar to that of *Angiopteris*, while such elongated sori are absent from the corresponding fossil types. A similar elongation of a synangial sorus of the *Marattia*-type, so as to extend the full length of the vein, would give the condition seen in *Danaca* (Fig. 283 J, K, or better in Fig. 286 A); here also the sporangia are disposed as in *Marattia*, but differing in the minor fact

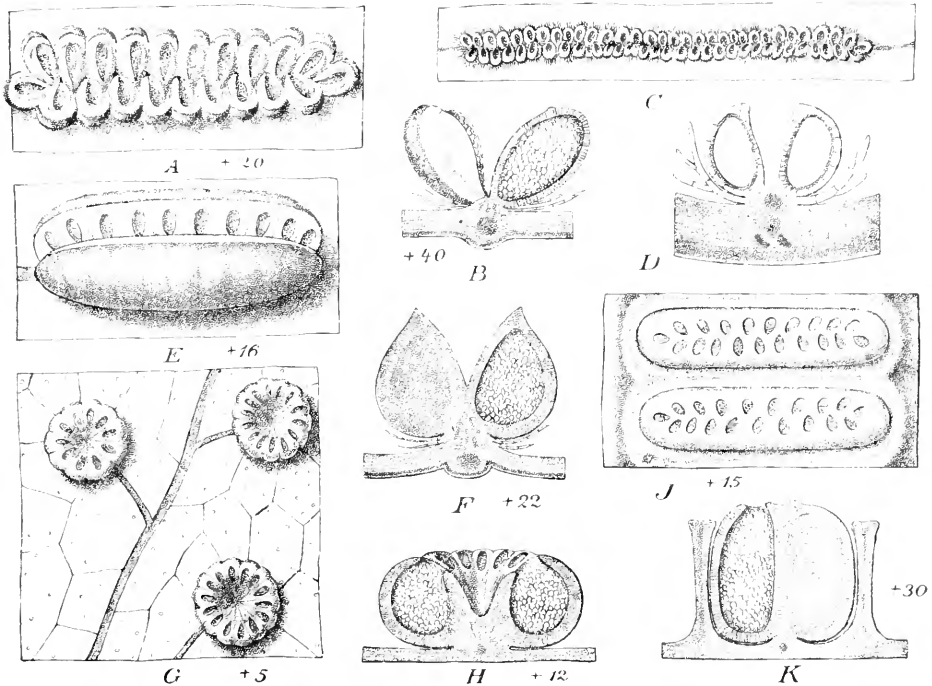

FIG. 283.

Sori and sporangia. *A, B* *Angiopteris crassipes*, Wall. *A*=sorus. *B*=two sporangia, one in surface view from without, the other cut longitudinally. *C, D*=*Archangiopteris Henryi*, Christ et Gieslen. *C*=sorus. *D*=two sporangia in section. *E, F*=*Marattia fraxinea*, Sm. *E*=synangium; *F*=the same in section. *G, H*=*Kaulfussia aesculifolia*, Bl. *G*=part of the lamina seen from below, with three synangia; the numerous small circles on the leaf-surface are stomata. *H*=section through a synangium. *I, K*=*Danaca elliptica*, Sm. *I*=two synangia; *K*=section through a synangium. (*A, B, E, G, J* after Bitter. *C, D* after Christ and Giesenhagen. *F, H, K* after Hooker-Baker. From Engler and Prantl, *Nat. Pflanzenfam.*)

that the valley between the rows of them is almost levelled up, and the sorus thus forms a solid cake. It will be shown shortly that developmental details support the view that such elongation has actually taken place, while the fact is worthy of note that the length of the sorus varies greatly in different species of *Danaca*. And lastly, in *Kaulfussia* the synangial association of the sporangia together in the circular sorus is on the plan of *Marattia* and *Danaca* (Fig. 283 G, H). The origin of the numerous sori by fission from the *Danaca*-type as the lamina expanded has already been

suggested, and structurally the sorus itself offers no difficulty (compare Figs. 283 H and K). It is thus seen that the general type of sorus is constant in the family: the chief differences lie in the mode of association of the sporangia, and in the extent and fission of the sori.

As the development of the individual sporangium has been found to be essentially the same in the several genera, notwithstanding the difference that exists between the synangial state and that where the sporangia are separate, it will suffice to describe it for one only, and *Angiopteris*, with which *Archangiopteris* shows close similarity, may be selected as being the most familiar.¹ At an early stage the sporangia begin to project as separate upgrowths; but it is impossible, from a study of superficial sections, to detect any regular system of segmentation which is maintained in all sporangia; a comparison of the four sporangia, shown in Fig. 284 A in surface view from above, discloses no regular sequence of segmentations, and the cell-groups which will develop into the sporangia appear consequently ill-defined. Of the sporangia *a*, *b*, *c*, *d*, shown, that marked (*b*) is believed to be the most regular and usual type; and the cells shaded in it are evidently sister cells, derived from a single parent cell which, as we shall see, gives rise to the central and essential part of the sporangium; we may call this, as in the other genera, the superficial parent cell. If a section were taken along a line *x—x* through such a sporangium, after it had grown more convex, it would appear as Fig. 284 B, in which the cells shaded are believed to correspond to those shaded in Fig. 284 A. It becomes apparent from such sections as these that a single cell, the central cell, had divided periclinally to form an inner cell and a superficial one: the former is the archesporium, and has in Fig. 284 B already divided into two; the superficial cell has also divided repeatedly. Though we may thus select sections so as to represent a reasonably regular and typical structure of the young sporangium, it is clear, from Fig. 284 A, that what has been described is only a central type, and as a matter of fact hardly any two sporangia show exactly the same details of segmentation. As development proceeds, growth and cell-division often continue with sufficient regularity to allow the genetic grouping of the tissues to be clearly followed (Fig. 284 c). Meanwhile, certain cells at the apex enlarge to form the crest-like annulus. The relation of this to the main lines limiting the product of the superficial parent cell is variable; a common case is that shown in the figure, where the middle line (*x*) coincides with the limit of the annulus; but this is by no means constant: from this point (*x*) downwards, on the central side of the sporangium, the dehiscence will take place. The sporogenous group is now clearly defined by the character of its protoplasmic body, and it forms a definite block of cells, referable to a single parent. Next follows the change of the cells immediately surrounding the sporogenous

¹ Compare "Studies," iii., *Phil. Trans.*, 1897, where more full details are given for this and other genera.

group, to the character of tapetum (Fig. 284 e), and the rule appears to be that the whole tapetum is extra-archesporial in its origin. The figure represents in radial section a sporangium which has arrived at the

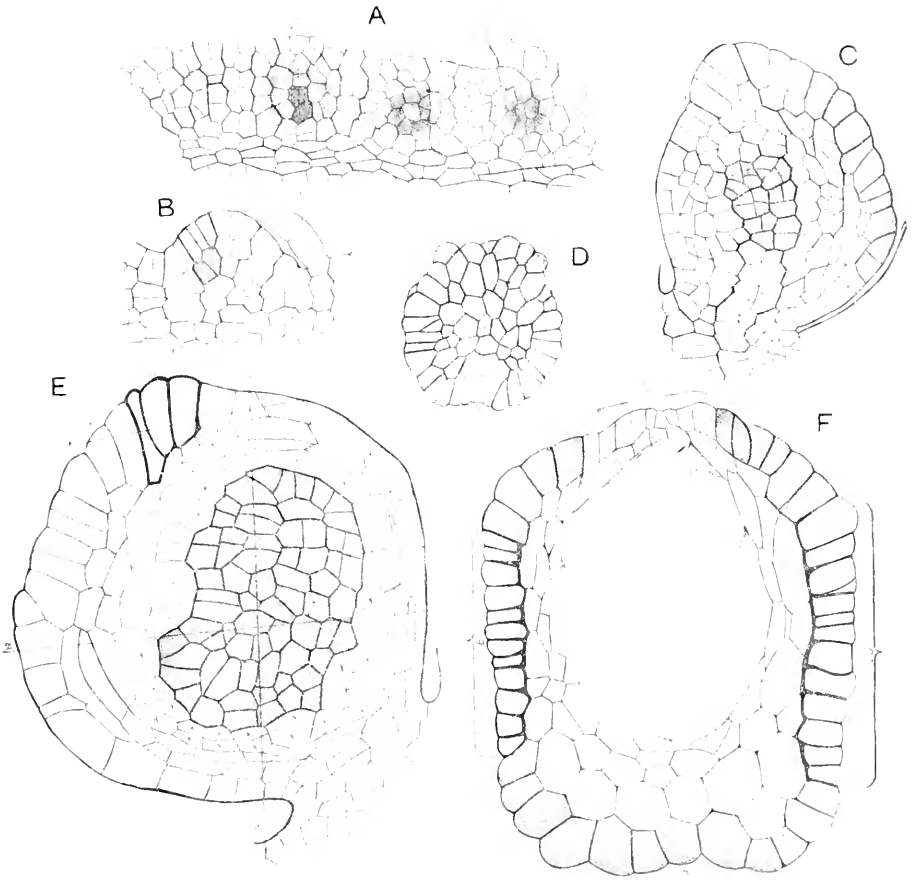

FIG. 284.

Angiopteris erecta. Hoffm. *A* = part of a young sorus seen in surface view from without. *B* = vertical (radial) section of a sporangium such as would be seen on cutting the sporangium (*b*) in Fig. *A* along the line indicated. *C* = vertical section of an older sporangium, showing genetic grouping of cells. *D* = apex of an almost mature sporangium seen from above; such a section as along the line *x, x*, in Fig. *E*. *E* = vertical section of a sporangium with spore-mother-cells; the tapetum is marked *t*. *F* = transverse section of an almost mature sporangium. All $\times 200$.

stage of complete division of the sporogenous mass, and in which the spore-mother-cells are about to separate and round themselves off, prior to the tetrad-division.

From such sporangia it is possible to compute the average number of spore-mother-cells, and for this purpose a number of countings have been made. In radial sections the average of the countings gave 59, say in

round numbers 60, spore-mother-cells traversed. Tangential sections show, on the average, about six such layers of cells to be present, and the average number of spore-mother-cells in each sporangium would thus be $6 \times 60 = 360$, while the average potential output of spores per sporangium would be $360 \times 4 = 1440$ spores. It may be noted that, in the cases observed, all the spore-mother-cells undergo the tetrad-division, and none have been seen to be disorganised, though this, doubtless, may occur occasionally.

Reverting to the tissues outside the sporogenous group, the tapetum is not a strictly defined layer, and is often irregularly doubled by periclinal divisions; but this is by no means always the case. It remains recognisable as distinct, enlarged, glandular cells, often with several nuclei, up to the period of the tetrad-division. The wall of the sporangium outside the tapetum consists of two or more layers, commonly three, of which the outermost is the firmest and most differentiated: the inner layers are less regular, and are composed of more or less tabular cells. I have never seen the tapetum in direct juxtaposition with the superficial layer, as it has been figured and described by Campbell.¹ Of the external wall three essential parts may be recognised, and they will be best seen in Fig. 284 D, which represents the apex of the sporangium, cut off in such a plane as *x*, *x* in Fig. 284 E. The first part (*a*, Fig. 284 E) is found on the peripheral side of the sporangium, and consists of large turgid cells, with moderately thin walls, and granular contents, which stain deeply with Bismarck brown. A second region (*b*) consists of deep prismatic cells with thick lignified walls, which may be recognised as the annulus: it extends as a narrow bridge across the apex of the sporangium (Fig. 284 D), and widens out on either side, as the apex is left, into a broader band of cells with lignified walls (Fig. 284 F). The third region (*c*) consists of thinner-walled cells, of elongated form, which constitute a narrow band running down the anterior (ventral) side of the sporangium. This is the tissue which defines the fissure of dehiscence.

The structure of the sporangial wall being as thus described, we may now consider how it works in connection with dehiscence. The annulus, together with the two broader lateral extensions of it, constitute a firm resistant arch, of which the apex is the narrowest part, being only about three cells wide (Figs. 284 D, E). If the thinner-walled posterior region (*a*) were to contract, as we may presume it does by drying as the sporangium matures, the two sides would be pulled backwards, while the thin bridge of the annulus at the apex would act as a sort of semi-rigid hinge; the line of dehiscence on the ventral face, having been structurally defined, would thus, on fission, be caused to gape widely. It is not probable, however, that this hinge-like action is very considerable, and the gaping of the slit may be mainly due, as in other Marattiaceae, to mere drying up of the cells in the neighbourhood of the rupture.

¹ *Mosses and Ferns*, p. 207, and Fig. 164 c.

At maturity the more or less indurated superficial layer of cells of the sporangial wall is the most conspicuous part, but the thinner-walled cells lying within, though they may shrink, do not entirely disappear.

The essential parts of the sporangium of *Angiopteris*, and especially the archesporium, are thus seen to be referable in typical cases to a single parent cell: this also is the case typically for all the other genera.

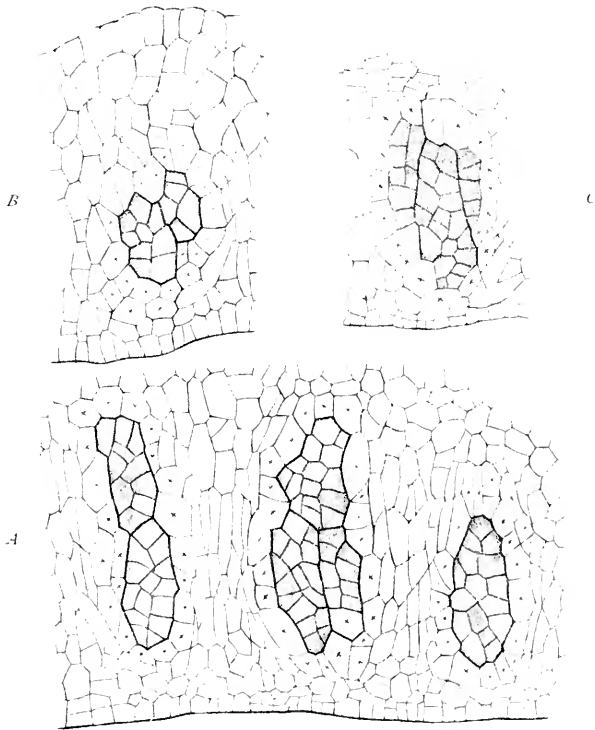

FIG. 285.

Marattia fraxinea, Smith. *A* = section transversely through a sorus; the sporogenous cells shaded, the tapetum marked (*t, a*); the left-hand sporangium is the most usual arrangement of sporogenous tissue, the other two less frequent. *B* and *C* show in similar section irregular groupings not referable to a single parent cell. x 200.

But in *Angiopteris* and *Marattia*, and notably in *Danacea*, this is not always so, and there is much individual divergence of detail. Not only is the segmentation conformable to no strict plan, but the size of the sporogenous groups varies greatly, while in non-typical cases it is not always possible to refer the sporogenous group of one sporangium to a single parent cell (Fig. 285). These irregularities are usually associated with considerable differences in size of the sporangia. In no genus does this irregularity appear more pronounced than in *Danacea*: an almost exact uniformity in size and segmentation of sporangia is so

marked a feature in Ferns at large that these irregularities command the greater attention. Fig. 286 A represents a tangential section traversing three sori in *Danaea elliptica*, of an age prior to the tetrad-division: the varying size of the sporangia is striking, as also their frequent grouping in pairs, separated by a thin, or even by a partial septum. Some of

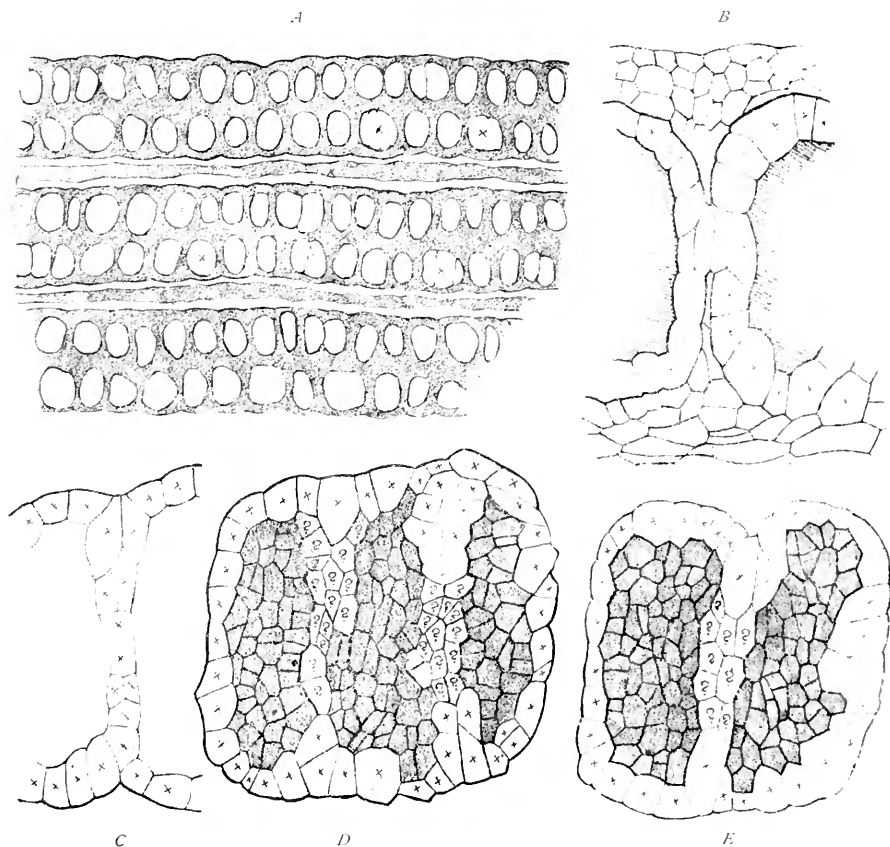

FIG. 286.

Danaea elliptica, Smith. Drawings illustrating partial septations of the sporangium. A, tangential section through three sori, showing the loculi in ground plan; the septa are often thin, so that pairs of loculi are in close juxtaposition; the loculi marked (x) are large, and show one or more partial septa. $\times 20$. B, C, D, E, show such loculi with partial septa in greater detail; in D and E it is difficult to decide whether the cells marked (p) will develop as tapetum or as spore-mother-cells. $\times 150$.

these partially septate sporangia are represented more in detail in Figs. 286 B-E. From these drawings it is clear that the identity of the sporangium is not maintained: that where the initial sporogenous group is large, some of its cells may develop as transitory tapetum, or even as permanent cells of septal tissue: and thus various intermediate steps of completion of a septum may be observed. Somewhat similar conditions

have been noted also in other genera, so that *Danaea* does not stand alone, though the demonstration is most effective in that genus.

In putting a morphological interpretation on these facts it is to be remembered that the genus *Danaea* has in many of its species very long sori compared with those of *Marattia*. External comparison had already suggested an elongation of the type of the latter genus to produce the sorus of *Danaea*. The internal structure is now seen to be conformable to such a progression, for the partial septations are commonly found in those sporangia which are larger than the normal: they thus appear to have followed upon expansion of the sporangia. Their existence

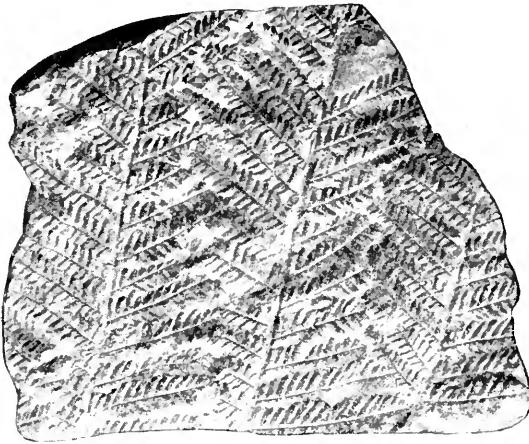

FIG. 287.

Pecopteris (Dactylothea) dentata. Part of a frond with the Matrix. Reduced after a photograph by Mr. W. Hemingway. From Scott's *Studies in Fossil Botany*.

here, as well as occasionally in other genera, raises the question whether or not septation has been effective in the primary production of the sorus: this will be considered again later.

The synangial sori differ from those with separate sporangia in the mechanism which accompanies dehiscence, though the dehiscence itself is uniformly by a radial slit. The annulus represented in *Angiopteris* by a broad indurated band or hoop, is absent: clearly it would be useless in a synangium, for it could not possibly be effective unless the sporangium were free from mutual relations with others. In *Kaulfussia* and *Danaea* the radial slit of each sporangium may widen as the neighbouring cells dry up, to form an almost circular pore. In *Marattia* there is in addition to this a change of form of the whole sorus at maturity: its two sides, originally in close juxtaposition so that the distal ends of their sporangia almost touched, move apart like the opening of a book. In *Danaea* and *Marattia* the whole external wall of the synangium is composed of deep indurated cells: the condition of *Angiopteris* appears accordingly

as a slight modification of this, by localisation of the sclerotic thickening so as to form a hoop-like band, while the remaining walls are thin.

It is thus seen that the sporangia of the living Marattiaceae conform essentially to a single type: but that that type is less definite in its detailed characters than is the case in other Ferns: and this goes along with their larger size, and the high output of spores, which is its natural concomitant. For on computation in round numbers, the sum of the spores potentially present in a sporangium of *Angiopteris* is about 1450: of *Danaea* about 1750: of *Marattia* about 2500: and of *Kaulfussia* about 7850. It is thus seen that the synangial forms have the largest number. This, with various other considerations, will have weight in the discussion whether the state with synangia or that with separate sporangia is probably the more primitive.

Passing now to the fossil Ferns having fructifications which may be ascribed to a Marattiaceous affinity, many of them had foliage of the Pecopterid-type (Fig. 287), though this in itself cannot be held as any clear indication of relationship: it is the soral structure which is distinctive. A few of the best known examples will be described, with a view to their comparison with the fructifications of the living Marattiaceae.

Ptychocarpus unites. Fructification. *A*, part of a fertile pinnule (lower surface), showing numerous synangia. *B*, synangia in side view. (*A* and *B* \times about 6.) (After Grand'Eury.) *C*, a synangium in section parallel to the surface of the leaf, showing seven confluent sporangia. *a*, bundle of receptacle; *b*, its parenchyma; *c*, tapetum; *d*, spores; *e*, *f*, common envelope of synangium. \times about 60. (After Renault.) From Scott's *Studies in Fossil Botany*.

One of the most striking is *Ptychocarpus (Pecopteris) unites*:¹ here, on the lower surface of the pinnules of a Pecopterid leaf, the sori are disposed on either side of the midrib: each is a solid synangium, composed of about seven sporangia united upon a common receptacle. Each synangium is attached by a short and narrow pedicel, so that it may be removed bodily, and the synangia are frequently found lying free. The form is that of a truncated cone, with a slight terminal dimple. The sporangia

¹ Renault, *Bassin Houiller d'Autun*, ii., p. 9.

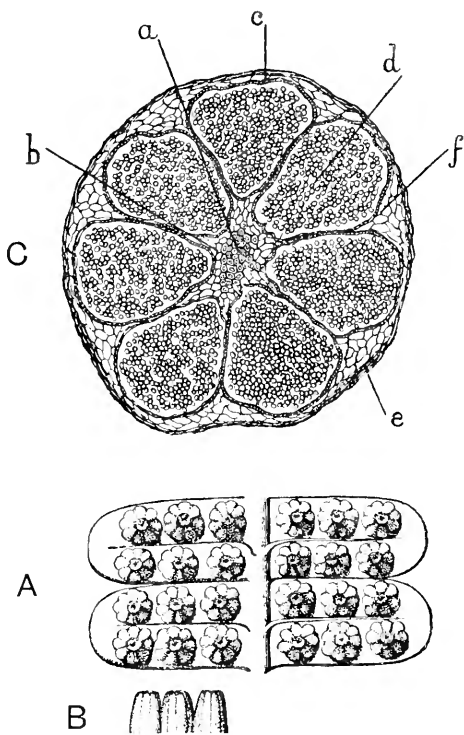

FIG. 288

are surrounded by a rather delicate common wall, about four layers of cells in thickness, of uniform structure, and without trace of any annulus. Centrally there is a vascular strand connected with the system of the leaf. The dehiscence appears to have been by terminal pores. The number of spores in a single sporangium was very large: to judge from Renault's detailed drawings it was probably equal to the output of the modern *Kaulfussia* (Fig. 288). It is evident that the correspondence with this genus was very close indeed: the plan of the sorus is the same: its form also, for the terminal depression in *Kaulfussia* is often less marked than is represented in the drawings usually quoted. The two are alike also in the thin parenchymatous tissue of the sporangial wall: in the absence of any indurated annulus, and in the presence of a vascular connection, which I have shown to extend in *Kaulfussia* also, upwards into the receptacle:¹ though it is not so long or so coherent a strand in the living Fern as in the fossil. The differences are of degree only, and the similarities are most convincing.²

Another genus which conforms in type of its fructification to modern Marattiaceae is *Scoleopteris*. This genus includes plants with sessile or shortly pedunculate sori, of three to six sporangia: they are united below, but separate above, and extended into a more or less elongated beak (Fig. 289 D). The Marattiaceous characters of this fructification are unmistakable, and it has been pointed out by Strasburger³ that *Scoleopteris elegans*, Zenk, shows features connecting it with *Marattia* as regards the form of the sporangia, and with *Kaulfussia* in their circular disposition in the sorus, while the outline of their upper free portion would point to *Angiopteris*: in dehiscence it compares with all three, but especially with *Marattia*. In fact it is a type which unites in itself characters of various living genera. It may be noted that the number of sporangia in the sorus of *Scoleopteris* is small and variable, but that four and five seem to be the most frequent numbers.

A genus of very early occurrence, and bearing sori of similar character is *Asterotheca*: here the three to eight sporangia are in close apposition while young almost up to the apex, but they separate and diverge radially when mature: the peripheral wall is strongly convex, and shows no annulus: the mode of dehiscence was by radial slits (Fig. 289 F).

¹ *Studies*, iii., Fig. 42, p. 46.

² Mr. D. M. S. Watson (*Journ. R. Micr. Soc.*, 1900, p. 1) has described a "Fern" synangium from the Lower Coal Measures, well preserved, but detached from the part which bore it. It resembles *Ptychocarpus unitus* in its synangial state, but differs in its more elongated form, its hollowed apex, and in the vascular supply being widened into a cup of tracheids: in these latter characters it resembles *Kaulfussia*. There is no evidence to show whether it was truly Filicéan or Cycadofilicéan. It is named *Cyathotrachus altus*.

³ *Jenaische Zeitschrift*, 1874, p. 87.

As a further example *Hawlea*¹ may be mentioned, which is also of very early occurrence. Here the sorus is of the circular form, as before:

the sporangia are sessile and elongated-ovoid in form, and radiate outwards from the centre of attachment, so that the slit of dehiscence on the inner side is directed upwards, and the sporangium when open has the form of a boat (Fig. 289 B). Stur describes a rudimentary apical annulus in these sporangia, but it is not clearly shown in his figures. The sorus of *Hawlea* appears most nearly comparable to that of the modern *Angiopteris*, but this comparison would be accepted with greater confidence if the microscopic details were better known by a study of sections.

Lastly, under the name of *Danacites* certain Ferns have been described, which, so far as can be judged from the study of impressions, conform to the *Danacia* type of sorus (Fig. 290). It may be a question whether the relation of the sporangia together, and the mode of their dehiscence were exactly as in the modern *Danacia*, but at least the plants appear to have been Marattiaceous, and to have had elongated sori. They come from the Coal Measures, Keuper, and Lias.

Having regard to the fact that the comparisons above sketched do not relate to one or two, but to several different genera, it appears that there is ample evidence of the early existence of the

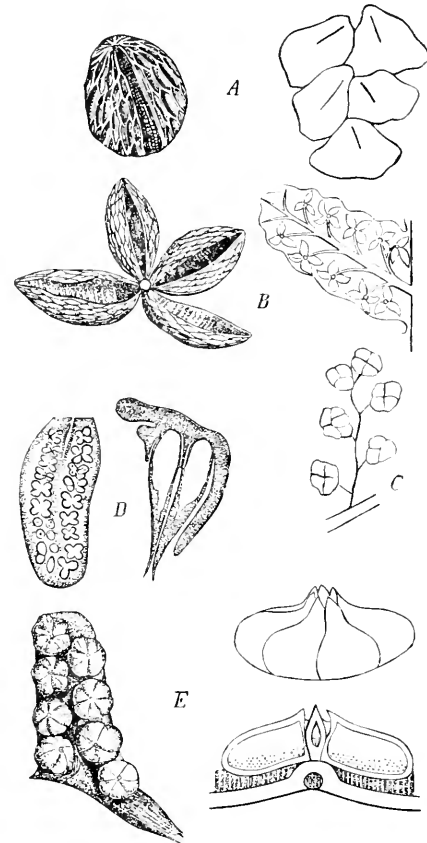

FIG. 289.

Fructifications from the carboniferous formation. *A* = *Senftenbergia ophidermatica*: to the right the position of the sporangia on both sides of the median nerve of the pinnule; to the left a single sporangium, seen from above. *B* = *Hawlea Miltoni*: to the right a pinna with the sori on the extremities of the lateral nerves; to the left a single sorus more highly magnified. *C* = *Oligocarpia lindsaoides*, showing position of the few-membered circular sori on the nerves of the pinnule. *D* = *Scolecopteris polymorpha*, Brongn.: to the left a pinnule showing the position of the sori in transverse section; to the right a longitudinal section of a sorus in which the sporangia are united below into a columnar receptacle. *E* = *Asterotheca sternbergii*: to the left the pinnule with sori; to the right a side view of a sorus, and a sorus in radial section. *D* and *E* diagrammatically represented. (All Figures after Stur. From Solms-Laubach's *Fossil Botany*.)

Marattiaceous type. It would in fact be difficult to find clearer evidence of affinity between a recent and a fossil group of plants, while, as we shall

¹ Mr. Kidston suggests to me that *Asterotheca* is really identical with *Hawlea*, the apparent difference being due to conditions of preservation.

see, the comparison is confirmed by reference to the petrified stems known as *Psaronius*. This consideration will justify our drawing together the modern and the fossil forms into a comparison with a view to tracing probable phyletic changes in the structure of the sorus, and a recognition of an original type.¹ The definitely circumscribed sorus appears to be a characteristic of the Marattiaceae, both ancient and modern. The form of the sorus varied from circular to elongated, both in the fossils and in living forms: there is no distinctive stratigraphical evidence to show which type was the prior, but in the majority of the early fossils the sorus is circular, with a small number of sporangia. Further, the Pecopterid is a relatively narrow-leaved type, while the leaves of *Danaea* and *Kaulfussia* are broad: if a widening of the leaf took place, followed by extension of the sorus, the result would be as in *Danaea* or *Danaeites*: if abstriction of the elongated sori followed also, the result would be as in *Kaulfussia*. The evidence of the

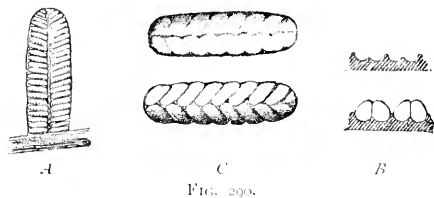

FIG. 290.

Danaeites saarfontanus, Stur. From the upper carboniferous of the Saar district. *A*=a fertile segment of the last order. *B*=transverse section through two adjoining sori, or the hollow impression of them. *C*=below a sorus of sixteen sporangia; above the impression of it. (After Stur. From Engler and Prantl, *Nat. Pflanzenfam.*)

partial septa in *Danaea*, and the irregularity of size and segmentation of the sporangia throughout the family, accords with the suggested extension of an originally circular sorus with few loculi to produce the more or less elongated sori of the living forms with more numerous loculi.

A further point for discussion is the original relation of the sporangia to one another in the sorus. Among both ancient and modern Marattiaceae various gradations may be seen between such as have their sporangia quite separate, and those in which they are synangially united. On this point the palaeontological evidence would be consistent with either view, for neither the synangial nor the polysporangiate state is distinctly the prior in stratigraphical sequence. It becomes thus a question of comparison, rather than of demonstration. As a matter of fact, all Marattiaceous sori are synangia in the first phases of their ontogeny: many of them remain so to maturity. It is only as the individual development proceeds that the sporangia project as individual outgrowths in such a case as that of *Angiopteris*. So far then as individual development bears on the question, it would indicate the synangial state as the more primitive. Reasons have already been shown for holding that a progressive septation accompanies the extension of the sorus in the type of *Danaea*: a similar septation of an enlarging initial spore-sac would produce the type of sorus seen, for instance, in *Ptychocarpus*. Such an origin would consistently carry back to an initial point that process of septation which is seen to be effective in *Danaea*. From the synangial state thus produced the polysporangiate state

¹A more full statement of the arguments is given in *Studies*, iii., p. 67-77.

of *Hazlea* or *Angiopteris* would readily result from individual growth of the sporangia already initiated. This seems more probable than a fusion of sporangia originally separate, of which there is no structural evidence in the synangia themselves.

An indirect argument that the synangium was the primitive type is to be found in comparison of the spore-output. It is much larger from the single sporangium of the synangial types, such as *Kaulfussia* or *Ptychocarpus*, than from the separate sporangia, such as *Angiopteris*. It will be shown below that in the Ferns at large a progressive reduction of spore-output from the single sporangium has accompanied specialisation. If the experience from comparison of other Ferns hold good for the Marattiaceae, then the larger output per sporangium in the synangial types would show them to be the more primitive, while the polysporangiate type with its smaller output would be the more advanced. The question is one incapable of present demonstration, but the comparative and developmental evidence supports the view as stated here.

In conclusion, it is impossible to avoid the comparison of the Marattiaceous sorus with the sporangiophores of other Pteridophytes: the vascular stalk or receptacle, the arrangement of the sporangia upon it, the relations of the sporangia, their radial dehiscence—all find their correlatives elsewhere. The chief differences are in the number of the sori, and their position relative to the parts of the shoot which bear them. But in view of the various positions which the sporangiophores hold in the strobiloid Pteridophyta this cannot be held as invalidating the comparison of them with these primitive sori. It may be that the similarity is a result of parallel development: but if that be so, it would still appear probable that the evolutionary progressions which produced them were of a like kind. It will probably be objected that many of the early Ferns show isolated sporangia of large size, and that this precludes any general application of a primitive soral state for Ferns of the Palaeozoic Period. In reply to this, it may be remarked that the genus *Sphenophyllum* illustrates how a "monangial" condition may probably arise from an originally soral state. The sporangiophores with four or more sporangia are seen in *Cheirostrobus* and in *S. majus*: and smaller numbers in other species lead to the solitary sporangium of *S. Dawsoni* (see p. 425). A reduction of like nature is seen in the sori of Gleicheniaceae, and may probably explain also the solitary sporangia of the Schizaeaceae, as indicated by Prantl. *Senftenbergia* is itself an early example (Fig. 289 A). These early forms must be given full consideration in elucidating the Fossils: they indicate the probability that in early Pteridophytes a monangial state may have been derived from a polysporangiate sorus or sporangiophore.

ANATOMY.

The vascular system of the shoot in certain of the Marattiaceae is well known to be among the most complicated of all the Pteridophytes.

It will be unnecessary to describe it in detail here: our object will be rather to bring it into relation with the less complex systems of other Ferns, and with the cognate fossils. This is most readily done by reference to the seedling-structure, and to those genera which are less complicated in their mature state: for there is considerable variety of complexity in the different living genera of the family. It is found that *Kaulfussia* and *Archangiopteris* are relatively simple, while *Angiopteris* is the most complicated of all, *Marattia* and *Danaea* taking a middle position.

In the seedlings of them all the axis is traversed by a monostele: in *Danaea simplicifolia* it has a solid xylem-core, which is maintained till several leaf-traces have been given off from it, naturally without any leaf-gap:¹ it then becomes crescentic, and expands into a dictyostele with leaf-gaps, while a central strand or commissure arises from the concavity of the dictyostele, and pursues an upward course with occasional fusions at the successive leaf-gaps.² The same type of structure is closely followed in the mature stem of *Archangiopteris*,³ though on a simpler scale; in fact, this stem still retains at maturity a stage rapidly passed through by the young plants of other more complex genera. A similar vascular system, consisting of a cylindrical dictyostele, with normally a single central strand, is found also in the mature axis of *Kaulfussia*: but it is dorsal-ventral, and rather more elongated between the leaf-gaps, in accordance with its creeping habit.⁴ In *Angiopteris* and *Marattia* the final structure is more complex, though the initial steps are similar. There is in their seedlings also a solid protostele: in the central part of its xylem-core certain cell-rows cease to differentiate as tracheides, but give rise to a parenchymatous pith: the siphonostele thus formed becomes broken up by leaf-gaps, thus giving rise to a dictyostelic cylinder⁵ (Fig. 291). Subsequently, as the stem passes to maturity, there arise

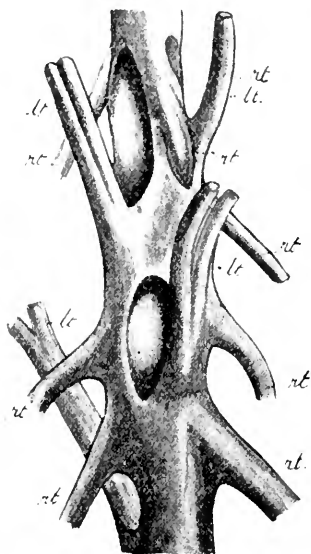

FIG. 291.

Angiopteris caudata. Stele of a young plant showing the foliar gaps, *lt*=leaf-trace, *rt*=root-trace. (After Farmer and Hill.)

¹ But Jeffrey (*Phil. Trans.*, 1892, B, vol. cxcv., p. 120, etc.) states that in several species of *Danaea* the stele is tubular in the seedling, and that it is interrupted by leaf-gaps. That may be so in older conditions, and Jeffrey's material does not appear to have been young enough to decide the question for the earliest stages.

² Brebner, *Ann. of Bot.*, xvi., p. 524.

³ Gwynne-Vaughan, *Ann. of Bot.*, xix., p. 250.

⁴ Kühn, *Flora*, 1889, p. 475.

⁵ Farmer and Hill, *Ann. of Bot.*, xvi., p. 371.

within the cylinder of *Angiopteris* three or four crescentic-meshed zones of vascular tissue, and it has been stated that there is here again a single central strand.¹ *Marattia* resembles *Angiopteris*, but does not obtain so high complexity.

As regards the attachment of the appendages, the vascular supply to the mature leaves originates as many distinct strands from the dictyostele: this is obvious enough in the simpler cases, but it appears to hold also for the more complex: here the leaf-trace is stated to spring from the outermost zone only. The roots, on the other hand, originate even in the simpler forms, in close relation to the central strand, while in the more complex they mostly spring from various points in the internal system, but some also from the outer zone.

It is thus seen that the ontogeny opens in all cases with a monostelic state, with a solid xylem-core. This gives a basis for comparison with other types of Fern, where the monostele is permanent. It is in the later phases of the individual life that the complications arise, and it will be recognised that these vary in rough proportion to the size and complexity of the whole shoot, and are most complex in the large plants of *Angiopteris*.

Comparing the structure of the fossil Marattiaceous stems with that of the living genera there are marked differences, though the points of similarity suffice to indicate a true relationship. The casts show on their smooth leaf-scars that the leaf-trace was habitually a continuous vascular band (Fig. 280), while that of all the modern Marattiaceae is composed of numerous independent strands: the latter are, however, disposed in series, of which the outermost corresponds in outline to one of those continuous bands, as though it had been broken up. This greater coherence of the vascular tracts is characteristic also of the stem of *Psaronius*: for the centre of these fossils is occupied by numerous broad band-like plates, disposed in concentric series, which show differences in relation to the phyllotaxis. These series of vascular plates are doubtless the correlatives of the meshed zones seen in the mature stems of *Angiopteris*, the former being disintegrated in the modern Ferns, in conformity with the disintegrated leaf-traces with which they are connected.²

¹ Mettenius, *Abhandl. Königl. Sachs. Ges. d. Wiss.*, vi.; Miss Shove, *Ann. of Bot.*, xiv., p. 497.

² It is interesting to compare this disintegration of vascular strands seen in the modern Marattiaceae while the related fossils show connected vascular lands, with the analogous cases seen in other Ferns. It will be shown below that most of the Simplicies have a single vascular band of the leaf-trace, while the larger Gradatae have a leaf-trace composed of many smaller strands. A parallel is also seen in the Ophioglossaceae: it has been shown that in *Euphioglossum*, which is held to be the more primitive section of the genus, the leaf-trace is a single broad strand: in *Ophioderma*, which is held to comprise derivative forms, the leaf-trace consists of several distinct strands. It seems probable that a progressive disintegration of a primitively simple leaf-trace has been a wide-spread phenomenon in the evolution of large-leaved types.

The cortex which surrounds the central region in the fossil stems was traversed by large numbers of downward-growing roots, having characteristic Marattiaceous structure: the cortex with its contained roots was often distended to great bulk, while outside it a mass of densely woven roots is sometimes seen. It seems probable that these specimens represent the basal region of arborescent stems, which, though greater in stature than the living forms, were Marattiaceous in their characters. Not only is this so as regards general structure, but also in the details of the tissues, into which, however, it is impossible to enter fully here:¹ the recognition of their affinity with the modern Marattiaceae is thus further confirmed.

EMBRYOLOGY.

The embryology of the Marattiaceae shows features distinct from that of other Ferns. The prothallus is of the normal flattened Fern-type, though of larger size and more massive construction. The sexual organs are borne on its under side, and are deeply sunk in its tissue, not projecting from its surface, as in the Leptosporangiates.

The first segmentation of the zygote is by a basal wall transverse to the axis of the archegonium, whereas in most Ferns it is nearly coincident with it (*b, b*, Fig. 292 A). The basal wall is followed by segmentation into octants, and the relation of the parts of the embryo to these is essentially similar to what is seen in other Ferns: the epibasal hemisphere, here turned away from the archegonial neck, forms the cotyledon and the apex of the stem: the hypobasal hemisphere contributes the root and foot (Fig. 292 A). But here the segmentation proceeds further before the several parts are defined than is the case in the Leptosporangiate Ferns (Figs. 292 B), and especially the foot is not clearly limited at first, nor does it develop later to any considerable size. The cotyledon and the axis grow directly upwards, surrounded by prothallial tissue forming a calyptra, which projects upon the upper surface of the prothallus: this is finally ruptured, and the cotyledon emerges upwards. Meanwhile the root developing from the hypobasal half emerges downwards, and the prothallus is thus transfixed by the young sporophyte (Fig. 277).

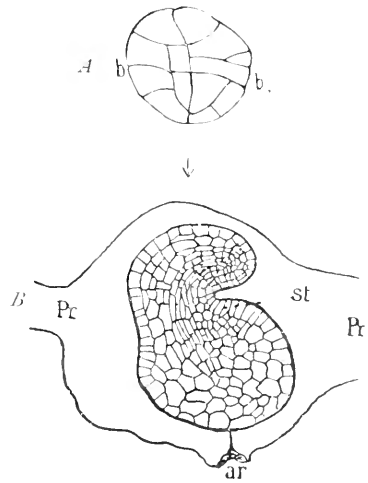

FIG. 292.

Marattia Douglasii. A = longitudinal section of a young embryo. $\times 225$. *b, b* = the basal wall; the arrow points to the neck of the archegonium. B = a similar section of an older embryo, showing its position in the prothallus. *st* = stem; *pr* = prothallus; *ar* = neck of archegonium. $\times 75$. (After Campbell.)

¹ Rudolph. *Paronion und Marattiaceen*, Wien, 1905.

The late definition of the parts of the embryo is in accord with the indefiniteness of the apical segmentation of these Ferns. There are some though inconstant signs of a single initial cell in the apex of root and stem of the embryo; but the apices of the mature parts of the Marattiaceae, whether axis, leaf, or root, show as a rule a more complex structure, three or more commonly four initial cells being recognised. This arrangement of the meristems is in accord also with the Eusporangiate character of these Ferns. Many years ago¹ I showed that a parallelism exists in the Filicales between their sporangial origin and the meristems of all the vegetative parts; that in the Leptosporangiate Ferns, where the whole sporangium originates from a single parent cell, the apical meristems of stem, leaf, and root are referable also to the segmentation of a single initial cell; but that in the Eusporangiate Marattiaceae the apical meristems are more complex, with no single initial. With this goes also the deeply sunk character of the sexual organs on the prothallus. Thus the general conclusion must be that in all its parts the Marattiaceous type differs from the Leptosporangiate type in its greater robustness of construction.

The account given in the preceding pages includes facts which show good reason for holding to the early existence of plants of a Marattiaceous type. Not only does this follow from the detailed comparison of Pecopterid-sori with those of the living Marattiaceae, but also from the structure of the *Psaronius*-stems. From evidence of comparative structure and association it appears certain that the *Psaronius*-stems bore the foliage of *Pecopteris* of the same nature as the leaves on which various syngangic fructifications have been found. Thus we have to do with a group of Palaeozoic fossil-plants showing affinity with the Marattiaceae alike in their anatomical structure and in their reproductive organs. But certain fructifications previously classed as Marattiaceous have lately been shown to be the pollen-apparatus of Spermophytes, e.g. *Crossotheca* and *Pecopteris* (*Dicksonites*) *Pluckenetii*. Considering the anatomical evidence, however, it seems impossible to doubt that Palaeozoic Marattiaceae actually existed, for the *Psaronius*-type of stem is altogether Fern-like in structure, and presents none of those anatomical features by which the Cycadofilices were recognised long before the evidence of fructification led to the foundation of the class Pteridospermeae. For the present, therefore, we must continue to accept the existence of a certain number of Marattiaceous Ferns, especially in the later Carboniferous and Permian periods, though we may not always be able to distinguish their fructifications from the pollen-bearing organs of Fern-like Seed-Plants. It seems not improbable that Marattiaceae and Pteridospermeae may have owed their syngangic fructifications to some common descent from a primitive group of Filicales in which that character had already appeared.²

¹ *Ann. of Bot.*, 1889, vol. iii., p. 395.

² This paragraph is taken almost verbally from Scott, "Present position of Palaeozoic Botany," *Progressus Rei Botanicae*, 1907, pp. 187-189.

The shoot of the Marattiaceae, as a whole, being of a usual Fern-type, it will be considered in relation to the theory of the strobilus at the conclusion of the Filicales. Meanwhile a comparison of the characters of the known representatives, modern and fossil, may be made, and this not only of the mature structure, but also of the details seen in the seedlings of the living forms. Such a comparison gives some foundation for an opinion as to the nature of the stock from which the family may have sprung. In the first place it had an upright, radially constructed shoot, as indicated by the fact that no dorsiventral fossil stem of this affinity has been described, while those which exist among the living genera are probably derivative: moreover the embryos are all upright, and radially constructed. Presumably it had a protostelic structure of the axis, as indicated by the simple anatomy of the young seedlings of the living genera. From this protostele sprang the leaf-traces, at first without leaf-gaps, as is still seen in some living seedlings: the formation of leaf-gaps probably followed early as the stele dilated and became medullated. Each leaf-trace itself was a single strand, as is seen in the fossils even in the mature shoot, but only in the seedlings of the living genera: this would suggest some simple form of leaf in the ultimate parentage. The arrangement of the leaves was on a radial plan, but was probably simpler than in the living forms: this is indicated by the occurrence of early fossils with regular orthostichies of leaves. The root-system was endogenous, and after traversing the cortex with a more or less lengthy course, the roots emerged at the surface, forming sometimes a supporting external felt. The arrangement of the sori on the leaf was on the plan of a simple row on either side of the midrib, and the form of the sorus circular. The relation of the sporangia was probably synangial, and their number in each sorus small, or liable to be reduced to a solitary one. The individual sporangia were large, the spore-output numerous, and the mechanism of dehiscence simple, or altogether absent.

These characters, which comparison would indicate as those of the Marattiaceous ancestry, show convergence in many points of form and structure towards the apparently distinct series of the Botryopterideae. As regards the reproductive organs also, it is to be remembered that certain Ferns referred to a nearer relation with the Botryopterideae have a more or less pronounced grouping of the sporangia into sori: this is suggested in *Zygopteris* itself (Fig. 272), and it is a marked feature in *Corynopteris* (Fig. 273). Thus the two families are not absolutely distinct even in this respect. It is probable that they represent divergent branches from some common primitive stock.¹

¹As regards relation to Pteridosperms, see Kidston, *Phil. Trans.*, 1906.

CHAPTER XXXIV.

OSMUNDACEAE.

THE Osmundaceae are represented by the living genera *Osmunda* and *Todea*, while certain species of the latter are sometimes separated under the generic name of *Leptopteris*. The number of species is ten. The order is of wide geographical distribution, but outside the limits of the ice-cap of the glacial period. The plants are all perennial, with an upright, but usually short stock, which bifurcates occasionally. The axis is covered by the persistent and winged bases of the leaves, which are disposed upon it in a dense spiral. The attachment to the soil is maintained by numerous stout and darkly-coloured roots, which originate in close relation to the leaf-bases. The leaves expanded in the current year form together a shuttlecock-shaped group, the outermost of which are often sterile, and the inner fertile: but some of the leaves never attain full development, their lamina being abortive: these lie at the outside of the winter bud, and their basal region, which remains persistent, acts as a scale-like protection to those within. The leaves show the usual circinate vernation, and are covered while young by mucilage-secreting hairs, which take the place oframenta. These hairs fall off as the leaf expands, leaving a smooth surface. The leaves themselves are singly or doubly pinnate. In *Todea* there is no marked difference between the fertile and the sterile regions, but in *Osmunda* the sporangia are localised on various parts of the leaf, which then show a considerably smaller expansion of surface (Fig. 293). There is a difference of texture of the leaves which has given the basis for the recognition of the third genus, *Leptopteris*: while *Osmunda* and *Todea barbara* have leaves of a leathery character, those species from Australasia and the South Sea Islands which are grouped under *Leptopteris* show a more or less thin and pellucid structure of the pinnules, an approach to the "filmy" character seen in the Hymenophyllaceae. It is, however, a question whether this difference deserves generic recognition. It is probably a relatively direct and recent adaptation to life under conditions of excessive moisture. The leaves of Ferns are typically winged structures throughout

their length:¹ in the upper regions this is more obvious than in the lower, where modifications of reduction and of special development are seen.

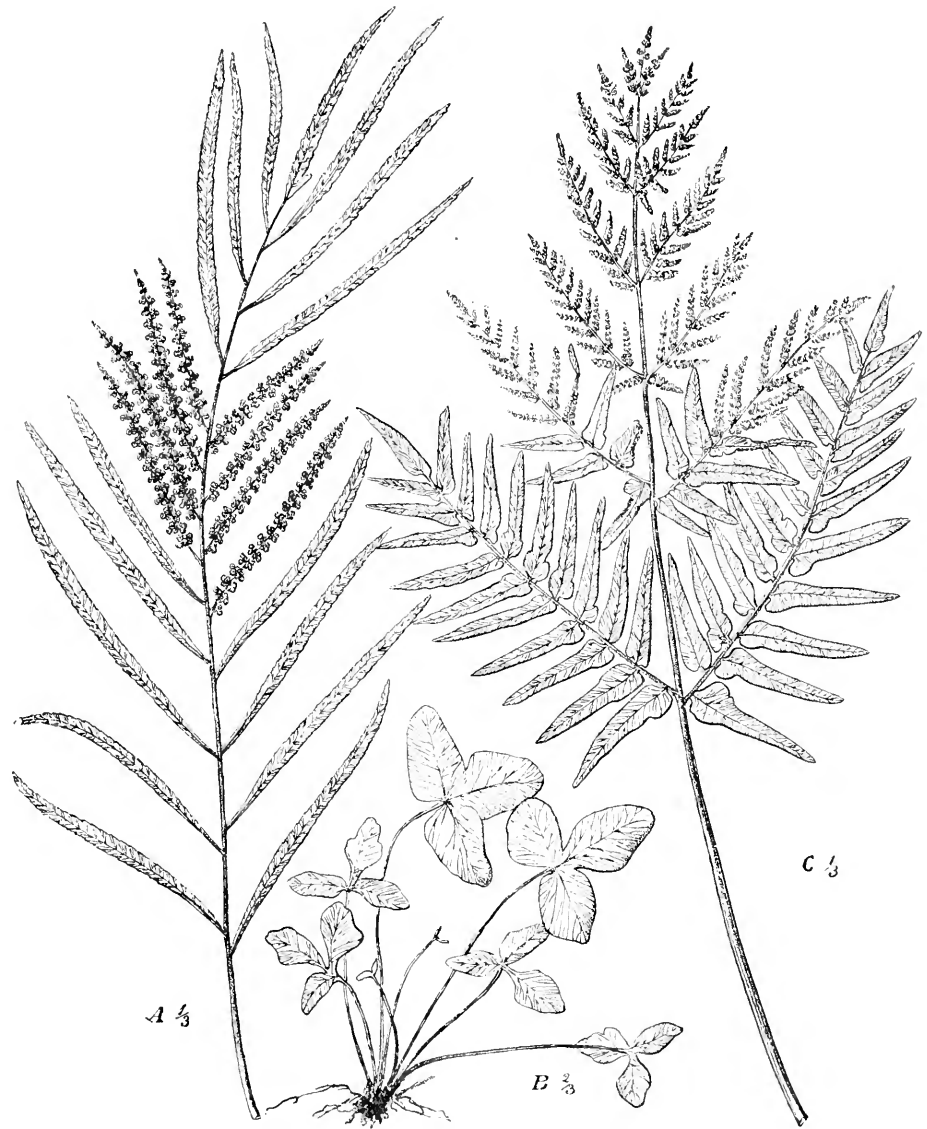

FIG. 293.

A = leaf of *Osmunda Presliana*, J. Sm. B = young plant of *Osmunda regalis*, L. C = leaf of mature plant of *Osmunda regalis*. (From Engler and Prantl, *Nat. Pflanzenfam.*)

In the Osmundaceae this results in the formation of the broad protective leaf-base. In *Osmunda* the wings are traceable as continuous down to the

¹ See *Phil. Trans.*, 1884, p. 573.

flattened expansion: and developmentally it is found that this arises by transverse growth of the superficial tissues, especially at the wings themselves. The result in *Osmunda* is a mere flattened leaf-base: but in *Todea superba* the development extends also as a transverse commissure across the adaxial face of the leaf-stalk. This development, so exceptional in Ferns, may be compared with the stipular development in the Marattiaceae, which is also extended as a commissure across the leaf-stalk. The two cases, though differing in detail, appear alike in morphological nature.

The sporangia of *Todea* are borne only on the under surface of the leaves, but in *Osmunda* they are inserted indifferently on both sides of the much-contracted part, so that at maturity it appears to be completely covered by them. There is no protective indusium. The sporangia themselves are relatively large, of pear-like form, and thick-stalked. They consist at maturity of a single layer of cells forming the wall, but with a few tabular cells within: a group of polygonal, thick-walled cells in a lateral position, but nearer the distal end, is recognised as the annulus: it is related to the slit of dehiscence so that the latter passes from the centre of the annulus, over the distal end, and approaches the stalk on the opposite side of the sporangium (Fig. 294). The line of dehiscence, defined structurally by narrow thin-walled cells, gapes widely at ripeness: this arrangement requires elbow-room, which the lax arrangement of the sporangia readily allows. Those sporangia which are in near proximity to one another originate simultaneously: there is no

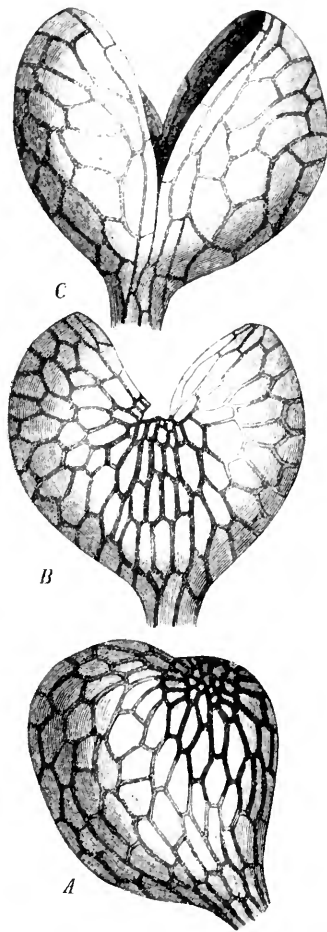

FIG. 294.

Todea barbara, Moore. Sporangium. *A*, in side view, closed. *B* seen from behind. *C* from in front, in both cases after dehiscence: the annulus is darkly shaded. $\times 80$. (After Imerssen.)

interpolation, nor any marked sequence of their origin. Nor is there any regularity in their orientation: in *Osmunda* the sporangia face in the most various directions: and even in *Todea*, where their arrangement has some reference to the nerves of the leaf, the sporangia upon a single nerve show no common rule of orientation. These Ferns are thus non-soral.

Fructifications with unmistakable Osmundaceous characters have been traced back to the Jurassic period. Several species, referred by Raciborski even to the genera *Osmunda* and *Todea*, have been found, bearing sporangia having the characteristic distribution, form, and structure. But, as Raciborski remarks,¹ they are there so highly differentiated that their origin probably dates back earlier still. I have myself pointed out that certain sporangia even from the Coal period show a detailed correspondence of section with those of *Todea*.² Without wishing to urge this similarity too far, such comparisons of the propagative organs suggest an early origin of the Osmundaceous stock, which is fully borne out by the existence of stems, with structure, having characters both external and internal comparable with those of the Osmundaceae. Such are the stems described from external characters as *Chelepteris* by von Eichwald (*Lethaea Rossica*), from the Permian: while these lead towards *Grammatopteris*, a form referred to a Botryopterid affinity. These all share with the modern Osmundaceae the general characters of an upright radial stock, with closely disposed leaves, the bases of which persist. It will be shown below that the anatomical details support the recognition of these stems as a probable phyletic sequence.

SPORE-PRODUCING MEMBERS.

The development of the sporangium in the Osmundaceae differs from that of most Ferns in the variety of its details in different individual sporangia, even when they may be in close juxtaposition on the pinnule. The sporangia fluctuate between two types, as shown by the details both in *Osmunda* and in *Todea*: these are illustrated by Figs. 295, which were drawn from actual sporangia of *Todea barbara*, and are not diagrams. They represent extreme types, the one with segmentation resulting in a square-based archesporium as seen in the Eusporangiates: the other showing the conical type characteristic of Leptosporangiate Ferns: the latter is the commoner in the Osmundaceae.

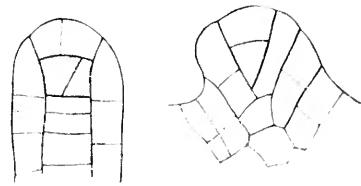

FIG. 295.

Young sporangia of *Todea barbara* in longitudinal section, showing different modes of segmentation. $\times 365$.

The differences of individual detail start from the very first, as is seen from Fig. 296 A, in which two sporangia are shown already projecting as convex outgrowths, but the segmentation is not uniform: it is further

¹ *Englers Jahrb.*, vol. xiii., p. 7. For further data see also Seward and Ford, *Linn. Trans.*, vol. vi., p. 250, etc.

² *Annals of Botany*, vol. v., 1891, p. 109. Renault has also described as *Todeopsis primæva* a fern sporangium from the Culm of Sanost, having Osmundaceous characters, *Gétes Minéraux*, Paris, 1896, p. 21.

to be noted that the cells marked (x) do not compose the whole outgrowth, but that adjoining cells also contribute in a certain degree, so that strictly speaking the whole sporangium is not referable in origin to the single cell. The massive stalk is partly formed from surrounding cells: this is a further feature for comparison with Eusporangiate types. How various the subsequent segmentations may be will be seen from the Figs. 296 A, E; these show that the large cell in the centre of the growing sporangium may be of prismatic or of conical form, while they also prove

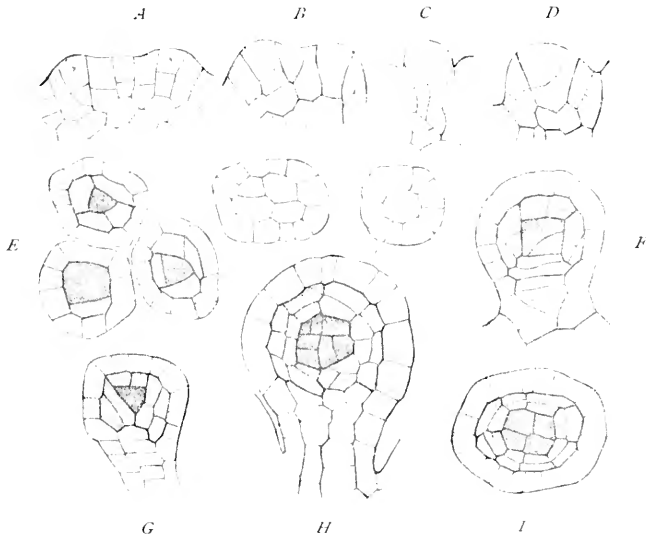

FIG. 296.

Todea barbara, Moore. A=small part of section of pinnule showing two young sporangia (x, x). B, C, D=examples of variety of segmentation, as seen in vertical sections. E=older sporangia in transverse section, showing differences in sporangia in juxtaposition. F=vertical section of sporangium of like age, with square-based sporogenous cell. G=similar sporangium with triangular sporogenous cell. H, I=vertical and transverse sections of older sporangia. The central figures show two unequal sporangial stalks, in transverse section. All $\times 200$.

that adjoining cells take part in the formation of the sporangial outgrowth; a comparison of Figs. 296 C, D, also brings out clearly the very great difference of bulk occasionally seen in sporangia of the same age. The large cell in the centre divides usually by three anticlinal walls corresponding to those seen in the usual Leptosporangiate type, though the cell which remains in the middle may still be either truncate or pointed at the base. But sometimes it appears that four lateral cells may be cut off by anticlinal walls, as in the largest sporangium in Fig. 296 E; thus the central cell after periclinal divisions in *Todea*, may sometimes have the form which is characteristic rather of the Eusporangiate sporangia, though this is exceptional. Then follows the periclinal division to separate the cap-cell from the archesporium: the cell which thus undergoes periclinal division

is believed to be truly comparable to the "central cell" of the Marattiaceous sporangium.

The archesporial cell thus surrounded by the tissue which will form the sporangial wall undergoes segmentation to form the tapetum (Fig. 296 E and F), and the irregularity seen in other segmentations is fully maintained in this also. From a comparison of Figs. 296 F and G it will be seen that sometimes the segmentation of the tapetum is almost according to the ordinary Leptosporangiate type (Fig. 296 G); the most interesting cases are, however, those in which the archesporium is truncate at the base; in these it appears that the cell or cells below it contribute to the completion of the tapetum (Fig. 296 F); this is a point of some special interest, for one of the most constant differences between the Leptosporangiate and Eusporangiate Ferns has been in the origin of the tapetum: but *Todea* occasionally shows an intermediate condition. The division of the tapetum into two or partially three layers follows (Figs. 296 F to I), together with the subdivision to form the sporogenous group; beyond this point it will be unnecessary to trace the development of *Todea barbara*. In conclusion the drawings not lettered in the centre of the group are added, as showing differences of thickness and segmentation of the sporangial stalk; these are both from sporangia, of the age of Fig. 296 H.

An abnormality, which has been observed occasionally in *Todea barbara*, has been found not unfrequently on certain fronds of *Osmunda regalis*, viz. the occurrence of synangia: one of these is represented in Fig. 296 bis: each half shows, except on the side where it is coherent with the other, the ordinary sporangial structure. Such developments are no very surprising consequence of the origin of two sporangia close side by side, with a deeply seated central cell; normally, each develops separately, but the obliteration of the groove between them would give a synangial structure, and clearly this is not a very great modification. But what interpretation is to be put upon such cases, whether they may be counted as retrogressions or the reverse, must for the present be left open.

The more robust and massive origin and structure of the sporangia of the Osmundaceae than of ordinary Leptosporangiate Ferns is to be connected with the greater number of spore-mother-cells produced, and consequently the greater potential output of spores. In *Osmunda* Russow long ago estimated the number of spores in the single sporangium as over 500, and assumes therefore the number of spore-mother-cells to be 128.¹

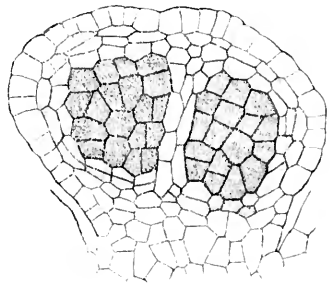

FIG. 296 bis.

Osmunda regalis. A synangium, in vertical section. $\times 200$.

¹ Vergl. *Unters.*, p. 87.

To form an estimate, the number of spores produced in a single sporangium may be actually counted, or an estimate of the potential number may be based upon the number of spore-mother-cells as shown in sections. By the latter method, as applied to *Osmunda regalis*, since the number of spore-mother-cells in a median section is 30 to 32 (Fig. 297), and the sporogenous mass is approximately spherical with the diameter of each cell about $\frac{1}{6}$ th that of the whole sphere, the total number would approximate to 128, though probably somewhat below that number. Actual countings of spores showed figures about midway between 256 and 512, distinctly below the estimate of Russow. In *Todea barbara*, while some sporangia approximate to those of *Osmunda*, others fall far short, and approximate to 256; but in *T. superba* and *lymenophylloides*, which are "filmy" in habit, the output is still lower, approximating in the last species to 128. The bearing of these

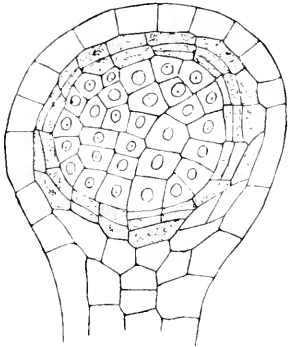

FIG. 297.

Sporangium of *Osmunda regalis*, containing a large sporogenous tissue, surrounded by tapetum consisting in parts of three layers. (After Goebel.)

facts will be discussed below; the results are such as coincide readily with the relatively robust structure and variable details of the sporangial development.¹

ANATOMY.

The vascular structure of the axis in the Osmundaceae has long been an object of interest, on the ground of its distinctness from that of other Ferns, and its apparent analogy with that commonly seen in Dicotyledons. But in the form of the leaf-trace, and the way in which it breaks up as it passes into the leaf, the Osmundaceae present features which are more readily matched among known Filicineous types. Starting from the periphery of the leaf, the numerous forked veins fuse, on passing downwards from pinnule and pinna to leaf-stalk, into a single half-cylindrical strand with its concave channel directed adaxially. This strand consists of a continuous band of metaxylem, with numerous protoxylem-groups at its concave limit, which alternate in position with groups of mucilage-sacs. Peripherally is a mantle of phloem, thicker on the adaxial side, and surrounding the whole is a continuous endodermis. As it passes down to the base of the petiole the strand contracts, and the protoxylems unite into a single one in a median adaxial position, while in transverse section it assumes a deep U-shaped outline (Fig. 298 A, B). It is in this neighbourhood that the vascular supply to the roots is given off laterally from the strand of the leaf-trace (Fig. 298 A III.). The strand thus contracted, after entering the axis, takes its place in a ring of similar traces surrounding a

¹For a more full statement see *Studies*, iv., pp. 38-42.

central pith: as it does so its endodermis opens, and becomes continuous with that which completely surrounds the stelar system (Fig. 298 *A, B, C*). The latter, as seen in transverse section, is composed of several layers of parenchyma at the periphery: then follows a band of phloem which is continuous, but may be uneven in width, extending inwards at the medullary rays. Within this are the xylem-strands, which vary greatly in number. *O. claytoniana* may have as many as 40, *O. regalis* about 15 (in Fig. 298 *A* there are 14). *Todea barbara* 8 or less (in Fig. 298 *B* there are 8, in *C* there are only 3), while in *T. superba* the xylem may form an unbroken cylinder. The position of the protoxylem also varies: in *Osmunda* it is nearly on the inner edge of the metaxylem, but in *Todea* the xylem is mesarch, or in *T. hymenophylloides* the strands are almost exarch.

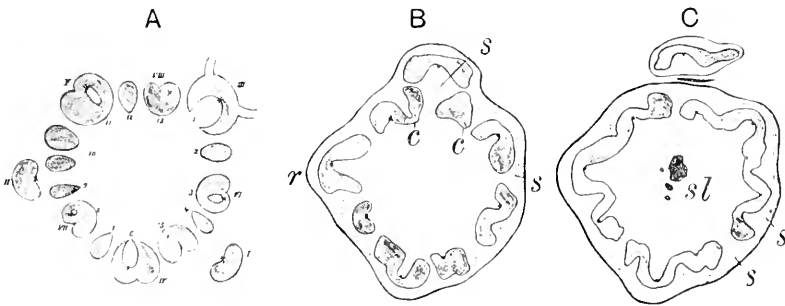

FIG. 298.

A = diagram showing the arrangement of the vascular tissue in the axis of *Osmunda regalis* (after Zenetti). *B* and *C* = transverse sections of the stele of *Todea barbara*, with leaf-trace (after Seward and Ford), showing the greater continuity of the xylem than in *Osmunda*. *s* = phloem. *sl* = sclerotic tissue.

Centrally lies the pith: in some cases an internal endodermis is present (*O. cinnamomea*, *T. hymenophylloides*), while in the former species some internal phloem has been found locally in several specimens examined by Jeffrey¹ and by Faull.²

If the course of the several strands be followed they are found to fuse downwards according to a regular scheme, so that they form a cylindrical network, of which the meshes are very long and narrow: the number and proportions of these vary in different cases, but in all the inter-communication of the whole system is exceedingly close and effective. The scheme is represented for *Osmunda* in Fig. 299 *A*, as flattened into a single plane, and for *Todea*, where the number of the strands is less, in Fig. 299 *B*. A comparison of these diagrams with the figures of transverse section will explain the main features of the system of the axis.

There are two possible views as to the nature of this system of the axis, as seen in the living Osmundaceae: either that it is a result of reduction

¹ *Phil. Trans.*, vol. cxcv., p. 119, etc.

² "Anatomy of the Osmundaceae," *Bot. Gaz.*, 1901, p. 381.

from a more complex condition, or that the system is itself in the upgrade, and an indication, as seen in the living examples, of the approximate limit which development had attained in the group. The former opinion has been elaborated by Jeffrey¹ and by Faull:² they hold the Osmundaceous stele to be a reduced form of "amphiphloic siphonostele," and in support of their opinion they adduce the presence of an internal endodermis (*O. cinnamomea* and *T. hymenophylloides*), and the occasional presence in some specimens of *O. cinnamomea* of internal phloem also, locally in the

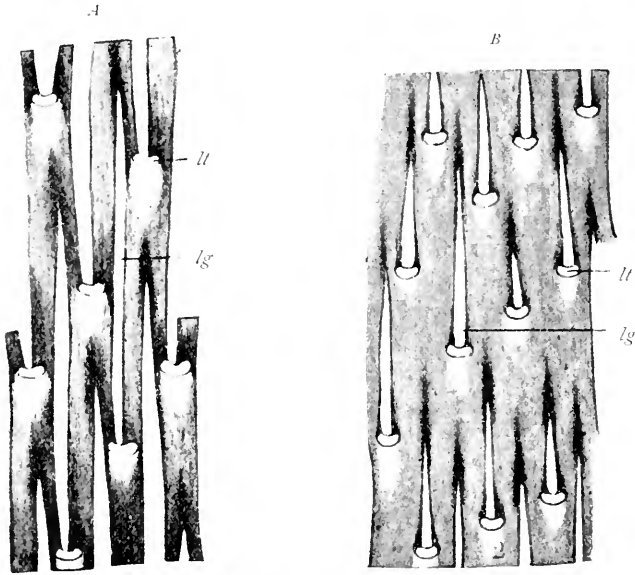

FIG. 299.

A—a representation of a portion of the xylem-ring of *Osmunda regalis* seen from without; *ll*=cut end of a departing leaf-trace; *lg*=leaf-gap. (After Lachmann, from Kidston and Gwynne-Vaughan.) *B*—a representation of a portion of the xylem-ring of *Todaea barbata*, seen from without. Lettering as above. (After Seward and Ford, from Kidston and Gwynne-Vaughan.)

neighbourhood of the branchings of the axis. There are good grounds for doubting whether the local and inconstant occurrence of internal phloem and endodermis will bear the weight of a far-reaching theory of reduction: the question has been argued sufficiently elsewhere,³ on grounds of anatomical comparison of living forms, and without acceptance of the reduction theory. Even on grounds of physiological probability it would appear less likely that a robust and large-leaved phylum of Ferns should show a reduced vascular system in its stock than that the stock should retain a primitive, though perhaps imperfectly efficient system.

Apart, however, from such questions of probability, a good basis for

¹ *Phil. Trans.* vol. cxcv., p. 119, etc.

² "Anatomy of the Osmundaceae," *Bot. Gaz.*, 1901, p. 381.

³ Scott, *New Phytologist*, vol. i., p. 209; Seward, *l.c.*, p. 255; Boodle, *Ann. of Bot.*, 1903, p. 518; Chandler, *Ann. of Bot.*, 1905, p. 406.

an opinion opposed to a theory of reduction is to be found in the ontogeny of the living plants: for in the seedlings there is at first a protostele without internal complications, which expands later, and becomes medullated: but at first the passing out of a leaf-trace does not necessarily interrupt the continuity of the xylem-ring: leaf-gaps are not found till later.¹ Thus the ontogeny suggests a progressive evolution of the complex structure from the protostele.

But still more cogent evidence is derived from the study of the structure seen in the related fossils, examined successively according to their stratigraphical succession. This work has lately been carried out by Kidston and Gwynne-Vaughan, and the demonstration is a very convincing one.² If the present Osmundaceous structure be reduced, the fossil correlatives should show a progressively more complex structure as they are followed to earlier strata, but the reverse is found to be the general trend. Five salient stages of complexity of the stele are involved in the series recognised by Kidston and Gwynne-Vaughan: they are these: (1) the condition with interrupted xylem-ring, and internal endodermis and phloem; (2) an interrupted xylem-ring surrounds pith only; (3) a continuous xylem-ring surrounds the pith: (4) a solid xylem is present, without pith, but heterogeneous in structure (?): (5) a solid homogeneous xylem.

In the modern Osmundaceae the usual condition is (2), but with indications of (1) in *O. cinnamomea*, and less clearly in *T. hymenophylloides*. Among the fossils *Osmundites Dowkeri*, Carr, from the Eocene, shows the condition (2). *Osmundites Skidgatensis*, Penhallow, from the Cretaceous, shows internal phloem, and is in fact the most complex Osmundaceous structure known. If no other fossils were available than this, there would appear to be some support for a reduction theory; but other fossils preclude this conclusion:³ thus *Osmundites Chemnitzensis*, Unger, from the Tertiary Quartz of Hungary, shows the condition (2). From the Jurassic comes *Osmundites Gibbeana*, Kidston and Gwynne-Vaughan, which shows the structure of type (2), but with narrow leaf-gaps: also *Osmundites Dunlopi*, Kidston and Gwynne-Vaughan, with a continuous ring of xylem surrounding a central pith (3). From the Permian of Russia *Chelepteris gracilis*, Eichwald, which shows type (3), with continuous xylem-ring: also *Chelepteris Zalesskii*, Kidston and Gwynne-Vaughan, which appears to conform to type (4), showing a protostelic state, but with the central region of the xylem differentiated from the peripheral. This condition approaches very near to type (5), with solid homogeneous protostele, a state which is seen in *Grammatopteris*, from the Permian of Autun. It has already been remarked above (p. 499) that in general habit and

¹ Seward and Ford, *loc. cit.*, p. 241.

² Kidston and Gwynne-Vaughan, *Trans. Roy. Soc., Edin.*, 1907, vol. xlv., p. 759.

³ An example such as this, leading to a possible conclusion which wider knowledge of the fossils shows to be erroneous, exemplifies one of the many dangers of argument from fossil evidence.

structure certain fossils attributed to the Botryopterideae have pronounced Osmundaceous characters: in view of the sequence of fossils above quoted, it seems probable that the Osmundaceous structure is referable in origin, with upward differentiation of the stele, to some type of the nature of the Botryopterideae (Kidston and Gwynne-Vaughan). It thus appears that a study of the related fossils in their stratigraphical sequence lends no serious support to a theory of reduction of the stele from an "amphiphloic siphonostele": it indicates rather an upward development from a protostelic state. Taken with the comparative considerations already advanced, the evidence against Jeffrey's view appears very strong indeed.

Zenetti¹ had already regarded the stele of *Osmunda* as being in the up-grade of development, and had compared it with the structure seen in certain of the Lycopodiales. With these a very interesting parallel may be drawn, and especially with that series illustrating a progressive elaboration of the stele, and its disruption into separate strands, which Kidston has recently demonstrated by a stratigraphical sequence of fossils as cogent as this in the Osmundaceae (see above, pp. 230, 337). The fact that such parallels have been shown to exist in distinct phyla is in itself a support of the views above indicated.

EMBRYOLOGY.

The primary embryology of the Osmundaceae being on the same plan as that of the Leptosporangiate Ferns as a whole, it need not be described in detail. The Leptosporangiates all differ from the Marattiaceae in the position of the basal wall: in the latter it is transverse to the axis of the archegonium, in the former it is parallel with it: in relation to this the epibasal half, which gives origin to the axis and leaf, is here directed laterally, and the cotyledon originates from its lower quadrant. The consequence is that, as in all the other Leptosporangiates, the cotyledon of the Osmundaceae emerges on the lower side of the prothallus, not from the upper as in the Marattiaceae. Comparing the embryo itself with that of other Leptosporangiate Ferns, it will suffice to remark that in the segmentation there is somewhat less regularity in the later divisions, and that the external differentiation of the members appears later, the embryo retaining longer than in them its spherical form. These are but minor differences: they indicate, however, for the Osmundaceae an intermediate place between the typical Leptosporangiates and the Eusporangiate Ferns.²

A similar intermediate character comes out also from comparison of the meristems of the Osmundaceae with those of the Marattiaceae on the one hand, and of the typical Leptosporangiate Ferns on the other. I have shown at length elsewhere,³ that in respect of the apices of root, stem,

¹ *Bot. Zeit.*, 1895, pp. 72-76.

² For details see Campbell, *Mosses and Ferns*, p. 356.

³ *Quart. Journ. Micr. Sci.*, vol. xxv., 1885, p. 75, etc.; *Phil. Trans.*, 1884, part ii, p. 595; *Ann. of Bot.*, vol. iii., p. 305. This matter will be taken up again later, when the general comparison of Ferns is made, and also in Part iii.

and leaf, and even in the segmentation of the wings of the leaf, the condition of *Osmunda* and *Todea* is less regular and more bulky than is habitual in the Leptosporangiates: and in particular, in the segmentation of some of their roots, where four prismatic initials take the place of the single initial of the Leptosporangiates, there is a near approach to the structure seen in the Marattiaceae: also in the apex of the leaf of *Osmunda* and *Todea* there is a three-sided initial cell, as against the usual two-sided type of the Leptosporangiates. When these facts are put in relation with what has been demonstrated for their sporangia, where there is so strange an oscillation between the Eusporangiate segmentation and that typical of Leptosporangiate Ferns, it becomes clear that the Osmundaceae hold a transitional place as regards their embryonic, and meristematic structure. This harmonises readily with their mature characters, and with their probable early origin as shown by palaeophytological enquiry.

Thus an examination of the Osmundaceae, living and fossil, leads to the recognition of the following characters as probably existent in the stock from which the family sprang. It had an upright, radially constructed shoot, as shown both by the living species and by the related fossils: for though the embryo has the prone position in living forms, this is only a temporary juvenile phase (see pp. 213-215). The axis was protostelic, as indicated by the seedling structure, as well as by that of the earlier fossils: and though the stele tended to be disintegrated in the more recent types there is still no proof that the state of typical dictyostely was ever reached. The absence of leaf-gaps in the early condition of the seedlings, and in the early fossils, as well as the fact that the leaf-trace in all consists of a single strand, indicates an ultimate origin from a stock in which the leaf had not attained the ascendant in the shoot. The young parts were protected by mucilaginous hairs,ramenta being absent. The disposition of the relatively bulky sporangia was non-soral, either uniformly on both sides or margin of the leaf, or on the lower surface: the individual spore-output was relatively large, and the opening mechanism simple. These characters all point towards the Botryopterideae among known early forms, and make it appear probable that the source of the Osmundaceae is to be found in some near relation to that early family of Ferns.

CHAPTER XXXV.

SCHIZAEACEAE.

THIS family includes *Lygodium*, *Schizaea*, *Ancimia*, and *Mohria* of living genera, with about 80 species, of wide distribution, but chiefly within the tropics. The fossil genera *Senftenbergia*, *Klukia*, and perhaps *Kidstonia*, referred to this affinity, indicate that the Schizaeaceous type was of early occurrence. Whereas in the Osmundaceae, and in the Marattiaceae with few exceptions, the radial type of shoot prevails, in the living Schizaeaceae there is a pronounced leaning towards a dorsiventral habit. The radial type of construction appears in *Schizaea*, in *Mohria*, and in most species of *Ancimia*: frequently, however, the stock is not upright in position, but more or less oblique, while in *Ancimia* (§ *Ancimiorrhiza*) the stock is a creeping one. The extreme case is in *Lygodium*, which has a creeping underground rhizome with bifurcate branching, and it bears the leaves inserted in a single row, or it may actually be two nearly coincident distichous rows, upon its upper side. The arrangement of the leaves is, however, in a dense spiral in those cases where the axis is upright or oblique, while in the creeping *Ancimias* it is in two alternating rows. It is probable in this family, as in others, that the dorsiventral is the derivative and the radial the primitive type: but it will be seen that *Lygodium*, which departs most markedly from the radial construction, is in certain other respects relatively primitive.

The leaves show great diversity of detail in the different genera. In *Schizaea* there is a very marked and repeated dichotomy (Fig. 300): the branches may be more or less completely webbed together below, and they bear the fertile segments on their distal ends. In *Lygodium* also the leaf-architecture is traced by Prantl to repeated dichotomy,¹ but complicated by the continued apical growth and sympodial development of the branches: the leaf may attain a length of 100 feet or more. This extraordinary foliar structure acts as a prehensile climber, and the fertile segments are seated on the distal ends of the branched pinnae which it bears at intervals. In *Ancimia* and *Mohria* the leaves are less complex, and the ultimate reference

¹ *Die Schizaeaceen*, Leipzig, 1881.

to a dichotomous branching is not so clear. In the former the lowest pair of pinnae are usually fertile, in the latter genus the sporangia may be distributed over the whole length of the leaf.

Hairs are present in all the genera, and in all except *Mohria* they are filamentous, as in the Botryopterideae, Marattiaceae, and Osmundaceae,

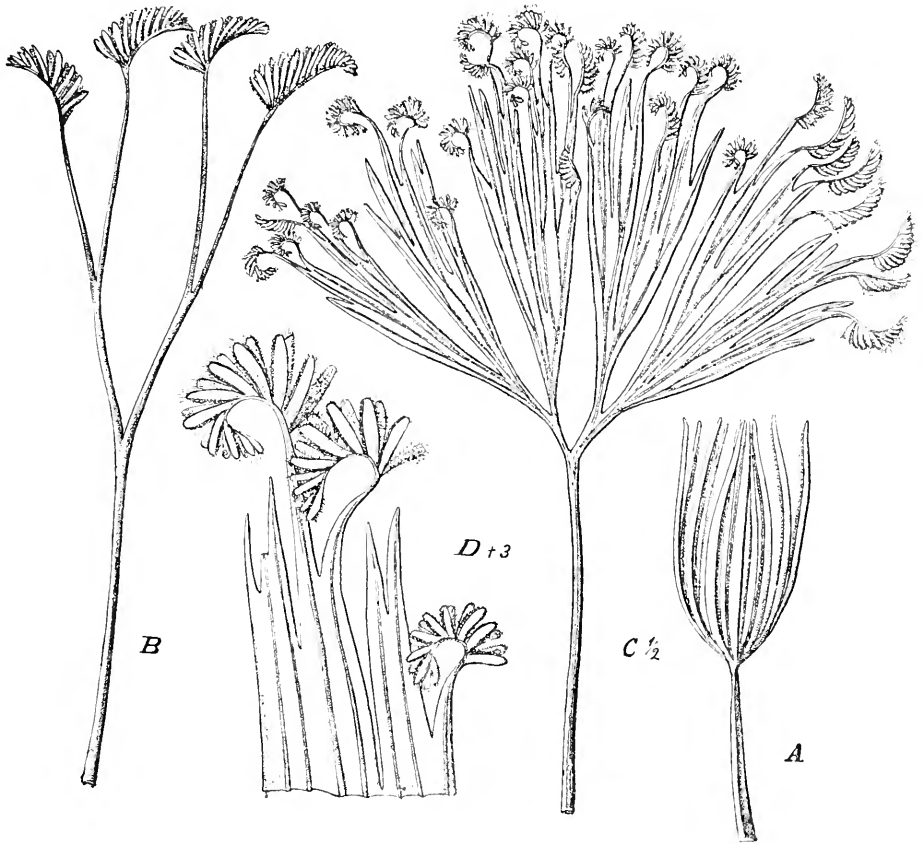

FIG. 306

Upper parts of fertile leaves of the genus *Schizaea*. A=*Sch. pennina*, Sw. B=*S. l. bifida*, Sw. C, D=*Sch. elegans*, J. Sm. In D the ultimate segments are more strongly magnified. (After Diels, from Engler and Prantl, *Nat. Pflanzenfam.*)

and are sometimes glandular. In *Mohria* they are no longer filamentous, but flattened as scales: this condition, which is characteristic of most Ferns of a more advanced type, is readily referable in origin to lateral widening accompanied by longitudinal cell-divisions.

The sporangia are not arranged in sori, but solitary, a number of them being borne on each fertile segment. In *Schizaea* and *Ancinmia* they appear when mature disposed in regular rows, one on each side of the midrib, on the lower surface of the fertile segments. They may be protected

by curling over of the margin of the pinnule, as in *Mohria* and *Schizaea*, and in some degree in *Ancimia*: or there may be a special protective growth, comparable to the indusium of the Hymenophyllaceae, which completely covers each separate sporangium, as in *Lygodium* (Fig. 301).

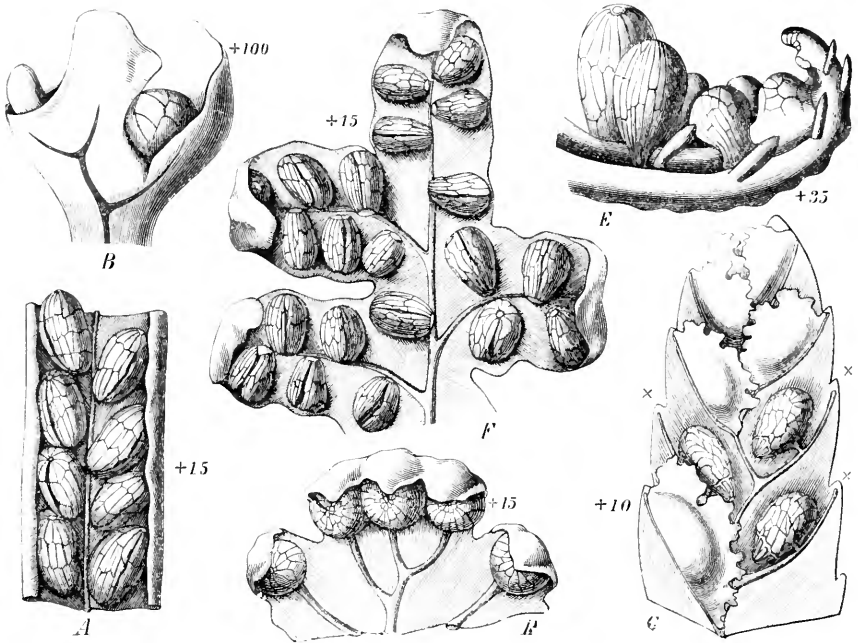

FIG. 301.

Disposition of the sporangia of the Schizaeaceae. *A* = *Sch. dichotoma*, J. Sm., part of a fertile segment (soriophore). *B*, *C* = *Lygodium japonicum*, Sw. *B* = apex of a young fertile segment, at (\dagger) the sheaths have been removed, so as to display the sporangia. *D* = *Mohria caffrorum* (L.) Desv., segment of a fertile pinna. *E*, *F* = *Ancimia Phyllitidis*, Sw. *E* = side view of a young fertile segment. *F* = fertile segment from below (*A*, *B*, *E* after Prantl. *C*, *D*, *F* after Diels, from Engler and Prantl, *Nat. Pflanzenfam.*).

SPORE PRODUCING MEMBERS.

These in the Schizaeaceae are simply the solitary sporangia, each of which Prantl recognised as constituting a "monangial sorus." He accurately worked out their development, and found them to arise in acropetal order on each fertile segment: he ascribes to them all an origin from cells of the marginal series, with a terminal position on the fertile vein. Consequently the protecting flanges must, according to his account, be accessory growths from the adaxial surface of the leaf. As Diels remarks, however, extended and renewed investigations are desirable before this is finally accepted.¹ It seems improbable for *Schizaea*, and still more so for certain of the related fossils: from their mature position in these it would appear

¹ *Nat. Pflanzenfam.*, i., iv., p. 360.

more likely that the sporangia are originally of surface origin. Nor does it appear unlikely that there should be inconstancy in this respect within the family, when it is remembered that the sporangia may be either marginal or superficial in the Osmundaceae.

The sporangia are large and sessile, or in *Lygodium* shortly stalked, and are annulate. The annulus in the living forms is usually uniseriate,

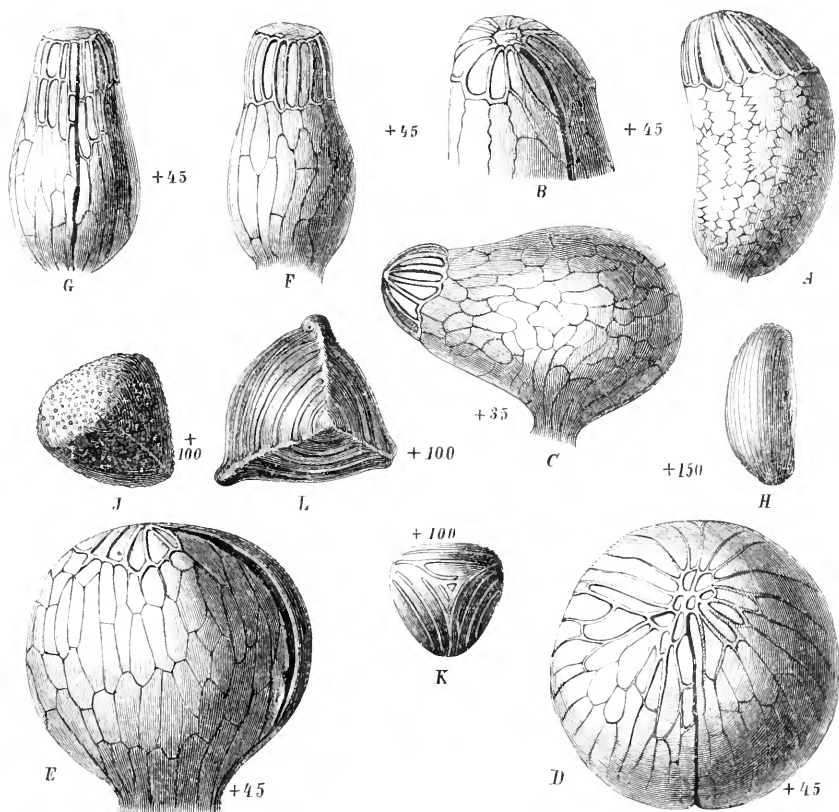

FIG. 302.

Sporangia of the Schizaeaceae. *A, B* = *Schizaea pennula*, Sw. *A* seen laterally. *B* the tip seen obliquely from above. *C* = *Lygodium japonicum*, Sw., seen laterally. *D, E* = *Mohria caffrorum* (L.) Desv. *D* = seen from above. *E*, laterally. *F, G* = *Ancimia Phyllitidis*, Sw. *F* = view from midrib, *G* from margin of pinnule. *H-L* = spores of the Schizaeaceae. *H* = *Schizaea pennula*, Sw. *J* = *Lygodium japonicum*, Sw. *K* = *Mohria caffrorum* (L.) Desv. *L* = *Ancimia fulva*, Sw. (All but *K* after Prantl. *K*, after Diels—from Engler and Prantl, *Nat. Pflanzenfam.*)

though occasionally it is more complex: it is contracted towards the apical end of the sporangium, and there is a definite stomium; but however contracted it may appear, there is in its centre an apical group of thin-walled cells (or it may be only a single one in *Lygodium* and *Schizaea*), designated by Prantl the "plate." It is important to note its existence for comparison with sporangia of other Ferns. The rest of the sporangial wall is thin.

The sporangia of *Mohria* are radially constructed, the apex and base being opposite (Fig. 302 D, E). In the other genera the sporangia are more

or less curved, so as to be dorsiventral: this curvature is slight in *Aneimia* and *Schizaea* (Fig. 302 A, B, F, G), but very marked in *Lygodium* (Fig. 302 C).

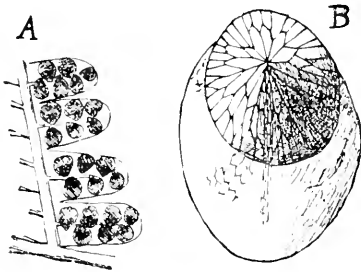

FIG. 302.

Senftenbergia (Pecopteris) *elegans*, Corda. A = a small piece of sporophyll ($\frac{1}{4}$). B = a sporangium ($\frac{3}{16}$). (After Zeiller, from Engler and Prantl, *Nat. Pflanzenfam.*)

Here it will be well to introduce a brief notice of certain fossil sporangia which have been referred to this affinity, for they help to an understanding of the structure of those of living forms. The best known of these is *Senftenbergia* (*Pecopteris*) *elegans*, Corda, from the upper Carboniferous (Fig. 303): it corresponds to *Schizaea* both in the disposition of the solitary sporangia and in their form and mode of dehis-

cence; but the annulus is composed of several cell-rows, and the terminal "plate" has not been observed. Zeiller points out, however, that this is not an absolute difference from living forms, for various species of *Lygodium* (a genus which has itself been traced back to the Cretaceous Period), have a partially double series of cells of the annulus, while the "plate" in living forms is often so small that a similar one in a fossil-impression might well escape detection.¹ A second example is the genus *Klukia*, the fructification of a Pecopterid from the Jurassic, of which several species have been described by Raciborski.² Here the arrangement of the sporangia, their structure, and line of dehiscence are as in *Schizaea*, there being only a single series of cells of the annulus (Fig. 304). In both of these genera of fossils it is to be noted that the sporangia are intra-marginal, on the lower surface of the pinnule, but without any indusial protection, while there is no specialisation of the fertile pinnules.

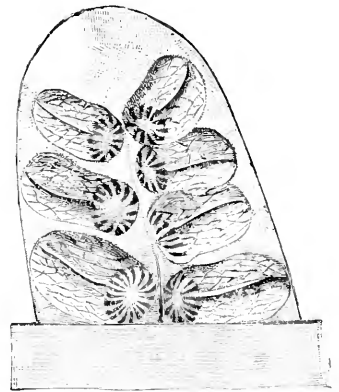

FIG. 304.

Klukia exilis (Philippis). Raciborski. Fertile pinnule of last order, seen from below ($\frac{2}{3}$). From the Jurassic of Krakau. (After Raciborski, from Engler and Prantl, *Nat. Pflanzenfam.*)

From such comparisons it would appear probable not only that the Schizacaceous type is an ancient one, but that it sprang from plants with a Pecopterid type of frond, without differentiation of specialised fertile pinnules, and that the sporangia were intra-marginal, on the lower surface.

¹ *Bull. Soc. Bot. de France*, T. xxiv., p. 217.

² *Engler's Jahrb.*, xiii., p. 1, Taf. 1.

Probably they had originally a more complex annulus than those of the present day.

The development of the sporangium follows in its main features the usual Fern-type, each being referable to a single parent cell, with rectangular base. It is specially noted by Prantl,¹ that in all the Schizaeaceae the first segment-wall extends from the outer to the inner periclinal wall of this cell: such segmentation is a feature characteristic of the more robust types of Fern-sporangium (Fig. 305). This is followed by two other anticlinal divisions, as seen in section, and then comes the periclinal division which separates the cap-cell from the archesporium. The former gives rise to the greater part of the sporangial wall, while the lower segments complete the wall, and form the short stalk. In the archesporium the usual tapetum and sporogenous group are formed: the latter consists, however, of a larger number of spore-mother-cells than usual in the Leptosporangiate Ferns: in *Ancimia* Prantl figures 16 spore-mother-cells as seen from one side only of the sporogenous mass, and I have seen the same number in *Mohria* actually traversed in a single section. These observations led to an enumeration of the spores actually produced from the sporangia of the Schizaeaceae: in *Lygodium japonicum* and *dichotomum* the number approximated to 256, but in *L. pinnatifidum* to only 128: there is thus a difference between species of the genus, as in *Todea* and elsewhere. The lower figure is shared also by *Schizaea*,² *Mohria* and *Ancimia*. The numbers are thus larger than are seen in ordinary Leptosporangiate Ferns, and they approach those seen in the Osmundaceae. The largest number is seen in *Lygodium*: it will be seen that its anatomical characters also mark this genus out as more archaic in structure than the rest of the family.

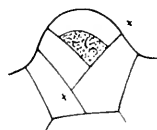

FIG. 305.

Diagram of segmentation of a sporangium of the Schizaeaceae; the first segment wall meets the periclinal (basal) wall of the parent cell; but the second (x, x) meets the first, and does not extend to the base of the parent cell.

ANATOMY.

The Schizaeaceae show diversity of habit, varying from those with creeping rhizome and laxly disposed leaves to those with ascending or upright stock, and leaves densely spiral: the internal structure of the shoot also shows marked differences, which follow these differences of habit.³ In *Lygodium* the simplest vascular structure is found, for there the rhizome is traversed by a protostele with solid xylem consisting of tracheides and parenchyma, surrounded by phloem, pericycle, and endodermis. There is no typical proto-xylem: the first formed tracheides

¹ *L.c.*, p. 49.

² Tansley and Chick, *Ann. of Bot.*, 1903, p. 495.

³ See Boodle, *Ann. of Bot.*, 1901, p. 359, and 1903, p. 511; Jeffrey, *Phil. Trans.*, B, 1902, p. 128; also Tansley and Chick, *Ann. of Bot.*, 1903, p. 493.

are finely scalariform, and are scattered round the periphery of the xylem-core, which is itself composed of tracheides, intermixed with parenchyma (Fig. 306). The petiole is traversed by a single strand, which comes off from the protosteles with only superficial disturbance of it: in fact the mature plant maintains the simple relation of the protosteles and trace which is seen in its seedling (Fig. 307). The foliar strand in the climbing petiole is an almost cylindrical body, with bays of phloem protruding into the xylem: it is probably a derivative form of the more usual flattened type, contracted in accordance with the climbing habit. In *Schizaea* the obliquely ascending or erect stock shows a medullated stele: endodermal

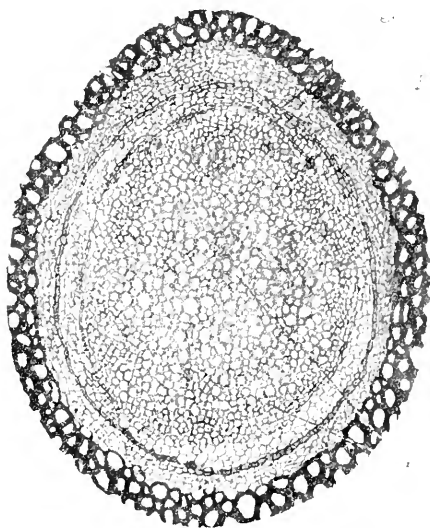

FIG. 306.

Transverse section of the rhizome of *Lygodium dichotomum*. $\times 50$. *e* = endodermis; *ph* = phloem; *x* = xylem. (After Boodle.)

pockets are often present at the nodes, or an isolated internal endodermis is occasionally seen, but no internal phloem. Internal tracheides occur in the medullary region, sometimes isolated, sometimes almost bridging across the central pith (*S. molluccana*). It has been clearly demonstrated that as the stele in the seedling expands, no internal phloem appears: these facts favour a theory of amplification of the stele in *Schizaea* rather than one of reduction. In *Ancimia Phyllitidis* and most other species, as also in *Mohria*, the mature stem is dialystelic, having a hollow reticulate vascular cylinder similar, except for the leaf-traces being only a single strand, to that of *Nephrodium filix mas*: each mesh is a leaf-gap and the leaf trace is inserted at its base. But in *A. mexicana* and other creeping species the dialystelic state is replaced by closed vascular ring or solenosteles. The simpler type of *Lygodium* is probably the more primitive, and as

bearing on this the development of its seedling does not suggest reduction from any more complicated type. In the seedling of *Aneimia* there is at first a solid stele, which is converted into a dialystelic one by gradations similar to those for instance in *Pteris*: the ontogeny may here be held to indicate the probable evolutionary progression. In the case of *Schizaea*

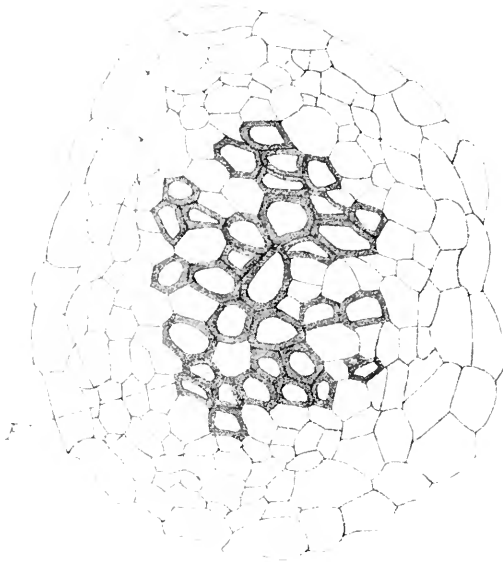

FIG. 307.

Transverse section of axis of seedling of *Lygodium japonicum*, below the first leaf. *p* = one of the xylem-parenchyma cells. $\times 390$. (After Boodle.)

the facts indicate that its middle position is due to amplification of the stele leading up towards the solenostelic state, though the opinion is also a tenable one that the genus illustrates phases of reduction.

EMBRYOLOGY.

This is described as being similar to that common for most Ferns in the case of *Schizaea pusilla*.¹ It may be noted, however, that the filamentous prothallus in this species shows very close analogies with that of the Hymenophyllaceae

In discussing the probable phyletic relations of the living Schizaeaceae, Prantl² remarks that it is impossible to derive any one genus from any other: they have obviously similar soral and sporangial characters, but they differ so greatly one from another in other respects that we can only regard them as derived from some simpler type, which may be held as a common

¹ Britton and Taylor, *l.c.*, p. 2.

² *l.c.*, p. 148.

ancestor. If the attempt be made to sketch the characters of that ancestry they would be as follows: Probably like other primitive Ferns the early Schizaeaceae had an upright, dichotomously branching stock (retained until after the leading soral characters were established), with radially disposed leaves, which also branched dichotomously: a protostelic structure (retained till after *Lygodium* had assumed its creeping habit), and a relatively simple leaf, as indicated by the single strand of the leaf-trace. On the surfaces were simple filamentous hairs. The monangial sori were probably superficial, as indicated by *Senftenbergia* and *Klukia*, with a tendency towards the margin realised in the more modern forms. The sporangia were relatively large, with the annulus consisting of more than a single series of cells.

Of the living forms *Lygodium* represents structurally the most primitive type, being protostelic. Subsequently the stele dilated, perhaps to accommodate the enlarging leaf-traces,¹ as seen in the genus *Schizaea*; and became even dialystelic, as in *Aneimia* and *Mohria*; but the section *Aneimiorrhiza* probably assumed its prone habit before the solenostele became dialystelic. On this view *Aneimia* and *Mohria* would be anatomically the most advanced types. This harmonises with the facts relating to spore-output: for on this ground also *Lygodium* would be the most primitive, and the other genera would have proceeded further towards reduction in number of the sporogenous cells. It is in *Lygodium* also that Zeiller recognised that more complex structure of the annulus which corresponds to that of the earlier fossils.

There is, however, another, and from its entire independence of the characters compared above, a most important feature, which marks off *Aneimia* and *Mohria* as advanced genera in the family. Heim,² in selecting organs which are typical for the divisions of the Ferns and recur under altered cultural conditions, lays great stress upon the structure and mode of dehiscence of the antheridium, of which he recognises two types: Type A, in which at maturity the cap-cell breaks away; this includes the Osmundaceae, Gleicheniaceae, Hymenophyllaceae, Cyatheaceae, Dicksoniaceae, and *Lygodium*; it is, in fact, characteristic of those Ferns which are usually held as primitive. Type B, in which the antheridium has a star-like dehiscence, includes *Aneimia* and *Mohria*, and the whole body of the Polypodiaceae: thus these genera share with the later and presumably derivative Ferns³ a character by which they differ from *Lygodium*. Accordingly, on their anatomy, on their spore-output, and on the mode of dehiscence of the antheridium *Aneimia* and *Mohria* appear relatively advanced, and *Lygodium*, which itself goes back to the Cretaceous Period, is relatively primitive. Any converse view will have to meet not only one, but all of these lines of evidence.

¹ Boodle, *Ann. of Bot.*, 1903, p. 530.

² *Flora*, 1896, p. 329, etc.

³ Heim notes also other characters of the gametophyte in which *Aneimia* and *Mohria* differ from *Lygodium*: so that the distinction is not based merely on the antheridial dehiscence, but is more general.

It is then specially through *Lygodium* that the nearest connection may be sought with ancestral Fern-types, which should have a protostelic stock, and show dichotomy both in axis and in leaf: large sporangia, with the annulus not necessarily uniseriate, and with a relatively large spore-output. As these characters are less decisive than those seen in the preceding families, the difficulty in locating the Schizaeaceae will be correspondingly greater.

MARSILIACEAE.

It is probably in near relation to the Schizaeaceae that the Marsiliaceae find their most natural position. This has been argued by Campbell,¹ and the data relating to the sporangia appear specially convincing. But as these heterosporous plants constitute a peculiarly specialised line, which has probably never advanced further, the discussion of them, however interesting in itself, does not bear directly upon the problem in hand. Accordingly no detailed account will be given of the Marsiliaceae.

There is, however, one striking feature in their morphology which calls for notice here, since it provides an apparent analogy with the Ophioglossaceae: viz. the position of the "sporocarp." This curious and complex body may be stalked or sessile and be borne singly attached to the leaf-stalk, or in considerable numbers as in *M. polycarpa*: finally it may itself be branched. From its position and structure, as well as from the way in which the sporangia are produced, a foliar character is probable, notwithstanding that the form is far removed from that of any ordinary leaf-segment: and this is the conclusion to which study of the development has clearly led.

Johnson² found that both in *Marsilia* and *Pilularia* the origin of the sporocarp is from a cell of the marginal series of the leaf: he concludes that the capsule is the equivalent of a branch of a leaf in which the marginal cells have been devoted to the formation of sporangia instead of a lamina. Goebel obtained a somewhat similar result from the investigation of *M. polycarpa*:³ here the numerous sporocarps arise in acropetal succession from the margin of the leaf, but from one margin only: they assume upon the leaf-primordium the same position as the sterile pinnae. But the arrangement of the cells is different: the sporophylls have a two-sided initial, while the sterile pinnae show from the first a marginal growth. This, however, need not preclude the recognition of the sporocarps as the correlatives of pinnae.

The analogy of these bodies with the spikes of the Ophioglossaceae is too obvious to escape remark, and some have seen in them and their pinna-character strong evidence that the same must be the nature of the Ophioglossaceous spike. The objections to this facile conclusion are two:

¹ *American Naturalist*, 1904, pp. 761-775.

² *Ann. of Bot.*, xii., p. 119; and *Bot. Gaz.*, xxvi., p. 1.

³ *Organography*, vol. ii., p. 479.

first, that the latter are not marginal, excepting very occasional examples in *O. palmatum*, which is held as a derivative and outlying species: but secondly, the general comparison of characters, morphological and anatomical, of the sporophyte, of the sporangia, and of the gametophyte, indicates a quite separate position for the Ophioglossaceae. It suggests that the most that can be said is that some analogy exists between the Marsiliaceae and Ophioglossaceae in the position of their spore-producing parts; but the way in which this analogy has been attained is quite a different question. It seems probable that they represent quite distinct evolutionary sequences: a well-founded hypothesis has been stated above of an origin of the Ophioglossaceous spike quite distinct from that of the sporocarp in the Marsiliaceae.

CHAPTER XXXVI.

GLEICHENIACEAE.

THIS family is represented by about twenty living species, all of which are referred by some systematists to the single genus *Gleichenia*, though others separate off the monotypic genera, *Platyzoma*, Br., and *Stromatopteris*, Mett. The living species are distributed throughout the tropics, whence they extend far southwards, but only in less degree north, and they are absent from the northern temperate zone.

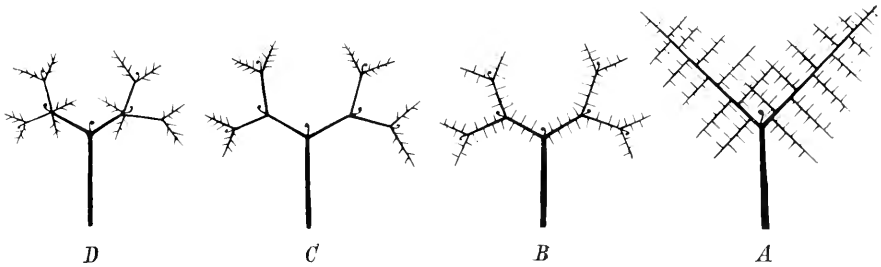

FIG. 305.

Gleichenia, Sw. § *Mertensia*, Willd. Scheme of branching of the leaf in the four sections of the genus. (After Diels, from Engler and Prantl, *Nat. Pflanzenfam.*)

Among these Ferns an upright shrubby axis is occasionally found (*Stromatopteris*), but usually there is a creeping rhizome, which sometimes takes an ascending position. Upon it the leaves are solitary, often with long internodes, but sometimes more closely arranged (*Platyzoma*). The leaves are occasionally simply pinnate (*Stromatopteris*, *Platyzoma*); but usually they show higher degrees of branching, together with a peculiar straggling habit. The branching of the leaf has frequently been described as dichotomous; but according to Goebel no species of *Gleichenia* has a dichotomous leaf,¹ the branching is always a monopodial pinnation: the appearance of "forking" is the consequence of the two pinnules below the circinate but temporarily

¹Goebel, *Organography*, vol. ii., p. 319, footnote.

arrested leaf-tip developing equally, and so strongly as to exceed the actual apex which lies between them. But on the other hand, as the result of comparison apparently of mature specimens, Tansley refers the leaf-architecture ultimately to dichotomy. He states that "a bud normally arises from the angle of the primary dichotomy."¹ In face of such diametrically opposite statements the accurate observation of the ontogeny is most desirable; hitherto the details of development of the Gleicheniaceae leaf have never been worked out.

The degrees of branching of the leaves have been made the basis of subdivision of the genus into four sections (Fig. 308).² Goebel has described the mode of protection of the resting bud seen in some species: the pinnules which stand nearest to the apex form protective scales, and they have been mistaken for adventitious or aphyloid growths.³ As a matter of fact, the whole structure can be referred to a normal pinnate development of the leaf, altered by temporary arrest of the apex, and by precocious development of certain pinnae. Hairs and paleae are found on the surface both of rhizome and leaf.

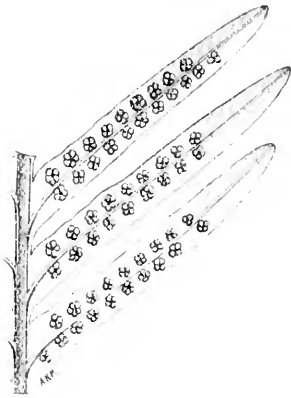

FIG. 309.

Gleichenia flabellata, Br. Midrib and three pinnules, showing the arrangement and constitution of the sori, with variable number of sporangia.

The sori are always superficial, disposed in a single row on either side of the midrib of the fertile segment (Fig. 309). Typically they are radiate-uniseriate, the sporangia being attached in a ring round a central receptacle: they are without indusium. The number of sporangia varies in different species, two to five being common numbers; but the sorus may often be represented by a solitary sporangium (monangial sorus),

especially towards the distal end of the segment, a fact pointing in the direction of the Schizaeaceae: or the number may be larger than five or six, as in *G. pectinata* and *dichotoma* (Fig. 310, a-h), and this points in the direction of the Cyatheaceae.

The existence of the fossil Fern with fructification designated *Oligocarpia* has been held as evidence of the existence of Gleicheniaceae Ferns as early as the Palaeozoic period. But the fact that the Gleicheniaceae and Marattiaceae sori are of the same type throws the burden of proof upon the sporangial structure, on which point it may be admitted that there is some doubt.⁴ But the Gleicheniaceae habit of frond is seen in the Palaeozoic genus *Diplotmema* and other types, while certain Carboniferous stems had an anatomical structure like that of the Gleicheniaceae.⁵ But

¹ *Ann. of Bot.*, xix., 1895, p. 479.

² Diels, *Nat. Pflanzenfam.*, i. 4, p. 352.

³ Goebel, *loc. cit.*, p. 318.

⁴ See below, p. 560.

⁵ Scott, *Studies*, p. 263.

whatever may be the doubt as to the proof of Palaeozoic Gleicheniaceae, their existence in the Mesozoic seems clear: certain of the fossils of that age have even been referred to the sub-genera of *Gleichenia*, as represented by living species. It will be seen that a detailed examination of the living species supports on comparative ground an early origin of the family, such as the fossil evidence suggests.

SPORE-PRODUCING MEMBERS.

The naked sorus consists of a low circular receptacle bearing a variable number of sporangia. The sporangia are commonly quite separate from one another, though instances of synangia which resemble a fusion of two

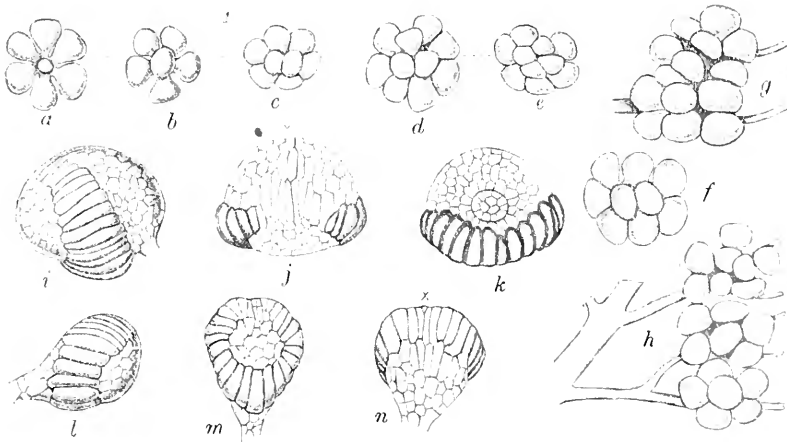

FIG. 310.

a-h sori of *Gleichenia dichotoma*, Willd. *a-c* show sori of radiate type, but with one or more sporangia in the centre of the sorus, usually in this genus vacant. *f, g, h* show degrees of fusion of the sorus. *a-h* \times about 14. *i, j, k* = sporangia of *Gleichenia circinata*, Sw., seen respectively from the side, from the distal end showing the line of dehiscence (\times), and from the proximal end showing the stalk. $\times 50$. *l, m, n* = sporangia of *Gleichenia dichotoma*, Willd., seen respectively from the side, presenting the peripheral face. Note the difference in size from *G. circinata*. $\times 50$.

sporangia, are not uncommon. The sporangia usually form a single row round the receptacle: their orientation is in this case constant, the longitudinal slit of dehiscence facing directly towards the centre of the rosette-like sorus. Where the number of sporangia in the sorus is more than five, single sporangia may be displaced, perhaps by lateral pressure, and point obliquely upwards. But in *Gl. dichotoma*, in which the number of sporangia in the sorus may be as high as ten, or even more, the central area of the sorus, which is usually vacant in other species, may also be occupied by sporangia. Figs. 310, *a-c*, show cases of the insertion of sporangia on the apex of the receptacle: the number of these sporangia may vary from one upwards, and they form a second tier above the basal rosette. When

one of these only is present it usually occupies a central position. The orientation of these central sporangia is not constant. By the presence of these supernumerary sporangia the gap is bridged over within a single genus, between two well-marked types of sorus: on the one hand are the Marattiaceae, and most of the Gleicheniaceae, representing the "radiate uniseriate" type, with a single linear series of sporangia, surrounding the periphery of the low receptacle; on the other hand are the Cyatheaceae, Dicksoniaceae, Loxsomaceae, and Hymenophyllaceae, with a more or less elongated receptacle covered to its apex with numerous sporangia.

As in other genera where the sorus is circumscribed, so also in *Gleichenia*, fissions of the sorus may be found, chiefly in conjunction with branching of the veins. Examples of this are shown in Fig. 310 *f, g, h*.

The sporangia have an annulus, consisting typically of a single row of cells: it is complete round the head, with the exception of the region of dehiscence, which is on the side directed away from the lower surface of the leaf (Fig. 310 *i-n*). The position of the annulus is oblique, so that of the two thinner areas of the sporangial wall which lie on either side of it, the one faces obliquely towards the centre of the sorus, and away from the leaf-surface, the other obliquely away from the centre, and towards the leaf-surface. The former may be styled the acroscopic or central, the latter the basiscopic or peripheral face of the sporangium.

There is considerable variation in size of the sporangia in the genus *Gleichenia*. Those species which have a small number of sporangia in the sorus, such as *Gl. rupestris* and *circinata*, have relatively large sporangia (Figs. 310 *i, j, k*); those which have more numerous sporangia in the sorus have them of smaller size, e.g. *Gl. dichotoma* (Figs. 310 *l, m, n*). Taking first the sporangia of the larger type, as seen in *Gl. circinata*, the form is almost that of a kettledrum; the "peripheral" face is almost flat, and lies in apposition to the leaf-surface, while the annulus runs round its margin; the "central" face is very convex. The stalk is short, and consists of a central group of cells, surrounded by a peripheral series; it is thus thicker than in ordinary Leptosporangiate Ferns. The sporangium of *Gleichenia dichotoma* is of much more elongated form, the stalk is thinner, and has no central group of cells: the annulus rises more obliquely from the surface of the leaf. *Gleichenia flabellata* holds a middle position between these two types as regards size and shape of the sporangium, but in the number of spores produced in each sporangium it is, as we shall see, an extreme type.

Tracing the development in *G. flabellata*, the sorus first appears in the still tightly circinate pinnule: it arises as a smooth outgrowth opposite a nerve (Fig. 311 *a*), a considerable number of cells being involved in its origin. Having grown to a height almost equal to the thickness of the pinnule, it becomes flattened at the apex; in those cases where the sorus is to be a simple rosette (Figs. 311 *b, g*), the convex margin begins to grow out as rounded processes, which develop into the sporangia. There

is some variety of detail, according to the size of the future sporangium; in the larger type of *Gl. circinata* or *Gl. flabellata* each process undergoes segmentation, resulting in a conical sporangial cell (x); in this successive obliquely inclined divisions follow, the earlier of which contribute to form the relatively massive stalk (Figs. 311 *b*, *c*). These divisions do not appear to be uniform, as will be seen on comparison of the four corners of Fig. 311 *c*, and of vertical sections (Fig. 311 *b*); the

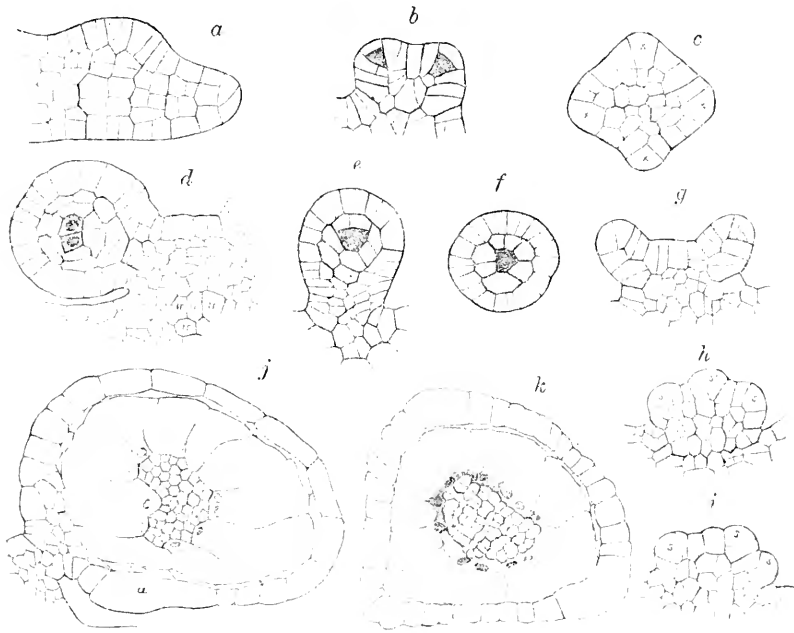

FIG. 311.

a, *b*, *c* = sori of *Gleichenia flabellata*, *a*, *b* in vertical, *c* in horizontal section; *d*, *e*, *f* = sporangia of *Gl. circinata* showing central cell and tapetum; *g*, *h*, *i* = sori of *Gl. dichotoma*; in *g* the centre is vacant, in *h* and *i* young sporangia appear in the vacant space; *j*, *k* = sporangia of *Gl. flabellata* with spore-mother-cells formed, and very numerous. *a* - *i* $\times 200$; *j*, *k* $\times 100$.

latter also show in the case of these more massive sporangia that the periclinal division, which cuts off the cap-cell, takes place at a time when the sporangial head projects but slightly from the surface of the receptacle. From this description, and from the figures it is apparent that the whole sporangium is from the first of more massive construction, and results from more numerous segmentations than that of ordinary Leptosporangiate Ferns, though the last segmentations which define the central cell follow the usual sequence.

In the more attenuated type of *Gl. dichotoma* the sporangium is from the first of more elongated form, and its stalk less massive (Fig. 311 *g*); the formation of the cap-cell takes place at a time when the sporangial head is more clearly in advance of the adjoining tissue, and the central

cell is thus never actually immersed in the tissue of the receptacle as is the case in *Gl. flabellata*. In this feature again, *Gl. dichotoma* approaches the ordinary Leptosporangiate type. The central sporangia, above noted as occurring in this species, arise, as far as can be seen, simultaneously with the rest, and actually occupy the central area of the sorus from the first (Figs. 311 *h, i*); this area is usually vacant in other species, and is sometimes vacant also in *Gl. dichotoma* (Fig. 311 *g*). Since the sporangia originate in this central position, their presence there cannot be accounted for by displacement due to pressure; it is to be ascribed rather to extra development, or interpolation of one or more accessory sporangia, which arise in a position usually unoccupied in the genus.

The divisions in the sporangial head to form the lateral cells of the wall, the cap-cell, the tapetum and definitive archesporial cell, follow with slight deviations the type general for Leptosporangiate Ferns (Figs. 311 *b-g*): the archesporial cell is usually of tetrahedral form, but from the first it is of relatively small size, while the tapetum, which soon divides periclinally into two layers, grows rapidly. The outer wall remains a single layer of cells, but the cells divide freely by anticlinal walls so that in the mature state the sporangial wall consists of very numerous cells (Figs. 311 *d, j, k*). The annulus soon becomes differentiated, and it appears that part of the annulus owes its origin to the cap-cell, but the larger part to the lateral segments. The outer layer of the tapetum with occasional supernumerary cells near the attachment of the stalk remains small, and forms a narrow inner investment of the wall; it is permanent for a considerable time, and traces of it may be found even in the mature sporangium. The inner tapetal cells enlarge greatly, and often become polynucleate: their protoplasm becomes aggregated, with the nuclei in close proximity to the sporogenous mass (Figs. 311 *j, k*), while the cell-walls become absorbed.

The definitive archesporial cell in *G. flabellata* undergoes successive divisions (Figs. 311 *d, j*), but the divisions are continued beyond the limited number usual for Leptosporangiate Ferns; the result is a very considerable cell-mass, so that a single vertical section through a sporogenous group of an average sporangium may traverse as many as 46 spore-mother-cells (Fig. 311 *j*): 45 was found to be the mean of countings in sections through eight different sporangia. A section through a sporangium parallel to the surface of the leaf may traverse even a larger number, as in the sporangium of Fig. 311 *k*, where 66 are shown in section. This difference may be in part due to the section traversing the curved sporogenous mass obliquely, but this explanation will not account completely for the variation in number. Any one section will only traverse about one-eighth of the whole number of sporogenous cells, thus there will be about $45 \times 8 = 360$ spore-mother-cells in a single sporangium, and the potential output of spores may be estimated at about $360 \times 4 = 1440$. Comparing this with the case of ordinary Leptosporangiate Ferns, it is plain that the potential productiveness of an average sporangium of *Gl. flabellata* is far

in advance of the latter. *G. dichotoma* shows individual fluctuations in size of the sporogenous group, while the number of spore-mother-cells is considerably below that in *G. flabellata*. Subsequently, the spore-mother-cells separate, becoming rounded off, and undergo the usual tetrad division. Prior to this, the tapetal nuclei make their way in among the developing spore-mother-cells, as has been described for other sporangia.

In order to test the results obtained from sections, and the estimates of potential spore-production based on them, countings of the actual spores produced from single sporangia have been made in various species of *Gleichenia*, with the following results :

Gl. flabellata, 794, 695, 838, 634.

Gl. circinata, 241, 242.

Gl. rupestris, var. *glaucescens*, 220, 232, 244.

Gl. hecistophylla, 265, 272.

Gl. dichotoma, 251, 319.

From the figures it appears that the output is very irregular, but considerably in excess of that in most Leptosporangiate Ferns ; that the high estimated number in *Gl. flabellata* is not actually attained ; and that though in the four latter species the numbers approximate to 256, that figure is liable to be exceeded. That the actual figure in *Gl. flabellata* falls below the estimate may be accounted for partly by the abortion of some spore-mother-cells, or young spores, of which there is evidence ; partly by errors in counting such large numbers ; but it may also be due to the number of spore-mother-cells being inconstant, or being actually not so large as the estimate, which is necessarily only a rough one ; another reason for the deficiency is the frequently incomplete division of the spores of single tetrads. There is no exact proportion between the size of the individual sporangium and its output of spores in this genus as a whole. *Gl. circinata*, with its large sporangium, has a smaller output than *Gl. flabellata*, of which the sporangium is a medium size. It is, however, to be noted that the spores in the latter species are smaller than in the former.

The dehiscence of the sporangium takes place by a slit in the median radial plane ; the annulus, which is continuous all round, except along the line of rupture, becomes gradually straightened on drying, or even everted, the whole sporangium thus widening laterally so as to elbow aside the other sporangia in cases where these are numerous. Then a sudden jerk on both sides of the slit throws the spores out, right and left. Plainly, this mode of dehiscence requires lateral space, to allow of the widening before the jerk, and it is thus ill-suited for a crowded sorus. Its existence here indicates that the Gleicheniaceae are in the upgrade, not in the downgrade, of soral complexity. The facts point to the radiate-uniseriate type of sorus as being the primitive state, while the spore-numbers would indicate that of the species examined, *G. flabellata*, in which that type of sorus is represented in its most regular form, is probably the most

primitive. It will be seen that this species has a stelar structure of the axis of a type which also indicates its relatively primitive character in the genus.

The sorus of *Oligocarpia* from the upper Carboniferous corresponds in its arrangement to that of *Gleichenia* (Fig. 312). *O. Gutbieri* and *lindsaoides* show uniseriate sori with varying number of the sporangia, as in *G. flabellata*; but *O. Brongniartii* has accessory sporangia occupying

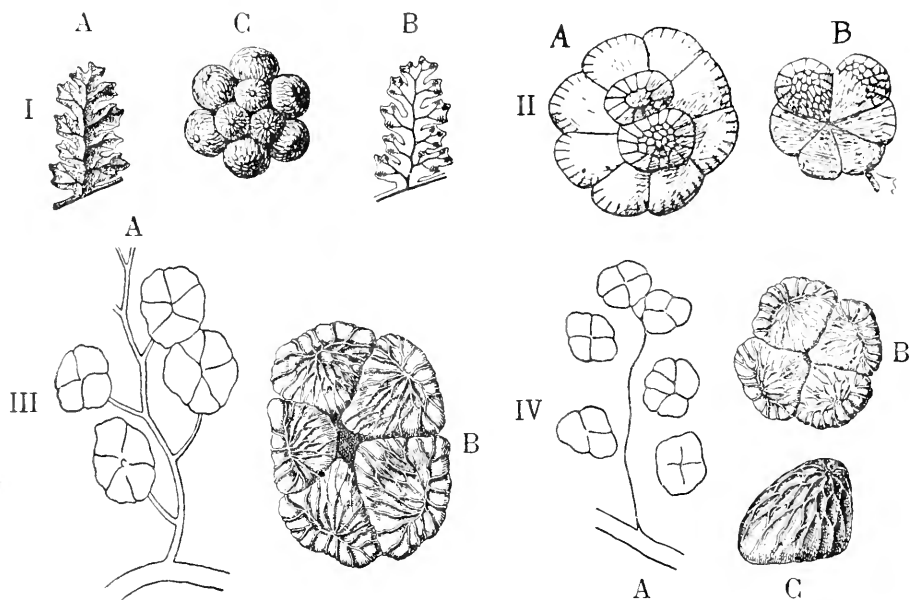

FIG. 312.

I. *Oligocarpia Brongniartii*, Stur. A = a sterile; B = a fertile pinnule ($\frac{3}{8}$); C = a sorus more strongly magnified. (After Stur.) II. = two sori of the same species. $\times 35$. (After Zeiller.) III. *Oligocarpia Gutbieri*, Göpp. A = position of the sori on a segment of the last order. $\times 30$. B = a sorus. $\times 65$. (After Stur.) IV. = *Oligocarpia lindsaoides* (Ett.), Stur. A = position of the sori on a segment of the last order. $\times 30$. B = a sorus. C = a sporangium. $\times 60$. (After Stur, from Potonié's *Lehrbuch*.)

the centre of the sorus, as in *G. dichotoma*. There is, however, a difference of opinion as to the annulus, and it is upon this that the ultimate determination must rest: Zeiller recognises an annulus similar to that of the Gleicheniaceae; but Solms Laubach¹ does not assent to this, asserting that the supposed annulus is due to an effect of lighting of the specimen under observation. Zeiller nevertheless adheres to his opinion.² Whatever

¹ *Fossil Botany*, p. 146.

² Potonié, *Lehrbuch*, p. 102. Mr. Kidston has shown me specimens of *Oligocarpia Gutbieri* in which the line of dehiscence was clearly seen running radially down the central face of the sporangium. The annulus could not be reduced to a single row of cells. Probably the type had a pluriseriate annulus like other Palaeozoic Ferns (compare Kidston, *Phil. Trans.*, Ser. B, vol. 198, p. 188; also Scott, *Progressus Rei Botanicae*, vol. i., p. 184). It may, however, be remarked that a division of the cells of the annulus appears as an occasional irregularity in sporangia of living species of *Gleichenia*, a distant suggestion of a pluriseriate annulus in the ancestry.

be the final decision on this point, it is clear that sori of the same type as those of *Gleichenia* existed at the Carboniferous period, and that in size and form the constituent sporangia were like those seen in the living species.

ANATOMY.

There is greater uniformity of anatomical structure in the Gleicheniaceae than in the Schizaeaceae; but still there are marked differences within the family which have a probable phyletic bearing when placed in relation

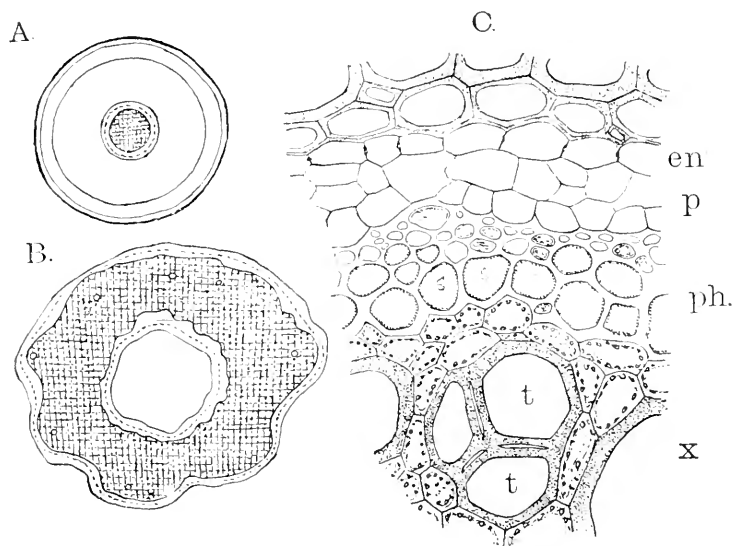

FIG. 313.

A = diagram of the tissues of the rhizome of *Gleichenia flabellata*. $\times 8$. *B* = section of the stele (somewhat diagrammatic) of *G. pectinata*. $\times 26$. *C* = part of the stele of *G. dichotoma*. $\times 250$. (All after Boodle, from Campbell's *Mosses and Ferns*.)

to other characters.¹ In the majority of species the rhizome shows in the internodes a centrally placed, solid stele (protostele), consisting of a central mass of xylem composed of tracheides and parenchyma, and surrounded by a continuous ring of phloem, pericycle, and endodermis (Fig. 313 A). There is thus a general resemblance to the structure of the rhizome of *Lygodium*; but a point of difference is that whereas in *Lygodium* there is no typical protoxylem, in *Gleichenia* the protoxylem is represented by several distinct groups of spiral elements, which are mesarch. The tracheides of the xylem are arranged in chains and groups separated by parenchyma: in fact the structure as seen in *G. flabellata* is strikingly like that of *Lygodium*, except in the matter of the protoxylem. In several

¹The data here embodied are chiefly derived from Poirault, *Ann. Sci. Nat. Bot.*, 7 Série, T. xviii., p. 170, etc., and from Boodle, *Ann. of Bot.*, vol. xv., p. 703.

species the xylem-core is fluted, the protoxylems being mesarch in its slightly projecting ridges. The only other widely different type of structure found in the genus is the solenostelic, which has been observed in *G. pectinata* alone: here the stele is larger than in any other species which have been examined: in addition to the structure as described the centre of the fluted xylem is replaced by a mass of sclerenchyma, surrounded by a ring of endodermis, pericycle, phloem, and conjunctive parenchyma (Fig. 313B). Another type which takes an intermediate position as compared with those already mentioned is seen in *G. (Platyzoma) microphyllum*, in which the leaves are densely crowded and polystichous on the rhizome. Here there is also an inner endodermis surrounding a central sclerenchyma, but there is no internal phloem between the xylem and endodermis.

In this last-named species the leaves are small, and the leaf-trace separates as a small collateral strand from the periphery of the stele without disturbance of the underlying tissues. This appears also to be the mode of origin in the seedling of the more complex *G. circinata*: but in these larger-leaved species the leaf-trace of the mature leaf takes in the petiole an almost cylindrical form bounded by an endodermis, with (§ *Mertensia*) or without (§ *Eugleichenia*) an involution on the adaxial side (Fig. 314). *G. dichotoma* is exceptional in § *Mertensia* in having no involution. The whole petiolar bundle may be regarded as a single flat ribbon widened laterally, but closely compressed and crumpled so as to take a cylindrical form: in that case the condition of § *Mertensia* with the endodermal involution would be more primitive than § *Eugleichenia* where there is none. But *G. dichotoma* is an exception in the latter section, showing the more advanced state.

The node of insertion of these larger leaf-traces may be marked by complications, islands of tissue (composed of phloem, endodermis, and sclerenchyma) appearing in the xylem of the stele as cut transversely: these correspond actually to pocket-like encroachments of those tissues, extending down from the centre of the petiolar trace into the stele of the axis. Such pockets are only slightly developed in *Eugleichenia*, but more so in *Mertensia*, and especially so in *G. dichotoma*, which leads suggestively on towards the continuous solenostely seen in *G. pectinata*. They have their relation to the theory of stelar structure, and on the facts two views are possible: either that the protostelic condition of most *Gleichenias* is primitive, and that the solenostelic type has been derived from it, or that the protostelic *Gleichenias* might be regarded as showing the reduced remnants of a previous solenostelic structure. The former view appears the more probable: in the first place the seedling is protostelic, and offers no suggestion of reduction to produce that primitive state: analogy with *Lygodium* corroborates this. Further, the nodal pockets may naturally be held to be local complications of the stele, directly connected with the insertion of the peculiarly complicated leaf-trace of an unusually

developed leaf: the formation of the more bulky pockets, and their continuation throughout the internode would give the solenostelic structure. Lastly, the most complex stelar state is seen in *G. dichotoma* and *pectinata*, species which in the character of the leaf, as well as of the sorus and sporangium, are aberrant from the rest of the genus, and have been recognised as showing advance towards the Cyatheaceous type. These several grounds indicate that an evolutionary progression rather than a retrogression is illustrated in the genus, from a protostelic to a solenostelic structure.

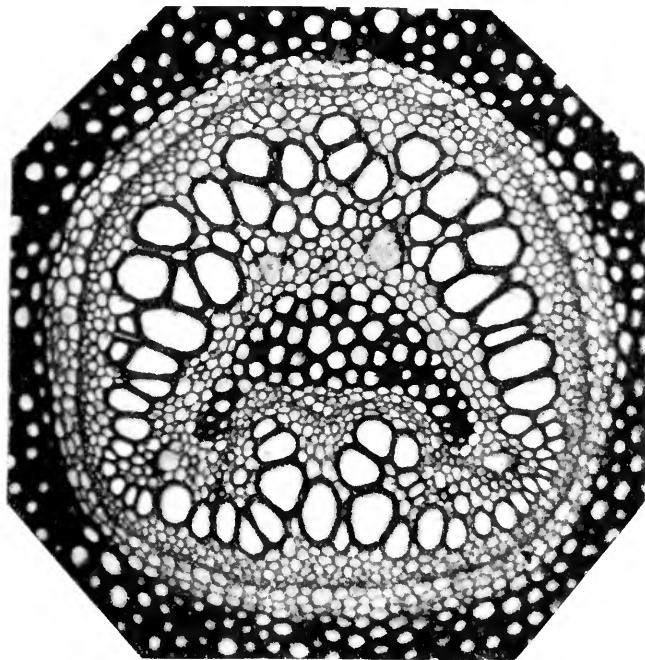

FIG. 314.

Transverse section of the base of the petiole of *Gleichenia dicarpa*, showing the pseudo-stelar structure resulting from contraction of the horse-shoe-like xylem, till its margins fuse. Photograph by R. Kidston, from section by Gwynne-Vaughan.

But lastly, there is the case of *G. (Platyzoma) microphylla*: Boodle suggests that this is a xerophytically reduced form, in which the leaf-traces have become small and crowded, and that it is probably derived from a solenostelic form by obliteration of the leaf-gaps and disappearance of the internal phloem. But his alternative suggestion, that it may have been derived from a protostelic *Gleichenia*, and its structure be due to the new formation of a pith and internal endodermis, appears the simpler as well as the more probable, in the case of an upright plant with closely crowded leaves. For it must be remembered that this was the condition of the shoot common for primitive Pteridophytes.

EMBRYOLOGY.

The development of the embryo appears to follow the type usual for Leptosporangiate Ferns, but the details are not adequately known.¹

The Palaeophytological evidence coupled with the anatomical and soral characters indicates for the Gleicheniaceae a position among relatively primitive Ferns. The comparative examination of the living species leads to the recognition of *G. flabellata* as a central type. This is not so much suggested by the external form, as by the sorus, the stelar structure, the relatively simple insertion of the leaf-trace, and the non-involute strand of the petiole. This species also shows the largest spore-output per sporangium observed in the family. There has probably been a line of diminution of the individual pinnules to produce the condition seen in § *Eugleichenia*, together with a reduction in number of the sporangia in the sorus, leading to a type of monangial sorus similar to that of the Schizaeaceae. A line of probable advance has been to such forms as *G. pectinata* and *dichotoma*: for not only do these species show interpolation of extra sporangia in the sorus, together with smaller sporangia and diminished output per sporangium, but also they are anatomically more complex. This is specially shown by the large nodal pockets of *G. dichotoma*, and ultimately by the continuous solenostely seen in *G. pectinata*. In both respects these species indicate changes from the central type in the direction of Cyatheaceous characters.

MATONINEAE.

This family² is represented by only two species of living Ferns, *Matonia pectinata* and *M. sarmentosa*, both of limited distribution in the Malayan region. But Ferns referred to this affinity on the characters of leaf and fructification played a prominent part in the vegetation of the Secondary Rocks, and have been traced back as far as the Rhaetic period: this fact accords with the unmistakable analogies which they show to the Gleicheniaceae.

The two living species differ in habit: *M. pectinata* is a stout, ground-growing species, with elongated creeping rhizome, covered with filamentous hairs, and branching in an apparently dichotomous manner. It bears solitary leaves at considerable distances apart on its upper surface. These grow to a height of 6 to 8 feet, and have a very characteristic pedate construction of the lamina, which is referable to a dichotomous system of branching (Fig. 315): even the "middle lobe," which often appears

¹ Rawenhoff, *Arch. Neerl.*, T. xxiv., p. 223.

² The chief sources of information have been *Natur. Pflanzenfam.*, i. 4., p. 343; Seward, *Phil. Trans.*, vol. 191, p. 171; Tansley and Latham, *Ann. of Bot.*, vol. xix., p. 475, and my own *Studies*, iv., p. 44.

to hold a terminal position, has been recognised as the inner branch of the second dichotomy. The segments themselves are pinnatifid, and the solitary sori are borne on their wings at points near to the midrib. The other species, *M. sarmentosa*, grows on rocks or on the branches of trees, with straggling, pendent leaves: at first sight the branching of the leaf seems quite different from that of *M. pectinata*; but this is due partly to the unequal development of the dichotomies, certain of the branches being represented only by arrested buds: partly it is due to their sympodial concatenation: but still the dichotomous branching appears to hold for

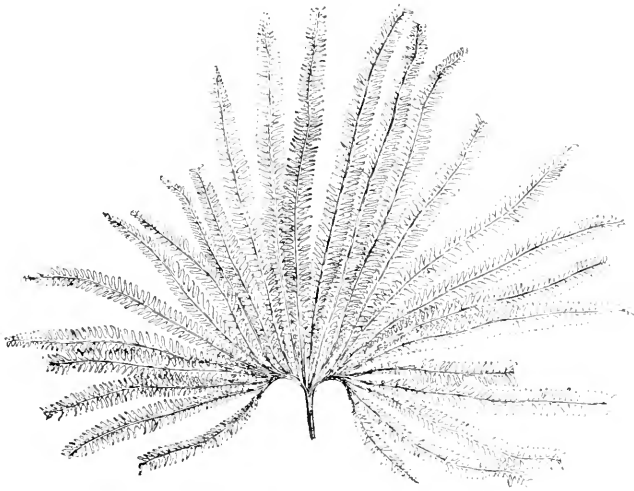

FIG. 315.

Matonia pectinata, R. Br. Leaf drawn from a specimen in the British Museum Herbarium, by Mrs. Seward. $\frac{1}{2}$ natural size.

both. An interesting feature in this species is that the sori are borne in larger numbers, forming a row on either side of the distal part of the pinnule: an arrangement more closely resembling that in *Gleichenia* than that of *M. pectinata*. The structure of the sorus is, however, precisely like that in *M. pectinata*, and there is no doubt of the close alliance of the two species.

SPORE-PRODUCING MEMBERS.

The general structure of the mature sorus is well known; the sporangia, commonly six to nine in number, form a simple ring-like series round the receptacle, and are covered till maturity by the thick and leathery hemispherical indusium, which is ultimately deciduous. The orientation of the sporangia is not exactly uniform; that of the majority is as in *Gleichenia*, but many have the annulus inclined, a consequence probably of crowding; this is seen also in the fossil *Laccopteris*. The annulus is incomplete at

one side, an ill-defined lateral stomium being present, while the rupture is by a ragged lateral slit, opened by the straightening annulus (Fig. 316).

The sorus originates as a smooth upgrowth from the lower surface of the pinnule, opposite a nerve, a considerable number of cells being involved from the first; no definite mode of segmentation has been recognised (Fig. 317 F). As development proceeds, the margin of the upgrowth extends all round, as the overarching indusium (*i, i'*); this, undergoing a somewhat regular segmentation by anticlinal walls, curves so as to cover in the sporangia which arise below (*s.*, Fig. 317 F); the indusium thus precedes the appearance of the sporangia, as in many other indusiate Ferns. The sporangia originate from single cells, which have commonly a square base, though it may be a question whether this is always so. The segmentation is by walls inclined to one another; the first wall is usually on the side next

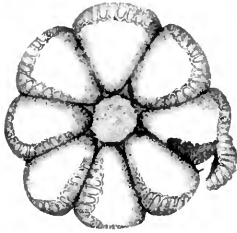

FIG. 316.

A sorus of *Matonia pectinata* from which the indusium has been naturally detached. (After Seward.)

to the leaf-surface, and meets one of the lateral walls of the parent cell: then follow three other inclined walls, and the segments thus produced surround a central triangular wedge-shaped cell, from which finally the cap-cell is cut off in the usual way (Fig. 317 E).

The further segmentation of the central cell follows the course usual for Leptosporangiate Ferns; a double tapetum is formed (Fig. 317 D) of which the inner cells become greatly enlarged, and their nuclei, clustering round the sporogenous group of cells, and undergoing fragmentation, present an appearance very like that in *Gleichenia*; the archesporium divides into 16 spore-mother-cells, and the typical number of spores seems to be 64; countings of mature spores gave figures between 48 and 64 as the produce of single sporangia. Sections of sporangia, when cut so as to traverse the annulus throughout its course, show the wall as a single layer, but composed of more numerous cells than is the case in many of the Leptosporangiate Ferns (Fig. 317 D); this is also brought out plainly in views of the mature sporangia from without (Figs. 317 A, B, C). It may be noted further that the stalk, which remains very short, is rather massive, and consists of a peripheral series of six or seven cells, surrounding a central cell (Fig. 317 A), which corresponds to the structure of the stalk in the massive sporangia in *Gleichenia* and *Osmunda*.

The mature sporangium is a body of rather irregular and variable form, owing apparently to pressures in the developing sorus. The annulus is incomplete and variable in position; it consists of a series of large cells, 20 or more in number, which takes an oblique and sinuous course, corresponding in the main to that in *Gleichenia*. The sporangia are liable to be tilted right or left, as shown in Fig. 317 B, which represents two sporangia *in situ*, as seen from the side facing the indusium.

Sporangia in which the annulus is not tilted are shown in Figs. 317 A, C; from these it will be seen that the annulus starts close to the stalk; it first curves downwards towards the basiscopic side of the sporangium, then circling round it, curves upwards, the highest point being reached at the distal end of the sporangium; passing this it again curves downwards towards the basiscopic side, and stops short at some distance from the stalk; it is at this point that the dehiscence takes place, but though the cells immediately beyond the end of the annulus may show some regularity of division, there is in *Matonia* no highly specialised stomium as is the case in most Leptosporangiate Ferns. Fig. 317 (the central

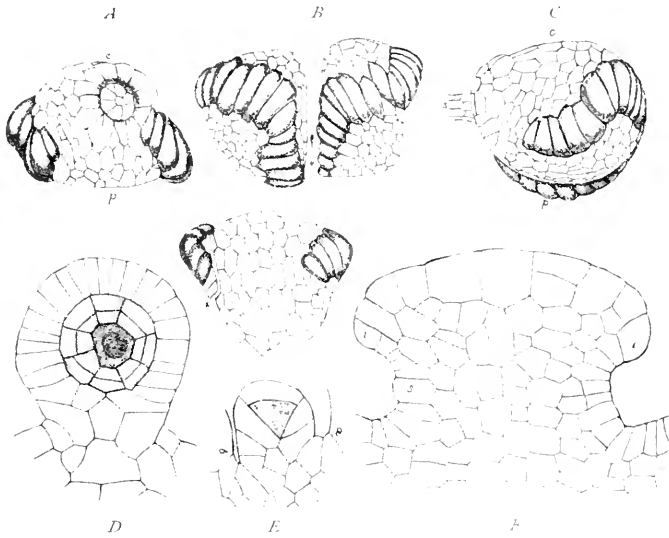

FIG. 317.

Matonia pectinata. A, B, C and the central figure represent the mature sporangia in various aspects. F=young sorus; i, i=indusium; s=sporangium. E=sporangium with cap-cell; a=aerospic. b=basiscopic side. D=sporangium with tapetum doubled. A-C $\times 50$. D-F $\times 200$.

figure) shows the rupture; it also shows a case of the annulus stopping short of the stalk on either side, and that there is not here any continuous series of non-indurated cells, such as that seen in *Loxsonia*.

Thus *Matonia* has a sporangium with a short and massive stalk and a large head, in which the annulus is not of a highly specialised, nor even of a constant type, though in its main features it corresponds to that of the Gleicheniaceae. It differs here, however, in its variability, its lateral dehiscence, and in the comparatively small output of spores.

Of the fossil Matonineae the sori are best known in *Laccopteris*, which is practically identical with *Matonia* in the size, disposition, and structure of the sporangia and spores, but differs in having apparently no indusium (Fig. 318). Probably, however, the sori of *Matonidium* and of *Microdictyon*

were indusiate, as in *Matonia* itself. The difference does not seem to be an essential one, and in face of the correspondence of the Ferns in question in other respects it cannot be held to invalidate the reference of these, and of certain other Mesozoic Ferns to the family of the Matoniaceae.

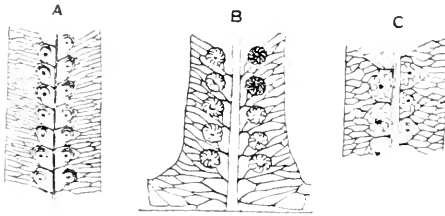

FIG. 313.

A = pinnule of *Luccopteris Woodwardi* from the inferior oolite of Yorkshire: the hemispherical bosses show the position of the sori (No. 217, Brit. Mus.). B = pinnule of *Luccopteris polypodioides* with sori and soral impressions. Upper shale, Gristhorpe Bay (No. 2522, Brit. Mus.). C = pinnule fragment from the inferior oolite of Stanford (No. 52367, Brit. Mus.). (After Seward, from drawings by Miss G. M. Woodward.)

how the final condition was probably arrived at. In the most complex rhizomes three concentric vascular rings may be found embedded in parenchyma, and each showing the typical solenostelic structure. Each is limited externally and internally by an endodermis and pericycle, while between these in each is a continuous ring of xylem, with phloem on either side of it. The arrangement of this solenostelic structure is represented diagrammatically in Fig. 319, together with its connections with the leaf-trace. The latter is in these Ferns one continuous band, with involuted margins, which are shown in Fig. 319 C: this drawing also indicates that foliar gaps occur, and shows how the leaf-trace is directly continuous with the outer and middle of the concentric rings at the node. There may also be a connection with the inner ring; but this occurs at some little distance from the actual node, and so is not shown in the drawing. The result is that the whole system is connected, but only at intervals of its whole length, while there is also connection through the leaf-gaps between the parenchymatous tracts in which the cylinders are embedded.

The ontogeny gives the suggestion how this complicated structure is to be placed in relation to that of other Ferns. The young axis contains at first a slender protostele; but this simple stele soon expands, and a strand of phloem appears in the midst of the xylem. This internal phloem appears to be a phloem-pocket decurrent from the adaxial surface of the second leaf, but there is as yet no true leaf-gap. The stele soon widens into a solenostele with internal endodermis and central parenchyma. Meanwhile at the nodes a ridge of xylem projects internally, which becomes more prominent at subsequent nodes, and is continued forwards into the internode further and further at successive nodes, till that of one node eventually connects with a similar xylem-dilatation of the next node (Fig. 319 A). A continuous central strand is thus produced, which is connected at the nodes with the outer cylinder.

ANATOMY.

The mature rhizome of *Matonia* shows the most complicated solenostelic structure known in Ferns: in the young stem, however, simpler conditions are found which suggest

The process thus described may then be repeated in that central strand: it becomes cylindrical, forming the second vascular ring, which is still connected at the nodes with the foliar system (Fig. 319 B), and a fresh central strand originates internally from it: this in its turn becomes cylindrical in the most advanced types, but still maintains its connection with the middle and outer rings in the neighbourhood of the nodes. The whole development is in fact an extreme type of the progression described by Gwynne-Vaughan in other solenostelic Ferns.¹ He showed how an internal vascular system may arise by progressive elaboration from a local thickening of the margin of the leaf-gap of the original solenostele. In *Matonia* this development is the same, but it may be twice repeated.

It is indicated by the palaeophytological evidence that while the *Matonia*-type is an ancient one it is not among the earliest. This accords with the soral and anatomical characters: for the sorus, though of the *Gleicheniaceae* type, and still forming its sporangia simultaneously as in other *Simplices*, shows an advanced feature in the indusium, as also in the lateral dehiscence, and small spore-output. Anatomically the indications are of the same nature: *Matonia* accords with *G. pectinata* in the solenostelic structure, but carries that line of elaboration much further. Finally, in the rhizomic habit and in the branching of the leaf there appears to be further similarity: there is indeed sufficient reason to regard the Matonineae as a family related to the *Gleicheniaceae*, but advanced in several respects beyond that type, in directions which are represented more fully in other series of Ferns.

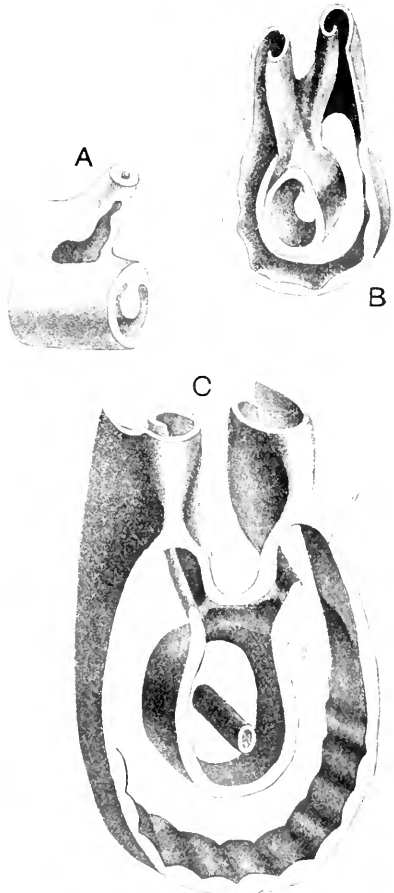

FIG. 319.

Matonia pectinata, drawings from wax models of the stelar system. A— from a young stem showing node. B— from an older stem, showing node seen from behind. C— still older node, seen from in front. A · 25. B · 12. C · 10. (After Tansley and Lulham.)

¹ *Ann. of Bot.*, xvii., p. 703.

CHAPTER XXXVII.

GRADATAE.

THE Ferns so far described, however different in detail, all correspond in producing those sporangia that are in near juxtaposition *simultaneously*: the sporangia themselves are of large size, with short, usually massive stalks. The output of spores per sporangium is commonly in excess of that in other Leptosporangiate Ferns. *Matonia* is, however, an exception to this, having not more than 64 spores: as also in its dehiscence, which is lateral, while in all the rest it is in a median plane. But notwithstanding these discrepancies, in the fact that the sporangia are simultaneously produced, as well as in other features, the Matonineae find their natural place with those Ferns which have been styled the Simplices.

We shall now proceed to types in which the sporangia appear not simultaneously, but in basipetal succession: these have been styled the Gradatae. In them the position of the sorus may vary, as indeed it does in those with simultaneous sporangia: while the Marattiaceae, Gleicheniaceae, and Matonineae have superficial sori, the sporangia of the Schizaeaceae may be marginal: in the Osmundaceae the sporangia may be on the lower surface only (*Todea*) or cover both surfaces and margins (*Osmunda*). So also we shall find similar variations of position in the basipetal sori: the Loxsomaceae, Hymenophyllaceae, Dicksoniaceae, and Dennstaedtiinae all have marginal sori, while in the Cyatheaceae they are superficial. Such difference of position may serve as a useful character separating the tribes, but need not in any way vitiate our comparisons. In other words, the method of internal arrangement of the sorus is to be estimated as a more important character than the exact position which the sorus holds upon the leaf which bears it. It will be seen that while the basipetal succession in the sorus is taken as the defining character of the Gradatae, other characters indicate a higher position, but none with the same distinctness, and in many features these Ferns resemble the Simplices. There is reason to think, therefore, that they originated from some similar common stock, but adopted the basipetal succession of sporangia at a relatively late stage.

This is biologically probable, since the successive development has the advantage of producing a large spore-output, while the physiological drain would thus be spread uniformly over a long period of time.

LOXSOMACEAE.

This family is represented only by the single species *Loxsoma Cunninghamsi*, Br., native in New Zealand. It unites in itself characters of several distinct tribes of Ferns, and as a consequence its systematic position has been difficult to fix. It has the habit of a coriaceous *Dicksonia* or of a *Davallia*, and a sorus like *Trichomanes*; but it differs from all of these in having a dehiscence of the sporangia in a median plane. This combination of characters has led to its being variously placed by different systematists. It is best regarded as the sole representative of a distinct tribe, and its natural position appears to be about the limit between the Simplicies and the Gradatae, in a phyletic line which leads towards the Hymenophyllaceae and Dicksonieae.

L. Cunninghamsi is an elegant Fern, with elongated, creeping rhizome, bearing irregularly disposed roots, and at intervals of about an inch firm coriaceous leaves, one to two feet high, which are glabrous, twice or thrice pinnate, and glaucous beneath. The sori are marginal, each seated upon the ending of one of the simple or branched veins. There is a basal cup-shaped indusium, with an entire rim: it surrounds the receptacle, which is columnar, and bears numerous fluffy hairs interspersed among sporangia, which originate in a basipetal succession. The whole appearance of the Fern is very like some of the creeping species of *Dicksonia* or *Davallia*.

I am not aware of any fossils having been attributed to this family.

SPORE-PRODUCING MEMBERS.

A vertical section through a sorus of medium age shows, as in Fig. 320 E, the short receptacle, sporangia, and hairs, all of which are included within the cup-like indusium; there is an obvious basipetal sequence of the sporangia. The orientation of the sporangia relatively to the centre of the sorus is constant, on the Gleicheniaceae type. The pear-shaped sporangia, which rise obliquely upwards, have a complete annulus, as is shown in Fig. 320 D, which represents the "peripheral" face; but though the complete series of cells of the ring can usually be traced, the induration of the walls is very unequal; commonly the cells of the distal half are enlarged, and their walls thickened; these are mechanically functional, while the lower part may be composed of thinner-walled cells, sometimes slightly or irregularly thickened, but usually not differing from the rest of the cells of the wall, except in their form and arrangement. This is shown in side view in Fig. 320 C. If we compare Figs. C and D with drawings

of *Gleichenia*, it is plain that the sporangia are of the same type, as regards the position of the annulus, though differing in the details; or the comparison might be extended to the Schizaeaceae on the one hand, or the Hymenophyllaceae on the other, as regards the position of the annulus.

The longitudinal slit of dehiscence traverses the distal part of the annulus, following the median plane of the sporangium, and may extend



FIG. 320.

Loxsoma Cunninghami, Br. E=young sorus with sporangia still protected by indusium (i, d). A=sorus rather older, with sporangia (s, s) carried up on the elongated receptacle (ps). B=vertical section of the base of the young receptacle (r) showing sporangia (s) in basipetal sequence. C, D=mature sporangia showing the incompletely indurated annulus, and distal point of dehiscence (tr). A and E×about 20. B×250. C and D×50.

some distance down its peripheral side, so that it faces outwards from the receptacle.

The orientation of the sporangia being strictly upon the Gleicheniaceae type, it appears that the main difference is that, while maintaining the same position of the annulus, the slit gapes towards the peripheral face of the sporangium rather than on the central side of it. There is no differentiation of a stomium, but the rupture occurs regularly at the distal end (x, Fig. 320 D). The portions of the annulus on either side of the slit straighten as they dry and curve outwards in the usual way; they may even become reflexed, tearing away irregularly from the rest of the wall, or carrying fragments of it outwards; in this state the two flaps may appear like the covers of an open book. As the induration stops short about half-way down the side, the general form of the sporangium is

not altered by the dehiscence, so as to press upon or displace neighbouring sporangia; in fact, no elbow-room is required, as in *Gleichenia*, and this is a distinct advantage in a sorus where sporangia are numerous; in this we may perhaps see the *rationale* of the incomplete annulus. No sudden jerks of the annulus have been observed, nor would such jerks be very efficient, since the majority of the spores lie below the flaps of the annulus; the shedding of the spores seems to be mainly on the principle of the pepper-box.

The receptacle performs an important part in connection with dispersal. At first it is short, so that the sporangia are all included within the indusium (Fig. 320 E), and this is so till the oldest sporangia are mature; an intercalary growth then takes place at the base of the receptacle, the thin-walled cells above the terminal mass of tracheids (*tr.*) become greatly elongated (Fig. 320 A), forming a sort of pseudopodium (*ps.*), upon which the sporangia are raised so as to project beyond the lip of the protective indusium, and are thus free to scatter their spores. The arrangement is similar to that seen in the Hymenophyllaceae, but in *Loxsonia* the pseudopodium is formed independently of the long-continued formation of a series of sporangia.

The sporangium makes its first appearance as a massive deeply sunk cell, near the base of the groove between the receptacle (*r*) and the indusium (*ind.*) (Fig. 320 E): the first segmentation in it passes down to the base of the cell, as in the Schizaeaceae and some other Simplices; the later ones cut the previous wall obliquely, and thus a three-angled conical cell is surrounded by three lateral segments. The cap-division, and segmentations forming the tapetum take place in the usual way; the inner series of tapetal cells enlarge considerably, and become polynucleate, thus resembling other large sporangial types. The definite sporogenous group is composed of 16 spore-mother-cells, which undergo a tetrad division to give typically 64 large spores.

ANATOMY.¹

The chief point of anatomical interest is the structure of the stele of the stem: a transverse section of an internode shows a typical solenostele, with phloem, pericycle, and endodermis, both outside and inside of the continuous ring of xylem. The protoxylem elements are all scalariform, and are not localised into groups, but are distributed around the periphery of the solenostele. Where a leaf-trace is given off the tube of the stele opens, forming a foliar gap on the acroscopic side. The leaf-trace itself consists of a single vascular strand,

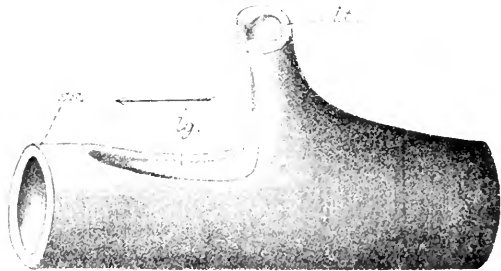

FIG. 321.

Loxsonia Cunninghamii. Diagram showing the form of the vascular system at the node of the rhizome. *st* = solenostele; *lt* = departing leaf-trace; *lg* = leaf-gap. The arrow points toward the apex of the rhizome. (After Gwynne-Vaughan.)

showing the horse-shoe outline in transverse section (Fig. 321). An unusual feature is the occurrence of islets of parenchyma in the sclerenchymatous masses of the stem, a peculiarity shared with certain species of *Dicksonia*.

¹Gwynne-Vaughan, *Ann. of Bot.*, vol. xv., p. 71.

These features indicate that *Loxsonia* is more nearly related anatomically to the Dicksonieae and Dennstaedtiinae than to any other family of Ferns; but a reasonable analogy is also to be found with the more advanced species of *Gleichenia*: the solenostelic structure seen in *G. pectinata* as well as the origin of its foliar trace are points for comparison, while structural affinities of a more remote nature are also indicated with the Schizaeaceae and Hymenophyllaceae.

It thus appears that *Loxsonia* is a generalised type, while its rare and local occurrence countenances this view. In habit it shows similarity to such genera as *Dennstaedtia*, *Microlepia*, and *Davallia*, a comparison which finds support in the anatomy of the vascular system: not only do the habit and anatomy support this, but also the form of indusium and receptacle, and the basipetal succession and orientation of the sporangia. An affinity with the Hymenophyllaceae is also unmistakable, but probably not so close as has often been assumed: against it are the texture of the leaf, the mode of dehiscence and the structure of the sporangium, and the low output of the very large spores: in any case the affinity is with the less specialised types (e.g. *Hymenophyllum dilatatum*) rather than the more specialised (e.g. *Trichomanes*). The sporangium, and its annulus and dehiscence point clearly towards the Gleicheniaceae and Schizaeaceae; and though the habit of the leaf is different from these Ferns, the structure of the creeping rhizome shows a certain resemblance. The similarity of position of the annulus, and constancy of orientation are important, especially when taken with the very peculiar facts of induration. For, as we have seen, the distal side of the annulus is indurated, while the proximal can still be followed, though it is commonly thin-walled; but occasionally single cells, or groups of cells, of the proximal side are also indurated: these cannot be functionally active, since they do not form a connected series. In them I think we can only see a decadent vestige of a completely indurated annulus, and conclude that *Loxsonia* was derived from ancestors with a complete oblique annulus, probably with a median dehiscence. Such ancestry might be found in the neighbourhood of *Gleichenia*. In *Gl. dichotoma* we have a type in which the sporangium and the sorus are similar in their main character. If we imagine these sori to be marginal (as they are in *Lygodium*), surrounded by a cup-like annulus which is already suggested in some *Gleichenias*, with the annulus modified as explained above to suit the more crowded sorus, and with a smaller number of spores, balanced by a larger number of sporangia produced in basipetal order, the sorus of *Loxsonia* would be before us. It is not suggested that any living *Gleichenia* was a progenitor of *Loxsonia*, but *Loxsonia* appears to be a link connecting the *Gleichenia*-*Schizaea* affinity with the type of *Dennstaedtia* and *Microlepia*. It should be regarded as the sole representative of a distinct tribe: the attempt should not be made to force it into any other tribe of living Ferns.

HYMENOPHYLLACEAE.

This family includes only the two genera, *Hymenophyllum* and *Trichomanes*, but each is represented by a large number of species, distributed



FIG. 122.

Habit of *Hymenophyllum*. A=*H. cruentum*, Cav. B=*H. dilatatum*, Sw. C=*H. australe*, Willd. (After Sadebeck, from Engler and Prantl, *Nat. Pflanzenfam.*)

chiefly in moist and shaded spots throughout the tropics: they extend as stragglers northwards, though more freely to the south, and there is a special centre of their distribution in New Zealand.

The shoot is sometimes upright and radial, with leaves showing $\frac{2}{5}$ ths phyllotaxis, as in some species of *Trichomanes*; or more commonly creeping and dorsiventral, with the leaves arranged distichously, with elongated internodes, as in many species of *Trichomanes*, and all of *Hymenophyllum*. From the axis numerous scattered roots arise in most species, but in some, and especially in the section *Hemiphlebium* of *Trichomanes*, no adventitious roots are formed, leafless branches of the rhizome serving as substitutes. These are covered by root-hairs, which resemble, however, the hairs which are normally found on axis and leaf in the rooted species also. The hairs are filamentous, andramenta are absent, but peculiar scales are found in some species of *Trichomanes*, and in some of *Hymenophyllum* of exposed habit the leaf is covered with a hairy felt.

The leaves in some of the larger species (*H. dilatatum*, *australe*) conform in outline to ordinary branched Filicenean types, and are winged structures to the base (Fig. 322). But in other cases the leaf may appear as a widened expansion of simple form, with or without a leaf-stalk (Fig. 323), as in *H. cruentum*, or *T. reniforme*, and *membranaceum*. It would appear probable that the latter are specialised and derivative forms, and they occur more freely in the genus *Trichomanes*, which there is good reason to believe to be the more specialised genus. The leaves are translucent or "filmy" in texture, a feature that will be considered at length below.

Axillary branches occur very generally in the Hymenophyllaceae, but at many nodes the rudiment of the axillary bud remains undeveloped.

The sori are marginal in all cases: the receptacle upon which the sporangia are inserted in strictly basipetal sequence is traversed by the direct continuation of one of the veins of the lamina: it is surrounded by the cup-like indusium, which is entire in *Trichomanes*, but two lipped in *Hymenophyllum*. The sporangia vary greatly in size and productiveness, but have uniformly an oblique annulus and lateral dehiscence: it will be seen that these characters are closely related to the regular basipetal sequence in which they are produced upon the receptacle.

Sori and sporangia of corresponding type have been traced back to early geological formations. From the upper Carboniferous, or perhaps even earlier, come the doubtful sporangia of *Hymenophyllites*, which will be considered in detail below. Meanwhile it may be noted that there is reason to believe the type to have been a very ancient one.

SPORE-PRODUCING MEMBERS.

The comparative study of the sori of the Hymenophyllaceae leads to the conclusion that while these Ferns show the highest complexity of the receptacle, the sporangia themselves are related in character to more massive types, and that this will justify a systematic position near to the Loxsomaceae, Dicksoniaceae, and Gleicheniaceae on the

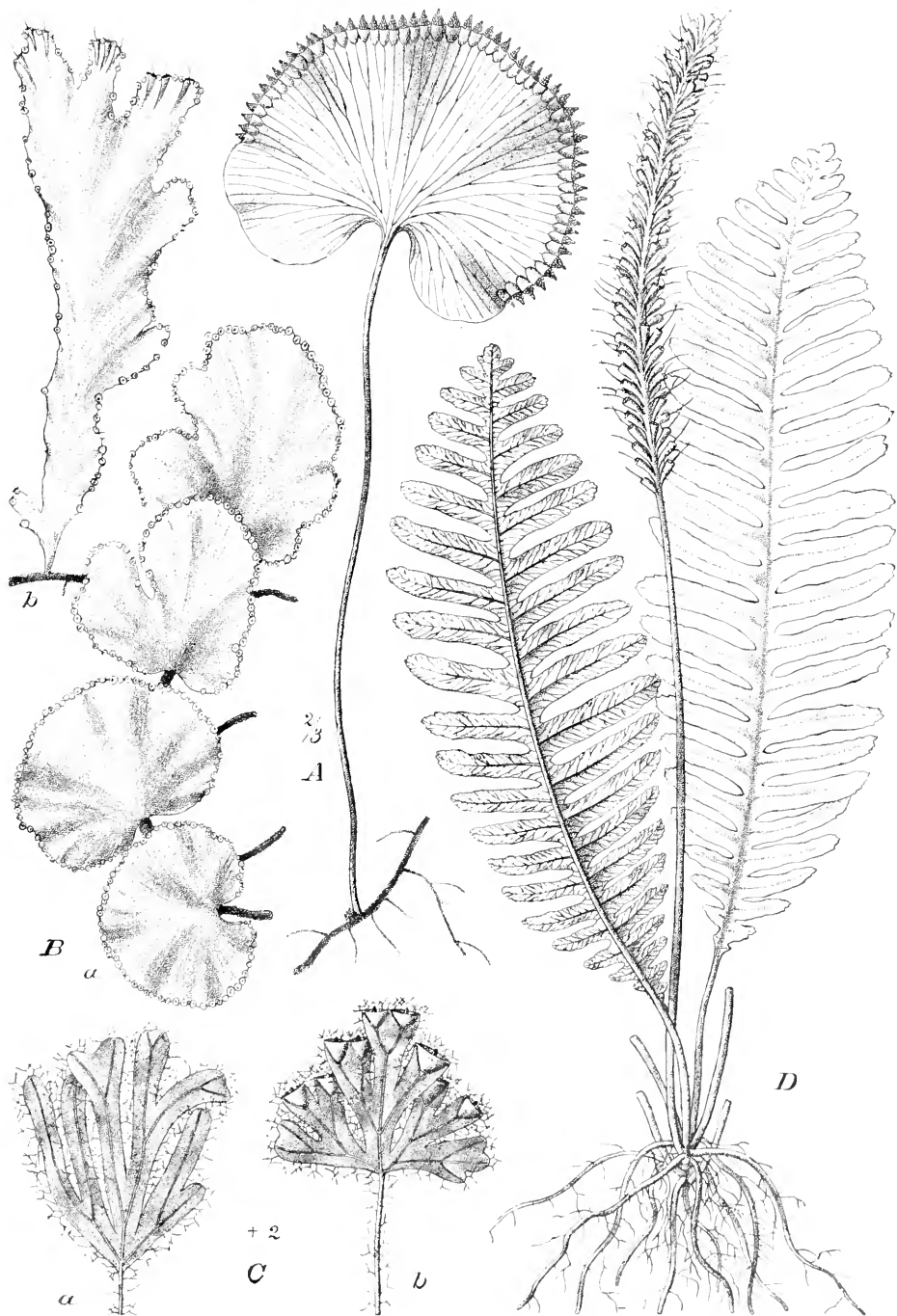

FIG. 123.

Habit of *Trichomanes*. A = *T. reniforme*, Forst. B = *T. membranaceum*, L. a, sterile; b, fertile. C = *T. Lyallii*, Hook. a, sterile; b, fertile. D = *T. spicatum*, Hedw. (After Sadebeck, from Engler and Prantl, *Nat. Pflanzenfam.*)

one hand, and on the other to the Osmundaceae and certain of the early fossils. The general construction of the Hymenophyllaceous sorus is well known. Many satisfactory drawings are given by Presl, and

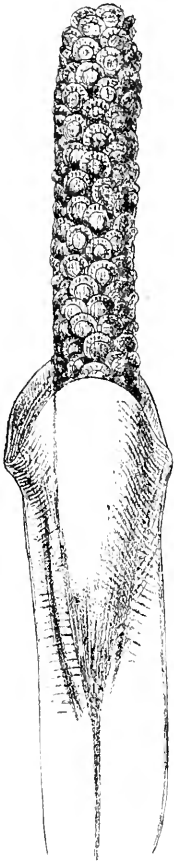

FIG. 324.

Trichomanes tenerum. Sorus in surface-view; the placenta bearing radially distributed sporangia issues from the two-lobed beaker-like indusium. The annulus is visible on the several sporangia. Magnified. (After Goebel.)

other descriptive writers, which show how the sporangia with their oblique annulus are disposed with regularity of orientation upon the elongated receptacle, so that they overlap one another like the shields of a Roman *testudo*. The orientation for each single sporangium corresponds essentially with that seen in *Gleichenia* or *Loxsona*. This is well shown for *Trichomanes* in the drawing of Goebel (Fig. 324). The sporangia are produced in basipetal succession upon the more or less elongated receptacle. This fact is demonstrated in Fig. 324 bis, which represents the young sorus of *Hymenophyllum Wilsoni* already bearing the young sporangia (*s*) near the apex of the receptacle, while below there are clear indications of the active intercalary growth. The extent of the intercalary growth of the receptacle is greater in *Trichomanes* than in *Hymenophyllum*, and the genera were by early writers distinguished on this ground, those with the receptacle exerted being ranked with the former, while those with it included fell into *Hymenophyllum*. Though this generic distinction will not hold accurately, still the general statement is correct that intercalary growth of the receptacle, and basipetal succession of the sporangia are longer continued in *Trichomanes*; it is the extreme example of this mode of development of the sorus among Ferns, but none the less it is similar in kind to that described for other Gradatae.

The sporangia in the Hymenophyllaceae differ greatly in size, between a large, almost spherical type, such as that of *Hymenophyllum dilatatum* (Fig. 325, Nos. 95, 96, 97, 98), and small compressed bodies such as are formed in many species of *Trichomanes* (Fig. 325, Nos. 99, 100, 101, 102); it will be shown that with this goes a very wide difference in the output of spores. The large

sporangia of *Hym. dilatatum* are produced in relatively small numbers upon the short, but rather broad, receptacle; in size and form they are comparable to those of *Gleichenia circinata* (compare Fig. 325, No. 95, with Fig. 310 *i* of *Gl. circinata*), while the annulus shows a similar degree of obliqueness. Externally there is close similarity, excepting in the dehiscence, which is lateral in *Hymenophyllum*, a position which we shall see

later may be correlated with the close packing of the sporangia in the sorus. The view of the sporangium from the side on which dehiscence takes place shows that the annulus is not continued throughout as a distinct series of cells (Fig. 325, No. 96); but there is no definite group of cells of the stomium: this feature is again comparable to that in *G. circinata*. The drawings of the central and peripheral faces (Fig. 325, Nos. 97, 98) will complete the knowledge of the external form of the sporangium in this species. The stalk is short and rather thick, and the insertion is by a rosette of cells, some six in number.



FIG. 324 bis.

Hymenophyllum Wilsoni, Hk. Sorus in longitudinal section showing the receptacle with divisions indicating intercalary growth, and the first sporangia originating near the apex. $\times 100$.

For comparison with the sporangium of *Hymenophyllum*, that of *Trichomanes radicans* is represented in Fig. 325, Nos. 99-102, as seen from four different points of view. No. 101 shows the sporangium presenting its central face; the close analogy with No. 97 of *Hym. dilatatum* is obvious, though it is smaller in size, and with fewer cells in the annulus; but fluctuations less in extent though similar in nature are found in *Tr. radicans* itself, the cells of

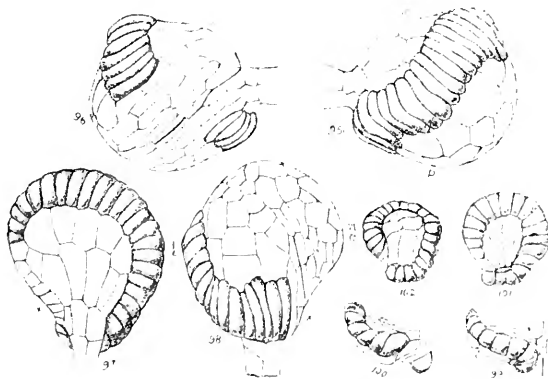

FIG. 325.

Nos. 95, 96, 97, 98 = Sporangia of *Hymenophyllum dilatatum*, Swartz, seen respectively from the two sides (Nos. 95, 96), and from the central (No. 97), and peripheral (No. 98) faces. Nos. 99, 100, 101, 102 = similar figures, to the same scale of *Trichomanes radicans*, Swartz. Nos. 99 and 100 show the lateral views. No. 101 shows the central, and No. 102 the peripheral faces. All $\times 50$.

the annulus varying between 20 and 25. There is also a greater simplicity in the region of the stomium, which in *Trichomanes* is represented by two cells only. No. 102 represents the "peripheral" face, the thin-walled region being surrounded by the annulus, which takes the form of a twisted hoop. This twisted form is clearly shown in No. 99, which demonstrates also the relation

of the sporangium to the receptacle, and that the distal part of the annulus is directed obliquely towards its apex. This being the case for all the sporangia, the free action of the annulus on dehiscence is assured for each individual sporangium; this may be compared with No. 95 of *Hym. dilatatum*. The stomium in *Tr. radicans* is of very simple construction: in the last of the drawings it is shown in surface view, with the slit of dehiscence gaping between the two cells. Comparing this with No. 96 of *Hym. dilatatum*,



FIG. 326.

Trichomanes speciosum, Willd. (= *T. radicans*), transverse section of the receptacle, showing early segmentation of the sporangia. (After Prantl.)

see again that *Trichomanes* is constructed on the same general plan, of which it appears as a simplified edition.

The origin of the sporangium has been followed by Prantl¹ in *Trichomanes speciosum*, with which that of *Hymenophyllum* agrees in essentials. The parent cell has a square base, and grows out into a papilla, with segmentation according to the usual Leptosporangiate type; but it is important to notice that the first segmentation strikes the basal wall of the parent cell (Fig. 326), a condition which is seen in the massive sporangia of the Simplices rather than in the more advanced Ferns.

The comparison thus suggested with the Fern-types which have large sporangia is borne out by the facts which follow from enumeration of the spores produced. The Hymenophyllaceae show among their species a wider range of number of spores per sporangium than has been noted for any other family of Ferns: while certain of their species approach, or even equal the high numbers of the Gleicheniaceae, Schizaeaceae, and Osmundaceae, in others the number is distinctly low: it will be seen that the species of *Hymenophyllum* give for the most part a higher output per sporangium than *Trichomanes*.² The typical number for *H. Tunbridgense* was found to be 256-512, and for *H. sericeum* 256, while that of *H. dilatatum* and *Wilsoni* was 128: but for six species of *Trichomanes* examined the typical numbers varied from 32 to 64. *Trichomanes reniforme*, however, which is in many respects an isolated and peculiar species, has the typical number of 256, thus corresponding to *Hymenophyllum* rather than to its own genus.

Seeing that in *Trichomanes* the usual output per sporangium is lower

¹ *Hymenophyllaceae*, p. 38.

² For full details see *Studies*, iv., p. 64.

than in *Hymenophyllum*, while on the other hand the receptacle is usually longer, and has more continued intercalary growth, the question arises whether the larger number of sporangia will approximately compensate for their lower individual output. A computation was made of the output per sorus in *H. Tunbridgensis* and *dilatatum*, and compared with a similar computation in *T. reniforme* and *radicans*, with the result that, notwithstanding the great variations in spores per sporangium, the output per sorus appears approximately uniform for the cases quoted. Thus the increased length of the receptacle and higher number of the sporangia tends to compensate the smaller output per sporangium which is seen in its extreme form in some species of *Trichomanes*.

It has been seen that in *Gleichenia*, where there is a median dehiscence of the sporangium, elbow room is required for the process of mechanical ejection of the spores, and that this is only possible where the sporangia are loosely arranged. In a crowded sorus such as that of the Hymenophyllaceae the necessary space is not available. In *Loxsonia* this difficulty is met by the incomplete development of the annulus, which then merely opens the distal end of the sporangium and allows the spores to be shaken out. But in the Hymenophyllaceae the whole mechanism is altered by the adoption of the oblique lateral dehiscence: as this is usual in the basipetal sori of the Gradatae it demands the greater attention. The sporangia are placed relatively to one another as seen in the diagram (Fig. 327), in which the cells of the annulus traversed in the median section of the sporangium are indicated by heavier lines. It is plain that on dehiscence taking place laterally, the distal side of each annulus has freedom to alter its form independently of the adjoining sporangia:¹ the oblique position of the annulus thus finds a practical explanation, and is even a necessity where the sporangia are short-stalked and imbricate. The dehiscence is, however, aided by its occurring usually in strict basipetal sequence in the Hymenophyllaceae: after the lateral slit is formed, the annulus is first of all reflexed, and then recovers with a sudden jerk, which often dislodges the whole sporangium, and scatters the spores. The result in *Trichomanes* is that the distal end of the receptacle may remain bare of sporangia, an indication of the extent of the intercalary growth, while young sporangia may still be found around its base.

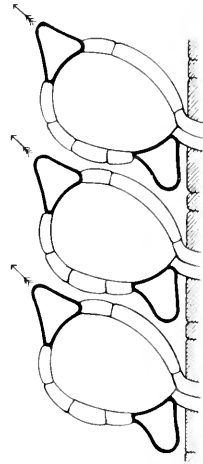

FIG. 327.

Diagram illustrating the relative position of the sporangia on the receptacle in the Hymenophyllaceae. It was constructed from Prantl's section of a mature sporangium of *Trichomanes Speciosum*.

¹As a matter of fact the freedom is greater than is shown in the diagram, for the sporangia alternate, and are not disposed in closely consecutive orthostichies.

Various fossil fructifications from early geological formations have been referred to the Hymenophyllaceae with more or less reason. The Devonian *Palaeopteris hibernica* may be put aside as insufficiently known, while it shows no distinct evidence of Hymenophyllaceous affinity: moreover, the presence of its stipules is against it. In *Hymenophyllites Weissii*, Sch., figured by Schimper from the coal of Saarbrucken, the reference is chiefly upon the sorus as a whole, while the sporangia themselves were not distinguished, or described in detail. Perhaps the best authenticated case is that of *Hymenophyllites delicatulus* (= *H. quadridactylites* (Gutb. Zeiller), described and figured by Zeiller.¹ Here the sori were borne on the distal ends of the pinnules: he was also able to recognise and draw the sporangia, with an oblique annulus, which corresponds very closely with that of a modern Filmy Fern. The original specimens were examined by Solms-Laubach, who concluded that the fact is correctly stated, and no other interpretation of the figures is possible.² Scott, however, remarks³ that the evidence as to the position of the reproductive organs on the leaf is not sufficient to place the affinities of these fossils beyond doubt.

It must be admitted that the evidence of existence of Hymenophyllaceous fructifications from the Primary rocks is insufficient. It does not, however, appear essential to the position to be ascribed to the Hymenophyllaceae below that their early existence should be established, though their occurrence even in the primary rocks would readily accord with the view here entertained of their origin from the protostelic Simplices.

ANATOMY.⁴

The most obvious structural peculiarity of the Hymenophyllaceae is the "filmy" texture of their leaves: the lateral wings throughout are pellucid owing to the absence of intercellular spaces, while there are no stomata upon them. Usually the flattened region consists of only a single layer of cells, though in some cases, such as *T. reniforme* and *H. dilatatum*, there may be three or four layers, but still without intercellular spaces. The question naturally arises whether this filmy character is primitive or the result of special adaptation. In Prantl's view it was held to be primitive, and indicated an affinity with the Mosses; but there are many reasons for rejecting this, and seeing in the simple structure a specialised and reduced character. It is plainly suited to the moist habitats in which the Hymenophyllaceae mostly live: while on the other hand quite a number of Ferns living in moist surroundings, but of divers affinity, show the same character in varying degree: it is seen in *Danaea crispa*, Endres, and in *D. trichomanoides*, Spruce, MMS.; but in these several layers of cells are present, with intercellular spaces: it is seen in various degrees in the *Leptopteris* section of *Todea*, and most clearly in *T. superba*: also in

¹ *Ann. Sci. Nat.*, Ser. 6, vol. xvi.

² *Palaeophytology*, p. 157.

³ *Studies*, p. 264.

⁴ See Boodle, *Ann. of Bot.*, xiv., p. 455, where the literature is fully referred to.

Asplenium resectum, Sm., and *obtusifolium*, Linn.: the existence of abortive stomata observed in some of these (e.g. *A. resectum*) indicates their reduced character. In *A. obtusifolium* two varieties have been recognised, one in which the filmy habit is fixed, and another in which stomata and intercellular spaces occur in the larger specimens, but are sometimes quite absent in the smallest, the filmy forms growing in the dampest localities. Giesenhagen¹ compares the condition of the Hymenophyllaceae with that of the fixed filmy variety of *A. obtusifolium*: he holds that as these plants have been adapted to an extremely damp habitat, so also have the Hymenophyllaceae, and the character has become hereditary, partially so in the *Asplenium* and wholly in the Hymenophyllaceae. Finally, it has been shown experimentally that a thinning of the leaf can be produced by cultivation under moisture and shade, even in some ordinary species of Ferns (*Scolopendrium vulgare*, *Pteris aquilina*), as is so frequently the case also in plants of other affinity.² From all this it may be concluded that the filmy habit is secondary and adaptive.

It would appear from their structure that *H. dilatatum* and *T. reniforme* are among the less specialised of the Hymenophyllaceae, for in them both the leaf-expansion is more than a single layer in thickness, a condition exceptional in the family. And in this connection the facts of segmentation of the young wings are interesting: in the development of the wings of the leaf in ordinary Leptosporangiate Ferns the marginal cells segment by alternating oblique walls, but in the Hymenophyllaceae the segmentation of the marginal cells is as a rule repeatedly transverse. Now, in the lower part of the leaf of *T. reniforme*, and occasionally also in *H. dilatatum* the segmentation is by oblique alternating walls, as in the ordinary Leptosporangiate Ferns, while in *Todea superba*, which is also held as filmy by reduction, there is instability between the two types, though with a preponderance of the oblique segmentation.³ These facts are further evidence that the filmy habit of the Hymenophyllaceae has been secondarily acquired, while they indicate an intermediate position for *Todea superba*, and for *H. dilatatum* and *T. reniforme*.

The filmy character is accompanied by structural reduction of other parts: thus in certain leaves pseudo-veins are present⁴ which can hardly be anything else than the vestigial remains of true veins no longer functional. Cognate with this is the fact that the root-system is reduced, and even entirely absent in some species. It may then be expected that the vascular system of the axis and leaf will also show signs of reduction as compared with other Fern-types: an examination of them shows that this surmise is correct.

The stem of the Hymenophyllaceae is monostelic, and one leaf-trace passes off to each leaf, while the vascular supply to the axillary bud is

¹ *Flora Ergänzungsband*, 1892, p. 174.

² Boodle, *Linn. Journ.*, vol. xxxv., p. 959; J. H. M-Hroy, *Trans. Roy. Phil. Soc.*, Glasgow, vol. xxxvii., p. 136.

³ Bower, *Ann. of Bot.*, vol. iii., pp. 340-360.

⁴ Prantl, *l.c.*, p. 24.

attached to that of the leaf-trace. The stele varies considerably in its construction in different species: in *Hymenophyllum* there is less variation than in *Trichomanes*. In all cases the stele lies centrally, and is delimited by the endodermis, followed by a broad pericycle, while the phloem surrounds the centrally-lying xylem. In species of *Hymenophyllum* with large rhizomes, such as *H. scabrum* or *dilatatum*, the metaxylem forms a ring enclosing the protoxylem together with some parenchyma: the metaxylem often has the form of two bands, their definition having relation to the origin of the strands which pass to the roots (Fig. 328; Boodle, Fig. 10). In species with small rhizomes the metaxylem

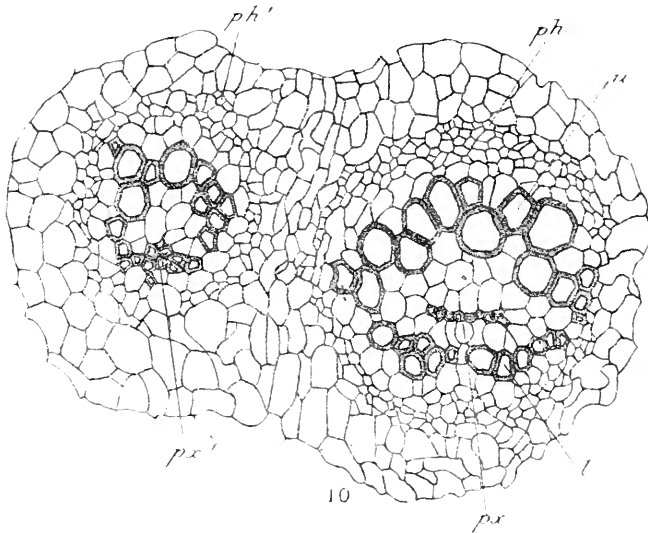

FIG. 328.

Transverse section of a node of *Hymenophyllum dilatatum* s. *Forsterianum*. Stele of rhizome to the right, leaf-trace to the left. *ph* = phloem; *px* = protoxylem; *l* = lower xylem-bands; *u* = upper xylem-band. $\times 200$. (After Boodle.)

forms a small band or mass, and the protoxylem is peripheral to it on the lower side: these two types are bridged by transitional forms. In *Trichomanes* the structure of the rhizome of *T. reniforme* corresponds in all essentials to that of *H. scabrum*, but with a considerable mass of parenchyma accompanying the central protoxylem. In others the parenchyma is scanty (*T. radicans*), while in *T. trichoides* the stele is sub-collateral: these types find their analogues in *Hymenophyllum*. But other species of *Trichomanes* diverge along lines of their own: thus the stele is collateral in *T. muscoides*, with the xylem downwards: others (*T. labiatum* and *Motleyi*) may have only a single tracheid, or none, and no phloem: these are plainly reduced types. Others again may show a solid mass of xylem, with scattered indefinite protoxylem (*T. spicatum*), or with the protoxylem peripheral

(*T. scandens*): there is reason to think that these, being more specialised in their general habit, have undergone secondary modification also of their stelar structure.

The petiole receives in all cases a single strand, which passes off from the stele without a leaf-gap, and widens out upwards into a collateral structure with more or less clearly curved xylem.

The comparison of this structure with that of other living Ferns leads to the recognition of no near relation. Perhaps the nearest is with the ancient family of the Botryopterideae, and especially with the genus *Zygopteris*. It will be seen that the correspondence is closest between the structure seen in *Zygopteris Grayi* (Fig. 270, p. 500), and that seen in *T. reniforme* and *H. scabrum*, that is, with the species which show the nearest resemblance to one another of the living forms of Hymenophyllaceae. The chief features of resemblance are in the structure of the stele, and the mode of origin of the leaf-trace, and of the supply to the axillary bud. As to the former, if the small central tracheides of *Zygopteris* are protoxylem, as seems highly probable, the agreement with *T. reniforme*, or the larger *Hymenophyllum* is very close, the differences being such as would be due to a $\frac{2}{3}$ ths arrangement of the leaves on the one hand, and distichous on the other. The mode of origin of the leaf-trace without any foliar gap, and the insertion upon it of the supply to the axillary bud are also points of similarity. This resemblance to a very ancient form appears to confirm the recognition of the living species named as being probably primitive, while from that central point the remaining species of *Hymenophyllum* diverged slightly in one direction, but those of *Trichomanes* diverged much more strongly along their own lines, either of reduction or of other specialisation. Such a conclusion appears to emerge clearly from the anatomical comparison.

The Hymenophyllaceae have undergone vicissitudes of classification: Brongniart first separated them as a special family, though the name of Endlicher is usually connected with their recognition as ranking on an equal footing with the Cyatheaceae or Polypodiaceae. Presl regarded them as a connecting link between Mosses and Liverworts, and somewhat far removed from the Filicineae; but the actual separation of them from the Filicineae was opposed by Mettenius. The comparison of their vegetative structure with that of certain Bryophytes was, however, maintained, and strengthened by fresh observations: it was pursued subsequently by Prantl, with regard to the sporophyte, and especially to the sorus, and by Goebel as regards the gametophyte. Consequently they were held to illustrate the phylogenetic connection between Mosses and Vascular Cryptogams, and to bridge over the gap between these circles of affinity in the sequence of development of the Archegoniatae. Further, the Hymenophyllaceae have been held to be at least as near to the Polypodiaceae as to any other family of the homosporous Leptosporangiateae: in accordance with such views we

find them placed first in the system of Christ,¹ and removed far from those Ferns with oblique annulus with which they were associated in Hooker's *Synopsis Filicum*. I have elsewhere expressed my dissent from the view that the Hymenophyllaceae are the most primitive type of Ferns: an alternative view is here adopted as to the relationship of this interesting family, based not only on comparison of the living forms, but also upon the rapidly increasing knowledge of related fossils.

It has now been seen that the two genera of the family may be separately recognised as forming natural sequences, and that there is greater uniformity in the genus *Hymenophyllum* than in *Trichomanes*. In the former genus the usual characters of the larger types are, a creeping rhizome containing a stele with metaxylem surrounding the protoxylem: with much branched leaves, sometimes of more than a single layer of cells in the wings: with sori, having a short receptacle, bearing large sporangia with large spore-output. Such a species as *H. dilatatum* may be taken as a central non-specialised type of the genus. In the case of *Trichomanes*, the species *T. reniforme* is isolated from the rest, and shares with *Hymenophyllum* the character of a creeping axis, containing a stele of similar construction: it has leaves several layers in thickness, short receptacle, and relatively large sporangia, with large spore-output. All these characters place it in close relation to *Hymenophyllum*. The rest of the genus represents various lines of specialisation: in some the creeping axis appears to have resumed an upright position, with modifications of the stele which may be held as secondary:² this is found in species with advanced leaf-differentiation, thin leaf-texture, elongated receptacle, relatively small sporangia, and low spore-output per sporangium, such as *T. spicatum*. In others there are found in varying degree diminution of size and complexity of leaf-form, reduction of stelar structure in the creeping axis, and even complete absence of roots: these characters are accompanied by thin leaf-texture, elongated receptacle, small or often minute sporangia, and a spore-output varying from 64 to as low as 32. A general conspectus of the family, bearing these characters in mind, leads to the conclusion that the species in which its two genera are most nearly alike are themselves the most primitive, and that it is through them that comparisons may best be instituted with a view to determining the evolutionary relations of the family. The rest may be held to form sequences of specialisation, which will accordingly possess less direct interest for comparison with other Ferns.

Taking, then, the characters of the sporophyte, as seen respectively in *H. dilatatum* and in *T. reniforme*, they may be compared seriatim with those of other Filicales. The creeping habit is already seen in such early Ferns as the Schizaeaceae and Gleicheniaceae, which are also protostelic: but the peculiar structure of the stele of the above species finds its nearest correlative not in these families, but in the Botryopterideae, and especially in *Zygopteris*: allowing for the differences which follow on upright habit

¹ *Farnkräuter der Erde*, p. 1.

² Boodle, *l.c.*, p. 487.

and radial construction in *Zygopteris* and the creeping dorsiventral rhizome in these Hymenophyllaceae, the structural resemblance is very close: and with this go the strikingly similar facts of structure and insertion of the leaf-trace, and of the mode of supply to the axillary buds.

Next, as to the leaf-texture, *H. dilatatum* and *T. reniforme* are both species with the lamina composed of several layers, and occasionally showing in their development the alternate segmentation seen in the leaves of ordinary Leptosporangiate Ferns. According to the argument advanced above, the filmy texture is an adaptive character shown in various families of Ferns: the peculiarity of the Hymenophyllaceae is that they show it in the highest degree. But the species named appear less specialised in the hygrophilous direction than others of the family, and thus they serve to connect it with the ordinary types.

The marginal position of the sorus is shared with the Schizaeaceae, while it is to be remembered that the Botryopterideae and Osmundaceae may also bear sporangia in their leaf-margins. But the Hymenophyllaceae differ from any of these in the basipetal sequence of the sporangia, the elongated receptacle, and the cup-like indusium. The basipetal sequence may be held to be a secondary condition, bringing with it the advantage of spreading the drain of spore-production over a longer period than if all were developed simultaneously: the elongation of the receptacle, a consequence of intercalary growth, is almost a necessary condition of its adoption. The basal cup-like indusium, imperfectly represented in the Schizaeaceae, has probably been a new formation: its efficacy in protecting the youngest sporangia at the base of the sorus amply justifies its existence. It is thus possible to conceive of the origin of the Hymenophyllaceous sorus from some Fern-type with marginal sporangia, by initiation of a basipetal sequence, and establishment of a protective indusium. The type from which they might have originated would probably be found among some protostelic types with large sporangia marginally produced, of which the Botryopterideae, Osmundaceae, and Schizaeaceae are the known representatives.

A comparison of the sporangia themselves confirms this reference to the Ferns with large sporangia, rather than to simpler forms such as the Polypodiaceae. For there is an oblique annulus corresponding in position on the one hand to that of the other Gradatae, but also to that of certain of the Simplices. A comparison of Fig. 325 of *Hymenophyllum* with Fig. 310 of *Gleichenia* shows plainly the close similarity of the sporangia: and it has been shown that if the peripheral face of the Gleicheniaceous sporangium be reduced the Schizaeaceous type is the result, both being variants of the same form. If finally the point of dehiscence were shifted from the median plane to the side—a practical necessity where there is a basipetal sequence—the Hymenophyllaceous sporangium would be the result. Further, in the spore-output certain of the Hymenophyllaceae approach the Simplices: it has been shown that in *H. Tunbridgense* the output per sporangium is 256-512: in *T. reniforme* and *sericeum* it is typically 256, while other species of

Hymenophyllum yield 128 as the typical number. These are figures which find no correlative in ordinary Leptosporangiate Ferns, but only among the Simplicies, a fact which strongly supports the view above expressed. On the other hand, certain species of *Trichomanes* show only low spore-output, but they are on other grounds regarded as specialised, and their small sporangia and low output are further indications of their derivative character.

It would be impossible to close any comparative account of the Hymenophyllaceae without some reference to the gametophyte, for it has figured largely in previous discussions. *Trichomanes* is the simpler type of the family in its prothallus: while that of *Hymenophyllum* consists of a broad ribbon-like expansion, that of *Trichomanes* is usually filamentous, with more massive archegoniophores. The archegonia of these Ferns do not show distinctive features, but Heim,¹ who has drawn attention to the value of antheridia for comparative purposes, specially notes the similarity of those of the Hymenophyllaceae to those of the Gleicheniaceae. This is a fact of importance when taken with the data of spore-output, for it is thus seen that features of the reproductive organs of both generations indicate a similar affinity.

The result of a general comparison of the Hymenophyllaceae with other Ferns is then to recognise that they approach most nearly to certain of the Simplicies, with which they agree in many points, both of the sporophyte and the gametophyte. The structural peculiarities of the gametophyte apart from the sexual organs are probably in large measure the result of secondary adaptation: a comparison of the antheridia, however, points to certain of the Simplicies. The characters of the sporophyte are more distinctive: they point, in one feature or another, to all the known protostelic families of the Simplicies, but to no one family in particular: so that it is impossible at present to locate the origin of the family with any degree of exactitude. The Hymenophyllaceae are to be looked upon as of early origin, but ending as a blind line of descent, characterised by specialisation of both generations to a hygrophilous habitat, which has taken the form of simplification; in both generations *Trichomanes* shows the greater simplicity, and is on that account to be held as more removed from the original source.

¹ *Flora*, 1896. p. 363.

CHAPTER XXXVIII.

GRADATAE (*Continued*).

THYRSOPTERIDEAE.

THE rare monotypic genus *Thyrsopteris*, which is endemic on the Island of Juan Fernandez, was at once placed with *Dicksonia*, which appears to be its natural position, though it is better, perhaps, to make it the sole representative of a separate family. It is a Fern with an upright axis, three to five feet high, covered by the scars of leaves: these have thick stalks, bear a lamina three to four times pinnate: the upper pinnae are sterile and of leathery texture: the lowest pairs of pinnae are fertile but slender: they are as highly branched as the sterile pinnae, but with the surface undeveloped: each pinnule is terminated by a sorus, the whole giving the appearance of a complicated thyrsum. There is some evidence that Ferns of this type existed as early as the Jurassic period.

The sori have a cup-like basal indusium, surrounding a receptacle which bears numerous sporangia. As in the Hymenophyllaceae, and on the other hand as in *Dicksonia*, the receptacle is the actual apex or margin of the pinnule: it appears at first, while the pinna is still tightly coiled, as a smooth cone, slightly flattened in the plane of the leaf. Below this, before the sporangia make their appearance, the indusium begins to be formed, as a massive outgrowth: a transverse section at this stage often shows that the indusium is slightly two-lipped, and here we may trace an indication of correspondence with *Dicksonia* (*Cibotium*), or, on the other hand, with *Hymenophyllum*: but this two-lipped character is only slight, and is not obvious at later stages. The formation of sporangia soon follows, and their succession is basipetal: the first appear at the extreme margin, of which one is shown in Fig. 329A, the section being perpendicular to the surfaces of the leaf: others then appear in lower positions. The marginal sporangium thus seen is only one of a series which arise along the edge of the flattened receptacle: thus the receptacle is a flattened lobe developed from the margin of the pinnule, as in *Dicksonia*, while the indusium originates as a growth within the margin, on either side of the pinnule.

The form of the parent cells of the sporangia is not constant: commonly the cell has a square base, and the first segment-wall passes obliquely to the basal wall (Fig. 329 A and C), the next segment-wall being inserted obliquely on the first: the result is from the outset a sporangium with a short massive stalk, as shown in Fig. 329 D. In other cases the parent cell is more wedge-shaped, and the first segment-wall cuts an oblique lateral wall (Fig. 329 B): thus the segmentation in *Thyrsopteris* wavers between two types—the one characteristic of larger, the other of smaller spore-output. The further segmentation of the sporangial head follows the type usual for Leptosporangiate Ferns. Very soon, however, the sporangium takes an

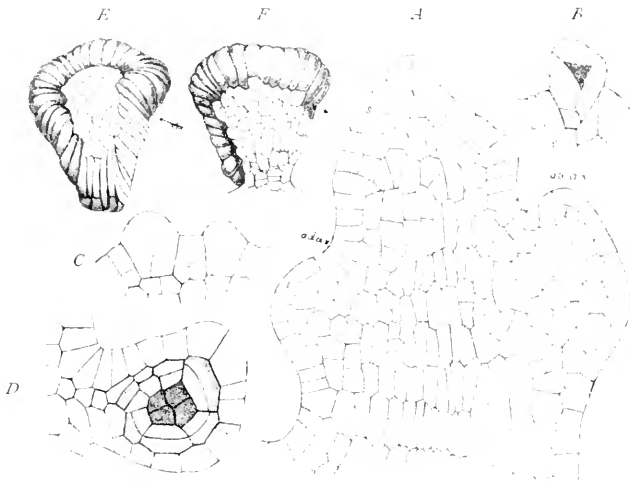

FIG. 329.

Thyrsopteris elegans, Kze. A=longitudinal section through the young sorus, showing the two-lipped indusium *i, i*, and sporangia *s, s*, seated on the receptacle, the oldest being at the distal limit of it. C=two young sporangia. B=one rather more advanced. D=a sporangium with tapetum and sporogenous group shaded. E, F=mature sporangia. A·D×200. E, F×50.

unsymmetrical form, the more strongly growing side being that directed towards the apex of the receptacle (Fig. 329 D): the oblique annulus, which in this genus presents peculiar characters, makes its appearance early, and occupies a position comparable to that in *Gleichenia*: the orientation of the sporangia is thus on the Gleicheniaceae type, which, when repeated and associated with lateral dehiscence, offers the advantages for spore-dissemination noted in the Hymenophyllaceae, and effective in other Gradatae. The central cell undergoes the usual segmentation to form a tapetum of the usual type, and 12 to 16 spore-mother-cells. From countings of the spores it has been concluded that the typical number for each sporangium is from 48 to 64.

The sporangia when mature are of large size and rather peculiar form: seen from without they present some rather unusual features. Fig. 329 F shows one presenting its central face: the annulus, starting from the base,

runs round two sides, but at the point (*) it appears to stop, but it does not do so actually: it merely curves round upon the peripheral face, and disappears behind the body of the sporangium. That the annulus is really a continuous one is seen from Fig. 329 E, which represents the peripheral face: it is very irregular, especially at the base of the sporangium, and consists of a large but not definite number of rather narrow cells: together they form a twisted hoop, so disposed that the distal end of the hoop is curved in the direction of the apex of the receptacle, and this curvature makes the sporangium a peculiarly difficult object to represent in a drawing. The thickening of the walls is greater at the distal part of the annulus than at the proximal, while at one side or the other is a part not strictly defined, where rupture will take place. There is no definite stonium, and though rupture usually occurs about the region to the right in Fig. 329 E, the actual point of dehiscence may vary.

The features thus noted mark off the annulus of *Thyrsopteris* as one of the least specialised among Leptosporangiate Ferns: the inequality of its thickening suggests a comparison with *Loxsonia*. It seems probable that, while showing clear points for comparison with *Dicksonia*, it has been derived from a type with a completely indurated annulus and median rupture: that this became modified in consequence of the close packing of the sporangia in the sorus, which would interfere with a median dehiscence: that a lateral rupture had been adopted, but the sporangium not definitely specialised for it.

The anatomy of *Thyrsopteris* is very imperfectly known. The leaf shows a vascular system, with a few separate bands arranged in the usual horse-shoe outline; in fact, the structure suggests similarity with *Dicksonia*. There are no data as to the internal structure of the axis.

From the known characters it would appear that the relationship of *Thyrsopteris* is primarily with *Dicksonia*, but in some remote degree also with the Hymenophyllaceae: there appears little reason to relate it to the Cyatheaceae, as has been suggested by various writers. It is, however, best placed as a separate family, on account of the peculiar characters of the sporangium and annulus: these show less perfect differentiation than of the Ferns named, while an archaic character is indicated by the numerous cells of the annulus, and the imperfect localisation of the point of rupture.

DICKSONIACEAE.

The family of the Dicksoniaceae included, as arranged in Hooker's *Synopsis Filicum*, six genera; but of these the affinity of *Onoclea* appears to be rather with the Cyatheae, while *Hypoderris*, *Woodsia*, *Sphacopteris*, and *Deparia* differ from *Dicksonia* itself not only in the position of the sori, which are superficial (except in *Deparia*¹), but also in the fact that the various ages

¹ *Deparia Moorci*, a fern in which the sori are mostly marginal, shows occasional superficial sori also: but these are upon the upper surface, and the case is perhaps comparable with that of *Aspidium anomalum*. Hk. and Arn: see p. 117.

of the sporangia are intermixed. The probable position of these genera will be considered later. There remains, then, only the old comprehensive genus *Dicksonia*. This was divided in the *Synopsis Filicum* into three sections—*Cibotium*, *Eudicksonia*, and *Patania* (= *Dennstaedtia*). While *Cibotium* and *Eudicksonia* have obvious relations to *Thyrsopteris*, *Patania* (*Dennstaedtia*) clearly approaches the genus *Davallia*, and especially to that section of the old genus which has been separated as the independent genus *Microlepia*: these relationships will now receive the support of developmental and anatomical evidence. I shall follow Prantl¹ in separating *Dennstaedtia* and *Microlepia* from the position given them in the *Synopsis Filicum*, and recognise them as constituting, perhaps with certain other genera, a natural sub-tribe under the name of the *Dennstaedtiinae* Prantl, having a position between *Dicksonia* and *Davallia*, and constituting with them a natural sequence. It will be shown that following this series from *Thyrsopteris* to *Davallia* we shall pass from a type with basipetal sequence of the large, short-stalked sporangia, with oblique annulus, to forms with a mixed sorus, smaller, long-stalked sporangia, and a vertical annulus. The receptacle, which is a prominent feature in the former, is reduced, or represented only by a flat surface in the latter types. The gradual nature of these parallel steps seems to indicate that the whole series is one of natural affinity, as indeed has always been recognised by systematic writers.

DICKSONIA (EXCL. § *Patania*).

The genus *Dicksonia* includes some large Tree Ferns, and others of smaller stature but with prevalent radial construction. Some of the smaller species closely resemble small plants of *Thyrsopteris*: like it they have leaves repeatedly pinnate, with numerous sori borne at the margins, but without any differentiation of sterile and fertile pinnae. The sori are protected by a two-lipped indusium, but the lips are unequal, and their character has been used as a basis of division of the genus. It will be shown that the receptacle itself is marginal, and that the lips of the indusium are developmentally outgrowths from the surface of the pinnule, just as in the Hymenophyllaceae and in *Thyrsopteris*. Thus there is essential correspondence with these Ferns, and the differences are rather of habit and size than of the more fundamental features of the sorus.

SPORE-PRODUCING MEMBERS.

The sorus in this genus has already been investigated by Glück,² who points out that the receptacle arises from the original leaf-margin, while the two lips of the indusium spring from the upper and lower leaf-surfaces. The structure of the young receptacle, as seen in *Dicksonia* (*Cibotium*) *Schidei*, Baker, is like that of a leaf-margin, with a marginal

¹ *Arch. Königl. Bot. Gart. zu Breslau*, 1892, p. 18.

² *Flora*, 1895, Heft 2.

series of actively dividing cells. In sections perpendicular to the leaf-surface the young sorus appears as in Fig. 330 A, the cell marked (*m*) being one of the marginal series. A section of a similar sorus in a plane (*x, x*) appears as shown in Fig. 330 D (the chain of 10 cells superposed on the lip of the indusium), while at the lower level (*y, y*) it is as shown between the indusial lips. It is thus seen that the receptacle is structurally like a normal leaf-margin, a conclusion again supported by Fig. 330 B, which shows a similar sorus traversed in a plane (*z, z*)

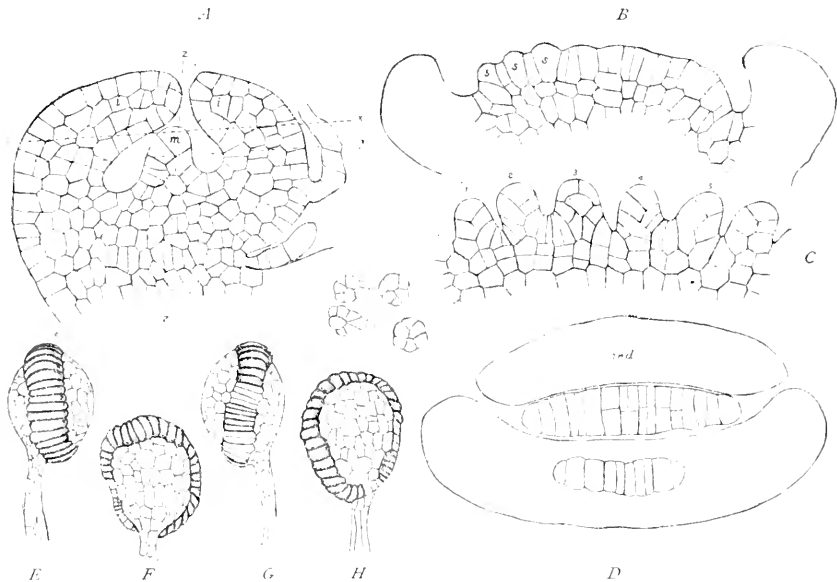

FIG. 330.

Dicksonia Schiedii, Baker. A=section through a young sorus perpendicular to the leaf-surface: *i*, *i*=indusium; *m*=cell of marginal series. B=section of sorus, parallel to the leaf-surface as along a line *i, i*, in Fig. A, showing receptacle bearing sporangia *s, s*. C=a similar section bearing older sporangia. D=transverse section of a young sorus showing the two lips of the indusium (*int*), and receptacle between them, as along a plane *y, y*, in Fig. A. A section of the receptacle as in plane *x, x*, in *A*, is superposed on the lower indusial lip. The central figure shows sporangial stalks cut transversely. A-D $\times 200$. E, F, G, H sporangia of *Dicksonia Menziesii* from four different points of view. $\times 50$.

indicated in Fig. 330 A. It is important to note the inequality in size of the two lips of the indusium. Here it is only slight, but in forms to be subsequently described an increasing inequality, both in area and in substance, makes its appearance. The formation of the sporangia has begun in the marginal cells, and it is seen that their appearance is almost simultaneous, a point better shown in Fig. 330 C, which represents a slightly more advanced stage. These marginal sporangia are succeeded by others produced in a basipetal sequence, but the succession is not long continued, and in *D. Culcita*, L'Herit, it is not clearly marked: there is, however, no evidence of intercalation of younger sporangia between those already present.

As seen from Figs. 330 B, C, the sporangial mother-cells are deeply sunk, and the first segment-walls may insert themselves upon the basal wall, as is shown in sporangium (3), Fig. C; in other cases the segment walls may cut the lateral walls of the mother-cell (*e.g.* sporangium 4). But, however this may be, the first segmentations are those characteristic of bulky sporangia.

The sporangia themselves are of large size, and vary somewhat in form, being in *D. Culcita* of an almost pear-like shape with very oblique ring, while in *D. Menziesii* the ring is more longitudinal. The stalks are relatively thick though elongated, and show in transverse section a rosette of six or seven cells (Fig. 330, central drawing). As the published drawings of *Dicksonia* sporangia are not altogether satisfactory, I have represented those of *D. Menziesii*, Hook and Baker, from four different points of view. Fig. 330 H shows how, on the peripheral face, the continuous ring of the annulus surrounds the relatively large thin-walled area; the indurated part of the annulus is shaded, and of the rest, four smaller cells (connective cells) are seen on either side of the group of five cells which form the stomium. The central face is shown in Fig. 330 F; but in this case the stomium is composed of only four cells, while five connective cells are seen on either side of it. Fig. 330 E shows a lateral view of the side on which the annulus is completely indurated, and Fig. 330 G shows the stomium as again a group of five cells, while two pairs of "connective" cells are seen on either side of it. From these drawings the form and large size of the sporangium, and the position of the annulus are clearly seen, while we also conclude from them that the number of cells of the stomium and connective is not constant.

The orientation of the sporangia has been examined in *D. Schiedei*, *Chamissoi* and *Menziesii*; at the margin of the flattened receptacle it is not uniform, but the sporangia seated on the sides nearer its base show in the majority of cases, though with no strict uniformity, an orientation on the Gleicheniaceous plan.

Notwithstanding the large size of the sporangia, the output of spores in *Dicksonia* is not a high one. Enumerations were made for *D. Menziesii* with 62, 63 as the result, and in *D. antarctica*, 64. Clearly 64 is the typical number for these Ferns.

ANATOMY.

The vascular system of *Dicksonia* can only be properly understood in the light of the simpler forms, and especially of the Dennstaedtiinae. Nevertheless it will be described here, and referred to again later. It has been examined in *D. Barometz* and *Culcita* by Gwynne-Vaughan,¹ who finds the system of the axis to consist of a cylindrical dictyostele surrounding a large central pith. The meshes of the dictyostele are the foliar gaps, and from the lower limit of each arises a leaf-trace in the

¹ *Ann. of Bot.*, xvii., 1903, p. 708.

form of a broad ribbon of tissue, with its margins folded inwards (Fig. 331). Very shortly after its departure from the axial stele this ribbon breaks up into a number of isolated strands arranged in horse-shoe fashion as seen in the transverse section. The point of disintegration varies from one leaf to another, and sometimes it does not occur until the free petiole is reached. There are no accessory strands in the pith nor in the leaf-stalk, as are seen in some other related Ferns.

The structure, even in the large dendroid species, such as *D. squarrosa*, *antarctica*, and *Schiedei*, appears to be the same as that in *D. Barometz*, but on a larger scale. The relation of the whole to a solenostelic type is obvious: where a leaf is inserted a gap occurs in the solenostele; but the leaf-gaps are very small and close up rapidly: if these leaf-insertions be close together, as they are in an upright radial stock, the foliar gaps

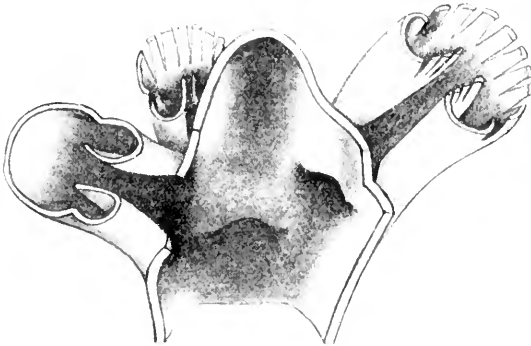

FIG. 331.

Dicksonia Barometz. Portion of the vascular system of the stem, seen from within, and showing the departure of three leaf-traces. (After Gwynne-Vaughan.)

will overlap, and give to the stele a reticulate character. On the other hand, the leaf-trace is originally a single strand, and is clearly seen to be so at its base in *D. Barometz*: but as it passes up the petiole it is disintegrated so as to form a number of separate strands. It will be seen later that this structure is in principle the same as that seen in the genus *Dennstaedtia*, allowance being made for difference in size, and in the elongation of the rhizome with its isolated leaves.

Both structurally and in the characters of the sorus and sporangium the *Dicksoniaceæ* as now limited occupy a position between *Thyrsopteris* and the *Dennstaedtiinae*, while in soral condition, though not in spore-output, the family shows analogies with the larger species of *Hymenophyllum*.

DENNSTAEDTIINAE.

This sub-tribe was founded by Prantl,¹ to include the genera *Dennstaedtia*, *Microlepia*, *Leptolepia*, *Saccoloma*, and *Hypolepis*. The most important of

¹ *Arbeiten Königl. Bot. Garten zu Breslau*, vol. i., p. 18.

these genera are the two first, which were placed apart in the *Synopsis Filicum*: *Dennstaedtia* (as § *Patania*) was included in *Dicksonia*, while *Microlepia* was included as a section of *Davallia*. But evidently systematists had reason to know how closely allied these two were, since the synonyms have been numerous. The fact is that *Dennstaedtia* is not very nearly related to *Dicksonia*; the form of sorus is different, and the details of the sporangium; these characters should weigh more strongly than any similarity of habit. On the other hand, *Microlepia*, while it resembles *Dennstaedtia* in its sorus, differs in some essential points from *Davallia*. Certain new facts have confirmed the soundness of Prantl's systematic method of founding the sub-tribe: it will be seen that the Ferns included in it occupy a peculiarly interesting position, as connecting links between the basipetal type of sorus seen in the *Dicksoniaceae*, and that of the *Davallias*.

MICROLEPIA = (*Davallia*, § *Microlepia*).

This genus includes Ferns with creeping rhizome, on which solitary leaves are borne, which are not articulated at the base. The surfaces bear hairs, notramenta. The leaves are repeatedly pinnate, and bear sori with the indusium unequally lipped; the upper lip appears as a continuation of the leaf-surface, the lower lip as a membranous half-cup-shaped outgrowth: the result is that the whole sorus appears to be intra-marginal.

The sorus has been examined in *Microlepia speluncae* (L.), Moore, *hirta* (Kaulf), Presl, *strigosa* (Thunb.), Presl, and *platyphylla* (Don), J. Sm. In all these it shows in the main a basipetal succession. This is seen in *M. speluncae*, in Fig. 332 A, in which the two lips of the indusium appear with the characteristic inequality, the superior lip (*s.*) having the aspect of a continuation of the leaf-lobe, while the inferior lip (*i.*) is smaller, and has some similarity in position to the indusium of *Cystopteris*. The receptacle is conical, but the sporangia are not very numerous, and it is not greatly elongated; it is traversed by a band of tracheides (*tr.*). The order of appearance of the sporangia is in a strict basipetal succession, but this is not long maintained. The sporangia themselves are on short, rather thick, three-rowed stalks, and the head shows a slightly oblique form, the peripheral face being the more convex. The annulus is almost longitudinal, but still it shows a slight degree of obliquity, such as will be described below in *Dennstaedtia apiifolia*: the orientation of the sporangia shows a considerable regularity on the Gleicheniaceous type.

In *Microlepia hirta* there is general correspondence to *M. speluncae* as regards structure of the sorus and sporangium, though the succession of sporangia is longer, and the receptacle accordingly more elongated; but cases occur occasionally in which the strict basipetal succession is not maintained. One of these is represented in Fig. 332 B, in which there is a larger sporangium at the tetrad stage, and below a small one in which the spore-mother-cells have not yet expanded. Fig. 332 C shows another

example of departure from the strict basipetal succession; still the receptacle is seen to be elongated and traversed for a considerable distance upwards by a strand of tracheides. Such exceptions occur in about one in every five sori cut, and are therefore not excessively rare. These irregularities are of interest for comparison with those to be described for *Dennstaedtia*.

In *M. platyphylla* and *M. strigosa* the sorus was found to be basipetal, the receptacle conical, and the sporangia of the same type as in the other species. Thus it may be concluded for *Microlepia* that the sorus is typically one showing basipetal succession of rather short-stalked, slightly oblique

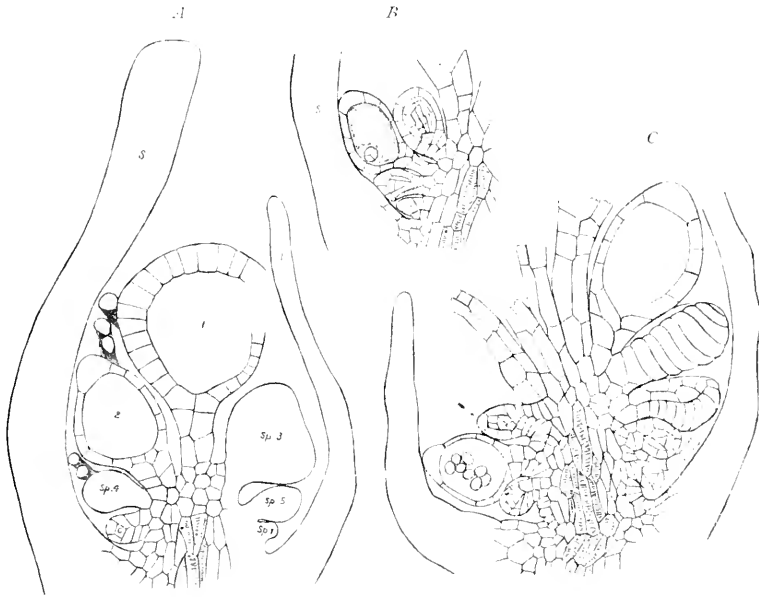

FIG. 332.

A = *Microlepia speluncae*, Baker. Sorus showing unequal lips of the indusium, and basipetal succession of sporangia. $\times 100$. *B*, *C* = *Microlepia hirta*, Kaulf. Similar sections to *A*, but showing departures from the strict basipetal succession. $\times 100$.

sporangia, with reasonable regularity of orientation, inserted upon a conical receptacle, and protected by two unequal indusial flaps. But that in some species occasional departures from the strictly basipetal succession occur, younger sporangia being found inserted between those which are more advanced.

DENNSTAEDTIA = (*Dicksonia*, § *Patania*).

This genus includes numerous species of more delicate habit than *Dicksonia*, and with creeping rhizomes, the solitary leaves are non-articulated, a character in common with *Microlepia*, and ranked as an important one by Smith. Hairs are borne, notramenta. The habit is like *Microlepia*, but also very like *Davallia*. The small sori are marginal, and Prantl had

already noted¹ that the receptacle is derived from the leaf-margin, while the cup-like indusium originates as two flap-like outgrowths of the lower and upper surfaces; excepting that the indusium is not two-lipped, and that the receptacle is cylindrical instead of flattened, it resembles in its main features the sorus of *Dicksonia*. The relations of the sporangia within the sorus have been examined in *Dennstaedtia apiifolia*, Hook., with the result that the basipetal succession has been found to be much more marked than in *Dicksonia*. The receptacle is cylindrical and elongated, and traversed by tracheides for a considerable distance (Fig. 332 bis, A); upon it the sporangia arise, as a rule, in strictly basipetal order. The sporangia themselves undergo the usual segmentation: when mature they

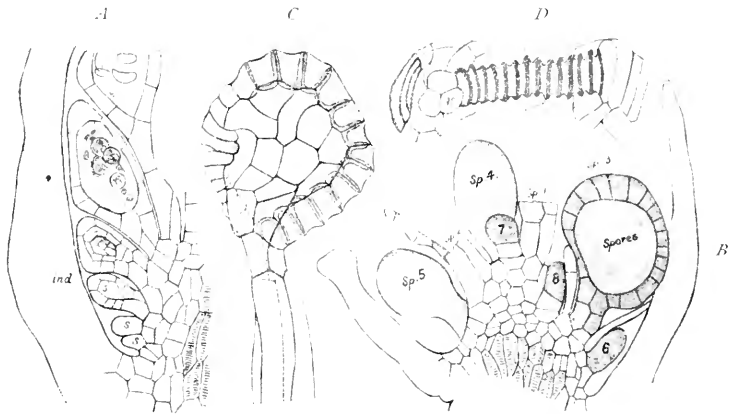

FIG. 332 bis.

A = *Dennstaedtia apiifolia*, Hook. Sorus showing basipetal succession throughout. C = dehiscent sporangium of the same showing very slightly oblique annulus. B = *Dennstaedtia rubiginosa*, Kaulf. Sorus in vertical section showing that it has been at first basipetal, but with a mixed character supervening. D = dehiscent sporangium of the same, seen from the base, showing that the annulus stops short on either side of the insertion of the stalk (st). All $\times 100$.

have long stalks composed of three rows of cells; the head is not bilaterally symmetrical, but one side is more strongly convex than the other: and it will be seen from the figure that the more convex side is the peripheral one. The annulus is not exactly vertical, but running round the margin of the sporangium to the attachment of the stalk, it is there slightly diverted to one side (Fig. 332 bis, c); usually the sequence of cells of the annulus is not wholly interrupted by the insertion of the stalk, but its cells are more or less in contact with one another, and the annulus is in such cases actually continuous at the base, as it is in those sporangia where it is more conspicuously oblique. In fact, the sporangium of *D. apiifolia* shows, though in a less obvious degree than in *Dicksonia*, the oblique annulus. The nearer side of the sporangium shown in Fig. 332 bis, c is the less convex one, the more convex side is the peripheral face as regards the

¹ *Loc. cit.*, p. 19.

whole sorus, and it is on this side that the annulus may be seen to show the last traces of continuity at the base. The orientation of the sporangia, as described, is not always maintained in the mature state; transverse sections of the mature sorus show some latitude in this respect; but this may be due merely to a twisting of the long thin stalk. This seems the probable explanation, since the young sporangia show a fairly accurate orientation.

Sections of sporangia show that the number of spore-mother-cells in each sporangium is variable: eight, twelve, and sixteen have been observed. Countings of mature spores have shown that in certain cases the full number of 64 may be produced.

Deviations from the basipetal succession have been observed in *D. davallioides* (Br.), Moore, and in *D. rubiginosa* (Kaulf), Moore. Even in *D. apiifolia* isolated cases have been seen of a sporangium seated near the apex of the receptacle, apparently arrested in its development, and representing a less advanced state than those surrounding it. In *D. davallioides*, cases of this sort are of fairly common occurrence towards the apex of the rather elongated conical receptacle. These may be held to be transitional forms to what is seen in the allied species *D. rubiginosa*, the sorus of which is represented in longitudinal section in Fig. 332 *bis*, v. Here, upon a relatively short receptacle, and between indusial flaps which are also short, the sporangia are disposed with no definite succession; the persistent stalks of two old sporangia are near the apex of the receptacle, and the younger sporangia below, with spores and tetrads, give a slight indication of a basipetal succession, but still younger sporangia are disposed irregularly among them. The sorus, though showing some slight signs of a basipetal succession at first, is clearly of that type which we shall designate "mixed," that is, with the sporangia produced in no definite succession, but the younger interspersed irregularly among those which are more advanced; correlated with this we find the receptacle short, but wide. The sporangium also shows a difference from *D. apiifolia*, the annulus being definitely interrupted at the insertion of the stalk as is shown in Fig. 332 *bis*, v, which represents a dehiscent sporangium seen from below. (*st.*) indicating the insertion of the round stalk. We shall subsequently see that, by these gradations in *Dennstaedtia*, a transition is indicated between two fundamental types of soral arrangement, the *basipetal succession* of sporangia, and the *mixed*, where the various ages are irregularly interspersed. *Dennstaedtia* is thus found to correspond to *Microlepia* in the occasional departure from the typical basipetal succession of the sporangia in the sorus: this condition leads on to that seen in the genus *Davallia*.

The other genera included in the Dennstaedtiinae by Prantl are *Leptolepia*, *Saccoloma*, and *Hypolepis*. The first two of these are closely related to *Microlepia*, as their numerous synonyms show: many of their species have indeed been included in that genus. *Hypolepis* is

mentioned by Prantl himself as an uncertain member of this sub-tribe. An examination of its sorus shows the sporangia of various ages intermixed, and without definite orientation. On these grounds the affinity of this genus would appear to be elsewhere than in the *Dennstaedtiinae*.

ANATOMY.

It has long been known that the axes of *Dennstaedtia* and of *Microlepia* show the structure now recognised as solenostelic; but the detailed knowledge has lately been extended by Mr. Gwynne-Vaughan,¹ and made the subject of important comparisons, of which the following paragraphs are a brief abstract. The solenostele is itself held to be a relatively primitive state: all the species of *Dennstaedtia* that have hitherto been examined

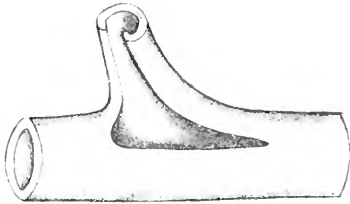

FIG. 333 A.

Dennstaedtia (Dicksonia) punctiloba. Diagram of vascular system of rhizome, including a node and the base of a leaf-trace. The upper surface of the rhizome would face the observer. (After Gwynne-Vaughan.)

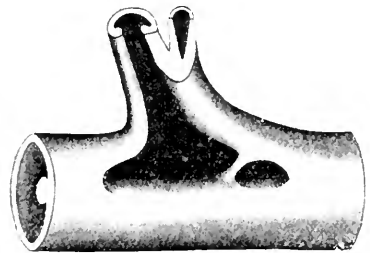

FIG. 333 B.

Dennstaedtia (Dicksonia) adiantoides. Diagram of vascular system of rhizome, including a node and the base of a leaf-trace. *Lsh.* = lateral shoot arising from basicopic margin of leaf-trace; *i.s.* = ridge upon internal surface of solenostele. The upper surface of rhizome would face the observer. (After Gwynne-Vaughan.)

prove to be essentially solenostelic: similarly all the reputed species of *Microlepia* that have been examined are also typically solenostelic, with two exceptions only: one of these is *Davallia (Microlepia) hirsuta*, Hk., which is dorsiventrally dictyostelic, and this appears structurally out of place among the *Microlepias*: an examination of its sorus, however, shows that the plant is one of the Mixtae: thus both the anatomy and the state of the sorus show that its proper place is elsewhere, probably with *Davallia*. The other exception is *Davallia (Microlepia) pinnata*, Cav., which appears to have relations anatomically rather with *Lindsaya*. Excluding these it may be said then that solenostelic structure is typical for *Dennstaedtia* and *Microlepia*.

The vascular relations of leaf and axis are indicated by the Figs. 333 A, B, C. The leaf-trace is in all cases an undivided ribbon-like strand: where it is inserted upon the tubular solenostele the latter opens, forming the foliar gap, which is here only short, and soon closes (Fig. 333 A).

¹ *Ann. of Bot.*, xvii., p. 689.

This simple vascular structure holds for most species, with minor modifications of form of the leaf-gap, and of insertion of the supply for lateral axes. There is, however, a further complication in *Dennstaedtia adiantoides* and *rubiginosa*: in the former a local thickening appears internally at the margins of the leaf-gaps in the ordinary stelar cylinder: this becomes extended to form an inwardly projecting ridge, continuous from one leaf-gap to another (Fig. 333 B). In *D. rubiginosa* this ridge is represented by a separate strand, which still maintains its connection with each leaf-gap-margin, but may divide into several distinct rods (Fig. 333 c). This peculiarity is of importance for comparison with what is seen in the stems of the Pterideae on the one hand, and of the Cyatheaes on the other, while it also has its bearings in the elucidation of the complex structure already seen in the Matonineae.

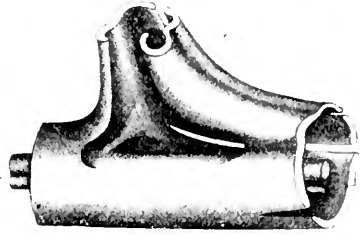

FIG. 333 C.

Dennstaedtia (Dicksonia) rubiginosa. Diagram of the vascular system of the rhizome including a node, and the base of a leaf-trace. *l.s.h.* and *i.s.* as in Fig. 333 B. *l*=lacunae in the solenostele not related to the departure of a leaf-trace. The upper surface of the rhizome would face the observer. (After Gwynne-Vaughan.)

These facts of vascular anatomy, coupled with those relating to the sorus appear to indicate for the Dennstaedtiinae a very interesting intermediate position. On the one hand their confirmed solenostely is evidence of a relatively primitive state, derived probably from a protostelic source: but it shows only slight indications of passing onwards to the more advanced state of dictyostely. Moreover, the constant condition of the leaf-trace as an undivided, ribbon-like strand is a clear index of their primitive position. Similarly, the uniform occurrence of hairs and the absence of ramenta points to the simpler rather than to the more advanced Filicales.

On the other hand, the soral conditions are characteristically those of the Gradatae: the basipetal sequence of sporangia is quite as marked as in *Dicksonia* or *Loxsema*, with which they share the basal indusium, here, as in *Dicksonia*, two-lipped. But in certain species occasional departures from the strict basipetal sequence occur: these are most prominent in *Dennstaedtia rubiginosa*, a species which shows also the vascular strands within the solenostele. With the loss of basipetal succession and the advent of the elongated stalk the sporangium loses its regularity of orientation and its markedly oblique annulus. But this is what might be expected, since there is no longer any mechanical reason for the regularity. In both of these characters, of anatomical structure and of sorus, the Dennstaedtiinae approach the Pterideae. On the other hand their relation to *Dicksonia* and to *Loxsema* is clear: it is based primarily upon habit

and leaf-form; but also upon the characters of the marginal sorus, and lastly upon the vascular system; for even the dendroid *Dicksonias* show a stelar system but little in advance of the solenostelic *Dennstaedtiads*, allowance being made for the closer leaf-arrangement in their upright shoot.

It is thus seen, not from one character alone but from several, that the *Dennstaedtiinae* take a transitional position between certain types of the simpler *Gradatae* and those *Mixtae* which have marginal or approximately marginal sori. But lastly, the inequality of the lips of the indusium, and the obvious lopsidedness of the sorus, both in *Dicksonia* and in the *Dennstaedtiinae*, has its interest in relation to what is seen in some of the more advanced Ferns. The origin of the receptacle is still strictly marginal, but already there is a leaning towards the lower surface, and it will be seen that, in forms belonging to the *Mixtae* which appear to be related, this becomes more pronounced, till finally a superficial position of the sorus is fully attained.

CYATHEAE.

In all the *Gradatae* hitherto considered the sorus is of marginal origin, though in some of the most advanced there is a tendency towards the lower surface. But in the *Cyatheae*, in which the sorus is also basipetal, its position is superficial, being thus comparable with that of the *Gleicheniaceae* or *Marattiaceae*. There is no comparative ground for referring this in the *Cyatheae* immediately to any transition from a marginal position: there is indeed good reason for believing that the superficial sorus was of very early occurrence, for it is exemplified in some of the most primitive types of Ferns.

The *Cyatheae* as now limited include the dendroid genera *Alsophila*, *Hemitelia*, and *Cyathea*, though it will be seen that certain other genera of Ferns of smaller stature are probably related. In habit they are occasionally creeping (*A. blechnoides*), but mostly of tree-like habit, the columnar stem being covered by the scars of the tufted leaves: these may be simple (*C. sinuata*), or singly pinnate (*C. Brunonis*), but usually repeatedly pinnate. Broad superficial scales are present generally, but hairs commonly accompany the sorus. Thorn-like outgrowths are not uncommon upon the surface, especially about the base of the petiole: these must be held as new formations, by enation from surfaces previously untenanted in descent: they show that such origin of new appendages existed among very early vascular Plants. Adventitious roots are numerous, and form a dense felt investing the lower part of the erect trunk to a thickness often far beyond its own bulk.

The three genera named form a very natural group, separated from one another technically by the character of the indusium, which is absent in *Alsophila*, incomplete and scale-like in *Hemitelia*, while in *Cyathea* it

is cup-like, and may form a complete investment for the sorus while young. The disposition of the sori is fundamentally as in *Gleichenia*, in a single series on either side of the midrib of the pinnule; but the regularity of the series is liable to be disturbed according to the mode of growth of the leaf. Moreover, the identity of the sorus is not always maintained, fissions (or fusions) being frequently seen.

The development of the sorus has been followed in *A. atrovirens*: an early condition of it is shown in Fig. 334 A, in which the sporangia near the apex of the receptacle have the cap-cell already formed, while in the lower sporangia on either side it is not yet cut off. The succession is thus basipetal, though not markedly so, since their number is not very large in this species. The sporangia are from the first more robust than those of *Cyathea*, but less so than those

of *Gleichenia*, to which they correspond in the oblique annulus, and in their position in the sorus: moreover, the first segmentations take a middle place: the parent cell of the sporangium has frequently a wedge-shaped base, and the first segmentation-wall cuts one of its oblique lateral walls: this type is thus intermediate between that of the more robust *Simplices* and that of the smaller sporangia of the *Polypodiaceae*.

In point of its convex form and actual size the sporangium of *A. atrovirens* does not differ widely from that of *Gleichenia dichotoma*, but the stomium is lateral as against the median dehiscence of *Gleichenia*: still it is obvious

that the cells of the stomium form part of the very regular series of the annulus (Fig. 334 C). The regularity of the orientation is according to the type of *Gleichenia* in the basal part of the sorus, but it is not strictly maintained by the sporangia at the apex of the receptacle: in this also *Alsophila* corresponds to *Gl. dichotoma*. The typical number of spores per sporangium appears to be 64.

It is thus seen that *Alsophila* shows certain points of interest for comparison with *Gleichenia*: notwithstanding the difference of habit it corresponds in the position of the sorus and in the absence of the indusium, while the number of the sporangia in the sorus in *A. atrovirens* is not greatly in excess of that in *Gleichenia dichotoma*. There is also some similarity in the form of the sporangium with its oblique annulus, and in the orientation of the sporangia, at least in the lower part of the sorus, though in both there is irregularity towards the apex of the receptacle. But there are important differences in the position of dehiscence and in the number

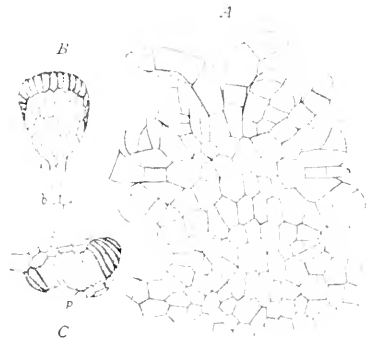

FIG. 334.

A = *Alsophila atrovirens*, Prest. A young sorus cut vertically, and showing a slight indication of basipetal succession of the sporangia. $\times 200$. *B*, *C* = sporangia of *A. cretula*, Br. Mature; *b* = a transverse section of a sporangial stalk. $\times 50$.

of the spores produced from each sporangium. If in a sorus of the type of *Gleichenia dichotoma* the receptacle were elongated to receive a basipetal succession of sporangia, which retained their form, but showed a diminished spore-output, and lateral dehiscence in accordance with their basipetal sequence, the sorus of *Alsophila* would be the result.

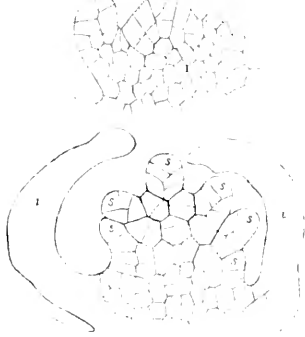

FIG. 335.

Cyathea dealbata, Sw. The upper figure shows a very young sorus, with receptacle and indusium already indicated. The lower shows the indusium (*i*) more advanced, and the sporangia *s*, *s*, arising in basipetal succession. $\times 200$.

Such changes are inherently probable, and it has been seen in the sorus of the Hymenophyllaceae how the greater number of sporangia goes along with a fall in their individual productiveness. This is carried further in *Cyathea* than in *Alsophila*, for there the sporangia are smaller, and the output in *C. dealbata* may fall as low as 16, or even 8 spores per sporangium, though in *C. medullaris* the number may remain at 64. The development of the sorus in this genus has also been followed: it differs in no essential point from that of *Alsophila*, excepting in the presence of the basal indusium, which appears before any of the sporangia (Fig. 335). The inconstancy of

occurrence of the indusium in a group of closely related plants indicates clearly that, however large, or early in appearance, or biologically important it may be, it is not to be held as an essential part of the sorus, nor trustworthy as a phyletic character.

ANATOMY.

Anatomically the Cyatheae show very great complexity of structure, though it can be referred, even in the most complex examples, by comparison to a simpler source: the conclusions are, however, rendered less certain by the lack of graded intermediate conditions. A relatively simple state was found by H. Karsten¹ in the western species *Alsophila pruinata*, a Fern which grows with an upright stem some three feet or more in height. In transverse sections of the axis a solenostelic structure is seen, which opens here and there with a foliar gap, from the margin of which the leaf-trace is given off, apparently as a simple strand, with the usual horse-shoe-like transverse section: after leaving the axis the leaf-trace soon breaks up into a number of strands. As the internodes are of perceptible length the leaf-gaps do not overlap, and the stele often appears as a complete ring (Fig. 336). A peculiar feature is seen in this Fern in the leafless runners, which originate below the leaf-bases, and grow like roots downwards into the soil: it is interesting to note that they have at first a solid stele,

¹ *Vegetationsorgane d. Palmen.*, p. 123.

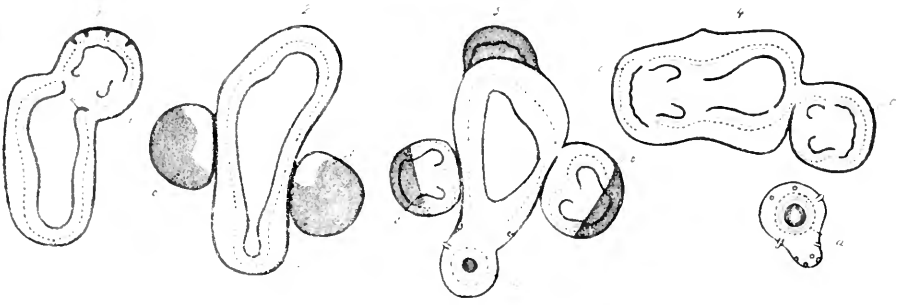

FIG. 336.

Alsophila pruinata, Kaulf. Transverse sections of stem, leaf-bases, and bud (*a*) in Figs. 3 and 4; it is apparent that the axis is solenostelic, that the solenostele opens at the exit of each leaf, and that the leaf-trace is a continuous horse-shoe at its base. (After H. Karsten.)

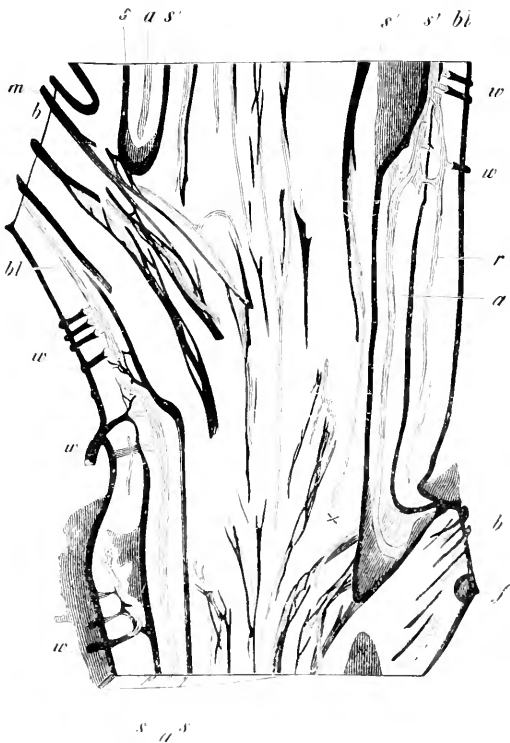

FIG. 337 A.

Cyathea Inrayana, Hook. *A* = axile longitudinal section. Natural size. The section was about 3 mm. thick, and semi-transparent. The black sclerenchyma and paler vascular strands drawn as superficial do not all lie exactly in the same plane. *a* = vascular strands of the main cylinder; *s* = outer; *s'* = inner plates of its sclerotic sheath; internally to *s'*, is the pith with its medullary strands, outside *s*, the cortex with cortical strands; *r* = cortical bundles; *b* = leaf-scars; *bl* = strands passing into leaves; *w* = insertions of roots; *m* = a foliar strand running into the pith; above *a* a blind ending of a medullary bundle. (After De Bary, from Engler and Prantl, *Nat. Pflanzenfam.*)

which, however, soon develops a pith. The anatomy of this Fern, which deserves a thorough reinvestigation, appears to be comparable with that of a solenostelic *Dennstaedtia*: it suggests the structure from which the more complicated Cyatheaceous stems may have arisen. Another species with exceptionally simple structure is stated to be *A. blechnoides*, which is peculiar in having a trailing axis.¹

In the vast majority of the Cyatheae the vascular system consists essentially of a dictyostele, with accessory strands in the pith, and in some cases in the cortex also. The leaves being closely disposed on the

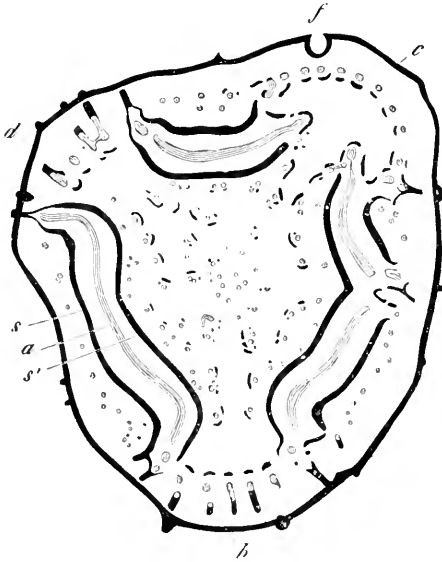

FIG. 337 B.

Cyathea Imrayana. Hook. Transverse section of stem. Natural size. At *b*, *c*, *d*, foliar gaps; all the black bands and spots are stereom, all the paler bands are vascular strands in section. The letters *a*, *s*, *s'*, *f* have the same meaning as in Fig. 337 A. (After De Bary.)

massive axis, the leaf-gaps, which are narrow, overlap, and accordingly several are traversed in a single transverse section (Fig. 337 B). The dictyostele is thus represented by several broadly strap-shaped tracts, with their margins turned outwards, and guarded on either side by bands of brown sclerenchyma: this is the correlative of the solenostele of simpler types. The leaf-trace, composed from the first of numerous distinct strands, springs from the margin of the leaf-gap, the strands being disposed in the usual horse-shoe series. But over and above this fundamental vascular system accessory strands are found in the pith (Figs. 337 A, B): these originate from the foliar gaps, and traverse the pith as a branched system with occasional blind endings. In origin and nature they would appear to be comparable to the accessory rods seen within the solenostele in *Dennstaedtia rubiginosa* (compare Fig. 333).² In the cortex also an accessory series of strands, related to the leaf-trace, is found: it is well shown in *C. Imrayana* in Fig. 337 c, and is reported also for other species, both of *Cyathea* and of *Alsophila*. This cortical system has no recognised correlative in other Ferns.

Young plants of *Alsophila excelsa* have been examined by Gwynne-Vaughan,³ with a view to tracing the ontogeny of the vascular system, and especially the origin of the medullary strands: his results are illustrated

¹ Mettenius, *Ueber Angiopteris*, p. 524, note 3.

² Gwynne-Vaughan, *l.c.*, p. 709.

³ *l.c.*, p. 709.

by a diagrammatic figure (Fig. 338), but with the reservation that the rapidity with which the successive stages are passed through varies considerably: it is believed, however, that the diagram will serve to represent the course of development of the vascular system, not only in the Cyatheae, but also in most of the solenostelic and dictyostelic Ferns, up to the particular stage that they retain when mature. The following description is taken almost verbally from Mr. Gwynne-Vaughan's memoir.

The young plant of *Alsophila exaltata* has its leaves arranged radially all round the axis. At the very base of the stem the single central

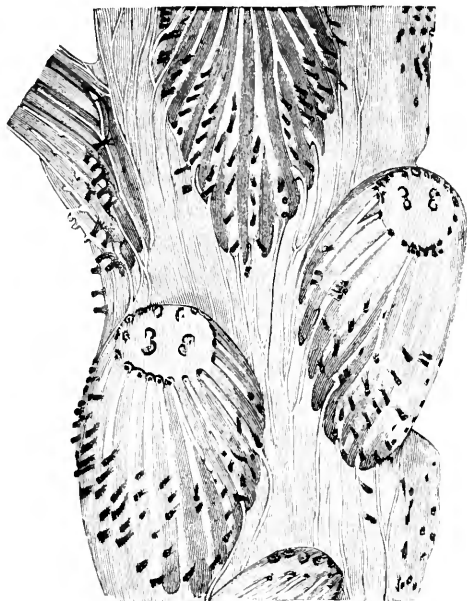

FIG. 337 C.

Cyathea Inrayana, Hook. Piece of stem with four leaf-bases, after removal of the outer layers of cortex, seen from without. The margins of the four leaf-gaps, the bundles which spring from them and pass into the leaves, the roots inserted on them (black), and the bundles which run down within the cortex are exposed. The cortical bundles and root bases are quite free, the rest are covered by semi-transparent parenchyma. Natural size. (After De Buy, from Engler and Prantl, *Nat. Pflanzenfam.*)

cylinder possesses a small central strand of xylem, usually with a few xylem-parenchyma cells intervening between the tracheides. The first leaf-trace may depart without in any way altering the structure of this stele, or of its xylem-strand, but usually the phloem on the adaxial surface of the leaf-trace is prolonged a short distance downwards into the substance of the central xylem. At the departure of the subsequent leaves this feature is much more pronounced, and the phloem thus decurrent runs down through the whole length of the internode to meet with that decurrent from the leaf below. In the second leaf, however, it often falls short of the point of departure of the first leaf, and ends blindly in the internode.

From this point, therefore, up to the third or fourth leaf, the centre of the xylem-strand is occupied by a core of phloem. At the departure of about the third or fourth leaf the pericycle follows the phloem down into the internode below, so that a few pericyclic cells are now to be found in the centre of the core of phloem. At the fifth leaf (or sometimes at the fourth) the endodermis also is decurrent, giving rise at first to a few cells only in the centre of the pericycle, which usually disappear before the node below is reached. Higher up it is continuous from node to node, and surrounds a progressively increasing amount of ground-tissue, which is now decurrent with it. The vascular system has, in fact, become a solenostele. This stage, however, does not last long, for the leaf-gaps begin to overlap after the departure of about the eighth leaf, and above this point the system becomes more and more dictyostelic, although at first a complete vascular ring is occasionally to be met with. The leaf-trace of the first five or six leaves consists of a single curved strand. Above this point two or three separate strands are given off to each leaf, and at about the tenth leaf four such strands are present, two arising from each side of the leaf-gap.

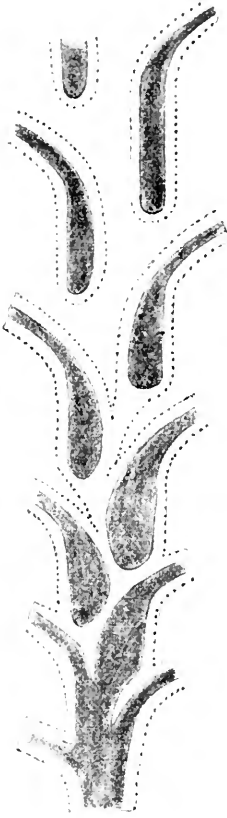

FIG. 338.

Alsophila excelsa. Diagram of vascular system of a young plant in median longitudinal section. The xylem is black, the phloem lightly shaded, and the endodermis is indicated by a dotted line, the ground-tissue is left white. (After Gwynne-Vaughan.)

The first indication of the internal steles that occur in the mature plant is to be found at about the tenth leaf. Just below one or both of the two upper (adaxial) traces of this leaf the xylem of the stem-stele is seen to project slightly inwards, so as to form a small ridge on its internal surface, which is often continued as such for some distance down the stem. Sometimes, however, it separates off completely so as to produce a small xylem-strand lying free within the phloem of the stele, which either ends blindly below or eventually fuses up again with the main xylem strand. These free xylem-strands are always present at the subsequent leaf-gaps, and, although still remaining enclosed by

the same endodermis, they become more and more distinct from the main xylem-strand of the stele. Later on they may even separate off from the stele altogether in the upper part of their course, only fusing with it again at a point lower down. The separation of the small xylem-strands from the main stele finally becomes complete throughout, and from their starting-point they run as small independent vascular strands ending blindly in the central ground-tissue, and having no further communication

with the main stele, except sometimes by a small branch near their point of origin.

It seems, therefore, that the internal vascular strands of *Alsophila excelsa* owe their existence to the same initial phenomena as do those of *Dennstaedtia rubiginosa*; that is to say, they are probably derived from the elaboration of a local thickening of the xylem-ring at the margins of the leaf-gaps in the ordinary stelar cylinder; but they do not appear at all until the ordinary stelar cylinder has become dictyostelic.

The ontogeny thus disclosed for a complex Tree-Fern may be held as a valid suggestion of the way in which the mature condition was achieved in descent. It starts from a protostelic state, which is, however, brief, and passes to the solenostelic by intrusion of outer-lying tissues into the xylem-core; but this again passes into the dictyostelic by reason of the overlapping of the leaf-gaps: and lastly, by intrusion of vascular growths from the margin of the leaf-gaps, the medullary system is produced. All these steps, so quickly passed over in the individual life, are readily intelligible, and even probable, in the evolutionary story of plants with a massive axis, bearing large and closely disposed leaves.

The protostelic state, here so short, is the permanent condition in most of the Gleicheniaceae. But the most advanced species of *Gleichenia* (*G. dichotoma* and *pectinata*) show signs of solenostely, while in *Alsophila pruinata* the solenostelic state appears to be permanent. But in other species of *Alsophila* it also is a phase quickly passed through to the dictyostelic state, which is then permanent. Finally, the medullary system absent in *A. pruinata*, as it is also in *Dicksonia*, but developed in *Cyathea*, is clearly a late accessory, probably consequent upon the enormous distension of the pith in relation to the wide leaf-bases.

The leaf-trace also presents features of comparative interest: in the young plant it consists of a single strand, as it is in all the *Gleichenias*: in *A. pruinata* it appears to be so at the base even of the mature leaf, though it soon breaks up into separate strands as it passes up into the leaf-stalk; but in most of the Cyatheaes the leaf-trace in the mature shoot is from the first composed of a number of distinct strands. These successive steps again indicate a probable phyletic progression, the young plant showing a condition similar to that seen in simpler types, and especially in the Gleicheniaceae.

If the facts derived from the characters of the sorus be put into relation to these from anatomy, a substantial parallelism emerges, pointing in both cases towards the Gleicheniaceae as a probable indication of the genetic source. In soral characters *Alsophila* is the nearest to *Gleichenia*, and especially to those species in which the sorus is no longer uniseriate, but consists of a large number of relatively small sporangia (*G. dichotoma* and *pectinata*). It is in these very species that there is a definite advance towards a state of solenostely not very far removed from that actually seen in *A. pruinata*. From such a

vascular type to that seen in the more complex Cyathea, the probable progress has been as suggested in the ontogeny of *A. excelsa*, while in the sorus the basal indusium appears as a new structure, and the individual sporangia are liable to diminution in size and spore-output, as is exemplified in the extreme form in *Cyathea dealbata*. Thus there seems good reason to see in the Cyathea a series having probable genetic relations with the Gleicheniaceae, but advanced on the one hand to the basipetal succession of the sori, and on the other to a high complexity of the vascular system.

This conclusion is in agreement with the palaeontological facts, for representatives of the Cyathea have been recognised as present from Jurassic times onwards. It is, moreover, specially interesting to note that the genus *Alsophila* is among the earliest of the fossils referred with certainty to this family, as exemplified by *A. polonica*, described by Raciborski from the fire-clay of Krakau.¹

Of Ferns in which evidence of a basipetal sequence of the sporangia in the sorus has been observed there remain *Onoclea*, *Sphaeropteris*, and *Diacalpe*, all genera in which the position of the sorus is superficial and the indusium basal. The natural place for these genera appears accordingly to be in relation to the Cyathea.² The annulus in these Ferns is almost vertical: in *Sphaeropteris* it is slightly oblique, and may be traced as continuous past the insertion of the stalk of the sporangium, as is characteristic of the Gradatae; but in *Diacalpe* and in *Onoclea* the annulus is interrupted at the insertion of the stalk. These genera appear to illustrate how, when the basipetal succession is not long continued, and the orientation of the sporangia not strictly maintained, the annulus is no longer markedly oblique, but passes over into the vertical position, and may even be discontinuous at the base. This will be noted also in the *Dicksonia-Davallia* series.

SALVINIACEAE.

It is impossible to leave the Gradatae without mention of the peculiar little group of heterosporous water Ferns, of the genera *Salvinia* and *Asolla*. They have been so exhaustively described elsewhere that it will be unnecessary to give any detailed account of them here, especially as they are in all probability a side branch from the main series. Examination of their sori shows resemblances to the sorus of the Gradatae: it is, however, difficult to attach them on these, or on more general grounds to any actual genus of living ferns. It would seem probable that the type from which they sprang was homosporous, having an elongated receptacle upon which arose a basipetal succession of sporangia, with short thick stalks, and each containing 16 spore-mother-cells. That with the differentiation of the spores followed certain other modifications, such as a decrease in number of the female sporangia, and perhaps an increase of the male sporangia: the former is

¹ *Abhandl. Akad. Wiss. Krakau*, xviii., 1894.

² See *Studies*, iv., p. 55-58.

particularly exemplified in the female sporocarp of *Azolla*, where the number has sunk to a single one: the latter in the male sorus of *Salvinia*, which shows the unusual phenomenon of branching of the pedicels. Since the annulus is absent, there is no ready clue to the orientation of the sporangia, and it may be a question whether in itself the basipetal succession of origin of the sporangia is a real index of affinity: it is one of those characters which might readily appear in several distinct evolutionary lines. But taken with the other characters of the sorus, and the fact that in these plants the basipetal succession is not always strictly maintained, and does not appear to be of any great practical importance, its existence in the Salviniaceae may be regarded as a survival of an ancestral character. The soral characters would all harmonise with the view that the Salviniaceae are a series of organisms related to the Gradatae, but subjected to modification consequent upon their aquatic habit, and upon their assumption of the heterosporous state.

CHAPTER XXXIX.

MIXTAE.

THERE still remain to be considered the great majority of genera and species of living Ferns. It is not proposed here to enter fully into the characteristics or the classification of them: it must suffice to indicate certain features only which they show, and to place them in general relation to those of the other Filicales which the Palaeontological evidence indicates as prior to them in time.

It has been found, as the result of examination of representatives of all the remaining genera of living Ferns, that the sorus is of the type which is designated "mixed": that is, that sporangia of different ages are aggregated together without any definite sequence: in fact, that promiscuous interpolation of younger sporangia between those already present is the rule.¹ This is accompanied by an absence of any definite orientation of the sporangia, such as has been seen especially in the Gradatae: also there is commonly an elongation of the sporangial stalk, which is often reduced to a single row of cells at its base. With this there is a vertical position of the annulus, which is interrupted at the point of insertion of the stalk. The numerical output of spores per sporangium has never been seen in these Ferns to exceed 64, while lower numbers are frequent. These characters are general for the remaining Ferns exclusive of those already described, and they are accordingly designated collectively the "Mixtae." There may, however, be very great differences in the number, position, and extent of the sori, and in the presence or absence of an indusium; and it is upon these characters that their classification has principally been founded. But before such classification can be held as more than provisional the criteria will have to be extended to include the results of wider anatomical study, and of comparison of the gametophyte.

It is improbable that the Mixtae constitute one single phyletic line: evidence will be adduced that in more than one distinct line of descent the mixed type of sorus was arrived at, and that it was probably derived in most

¹See *Studies*, iv., pp. 78-87.

cases from the type of the *Gradatae*, but might also be produced directly from the sorus of the type of the *Simplices*. It must suffice here to trace some probable lines of phyletic origin which have so far emerged, though others may eventually be recognised.

DENNSTAEDTIA-DAVALLIA SERIES.

The best accredited case is seen in Ferns with marginal sori, and it has been found that among them there are forms which lead from the *Gradatae* towards those genera with mixed sori which have been grouped by Prantl as the *Pterideae*.¹ It has already been seen that though the sorus of *Dennstaedtia* is typically basipetal (see Fig. 332 bis, A), occasional departures from the strict sequence exist in *D. apifolia*, while in *D. rubiginosa* the sorus retains some signs of the basipetal sequence, but younger sporangia occur interpolated without order among those pre-existent, while the receptacle is more flattened (Fig. 339 A). It will be seen that these characters approach those seen in *Davallia*.

The genus *Davallia*, as it stands in the *Synopsis Filicum*, is a comprehensive one. Sir William Hooker remarks² of the *Davalliae*: "No two authors are agreed as to the limits of this group, nor of the genera which compose it; and no wonder, seeing how gradually the genera seem to run one into another. To me the genera seem to have been needlessly multiplied, upon very insufficient grounds, so that in many cases I cannot even adopt them as sub-genera." The result of Sir William Hooker's view, as thus expressed, has been that he grouped several genera of other authors under the comprehensive genus *Davallia*. But the tendency has since been to reinstate some of his sub-genera as substantive genera, the most prominent case being that of *Microlepia*: the characters derived from the sorus have been described above, and justify the removal of *Microlepia* from the genus *Davallia*.

From the § *Eu-Davallia* of the *Synopsis Filicum*, observations have been made on *D. griffithiana*, Hook, *pyxidata*, Car., *canariensis*, Smith, *solida*, Swartz, and *divaricata*, Blume. In all of these the sorus shows various ages of sporangia intermixed, while they are inserted upon a wide, flat receptacle. The sporangia themselves have long stalks when mature, so that the ripe sporangial head is raised far above those of the younger sporangia, and thus scattering of the spores is ensured without an elongated receptacle.

The development has been specially studied in *D. Griffithiana*. Fig. 339 B shows a young sorus with the first sporangia appearing. It may be noted that on the flat receptacle the first sporangium is in a median position, and this may be taken as a slight trace of basipetal succession; but even this is not constant, and as the development proceeds any superficial cell

¹ *Arb. K. Bot. Gart. Breslau*, vol. i. (1892), p. 17.

² *Species Filicum*, i., p. 150.

of the receptacle may grow up into a sporangium, developing as such in any order whatever, and without any regularity of orientation. The confused mass which results is shown in Fig. 339 c, and this also illustrates how, as the sporangia grow older, their stalks, composed in the lower part of but a single row of cells, become elongated. The vascular strand runs upward to a point immediately below the surface of the sorus, and there widens out

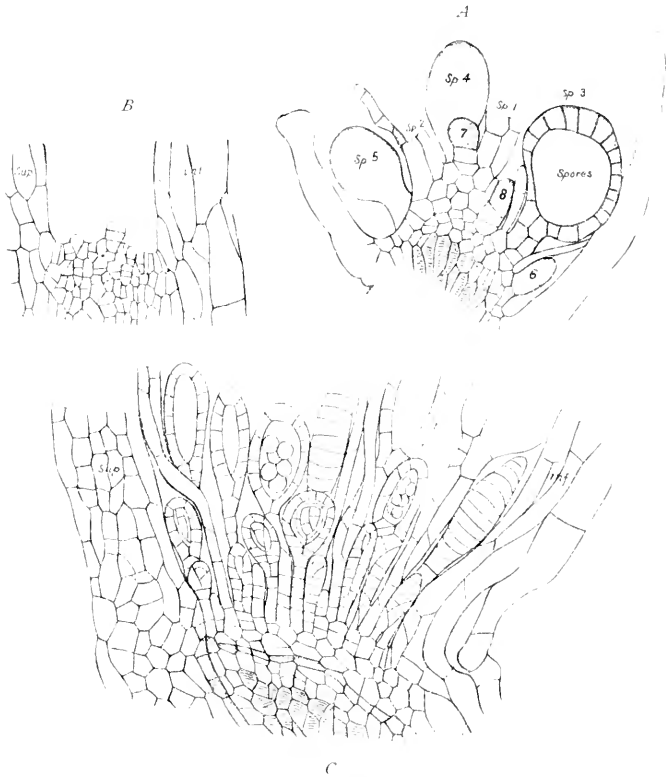

FIG. 330.

A = sorus of *Dennstaedtia rubiginosa*. Cut vertically and showing mixed condition in a sorus originally basipetal. *B* = *Davallia Griffithiana*, Hk. Young sori in section, showing first formation of sporangia. *C* = old sori of the same, showing sporangia of different ages intermixed. All $\times 100$.

into a considerable mass of tracheides, surrounded by a thin band of parenchyma, and limited by a brown layer, which is doubtless of the nature of an endodermis.

Examination of representatives of all the other sections of the genus *Davallia* led to similar results, and it is thus seen that, with the exception of *Microlepia*, which had already been removed on other grounds by Prantl, and accorded a separate place by Christ,¹ the genus *Davallia* shows

¹ *Farnkräuter*, p. 10.

uniformity of structure of the sorus on the mixed plan, with flat receptacle, and with no definite rule of orientation of the long-stalked sporangia.

The connection of the *Dennstaedtia-Davallia* series with such genera as *Lindsaya*, *Pteris*, *Pellaea*, and *Adiantum*, where the sori are marginal, seems beyond question, and it is strongly supported by the anatomical evidence. But, on the other hand, the sori are liable to move from the marginal position: this phyletic change is illustrated by very gradual steps. An inequality of the lips of the indusium is apparent in *Microlepia* (Fig. 332 A): it appears often in greater degree in the various forms of *Davallia*, and is specially marked in § *Leucostegia* (Fig. 340), where the upper lip appears as the continuation of the leaf-lobe, the lower as a cup-shaped indusium apparently some distance from the margin. *Leucostegia* has long been recognised as closely related to *Cystopteris*, which also has a mixed sorus, without regular orientation of its sporangia, while it is protected by an indusium



FIG. 340.

Davallia hymenophylloides. Pinnule enlarged. (After Hooker, from Christ's *Fauna-Krauter*.)

of similar form to that of *Leucostegia* (Fig. 341). These examples will serve as illustrating a feature which has probably been widely effective in the descent of the Leptosporangiate Ferns, viz. the retreat of the sorus from the margin to the under surface of the leaf. From *Cystopteris* the sequence may with probability be traced on to the Aspidaceae. It would thus appear that a considerable proportion of the Mixtae are referable in origin to forms with a marginal position of the sorus.



FIG. 341.

Cystopteris fragilis. Pinnule of the form from Tasmania, and its sorus enlarged. (After Hooker, from Christ's *Fauna-Krauter*.)

A further illustration of probable relationship, in this case to *Polypodium*, is seen in *Hypolepis*. This genus was included by Kühn and by Prantl¹ in the Dennstaedtiinae, though by others it has been placed in the Pterideae. The marginal sori, covered by the reflexed margin of the leaf, consist of a slightly convex receptacle, upon which the sporangia of various ages are inserted in no definite order: the annulus is definitely interrupted

at the insertion of the stalk. It is clearly one of the Mixtae, but the affinity with the Dennstaedtiinae is indicated by the position and character

¹ *L.c.*, p. 18.

of the sori and the habit, as well as by certain anatomical features. The genus appears to hold an intermediate position between the Dennstaedtiinae and some Ferns referred to *Polypodium*: the relationship to the latter has already been the subject of remark; for instance, in the *Synopsis Filicum*, p. 130, Dr. Griesebach is quoted as writing of *H. Purdieana*, Hk.: "Not to be distinguished from *P. rugulosum* but by the specially transformed involucreal appendages, and probably passing into that widely-ranging species." Again,¹ under *Polypodium* (*Pheg.*) *punctatum*, Thunb. (which Hooker regarded as including *P. rugulosum*, Labill), he remarks: "Very closely related to *Euhypolepis*." All this seems to indicate a probable sequence which would consist of (a) some Dennstaedtiinous Ferns with basipetal sori, (b) some type with mixed sorus, and receptacle within the margin which is curved over as an indusium, as in *Hypolepis*: (c) such a type as

Polypodium punctatum, Thunb., with its definitely superficial, unprotected sorus, having sporangia with ages intermixed, and no regularity of orientation.

It may next be enquired how far the anatomical data will support the results of examination of the sori in this series. It cannot be assumed that characters so distinct as those of the sorus and of the vascular system must necessarily run parallel; but if they do, it is a strong support of the correctness of recognition of a phyletic line. Gwynne-Vaughan has found that in every species of the sub-tribe

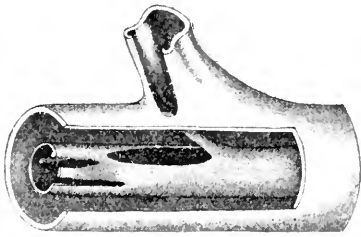

FIG. 342.

! *Pteris elata*, s. *Karsteniana*. Diagram showing the arrangement of the vascular tissue at the insertion of a leaf. A piece is supposed to be cut out of the side of the solenostele, so as to show the internal vascular system. Note that a small strand, lying within the second vascular ring, is also present. (After Gwynne-Vaughan.)

Dennstaedtiinae in which the anatomy

is known the same type of primitive vascular system, the solenostelic, is seen: this indicates the primitive nature of Prantl's sub-tribe as a whole. The statement applies for all species of *Dennstaedtia* examined, but in *D. rubiginosa* the solenostele is not quite typical, additional vascular strands being also present: this is, however, the very species in which an approach to a mixed sorus is found: thus, the two characters indicate that plant as an advance upon the rest. The approach is towards a condition seen in species of *Pteris*, where with a mixed sorus there is a still more elaborate accessory vascular system within the original solenostele (Fig. 342).

Turning to the *Hypolepis*-*Polypodium* line above noted, the anatomy again supports the relationship. *Hypolepis* is solenostelic: so is *P. punctatum*: in fact this species stands structurally isolated among the Polypodiaceae, and is evidently related closely to *Hypolepis*, which in turn is related to the other Dennstaedtiinae.²

¹ *Syn. Filic.*, p. 312.

² Gwynne-Vaughan, *l.c.*, p. 735.

In the case of *Lindsaya* the matter is not so clear. The marginal sorus is of the mixed type, but the vascular structure is less advanced than in the *Dennstaedtia-Davallia* series: it is characterised by possessing in addition to the external phloem-mantle a strand of phloem completely embedded in the xylem.¹ In this, however, there is no serious discrepancy: it appears that the soral and anatomical characters do not always march abreast: in *Lindsaya* the anatomical advance has lagged behind that of the sorus.

Lastly, there is abundant evidence to show that an ultimate state of dictyostely has been achieved in the vast majority of the Mixtae: it appears already in *Davallia* and in *Cystopteris*, among the series now under discussion. It may be held as a final modification of the solenostelic structure, consequent upon the overlapping of the leaf-gaps. And so it is seen that in the *Dennstaedtia-Davallia* series the anatomical advance is in the main parallel with that of the soral characters, though exact parallelism is not always maintained. There is thus good reason for holding that the series represents a true line of phyletic advance, leading from the condition of the Gradatae to that of the Mixtae.

ONOCLEA-WOODSIA SERIES.

A phyletic line of progression from a basipetal to a mixed sorus, possibly distinct from the last though of much less certainty, may be traced through genera where the sorus is already superficial: viz. from *Onoclea* and *Diacalpe* on the one hand to *Woodsia* and *Hypoderris* on the other. These genera have been grouped together in most of the leading systems, and are all included under the Woodsieae by Diels.² But an examination of their sori shows that in *Onoclea* and *Diacalpe* there is a basipetal succession of the sporangia: this has been demonstrated developmentally in *Onoclea*, and the result may be summed up in the statement that the sorus is characteristic of the Cyatheae: but the sporangium is characteristic of the Polypodiaceae, having a long stalk, and the annulus is definitely interrupted at the insertion of the stalk, while there is no regularity of orientation. In *Diacalpe*—as in *Sphacopteris*, as well—there is also evidence of basipetal succession (see *Studies*, iv., pp. 55-60).

But in *Woodsia* and *Hypoderris*, where also the sori are superficial and the indusium basal, the case is different: in *Hypoderris* the sorus is clearly of the mixed type, with flattened receptacle: the same appears to be the case in *Woodsia*, though the small number of sporangia makes the decision less certain. Full anatomical data are not at hand for comparison, though *Onoclea* at least appears to have already an advanced type of dictyostele. The evidence, such as it is, appears to indicate that a line of advance from a basipetal to a mixed sorus has existed among the Ferns with superficial sorus and basal indusium, of Cyatheaceous affinity. But these forms require

¹Tansley and Lulham, *Ann. of Bot.*, xvi., p. 157.

²Engler and Prantl, i., 4. p. 159.

a careful revision, with special reference to their anatomical characters, before this progression can be regarded as established.

MATONIA-DIPTERIS SERIES.

The genus *Dipteris*, Reinw., so long merged in the comprehensive genus *Polypodium* on account of its sorus being naked and superficial, has recently been restored to its independent position, and is now held to be the sole representative of the family of the Dipteridinae.¹ There is little doubt that this position is justified, while among relatively primitive types the family finds near allies among the Matonineae.

The genus is represented by four living species from the Indo-Malayan Flora, which illustrate an interesting progression in leaf-architecture. They all have creeping rhizomes, showing occasional dichotomy, the type of shoot being closely similar to that of *Matonia*. The axis and the bases of the leaves alike are invested with a dense covering of hairs, which are, however, flattened into elongated scales, an advance upon the filamentous hairs of *Matonia*. The leaves of the different species vary in area, but are alike in plan: upon the end of a long petiole is borne a lamina which is repeatedly branched in a dichotomous manner. The branches may remain narrow, with a marked midrib and lateral flanges of no great area, as in *D. Lobbiana*, Hooker, and *D. quinquefurcata*, Baker: or they may be broader, and be more or less webbed into a lamina, which is, however, still divided by a median sinus into two symmetrical halves: this is seen in *D. conjugata*, Reinward (Fig. 343 A), and *D. Wallichii*, Hook. and Grev. This leaf-structure is comparable with that of *Matonia*, in which also the outline of the lamina is referable to a dichotomous branching, and as in that genus, so here also the sori are in the narrow-lobed species disposed upon the flanged wings on either side of the midrib. Their relation to the area of the leaf-surfaces within this very natural genus is instructive for comparison with other Ferns. In the narrow-leaved *D. Lobbiana*, and especially near to the bases of the several lobes, the sori form a regular linear series on either side of the midrib (Figs. 344 and 343 E). In *D. quinquefurcata* the lamina is larger and the segments broader than in *D. Lobbiana*, and the areolae within the veins on either side of the midrib are larger, and contain more sori: these illustrate various degrees of fission, and thus they become spread over the enlarging area (Fig. 345). *D. Wallichii* appears to occupy a middle position between these species and the large *D. conjugata*: for it is described as having the ultimate segments linear in form, and the sori as being similar to those of *D. conjugata*, but more numerous than in *D. Lobbiana* or *quinquefurcata*. Lastly, in the large-leaved *D. conjugata* the bifurcate lamina is broadly webbed, and the very numerous small sori, which are distributed over the wide expanse, may be circular or oval, and not always distinct from one another: they may vary much both in

¹Seward and Dale, *Phil. Trans.*, vol. exciv., p. 487.

size and shape, and their individuality is often lost, so that nearly the whole of the lower surface of the frond appears as though densely covered with a mass of sporangia (Figs. 343 A C, and 346).

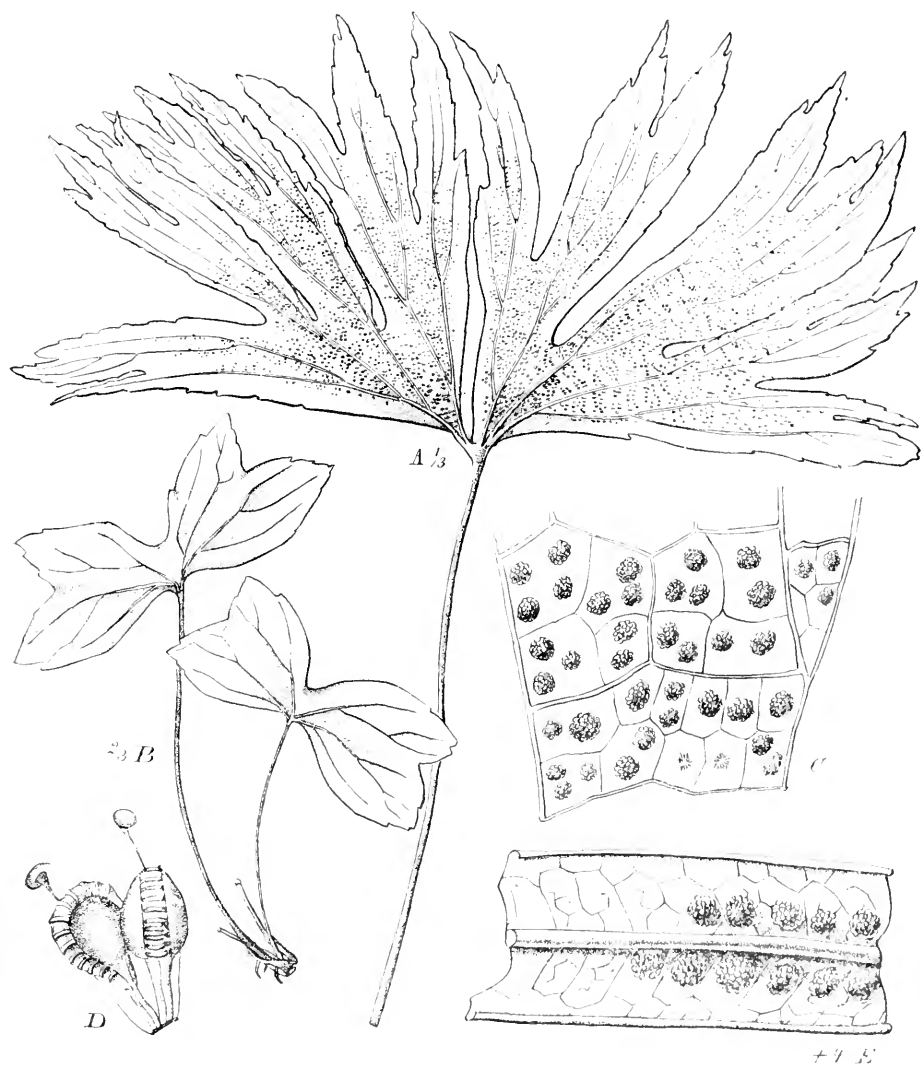

FIG. 345.

Dipteris, Reinw. A-C = *D. conjugata* (Kaulf.), Reinw. A = leaf of a mature plant. B = habit of a young plant. C = part of a fertile leaf with venation and sori. D = sporangia and paraphyses enlarged. E = *D. Lobbiana* (Hook.), Moore. Part of a fertile segment with venation and sori. (A, C, D after Kunze. B, E after Diels, from Engler and Prantl, *Nat. Pflanzenfam.*)

There seems to be only one probable way of reading these facts phyletically. Comparison points to *Matonia* and *Gleichenia* as primitive

types of leaf, to which that of *Dipteris* is related by *D. Lobbiana*; but from this simple narrow-leaved type, with its single row of sori on either side of the midrib, the broader-leaved *Dipteris* has broken away as its leaf-area enlarged, and the sori have been spread over the extended surface, while the absence of their individuality gives the key to the way in which

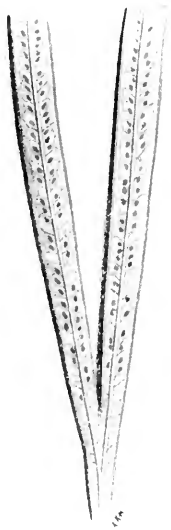

FIG. 344.

Dipteris Lobbiana (Hook.), Moore. Parts of two pinnae, showing narrow form, venation, and regular disposition of the sori. Natural size.

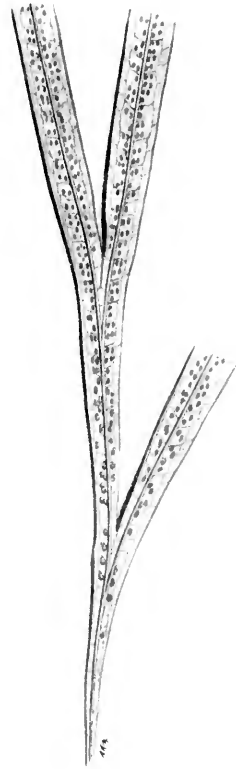

FIG. 345.

From a specimen collected by Capt. Hope, R.N., on the "China Station," but without exact locality; recognised as *Dipteris quinquefurcata*, Baker. Pinna showing greater width, and sori arranged below in two lateral series as in *D. Lobbiana*, but spreading out upwards, with many fissions, over the more extended surface. Natural size.

the result has been brought about, viz. by fission. This process, so clearly seen in the few species of this very natural genus, has probably occurred also in other types of Ferns. It is suggested by *Kaulfussia* among the Marattiaceae, but much more obviously in various lines of the Polypodiaceae. It will have to be reckoned with in any general conception of the phylogeny of the leaf in Ferns.

Examining the sorus itself, it is composed of a number of sporangia, and numerous glandular hairs are associated with them. The sporangia

show no regularity of position or of orientation, such as is seen in *Matonia*: there is also an absence of any projecting receptacle. The sporangia of the same sorus have been found to arise simultaneously in *D. Lobbiana*, which may in this respect compare with *Matonia*. But in *D. conjugata* they are formed successively, while those which appear later are distributed without order amongst those first formed. The sorus, in this respect, compares with that of the Mixtae, but the succession is not long maintained. When the individual sporangia are examined an essential difference is found from the Polypodiaceous sporangium, with its vertical ring; for here the annulus is not only oblique, but also twisted: the series of cells of the annulus can be traced laterally past the insertion of the stalk, but the induration of their walls is interrupted at that point: the

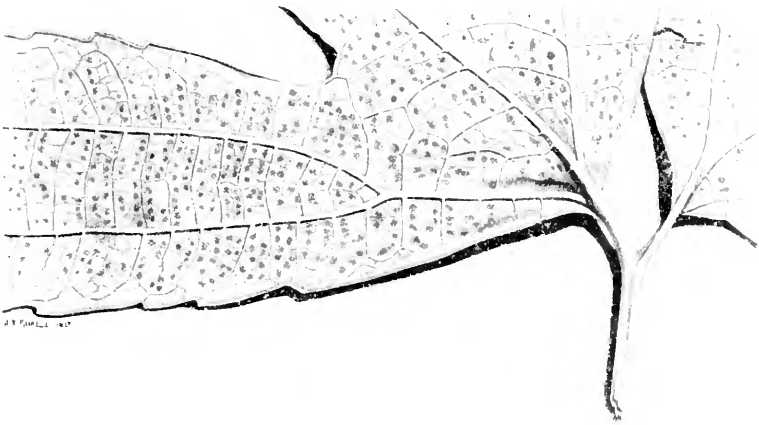

FIG. 346.

Dipteris conjugata, Rein. Portion of leaf, showing the extended surface, the webbing between the pinnae, the venation, and the numerous sori spread over the surface. Natural size. Figs. 344-346, after drawings by Mr. A. K. Maxwell.

dehiscence is lateral, but there is no clearly defined stomium. The sporangium itself is small, and the spore-output has been found both in *D. Lobbiana* and in *D. conjugata* to approach the typical number of 64. Comparing this sporangial structure with that of other Ferns, it is actually most like that of the Cyathea, though the interrupted induration of the annulus points a further departure from the primitive type, such as may with reasonable probability be found in the sporangia of *Matonia*, and ultimately of *Gleichenia*.¹

Turning to the anatomical characters, they bear out the above comparison; for the rhizome contains a simple solenostele, while the leaf-trace comes off as a single ribbon-like strand, opening a leaf-gap which soon closes again. The margins of the petiolar strand curve inwards to form the usual horse-shoe curve, which only breaks up at a point close below

¹See Miss Armour, *New Phytologist*, 1907.

the lamina. These are all relatively primitive characters, and unusual in Ferns showing a mixed sorus: they direct the line of comparison downwards to *Matonia* and *Gleichenia*. The former has a vascular system of the same type as *Dipteris*, but it has run into greater complications, with its concentric solenosteles. Both genera, however, are considerably in advance of the most complex *Gleichenias*. Yet all these Ferns appear to conform in their various degrees of elaboration to the same vascular type.

There is, however, no exact parallelism in the soral and vascular characters. *Gleichenia* is the most primitive in both respects; while *Matonia* is the most advanced of all in vascular structure, its sorus is still that of the Simplices, though it has only a small spore-output per sporangium, and a protective indusium is present; but as this is apparently absent in *Laccopteris*, it has probably been in *Matonia* a special generic feature. *Dipteris*, with its vascular system taking a middle place, has the most advanced soral condition, as shown by their distribution on the leaf, by the flat receptacle, and by the mixed aggregation of the sporangia in *D. conjugata*. But still it proclaims its origin by the absence of indusium, the oblique annulus, and the imperfectly differentiated stomium. The sum of characters justifies the conclusion that in *Dipteris* we see a genus of origin from a stock included in the Simplices, in which at least one species has passed, apparently without the intermediate state of a basipetal sorus, directly to the condition of the Mixtae. There is, moreover, good reason for holding that this phyletic line has proceeded quite independently of the other progressions to a mixed sorus which have been traced elsewhere.

Finally, the palaeophytological data harmonise with this conclusion: for representatives of the Dipteridinae figured largely in the Mesozoic Flora, as far back as the Rhaetic, with sori agreeing in form and distribution with these of *Dipteris*; but the annulus is described as probably complete.¹ This point may be considered doubtful; but if it were confirmed it would fall in readily with the phyletic position suggested for the Dipteridinae. The conclusion of Seward seems fully justified that *Matonia* and *Dipteris* are linked together as remnants from a bygone age. They have advanced independently, the one to higher vascular complexity, the other to a distribution and construction of the sori characteristic rather of the more recent Ferns than of its own progenitors.

It has now been seen that the condition of sorus characteristic of the Mixtae is absent from the Ferns which Palaeophytology tells us were the most primitive, but that it is the prevailing feature in the Ferns of the present day. It has also been seen that steps leading from the more primitive condition of the Simplices and Gradatae to the mixed type of sorus exist in certain Ferns: and further, that there is a probability that this end has been achieved by progression along more than one phyletic line:

¹Seward, *l.c.*, p. 507.

these conclusions have been shown to be supported by the facts of anatomy. It must, therefore, be allowed that those Ferns which are associated under the general heading of "Mixtæ" are relatively late derivative forms, and that they do not constitute a natural group, any more than do those plants which are heterosporous or those which produce seeds. It would then seem desirable to proceed at once to divide this heterogenous group into true phyletic sequences. But to do this requires much greater command of facts, and especially of those of anatomy, than is at present available. Here it must suffice to recognise the unsatisfactoriness of the present position, and at the same time to give a very few general indications of the form the future system may take.

It would appear probable that the main bulk of the Mixtæ have been derived along a line where the sori were marginal, with the *Dennstaedtiinae*, the *Davalliinae*, and *Pterideae* of Prantl as early representatives of it. This was accompanied by transition through the solenostelic to the dictyostelic structure of the stem. A gradual shifting of the sorus to the under surface of the leaf also occurred, till the condition was reached as seen in the *Aspidiinae* and *Aspleniinae* of Prantl. Certain forms allied to these, losing their indusium altogether, constituted one section of the old comprehensive genus *Polypodium*. All through the more advanced members of this sequence the dictyostelic structure of the stem was maintained. Another contingent, with very similar final result, probably arose from forms with superficial sori and basal indusium, allied to the *Cyatheae*: in this also the dictyostelic structure is seen. A third series, also with superficial sori, is represented by the *Gleichenia-Matonia-Dipteris* line: it is true that *Dipteris* is at present the only recognised representative of this sequence which has attained to the rank of the Mixtæ, and it has consequently been removed from its old position in *Polypodium*. It seems, however, not improbable that future investigations may add fresh contingents from the ranks of *Polypodium*, and possibly from some other genera, and one useful criterion will be found in the stem-structure, for in the recognised forms it is persistently solenostelic.

The attempt will not be made at present to assort all the remaining forms of Polypodiaceous Ferns into probable phyletic sequences: they are left to be dealt with as knowledge increases. Meanwhile the general view of them will be as of a brush of diverging phyletic lines, which have proved blind. In fact, the ultimate fulness of development of the Homosporous Ferns is that which is before us to-day.

CHAPTER XL.

GENERAL COMPARISON OF THE FILICALES.

THE burden of evidence in the comparative study of the Ferns has habitually been laid upon the sporophyte: indeed, this was a matter of necessity to the older Pteridologists, since the prothalli were then practically unknown. But subsequent investigation has largely justified what was at first a matter of circumstance rather than of choice: it has been shown that for very many Ferns there is a dead level of form of the gametophyte, while it has been proved to be possible, by varying the conditions of growth, to elicit great differences of development even in individuals of the same species. It is true that while some groups of Ferns have habitually a robust prothallus, as in the Marattiaceae, others show habitually a delicate and sometimes a filamentous type, as in the Hymenophyllaceae or Schizaeaceae, while the same appears also in *Vittaria*. But though in some measure such characters may be held as useful evidence, the very slight positive features that the vegetative development of the prothallus presents, and their liability to modification, will always derogate from its importance in comparison. Turning to the sexual organs, they vary in their level, being either sunken or projecting: and an interesting parallel may be drawn between them and the sporangia in this respect, for they are habitually sunken in Eusporangiate and projecting in Leptosporangiate forms. The archegonia are singularly uniform in structure throughout the Ferns: but the antheridia show two distinct types as regards dehiscence: the one, in which a cap-cell breaks away at maturity, is characteristic of all Ferns with an oblique annulus, with the exceptions of *Ancimia* and *Mohria*: the other, in which there is a star-like dehiscence, includes *Ancimia* and *Mohria*, together with the whole body of the Polypodiaceae. Such facts are interesting as a confirmation of the results of study of the sporophyte, for they group together on the basis of a gametophyte character those Ferns on the one hand which comparison of the sporophyte indicates as primitive, and on the other those which are held to be later and derivative. It is in this way that the characters of the gametophyte may be used, as ancillary rather than

dominant in our comparisons: and the burden of the argument must still rest upon the facts derived from the sporophyte generation. We shall then, excepting for an occasional reference, leave the gametophyte aside in the present discussion, and review the characters of the Fern-plant in its relation to the general theory of the sporophyte.

EXTERNAL CHARACTERS.

The Ferns are the characteristic megaphyllous members of the Pteridophyta, and thus differ markedly in habit from the smaller-leaved strobiloid types. It is necessary first to inquire what are their probable relations to these series. In point of time the distinction of habit dates back as far as the earliest known fossils, and accordingly it is only by comparison that any opinion can be formed as to their origin by descent, and then only as a probability, not as a demonstration. The similarity of life-history shows, however, that the sporophyte of the Fern as a whole corresponds to that of the strobiloid types: the further question will then be as to the correspondence of the parts, especially the axis and leaf.

The chief difference lies in the proportion of leaf to axis, and in the branching of the leaf, not in the fundamental relations of those parts as regards origin or position: this is specially obvious in upright growing species, with radial symmetry of the shoot. In the Ferns, as in other Pteridophytes, there is reason to regard the radial type of the shoot as primitive, notwithstanding the fact that a very large proportion of living Ferns are dorsiventral. Among the Ferns of the Primary Rocks no dorsiventral type of shoot has been described, unless it be the Permo Carboniferous genus *Glossopteris*, the relation of which to the true Ferns is still a matter for discussion. It is possible that a creeping rhizome may have existed as the base of insertion of some of the unattached fronds, but still in the absence of demonstration of this the evidence points to the radial type as having been prevalent. This is the case with the various stems designated *Caulopteris*, in many of which the leaf-arrangement is on a spiral plan: even those designated *Megaphytum*, where the leaves are distichous, were of radial character, and all evidence indicates that their position was upright. Among the best known of the early forms are the Botryopterideae, which had relatively thin axes with leaves in some cases closely aggregated, in others more laxly disposed: both types are of radial construction. Thus the evidence, so far as it goes, indicates that the radial type of shoot was prevalent, if not indeed exclusive, for the early Ferns. It is exemplified by the Botryopterideae, the Marattiaceae, and the Osmundaceae, all early types.

That large-leaved forms would be mechanically unstable structures is obvious, especially where the stem is thin and the internodes of appreciable length. There is an inherent probability that such axes should become oblique or prone, with a dorsiventral development as a natural consequence.

Examples illustrating that this has actually occurred have already been seen in the living Marattiaceae; while *Angiopteris* and *Marattia* have upright and radial stocks, that of *Danaea* becomes oblique or even prone as it grows older, and *Kaulfussia*, with its longer internodes, is a creeping form. In all of these, however, where the embryo is known, the shoot is in the first instance erect. It seems plain that there has been a transition from the upright and radial to the prone and dorsiventral type.

In the living representatives of those sequences of Ferns which culminated in the Leptosporangiate group dorsiventrality is more common, and it is already seen to be prominent in such early types as the Schizaeaceae, Gleicheniaceae, and Matonineae, though the Cyathea and Dicksonieae are strongly radial. There is some reason on anatomical grounds for thinking that the living Hymenophyllaceae show in their radial types a recovery of

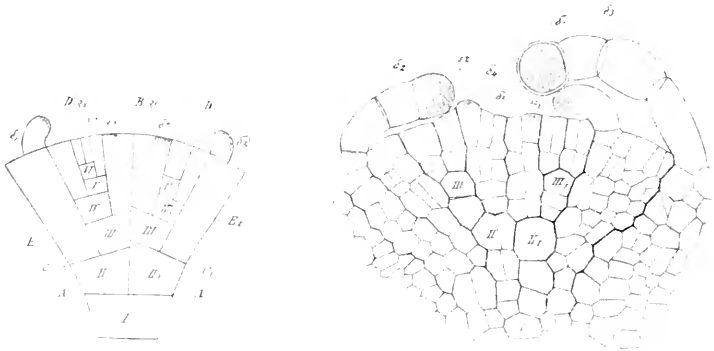

FIG. 347.

Portion of the leaf surface of a seedling of *Asplenium serpentinum*, showing how dichotomy accompanies the marginal growth. $\times 190$. To the left a diagrammatic representation of the same. (After Sadebeck.)

the upright shoot from the creeping rhizome, and this may have occurred in others of the Leptosporangiate Ferns. However this may be, the Leptosporangiate Ferns show radial and dorsiventral development so intimately intermixed that it is more difficult in them to trace the probable evolutionary relations than in those groups which are clearly indicated as the most ancient. But taking the facts over all, it appears reasonably probable that the primitive shoots of Ferns were radial, and that dorsiventrality was here as elsewhere derivative.¹

In some Ferns the axis remains unbranched, as in the Marattiaceae. In others dichotomous branching of the axis is seen to occur, and there is reason to recognise this as a primitive mode of increase, since it occurs characteristically in relatively early forms, such as in *Lygodium*, in the

¹Mr. Tansley remarks very pertinently that "dorsiventrality is not very common in fern steles, in spite of the prevalence of creeping rhizomes" (*New Phytologist*, 1907, p. 112). To those who hold that vascular structure follows rather than dominates development this is important evidence in favour of a primitively radial construction of the Fern-shoot.

Osmundaceae and Matonineae, and occasionally in other genera, for instance in *Cyathea* and in *Pteris*. On the other hand, axillary branches are found with a high degree of constancy in the Botryopterideae and Hymenophyllaceae. In other Ferns buds are found in varying relation to the leaf-bases, and at various other points upon the leaves: all these appear to be different in their nature and origin from the terminal, dichotomous branches above mentioned.

The architecture of the leaves of Ferns, with their complex and variable outlines, presents features which are important for comparison. For long the developmental interest centred in the apical segmentation, as exhibited in the Leptosporangiate Ferns with their single initial cell. It was not till 1874 that Sadebeck extended that interest to the marginal growth of the ultimate pinnules, and showed in the case of *Asplenium Shepherdii* that the last branchings of the veins are true dichotomies (Fig. 347). The same was shown later by Prantl in the Hymenophyllaceae: such dichotomy may

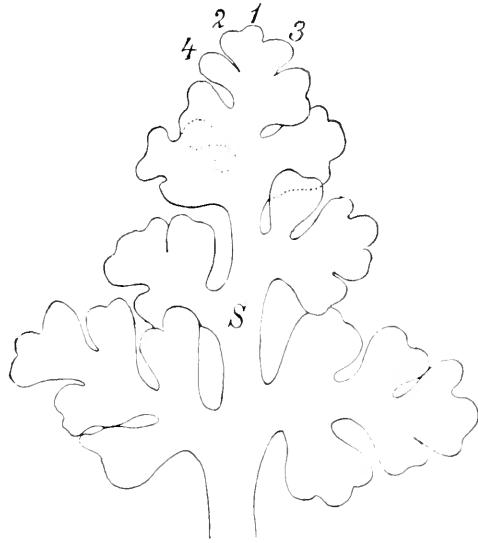

FIG. 348.

Allosorus crispus. Outline of a leaflet. The branching is clearly dichotomous. The apex has divided into lobes 1 and 2, of which 1 is the stronger and continues the growth, 2 forms a lateral lobe. Below we have lobes 3 and 4 which have been similarly formed. The leaf-spindle (rachis) S, is only a narrower portion of the lamina which is subsequently mechanically strengthened. Magnified. (After Goebel.)

be held to be wide-spread in Ferns, and its results are apparent in the external outline of many young leaves; for instance, it cannot be missed in the case of *Allosorus crispus*, quoted by Goebel (Fig. 348): here the successive pinnules are produced as branches of a dichotomy, and are successively relegated to a lateral position right and left: the whole pinna is thus a sympodial development of a dichotomous system, though when mature it presents an appearance of pinnation.

Dichotomous branching is a very obvious feature even in the mature leaves in some of those Ferns which are believed to be relatively primitive. For instance, in the Schizaeaceae, and especially in *Schizaea* itself, while the same is seen with modifications in the pinnae of *Izogodium*.¹ Again, in *Matonia* and *Dipteris* it is very obvious, though with sympodial development of the branches; and in the Hymenophyllaceae, especially in the

¹See Prantl, *Unters. z. Morph. d. Gefässkryptogamen. I. Die Hymenophyllaceen Die Schizaeaceen.*

distal branchings. Moreover, the prevalence of dichotomy in the venation of Ferns at large is to be taken into account in this connection. Lastly, dichotomy is a common feature in the first leaves of Fern-seedlings, and is seen, probably as an occasional reversion, abnormally in the later leaves of many Ferns, being sometimes a persistent character of varietal forms. These facts suggest the enquiry as to the branching of the leaves of the early Ferns: it has been pursued by Potonié, who finds among the early fossils, and even among those of Pecopterid-type, evidences of dichotomy which lead him to conclude that the truly pinnate type of leaf-construction in all its parts originated phylogenetically from the true dichotomy.¹

Potonié strengthens his position by noting certain palaeontological facts. The Archaeopterids from the Devonian, Culm, and lower Carboniferous have no midrib in their ultimate pinnules, but are characterised by parallel veins, forked in a fan-like manner. In higher strata, however, a midrib with lateral veins is found. Reticulate venation was apparently absent from the Ferns of the Culm, and appeared in the Middle Carboniferous, while the higher type of reticulation, with areas of smaller meshes filling up the meshes of a larger reticulate system, occurs first in the Mesozoic period. The fossil record would thus support the early prevalence of dichotomy, so far as venation is concerned.

Before accepting Potonié's conclusion an examination of the development of the apparently pinnate type in living Ferns is necessary. In 1875 Kny showed that in *Ceratopteris* the lower pinnae arise alternately below the leaf-apex, the branching being monopodial, and without individual relation to the segments of the apical cell.² This origin of the lower pinnae has been verified also in other Ferns, and may be taken as the usual type where the leaves are elongated and the lateral parts numerous. But it is to be noted in such cases that the pinnae themselves may branch dichotomously, that towards the apex of the leaf there may be a gradual transition to a dichotomous branching, the pinnae being then produced sympodially after the scheme seen in the pinnae of *Allosorus* (Fig. 248); and that in all cases the pinnae arise in strict relation to the lateral wings or flanges of the leaf. For, however much disguised by special developments at the base of the leaf, or by the bulk of the leaf-stalk in proportion to the wings, still every Fern-leaf is essentially a dorsiventral structure, with margins which may or may not be developed as projecting wings, but can commonly be traced even down to the base of the leaf-stalk; and it is upon these that the pinnae originate. The general facts may be summed up thus: that the branches arise marginally on the flattened leaf; that where the leaf is massive and greatly elongated the lateral parts are laid down monopodially, but where the surface-growth predominates there is dichotomous branching without the formation of a strong midrib; but the one type may pass into the other in the length of a single leaf.³

¹ *Palaeophytologie*, pp. 110-121.

² Compare Kny, *Parkeriaceae*, Taf. xxiv.

³ Compare Goebel, *Organography*, p. 317.

In 1884 I formulated a theory of origin of the "phyllopodium," or rachis of the leaf, chiefly based upon comparative study of the leaves of Ferns.¹ It was pointed out how in an enlarging dichotomous system a main rachis asserts itself as a supporting organ among parts similar in origin and structure to itself. This theory of genesis of the Fern-leaf may now be restated as follows: the Fern-leaf was originally a limited structure of flattened form, endowed with growth at its distal end: this growth was conducted with fan-like segmentation, but it was apt to be localised at points which diverge dichotomously. Sometimes the margin remained entire, and the fan-like expansion is then traversed by dichotomising veins: it is not improbable that this is really a secondary condition of condensation of a branch-system. More commonly the margin grows out dichotomously, the veins following, and a fan-like forking is produced such as is actually seen existent in many Ferns. But frequently with the enlargement of the branch-system the equality of the forking was not maintained: certain branches took the lead, and a sympodial development resulted in a rachis being produced, as a strong support for the rest, though primarily it was of similar origin with them. It is but a slight modification which would establish the rachis thus initiated as the definite "phyllopodium," upon which the earlier, and sometimes also the later branches would arise monopodially, being lateral from the first: and thus a Pecopterid-type of leaf would result. The facts certainly indicate that such a transition has been effective in descent, though it may be a question whether all pinnate types, for instance the Marattiaceae, originated in this way. Lastly, it may be noted that the winged structure, so prevalent in Fern-leaves as lateral lines leading even to the base, still indicates the ultimate origin from a flattened expansion: the margins may often still be traced in this way even where the petiole is almost cylindrical in form.

A theory of the whole shoot based upon similar progressions was also suggested in the same Memoir in 1884, viz. that just as the phyllopodium gradually asserts itself as a supporting organ among structures of similar origin and structure to itself, so also the stem may have gradually acquired its characters by differentiation of itself as a supporting organ from other members similar to itself in origin and development. A similar idea has been subsequently expanded into Potonié's theory of origin of the Fern-shoot.² There seems to be no sufficient foundation in fact for its acceptance. In the first place, there is in Ferns no known case where the axis and leaf appear as the two branches of a dichotomy, so that the suggestion is purely hypothetical: it is based only on analogy with what is learned from the comparative study of the leaf. The strength of the argument referring the branching of Fern-leaves to an original dichotomy rests on the fact that that mode of branching commonly appears at the apex, and is specially apparent in the lateral branchings. There are no such examples showing

¹ *Phil. Trans.*, 1884, part ii., pp. 604-5.

² *Palaeophytologie*, pp. 156-159.

leaf and axis as branches of a dichotomy. The leaves always originate monopodially. Secondly, other Pteridophytes, such as the Sphenophylls and early Calamarians, exist with bifurcate leaves, but without any suggestion of an origin of axis and leaf from a common dichotomous system. These grounds, over and above the inherent improbability of the comparisons with Fucoids introduced by Potonié, or with the gametophyte of Liverworts by other writers, should suffice to show that the suggestion which I threw out in 1884 is untenable, as I very soon realised it to be. All developmental evidence shows that the axis in Ferns, as in other plants, was throughout descent a part of distinct origin from the leaves which it bears.

The dichotomous theory of origin of the whole shoot, including axis and leaf, has been supported also by Tansley on the basis of anatomy; and it has been pointed out that analogies exist between the structure of axis and of leaf in certain early fossils.¹ Especially it has been shown that there is an approach to a radial type of construction of the lower region of the leaf in certain cases. It need be no surprise that such similarities to the structure of the axis should exist in an appendage which is a part of the same shoot as the axis: as the leaf became larger and more important its requirements would become similar to those of an axis: to meet these a structure analogous to that of the stem would then be probable, such as is actually seen. In the facts adduced I see nothing stronger than structural analogies: this class of evidence carries little weight as against the objective fact that in living Ferns the leaf is always seen to arise monopodially. Thus the dichotomous theory, which is based on analogies, appears to break down in the absence of developmental fact.

It is possible now to institute a comparison of the shoot of Ferns with that of other Pteridophytes, and to consider its relation to the theory of the strobilus. In its original radial structure, with derivative dorsiventrality, and in its occasional dichotomous branching it corresponds to other strobiloid types. The genetic relation of leaf to axis as actually observed is the same, and in point of fact it is in the proportion of leaf to axis and in the architecture of the leaf that the chief difference lies. But among strobiloid types, and especially among their fossil representatives, the leaf is not always small or simple: the leaves of certain living Lycopods (*L. serratum* and *Isoetes*) are relatively large, as were also those of some of the fossils, notably *Sigillaria*. The branched leaves of the Sphenophylleae and Psilotaceae, and even of some of the Calamarians, such as *Archaeocalamites*, and notably of *Pseudobornia*, are instances of branching of leaves in strobiloid forms. Again, in our view a great leaf-enlargement in a fundamentally strobiloid type has resulted in the Ophioglossaceae. Thus variety in size and complexity of the leaves existed in other Pteridophytes besides the Ferns. Even the dichotomy which is so frequent in the first

¹ *New Phytologist*, 1907.

leaves of young Ferns, and lies at the basis of the architecture of the mature leaves, finds its counterpart in the dichotomy seen in certain strobiloid Pteridophytes.

It is true that the Leptosporangiate Ferns show a very distinctive mode of segmentation both of apex and margin of the leaf. But it has been shown that in this character the Osmundaceae form an intermediate step from them to the Marattiaceae, while the latter diverge clearly from the Leptosporangiate type. It is thus seen that the definite segmentation of the Leptosporangiate type is no essential character of the Fern-leaf at large. Such considerations point to the justness of the view that the Fern-leaf, however different in size, in continued apical growth, and in its segmentation, is essentially comparable with the smaller and simpler leaves of the strobiloid forms. We shall therefore accept the conclusion that in the evolution of Ferns some such leaf-enlargement as is faintly indicated in certain strobiloid Pteridophytes, and notably in the Ophioglossaceae, was carried out to a higher degree than in any other Archegoniate Plants. It would appear probable that the Ferns, developing early towards megaphylly, worked out to the fullest such methods of leaf-enlargement as are outlined in some other early types; in fact, that they were ultimately derived from a smaller-leaved ancestry, with a strobiloid shoot not unlike that which remained in the rest persistently small-leaved.

As regards the differentiation of their leaves, Ferns show a comparatively low position. In a very large proportion, in which are included most of the types which are held as primitive, the leaves are general-purposes leaves: each serves at first for protection of the apical bud, and on unfolding is at once an organ of assimilation and of propagation. The differentiation of trophophylls and sporophylls is usually marked by a reduction of the assimilating surface where the sporangia are borne: examples are seen in *Struthiopteris* and *Blechnum*, in *Acrostichum* and *Platyrium*, and the distinction is to be held as a morphological advance which had, however, already made its appearance in the Ferns of the Carboniferous Period. A good example of this is seen in the Hymenophyllaceae, where the leaves are undifferentiated in *Hymenophyllum*: but in certain species of *Trichomanes* (§ *Feca.*), the genus which on other grounds is held to be more specialised than *Hymenophyllum*, a distinction of sporophylls from trophophylls is seen. Sometimes the differentiation may be between parts of the same leaf, as in *Osmunda*, and the fact that within this genus the relative position of the sterile and fertile parts may vary indicates that the distinction is not very deep-seated. Innumerable middle-forms between the sterile and fertile conditions further indicate how imperfect the differentiation actually is. A further specialisation of certain leaves as protective scales is seen in *Osmunda* and in some elongated rhizomes: in such cases the rudimentary leaf-apex shows that these are potentially normal leaves diverted to the protective duty. It thus appears that the differentiation of the leaves in Ferns is not on a high scale: that they are all essentially of one type, and

that that type was probably the tropho-sporophyll; in fact, the Ferns show a Selago condition of their shoot.

As in other Pteridophytes, so here the question is an interesting one at what period fertility of the plant may begin. In most Ferns the period is late, especially in the larger forms, and, as in the strobiloid types, this may be ascribed to a progressive sterilisation of the earlier leaves. But in other cases the formation of sori may happen relatively early, and these serve to direct attention to what was probably a more primitive condition. As examples where an early fertility is seen there may be quoted *Blechnum lanceolata*, Swartz, in which, however, no exact record was kept of the leaf on which sporangia were first seen. In specimens of *Pteris heterophylla*, L. var. *internata*, supplied by Messrs. Hill, the fourth or fifth leaf of the seedling already produced sori; but an extreme case is that quoted by Prantl,¹ of *Lygodium subalatum*, in which not only are the normal leaves fertile to the base, but it was noted also that the sub-primordial leaves, and even the primordial leaves bear "sorophores," so that completely sterile leaves are hitherto quite unknown in this species. Such an example points clearly to the conclusion that in Ferns, as in other Pteridophytes, all the leaves of the sporophyte are potential sporophylls.

A minor character too little used in comparison as yet is to be found in the superficial appendages. These may be filamentous or scale-like: the latter are readily recognised by their development as flattened expansions of the former. Speaking generally, the hair is characteristic of relatively primitive types, such as the Botryopterideae, Hymenophyllaceae, and Osmundaceae, while the scale or ramentum is found very generally among the Leptosporangiate Ferns, though it is also present in some of the Gradatae and Simplices. It is to be noted that in a considerable number of cases ramenta accompany a dictyostelic structure, though there is no constant coupling of the two characters. A good example of their phyletic significance is to be found in the Schizaeaceae, in all of which, excepting *Mohria*, the appendages are of the primitive filamentous type; but in *Mohria*, which is regarded on various other grounds as a relatively advanced genus, and has a dictyostelic stock, the appendages are flattened scales. It is possible that such characters may never acquire the systematic importance claimed for them by Kühn,² but they certainly must not be overlooked as evidence having some degree of phyletic value.

SPORE-PRODUCING MEMBERS.

The sporangia of Ferns are usually grouped in sori; but apparent examples occur even among the most primitive types, as well as among those which are more recent, of their non-soral disposition. The first question will therefore be, what was the mode of disposition of the sporangia in the first instance?

¹ *Schizaeaceen*, p. 14.

² Prantl, *l.c.*, p. 13.

At first sight it might seem probable that the non-soral state was primitive, since it is seen apparently in such early forms as *Botryopteris* and *Myriotheca*, and in *Osmunda*. But there are objections to this as a generalisation; for, in the first place, definitely soral types, such as the Marattiaceae, are quite as well represented in the primary rocks as any non-soral forms: secondly, while *Botryopteris* itself appears to be non-soral, there is a distinct indication of a disposition of the sporangia around a central point in *Zygopteris* (Fig. 272, p. 503), while in *Corynopteris* there are very definite sori: thirdly, there are among living Ferns clear indications that the soral may pass into the non-soral state: such a progression is suggested in the species of *Dipteris* (p. 620), while the condition of *Acrostichum* and of *Platycerium* can hardly have been produced in any other way than by spreading of the sporangia of some soral type over an enlarged surface, as is indeed suggested by such genera as *Gymnogramme* and *Hemionitis*, etc. This is exactly what would be expected as a consequence of indefinite multiplication of parts closely aggregated together, in cases where no biological check determined their exact position. Thus it would seem probable that the soral state is the original condition and the non-soral the derivative, notwithstanding its early appearance.

But the sorus, whether marginal or superficial, does not always maintain its identity, even in those cases where it is habitually circumscribed. In many Ferns, and especially in those in which there is an enlarged leaf-area, sori may be found of unusual size, elongated, and constricted in the middle; and from these it is a slight step to complete fission, two smaller sori being then seated close together (Figs. 281, 310). In such changes from the normal as these there lies a capacity for increase in number of sori, and there is hardly room for doubt that in such cases as *Kaulfussia* and *Dipteris*, as well as in many of the broader-leaved Polypodiaceae, where the sori constitute more than a single row on either side of the midrib, the more complex condition has been brought about in this way; in fact, the statement seems fully justified that the primitive disposition of the sori was in a single marginal or intra-marginal row: all more complex arrangements in Ferns are secondary and derivative.

A further matter for discussion is the position which the sorus holds relative to the leaf which bears it. Two positions are common, marginal and superficial, the latter almost always on the lower surface of the leaf: both of these are of very early occurrence, the superficial being characteristic of the Marattiaceae and Gleicheniaceae, and the marginal of the Botryopterideae and Schizaeaceae, while both types are continued upwards into the Gradatae and Mixtae. It would be important to know which of these positions was the more primitive in Ferns. Here, again, an indirect indication may be obtained by comparison of more recent types: among the Leptosporangiate Ferns there is ample evidence to show that the marginal sorus has shifted by gradual steps to the lower surface. This is clearly proved by comparison within the *Dennstaedtia-Davalha* series:

Prantl had already noted it, and held that the translocation had occurred along several distinct phyletic lines within the Polypodiaceae.¹ There is no evidence at hand of the converse progression from the surface to the margin. But though a probability is thus established of progression of the sorus from the margin to the lower surface, this does not prove that the former position was prior for the Ferns at large. It must be remembered that Marattiaceous types with sori intra-marginal are recorded as far back as the Culm; and it is quite possible that they may have originated from forms with sori superficial from the first. The question is accordingly an open one whether all Ferns sprang from types with marginal sori, though it seems certain that in some the superficial position has been secondarily acquired.

The sorus itself consists of a receptacle upon which the sporangia are inserted, and of the sporangia themselves, while various accessory growths may be present also, and are called by the collective name of indusium. According to the construction of their sori the Ferns have been seen to fall into three main groups: the Simplices, Gradatae, and Mixtae. In the Simplices the sporangia are all simultaneous in origin: in the Gradatae there is a basipetal succession of the sporangia, but there is no intercalation of younger sporangia between those already initiated: in the Mixtae new sporangia are intercalated without order between those first formed. There is reason to believe the Simplices to be the most primitive type, the Gradatae to occupy a middle position, and the Mixtae to be the most advanced, and that either of the latter might be derived phyletically from the first. The differences in order of origin of the sporangia in these three types have entailed variety in adjustment of the sorus, especially in regard to the protection and nutrition of the sporangia, and the distribution of the spores when ripe.

Taking the *receptacle* first, it is required as a means of transfer of nourishment to the sporangia and as a basis for their support in such a position that the spores can be scattered when mature. These requirements will have to be considered separately in the case of each of the three groups. In the Simplices the sporangia are usually produced in such moderate numbers that there is room for them all in a single radiating series round the centre of attachment: there appears to be little need in them for a raised receptacle. It is true that in some cases, such as *Kaulfussia* and *Ptychocarpus unitus*, there may be a massive receptacle with a vascular extension into it, while in *Marattia Kaulfussii* it may be elongated into a stalk below the sorus; but in many of the Simplices the receptacle is hardly developed as such, the sporangia receiving their supplies directly from the leaf through their own massive stalks. The Gleicheniaceae show certain points of interest for comparison: those species which have few sporangia in the sorus have only a comparatively small receptacle; but in *G. dichotoma*, where the sporangia are more numerous, the receptacle is slightly elongated, while it is well provided with vascular tissue.

This elongation and structural adaptation of the receptacle becomes much more pronounced where there is a continued succession of sporangia, as in the Gradatae. The basipetal sequence seen in the Cyathea, Dicksoniae, Dennstaedtiinae, Hymenophyllaceae, would hardly be possible without a receptacle having intercalary growth: the continual moving upwards of the more mature sporangia, so that they can freely shed their spores, leaves space for the initiation of younger ones below, while the latter are in their early stages close to the source of supply, and protected by the basal indusium. This seems to be the *raison d'être* of the elongated receptacle in such cases: given a basipetal succession, its origin has been a response to the need of space, by upgrowth from the base, not the result of "metamorphosis" of any pre-existing vegetative part such as a lamina of a leaf (Prantl).

An indirect support for this opinion is found in the fact that the receptacle disappears in those Ferns where the mixed sorus is acquired: for here the receptacle is commonly flat, though some exceptions do occur. A peculiar interest attaches to those closely allied Ferns of the *Dicksonia-Davallia* affinity, in which a transition from the basipetal sequence to the mixed sorus is believed to have taken place. In *Dennstaedtia* and *Microlepia* the receptacle is clearly conical, though it does not show an elongation at all comparable to that of the Hymenophyllaceae (Fig. 332). Occasionally in *Denn. davallioides* and in *Microlepia hirta*, but more commonly in *Denn. rubiginosa*, the strict basipetal succession which is seen in the first stages of the sorus is departed from, though the receptacle still maintains in some degree its conical form. But in *Eudavallia*, which is without doubt closely allied to the above, the sorus is a mixed one, and the receptacle is almost flat, though still provided below with a considerable mass of tracheides (Fig. 339). Here, since the basipetal succession is not maintained, an elongated receptacle is not required, and since this difference occurs between Ferns which are certainly of a common stock, it is probable that a reduction has taken place. Accordingly, an elongated receptacle is not in itself an important morphological feature; it is to be correlated with a continued basipetal succession of sporangia, and it is this last which is the essential morphological feature in such cases.

There are, however, instances where there is an enlarged receptacle on which the sporangia are borne not in basipetal succession, but in mixed order; as an example, the familiar sorus of *Nephrodium* may be quoted, with its large receptacle and internal mass of tracheides (Fig. 4). It may be urged that these facts are inconsistent with the view expressed in the last paragraph, but the large receptacle may here be a survival, which, though the sorus has become a mixed one, may still be a convenience: as it certainly is in *Nephrodium*, where its size allows space for the sporangia between the indusium and the leaf-surface. The general view may then be formulated thus: the Simplices have as a rule a receptacle of small size; the Gradatae have a more or less elongated receptacle, and it may attain very considerable dimensions where the succession is long

continued. The Mixtae have commonly (though not always) a flat receptacle. It is not a constant morphological feature, as shown by the fact that a line of transition from an elongated receptacle to a flat one has been demonstrated in the genera *Dennstaedtia* and *Microlepia*, and it is possible that other transitions have also taken place elsewhere.

The term *indusium* has been applied to bodies of the most various form, position, and structure borne in relation to the Fern-sorus, and serving for the protection of the sporangia. It is hardly necessary to point out that these, however similar in their function, cannot be regarded as homogenetic throughout: they are often only examples of homoplasmy. We call the basal indusium of *Cyathea* by the same name as the umbrella-like indusium of *Matonia* or *Polystichum*, or the marginal flap of an *Adiantum*. It may be possible, by regarding the indusium as having had a high degree of plasticity, to accept some of its different forms as being modifications of one another, and a reasonable case can be made out sometimes, such as that in the transition from the Dennstaedtiaceae to the Pterideae. But such cases as *Cyathea* and *Matonia* seem incompatible with any opinion of homogeneity of the two structures, especially when it is remembered that in *Alsophila* and *Gleichenia*, genera which are respectively allied to the above, an indusium may be entirely absent: and this is in fact the usual condition among the Simplices. We shall then hold the indusium to be an inconstant body, varying in occurrence and in position, and the term will be used to designate outgrowths protective of the sorus, whatever their position and whatever their evolutionary history may have been.

It has been demonstrated in many cases that the indusium is formed before the earliest sporangia appear: this is probably a case where physiological opportunism, rather than any recapitulatory habit, determines the order of succession. It is impossible to believe that those constant bodies, the sporangia, are of later evolutionary origin than the less constant body, the indusium. In this respect the indusium and the embryonic haustoria are probably alike. It is important to recognise such cases as these, for they go far to break down the dogma, that the prior existent parts in the development of the individual were necessarily prior existent in the evolution of the race.

The views of Prantl have already been quoted, which involve a comprehensive shifting of sori from the margin to the surface. This has brought about great modifications of the indusium. Starting with a strictly basipetal sorus, with cup-like indusium, slightly two-lipped it may be, as in *Loxsonia* (Fig. 320), we have seen that the type in *Dennstaedtia apiifolia* (Fig. 332) is similar in position and structure. The indusial lips, which are equal in the above plants, become unequal in *Microlepia speluncae* (Fig. 332), the superior lip (*s*) being both longer and thicker than the inferior (*i*), and taking on itself the structural characters and appearance of a continuation of the leaf; this is repeated in *Davallia Griffithiana*

(Fig. 339), and is still more pronounced in *Cystopteris* and *Lindsaya*. Thus the equal lips may be differentiated, the one taking on the structure of the leaf-margin, the other becoming a mere appendage of the surface.

There is reason to believe that a reduction of the indusium has taken place along more than one line of descent; one such probable series of reduction may be traced from *Cyathea* to the very interesting conditions seen in *Hemitelia* with its one-sided indusium, and in *Woodsia* and *Hypoderris*, in which there is an exiguous, fimbriated indusium. It is but a slight step from these to some forms of the comprehensive genus *Polypodium*, in which, with a similarly superficial sorus, the indusium is absent. Another line of possible reduction may be traced from the Dennstaedtiinae, through *Hypolepis*, to certain types of *Polypodium*. The probability is that there is here a progression from a type with basipetal succession of sporangia protected with a basal indusium, to a mixed type in which the indusial protection is less essential, and the indusium is accordingly abortive.

THE SPORANGIUM.

The morphological equivalence of the sporangia of Ferns at large will be generally admitted, whatever their modifications of detail may be. It has been customary to distinguish the Leptosporangiate from the Eusporangiate types, on the basis of the origin respectively from one or from several

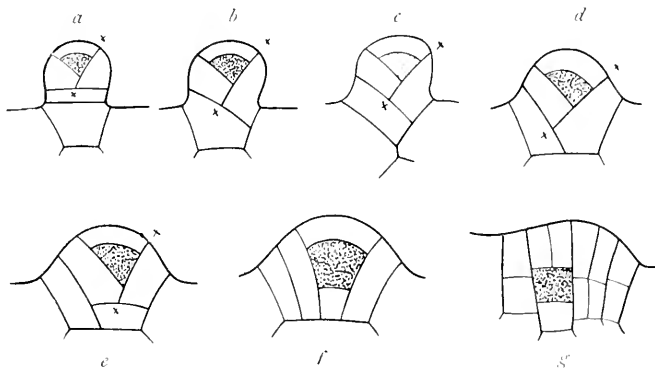

FIG. 349.

Diagrams illustrating the segmentation of Ferns. *a*=Polypodiaceae (compare Kny, Wandtafeln XCIV.) *b*=*Ceratopteris* (compare Kny, Parkeriaceen Taf. XXV., Fig. 3). *c*=*Alsophila* (compare Fig. 334). *d*=*Schizaea* (compare Prantl, Taf. V., Fig. 90), or *Thyrsopteris* (compare Fig. 329), or *Trichomanes* (compare Prantl, Taf. V., Fig. 92). *e, f*=*Todea* (compare Fig. 205). *g*=*Angiopteris* (compare Fig. 284).

parent cells. But comparative observation shows that this distinction is based not on any difference of kind, but only of degree. The transition from one to the other is illustrated by the diagrams (Fig. 349 *a-g*), which show the initial segmentations of the sporangia of various types of Ferns, from the Marattiaceae to the Polypodiaceae. Taking the Simplicies first,

so as to follow roughly the probable phyletic sequence, the massive sporangium of the Marattiaceae has its archesporium deeply sunk: the walls all cut at right angles, and since the outer surface is but slightly convex, the walls are almost parallel, and the archesporial cell approximately cubical (Fig. 349 *g*). The segmentation in the Osmundaceae is variable, and it has been observed to be so even in sporangia on the same plant in *Todea barbara*. In some cases the archesporium is still square-based, and may be square in its transverse section: but as the outer surface becomes early convex, the lateral walls converge, and the archesporium has the form of a four-sided truncated pyramid (Fig. 349 *f*). In other sporangia of the same plant the lateral walls limiting the archesporium converge more strongly, the outer surface being more convex, and one of them inserts itself upon another: consequently the archesporium takes the form of a three-sided pyramid (Fig. 349 *e*). It is to be noted that in this figure the wall (*x, x*) is inserted on an inner periclinal; but in Fig. 349 *d*, which represents the segmentation in *Schizaea*, or in *Trichomanes* or *Thyrsopteris*, the wall (*x, x*) cuts another anticlinal. This marks another step in attenuation of the sporangium, though only a slight one, and in other essentials the segmentation is as in the simplest of the sporangia of *Osmunda* or *Todea*. Figs. 349 *b, c*, show the segmentation seen in various Gradatae: (*c*) corresponds to the condition of *Alsophila* and *Cyathea*, and (*b*) is a slight variant upon it which is sometimes found: it is seen also in *Ceratopteris*. In the Polypodiaceae, however, where the sporangium may often be long-stalked, the wall cut by the wall (*x, x*) may be no longer inclined, but transverse. From this series of diagrams it is seen how gradual are the steps from the segmentation typical of the Eusporangiate Fern to that of the most advanced Leptosporangiate. The unity of the scheme cannot naturally be divided by any distinction of origin from a single cell or from more. The difference of type thus gently graded over is an index of the progressive attenuation of the sporangium seen in descent, and it will be shown to go along with progressive reduction of the individual productiveness.

Closely related to the segmentation of the young sporangium is the structure of its *stalk* when mature. Putting synangia aside, the stalk varies from the short massive type of *Angiopteris*, through various types such as the Osmundaceae, Gleicheniaceae, Schizaeaceae, and Hymenophyllaceae with relatively thick stalks, to the Polypodiaceae, where the stalk is commonly attenuated and long. It may, in extreme cases, be reduced to a unicellular filament, as in *Scolopendrium*. These steps again show a general parallelism with the individual spore-output, the thickness of the stalk being roughly proportional to the stream of nourishment required.

But it is the *sporangial head*, with its relatively thin wall surrounding the cavity filled with spores, that is the most distinctive part, and as the character of the opening mechanism, or *annulus*, has been made the chief

diagnostic feature in Ferns, it requires special notice, and will be taken first. In the synangial Marattiaceae and Pecopterids the opening mechanism is very simple: a slit-like rupture is formed, and it gapes by drying up of the adjoining cells, while the firmer region of the wall stands rigid. This may be complicated by changes of form of the whole sorus, as in *Marattia*. But in those early forms of Ferns in which the sporangia were separate, there is commonly a band of mechanical tissue, composed of several rows of indurated cells: this band varies in extent and in position in different sporangial types. It has been stated by Scott,¹ referring to the annulus of certain primitive Ferns which is more than one cell wide, that "this was perhaps a general character of the annulate Fern-sporangia of Palaeozoic age: at least no clear case of a uniseriate annulus has yet been demonstrated." In fact, it seems that in the Primary rocks the distinctive Leptosporangiate annulus was at least rare, if indeed it existed at all.

It may be a question whether the more complex mechanism thus seen in Eusporangiate Ferns is really the true correlative of that in the Leptosporangiate type. A comparison of the indurated tissues in the sporangia of *Angiopteris* and *Gleichenia* shows certain points of essential similarity, though the details do not correspond. The firm resistant arch of indurated tissue described in *Angiopteris* consists of cells of a similar nature to those which form the annulus of *Gleichenia*; its position is in the main the same, though it does not stretch as a continuous hoop round the back of the stalk, but stops short on either side of its base. When we consider the similarity of the sorus in these two genera, and of their sporangia with the same orientation and dehiscence, the comparison of these two bands seems inevitable, notwithstanding that the one is usually, though not always, a single row, and the other a broad and ill-defined band. But a further important fact is that among early Ferns of reputed Leptosporangiate affinity the annulus is not always a single row of cells; this is seen in the Schizaeaceae, for *Senftenbergia* has an annulus of several rows: Zeiller has shown that living species of *Lygodium* may have a double-rowed annulus, which is an intermediate step to the type with a single row.² Again, in living species of *Gleichenia* occasional cells of the annulus have been found to be divided, showing thus a reminiscence of a pluriseriate state. Such evidence favours the opinion that the simple annulus is the correlative of the pluriseriate, and that a simplification of its structure has accompanied the reduction in size and spore-output of the sporangium in the course of descent. In the Leptosporangiate Ferns the homogeneity of the annulus seems the only view which is in accord with the constancy of its occurrence in plants which are so clearly related to one another.

The position of the annulus and of the point of dehiscence appears to have undergone change in the progressive evolutionary course. In the

¹ *Progressus Rei Botanicae*, i., p. 184. Compare Kidston, *Phil. Trans.*, Ser. B, vol. 198, p. 188.

² *Bull. Soc. Bot. de France*, xlv., p. 214.

archaic types the annulus was vertical or oblique, and the dehiscence was mainly, though not exclusively,¹ in a plane including the axis of the sporangium; this is seen in all the surviving Simplices, excepting the Matonineae, and also in *Loxsonia*. But in the Gradatae the annulus was oblique and the dehiscence lateral, while in the Mixtae the annulus is again vertical, but the dehiscence transverse. If we contemplate a derivation by descent of Ferns with a lateral dehiscence from those with median dehiscence, we shall have to enquire whether there are any evidences of shifting of the annulus itself as well as of the point of dehiscence. One material point is that the formation of the annulus in Ferns at large does not stand in any constant relation to the segmentation of the sporangium-mother-cell, though that segmentation itself shows so singular a constancy. This fact leaves the question of a shifting of the annulus more open than it would otherwise appear. The more primitive type of complete annulus is that seen in the Gleicheniaceae and Schizaeaceae, with oblique position and median dehiscence: *Loxsonia* maintained the oblique position and median dehiscence, but part of its annulus is incompletely indurated. In others, while the complete oblique ring was maintained, the point of dehiscence was shifted laterally, the result being as in the Cyatheaceae, Hymenophyllaceae, and others with a basipetal sorus. With the transition from the basipetal sorus to the mixed came also a further change of the annulus: maintaining the lateral dehiscence, the annulus became vertical, stopping short on either side of the stalk, which interrupts it. But in many cases a slight obliquity was retained, as seen in *Dennstaedtia apifolia* (Fig. 333 c) and *Diacalpe*, the two sides being so far dissimilar that it is possible still to distinguish the "central" from the "peripheral" face: this is also the case in *Davallia*, *Lindsaya*, *Nephrodium* (Fig. 6), and many others. But there are other outstanding cases of an oblique annulus among Polypodiaceae which have been the subject of discussion, and have even been considered a sufficient reason for rejecting the oblique or vertical positions of the annulus as characters which are not dependable: for instance, the genus *Lomaria*, in which the § *Plagiogyria* has a well-marked continuously oblique ring of the annulus, somewhat similar to that seen in the Dicksonieae. So far from looking upon such cases as these as being subversive of views based on the character of the annulus, they are exactly what might have been anticipated if the types with a vertical annulus were derived from forms in which the annulus was oblique: it is hardly to be expected that the transition would be carried out completely in all cases: these exceptions may be regarded as being occasional survivals of the earlier oblique type.

It would appear thus probable that the simple annulus of the Leptosporangiates is prefigured by the vertical, many-rowed hoop of the Eusporangiates. That in the course of descent, as the bulk of the sporangium was reduced,

¹ Scott quotes a porous dehiscence for *Stauropteris* (*Progressus Rei Bot.*, i., p. 186).

this hoop became simplified to a single cell-row: and that it changed its position in accordance with the soral arrangements, being oblique in some Simplices and in all Gradatae, first with median but subsequently with lateral dehiscence: and that finally it swung again into the vertical position in the Mixtae, but with the stomium still remaining lateral.

Passing to *the contents of the sporangium*, these are derived from the archesporium, which in all Ferns, with occasional exceptions in abnormal Eusporangiates, consists of a single cell. From this in the Leptosporangiate the tapetum is first cut off peripherally, and the central cell which remains divides up into cells which are commonly found to number some power of two. This is a consequence of the successive divisions occurring as a rule simultaneously within the sporogenous group, and the result is that the spore-mother-cells number 2, 4, 8, 16, 32, 64, etc. Since each of these undergoes tetrad divisions, the numbers of spores produced may as a rule be 4, 8, 16, 32, 64, 128, 256, 512, etc. These may be styled the typical numbers.

There are two ways of computing the output of spores from a single sporangium: either by examining preparations of sporangia with spore-mother-cells, and estimating their number, or by actual counting of the spores produced. Where the output of spores is small a reasonable degree of precision is to be expected by either method: but where the numbers are large there are various sources of error, and the results must be taken as mere approximations. The results of such computations will now be given for various Ferns: the estimates for the Marattiaceae have been made from study of sections traversing the sporogenous group before tetrad-division, but in all the rest the results are those from direct counting of the mature spores (see Table, p. 642).

In estimating the value of these results it is first to be noted that the largest numbers are associated with complete synangial fusion, a smaller number being found in *Angiopteris* where the sporangia are separate than in any of the synangial genera of living Marattiaceae. The potential number estimated for *Gleichenia flabellata* is nearly equivalent to that of *Angiopteris*, though the actual countings run considerably below; still they are in excess of those for any other Leptosporangiate Fern observed, and as this is seen in a Fern in which the type of sorus is the same as in *Angiopteris*, it strengthens the affinity between these two genera, notwithstanding that the one is, as regards the mode of segmentation of the young sporangium, a typical Eusporangiate, while the other shows essentially the segmentation of the Leptosporangiates.

From *Gleichenia*, as we pass through the table, successively lower numbers are seen, and it is obvious that the larger numbers are associated with those Ferns which on other grounds are held to be relatively primitive. Of the Simplices examined none have a lower typical number than 128: and in this connection it may be noted that a rough estimate of the spore-output from a sporangium of *Zygopteris*, after

642 GENERAL COMPARISON OF THE FILICALES

Renault's drawings, would give a figure of 500-1000, while drawings of other early Ferns, such as *Stauropteris* and *Pteridotheca*, plainly show

Name.	Result of Countings.	Typical Number.
<i>Kaulfussia</i> , - - - - -	—	7850
<i>Marattia</i> , - - - - -	—	2500
<i>Danaea</i> , - - - - -	—	1750
<i>Angiopteris</i> , - - - - -	—	1450
<i>Gleichenia flabellata</i> , - - - - -	838, 794, 605, 684	512-1024
„ <i>dichotoma</i> , - - - - -	319, 251	256 or more
„ <i>hecostophylla</i> , - - - - -	205, 272	256 „
„ <i>circinata</i> , - - - - -	241, 242	256 „
„ <i>rupestris</i> , var. <i>glaucescens</i> , -	244, 232, 220	256
<i>Osmunda regalis</i> , - - - - -	476, 462, 396, 373	256-512
<i>Todea barbara</i> , - - - - -	478, 445, 442, 225, 238	256-512
„ <i>superba</i> , - - - - -	200, 306, 342	256 or more
„ <i>hymenophylloides</i> , - - - - -	112, 115, 120, 124, 204	128 „
<i>Lygodium dichotomum</i> , - - - - -	232, 246	256
„ <i>javanicum</i> , - - - - -	237, 238, 245	256
„ <i>pinnatifidum</i> , - - - - -	128, 127	128
<i>Ancinia phyllitidis</i> , - - - - -	114, 111, 104	128
<i>Mohria caffrorum</i> , - - - - -	107, 107, 101	128
<i>Hymenophyllum Tunbridgense</i> , - - -	413, 416, 421	256-512
<i>Trichomanes reniforme</i> , - - - - -	247, 243	256
<i>Hymenophyllum sericeum</i> , - - - - -	216, 239	256
„ <i>dilatatum</i> , - - - - -	121, 127, 127, 127	128
„ <i>Wilsoni</i> , - - - - -	119, 121	128
<i>Trichomanes crispum</i> , - - - - -	51, 52, 59	64
„ <i>rigidum</i> , - - - - -	32, 48, 56	32-64
„ <i>radicans</i> , - - - - -	49, 58, 62	48-64
„ <i>javanicum</i> , - - - - -	38, 42, 48	32-48
„ <i>spicatum</i> , - - - - -	48	48
„ <i>pinnatum</i> , - - - - -	32, 48, 32	32-48
<i>Loxsonia Cunninghamii</i> , - - - - -	64, 62, 63	64
<i>Alsophila excelsa</i> , - - - - -	64, 60	64
„ <i>atrovirens</i> , - - - - -	57, 62	64
<i>Cyathea medullaris</i> , - - - - -	57, 61	64
„ <i>dealbata</i> , - - - - -	16, 8, 8, 16	8-16
<i>Dicksonia antarctica</i> , - - - - -	64	64
„ <i>Menziesii</i> , - - - - -	62, 63	64
<i>Dennstaedtia apiifolia</i> , - - - - -	61, 62	64
<i>Thyrsopteris elegans</i> , - - - - -	—	48-64
<i>Davallia speluncae</i> , - - - - -	64, 64	64
Polypodiaceae generally, - - - - -	—	48-64
<i>Notochloena sinuata</i> , - - - - -	24, 32, 32	24-32
<i>Sadleria cyathoides</i> , - - - - -	16	16
<i>Ceratopteris thalictroides</i> , - - - - -	32 (16, Kny)	16-32

that the spore-output was large. It may then be held that in the more primitive forms, and especially in those types which are represented in the Primary Rocks, the number of spores produced by the individual

sporangium was uniformly large. Passing from these to the prevalent Leptosporangiate Ferns of the present day, the output falls with some degree of consistency, and the striking fact emerges that, so far as observation goes, no Polypodiaceous Fern has a larger output than 64, while in many cases it is smaller. The evidence points to a general reduction in the course of Descent.

But variations occur within near circles of affinity, and in accordance with the above generalisation these have a special interest in those families which hold an intermediate position. This is seen within moderate limits in the Gleicheniaceae, Osmundaceae, and Schizaeaceae, in which the numbers approximate for the most part to the typical numbers 512, 256, 128. In some cases it is difficult to see any circumstances which serve as an explanation; thus the variation between *Gleichenia flabellata* (512-1024) and *Gl. dichotoma* (256 or more), is not susceptible of ready explanation, unless it be connected with the more numerous sporangia in the sorus of the latter. Nor is that within the genus *Lygodium*. In other cases, however, the conditions of life and the structure of the assimilating apparatus throw some light on the matter; thus *Todea barbara*, with its thick assimilating leaves, gives higher numbers per sporangium than *T. superba* and *hymenophylloides*, with their thinner pellucid leaves. But the most interesting series in this connection are the Hymenophyllaceae, for the limits of variation in number are here very wide, ranging between such numbers as 421 and 32. Here the variation in number of spores per sporangium runs fairly parallel with the size of the sporangia, the smaller number of spores being contained in smaller sporangia (compare *Tr. reniforme* and *Tr. pinnatum*). Further, there is a correlative elongation of the receptacle, on which there is thus space for a larger number of the smaller sporangia to be inserted and produced in succession. On these characters the Hymenophyllaceae may be laid out as a series, extending from types chiefly of the less specialised genus *Hymenophyllum* with short receptacle, large sporangia, and large output of spores from each, to types of the more specialised genus *Trichomanes*, with longer receptacle, smaller sporangia, and smaller output of spores from each. The former link on naturally to the Gleicheniaceae in the characters named, as well as in the general appearance of the sporangia: it seems not improbable that in the Hymenophyllaceae we may see a series of specialisation in which the "filmy" character is the most salient vegetative feature, and that this has carried with it, as in the genus *Todea*, a decrease in size of the sporangia, and in the number of the spores produced from each.

Taking the facts thus acquired from the Simplicis and Gradatae they show that within circles of near affinity there may be a wide margin of variation in output of spores per sporangium, such as a theory of phyletic reduction of the sporangium would demand: and this goes parallel with the increase in number of the sporangia in the sorus, a decrease in size

of the sporangium, and in the thickness of its stalk and of the sporangial wall, and a progressive change from the early segmentation characteristic of the Eusporangiate type to that of the Leptosporangiate.

As a consequence of such phyletic changes in the constitution of the sorus, it is noteworthy how often the output of spores per sorus is similar in Ferns which are systematically remote from one another: for instance, *Marattia fraxinea* (45,000) and *Polypodium aureum* (57,600); *Angiopteris erecta* (14,500) and *Hymenophyllum dilatatum* (11,500); *Alsophila excelsa* (3,200) and *Gleichenia flabellata* (3,000). These examples show how a similar result may be obtained by various means, a large number of small sporangia balancing a smaller number of large ones. The similarity of output in such cases may be merely a consequence of similarity in the powers of the underlying nutritive mechanism. The real interest, however, arises when in nearer circles of affinity, with varying size of sporangia, and of output per sporangium, the result per sorus is kept approximately constant by converse variation of the two factors. This is illustrated in the genus *Gleichenia*, and in a less precise way in *Alsophila excelsa* and *Cyathea dealbata*. But the best demonstration of it is seen in the Hymenophyllaceae, undoubtedly a very natural series, in which the sorus has a uniform type of construction, though the size and number of the sporangia, and the length of the receptacle are variable. In illustration of this, estimates have been made with such accuracy as possible, with the results which are given in the subjoined table:

Name.	Sporangia per sorus.	Spores per sporangium.	Output per sorus.
Hym. Tunbridgense, - - -	20	420	8,400
Trichomanes reniforme, - - -	40	256	10,240
Hym. dilatatum, - - -	90	128	11,500
Trich. radicans, - - -	140	64	8,960

It thus appears that notwithstanding the great variations of sporangial output, the result per sorus is approximately uniform for the cases quoted from that very natural family of Ferns. This suggests a true biological progression, and it probably does not stand alone, but illustrates a principle which has been of wide application in the Fern phylum.

The production of numerous spores is a drain upon the resources of the plant. That drain may be relieved within the sorus by the development of a succession of sporangia, the demand being thus spread over an extended period. In the Simplicies the sporangia of a single sorus arise simultaneously: the physiological drain thus comes at one time: this method, which is, physiologically speaking, a simple and probably a primitive one, is

specially prevalent among the earliest fossils. A definite succession of sporangia in time and in space is found in the sori of the Gradatae: here the physiological drain is not sudden and severe, but it is spread over a long time: in *Trichomanes* it may be over a period of years. The basal position of the youngest sporangia gives them the further advantage of being near to the source of supply at the time when they are most in need of it, while those which are approaching maturity are successively removed from it to a position where they can readily shed their spores. In the prevalent type of the Mixtae there is a succession of sporangia in time but not in space. The physiological drain is spread as before over a long period, so that in this respect the Gradatae and Mixtae appear equally practical; but in the mixed sorus the receptacle is found to be wide and flat: this has the double advantage of enlarging the surface from which nutriment can be derived, and of shortening the distance through which it must be transferred. In point of protection those sporangia which are more advanced give an adequate protection to those which are younger: there are, however, multitudinous minor adaptations to this end which cannot be entered upon here. It thus appears that each of these types of sorus, the simultaneous, the basipetal, and the mixed, which Palaeontology shows to have been of successive appearance in the course of descent, was a biological amendment upon its predecessor.

Lastly, the facilities for dispersal of the spores when mature remain to be considered. There are three main types of dehiscence: by a slit in the median plane, which is characteristic of the Simplicis; by a slit in an oblique lateral plane, seen in the Gradatae; and by a slit laterally in a transverse plane, characteristic of the Mixtae. Dehiscence can only be properly carried out when free movement of the mechanical tissue is allowed: where, as in the Leptosporangiates, there is a definite annulus and a free sporangium, the whole body alters its form on dehiscence: accordingly the grouping of the sporangia in the sorus is a determining factor in the position of the mechanical ring if it is to be effective. In the case of median dehiscence, as in *Gleichenia*, the sporangium widens laterally, requiring free elbow-room on either side before the sudden springing of the annulus throws the spores out right and left. It thus appears that the median dehiscence of an annulate sporangium can only be a practical working arrangement where the sporangia are not in close lateral juxtaposition. *Loxsoma*, with its basipetal sorus, is an exception in having the median dehiscence; but the sporangium is so constructed with its incomplete ring that though the dehiscence is median, still the sporangium as a whole does not widen on dehiscence; it is, in fact, a compromise, the annulus being so modified as to be still compatible with the basipetal sorus.

With the exception of *Matonia*, *Dipteris*, and *Plagiogyria*, all the Ferns showing the oblique dehiscence have basipetal sori. The sporangia overlap one another like the shields of the Roman *testudo*, while all are so closely packed together that no space is given, as in the former case, for lateral

expansion before the sudden jerk. But some space is necessary for the straightening of the annulus before its quick recovery: the free space available is found obliquely upwards, towards the apex of the receptacle. In that direction the annulus is free to straighten itself out, dehiscence taking place at one side, near to the attachment of the stalk: it can then execute without obstacle the sudden jerk by which the spores are scattered (Fig. 350).

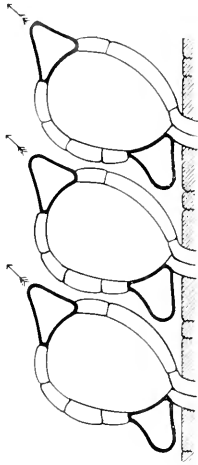

FIG. 350.

Diagram illustrating the relative position of the sporangia on the receptacle in the Hymenophyllaceae. It was constructed from Prantl's section of a mature sporangium of *Trichomanes Speciosum*.

The dehiscence by a lateral transverse slit, worked by a vertical annulus, is the prevalent type of the Mixtae. The ripe sporangia usually have long stalks, and show no regularity of orientation. The vertical annulus with transverse dehiscence is a mechanical arrangement which makes use of the free space immediately above the surface of the sorus for the straightening of the annulus prior to the jerk of ejection: a bias to either side is quite unnecessary, and may be a positive disadvantage. As the young sporangium grows in a mixed sorus, for instance of a *Polypodium*, its stalk elongates, carrying the head vertically upwards from the receptacle: it is thus lifted above the crowd of younger sporangia, and the space directly above it is free for the movement of ejection. The vertical annulus thus satisfies the conditions of the mixed sorus

It has already been shown how the different types of annulus characteristic of the three types of sorus pass phyletically one into another: and it is now seen that there are biological reasons for this in the exigencies of the mechanism of dehiscence: in fact, the details of the method of dehiscence in the more specialised Ferns appear to have been determined by the mutual relations of the sporangia.

ANATOMY.

It has been shown from comparison of the external characters of Ferns that they were probably in the first instance strobiloid types, with a radial construction of the shoot, and that their present condition was probably attained by advance from a smaller-leaved state to megaphylly: with this went frequent assumption of a dorsiventral development. This matter must now be considered from the point of view of comparative anatomy, and especially of the vascular system. If the Fern-shoot were primitively strobiloid and radial, we should expect the fact to be reflected in the vascular construction of those Ferns which are held on comparative or on palaeontological evidence to be primitive; and also that it would be

supported by the structure of the individual plant when young. In both cases a prevalence of a cylindrical protostelic state, with comparatively slight disturbance of the axial system on departure of the leaf-traces, would be expected if the shoot were primitively strobiloid. Further, the leaf-trace would be relatively simple.

Leaving aside for the moment the Marattiaceae, which are anatomically a peculiarly specialised series in themselves, a comparison of the early types of Ferns points clearly to origin from a protostelic state with a leaf-trace consisting of a single strand, which comes off with but slight local disturbance from the periphery of the stele. This, with certain variants, is the typical condition in the Botryopterideae: a near approach to it is found also in the earliest Osmundaceae, though those of later epochs depart from the simple type by elaboration of the stele, as described above (p. 539). The close correspondence of the Hymenophyllaceae with certain of the Botryopterideae stamps their structure as relatively primitive also, though it shows some variants upon the simple protostelic state. *Lygodium* also, recognised as the most primitive genus of the Schizaeaceae, is protostelic, and the same is the case with the simpler species of *Gleichenia*; in fact, those early stocks of Ferns which are recognised by comparison of other characters, as well as by their geological history, as forming the phyletic basis of the Leptosporangiate series, show the protostelic structure, or a condition very little removed from it.

The Ferns thus mentioned are all included in the Simplices, except the Hymenophyllaceae. These are exceptional among the Gradatae in showing a protostelic structure of the axis: most of the Gradatae have a more elaborate stem-structure, which may be held to be derivative from the protostele, just as the basipetal sorus is probably derivative from the type of the Simplices. The probable steps towards a solenostelic state are illustrated in *Lindsaya* and *Dennstaedtia*, and suggested also in *Gleichenia*; but the solenostelic structure is typically seen in *Dipteris* and *Loxsonia*, as well as in the Dennstaedtiinae. Here at each leaf-insertion the vascular tube opens by a foliar gap. Where the internodes are long and the gap itself short, as in the rhizomic species, the structure is easily intelligible. It is but a slight step to the dictyostelic type, as seen in Ferns with short axis and overlapping leaf-gaps: the transition is illustrated in the *Dennstaedtia-Davallia* series, and has probably occurred also in the *Alsophila-Cyathea* series, and elsewhere. It seems probable that the progression from a protostelic to a solenostelic or dictyostelic state has been effected in several distinct phyletic lines, while the dictyostelic, with or without internal accessory strands, is the most elaborate system of all.

It usually accompanies an advanced soral condition: that this is, however, no obligatory parallelism is shown by the comparison of *Matonia* with *Dipteris*. The latter retains a simple solenostelic structure of the axis, though its sori have progressed to the condition of the Mixtae: the

former, though its soral structure has remained virtually unaltered, shows the highest condition known of the solenostelic development.

Parallel with such structural progression of the axial system goes an elaboration of the leaf-trace. In protostelic, and usually in solenostelic forms, it is represented by a single strand, which may, however, be widened into a broad strap, and curved in transverse section into a horse-shoe outline: and this may again be contracted into a pseudo-stelic condition (compare Fig. 98, p. 194). But with dictyostely comes usually a division of the single strand into many. It is interesting in *Dicksonia* to see a middle condition illustrated; for in *D. Culcita* and *D. Barometz* the leaf-trace at its base is still a single strand, but at a point above the base, varying in different leaves, it breaks up into many separate strands: it thus represents the various stages of the probable phyletic sequence (Fig. 97). The complete subdivision is seen in the larger species of *Dicksonia* and in *Cyathea*, as well as in most of the Mixtae, and it is held to be an advanced and derivative state.

The seedling structure gives a strong support to the view of elaboration here put forward: in all observed cases the stele of the axis is either protostelic or very closely related to that structure, and the leaf-trace is a single vascular strand. In the primitive forms this may remain permanently so; but in others there may be a quick transition to the more complex and presumably derivative state. The example of *Alsophila excelsa* (p. 608) shows that the individual life, after the first stages are past, reflects the probable story of development of the complex adult condition in the race.

It is in this way, through the seedling, that the Marattiaceae may best be approached. They have in the mature stem a still more complicated system of vascular strands than other Ferns; but in their seedlings the ontogeny opens in all cases with a monostelic state, with a solid xylem-core. Complications soon arise: in *Kaulfussia* and *Archangiopteris* a cylindrical dictyostele is formed, not unlike that of other Ferns; but in *Angiopteris* there may be as many as three or four concentric, meshed zones in the stock, while the leaf-trace is also disintegrated into numerous strands. It is important to note, however, that in the related fossils the leaf-trace is habitually a single connected strand, while greater coherence is also seen in the vascular tracts of the axis in the fossils than in the living species.

These facts all indicate that in the evolution of Ferns there has been a progressive amplification and disintegration of the vascular tissues; and they lead back towards a type, which seems to have been a common one: the original type was characterised by a radial shoot traversed by a protostele, from which the successive leaf-traces came off each as a simple strand, and with the minimum of disturbance of the axial stele. If this were the original type of shoot in the Filicales, it is plain that the foliar gap, to which Jeffrey attaches so much importance as the distinctive character of his phyllosiphonic type, must have been a secondary development: it is

absent as a matter of fact in many of the Simplices in their mature state, and apparently from all Ferns in the first condition of the seedling.

The vascular structure thus held to be primitive and typical for Ferns is that characteristic of strobiloid plants, and it seems reasonable to read the anatomical data as indicating that the Ferns also are essentially strobiloid, but have progressed to a condition of megaphylly, while the anatomical characters that ultimately accompany that habit lagged behind in the several evolutionary series, and only become apparent in the later representatives of each.

EMBRYOLOGY.

The primary embryology of Ferns shows so nearly a dead level of uniformity that it has not seemed necessary to describe the details for the successive families. There are, however, two distinct types: that of



FIG. 351.

Transverse sections through growing point of root in Osmundaceae. *A* = *Osmunda regalis*; the section shows a three-sided initial (*r*), but the segments are not regular. *B* = shows transverse section immediately below the root-cap; three initials (*r, r*) are present; the dotted line is the cell-division in the root-cap, seen on focussing deeply into the hand-cut section; this shows that the section has traversed the initials and is not below them. *C* = *Todea barbara*, showing a very regular meristem of the root, with four initials (*r, r*). $\times 144$.

the Marattiaceae, and that of the main series of the Leptosporangiate Ferns, and these must be compared. The most obvious difference lies in the fact that the seedling of the Marattiaceae perforates the prothallus, and emerges with an upright axis through its upper surface (see Fig. 292, p. 527); that of the Leptosporangiate series emerges on the lower surface, and the axis is at first prone (see Figs. 14, 15, pp. 30, 31). This difference may be referred back to the first segmentation of the zygote, and appears to be closely related to the difference of polarity then initiated; for in the Marattiaceae the first wall appears at right angles to the axis of the archegonium, but in the Leptosporangiates it is approximately in a plane including the axis. The further segmentation, and the relation of the parts of the embryo to the first divisions are substantially alike in both: except that in the Marattiaceae, as also in the Osmundaceae, there is a less regularity in the later divisions than is the case with the other Leptosporangiate Ferns. In this respect *Osmunda* occupies an intermediate position between the latter and the Marattiaceae. The parts formed in

either case are the same in nature and relative position, though they differ in their relation to the prothallus, and the foot is less fully developed in the Marattiaceae.

It does not appear that the facts of the primary embryology have any very direct bearing on the present problem. It is interesting, however,

to note that the axis is vertical from the first in the Marattiaceae, as it is also in most other Pteridophytes, and this may be held to be the more primitive state for Ferns: the prone position characteristic of the Leptosporangiate Ferns is exceptional among Pteridophytes at large, and is probably derivative.

A comparative study of the meristems which carry on the continued embryogeny of the Ferns has brought interesting results.¹ Examination of the apical regions of axis, leaf, and root indicates that in all of these parts the Marattiaceae show a relatively complex state, the whole part being referable in origin as a rule to a group of some three or four initial cells, usually of prismatic form. It has also been seen in them, in sections of the thick marginal wings of the leaf, that at least two and possibly more cells appear as initials. In the typical Leptosporangiate Ferns a single initial cell of conical form is present at the apex of stem, leaf, and root: and in the case

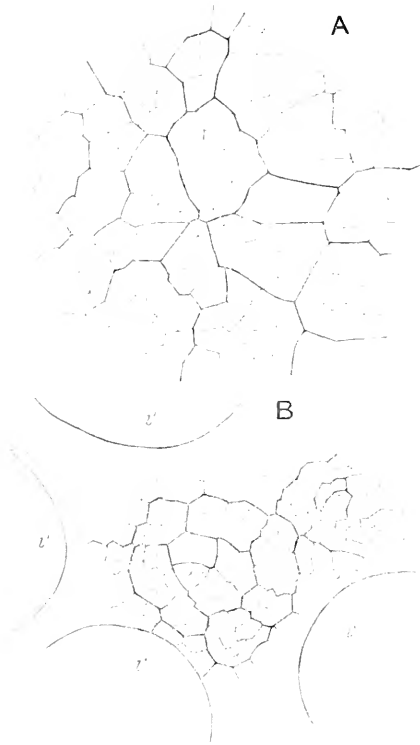

FIG. 352.

A=apex of stem of *Angiopteris evecta*, seen from above: apparently there are four initials (x, x'). $\times 83$.
B=apex of stem of *Osmunda regalis*, seen from above, with initial cell (x) of regular form and segmentation; L, L'=leaves, the youngest (L) shows also a three-sided initial cell. $\times 83$.

of the wings of the leaf there is a single marginal series, so that in any transverse section only one initial appears. A similar examination of the Osmundaceae shows that structurally they hold an intermediate position: for while a single initial may be found in stem, leaf, and root, deviations from this are common. In the roots of *Osmunda* and *Todea* various

¹See Bower, *Annals of Bot.*, iii., p. 305. Though this paper of 1889 was written from the point of view then current, that the Leptosporangiate Ferns were more primitive than the Eusporangiate, the facts are now equally available in their bearing on the contrary view at present held. (Compare *Ann. of Bot.*, vol. v., p. 109.)

irregular and intermediate conditions have been found between the Marattiaceous type with four prismatic initials and that of the Leptosporangiate Ferns, where there is only one (Fig. 351). The axis has usually a single conical initial, but it is doubtful whether this is always so, and irregularities certainly occur (Fig. 352). The leaf of the Osmundaceae is alone among Ferns in showing the more complicated three-sided initial in place of the two-sided common for the Leptosporangiates, while the wings of the leaf have a segmentation of the Marattiaceous rather than of the Leptosporangiate type (Fig. 353). In

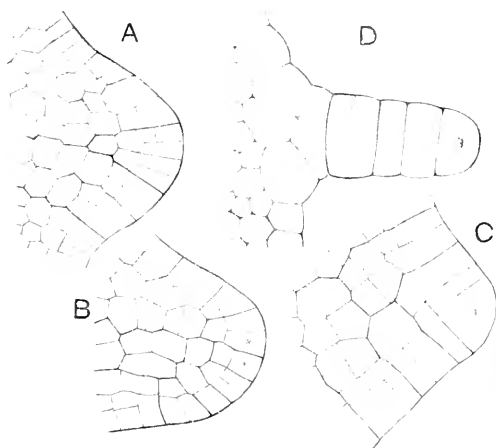

FIG. 353.

Sections transversely through young wings of the leaves of various Ferns. *A*=*Angiopteris erecta*, showing that there is no single marginal cell, but a small celled meristem at margin of the wing. *B*=a similar section of *Todea barbata*, with like structure. *C*=similar section of *Scelopendrium vulgare*, showing regular segmentation of a marginal cell (*m*) by alternating cleavages. *D*=similar section of *Trichomanes radicans*, showing marginal cell (*m*) with transverse segmentation. . . 216.

point of fact, all the meristems of the Osmundaceae show nearer relation to those of the Marattiaceae than do any other Leptosporangiate Ferns that have been examined.

These facts are in obvious accord with the segmentation of the sporangia (see above, p. 637): it appears, therefore, that in stem, leaf, root, and sporangium those types of Ferns which are held as more primitive commonly show a more bulky initial construction, while the true Leptosporangiates, which are held as derivatives, show in all their parts a less bulky type of segmentation. It has been seen above that the spore-output per sporangium follows a similar sequence, and indeed the numbers might be taken as a rough indication of the complexity of organisation for the plant at large. The conclusion follows that in the Filicales there has been a progressive simplification of the meristic plan: in the more ancient forms the meristems are not referable to a single initial,

but in the Leptosporangiates this became the rule, and with it is associated the more definite segmentation of the projecting and delicate sporangium, and a diminution of the output of spores. In fact, the character of the sporangium may be taken as an index of the meristic character of all the embryonic tissues.

PHYLOGENY OF FERNS.

The comparative study which has now been made of the Filicales provides a basis for views as to their phylogeny. Several different lines of comparison have been adopted, such as that on external form, on anatomy, on the spore-producing members, and on spore-output: and the results have been found to be substantially parallel along them all, though with some exceptions. Moreover, these results are found to harmonise with the geological record: from this it is learned that, speaking generally, the Ferns with simultaneous formation of the sporangia in the sorus (Simplices) were those present mainly, or perhaps exclusively, in the Palaeozoic period: the Ferns of the Mesozoic Period included, in addition to these, a large proportion of those with basipetal sequence of the sporangia (Gradatae), while the bulk of the more recent Ferns are characterised by the mixed type of sorus (Mixtae). While these three types are found to coincide generally with three great periods of time, it must not be assumed that every phyletic line ran through them all: at the moment it is impossible to demonstrate in any clearly defined family of Ferns that the sorus has passed successively through all the three phases. What is recognised is a general trend of development, carried out in many phyletic sequences, rather than any single progression. It may indeed be said that no connected phyletic tree of the Filicales can at present be constructed with any degree of certainty: it must suffice to give a provisional arrangement of the Ferns, divided in the first place according to their soral condition, which also tallies approximately with their geological age (Fig. 354). The three recognised grades are limited by horizontal lines in the graphic table. The several sequences of Ferns are indicated by vertical or oblique lines so placed as to indicate relationships, but disconnected so as not to convey necessarily a common descent. Where one of these lines crosses the limit between the three grades of soral construction it is intended to convey the idea of the derivation of the higher from the simpler plan. Further, the arrangement is such as to give some general idea of the position of the sorus: the forms with marginal sori are placed to the left side of the plan, and those with superficial sori to the right. Finally, no attempt has been made to represent separately the numerous sequences of the Mixtae: the unravelling of the lines will have to be deferred till a better knowledge is gained of their anatomy, and of other details. They have been represented conventionally in the scheme by overlapping areas, the one to the left stands for those with marginal sori, that to the right for those with superficial sori, while

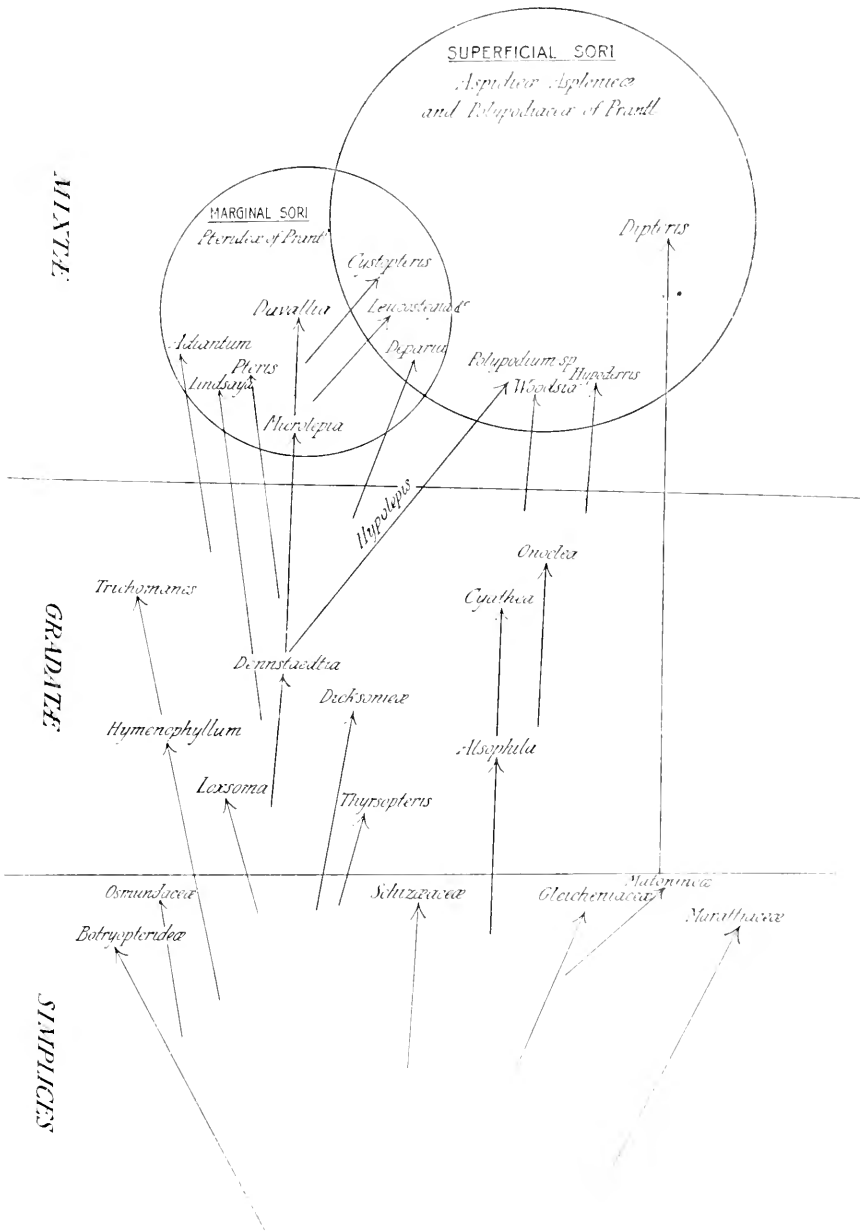

FIG. 354.

Scheme to illustrate approximately the relations of the several families of Ferns, as concluded from the discussions in the text. It will be noted that the distinctions as Simplices, Gradatae, and Mixtae traverse several of the probable evolutionary lines; the grouping is so disposed that Ferns with marginal sori lie to the left, with superficial sori to the right. No attempt is made to connect the lines into a phyletic tree.

the overlap represents those which are in course of transition, or are believed to have recently passed from the one state to the other. With these explanations the scheme may be taken as representing the conclusions arrived at in the preceding pages.

Of the Simplices the Marattiaceae stand somewhat isolated from modern Ferns, both anatomically and sorally. They are approached most nearly by the Gleicheniaceae in point of the sorus, but in anatomy and in habit they stand widely apart from them. Their stock probably never progressed beyond its present state. If they had any near relation with other living Ferns it must have been very far back.

The other very ancient family, the Botryopterideae, shows obvious relations with the Osmundaceae, both in type of shoot, in anatomy of the earlier species, and in sporangial characters. There appears to be an anatomical resemblance, on the other hand, to the Hymenophyllaceae, which extends to the external characters of the shoot also; but the sorus of the Hymenophyllaceae is widely apart, having passed to the basipetal type. It is perhaps in relation to their consequent increase in number that reduction of size of the sporangium is here shown, and especially illustrated in *Trichomanes*. None of these three related families appear to have progressed further than their living representatives: they are held to be blind branches of descent.

The Schizaeaceae appear as an isolated family, though nearest to the Gleicheniaceae: their solitary marginal sporangia show analogies of structure, but not of position, with those of *Gleichenia* on the one hand and of *Osmunda* on the other: it is, however, probable that their monangial sorus is a result of reduction from a radiate type, such as is seen in some species of *Gleichenia*. Anatomically also their simpler types approach *Gleichenia*, but the upright genera, *Aneimia* and *Mohria*, appear to have progressed along a line of their own to a dictyostelic structure. The Schizaeaceae also appear to have been a blind branch.

The Gleicheniaceae are somewhat isolated, from the fact that they show cross characters: their sori compare most nearly in position and structure with those of the Marattiaceae, but their type of shoot and their anatomy correspond rather with the Schizaeaceae. Thus among the Ferns which show their primitive character by their large spore-output per sporangium, including the Simplices and the Hymenophyllaceae, there appear to be several fairly distinct lines: it is possible to link these together by hypothesis as to a common ancestry, but there is no distinct evidence of their common descent from any known Fern-type. This is indicated in the scheme by the convergent but disconnected lines, the longer lines of the Botryopterideae and Marattiaceae indicating their priority in the fossil record.

From the Simplices, though with uncertainty as to their definite reference to any exact origin, at least two other main lines in addition to the Hymenophyllaceae appear to have proceeded to the basipetal type

of sorus: the one with marginal sori, the other with superficial. They are both characterised by having their spore-output restricted to the typical number of 64 as the upper limit. It may be a question whether these two were truly distinct in phyletic origin, but they appear to have progressed independently. The one comprises the *Dennstaedtia-Davallia* series, leading onwards to various families of the Mixtae: the other is the Cyatheaceous series. Besides these the genus *Dipteris* seems to have taken a line of its own towards the mixed sorus, and may perhaps be not alone in having done so.

The most complete phyletic story has been made out for the *Dennstaedtia-Davallia* series, to which *Dicksonia* itself may probably be a collateral line, with unusual elaboration of the structure of the stock. The scheme suggests a somewhat independent origin for this series, together with such genera as *Loxsona*, *Thyrsopteris*, and *Dicksonia*, from a source probably between the Botryopterideae and Schizaeaceae, though not directly from either of them. They all show a structure of the axis advanced to a solenostelic or even a dictyostelic state, and a basipetal sorus, derived presumably as an amendment on the simple type: *Loxsona* and *Thyrsopteris* have a peculiarly archaic structure of the sporangium. The further progression, which harmonises reasonably with the palaeontological record, has been traced both anatomically and sorally, and leads with advance in both respects, through the *Dennstaedtia-Microlepia-Davallia* sequence from Ferns with a solenostelic structure and basipetal sorus to those with a dictyostelic stock and mixed sorus. Several side-branches, or it may be concurrent lines, also exist, such as *Lindsaya*, *Pteris*, and *Adiantum*, thus giving rise to the bulk of those Ferns which Prantl grouped together as the Pterideae.

But in several branches from this line a transition is found from the marginal to the superficial position of the sorus. One line is direct from *Dennstaedtia* through *Hypolepis*, a genus with mixed sorus, to some forms with superficial sorus reckoned as *Polypodium*: another line may have been as illustrated by *Defaria*, where the mixed sori are sometimes marginal, sometimes superficial. Another, and a more decisive line is through such forms as *Cystopteris*, and certain sections of *Davallia* such as § *Leucostegia*, in which there can be little doubt that the mixed sorus has been shifted from the margin to the surface. And so by a number of phyletic sequences, by no means exhausted by the examples quoted, it seems probable that there has been progression to that prevalent and final type of the Mixtae which has an intra-marginal sorus on the lower surface of the leaf. The Ferns thus derived are characterised by their advanced dictyostely.

But there is some reason to think that a similar result has been reached also by a more direct route. The series of the Cyatheaceae is linked by *Alsophila*, and especially by the solenostelic *A. fruinata*, with the Gleicheniaceae: it is a very slight transition, already indicated by *G. dichotoma*,

and *pectinata*, to the basipetal sorus of *Alsophila*: the addition of a basal indusium, together with increased vascular complexity, gives the full type of *Cyathea*. In relation with these genera, though on a minor scale of structure, is probably *Onoclea*, and as possible last terms leading to the mixed sorus may be *Woodsia* and *Hypoderris*. But this line requires more full investigation before it can be accepted with assurance.

A third line, which is however more certain, is the *Matonia-Dipteris* series. Again the sori are superficial, and the relation of *Matonia* is clearly with the Gleicheniaceae. There can be no doubt of the close relation of *Dipteris* to *Matonia*, as shown by external form, as well as by anatomy: but in place of the simple sorus of *Matonia* and of *Dipteris Lobbiana* that of *Dipteris conjugata* shows the mixed condition. It seems clear that there has been a direct transition in this case from the simple to the mixed sorus, leading in fact to a form long included in the genus *Polypodium*: but without the intermediate basipetal condition, though this has been found usual in other cases.

It would thus appear that along several distinct phyletic lines the condition with mixed sori may have been attained. This is the most advanced state of the present day among the Filicales. It will remain for future workers, by anatomical and other enquiry, to disentangle more fully the confused phyletic lines of the Polypodiaceae: the present work will at least have served to show where the tangle actually lies, and some of the probable lines which have led up to it.

Returning now to the base of the series of the Filicales, as represented in the scheme, it remains to consider what idea can be formed of a primary type for the group. As there is no clear evidence of the nature of the Fern-stock prior to the known types of Simplicies, it is only on a basis of comparison of these with one another, and with other early Pteridophytes, that a conception can be formed of the probable origin of the sporophyte in the Filicales. Comparison, checked by the Palaeontological facts as stated at length above, has led to the recognition of the following characters as primitive for Ferns: the shoot consisted of a radial upright stock, showing occasional dichotomy, with protostelic structure, bearing radially disposed leaves, and supported by adventitious roots: the leaves were primitively flattened, of relatively simple outline, in which dichotomy was a prevalent, but perhaps not an exclusive feature: the leaf-trace consisted of a single strand: the meristems of axis, leaf, and root were not dominated by a single apical cell, but showed a group of initials: all the leaves were potentially sporophylls: the sori were probably definite, marginal or superficial, disposed in a single row on either side of the midrib: the sporangia of each sorus were simultaneous in origin, sessile, and of large size, with high individual output of spores.

The characters thus summarised indicate an essentially strobiloid type not very much removed from some of those which Palaeophytology has brought to light. Among the Sphenophyllales and Equisetales are forms

which share many of the characters thus set down. The chief difference lies in the extent of the development of the leaves, and the number and position of the sori upon them. These are, however, matters of degree rather than of kind. A dichotomous leaf like those seen in *Sphenophyllum* or in *Pseudobornia* is in point of construction not unlike that type which is found in certain primitive Ferns, where dichotomy was also prevalent. It has been seen that the sporangiophores may be multiplied on the single leaf of the Psilotaceae or on the leaf-sheath of the Sphenophylls, while a plurality of them is a character of *Cheirostrobus*. But sporangiophores are held as correlatives of Fern-sori, though probably not homogenetic with them: it is thus seen that precedents are present for their plurality on the single sporophyll in the strobiloid types. On the view of the Ophioglossaceae given above (pp. 490-494), this family is held to represent a series in which megaphylly has been achieved from a strobiloid origin: the spore-producing members have there been shown to follow the leaf-enlargement, in size, and sometimes even in number. This series, though probably a quite separate megaphyllous phylum, shows an interesting parallel to the Ferns, and suggests how spore-producing members may be spread over an enlarging part. Lastly, the position of the sorus is seen to have varied in Ferns from the margin to the lower surface, and occasionally to the upper surface: what is thus liable to change within the Filicales as now defined may probably have been equally liable to change at the inception of the phylum: therefore the habitual position of the sori on the lower surface of the sporophyll must not be held to be a vital point of difference from other Pteridophytes. Accordingly, there appears to be reason for regarding the fundamental plan of the sporophyte in the Filicales as being essentially strobiloid, like that in the other phyla of Pteridophytes, but specialised to a greater extent than in any of them in the direction of megaphylly, while a cognate spread of the sori has followed the enlargement of the sporophylls.

PART III.

CONCLUSION.

CHAPTER XLI.

ALGÆ AND BRYOPHYTA.

THE general theory which may be based on the occurrence of anti-thetic alternation in Archegoniate plants has been expounded in the First Part of this book: the Second Part has been devoted to the examination of those facts which specially bear upon the theory, as they are seen in the several groups of Bryophytes and Pteridophytes. It now remains to draw these facts together into a collective statement, and to see how far they uphold the hypothetical position: at the same time, the attempt may be made to formulate some general morphological and phyletic conclusions. It must be remembered, however, while doing so, how fragmentary the series of genera and species, living and fossil, actually is, and how incomplete the knowledge of the details, especially in the fossils, in which developmental facts can rarely be observed. These considerations will restrain any tendency to dogmatism, and make such statements as are offered rank rather as tentative conclusions than as matters susceptible of ultimate demonstration under present conditions of knowledge.

It must be admitted at the outset that the theory of initiation of the sporophyte—by amplification of the zygote, by repeated cell-division in its products, by sterilisation of some of them so as to form vegetative tissue, and consequently by deferring of the tetrad-division, with its concomitant reduction of chromosomes—is not fully demonstrated by comparison of the representatives of any one series of living organisms: there is no known phylum which exemplifies all of these several steps *ab initio*. Nor is it likely that there should be, if the biological advantage following on the multiplication of spores in land-growing organisms were such as has been suggested in Chapter VI.: for it is not probable that those land-growing organisms in which the sporophyte was nascent would have stood permanently still in the earlier phases of it: the probability would be that all surviving forms would have proceeded some considerable length in the direction of that biological advantage which follows upon a multiplication

of germs. But at least the existence of post-sexual divisions in certain Algae associated more or less definitely with reduction show that the initial structure postulated by our theory does actually exist. At the same time, the Thallophytes present no facts which directly disprove the hypothesis for land-growing plants: they do illustrate, however, other types of cytologically distinct generations, both algal and fungal, analogous, no doubt, to that seen in the Archegoniatae, but probably produced along phyletic lines which were distinct, and subject to quite different external conditions during their development.

A general objection to the whole theory of antithetic alternation was raised some years ago on the ground of the assumed improbability that new parts should appear in the life history.¹ It was pointed out that nature is conservative, and it was stated that when a new organ is formed it is almost always fashioned out of some pre-existing organ. The adage was quoted "*ex nihilo nihil fit*": the same objection to the whole antithetic position has recently been reiterated from the Continent. The reply to this general objection is a very simple one: it is, that the zygote from which our hypothesis starts is not "nothing": it is a cell, with all the powers and possibilities of a complete—and in point of fact a diploid—cell. It has already been concluded generally as regards the sporophyte (p. 100) that a living cell which is capable of growth has not a specific and unalterable function: this we may conceive to have been the initial condition of the zygote and of its early products. The hypothesis involves a development of the potentialities of a living cell: the zygote is actually seen in each normal ontogenetic cycle to give rise by gradual steps of development to the whole sporophyte: the theory contemplates a cognate development as having proceeded gradually in the course of descent. In face of the ontogenetic facts the initial objection does not appear to be valid.

Passing to the more special question of the origin of members, it is necessary to examine the inherent improbability which is assumed to surround their appearance as new structures. It is plain that the difficulty lies in their phyletic not in their ontogenetic origin: for it is a fact which anyone may observe that in the individual development new parts do appear where previously there were none: new axes, new leaves, hairs, emergences, roots, all are originated in this way, each growing out from a spot previously in the individual unoccupied. The position, then, of those who entertain this objection appears to be that what is the rule in the development of the individual is inherently improbable in the evolution of the race. This is surely a new principle in morphology. The practice of the science has been hitherto to hold the exact converse: the *onus probandi* lies with those who declare that the origin of organs in the

¹ Dr. Scott. Presidential Address to Section K (*British Association Report*, 1896, 996). The position there taken up was substantially that of Pringsheim (*Gesammelte Abhand.* ii. p. 370). It was criticised in my address to Section K (*British Association Report*, 1898, p. 1032).

evolution of the sporophyte was essentially different from that so constantly seen in their individual development. Here it is held that unless good reason be found to the contrary, the development of the individual will probably reflect in some degree the evolution of the race: but it is recognised that the principle is not directly applicable in all cases (Chapter XIV.).¹ Accordingly the ontogenetic facts would support a view involving the appearance of new structures in the course of descent.

We have seen that the first steps in the organisation of a sporophyte are suggested by the post-sexual divisions in certain Algae which there is good reason to believe were associated with a reduction of chromosomes. Passing from these initial stages of the sporophyte, of which the post-sexual stage in certain Algae cannot be held as more than suggestive of what actually occurred, to those where it appears as a more or less extensive tract of tissue, it has been shown that the sporogonia of Bryophytes provide numerous examples of sterilisation, and that the result has been to defer the event of reduction, and in various ways to increase the means of nutrition and dispersal of the spores (see pp. 258-286). The facts of sterilisation and their biological results have been accepted by other writers, and though they do not actually demonstrate that the sporogonium of the Bryophyte did originate by intercalation of a new phase in the life-cycle, nevertheless the observed facts harmonise with that view: it is difficult, without having recourse, as some have done, to purely hypothetical preliminary phases in the descent of this phylum, to read the facts in any other way.

One important point on which the Bryophyta differ markedly in their individual development from all Vascular Plants, is that in them, as a rule, the whole sporophyte originates by a primary embryogeny: it is initiated directly from the zygote with the minimum of apical or intercalary growth, and with entire absence of appendages.² There is no continued embryogeny, with secondary initiation of fresh parts, as in Vascular Plants. This simple

¹There are two leading features of development to which a theory of recapitulation will not apply, and both are open to a biological explanation. The one is where those gonyt developments occur in the embryogeny, especially in the Lycopods (p. 351), the other is the apparent priority of the vegetative system over the spore-production in the individual life. In both cases the recapitulation of the sequence of developmental events may be held to have been overruled by physiological requirement: the latter is fully explained on the basis first of sterilisation of individual cells, and secondly of abortion of the spore-producing parts: the consequence is that the vegetative system appears before the spore-production begins: though the latter was the prior function of the sporophyte, the overruling requirement was for early nutrition. The former has its origin in the demands of early nursing of the embryo, and it has been shown that it has arisen along two distinct lines within the genus *Lycopodium*. Such responses to biological requirement are readily intelligible: but they must not be held to invalidate the whole doctrine of recapitulation, they show rather that it applies within limits only, and that the evolutionary story which the individual may tell is liable to secondary disturbance.

²An exception is seen in *Eriofus*, in which rhizoids appear at the base of the seta: this appears to be a good example of the origination of new organs not fashioned out of pre-existing organs (Goebel, *Flora*, 1906, pp. 66, 68).

origin falls in readily with antithetic theory, under which it would be held to be a primitive, not an acquired condition. Moreover, it accords with the relatively simple form and structure of the sporogonium when mature: this simplicity has made the recognition of the part played by sterilisation easier in the Bryophytes than it is in plants where continued embryogeny leads to a more complex state.

But the details of this primary embryogeny are carried out differently in Mosses and in Liverworts: in the former, after the first division which separates the hypobasal cell, apical growth appears in the epibasal hemisphere with regular segmentation of a two-sided initial cell: in the latter the segmentation in the epibasal hemisphere is not localised apically, but after division into octants the growth is intercalary. Both of these types, so distinct in their details of segmentation, present points of interest for comparison with the more complex embryogeny of Pteridophytes: but the analogies offered by the Liverworts are the more instructive. In some of them (Ricciaceae) there is no distinction of apex and base: it may be a question whether this absence of polarity is primitive or acquired. In others (Marchantiaceae) there is definite polarity, the whole hypobasal hemisphere serving functionally as a foot and seta, while the epibasal is reproductive. In others again (Jungermanniaceae) the hypobasal hemisphere develops into a unicellular appendage of small size; the epibasal hemisphere after octant division undergoes intercalary growth, with repeated transverse segmentation: the seta is derived from the lower tiers of cells thus produced, and it may be only the uppermost tier that remains fertile (Figs. 124, 125). The interest here lies in the deferring of the propagative function, as compared with the previous cases: the part which is in them an absorptive seta is here a small body, with probably a minor or temporary function, while the lower part of the epibasal region, which is elsewhere propagative, takes up the duty of the hypobasal. The propagative function is relegated to the apical tier, and thus, on a basis of comparison along the Liverworts, an example is established of that process of deferring of the event of spore-production which is an essential feature in the theory here put forward. A somewhat similar process has been traced in the Mosses; and in the Pteridophytes there is reason to believe that it has been very prevalent. The presence of such evidence from phyla which have probably been distinct from one another at least in the later phases of descent, illustrates what is believed to have been a progressive development which owes its prevalence to the fact that it was dictated by biological advantage.

The similarity of the small hypobasal appendage in the Jungermanniaceae (Fig. 125) to the suspensor in certain Pteridophytes is a further point for comparison; but it is doubtful whether this is in reality anything more than a very distant analogy. In either case the body in question represents a part of the zygote which takes no active part in the further embryonic development: both owe their origin to a form of meroblastic segmentation.

Another point of interest in the Bryophytes for comparison is the establishment of a central sterile tract—the columella. In the Liverworts this is incompletely carried out in *Aneura* (Figs. 127, 129), and in *Pellia* (Fig. 128), the final end here being a more effective distribution of the spores: it is more completely organised in *Anthoceros*, where it probably serves for nutrition as well as for distribution (Fig. 130 E); but its more definite character is established in the Mosses, where it is probably effective in water storage as well as in nutrition. However different these several parts may be in origin or in function, they all illustrate that process of relegation of the spore-production, originally central, to a more superficial position. It has been pointed out above (p. 286) that in sporogonia of no great bulk, which dehisce by apical pores or by lateral slits, the superficial position of spore-production is not a point of biological moment in the same way as it is in larger plants, with separate sporangia, and with a larger proportion of sterile to propagative tissue; doubtless here again the tendency to a superficial position of the spores, so imperfectly carried out in the Bryophytes, shows only a distant analogy to the more pronounced condition in Vascular Plants, as seen in their superficial sporangia.

So also with the assimilatory system, imperfectly represented in most Bryophytes, though better developed in some few (*Splachnum*, *Luxbaumia*, *Anthoceros*); however similar these tissues may be to the functionally corresponding tissues in Vascular Plants, the similarities cannot with certainty be held as more than points of analogy. The facts point to a wide-spread "homoplasmy" as having been effective in the Bryophytes and Pteridophytes; at the same time the similarity of the consequent characters seen in the simpler organisms, throws suggestive light upon the origin of those of the more complex. Nevertheless the similarities cannot safely be held to lead further than to the recognition of certain methods of morphological advance: they indicate that the origin of the sporophyte was probably the same in both classes; it may be traced from a primitive body, initiated by the post-sexual complications involving chromosome-reduction. The requirements of both in respect of increasing spore-production, and consequently of nutrition under subaerial conditions, were essentially alike; independently each has probably worked out its own evolution; and they have independently arrived at results which show points of analogy such as those above recognised. The mere existence of those analogies, with the differences both of general scheme and of detail which they show, appear to lend probability to the recognition of the general biological conditions under which they are believed to have arisen. They were briefly these¹ that in land-growing forms which maintained the aquatic type of fertilisation by a spermatozoid motile in water, a premium was put upon multiplication of germs: and that multiplication of germs necessitates increased facilities for their nutrition and dissemination. It appears probable that these offices were carried out by tissues which originated ultimately by sterilisation of a proportion of the potential germs.

¹ Compare Chapter VI. where the biological aspect of alternation has been discussed.

CHAPTER XLII.

EMBRYOGENY OF THE PTERIDOPHYTES.

No great difficulty is experienced in recognising the sporogonium of the Bryophyta, in its various forms, as the result of the working out of the requirements in respect of increasing spore-production and consequently of nutrition, under conditions of sub-aerial life. They are believed to present a sequence of forms for the most part caught in the up-grade of evolution, though showing occasional evidences of reduction.¹ But in the more complex Pteridophytes the case is different: they have, according to our hypothesis, proceeded so far in the elaboration of the sporophyte that the steps of earlier evolution are less easily grasped: and as the area of fact involved is very much greater than in the Bryophytes, and the application of the theory of antithetic alternation, with sterilisation as a leading feature, has never till now been fully formulated for them, it will be necessary to summarise the evidence which has been derived from the comparative study of their sporophyte generation. This summary will be arranged in order of the events of the individual life, starting with the embryology, and proceeding to the vegetative, and finally to the propagative system.

From the criticisms of the older methods of comparative embryology advanced in Chapter XIV., it will be gathered that at the moment the study of the earliest phases of the individual, as an avenue to an opinion on the morphology and phylogeny of Vascular Plants, stands in a discredited position. Modern analysis has disproved the conclusions drawn from the primary segmentation, and shown that there is no constant relation between cell-cleavages and the genesis of the several parts.

¹It is possible to make out a case for the converse view of the Bryophytes as a series in which the dependence of the sporophyte has been secondarily acquired, and reduction widely effective; but that idea is not seriously entertained here, as it is not based upon observation of any actually existent organisms indicating that such a progression took place: nor has any physiological ground been advanced as a sufficient reason that the presumed reduction should have been carried out.

On the other hand, the examination of the embryos of various types of Pteridophytes has shown that the occurrence of a suspensor is variable within near phyletic limits, that the form of the embryo itself is in high degree plastic, and that a certain correspondence can be traced between biological requirement and the proportions, or even the actual position of the parts relatively to one another, and to the parent prothallus. Thus the haustorium or foot is found to be inconstant in position, and may be present or absent in plants of near affinity: the root may be entirely absent, or vary in its position: the cotyledons also may vary in number and in position as well as in form and dimensions. Such irregularities, together with a certain degree of physiological reasonableness which may often be seen to underlie them, led not unnaturally to the conclusion drawn by Goebel¹ that "root, shoot, and haustorium are laid down in the positions that are most beneficial for their function." This implies that all parts are opportunist growths. To those who accept this thesis as true, embryology cannot form a secure basis for general comparisons or for phylogenetic argument. For them comparative embryology would be little better than a study of the more or less immediate biological adaptations of the embryos themselves: there would be no common ground from which the comparison could start.

But it may be questioned whether this extreme position is fully justified. The endeavour must be made to recognise and isolate those characters of the embryo which are variable, and to see whether there is not some element of constancy in shape or in construction which underlies the fluctuating features, and runs through all the different forms. This has been greatly facilitated by recent discoveries; for now the embryos of all the leading types of living Pteridophytes are fairly well known, with the exception of the Psilotaceae—though possibly these are, for comparative purposes, the most important of them all.

A revision of the embryology in the whole series of Pteridophytes described above leads to the conclusion that the form is not so inchoate or immediately plastic as Goebel's statement implies: comparison shows that there is one point comparable in them all (where fully investigated) which does not appear susceptible of disturbance on a basis of opportunism, viz. the position of the apex of the axis relatively to the primary segmentation; or, expressed in other words, the relation of the polarity of the embryo to its first cleavages.

Of this primary segmentation there are two types, according as a suspensor is present or absent; otherwise it shows that remarkable constancy of cleavage which led earlier writers to construct the theory of octants, now no longer to be upheld. It has been shown that these two types may appear in the same phylum (Lycopodiales, Ophioglossales) and even in the same genus (*Botrychium*); and there is accordingly reason to believe that, however important biologically, they do not mark such

¹ *Organography*, ii. p. 246.

a difference of initiation of the embryogeny as will serve for a safe taxonomic guide. Where a suspensor is formed, the first segment-wall (1, 1) divides the zygote, separating the parent-cell of the suspensor from what has been styled the embryonic cell (Fig. 355 1.). As the position of the first segment-wall in all Pteridophytes where a suspensor occurs is approximately at right angles to the axis of the archegonium, the mother-cell of the suspensor is directed towards the archegonial neck, and the practical effect of biological moment is that the embryonic cell is thrust downwards into the tissue of the nourishing prothallus. While the suspensor is thus recognised as biologically important, it may, on the other hand, be regarded as a means of deferring the actual constitution

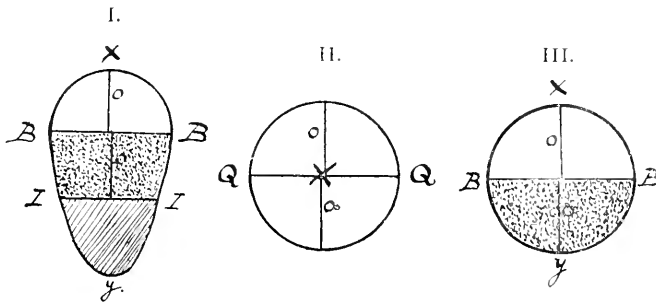

FIG. 355.

Diagrams illustrating the segmentation of embryos. I.=where a suspensor is formed, which is cut off by the first wall, 1, 1; the suspensor is cross-hatched; B, B=basal wall, separating the hypobasal hemisphere (dotted) from the epibasal (clear). II. is the same seen from above, x marking the pole. III.=an embryo where no suspensor is formed, and the segmentation resembles that in the embryonic cell where the suspensor is present; the lettering corresponds; x, y indicate the polarity. Each hemisphere divides into four by quadrant walls (Q, Q in II.) and octant walls e, e.

of the definitive embryo, which is entirely derived from the remaining portion of the zygote. The formation of a suspensor is in fact a form of meroblastic segmentation, comparable generally, though not in detail, with that seen in many Gymnosperms. But a further analogy is to be found, as already pointed out, in the sporogonia of the Jungermanniaceae (Fig. 125): here, however, it is the segment furthest from the neck of the archegonium which takes no part in the constitution of the definitive sporogonium.¹ In either case a part of the product of the zygote, which has some more or less obvious biological use, may in certain forms be set aside from partaking directly in the formation of the definitive embryo.

Passing now to the embryonic-cell in the Pteridophytes which have a suspensor, it has been shown in several well-investigated cases that it

¹It is interesting to note that this body is absent from the Marchantiaceae; and the inconstancy in the Liverworts may be compared with that of the suspensor in the Pteridophyta.

undergoes octant-division:¹ the succession of the divisions is not always the same, but as a rule there is first a basal wall (B, B) parallel to the wall 1, 1, which divides the embryonic cell into hypobasal and epibasal tiers, and this is followed by quadrant and octant walls at right angles (Fig. 355 Q, Q: o, o), which divide each of those tiers into quarters. The result is a body which shows in many cases, by its elongating form, that there is a distinct polarity: its form and constitution are illustrated by diagrammatic figures (Fig. 355 l. n), in which the suspensor is cross-hatched, the hypobasal tier dotted, and the epibasal tier left clear. Such a scheme will serve for all Pteridophyte embryos with suspensor which have been fully elucidated.

Turning to embryos without a suspensor, the segmentation of the whole zygote into octants is similar to that seen above in the embryonic cell, where a suspensor is present, but with the suspensor completely omitted (compare *Equisetum*, Fig. 214: Ophioglossaceae (excl. *Botr. obliquum*), Figs. 260, 261, 261; *Isoetes*, p. 350; and all Filicales). It is represented diagrammatically in Fig. 355 m., where again the hypobasal region is dotted and the epibasal left clear. Without attaching undue importance to the cell cleavages themselves (for they resemble those in certain quite distinct bodies, such as capitate hairs), they may be held as indications of the growth, and, what is more important, of the polarity already defined in the body of the embryo. The first indication of the existence of this polarity is given by the position of the first segment-wall (1, 1), or B, B in cases where a suspensor is absent; and it may be shown that in all fully investigated cases the apex of the axis has a definite relation to that first wall. It appears at the centre of the epibasal hemisphere, that is, in close relation to the intersection of its octant walls: the point is marked (x) in the diagrammatic Figures 355 l., n., m.

It should be clearly understood that however constant the orientation of the embryo may be in cases where a suspensor is present, the orientation is not constant in the type without a suspensor: in these the apex of the axis bears no necessary or constant relation to the axis of the archegonium, either for Archegoniate plants at large, or for the several phyla of them, or yet for genera or even for individuals. As a matter of observation, the orientation of the definitive shoot is initiated sometimes with its apex towards the neck of the archegonium (compare Fig. 214 of *Equisetum*, and Figs. 260-262 of the Ophioglossaceae, with the diagrammatic Fig. 356 m.); or obliquely to one side, e.g. Leptosporangiate Ferns (compare Figs. 14, 15 with diagrammatic Fig. 356 n.); or away from it (as in Marattiaceae, compare Fig. 292 with the diagrammatic

¹ Compare especially Fig. 190 of *Sal. spinulosa*: also, though less clearly, Pfeiffer's drawings of *S. Martensii*, Haunstein's *Abhandl.*, vol. i. Taf. 2, 3; Treub's drawings of *Lyc. Pilegenaria* (Fig. 185), but more fully in *Ann. Jard. Bot. Buit.*, vol. v. Taf. xxiii., xxiv., and Bruchmann's drawings of *Lyc. clavatum* and *annotinum* (Fig. 186); but more fully in Bruchmann's own memoirs quoted above.

Fig. 356 I.); it has been shown that the latter type exists initially in all cases where a suspensor is present, e.g. Lycopods (Figs. 183, 186, 187), and presumably in *Botrychium obliquum* (Fig. 264). In *Isoetes* the orientation may vary between wide limits even in the same species.¹ But a still more interesting case is that of the genus *Botrychium*: in *B. Lunaria* and *virginianum* the orientation of the primary axis is towards the archegonial neck (Figs. 261, 262, 263). In *B. obliquum*, however (Figs. 264, 266), where a suspensor is present, it is at first turned away from the archegonial neck, as in other embryos with a suspensor. Thus within the old genus *Botrychium* there are two types of opposite orientation. An inversion of polarity must have occurred in descent. Probably in more than one case such an inversion of polarity

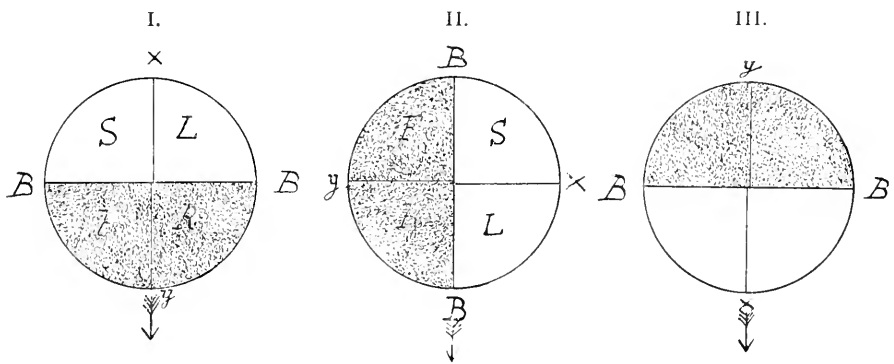

FIG. 356.

Diagrams to show the relation of the basal wall, *B, B*, and hypobasal (dotted) and epibasal (clear) hemispheres to the archegonial neck, which is indicated by an arrow; *x, y* shows polarity, *x* being the apex; *S*=stem; *L*=leaf; *R*=root; *F*=foot. I, shows the orientation seen in Marattiaceous Ferns. II, that for Leptosporangiate Ferns. III, that for *Equisetum* and Ophioglossaceae.

has taken place, not by any rotation of the embryo, but by change in the way in which the zygote has itself initiated its organisation. It is necessary in this connection to realise that the zygote is at first without any determinate polarity: that this may be initiated in various relation to the axis of the archegonium, in different types of plant or even in different individuals; and that its position is controlled, not by external, but by internal causes at present unknown.² But whatever those causes may be, and whatever the orientation, a comparative study of embryos shows that when the direction of polarity is once indicated, as it is by the first segment-wall, the apex of the axis of the first shoot is initiated in a definite position relatively to it: occupying, in fact, the epibasal pole.

¹ Campbell, *Mosses and Ferns*, pp. 545-547; compare Fig. 191 B above, p. 359.

² Goebel, *Organography*, i. p. 219, and ii. p. 246.

This general principle may be illustrated by comparison of certain of the figures quoted in Part II. Thus in Fig. 185 A, B (p. 348) of *Lycopodium Phlegmaria* the apical point T coincides very nearly with the intersection of octants, though it appears unsymmetrical owing to unequal growth caused by the precocity of the cotyledon (c), but it is righted by the appearance later of the second leaf (Figs. 185 C, D). It cannot be doubted that the case of *L.*

Selago is very similar, though the detailed study of cleavages is not yet to hand (Fig. 183, p. 346). Fig. 186 (p. 349) of *L. annotinum* shows the coincidence of the apex (s) with the cleavage-wall (ii) very plainly indeed. As the cleavages have not yet been traced in the more aberrant *L. cornutum*, it is impossible to say more than that the observed facts do not preclude a similar origin of the axis, which comparison with *Phylloglossum* makes probable (p. 353). In *Selaginella spinulosa* (Fig. 190, p. 357) a comparison of the stages A, C, D clearly shows that the small-celled tissue of the apex of the axis includes the intersecting octant walls. A similar origin of the axis to that in *Lycopodium* and *Selaginella spinulosa* may be traced for *Isoetes*, notwithstanding the absence of a suspensor and the small size and late definition of the apex (Fig. 191, pp. 359-360). The case of *S. Martensii* is interesting for comparison, since there is a single initial

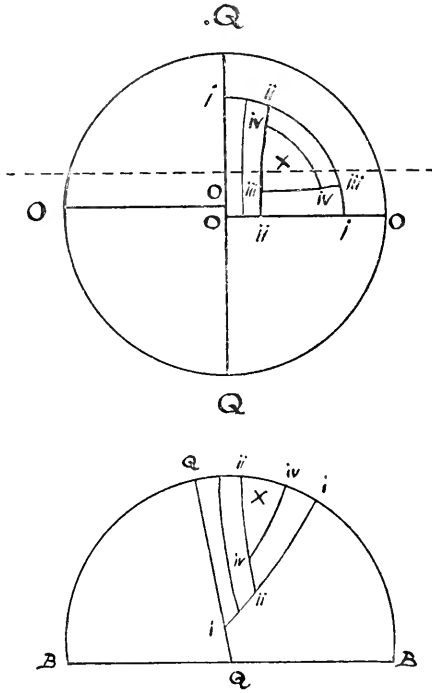

FIG. 357.

Diagrams to show in view from above and in section how growth with a single three-sided initial cell may be established in an epibasal hemisphere divided into octants. The quadrant wall, Q, Q, and the octant wall, o, o, are the first of the series of cleavages, continued by the walls i, i, ii, ii, etc. The result is that the initial cell (o) is formed at the nearest possible point to the centre, consistent with the sequence of its segmentation.

cell, a condition which is probably derivative as compared with that of *S. spinulosa*, with its small-celled meristem. Pfeffer's drawings¹ demonstrate how this originates with the octant wall forming one of its lateral faces; in fact, at the nearest point to a central position compatible with its existence as a single initial cell. The embryo of *Equisetum* shows this even more plainly: if a single initial cell is to be carved out of an epibasal hemisphere of four octants so as to be as near to the centre of

¹ Hanstein's *Abhandl.*, i., Taf. iii. iv.

it as possible, it could not be done more exactly than is shown in Sadebeck's drawings (Fig. 214, p. 393): one octant enlarges and thrusts the less active octants aside: and its central angle immediately becomes one of the angles of the pyramidal initial, which then continues to segment in a sequence of which the original octant walls were the first terms. The succession of the cleavages is shown diagrammatically in Fig. 357 A and B. The necessary consequence is an appearance in section accurately shown in Fig. 358 A, in which it will be seen that the apical segmentations conform with great exactitude to those shown in the diagram.

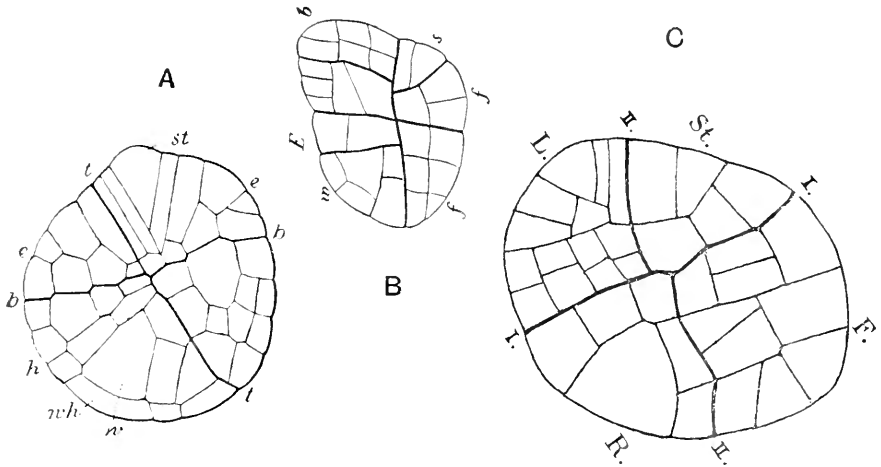

FIG. 358.

Drawings of embryos. *A*, of *Equisetum* (after Sadebeck). *B*, of *Marsilia* (after Hanstein). *C*, of *Adiantum* (after Atkinson). They all illustrate with accuracy the origin of the apical cell of the axis, according to the scheme shown in Fig. 357.

Even in Leptosporangiate Ferns, notwithstanding the influence of a large and precocious cotyledon, the same relation of the apical cell of the axis to the octant segmentations may be observed. It is accurately shown in Hanstein's drawing of the embryo of *Marsilia salvatrrix* (Fig. 358 *B*), where the apical cell with its first segment directly adjoins the octant-wall. It is equally clear in Campbell's Fig. 178 *F*¹ for *Onoclea sensibilis*, while Fig. 358 *C*, after Atkinson, showing the embryo of *Adiantum*, indicates the same cleavages there also. Thus, even in embryos where there is a single initial cell, that cell is carved out so as to be in the point nearest the centre of the epibasal hemisphere that is consistent with their mode of segmentation. In the Marattiaceous Ferns, where there is no constant single initial at the apex of the stem, the matter is not so clear: but Fig. 292 leaves no room for doubt that the position of the apex of the stem is substantially the same. In the Ophioglossaceae the segmentation in the embryo has not been accurately made out, but sufficient is known to show that in

¹ *Mosses and Ferns*, p. 322.

Ophioglossum vulgatum (Figs. 260 and 260 bis, p. 466) and in *Botrychium* (Figs. 261, 262, p. 468) the apex originates from approximately the centre of the epibasal hemisphere, and notwithstanding that there is an early displacement owing to the precocious development of the first root. The facts thus suffice to support the general statement, that whatever the other fluctuations of form of the Pteridophyte embryo may be, all the exactly investigated types show the apex of the axis to originate in close relation to the intersection of the epibasal octant-walls.

It is accordingly recognised that the very first step that can be observed in the embryogeny involves the definition of its polarity, and that the apex of the shoot bears a constant and close relation to the centre of the epibasal hemisphere. The base of the primitive shoot thus defined is the suspensor where that part occurs; where it is absent the centre of the hypobasal hemisphere may be held to mark the base of the primitive axis.¹ The whole embryo thus appears from the first as a radially constructed spindle upon which appendages may be borne: these are of the nature of leaves and of accessory roots, and they may vary in number, and in position and time of origin, causing thereby marked variations in the early structure, which are for the most part open to biological explanation. The embryo is, however, subject also to early distortion in various ways, through the formation of swellings of the nature of haustoria, or of storage tubers: or it may be that modifications of form arise in relation to the precocious development of some one appendage and the correlative delay or diminution of another, or even of the axis itself. Though such modifications are probably secondary, yet they have produced such peculiarities of form and aspect in the embryos in which they appear that the originally radial form of the shoot is disguised, and its morphology has consequently been misunderstood. Examples will now be quoted illustrating these various points.

The origin of the cotyledon in Ferns is constant in time and place: this is probably related to the prone position of the embryo, and to its importance for early nutrition in replacing the supply derived from the small and evanescent prothallus. But in other cases there is less constancy: in *Equisetum* there may be sometimes two, though usually three cotyledonary leaves in the first whorl. In *L. Selago* and *Phlegmaria* one cotyledon takes precedence, soon followed by a second leaf (Figs. 183, 184, 185), but in *L. clavatum* two equal cotyledons are formed (Fig. 186). Again, in *Selaginella Martensii* two equal cotyledons appear very early; in *S. spinulosa* Bruchmann specially notes that though the two cotyledons may

¹ Some previous writers have held the primary axis to run from the stem apex obliquely to the apex of the first root. Reasons will be shown below for regarding the root as an accessory part, commonly lateral, and not determinate in position. Its growth may in certain cases approximate to the original axis of polarity of the shoot, as it does in the embryos of Ferns; but this is held to be an occasional and accidental rather than an inherent character, as is indicated by a comparison with the more bulky embryos of *Equisetum* and the Ophioglossaceae.

sometimes be equal (Fig. 190 c) they are usually unequal (Fig. 190 d), and that the second may be long delayed, and only make its appearance after the shoot issues from the spore: nor is there any constancy in the position of the first relatively to the suspensor and first root (compare Bruchmann, Figs. 62, 63 of *Scl. spinulosa*). These examples will serve to show the inconstancy of time and place of origin of the first leaves in the Pteridophytes at large, notwithstanding the constancy seen in Ferns. There is, however, one feature that appears constant: it is their orientation relatively to the axis: they all appear to present towards the axis or to that point where the axis will ultimately make its more obvious appearance, a surface that may be recognised as more or less characteristically "adaxial": even in the extreme cases of *Lycopodium cernuum* and of *Phylloglossum*, where the number of protophylls is most irregular (Figs. 101, 188, 189), they are not disposed at haphazard, but face towards the point where the apex of the definitive axis appears. This constancy of orientation of the first leaves resembles that of the later leaves, and supports the conclusion already arrived at, that cotyledons and protophylls are essentially of the same category as the later foliage leaves, and are essentially appendages of the axis (pp. 186-7).

Here it may be well to mention cases of that precocity of the cotyledon which carries with it a correlative delay in development of other parts, but especially of the axis (pp. 183-4). It is seen in Ferns, where the cotyledon is hurried forward to supply a nutritive need, and a correlative delay of the axis is the consequence (Fig. 15). The same is seen in *Isoetes*, with a similar result (Fig. 191 c). But perhaps the most remarkable examples are seen in the Ophioglossaceae, plants which show greater adaptive plasticity of the embryo than any others. It has been shown that in certain forms, *Oph. vulgatum* (Fig. 260, 261), *Botrychium Lunaria* (Fig. 262, 263), the cotyledon is small, and probably reduced in accordance with the underground habit: in others, *Helminthostachys* (Fig. 267), *Botrychium virginianum* (Fig. 261) the cotyledon appears above ground as an expanded green leaf, and though the apex of the axis is correlatively delayed, it is still recognisable. But in others again the cotyledon is precociously developed to such a degree that it is difficult or impossible to recognise the apex of the axis:¹ this may be held to be an extreme case bearing with it correlative consequences which have completely upset the balance of parts in the embryo.²

The time and place of origin of the first and subsequent roots is open to variation. In Ferns it arises in the hypobasal hemisphere, and this is the case also in certain types of *Equisetum* (Fig. 214), though in *E. hiemale* it is apparently higher up (p. 392): but in any case it is clearly lateral in *Equisetum*, and the condition in Ferns appears to be only a less bulky variant on the same type. The apparent difference in exact point of

¹ *Oph. moluccanum*, Campbell, *l.c.*, p. 186, and Pl. X.

² Compare p. 469, where Campbell's alternative view is mentioned.

origin of the first root is again fully illustrated within the Lycopods: in *Selaginella* (Fig. 190) the first root originates laterally from the hypobasal tier, and near to the suspensor: in *Lycopodium* (Figs. 183, 185, 186, 188) and in *Isoetes* (Fig. 191) it springs from the epibasal tier, and is thus necessarily in a lateral position upon the whole embryo. Its orientation relatively to the cotyledon also varies: in *Isoetes* it is opposite to the cotyledon (Fig. 191), in *Lycopodium* and *Selaginella* it is frequently on the same side of the axis as the cotyledon, but this is not constant in *S. spinulosa*: in Ferns it is on the same side as the cotyledon (Fig. 15). It thus appears that the root is not definite in level or in orientation relatively to the other parts: while in point of time, its extreme delay in *L. cornutum* and its absence in *Salvinia* are cases too well known to require remark. It is notable that though the root in Seed-Plants directly faces the suspensor, this is not the case in any Pteridophyte: in them it is always a lateral appendage, however nearly it may sometimes approach the centre of the hypobasal hemisphere. Accordingly it cannot be held to be itself the continuation of the primitive axis.

Though the root may appear late in the embryology of certain Lycopods, the converse is seen in the Ophioglossales: in them the precocity of the root upsets the balance of parts usual in other embryos. This is seen in moderate degree in such types as *Botrychium virginianum* (Fig. 261) or *B. obliquum* (Fig. 264), in which, though the embryo differentiates slowly, the root soon takes a prominent place; but in *Botrychium Lunaria* (Fig. 263) and *Ophioglossum vulgatum* (Fig. 260, 260 bis) it is clear that the root, rushing forward in its development, outstrips the other parts, and becomes the prominent feature of the embryo. The extreme is, however, found in *Oph. pendulum*, and so prominent is the root here that Campbell has described the embryo as consisting of "roots only."¹ This may probably be held as the consequence of precocity of the root carried to a greater degree than in other species: and the precocity finds a ready biological meaning in its mycorrhizic function. It may be held that the embryo hurries it forward as an accessory aid to nutrition, and the parts of the shoot are correlatively delayed till sufficient store is at hand to justify their development above ground.

Though the balance of parts in the embryo may be thus disturbed by the precocity of certain parts, still more profound disturbances appear associated with parenchymatous swellings of the nature of haustoria or of storage tubers, and these are usually accompanied by considerable curvature, and distortion of the axis. Such swellings are of two sorts: intra-prothallial haustoria, to which the name "foot" has commonly been applied, and extra-prothallial tubers, known under the name of "protocorm." In simple types of embryo with suspensor the hypobasal tier of the embryo may remain small, though functioning as an haustorium (*L. Selago*, Fig. 183, and *L. Phlegmaria*, Fig. 185): but in others it may enlarge in the direction

¹ *Ann. Jard. Bot.*, vol. xxi., p. 189. See remarks on p. 469 above.

of the greatest nutritive supply and take a strong curvature, as in *L. clavatum* (Fig. 186). In others, again, it may provide the basal part of the embryo and root, without any swelling (*Sel. spinulosa*, Fig. 190), or an haustorial swelling may be formed, with convex curvature, on the side next to the food supply (*Sel. Martensii*). In embryos without suspensor the hypobasal tier may maintain this same function, but it is usually only slightly enlarged (*Equisetum*, Fig. 214; Fern, Fig. 15; *Isoetes*, Fig. 191; *Ophioglossum vulgatum*, Fig. 260 bis; *Botrychium Lunaria*, Fig. 263). It would appear from the inconstancy of their development, and their position in relation to their obvious uses when present, that these haustorial growths are of the nature of relatively late and direct adaptations at or near to the basal region of the axis of the embryo, and it is significant that there is no special haustorial growth in *Lyc. Selago* or in *Selag. spinulosa*, both of them species believed to be primitive types of their respective genera.

The extra-prothallial swellings, of the nature of protocorms, differ in origin and in function from the intra-prothallial haustoria (Figs. 101, 178, 188): they spring from the epibasal tier, and do not serve as suckers. It has been argued at length above (p. 351, etc.) that there is good reason to believe them to be secondary in their origin: however greatly these gouty interludes may affect the form and appearance of the embryo, their effect is temporary, and the shoot ultimately settles down into a normal Lycopodinous type. If this view of the protocorm as a special secondary development be accepted, then it may be put on one side as not directly affecting the bearings which embryogeny may have on the theory of origin of the shoot.

The various types of embryogeny observed among Pteridophytes have now been reviewed, and it remains to attempt to separate the characters which are secondary, special, and fluctuating, from those which are primary and constant, with a view to some general estimate of the embryogeny as an aid to a morphological conception of the shoot. Following the reasoning contained in the preceding pages, the occasional swellings of the nature of a protocorm or of a haustorium, together with the curvatures and distortions which these often produce, may be set aside as secondary; similarly, the precocious developments of root or of leaf, which sometimes upset the balance of parts in the embryo, may be set aside as special biological adaptations; for even where a cotyledon or a root appears early and anticipates apparently the other parts, still in all accurately observed cases the relation of the axis to the primary segmentations is found to be maintained. Further, the position of the first root is always lateral; its orientation and level of origin varies, as well as the time of its appearance: these facts point to its being an accessory part upon the embryonic body. The first foliar development is inconstant in position and time and number of the leaves, but it is constant in the fact that the protophylls are always lateral with respect to the point where the axis will appear, and orientated with regard to it, so that more or less

definite "adaxial" surface is presented towards it. It thus appears that the most constant features of the embryo in Pteridophytes are: (1) the origin of the axis in relation to the initial polarity of the embryo, and (2) the orientation of the first leaves relatively to it. These facts once recognised must needs take a premier place in Pteridophyte embryology. The embryo is thus presented to the mind as consisting essentially of an axis or spindle, liable in the different types to varying proportions of length

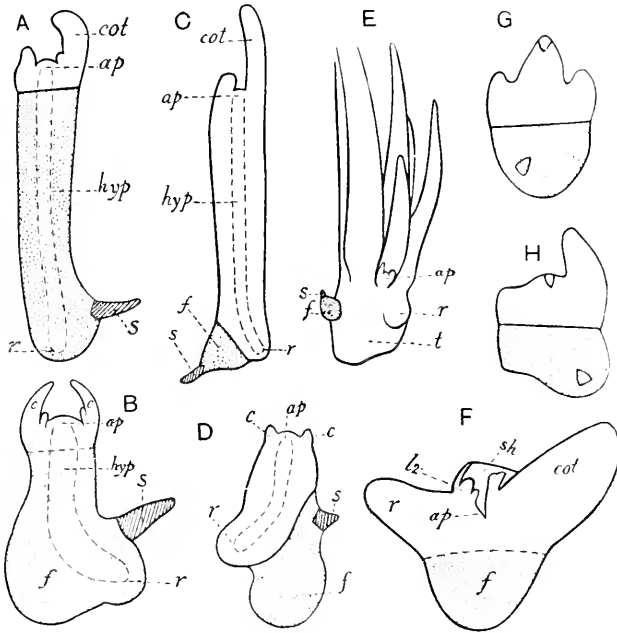

FIG. 359.

Diagrams of embryos: the suspensor is cross-hatched; the hypobasal hemisphere dotted, and the epibasal clear. A=*Selaginella spinulosa*. B=*Selaginella Martensii*. C=*Lycopodium Selago*. D=*Lycopodium clavatum*. E=*Lycopodium cernuum*. F=*Isoetes*. G=*Equisetum*. H=*Adiantum*. c=cotyledon; ap=apex of axis; r=root; hyp=hypocotyl; f=foot; s=suspensor. These diagrams place various of the divergent types described in the text in juxtaposition, and thus bring into prominence their points of similarity and of difference.

and breadth, upon which the other parts are inserted as appendages: the leaves with a more regular relation, the roots with less regular relation, and the haustoria or tubercles being occasional. In cases where a suspensor is present this constitutes the organic base, while the stem-tip forms the organic apex of the spindle, which is itself built up from the suspensor, the hypobasal, and the epibasal tiers. In cases where no suspensor is formed the relations of parts are still the same, but the base is formed from the centre of the hypobasal tier; often, however, the latter is specially developed as an haustorial foot, or disguised by the early origin of a root. The spindle thus defined is

held to be the primitive axis, which in virtue of its constancy and of its early development is regarded as the fundamental factor in the embryonic shoot. The prior existence of the axis in the normally developing shoot, and the origin of the leaf laterally upon it, have been held as the basis of the enation theory of the leaf (Chapter XI.): since there is reason to recognise the existence of that polarity of the embryo which defines the axis, prior to the origin of the leaf in all the varying forms of the embryo, the same arguments will apply even to the earliest phases of the ontogeny. In fact, the embryo itself is from the first segmentation a shoot showing polarity: the appendages appear later. Such results from the comparative study of embryos greatly strengthen the strobiloid theory of the shoot, as enunciated in Chapter XI.: at the same time they indicate that the embryo is not a thing apart from the later developed shoot, but merely its initial phase, modified in various ways to meet biological needs, but preserving essentially the same relations of prior-existent axis and of leaf produced in lateral relation to it.

A question remains as to the relation of the embryos with suspensor to those in which there is none. Is it possible to recognise either of these as the prior state? The two types indicate different modes of prothallial nursing: that with a suspensor is characteristic of stocks having relatively bulky prothalli, often underground, and at the present time carrying on as a rule a saprophytic nutrition: the type without suspensor is characteristic of stocks with less bulky prothalli, usually above ground, and self-nourishing. The determining factor would appear to have been the bulk of the nourishing prothallus, rather than the exact way in which it obtained its nourishment. The question will therefore be, whether the evidence points to a bulky prothallus and embryo with suspensor as the prior condition, or a less bulky prothallus and embryo without suspensor. There are two phyla from which comparative evidence on this point may be drawn, viz. the Lycopodiales and the Ophioglossales. In the Lycopodiales, in view of the upward curvature commonly seen in their embryos (Figs. 183, 186, 188, 190), and the necessity of their bursting through the tissue of the prothallus at some point apart from the archegonium to gain their freedom, the complete inversion of the embryo, and its emergence in the neighbourhood of the archegonial neck would be a simplification of an awkward and inconvenient process. Such a simplification is found in *Isoetes*, which there is good reason to look upon as a more specialised type of the Lycopodiales, and in which the indeterminate position of the first segmentation of the zygote suggests how the inversion may have come about. Moreover, the condition with suspensor is found in its simplest form, and without any tuberous complications, in such species as *L. Selago* and *Sel. spinulosa*, both of which are believed to be relatively primitive forms. The facts supply no proof, but they suggest a reasonable probability that within the Lycopodiales there has been a progression from the state with suspensor, and apex directed to the base of the archegonium, to the state without a

suspensor, and with the apex directed to the archegonial neck. A similar probability may be recognised in the Ophioglossales, and *Botr. obliquum* may be held to illustrate the more primitive embryogeny; and it shows also that an awkward curvature during development is entailed on the young embryo (Fig. 264): the type common for the rest, without suspensor, and with the apex directed to the archegonial neck would be the derivative, and in them the awkward curvature is avoided. As regards other phyla, such as the Equisetales and Filicales, where a suspensor is absent, the question must remain open; but there is nothing apparently to oppose the view that they also may have sprung from a stock with a suspensor, and that, as suggested for *Isoetes*, and for most of the Ophioglossales, they also may have broken away from a development which had ceased to be practically useful. The evidence from the Ferns, such as it is, indicates a probable progressive reduction of the prothallus on passing from the Eusporangiate to Leptosporangiate types: this would accord with a general opinion that the primitive Pteridophyte prothallus was generally a massive structure, and the primitive embryo which it nursed of the type with a suspensor.

A comparison of the spindle-like embryonic axis of the Pteridophytes which these observations have disclosed with the young sporogonium of Bryophytes, and especially of some of the Jungermanniaceae, is inevitable: it would, however, be an error to press this comparison closely. In both cases a segmented body of radial symmetry is recognised, endowed with growth. But there is no sufficient reason to believe that any living sporogonium really prefigures any early Pteridophyte: the similarity may well have had its evolutionary origin along distinct phyletic lines, but subject to somewhat similar biological requirements. On this point the difference in position of apex and base has its interest; while the suspensor of Pteridophytes points to the neck of the archegonium and the apex towards the nutritive prothallus, in Bryophytes the apex is towards the neck of the archegonium and the foot, or in Jungermanniaceae the basal appendage, grows into the tissue of the gametophyte. There would appear to have been an essential difference of method here: in the one case leading to the direct establishment of an ephemeral sporophyte, deriving its nourishment from a perennating gametophyte, and demanding early dissemination of its spores: this is characteristic of the Bryophytes. On the other, the tardy establishment of a perennating sporophyte deriving its nourishment at first from the gametophyte, but eventually achieving a power of self-support, and producing its spores relatively late: this is characteristic of the Pteridophytes, and extended with modifications to the whole Vascular Vegetation.

From the above pages it will appear that the evidence to be drawn from comparative embryology as bearing on the morphology of the shoot is by no means to be neglected. When the fluctuating characters and features of more immediate adaptation are removed, there remains a sub-

stratum of constant fact, which gives no uncertain support to the strobiloid theory of the shoot. For it appears that from the very first segmentation of the zygote the polarity of the embryo is defined, and the position of its axis may thereafter be recognised with certainty. The embryo is in fact from the first a shoot with pre-existent axis, not a congeries of parts which are ultimately related to an axis of later origin. While we recognise thus the importance of the facts of development in indicating the shoot-character as initiated at once, it is necessary always to bear in mind the critical position of the young embryo until it is self-supporting: the urgent need of nutrition is the chief influence which has contributed to its biological specialisation, and to the assumption of those aberrant forms which tend so strongly to disguise its real nature as a simple and primitive, but from the earliest stages a leafy shoot.

CHAPTER XLIII.

THE VEGETATIVE SYSTEM OF VASCULAR PLANTS ANALYSED.

A MOST effective factor in the higher development of the sporophyte is the continuance of apical growth. In some few cases this is absent, as in the sporogonium of certain Liverworts, and the development is then but small; or intercalary growth may intervene as in the Jungermanniaceae, and be continued for a long period, as in the Anthocerotae; but in all the more elaborate cases, including the Mosses and all Vascular Plants, localised apical growth is effective, though it is usually associated with intercalary growth. This localised and continued apical growth is taken up early by the apex of the axis in the young embryos of Vascular Plants, and is persistent through life: it is by reference to the simpler cases where it does not exist that its importance as a factor in the organisation of the plant-body will be duly appreciated. In presence of the sporophytes such as those of the Liverworts it becomes evident that apical growth is not a general factor in the neutral generation: it seems probable that in the first instance it did not exist, and that the whole sporophyte owed its origin to a primary, intra-archegonial embryogeny: that localised apical growth, and as a consequence continued embryogeny, was acquired as a secondary development, though it has become a dominating influence in all the more elaborate sporophytes.

The mode of segmentation which accompanies apical growth provides important material for comparison, according as it is conducted with a single initial cell or with many, and according as the meristem is stratified or not. In certain cases comparison leads to the conclusion that the more definite segmentation with a single initial is a derivative state in the sporophyte, and that with several initials the more primitive. Among the Bryophyta there is no distinctive evidence on this point: the sporogonia of the Musci have as constantly a single initial cell as those of the Hepaticae have none. But among the Pteridophyta evidence of value comes from the Filicales, and also, though less clearly, from the Lycopodiales. A

comparative study of the meristems of root, stem, and leaf in Ferns indicates that the most complex meristic condition is found in the Marattiaceae, a series of Ferns known to have been well represented in Palaeozoic times (see p. 650, etc.). The Osmundaceae are now being more and more firmly established in relation to the ancient Botryopterideae: their characteristic structure is recorded back certainly to early Mesozoic times, and possibly earlier: they show in their meristems an intermediate condition, while that of the roots is variable: *Todea* often has the structure characteristic of the Marattiaceae: *Osmunda* has sometimes a single initial in the root, but often more, with curious irregularities of the segmentation. Its stem-structure shows a similar state, while the leaf in the Osmundaceae is alone among Ferns in possessing a three-sided initial with regular segmentation: the leaf (except in the filmy *Todeas*) also shows a structural complexity of the wings similar to that of the Marattiaceae. All other Ferns, including even such early forms as Schizaeaceae and Hymenophyllaceae, have the single initial in all their parts, while the wings of the leaf also have a single marginal series of cells with definite segmentation. From this it is concluded that in the Filicales there has been a progression from types which were more primitive—where the meristic structure was more complex, with the centre of construction more deeply seated, and as a consequence with a plurality of initials of prismatic form—to those characteristic of more modern times, where the meristic construction is less complex, the centre of construction less deeply seated, and as a consequence with a single initial having the form of a three-sided, or even a two-sided, pyramid. The progression has been from a more massive to a less massive construction, and from less definite to more definite segmentation. It has been shown above (p. 637) that a similar progression may be traced in the sporangial character.

A parallel progression, though less definitely indicated, is to be traced in the Lycopodiales. At the apices of stem and root in the ancient genus *Lycopodium* the tissues are not referable to a single initial cell. In *Selaginella spinulosa* also, that species which on grounds of its radial shoot and its anatomical structure we have recognised as a relatively primitive type of the genus (pp. 300, 332), there is from the first stages of the embryo a small-celled meristem, without any single initial in stem or root. But in the dorsiventral species, which on grounds of form and structure are held to be derivative types, there may be a single initial both in axis and root, though variable in the details of form.¹ This mode of apical growth makes its appearance in the very first stages of the embryo (p. 356). It seems therefore probable that here again, as in the Filicales, there has been a phyletic progression from a less definite segmentation with several initials at the apex of stem and root to a more definite segmentation with a single initial cell.

¹ De Bary, *Comparative Anatomy*, p. 15. Treub, *Selaginella Martensii*, Leide, 1877, Pl. 1., II., III.

Such examples, showing a parallelism of progression raise the question whether in the Pteridophytes generally the apical segmentation with a small-celled meristem and several initials was not the more primitive state, and that with the more definite segmentation of a single initial the derivative. It is not possible in the present state of knowledge to come to a definite conclusion on this point; and in the sporangiophoric Pteridophytes, including also the Ophioglossales, the evidence is less clear than in the cases above quoted; for in them there is a prevalence in the very isolated living genera of a definite segmentation with a single initial: there is, it is true, nothing to preclude the view that they also were derived from forms with several initials: certainly their eusporangiate sporangia, and deeply sunk antheridia and archegonia, which usually go with the less precise segmentation at the apex, would suggest that this was so.

Closely associated with the continued apical growth of the shoot is the formation of the appendages, leaves, emergences, and hairs. The leading fact with regard to the leaves is that in all cases they are found to originate normally in the same way, by enation from the pre-existent axis, and in acropetal succession: the embryological comparison given above shows that this holds even for the protophylls. It applies equally for the small leaves of the strobiloid types and for the larger and more complex leaves of the Ophioglossales and Filicales: moreover the leaves are dorsiventral, and show a constant orientation to the axis which bears them. The high degree of persistence of their relation to the axis, notwithstanding the differences in size, form, and number, indicates that the parts large or small are substantially of similar nature throughout the Pteridophytes, though not necessarily homogenetic. The discussion in Chapter XI. has led to the conclusion that the leaves originated in descent as they are seen to do now in the normal course in all Pteridophytes, viz. by enation from the apically growing axis. It is held as probable that the process of leaf-formation which appears in every normal ontogeny, should represent the mode of their phyletic origin.

The view that there is an inherent improbability in this mode of phyletic origin of the leaves has already been alluded to (p. 659). But leaves are not the only appendages of the simple shoot: emergences and hairs must also be considered, and from these some light may be derived as to the origin of appendages at large which may illuminate the probable origin of leaves. Emergences occur in isolated genera and species of Vascular Plants, both in Pteridophytes, and Seed-Plants: they sometimes contain vascular tissue, and in early stages of development may closely resemble leaves. Both emergences and hairs arise ontogenetically by enation from the plant-surface, and both are often irregular in their position. Is there any reason to believe that these sporadic appendages of the shoot were fashioned out of some pre-existing organ? The very irregularity of their position in the individual, and of their occurrence in the race precludes such a view for them: the conclusion

seems unavoidable that these minor organs arose phyletically by enation, as new outgrowths, from a previously smooth surface. If it be admitted for emergences and hairs that new organs, not pre-existent in the race, can originate by enation, are we to take a different view for leaves, notwithstanding that the facts of individual development by enation are alike in both cases? Is the leaf to stand alone among the appendages of the shoot in having been fashioned from some pre-existing organ? It may well be asked whether this view has any other foundation than in pre-conception apart from fact. The ontogeny is against it. The phylogeny does not show it to be a necessary view. Comparison with other appendages of the shoot gives it no support. And, finally, its acceptance has led its adherents into theoretical difficulties involving hypothetical organisms such as "Archegoniate Algae"; or a "Prohepatic" type has been assumed. These appear as unnecessary as they are non-existent to those who accept the guidance which the individual development gives with so great constancy. It may, on the other hand, be urged that leaves are essentially different from emergences and hairs: that they are more constant in occurrence, and more regular in position, as well as physiologically more important, as they were also prior in descent. But such differences do not indicate a radical difference in their mode of origin: the early phyletic appearance and physiological importance of the leaf would rather lead one to expect that just such priority and regularity should rule in their organisation as distinguishes them from the other appendages of the shoot. On these grounds it is held that the phyletic origin of the leaf by enation, like that of emergences and hairs, is more probable than any theory under which it would be fashioned from some pre-existing organ, hitherto undefined, and wholly hypothetical.

The other appendages—the roots—bear no direct relation to the continued apical growth of the axis. This fact, together with the great diversity of their position and time of origin indicates them as accessory parts—as they have already been held to be in the primary embryogeny. Thus whether from the primary embryogeny, or from the plant showing continued apical growth, the conception of the simple shoot emerges: it is composed of a pre-existent axis defined in relation to the first cleavage of the zygote; upon this axis leaves are produced laterally, by enation in acropetal order, also, though less constantly, emergences and hairs; while the roots, and even the first root of the embryo, are accessory organs.

The simple shoot thus constituted, forms the unit upon which the vegetative region of all Vascular Plants is built. Comparison indicates that the radial construction of the shoot was primitive for the sporophyte, and that where dorsiventrality occurs, it has been secondarily acquired (Chapter XVI.). Such a shoot, developed as it is directly in the embryogeny, may sometimes remain entirely unbranched: this is seen in some of the simplest species of *Lycopodium* (e.g. *L. Trencilla*) or *Selaginella* (*S. pumila*

in its simplest forms): it is habitual, though with occasional exceptions, in *Isoetes* and the Ophioglossaceae, and it is seen in many Ferns, and especially in such early types as the Marattiaceae, and Osmundaceae. The whole plant in these cases consists of a single upright radial shoot, and there is reason to believe that this is itself a primitive condition; such a view accords with the generally primitive character of the plants in which it is seen. It may, however, result also from reduction, as may often be seen in starved seedlings of annual flowering plants.

But in all the more advanced types, branching of the shoot occurs, resulting in multiplication of shoots, and ramification often of a high order. It is necessary to put this in relation to the simple unbranched state. The terminal dichotomy of the shoot was probably a primitive mode of branching. It is characteristic of those species of *Lycopodium* and *Selaginella*, which are held as primitive; (viz. the *Selago* section of *Lycopodium*, and in *Selaginella spinulosa*): it is seen occasionally in *Isoetes*, in the Psilotaceae, and in the Ophioglossaceae as a rare occurrence, also in the Osmundaceae, and in some other Ferns. Gradual transition from the dichotomous to the monopodial branching may be traced by comparison of the more primitive with the more specialised species of *Lycopodium* and *Selaginella*, while in some cases the change may be traced through unequal development of the branches of the dichotomy in passing from the earlier to the later branchings of the individual life.¹ This makes it appear probable that the monopodial is a later and derivative mode of branching.

It is a question what the relation of these terminal branchings of the shoot may be to such lateral branchings as are seen in *Equisetum*, and *Sphenophyllum*, or in those Ferns where axillary branching occurs. It seems not improbable that these are in origin quite distinct modes of amplification of the vegetative system from those brought about by terminal branching, and that they are to be regarded rather as regularly recurring and early, but nevertheless accessory developments. A reason for this distinction is to be found in what is seen in *Equisetum*, for here terminal fissions of the strobilus are occasionally to be found, and are quite different in nature and origin from the formation of branches normal for the genus. Again, in the Ophioglossaceae, in which family dichotomous branching has been seen as a rare occurrence, and in many Ferns such as *Pteris*, which show occasional dichotomy, buds arise at points remote from the apex of the shoot, in the former case upon the roots, in the latter commonly near to the bases of the leaves: these are clearly adventitious. All of these are probably of distinct origin and nature from the terminal branching which is fundamentally dichotomous. Moreover there is a structural difference between terminal ramifications and branchings which are accessory: the former carry on the vegetative construction with amplified stele, and fully formed leaves arranged as in the

¹This is believed by Bruchmann to be the rule throughout the genus *Selaginella*, their first branching being regularly dichotomous. *L.c.*, p. 18.

region below the branching: the latter commonly start afresh from simple beginnings, analogous to those of the seedling, with a contracted stele, and leaves of smaller size, and simpler form and arrangement. These facts seem to mark a distinction between terminal and accessory ramification.

By either, or by both of these modes of branching, there is ample provision for extension of the shoot-system, over and above its own apical growth. The branchings, whether terminal, axillary, or adventitious result in the repetition of the original unit, modified, it may be, in certain minor respects, but retaining the essential characters of the primary shoot. But the upright position so common for the latter is not habitually maintained by the later derivatives, which show a tendency to run off into plagiotropic and dorsiventral modifications: not uncommonly they may take an underground course. And thus, primarily from its own apical growth, but secondarily from repetition of the primitive unit as a result of branching, the diverse vegetative systems of vascular plants are built up.

There are certain analogies between the branching of the axis and that which is seen in the leaf of many vascular plants. In not a few cases the leaf is unbranched, and this—as in the case of the unbranched axis—may be held as a primitive condition, though very many cases where simple leaves exist have probably been derived by reduction from more complex types with branched leaves. But just as the axis may dichotomise in primitive forms, so also is dichotomy seen to be widely existent in the leaves of early vascular types, and examples come from all the phyla excepting the Lycopodiales. In the Equisetales, the ancient *Asterocalamites* had leaves repeatedly dichotomous (Fig. 199): and a somewhat similar branching of the large leaves existed in *Pseudobornia*: these show that though many of the fossil Equisetales, and all the living ones have simple leaves, the capacity for their dichotomy existed in the race. In the Sphenophyllales the dichotomy of the leaf is an outstanding feature, and it is represented in the modern Psilotaceae: in the latter *Tmesipteris* is specially interesting, since, though normally the sporophylls dichotomise but once, repeated dichotomies occur occasionally in the middle of the fertile region; this suggests that the leaves possess capacities for branching, normally unrealised, but brought into existence where the nutrition is most effective. In the Ophioglossales branching of the leaf is also seen; sometimes it is clearly dichotomous (*Ophioglossum palmatum*), but in *Botrychium* and *Helminthostachys* it is modified in the direction of a monopodial branching. It is, however, in the Filicales that branching of the leaf attains its climax; and the prevalent dichotomy, and transition to a monopodial branching show interesting analogies to what is seen in the shoot itself.¹

The roots, which have been recognised as adventitious and accessory parts upon the shoot, also show a branching similar to that of axis and of leaf. In the Lycopods the roots are sometimes unbranched, as is usual

¹ See p. 627, etc., where the literature is quoted.

in *Phylloglossum*; but in *Lycopodium*, *Selaginella* and *Isoetes* there is dichotomous branching, often with unequal development of the shanks. *Ophioglossum* also shows dichotomy of the roots. But in *Equisetum* and in Ferns the branching is definitely monopodial, the lateral roots originating apart from the apex of the main root; a condition comparable with the origin of the lateral buds in *Equisetum*, or of the axillary buds in the Hymenophyllaceae. The similarity of these conditions to what is seen in axis and leaf is unmistakable.

It is thus seen that in the axis, leaf, and root provision is made for amplification of each several part by branching, and the methods of branching seen in them all are essentially alike: each type of part may remain unbranched, or it may dichotomise, or show monopodial branching: it is also seen that dichotomous branching is prevalent in those forms which comparison or palaeontological evidence shows to have been primitive. It is natural that such analogies should exist between parts of the same individual plant; but there is no reason to see in them anything more than parallel modes of amplification of parts which were throughout their descent distinct in their origin, and in their nature.¹

An analysis of even the most complex types of the vegetative system in Vascular Plants involves only the factors thus disclosed, viz. the shoot consisting of axis and leaves, with occasional emergences and hairs, and the accessory roots. The apical growth of the shoot may be continued indefinitely, with indefinite repetition of its several appendages; or it may itself be duplicated either by terminal or by lateral branchings, with or without accessory roots. In fact, the whole vegetative system of the plant-body, however complex, is built upon the simple shoot as the unit: its apex, initiated in the first definition of polarity in the embryo, shows continued apical growth with formation of an indefinite succession of appendages: it may fork at its distal end: or new shoots may be initiated below the apex: but still the whole plant-body is derived from the extension or it may be the forking or repetition of that fundamental unit—the shoot.

¹The fact that these structural analogies exist cannot rightly be held to show any common origin of those parts, unless examples of dichotomy can be brought forward in which one limb develops as one type of part, the other as another type; or unless a gradual transition from dichotomy to monopodial branching, such as is seen in the branching of the leaves of Ferns, smooths over the transition from branchings which produce parts of the same category to those which produce those of different category. Such direct evidence can easily be found indicating a common origin of rachis and pinna in the leaves of Ferns; but it has never yet been produced in support of the views of Potonié or of Tansley as to the common origin of axis and leaf, already alluded to above (pp. 628, 630). All the evidence adduced by them is indirect; though the structural analogies are interesting, they carry little weight against the positive fact that in all observed cases the leaf originates normally as a lateral appendage of the axis.

CHAPTER XLIV.

THE VASCULAR SKELETON.

PASSING from the characters of external form to the internal arrangement of tissues, the Vascular system provides by far the most constant structural characters; and, as it is naturally the best preserved tissue in the fossils, it gives a basis for comparison of both ancient and modern Pteridophytes. But in dealing with anatomical facts it must be remembered always that in any progressive evolution vascular structure follows, and does not dictate external form: all the evidence which it yields is necessarily *ex post facto* evidence. On the other hand, the structural effect of a certain development may persist even after the formal characters with which it was primarily bound up may have been altered or even wholly removed. In fact, anatomical characters are apt tardily to follow evolutionary progress, and to thereafter persist: they possess what may be described as a sort of phyletic inertia.

It has already been shown in Chapter XV. that the prevalence of a central stele in the axis of Vascular Plants is in direct accord with a strobiloid theory of the primitive shoot: and that the strictly cauline origin of the central region of the stele, and the insertion of the leaf-traces upon it with but slight disturbance, as seen especially in the smaller-leaved forms, are also features which harmonise with a strobiloid theory: the facts were held to suggest a primitive condition in which the axis was the dominant factor, and the appendages of subordinate importance. This position receives additional support from the demonstration given above in Chapter XLII., that the axis is the first part to be structurally defined in the initiation of the embryo. But it will be necessary further to show how far the Vascular structure of the larger-leaved types will accord with a strobiloid origin. The leading anatomical facts required for this are contained in the special descriptions of the several groups in Part II.; they may now be drawn together into a short collective statement.

By a general consensus of opinion, the non-medullated monostele is recognised as the primitive stelar type, and it has been shown severally

in the case of Lycopodiales (p. 337), Equisetales (p. 391), Sphenophyllales (p. 418), Ophioglossales (p. 464), and Filicales (p. 646), how the stelar structure, however various, is uniformly referable in origin to the monostele: for it is seen in the young plant either to show a solid xylem-core, or a medullated state not far removed from that condition. The frequent occurrence of a like structure even in the mature axis of the early fossils has also been shown: and from such observations it becomes apparent how fully justified the opinion is that for the various types of the Pteridophytes the non-medullated monostele was the original vascular structure in the axis.

It will probably be objected that in many of the Pteridophytes the embryogeny does not bear this out; and that what is apparent, especially in the larger-leaved types, is that the vascular tissue of the shoot is initiated by a simple foliar strand, which descends from the first leaf continuously to the root, and in fact that the axial system is in its origin little more than a sympodium of leaf-traces. But before this objection is allowed to have weight the condition in the smaller-leaved forms must be taken into account, and the question examined as a whole rather than from one aspect only. A comparison of those Lycopods, which are held to be relatively primitive, shows that the cauline stele is initiated in the first stages of the embryonic development; this is seen with particular clearness in Fig. 190 C, D, E of *Selaginella spinulosa*, where the tissue formative of the stele can be recognised as extending up to the broad apex of the axis before any foliar strand is initiated. The same is the case in *Lycopodium Phlegmaria* (Fig. 185 C, D) and *L. annotinum*,¹ and it is indicated also in the imperfectly known embryology of *L. Selago* (Fig. 183). In these plants the vascular condition from the very first establishment of the embryonic shoot is the same as in the continued embryogeny (compare Fig. 172, p. 331): the stele is essentially cauline, and the foliar strands insert themselves upon its periphery. This appears to be the normal condition of small-leaved forms; according to our hypothesis these are themselves primitive, and the result of a comparison of the embryogeny in the two types would be that in larger-leaved forms the cotyledon bulks more largely at first; that the axis in the first instance is correlatively reduced in size, and the cauline vascular core is reduced with it. But, nevertheless, the examination of the embryogeny has shown with constancy that the axis is pre-existent to all the other parts of the embryo, though it may often be correlatively reduced, or its development deferred where the cotyledon or the root is precociously developed. The same view will hold also for the constituent tissues of the axis, including the cauline vascular core. The condition where this xylem-core is present is accordingly held to be the primitive state of the embryo, that where it is reduced and even absent is held as the secondary and derivative. But even in the latter cases, the stelar tissue asserts

¹ Bruchmann, *l.c.*, Pl. 4, Fig. 17.

itself as the individual shoot develops: so that the absence of it in the young embryo is only an apparent condition secondarily due to correlative reduction.

A protostelic state will functionally serve only a limited vegetative system. Starting from relatively small beginnings, as that system enlarges—either by continued growth of the axis and multiplication of small leaves, or by increase in size of a more limited number of larger leaves—the size of the stele becomes proportionally increased: and this may be seen to be the case either in the individual life, or it may be illustrated by comparison of different related species or genera. But there is a limit to the size which a solid protostele may attain with functional advantage, and as a matter of fact when large size is approached the protostelic character is sacrificed, and amplification begins, which may take several distinct forms. The simplest of these, as it is also the most general, is medullation. It is illustrated in many of the dendroid Lycopods. While certain of the early species of *Lepidodendron* have a solid protostele (*L. rhodumnense*), *Lepidodendron selaginoides* (Fig. 176, p. 336) has the centre of its stele composed of parenchyma and tracheides intermixed: others again, and especially later species, show a parenchymatous medulla (*L. Harcourtii*, Fig. 174), derived by conversion of the central region of the wood into pith (Fig. 175). The result of a similar change is seen in *Sigillaria*, but with a further progression to the breaking up of the ring of xylem surrounding the pith into separate strands (p. 337). This condition is very nearly approached in *Lepidostrobus Brownii* (Fig. 175), and finds an interesting parallel also in the upper part of the shoot in *Tmesipteris* (Fig. 234): in the latter a sclerotic tissue takes the place of the pith in the lower regions of the axis, but is replaced by thin-walled tissue above. Such cases prepare the way for the view of the stelar structure adopted above for *Equisetum* (pp. 386-392); the condition there seen appears to be the result of carrying the medullation of the stele to an extreme. Turning to the larger-leaved forms, the condition seen in the Ophioglossaceae (p. 459) may be referred in origin to a centroxylic protostele; it appears in fact as a medullated monostele with opening of the xylem at departure of the leaf-traces. Lastly, the series of Osmundaceous fossils described by Kidston and Gwynne-Vaughan (p. 539) shows most convincingly how their vascular structure is also referable in first instance to the medullation of a protostele, with ultimate breaking of continuity of the xylem-ring. It is thus seen that in a number of Pteridophytes, and probably along quite distinct phyletic lines, a progression may be traced from a primitive protostele to a state of medullation, and in some cases even to the disintegration of the remaining xylem-ring into distinct strands. This progression may even be followed in the successive stages of the individual life, which are accordingly held as further evidence of the phyletic story.

Another modification of the protostele, which probably has an importance in interrupting the continuity of an enlarging mass of xylem, is seen in

the modern Lycopods, but it is quite different in origin from medullation. Intrusive bands of phloem invade somewhat irregularly the central xylem, giving it sometimes the form of a fluted column, or of a series of plates connected at intervals, or of a continuous xylem-sponge (Fig. 171, p. 329). Such conditions, which are characteristic of modern Lycopods, are probably secondary derivatives of the simple protostele, since they are absent in the early fossils, as well as in the early condition of the plants that show them when adult.

A somewhat similar intrusion of tissues from without leads, in many Ferns, to the condition which is described as the solenostelic. But here it is regularly at the point just above the exit of the foliar strands from the stele that the intrusive tissues enter; it thus comes about that phloem and endodermis and ground parenchyma come to occupy continuously the centre of the stele, which accordingly takes the form of a hollow tube, with openings opposite each leaf-base (Figs. 95, 97, 100). This formation of a solenostele has probably occurred along more than one phyletic line, and it lies at the base of those complex types of dictyostelic structure of the stem seen in Leptosporangiate Ferns. These follow upon the overlapping of the foliar gaps, which results in dictyostely formerly described as a polystelic state (p. 190). A similar condition in some species of *Selaginella*, though phyletically quite distinct, shows interesting analogies; but its origin appears to be in relation to the departure of supplies to axes, not to leaves; these are, however, referable also by origin to a primitive monostelic structure.

Still further complications occur in certain Ferns which are associated with the formation of accessory vascular tracts; these arise in relation to the foliar gaps as described on pp. 568, 600, and lead to a doubling or even trebling of the solenostele (Figs. 319, 342), or accessory strands may arise in pith or cortex (Fig. 339). The condition of the modern Marattiaceae and of the fossil *Psaronius* may also be mentioned as extreme cases of complexity of vascular structure based probably on a scheme allied to those above noted (p. 525). Into these details it is not necessary to enter further here, they concern us chiefly as illustrating some of the extreme methods of amplification of the vascular system seen in the axes of Pteridophytes.

In some degree parallel with this progressive dilatation and disintegration of the stele goes also the disintegration of the foliar trace. In all the smaller-leaved, and in many of the larger-leaved forms, the leaf-trace consists of a single strand; in the Lycopodiales this is uniformly so, with exception of certain *Sigillarias* described by Kidston.¹ It is a single strand also in *Isoetes*,² and in the *Equisetales*. In the Sphenophyllales and Ophioglossales (except § *Ophioderma*, and perhaps § *Cheiroglossa*), the leaf-trace comes off always as a single strand, but branches frequently while still

¹ *Proc. Roy. Soc., Edin.*, vol. xxvii., part iii., p. 203.

² *Studies*, ii., Fig. 105.

within the cortex (*Cheirostrobilus*), giving sometimes a median bundle (*Ophioglossum*), sometimes a paired trace (*Botrychium*). All the more primitive types of Ferns, including the fossil *Psaronius*, have a single more or less horseshoe-shaped trace; but the modern Marattiaceae and the bulk of the Polypodiaceous Ferns have a trace composed of many strands: these are, however, arranged in series corresponding to the horseshoe outline of the undivided trace. The facts indicate with no possible uncertainty that there has been a disintegration of the leaf-trace by fission: it finds its origin in branching of the strands in an enlarged upper region of the leaf, and has been phyletically progressive from a region lying above towards the base. A comparison of Fig. 97 will make this clear: leaf-traces are there shown each of which consists at the base of a broad strap-shaped strand: this breaks up distally into numerous strands. But in *Cyathea*, which is structurally a more advanced type, the breaking up has been continued down to the base, and the leaf-trace comes off initially as numerous separate strands (Fig. 337). The same has probably happened in the modern Marattiaceae as compared with *Psaronius*; in most Mixtae as compared with the Gradatae (p. 648), and in the section *Ophioderma* as compared with *Euophioglossum* (p. 462). Thus in several distinct phyla it is shown that a progressive disintegration of the leaf-trace has been effective; and goes always with leaf-enlargement just as disintegration of the axial stele has followed on expansion of the axis. But in both cases the enlargement has phyletically preceded the consequent disintegration.¹

The present interest in these complex structures in axis and leaf-stalk does not lie in their detailed study, so much as in the fact that in all cases they appear only in the plant when advanced towards full development. In the young seedling a stelar structure, little removed from or, in most cases, actually showing a protostelic state, is constantly found; and from it the various steps may be traced to the more complex condition. So far as the development of the individual can be held to reflect the

¹ In certain Pteridosperms and Gymnosperms a double leaf-trace has been found to be prevalent, and it has been suggested that it finds its origin in the bifurcation of the leaf. Arguments based on the existence of a double leaf-trace have recently been extended to Flowering Plants (Miss Thomas, *New Phytologist*, 1907, p. 77). It is not proposed here to criticise those arguments, but merely to point out from the side of the Pteridophyta that there is no constant relation between foliar dichotomy and a double leaf-trace. In *Sigillaria*, Kidston (*Proc. R.S., Edin.*, vol. xxvii., p. 203) has shown that the double leaf-trace, already recognised by Renault, exists in a leaf of simple-form; on the other hand, the bifurcate sporophyll of *Tmesipteris* has only a simple leaf-trace. In the Ophioglossaceae, *Euophioglossum* and *Helminthostachys* have a simple leaf-trace, which soon branches, *Botrychium* has a double leaf-trace, *Ophioderma* a trace of several strands, not arranged in any binary scheme (*Ann. of Bot.*, xix., Pl. xv., Figs. 6-29). Lastly, in many primitive Ferns, where dichotomous and other branching of the leaf is prevalent, the leaf-trace is a single strand. Such facts suggest the propriety of extreme caution in applying arguments based on the vascular structure at the base of the leaf. It would seem not improbable that a double leaf-trace might appear in any broad flattened organ which is bilaterally symmetrical, whether branched or not. This may very well have been the case in *Sigillaria*.

evolution of the race, the evidence is quite clear: it indicates that the large-leaved forms, in which solenostelic or dictyostelic structure rules, originated from a smaller-leaved ancestry, with protostelic structure and a single strand of the leaf-trace. This is in full accord with probability, according to the antithetic theory of origin of the leafy sporophyte; for on that theory smaller-leaved would necessarily have preceded larger-leaved types.¹

Another mode of amplification of the stele, which often accompanies the first but is not necessarily associated with it, is by secondary thickening. The stem of *Sphenophyllum* (Fig. 217), and of *Lepidodendron Petticurensis*,² are examples of how a secondary development of vascular tissue may surround a solid protostele: this shows that medullation does not necessarily precede secondary thickening, but commonly the secondary thickening occurs where medullation is present: and indeed in some cases the two are in a sense complimentary, the secondary vascular tissue taking the place functionally of the primary tissue reduced by medullation; this is exemplified in the Calamarians (Fig. 225) and in *Sigillaria*,³ as also in some forms of *Stigmaria*,⁴ and it is seen with special clearness in *Lyginodendron*, *Poroxylon*, etc. In other types structurally more advanced, the secondary development may be held to have completely replaced the centripetal wood of the original stele.

The distribution of secondary vascular development among the Pteridophyta indicates clearly that it is a phyletic afterthought, originated in relation to the increasing size of the vegetative system consequent upon continued apical growth, repeated branching, and leaf-enlargement, either separate or in combination. Enlargement of the primary stele, with or without attendant medullation, may meet the demand in some degree; but it is a fixed and limited scheme compared with that of secondary thickening, which is capable of increasing the conducting tract in proportion to the demand. In some cases, however, it appears that a phyletic decrease of the secondary development has occurred, and it is probable that the feeble cambial activity in the nodes of *Equisetum*, and locally in the Psilotaceae may be vestigial remains of a more active increase in their predecessors, allied respectively to the ancient Calamarians and Sphenophylls.

¹This is, however, quite contrary to the opinions of Dr. Jeffrey, who holds that the large-leaved and small-leaved stocks were "separate back to the beginning of the period when the palaeontological record begins." This view would recognise no transition from the structure characteristic of the smaller-leaved forms (cladosiphonic) to that characteristic of the larger-leaved (phyllosiphonic). But, as a matter of fact, this can be demonstrated to have occurred in the individual life of Ferns, and probably it has occurred also in other forms in the passage from small-leaved youth to large-leaved maturity. It has been pointed out repeatedly in Part II. how cladosiphony is the anatomical expression of the dominance of axis, phyllosiphony that of the leaf in the shoot: and the balance may be altered in the individual life. (See Jeffrey, *Phil. Trans.*, 1902, vol. 195, p. 144.)

²Kidston, *Proc. Roy. Soc.*, Edin., 1906-7, p. 208.

³Scott, *Studies*, Figs. 77-78.

⁴*Ib.*, p. 234.

It is naturally the primary developments, however, which are of importance in the present comparisons: and sufficient has been said to show that the anatomical evidence, combined with that from embryology, has a very direct bearing on the theory of the strobilus. The uniform reference of the stelar structure to a protostele, and the actual existence of this structure in the young seedlings of the most diverse types, points clearly to its early existence in the race. Its continuity up to the apex of the axis in the more primitive of the living, small-leaved types is a further fact of importance: while the attachment of the foliar traces to the outer surface of the cauline core indicates not only the priority of the latter, but also the subsidiary character of the former. Lastly, the correlative reduction of the axis in the embryos of the larger-leaved forms, consequent on their precocious development of the first leaf accounts on well-known principles for their structure: it explains the fact that in them the evidence of early existence of the cauline core is not so prominent as it is in the smaller-leaved forms, which are on our hypothesis the nearer to an original type. The general conclusion from comparative study of the vascular skeleton, combined with the facts of embryogeny, will therefore be that it supports the priority of the axis over the leaf: it shows that the axis was from the first traversed by a conducting core, upon which the conducting strands of the leaves became attached. But that both the stele and the leaf-trace were susceptible of amplification and disintegration as a consequence of the enlargement of axis and leaf, and of the increasing proportional influence of the latter: in fact, the leaf in certain forms became at last the dominating feature of the shoot, and consequently its influence also controlled the internal vascular structure of the whole shoot. This condition, which is that characteristic of those forms which have been designated "phyllosiphonic," is believed to have been of secondary origin, and the structural progress shown in the individual life would appear to indicate with special clearness that it was so.

CHAPTER XLV.

THE SPORE-PRODUCING MEMBERS.

So far only the vegetative organs have been considered in this summary of results; the reason for this is that they appear the first in the individual life of Vascular Plants, and it is only after the vegetative system of the sporophyte has been established that spore-production supervenes. The relation of the sterile to the fertile region from the point of view of descent has, however, been discussed at length in Chapter XIII.: the conclusion was there reached that in vascular plants the sterile tract, which is prior in the individual life, is itself from the evolutionary point of view, the consequence of a secondary change, since the foliage leaves are themselves held to be sterilised sporophylls. In Chapter XIV. it was further concluded (p. 186) that there existed initially only one type of leaf—the sporophyll, and that even the protophylls are the result of their transformation. Moreover, justification for this is found in the positive fact that spore-production occurs very early in certain plants (Ophioglossaceae and some Lycopods), while in *Lygodium subalatum* the extreme condition was actually observed by Prantl, viz. that the primordial leaves are themselves fertile sporophylls. With these facts, and this general conclusion before us, we may now proceed to consider the morphology of the spore-producing members and their relation to the other parts of the shoot.

On an antithetic theory of origin of the sporophyte we contemplate an initial condition of a simple body having a coherent group of spore-mother-cells, provided, in fact, with a simple spore-sac. The Bryophytes, with their concrete archesporium, retain this state even in their more advanced forms; but the Vascular Plants, with their discrete sporangia, have diverged from it very widely. The two types of construction are not connected by any living intermediate links, nor is there any direct proof that the one type is phyletically related to the other. But both provide evidence suggestive of how a segregation of spore-mother-cells into distinct sporogenous masses, such as appear in the separate sporangia,

may have come about. In Chapter VII., which deals with sterilisation, examples have been brought forward showing how widespread is the conversion of individual cells, and even tracts of tissue from the fertile to the sterile state, and that in some cases septation of spore-sacs has actually been the result. It was concluded (p. 102) that plants show not uncommonly to-day such a conversion of cells from the propagative to the vegetative state as the antithetic theory would demand. Further, in Chapter VIII. (p. 112) it was shown that commonly the archesporium of Vascular Plants is not strictly circumscribed, but that the sporogenous groups have often ragged edges: this suggests on the basis of structure that each fertile tract is a residuum left by advancing sterilisation; in fact, the sporangia may in the simpler cases be regarded as islands of fertile tissue which have retained their spore-producing character. In Chapter XI. (p. 140), on the theory of the strobilus, it was shown how the disposition of the parts in some of the simplest Pteridophytes suggests as a prototype, prevalent though perhaps not general, an upright, radial, strobiloid structure, consisting of a predominant axis showing continued apical growth, and bearing relatively small and simple appendages formed from it by enation. Associated with these are sporangia each containing as its essential feature an island of fertile tissue. It is impossible to bring proof how a simple strobilus such as this actually originated: but it can be claimed that all the structural and developmental facts described in Part II. accord readily with a theory of origin by septation from a continuous spore-sac and enation of appendages. So also is physiological probability, for the sporangial types are better fitted for the mechanical protection, the nutrition, and the dispersal of the numerous spores than those with the non-septate sac: and in homosporous forms, which all the most primitive types were, the larger the number of germs the greater the probability of survival and of spread.

Passing, however, from such hypotheses, which are not susceptible of actual proof under present conditions, to matters of direct observation, a comparison of the fertile shoots of all the known homosporous Pteridophytes shows them to be composed of three constituent parts: (i) the *axis*, which the embryological comparison as well as the facts of development in the growing shoot have shown to be the pre-existing part; (ii) the *bracts* or *sporophylls*, which are appendages produced by outgrowth from the pre-existent axis; and (iii) the *spore-producing-members*, under which general term are included *sporangia* and *sporangiohores*, with their phyletic products. These may be inserted either on the axis or on the sporophyll. It is believed that (ii) and (iii), though they show commonly a local relation to one another, have actually been distinct organs throughout descent: neither has been the result of metamorphosis of the other. In further support of this it will be shown that they do not bear any obligatory relation one to another: either may exist without the other: while either may show fission independently of the other, though in some forms both are alike in this.

In point of the positions which they hold on the shoot the two types of spore-producing members, the sporangia and sporangiophores, show some degree of uniformity: in either case the insertion may be directly upon the axis or in the axil of the sporophyll, or they may be inserted further outwards upon the surface of the sporophyll. Leaving for the moment the Ferns on one side, illustrations may be taken from the strobiloid types. As regards the simple sporangia, these may originate from the axis quite apart from the subtending leaf, as in *Selaginella* (Fig. 360 A): in *Lycopodium* the sporangium arises from the upper surface of the leaf close to its base (Fig. 360 B, C); but in *Spencerites* it is borne at a point far removed from the leaf-base, though otherwise in accordance with the Lycopod-type (Fig. 360 D). Similarly with the sporangiophores, the insertion may be

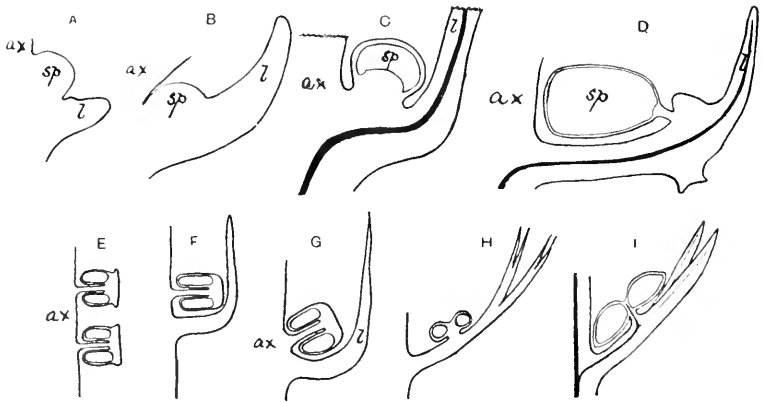

FIG. 360.

Diagrams illustrating the varying positions respectively of sporangia (upper row) and of sporangiophores (lower row). It is seen that a parallelism exists. For details see Text.

on the axis or on the sporophyll, but they show rather more latitude of detail: thus in *Equisetum* and in the ancient *Archaeocalamites* they are seated upon the axis, showing no association with bract-leaves (Fig. 360 E): or in *Calamostachys* whorls of bracts may intervene between the successive whorls of sporangiophores, but without individually subtending them (Fig. 360 F): or the sporangiophore may, possibly by a secondary displacement, be apparently axillary, as in *Palaeostachya* (Fig. 360 G): or, again, the sporangiophore may arise from the upper surface of a sporophyll, in which case it necessarily has a subtending position, as in the Psilotaceae (Fig. 360 I): a similar position is seen in *Sphenophyllum majus* (Fig. 360 H), but in other species of the genus there are more complex arrangements probably resulting from fission.¹ From such examples as these it appears

¹ Scott mentions a species (*S. emarginatum*) which appears to have borne its sporangiophores separately, so that they "have left their own distinct scars on the axis above the bractical node" (*Progressus*, i. p. 153). This arrangement closely approaches that of *Palaeostachya*, or of *Calamostachys*.

that the spore-producing members, whether sporangia or sporangiophores, have been susceptible of considerable differences of position in the radial plane, and that in this the sporangia show a parallelism with the sporangiophores which it is important to recognise in parts which are identical in their function.

The position of the leaves relatively to the spore-producing members in strobiloid forms is usually, but not constantly, a subtending one: there is reason to believe that a constant relation was a usual condition in primitive forms, while the exceptions may be held to be secondary in their origin. In the Lycopodiales the subtending relation of leaf to sporangium is

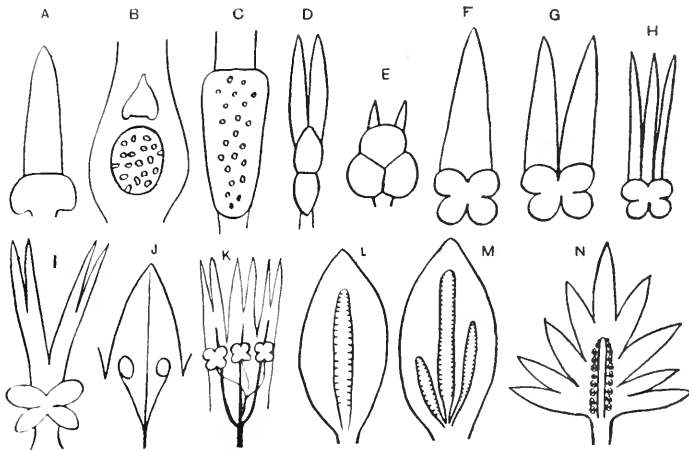

FIG. 361.

Diagrams illustrating the relation of spore-producing members and sporophylls or bracts, and the results of their respective fissions, as seen in surface view from the adaxial side. *A* = *Lycopodium*. *B* = *Isoetes*. *C* = *Lepidoströbus*. The dots in *B* and *C* show the trabeculae. *D* = *Tmesipteris*. *E* = *Psilotum*. *F* = *Palaeostachya*. *G* = *Calamostachys Binneyana*. *H* = *Calamostachys germanica*. *I* = *Sphenophyllum majus*. *J* = *Sphenophyllum Dawsoni*. *K* = *Cheiroströbus*. *L* = *Ophioglossum*. *M* = abnormal case of *Ophioglossum* (see Fig. 359 J, K). *N* = *Helminthostachys*.

constant (Fig. 361 A, B, C), as it is also in those of Sphenophyllales wherever there is a single sporangiophore to each bract-leaf (Fig. 361 D, E, I), but it is departed from in those cases where more than one is associated with each bract (*S. Dawsoni*, *Römeri*, p. 402, Fig. 361 J). The condition seen in *Cheiroströbus* strongly suggests chorisism of both bract and sporangiophore (Fig. 361 K), and their mode of insertion upon the bract-whorl in other species of *Sphenophyllum* above quoted indicates it as probable that some similar chorisism of the sporangiophores has been effective in them also (Fig. 361 J). In the Equisetales the relation is generally less exact: it seems still uncertain whether or not the sporangiophores were actually subtended by the bracts in *Palaeostachya* (Fig. 361 F):¹ in *Calamostachys* they may be somewhat irregularly subtended by

¹ See Hickling, *l.c.*, pp. 372, 377.

two (Fig. 361 G), or by three bract-leaves (Fig. 361 H): or in *Archaeocalamites* and *Equisetum* the sporangiophores may be borne quite independently of any bracts. It thus appears that the most usual condition is clearly that where the bract subtends the spore-producing member, whether sporangium or sporangiophore; but this arrangement is liable to be disturbed by chorisis of either bract or sporangiophore, or by the entire absence of the bract.

These presumable fissions, which comparison indicates as having occurred in both sterile and fertile parts, deserve attention: it appears that they may affect either class of parts separately or both together. In the simple condition of the Lycopodiales fissions of the appendages are very rare: but examples have been recorded where two sporangia appear side by side in *Lycopodium*,¹ and an occasional case of a bifid protophyll has been observed in the young plant of *Lycopodium* and of *Phylloglossum*:² but these characters have never become permanent for any race of Lycopods. In the Equisetales the result of fission is seen frequently in the bracts (Fig. 361 G, H), though not in the sporangiophores of the ancient types; but in the modern genus *Equisetum* fission of sporangiophores appears to have been effective. An examination of the very numerous sporangiophores of *Equisetum maximum* shows frequent cohesion of their stalks, while a comparison of the simpler species, such as *E. palustre* and of the Calamarians, leaves little doubt that with enlargement fission of the appendages has occurred (Fig. 195). Forking is a marked feature of the leaves in the Sphenophyllales (Fig. 361 I), but not necessarily accompanied by fission of the sporangiophore. In some forms, but not in all, there is, however, such a collocation of the sporangiophores, in number and position as well as in vascular connection, as would indicate that an increase by fission has occurred to produce them: but this may occur independently of any fission of the bract (Fig. 361 J). In the very complex cone of *Cheirostrobus* it is highly probable that fission has been effective in both parts, as the vascular connections appear to indicate (Fig. 361 K). Lastly, the branching of leaf and spike, described at length for the Ophioglossaceae (pp. 435-439), can best be understood as the consequence of similar progressive fissions (Fig. 361 L, M, N). It thus appears that fission has probably been a frequent feature in producing the condition of the appendages in the strobili actually observed in the more complex sporangiophoric types, and that such fission may occur independently in either sporophylls or spore-producing members, or coincidentally in both. On the other hand, the condition usual in the Lycopods may be regarded as a type which has remained on the simpler basis without fission.³

¹ *Annals of Botany*, vol. xvii., p. 278.

² Treub, *Ann. Jard. Buit.*, vol. viii., taf. v., fig. 2 A.

³ By the term "fission," as here used, is to be understood a chorisis which dates from the initiation of the primordium: the fission is not a branching of a part which is

The recognition of the spore-producing members as a category of parts, probably distinct in origin from the bracts, though often supported on them, having a uniform function, and showing, whether as simple sporangia or as sporangiophores, similarities of position, raises the question whether the two types of spore-producing members are genetically connected; it is necessary to enquire whether there is any structural indication of an evolutionary progression having taken place from the simple sporangial sac to a septate state, and thus of the origination of the stalked sporangiophore with vascular supply from the single sporangium. In the first instance it is to be recognised that such a progression cannot rightly be negatived on *à priori* grounds: for it has been shown that septation of sporangia has occurred in well-authenticated cases (p. 120), while biological probability would favour such amplification in homosporous forms (p. 111). The structural evidence showing that septation has taken place may be derived both from the septate and from the non-septate forms, but no consecutive demonstration is to be obtained from comparison of the representatives of any one phylum. On the one hand the occurrence of sterile cells and tissue-tracts has been described at length in simple sporangia, and it is specially worthy of note that it is in the largest of them (*Isoetes*, p. 318, *Lepidostrobus*, p. 323) that the nearest approach to a septate state is found: in the megasporangium of *Isoetes* the sporangium is technically septate, for each spore-mother-cell may be completely partitioned off by tracts of sterile tissue (Fig. 320). Such a condition, which only appears relatively late in the individual development of *Isoetes*, is comparable with that of a young synangium of *Equisetum* or of *Kaulfussia*,¹ inasmuch as in these also the archesporial cells are found isolated in sterile tissue (Fig. 206 A): the fact that the condition of isolation is seen earlier in the individual development of these sporangiophores is in complete accord with their greater morphological advance: a less advanced state is, however, seen in *Tmesipteris* (Fig. 230 B), in which the septum and sporogenous groups are at first indistinguishable from one another, but differentiate after the tissue has attained a considerable bulk. If the individual development be rightly held as an indication of the evolutionary progression in the race, then the sporangiophore in the cases quoted would find its evolutionary prototype in larger non-septate sporangia, such as those seen in the Lycopods, from which the condition in *Tmesipteris* would be less far advanced than that of *Equisetum* or of *Kaulfussia*. Such a comparison comes with special force in those cases where, as in the Psilotaceae and Sphenophylls, the position of the sporangiophore is identical with that of the Lycopod sporangium.

already existent in the individual, but the substitution of two related centres of initiation in place of one, while their near proximity may lead to a more or less common upgrowth with consequent cohesion at the base.

¹*Studies*, iii. pl. viii., and Fig. 37.

But the objection may be raised that the vascular supply has also to be accounted for. It is a general experience in the plant-body that vascular development follows demand: and many examples might be quoted both from vegetative and propagative organs. It appears that similarly a vascular supply extended into the syngangium; a first indication of such a development is seen occasionally in the sporangia of *Lycopodium* (Fig. 161), while it is a common feature in the megasporangia of Seed-Plants. Thus any objection to a theory of origin of the sporangiophore by a process of septation and outgrowth on the ground of the presence of vascular tissue does not appear to be valid. Moreover, such vascular extension is seen in less full development in those sporangiophores where the sporangia are obliquely erect and syngangial, as in the Psilotaceae, *Kaulfussia*, and *Ptychocarpus* (Fig. 288), but further developed where they are inverted and separate, as in the Equisetales. It has already been argued that the former are the less advanced, and those with separate and inverted sporangia the more advanced types (pp. 426-7).

It is thus seen that there is coincidence between sporangia and sporangiophores in their leading function of spore-production: that there is commonly a similarity of position of the two: that either may undergo fission independently of the subtending bract, that in certain sporangia there are indications of partial septation, and occasionally a technically complete septation: also that the facts of development of the syngangial sporangiophores harmonise in varying degree with a theory of origin from a non-septate sporangial sac. The conclusion therefore seems justified that they are essentially comparable parts, the one being the simpler, the other the more complex terms of a category of phyletically uniform organs.¹ That the non-septate sporangium was the more primitive there can be little doubt. So far as palaeontological evidence bears upon the question, Lycopodinous types with their non-septate sporangia appear to have been fully as early as any of the more elaborate forms.

Turning now to the Ferns, which had been temporarily put aside while discussing the strobiloid types. It has been accepted as probable that the soral condition was the original state in Ferns, and the non-soral derivative (p. 633), while it was left an open question whether the sori were originally marginal or superficial in their position upon the sporophyll (p. 634). It has also been pointed out how close the structural similarity is between certain syngangial sori and the sporangiophores of the smaller-leaved types (pp. 151, 524). It may have been the fact that this striking similarity was a result of parallel development, but still it would appear probable that the evolutionary progressions which produced them were of a like kind. There is ample evidence also of fission of sori in Ferns (pp. 511, 555, 620), essentially like that of the sporangiophores of the strobiloid types. It would therefore appear probable that the condition

¹The designation of sporangiophores as ventral or other lobes of the sporophyll has been objected to on a previous page, and reasons given for its rejection (p. 426).

seen in Ferns is similar in kind to that of strobiloid types, but modified in accordance with the great amplification of the sporophyll, with its continued apical growth and often profuse branching: this was accompanied by increase in number of the sporangiophores (sori), fission being one prominent source of that increase, and also by a tendency for the sorus to diffuse itself as scattered sporangia over the enlarged surface, producing thus the non-soral state as a secondary condition: moreover, the position of the sori shows frequent tendency towards the lower leaf-surface. From this point of view the Fern-type does not stand apart from the rest in the essentials of its morphology, but only in the fact that it has proceeded to a larger-leaved state, and that this has brought with it secondary changes of the spore-producing members.

There is a considerable bulk of evidence to show that, apart from fissions, the sorus or sporangiophore has also been capable of extension in the course of descent: this is to be found in certain points of structure which have not been satisfactorily accounted for on any other footing. It has been noted that in the fossil Equisetales the number of sporangia on each sporangiophore is commonly four (p. 425), but that modern Equiseta have usually more. In the Psilotaceae and Sphenophylleae the number may be from one to six, the lowest number being probably in some cases due to reduction: thus fluctuating numbers are a common feature in the simpler types. In the Ophioglossaceae the fluctuations are within wider limits, and the larger numbers of sporangia are associated with an apical growth of the sporangiophore, which is either of very short duration or entirely absent in other cases. The result is in *Ophioglossum* the elongated spike, with its lateral rows of sporangia partitioned sometimes imperfectly from one another (Fig. 361 L). The structure bespeaks a progressive condition in which septation has played a leading part (p. 404). In *Botrychium*, profuse branching parallel to that of the sterile leaf, occurred, and it is very closely related with septation of the individually projecting sporangia (p. 454); lastly, in *Helminthostachys* the rows of sporangia of *Ophioglossum* are replaced by dense ranks of sporangiophores (pp. 455, 485), and their origin is believed to have been virtually a repetition of that process of septation and upgrowth above recognised in the origin of the sporangiophore from a simple sporangium (Fig. 361 N). All these amplifications of the sporangiophore are consistent with physiological probability, as shown in Chapter XXXI.

In the Ferns also similar extension of the sporangiophore (or sorus) is seen, but it has taken a different form in accordance with the expansion of the leaf-surface to which it remains attached. It is exemplified in the simplest form in the Marattiaceae, in which the structural condition of *Danaea* seems plainly to be the result of elongation and progressive septation of a sorus of the same type as that of *Marattia* (Fig. 278 C, E); the partial septations are themselves specially convincing evidence of how the highly septate state has been acquired (p. 518). The progression has

been similar to, though phyletically quite independent of, that in *Ophioglossum*; and the results are, in the former an elongated sorus attached to the leaf-surface, in the latter an elongated sporangiophore which is attached to the sporophyll only at its base. In many other Ferns there is evidence of amplification of the sori, whether by intercalary elongation of the receptacle and a basipetal succession of sporangia, as in the Gradatae, or by marginal extension, as in the *Lindsaya-Pteris* series, or by superficial spread so as to produce the conditions seen in *Gymnogramme*, *Acrostichum*, or *Platyserium*: associated with these is the profuse interpolation of new sporangia characteristic of the Mixtae. It is thus possible to picture how even the most complex and divergent types of spore-production in large-leaved forms may be referred back in their ultimate origin to elementary types, and to recognise how they conform to that general scheme of construction which obtains among the simpler strobiloid Pteridophytes.

It remains to consider the distribution of the spore-producing members on the plant as a whole. We have recognised the shoot or primitive strobilus as composed of (i) axis, (ii) leaves or bracts, and (iii) spore-producing members. It has also been seen to be probable that originally all the leaves were sporophylls. The primitive shoot appears to have been a general-purposes shoot, in which vegetative and propagative regions were not segregated. But it is evident that two other conditions are possible, that is a shoot bearing (ii) alone, and one bearing (iii) alone; both of these states are known in living forms, and both may be held to be secondary and derivative.

The former case, where leaves without spore-producing members are present, is by far the commoner condition of the two, and it appears in the early stage of the ontogeny in almost all Vascular Plants. But it also appears in successive intermediate zones higher up in various plants, and notably in *Lycopodium Selago*, from which it is called the "Selago" condition (Frontispiece) (Chapter XIII.). It has been shown that this condition would result from abortion of the spore-producing members, and the fact that this has taken place is clearly indicated by the occurrence of imperfect sporangia about the limits of the region which has remained fertile (p. 162). The converse evidence, that in certain cases (*L. Selago*, *Botrychium*, and *Ophioglossum*) the spore-producing members appear very early in the individual life, and that in *Lygodium subulatum* the very first leaf may be fertile, further strengthens the view that the whole plant was originally fertile (p. 186), and that the sterile regions, whether basal or intermediate, are so by abortion of the spore-producing members.

The second case above mentioned, in which spore-producing members are present but no leaves, is less common; it is seen in *Archaeocalamites* and in the modern *Equisetum*. It has been argued at length above (pp. 382-4, and p. 429) that the leaves and sporangiophores in these plants are parts of distinct nature and origin, and that the condition of their strobili is due to abortion of the leaves, of which in *Equisetum* the

annulus is the last representative. A somewhat similar condition appears in *Ophioglossum simplex*, where the spike is present, but the subtending leaf absent (p. 441); in both cases the structure seen appears to be based upon the persistence of the sporangiophore, while the leaf is abortive—in fact, the converse of the process which brings the “Selago” condition into existence.

There remain, however, certain instances where the distinction between the leaf and the spore-producing members appears to break down, and middle forms appear with the characters of leaves bearing sporangia; the annulus of *Equisetum* sometimes bears sporangia, grouped as upon malformed sporangiophores (p. 382); or sporangia may appear upon the sterile leaf of *Botrychium* (Fig. 242, p. 443); or, as in *Sphenophyllum fertile* (p. 404), the bract bears sporangia as well as the sporangiophore which it subtends. I do not think that these occasional exceptions suffice to prove that leaves and sporangiophores belong to the same category of parts, any more than the substitution of a foliage leaf for an ovule, in certain well-known cases, proves that the ovule is really an organ of the same category as the leaf. What they really appear to show is, that in certain cases a primordium is not always of clearly defined character at its initiation, and consequently that the characters pertaining to members of distinct category may occasionally be intermingled. Accordingly, notwithstanding the exceptions quoted, the distinction of leaves and sporangiophores may be upheld for the early forms of Pteridophytes.

It thus appears that the whole plant-body, as seen in the simpler Vascular Plants, is referable to the simple shoot or strobilus, of radial construction, as a unit; that it consisted, in its most primitive form, of an unbranched axis, simple leaves, and unilocular spore-producing members, all of which were distinct in their character and in their phyletic origin, and none the result of metamorphosis of another part; that the whole plant-body of the known Pteridophytes may be regarded as derived from some such simple source, by continued apical growth, and terminal and adventitious branching of the axis, and by branchings and fissions of the appendages; by adoption of a dorsiventral in place of the primitive radial habit; by abortion of certain of the spore-producing members, which differentiated the sterile regions from those which remained fertile; and in these sometimes by abortion of the leaves themselves, thus leaving the spore-producing members as the sole appendages. Such an origin is fully in accord with the details of individual development; for the ontogeny often demonstrates those very progressions from the simpler to the most complex state which the phyletic development of the more elaborate forms from so simple a source would require.

Combining the results which thus follow from the detailed examination of Vascular Plants with the conclusions from comparison of the Bryophytes, there appears to be very strong support for our general theory of origin of the sporophyte, as the essential constituent of the Flora of the

Land. The theory presupposes in the first instance post-sexual complications involving reduction: by deferring that event through sterilisation of individual cells, a neutral cell-group is established: this shows continued growth, and further progressive sterilisation as it is seen exemplified in the Bryophytes, and leading to their complete state with a vegetative system of considerable extent and a concrete fertile tissue. Such sterilisation of individual cells or cell-groups is also seen among Vascular Plants, and has been in them a source of vegetative increase. But in them, with their discrete sporangia another, and a more effective factor arises, viz., the abortion of whole sporangia and sporangiophores. This leads in a more rapid and wholesale fashion towards the same end, viz., the establishment of a vegetative system, by separation of the function of nutrition from that of propagation in a shoot primitively constructed to serve both purposes. Such an early state is seen in every plant which shows the "Selago" condition: it has been shown above that this exists in more or less obvious form among the representatives of all the main phyla of Vascular Plants: and that it figures among their early fossil forms. There is less certainty about the earlier steps of origin of the sporophyte in the poly-sporangiate type, and analogy with the Bryophytes has to serve in place of more direct observation. But the later steps, by abortion of spore-producing parts, are more secure, even though the observations are frequently of the negative fact established by comparison, viz., that certain parts are not present, having been completely obliterated, so that not even a vestige remains to show what has happened.

In the nature of things this theory of the origin of the sporophyte, and of its establishment as the leading factor in the Flora of the Land, is not susceptible of direct or full proof under present conditions. But it offers a coherent account of how the sporophyte may have arisen: it is based on a wide comparative study of known forms from the point of view of their individual development, their external morphology, their anatomy, spore-producing members, and embryology: it does not assume wide-spread reduction, nor does it postulate any imaginary types, but proceeds by comparison of those forms of which there is evidence actually existing either in the living or the fossil state. On these grounds the theory is put forward with some degree of confidence, though in the full knowledge that it has not been, and indeed that it cannot be, proved.

CHAPTER XLVI.

HETEROSPORY AND THE SEED-HABIT.

THE theme of this book has been the origin of a Land-Flora, not the examination of its ultimate developments: and accordingly the detailed study has related to the homosporous Archegoniatae, with only occasional allusion to those which are heterosporous, and hardly any to the Seed-bearing Plants. The reason for this lies in the high degree of certainty that the homosporous state was the pre-existent, and the heterosporous the derivative condition from it: any study of origins will therefore relate primarily to the former. But the upward evolution of Vascular Plants has been intimately connected with the differentiation of the spores according to sex, and the establishment of the Seed-Habit, changes which have brought with them biological advantages conducing to increased precision in the establishment of new individuals. The earlier step was the introduction of heterospory, which results only in minor reflex effects on the parent: the later adoption of the Seed-Habit has in certain cases been followed by a profound modification not only of the immediate spore-producing members themselves, but also of the parts which bear them. It will be necessary then to compare the condition of homosporous, heterosporous, and Seed-Bearing Plants, especially with respect to questions of amplification and reduction, such as have been treated of in Chapter XIX. It was there concluded (p. 241) that the production of the largest number of effective germs was the end of all development of the sporophyte: that any increase in their number involves amplification not only of the propagative system but also of the nutritive: and consequently, other things being equal, there is a probability that homosporous plants as a whole should illustrate lines of amplification rather than lines of reduction. While admitting that reduction may occur in homosporous forms, the homosporous types have for the most part been recognised as constituting natural series of ascending complexity.

The innovation of heterospory does not appear to have brought with it any general reduction of parts, but changes rather of the contents

themselves of the sporangia. It is well known to have been initiated along several distinct phyletic lines: well-ascertained cases are seen in the ligulate Lycopods (Figs. 23, 24; 165, 166; and 170), in the Calamarians (Fig. 210), and in the Hydropterideae, while it is quite possible that the heterospory which preceded Seed-formation in the Pteridosperms may also have been independently initiated. The innovation is closely connected with the sacrifice of a proportion of the potential germs for the better nutrition of the rest: this has already been seen to occur in various homosporous types such as the Psilotaceae (p. 417), and *Equisetum* (p. 380), though the spores produced in these plants show no differentiation in size, or apparently of sex. The condition seen in *Calamostachys Casheana* (p. 381) is but little removed from this: here, however, heterospory is clearly present, but not far advanced from that homosporous state where sacrifices for nutritive purposes are seen: the megaspores appear relatively small and numerous, as they are also in some of the heterosporous Lycopods, such as *Lycopodites Suissei*, with 16 to 24 in each sporangium. In *Selaginella* itself the number of the megaspores is smaller, and may vary from 8 in *S. apus*, through the common number of 4, to sometimes a single one, as in *S. rupestris*. The latter condition is found also in the Hydropterideae, and it is the state which is commonly seen in all the higher Seed-Plants. The facts indicate with no possible uncertainty that a progressive reduction in number of the spores, which prove on germination to be female, has taken place, till finally a single, large, well-nourished spore is the sole product of each megasporangium.

Such changes, however effective they may be in the successful establishment of the new individual, through the concentration of the nutritive store conveyed from the parent plant in a few enlarged megaspores, or in only a single one, are nevertheless intra-sporangial: they rarely affect other parts. It is true that in *Azolla* abortive primordia of microsporangia accompany the megasporangium, as though their correlative diminution followed on the great enlargement of the megasporangium; but this case is exceptional among heterosporous plants, and thus it is seen that the introduction of heterospory does not necessarily bring far-reaching effects, but involves a readjustment of the available nutritive material within the single sporangium, and its concentration round few centres, or only a single one, in place of many.

It is different, however, with the other, and much more effective innovation, viz., the Seed-Habit. This also was initiated along more than one line of descent, though it may still be a matter of doubt whether it became permanently effective in more than one distinct phylum. It will suffice here to quote the cases of incipient seed-like habit of the Lycopodiales, seen in *Lepidocarpon Lomaxi*, and in *Miadesmia*, in which the megasporangium, with its single megaspore retained within it, is covered in by an integument, leaving a micropylar slit or pore: the whole structure, together with the sporophyll to which it is related after the

type of the sporangia of other Lycopodiales, falls away, but the details of fertilisation and of embryogeny which follow are still unknown.¹ The nearest approach to a seed-like habit among the living Lycopods is seen in *Selaginella apus* and *rufestris*.² Here fertilisation occurs while the spores are unshed, and the sporangia still attached to the strobilus: in *S. rufestris* the connection is maintained with the parent plant until the embryo has produced cotyledons and a root. Thus the Lycopodiales, both fossil and modern, show approaches to a seed-habit, though it is doubtful whether that habit was ever firmly established among them, or persists in the form of any of the Seed-Plants of the present day.³ The condition now so fully demonstrated for the Pteridosperms shows that a Seed-Habit was definitely acquired along another quite distinct phyletic line.⁴ These large-leaved types, bearing their large seeds of Cycad-like character distributed on fronds effective also for assimilating purposes, probably sprang from the same stock as the Ferns, and it is especially with the Botryopterideae and the Osmundaceae that they show the nearest analogies. Thus the Seed-Habit appears to have been initiated certainly in two distinct phyla, and it is not improbable that it may have been repeatedly initiated within either or both of them.

The establishment of a Seed-Habit does not necessarily bring immediate reduction of the supporting system in its train: but it has frequently happened that such reduction follows. The fact that the large seeds of *Neuropteris heterophylla* are borne on a rachis bearing characteristic vegetative pinnae shows that a correlative reduction is not obligatory. But on the other hand, a reduced state of the sporophylls does usually accompany the seed-habit: in *Lyginodendron* the female fructification is described as being borne on the rachis of fertile fronds which differed from the sterile foliage in the reduced leaf-area: and this applies also in some degree to the male sporophylls as well. From such minor degree of reduction of the megasporophyll to that condition seen in *Cycas* is no great step, and from this the sequence through the Cycads gives very convincing evidence of further reduction.⁵ It seems not improbable that in *Cycadoidea* a still further step in reduction has been taken, so that while many of the sporophylls appear as minute sterile scales, those which are fertile exist merely as radio-symmetric pedicels, each bearing a single terminal ovule.⁶ The microsporophylls show a series of reductions in less prominent degree, but without any strict parallelism with the megasporophylls: thus in *Cycadoidea* where the

¹ See Scott, *Progressus Rei Bot.*, i., p. 171.

² Miss F. Lyon, *Bot. Gaz.*, vol. xxxii., pp. 182-3.

³ See Seward and Ford, "The Araucariaceae, Recent and Extinct," *Phil. Trans.*, Series B, vol. 198, p. 305, etc.

⁴ See Scott, *Progressus Rei Bot.*, i., pp. 190-212, where the literature is quoted.

⁵ Engler and Prantl, *Nat. Pflanzen.*, II. i., Fig. 7.

⁶ This is the opinion of Wieland, *American Fossil Cycads*, p. 230, etc.

megasporophylls are the simplest of all, the microsporophylls are still of considerable size, while those of the modern Cycads are much smaller, though their megasporophylls show less extreme reduction. Such comparisons appear to indicate with unmistakable clearness that in the course of descent a reduction of sporophylls has followed upon the establishment of the Seed-Habit, but that it came gradually, and is not to be held as a simple or direct example of correlation.

The essential point in the Seed-Habit is the retention of the megaspore within the tissues of the parent plant till after fertilisation: on this has followed, in the first place, the ultimate achievement of a higher degree of independence as regards fertilisation; and secondly, the opportunity of continued nutrition of the embryo by the parent plant up to an advanced age. Both of these are important steps in the establishment of a Land-Flora, and must be briefly considered. Taking first the question of method of fertilisation, it may be remarked that the differentiation of sex as evidenced in heterospory is in itself no point of adaptation to a land-habit: while it brings an advantage in the superior nutrition of the female spore, it imposes a fresh difficulty in fertilisation, viz., the necessity during germination of a near juxtaposition of the microspores and megaspores, bodies which have a distinct source of origin: the more distinct the origin in space, and in time of production, the larger will be the number of microspores requisite to ensure a reasonable probability of fertilisation. As a matter of observation the number of microspores in the Pteridophytes is habitually maintained according to the plan of the original homosporous sporangium, and it may be in Seed-Plants also, so long as their distribution is by no specialised method, and so long as juxtaposition with megaspores is only a matter of chance. This is exemplified in the Pteridosperms and in *Cycadeoidea*, and in less complete degree in the Cycads. But in the higher forms of Seed-Plants the specialised methods of transfer of microspores, and especially those by animal agency, have led to economy, so that a reasonable certainty of fertilisation is secured with a smaller output of microspores. This theme may be so fully illustrated by well-known examples from the Flowering Plants that it requires no further explanation here. But as against the difficulty of securing juxtaposition of the megaspores and microspores during germination may be set the adoption of siphonogamy, which followed ultimately upon the Seed-Habit. A precision previously unknown was thus introduced into the act of fertilisation, so that once juxtaposition of spores was secured, fertilisation followed with a high degree of certainty. This reduced and finally abolished the motile stage, and so removed the critical process of fertilisation from its primitive dependence on the presence of external fluid water. The adoption of siphonogamy was the last adaptive step of prime importance in the establishment of a Land Flora upon a permanent basis of suitability to external circumstance: and the high degree of certainty of the resulting fertilisation still further favoured economy of pollen-production.

A second consequence of the adoption of the Seed-Habit was the continued nutrition of the embryo by the parent plant: not only was accurate fertilisation secured, but the embryo was far advanced in its development, and supplied with a large nutritive store before being isolated, and becoming dependent on its own resources. This, together with the mechanical protection of the seed-coat, brings a highly increased certainty of establishment of each germ as a new individual. Economy will again follow on the increased chance of success of each individual germ, and the general tendency of these precise and certain arrangements must have been in the direction of reduction: evidence of this is to be recognised generally in the floral construction of Seed-Plants. Amid all the fluctuations of detail of the floral mechanisms they show, as compared with the Pteridosperms or Cycadales, evident traces of that reduction which the adoption of the Seed-Habit would on biological grounds lead us to expect.

The higher terms of the series of Vascular Plants show more exact differentiation of the vegetative and reproductive systems than the lower. Each appears to have taken independently its own line of specialisation. But there is good reason to hold these advances as mere changes of detail in a plan substantially the same, however important may be the biological effects thus gained. The general plan of the shoot of Flowering Plants, whether vegetative or propagative, and the characters of its several parts remain the same as in the more primitive Vascular Plants, though subject to an infinity of modifications; and the conclusion which is forced upon the mind in contemplating the construction of Vascular Plants at large is, the unity of the general scheme underlying them all. It is based, as we have seen, on the individual shoot, consisting of an apically-growing axis with appendages borne in acropetal succession, and accessory roots. The general-purpose shoot, as seen in its essentials in the earliest homosporous Pteridophytes, is the pattern: from this, by segregation of the vegetative and propagative regions, and subsequently by their independent specialisation, even the highest terms of the Flora of the Land may be held to have been derived. And in the course of this evolution there is evidence of two main progressions as regards the size of the appendages, and their propagative capacity. In the first and more primitive phase, which was characterised by being homosporous, there are comparative reasons which have been explained at length above for recognising a very general amplification, though subject in special cases to reduction. This is in accordance with the obvious biological advantage in homosporous forms of producing as large a spore-output as possible. It involved in some cases profuse branching of the shoot, while the individual appendages remained small, as in the microphyllous Lycopodiales. In other cases the axis was not greatly extended, nor the appendages numerous, but the latter made up for these deficiencies by their extensive individual growth and ramification. This is exemplified in the megaphyllous Ophioglossales and Filicales, while the sporangiophoric Pteridophytes take an intermediate place. Thus

in various ways, though probably from somewhat similar beginnings, the various primitive homosporous phyla may be held to have worked out the line of biological advantage which follows on direct increase of numerical output of spores. This may be regarded as the upward limb of a curve of morphological complexity.

But with heterospory and especially with the Seed-Habit and more precise methods of fertilisation following on siphonogamy, the line of biological advantage was diverted from mere numerical increase of germs to their individual nurture, with, as a consequence, a higher degree of certainty of their final establishment in life. This brought in various ways reduction as against the previous amplification. The most conclusive evidence of this is to be found in the sequence from the Ferns, and Fern-like Pteridosperms, through the Cycads. It seems impossible to see in these any other story than one of simplification of appendages following on increased precision of propagative method; it may be represented as the downward limb of a curve of morphological complexity. It is not at present possible to indicate any other phyletic lines with the same degree of certainty as this; but the condition of the floral construction in other Gymnosperms, and in the Angiosperms themselves is certainly such as to harmonise with an origin in which reduction has played a prominent part.¹ The biological probability that such an homosporous amplification should be succeeded by a reduction following on the adoption of a Seed-Habit is in full accord with the evolutionary course which the facts themselves appear to indicate.

¹ I leave entirely open the question of phyletic origin of certain Gymnosperms from the Lycopodiales. If that were their true origin the reduction would in that case be in restriction of the number of sporophylls and sporangia rather than in size of the sporophylls themselves: in fact a reversal of their homosporous amplification, analogous to but not coincident with that of the larger-leaved Filicales, Pteridosperms, and Cycads.

CHAPTER XLVII.

RESULTS, PHYLETIC AND MORPHOLOGICAL.

It remains to state the chief phyletic and morphological conclusions which may be based upon the facts and the reasoning contained in what has gone before. They are derived primarily from the sporophyte generation, and the reason for this is that it supplies the most distinctive features. Nevertheless, the characters of the gametophyte have not been ignored. The method adopted, wherever it is possible, has been to start from the detailed comparison of forms within a near circle of affinity: to lay these out in short series which there is reason to believe were progressive, and then to compare the more primitive types of each with a view to gaining some idea of a prevalent original type for the whole group, or phylum. A comparison may then follow of the original types of different groups or phyla, with a view to the recognition of characters which are common in them: and so a conception may be formed of some of those general features which ruled in the remote ancestry, and even in the early foundation of the distinctive Flora of the Land, as expressed in the rise of the sporophyte generation.

It has already been seen that no definite Algal form now living can be held to have been a direct progenitor of any known Archegoniate type. *Certain Algae suggest in their post-sexual phase how the initiation of a sporophyte may have occurred, but there is no sufficient reason to hold them as being in the actual line of descent of Archegoniate forms.* The probable relation of the Bryophytes to the Pteridophytes is somewhat similar: for though the comparison of their sporogonia with the sporophytes of the Vascular Plants shows many points of similarity, still it cannot be held that there is sufficient evidence to assume a phyletic relation between the non-vascular and the vascular Archegoniates. *Both Mosses and Liverworts may with probability be held to be blind branches of descent, which illustrate nevertheless phyletic progressions that illuminate the origin of sterile tissues from those potentially fertile, and the establishment of a self-nourishing system in the sporophyte.* With these few words the Algae and

Bryophyta may be dismissed as side issues, and the special phyletic interest will centre round the vascular Archegoniatae, as the forerunners of all the higher vegetation of the Land.

The method above described may be first applied in the case of the GAMETOPHYTE of the homosporous forms of Pteridophytes. A comparison of the prothalli of various species of *Lycopodium* (pp. 340-345) points towards a massive body, probably exposed above ground and capable of assimilation, with its sexual organs sunk in the massive thallus: the form seen in *L. Selago* is held to be not far removed from the original type. Probably the filamentous condition seen in *L. Phlegmaria* is a specially attenuated development in accordance with saprophytic habit, while the colourless condition of the underground prothalli, where dependence is entirely upon saprophytic nutrition, can hardly have been anything else than secondary. The same opinion applies also for the prothalli of the Ophioglossaceae as regards their colour, and the deeply sunken sexual organs (p. 465), while their massive construction compares with that usual in *Lycopodium*. The female prothallus of *Equisetum* is of essentially a similar type, but it shows less massive structure, especially in the upward-growing lobes, which are not unlike those of *L. cernuum*. The male prothallus is, however, of a simpler type: the antheridia are sunk as before, but the archegonial neck projects, as it does also in some species of *Lycopodium*. Turning to the Ferns, the delicate prothallus of the Leptosporangiates, and especially the simple filamentous forms of the Hymenophyllaceae, suggests at first sight that they are of an essentially different type from the more massive forms previously considered. But comparison within the Fern-phyllum shows that the prothallus of the most ancient living type, the Marattiaceae, is more massive in construction: and in the Osmundaceae the same is seen, though in less degree. These facts strongly suggest that the Fern-phyllum has undergone a progressive simplification of the prothallus, and indicate an origin like the rest from a massive source. The sexual organs also are deeply sunk in the Eusporangiate types, but show a successively more projecting position in the Leptosporangiates, just as their sporangia also project more than in Eusporangiate Ferns. Thus the propagative organs of the two generations march parallel in respect of their relation to the surface of the part which bears them. *It may accordingly be concluded as probable that the prothallus of early Pteridophytes at large was a relatively massive green structure, with deeply sunk sexual organs.*

Turning now to the comparison of the SPOROPHYTE, the phylum of the Lycopodiales, in which it is of the simplest construction among the Pteridophyta, is certainly as ancient as any of the rest: the two constituent series, the Ligulate and the Eligulate, illustrate parallel progressions, but their similarity of plan shows that they are closely allied. On the basis of comparison of the known forms a primitive type of Eligulate Lycopod has been sketched out, and it is nearly approached by what is actually

seen living in *L. Selago* (see frontispiece, also p. 363): perhaps it may ultimately be found to be even better represented by some others of the thirty-eight less fully known species of the *Selago*-Section of the genus. The undifferentiated "*Selago*" condition, which is seen in them, is no recent characteristic, for it appears also in certain Palaeozoic Lycopods: from this state the various living forms illustrate the achievement of a more clear segregation of sterile and fertile tracts, initiated by abortion of sporangia in the sterile regions: along with this goes more adequate protection of the sporangia, and their change to a broader form: there is also a greater complexity of the stelar structure, and a greater specialisation of the embryogeny: the essential parallelism of these progressions indicates that they constitute true phyletic lines, the advance having been from the primitive condition of the "*Selago*" Section to the more specialised state of the rest of the genus. The Ligulate series, which includes the most of the fossil genera and the modern *Selaginella* and *Isoetes*, has as a rule more definite heterosporous strobili, though the "*Selago*" condition is again seen in *Isoetes*. In this respect the Ligulate Lycopods are more advanced than the Eligulate. The highest type of propagative organs in the whole phylum are the seed-like structures in *Lepidocarpon* and *Miadesmia*, which show an advance parallel to that found in the Pteridosperms. Both the living and the fossil forms are in their simplest types protostelic, but there has been advance to medullation, and finally to disintegration of the xylem of the stele and to secondary thickening in the dendroid forms. *Selaginella Spinulosa* has been recognised among living species as a relatively primitive Ligulate type, on the ground of its radial construction, its branching, and its anatomy: in these characters, as also in point of the embryogeny, *S. Spinulosa* resembles *L. Selago*, notwithstanding its heterosporous state; this fact has a special interest, and the convergence in many features between the two species confirms the correctness of their recognition as primitive in their respective genera.

The Lycopodiales stand by themselves in the simplicity of their sporangial arrangement, and constitute a type of extreme antiquity, which has come down practically unaltered to the present day. Their comparative study may be conducted independently of other phyla: for there is no reason to think that they were derived from any other known vascular type. It has been shown that the several lines of comparison converge downwards: *the condition actually seen in the "Selago" type may be held as truly primitive, and Lycopodium Selago, with its imperfectly differentiated shoot, is in fact a near approach in a living species to the ideal primitive form which emerges from wide comparative study of the phylum as a whole.*

There are two further characters seen occasionally in the Lycopodiales which call for special remark. In the very early fossil, *Lycopodites Stockii* (p. 298), the leaves are arranged in whorls, as they are also in certain living species of *Lycopodium* (p. 291). In others the leaf-arrangement is irregular. Sometimes, however, whorled and spiral arrangements may be

found at different heights on the same plant: or the plane of the whorls may be set obliquely to the axis. It would appear probable from such facts that the original type had whorled leaves, and that the spiral arrangement was acquired by secondary disturbance of it, a point of some considerable interest for comparison with the sporangiophoric Pteridophytes. The other character is seen in *Isoetes* (p. 318), and in *Lepidostrobus Brownii*, both of which had very large sporangia (p. 322). In these a partial sterilisation of sporogenous tissue producing trabeculae meets a mechanical and nutritive requirement following on their large size, and the structure thus approaches a state of septation: such septation is indeed technically completed in the megasporangia of *Isoetes*, but no Lycopod shows a septate state of the sporangium as a permanent character. The interest in this is in comparison of these sporangia with the similarly placed synangia of the Psilotaceae and Sphenophyllaceae.

These two series, together with the Equisetales, have been included under the general designation of the *Sporangiophoric Pteridophytes* (p. 423). Though differing in detail, the main plan of their sporophyte is similar to that in the Lycopodiales, as regards axis and leaves, branching, and anatomical structure; but the sporangia of the latter are replaced by sporangiophores, while the relations of these to the bracts is not uniformly so regular as that of the sporangia in the Lycopodiales. Moreover, both bracts and sporangiophores show evidences of fission, sometimes independently, sometimes together. These relations have been considered above (p. 694-5), together with the similar variations of exact position of the sporangia and sporangiophores relatively to the axis: such facts, combined with the arguments already advanced in Chapter XXVIII., lead to the conclusion that *the functionally identical parts designated sporangiophores and sporangia are cognate parts; it appears probable that the sporangiophore is itself a consequence of elaboration of a simpler type of spore-producing member, of which the sporangium of Lycopodium is an example, while the trabeculae in Isoetes and Lepidostrobus Brownii suggest a mode of origin of the septate state. If this were so, then the sporangiophore would have been distinct in its phyletic origin from the bract-leaves, which habitually subtend the spore-producing members, whether they be sporangia or sporangiophores.*

The Sporangiphoric Pteridophytes (which include the "Articulatae" of Lignier together with the Psilotaceae) are primarily characterised by the presence of the sporangiophore. The fact that the leaf-arrangement is often whorled, which is a leading feature of the Articulatae, while that in the Psilotaceae is alternate, is here regarded as a point of secondary moment. The reasons for this are, first, that the leaf-arrangement varies from the whorled to the alternate in the very natural phylum of the Lycopods, and secondly, that a similar change appears from the ancient Sphenophylleae to the modern Psilotaceae—groups clearly related to one another. *It seems probable that the whorled arrangement was initially general for the strobiloid types, but that the regularity has been secondarily abandoned.* The

character of the sporangiophore once acquired appears to have been more constant, and affecting as it does the production and dispersal of the spores, it is of much more biological moment than details of leaf-arrangement: consequently it deserves a prior place in our comparisons. The designation of the Equisetales and Sphenophyllales, including the Psilotaceae as sporangiophoric Pteridophytes, is to be preferred to any separation of the "Articulatae" on the ground of leaf-arrangement.

The essential unity of the characters of the Sporangiophoric Pteridophytes is becoming more apparent as the knowledge of them widens: this indicates that they constitute a brush of phyletic lines sprung probably from a common source: the original characters of the common stock appear to have been not unlike those of a primitive Lycopodinous type where the whole shoot was fertile; but here the spore-producing members proceeded early to a more elaborate structure, the sporangiophore replacing the simple sporangium, while a capacity for fission of the leaves supervened, and often of the sporangiophores also. The stelar structure in many cases so closely resembles that of the more primitive Lycopodiales as to lend material support to this suggestion. Starting from such a central type as *Sphenophyllum majus*, in which a "Selago" condition is seen, a departure from the whorled disposition of the leaves, such as the Lycopods show within the genus *Lycopodium*, would give the type of the modern Psilotaceae: a transition to a higher differentiation of the sterile and fertile regions, with fission of the sporangiophores and reduction of the number of sporangia borne by each would give the more complex state of *S. Dawsoni* and *Roemeri*: a similar fission of both bracts and sporangiophores would lead towards the type of *Cheirostrobus*. It is not suggested that the species named were thus grouped in actual phyletic lines, nor would these accord with stratigraphical sequence; the intention is rather to indicate morphological relationships of the different known forms to a probable primitive type, a primitive type to which *Sphenophyllum majus* retained a high degree of similarity.

On the other hand, the structure seen in *Sphenophyllum emarginatum* (p. 694, footnote) connects the Sphenophyllaceous-type of strobilus with the usual Calamarian type: it has been shown above how the various other types of the Equisetales are related to this (pp. 694-6; also chapter XXVIII.). The analogy of the Lycopodiales, together with the facts seen in the sporangiophoric Pteridophytes themselves, points to their origin also from a strobiloid type with a general-purposes shoot, in which the axis was dominant and protostelic, the leaves were whorled, and in which the spore-producing members early attained to the sporangiophoric structure. *The phyletic relationship of the Sphenophyllales and Equisetales has undoubtedly been a very close one: the distinguishing features are not to be found in the primary plan or construction of the shoot, so much as in the secondary modifications of number and relation of the appendages, and of their branching, together with changes in the originally protostelic structure of the axis. Such*

considerations support the conclusion that the Sporangiohoric Pteridophytes constitute a brush of naturally related phyletic lines.

It has been argued at length above (Chapter XXXI.) that the Ophioglossales are an upgrade sequence, a view which accords with their homosporous state: also that *their spike illustrates various steps in the increasing complexity of a body of the nature of the sporangiophore.* The elaboration of the subtending leaf runs parallel with it, while both leaf and spike show branchings and fissions comparable with those recognised in the sporangiohoric Pteridophytes, but carried out here on a larger scale. *On this view the whole unbranched shoot is a simple strobilus bearing leaves, of which all are potentially fertile, and the great majority actually so.* But the large size of the leaves, and their isolation in point of time (commonly only one being expanded at once), disguises the real nature of the strobilus. All the three genera have attained to great complexity, but in *Ophioglossum*, and more clearly in *Botrychium*, the gradually increasing complexity of the leaf in the individual life indicates what has probably occurred also in the race. Along one line, that of *Ophioglossum pendulum, intermedium, and simplex*, it seems probable that reduction of the vegetative system has occurred; but with this exception *the Ophioglossaceae appear to have been an upgrade sequence, sprung from some sporangiohoric stock, and bearing no near relation to the large-leaved Ferns.* The anatomy here again points to an origin from a protostelic structure, while the single leaf-trace strand in all the simpler forms indicates a primitively simple structure of the leaf.

The Filicales constitute a more isolated phylum than any of the smaller-leaved forms. Their general comparison among themselves has been fully discussed in Chapter XL., and the relations of their leading families graphically indicated on p. 653. It is now recognised that true Ferns were represented in the Primary Rocks by relatively few forms, while their derivative families increased in number and extent in later periods. The Leptosporangiate type is essentially modern: it is indeed doubtful whether any of the Palaeozoic Ferns had an annulus composed of a single row of cells: on the other hand, though Eusporangiate Ferns still survive, they were the leading type of the Palaeozoic Period. Accordingly, it is in the latter and not in the former that the features of interest for comparison with other phyla of Pteridophytes are to be found.

It has been shown that the construction of the shoot of the primitive Eusporangiate Ferns is essentially strobiloid, maintaining constantly the same relations of axis and leaf as in smaller-leaved forms: the axis is in some of them permanently protostelic (Botryopterideae), while in the rest a protostelic structure figures in the early seedling of the forms still living. The leaf-trace is a single strand in primitive forms, though in the modern Marattiaceae it may be broken up into separate strands. In addition to this the outcome of anatomical comparison of the Ferns at large has been to show that the axial structure is constantly referable in origin to a primitive protostele, a construction which is held to be typical and primitive for strobiloid plants;

this indicates that they are themselves essentially strobiloid types which have progressed to a condition of megaphylly. That is also the conclusion which comparison of their external morphology with that of other phyla suggests, while the absence of differentiation of the sterile and fertile regions is the same as is seen in the "*Selago*" condition of the strobiloid types. On the general biological ground that in homosporous forms there is direct advantage in enlarged spore-output, there is reason to regard amplification as probable. The amplification of the appendages has been more extensive here than in any other phylum, but there are many points of similarity with what is seen in certain of the strobiloid Pteridophytes, and especially in the Sphenophyllales and Ophioglossales. *Accordingly, it is held that the Filicales were ultimately of strobiloid origin, but have undergone amplification of their leaves analogous to, but phyletically quite distinct from what is seen in other Pteridophytes, and carried to a higher degree.*

One chief reason for regarding the lines of the Filicales and Ophioglossales as distinct lies in the difference of position of the spore-producing members. It has been argued above (p. 633) that the soral condition was primitive for Ferns, and that *the sorus is a body similar in kind to the sporangiophore, the two being alike in function, in structure, and in capacity for fission and extension* (p. 699): *the number and position are points of difference.* An increase in number of sporangiophores (or sori) is a natural concomitant of increase in size and nutritive capacity of the leaves; in the Ferns a process of fission similar to that suggested in the Sphenophyllales probably played a part, rather than elaboration of the single sporangiophore as seen in the Ophioglossales. The disposition of the numerous sori upon the leaf in Ferns differs from that in other Pteridophytes: but it must be remembered that in large-leaved forms this necessarily became a matter of biological adaptation in the absence of the protection afforded by a compact strobilus. The Filicales are thus a phylum showing fundamentally the strobiloid characters, but secondarily modified in relation to their pronounced megaphyllous habit. This was adopted very early by them, as the fossil story as well as their general morphology clearly show. *Accordingly, the Filicales appear as the most divergent phylum of homosporous Pteridophytes.*

The prevalence of a whorled arrangement of the leaves has already been noted among early strobiloid types, but it was seen to have been departed from in many of the Lycopods, and in the modern Psilotaceae. In the Filicales, however, as also in the Ophioglossales, alternate leaf-arrangement is the rule. This difference from early strobiloid types is a very natural one in megaphyllous shoots: for the whorled arrangement is mechanically inconvenient where the leaves are large. The alternate leaf-arrangement in the megaphyllous types may be held as a natural though not an inevitable consequence of the large size of the appendages. If this is itself secondary in the Filicales it is quite possible that their alternate arrangement was also secondary in descent. But on this point there is no clear evidence.

It thus appears that comparison of the several phyla, as represented both by their fossil and their modern representatives, leads in each case towards the recognition of a primitive type, and that its construction in the several phyla has certain features in common. The chief of these are the definition of axial polarity in the first initiation of the embryo: the continued apical growth: the radial construction of the shoot: the origin of the appendages laterally from the axis by enation, and in strictly acropetal order: a protostelic structure of the conducting system of the axis, and a leaf-trace composed of a single strand, which comes off from the protostele with the minimum of disturbance of its structure. The appendages were from the first of two kinds which were closely associated together: bracts or leaves, and spore-producing members: the structure of these, and their relations to one another and to the axis, varied in the different phyla, and gave them their distinctive characters: but a whorled arrangement of the bracts was prevalent in early small-leaved forms, while they commonly held a subtending relation to the spore-producing members. *A body such as that sketched appears to have been common for all the early Pteridophytes, and constituted the primitive shoot.* There is no clear indication, beyond comparison based on the facts of embryology and of mature structure, how such a body was in the first instance produced: but this leads to the hypothesis put forward in Chapter XI. The sporophyte, thus constituted, probably arose originally as a structure of limited size, and unbranched, upon a prothallus of considerable dimensions, and producing *Homosporous Spores*. From it, by branching of the axis, by differentiation of vegetative and propagative regions, by amplification of the leaves and spore-producing members, by adoption of an alternate leaf-arrangement as the leaves enlarged, and by expansion of the vascular system to meet these additional requirements, all the known homosporous types may be understood to have originated. But as explained in Chapter XLVI., the adoption of *Heterosporry*, and of the *Seed-Habit* supervened later. This, while it has led to the final independence of the Land-Flora as regards external fluid water for the completion of its Life-Cycle, has brought as a secondary consequence a wide-spread reduction.

The final goal of all organic development is the establishment of new individuals. The evolutionary story of the sporophyte illustrates this in two distinct ways. *In the prior and non-specialised homosporous forms large numbers of germs are produced:* those are individually small, and ill provided with nourishment, but they make up for deficiency of method by their large numbers. The larger their number the better the chance of survival and spread of the race: *consequently amplification of the whole sporophyte is the leading characteristic of these earlier and simpler types;* it was carried out either by multiplication of appendages individually small, as in the microphyllous types, or by enlargement of individual appendages, as in the megaphyllous types. It was in these homosporous forms that

the vegetative system was established and amplified, while it tended to become differentiated from the propagative system. *In the later and more specialised heterosporous forms, and particularly in the Seed-Plants with their more refined methods, individual precision supersedes mere numbers: and reduction of the propagative system has been its usual concomitant.* The vegetative system which became fully distinct from the propagative, often retained or even increased its dimensions and complexity. Taking an evolutionary course of its own it diverged more and more in character from the propagative system. The final result is seen in the Angiosperms which are now dominant: here the flowers differ widely from the vegetative shoots, though the plan of each resembles that of the primitive shoot from which both sprang. But whatever the modern complications may be, comparison along lines which have been pursued in this volume indicates that the sporophyte, which is the essential feature in the Flora of the Land, is referable back in its origin to post-sexual complications: *it appears to have originated as a phase interpolated between the events of chromosome-doubling and chromosome-reduction in the primitive life-cycle of plants of aquatic habit.*

INDEX.

- Abortion of spore-producing members, 120, 127, 161, 700.
- Abortive spikes in Ophioglossaceae, 446; sporangia in *Lycopodium*, 163, 292; in *Isoetes*, 165, 307.
- Acacia*, 235; seedlings, 185.
- Achyla*, 69.
- Aconitum*, 128.
- Acrostichum*, 631.
- Actaea*, 128.
- Adaptation to Land Habit, 3, 81, 245.
- Adiantum concinnum*, 30, 31 (Figs. 14, 15); *Edgworthi*, 183 (Fig. 94).
- Aglaozonia*, 66.
- Akrogynous Jungermanniaceae, 264.
- Albugo*, 68.
- Alchemilla*, apogamy in, 101.
- Allosorus crispus*, 627 (Fig. 348).
- Alsophila atrovirens* sorus, 603 (Fig. 334); *excelsa* stem-structure, 198 (Fig. 100); anatomy of young plant, 606 (Fig. 338); phyletic position of, 655 (Fig. 354); *pruinata*, 604 (Fig. 336).
- Alternating generations, balance of, 33; inversion of balance of, 45; cytological distinction of, 46, 61.
- Alternation, biological aspect of, 79.
- Amphibious habit, 81; organisms, 3, 244.
- Amphithecium, 272, 278, 285.
- Amplification, 233; progressive in homosporous forms, 236, 717; of leaf in Ophioglossaceae, 433.
- Anachoropteris*, 501.
- Anakrogynous Jungermanniaceae, 264.
- Anatomical evidence, 188.
- Anatomy of Filicales, 646; characteristic of strobiloid plants, 649.
- Andreaea*, 275 (Fig. 133, 134).
- Andreaeales, 275.
- Aneides nemorosa*, 127 (Fig. 70).
- Ancura*, 266 (Fig. 127); 267 (Fig. 129); *ambrosioides*, 90 (Fig. 46); 161 (Fig. 86).
- Angiopteris*, 505 (Fig. 274); sorus of, 512 (Figs. 278, 283, 284); anatomy of, 525 (Figs. 279, 291); embryo of, 508 (Fig. 277).
- Annularia*, 372.
- Annulus, 23, 104; of *Equisetum*, 382; in Ferns, change of position of, 639.
- Ancimia*, 543 (Figs. 301, 302); anatomy, 548.
- Anthocerotales, 267.
- Anthoceros*, 268 (Fig. 130).
- Anthoceroteae, self-nutrition of sporogonium, 237.
- Antithetic alternation, 32, 47, 80; theory, general objection to, 659.
- Apex of axis, of constant origin in embryo, 181, 664, 673.
- Apical cell of axis, origin in embryo, 668 (Figs. 357, 358); cone of *L. Selago*, 331 (Fig. 172); segmentation, 678; with small-celled meristem, 679; with definite initials, 679.
- Apogamy, 51, 52 (Fig. 33).
- Apospory, 281.
- Apospory, 53 (Fig. 37).
- Appendages, classification of, 145.
- Appendicular organs, origin of, 86.
- Archaeopteris hibernica*, 228.
- Archangiopteris*, 505; sorus of, 512 (Figs. 278, 283); anatomy of, 525.
- Archaeocalamites*, 374 (Fig. 82); whorled leaves, 230.
- Archegoniate series, origin of, 82.
- Archesporium, 88, 106; of *Anthoceros*, 268; of moss, 278, 285.
- Archidium*, 277, 284.

- Arisarum*, 127.
Aspidium acrostichoides, 24 (Fig. 8).
Asplenium obtusifolium, 583; *resectum*, 583;
shepherdii, 626 (Fig. 347).
 Assimilatory system in Bryophytes, 662.
 Astelic state, 192.
Asterocalamites, 373 (Fig. 199).
Asterochloa, 501.
Asterophyllites, 372.
Asterotheca, 511 (Fig. 282), 521 (Fig. 289);
Sternbergii, 522 (Fig. 289).
Athyrium filix-foemina v. *clarissima* apos-
 pory 55 (Fig. 37).
Atrichum, 35 (Fig. 19).
Auricula polystely, 192, 193.
 Axillary branching in Ferns, 627.
 Axis pre-existent, 141.
Azolla, 176, 610.
- Bartramia*, 281.
 Basal wall, 666; indeterminate in *Isoetes*,
 358.
 Basipetal sorus, 635.
 Bilateral construction, 201.
Blechnum, 631; *B. lanceolata*, 632.
Blechnum boreale differentiation of leaves,
 167.
Bornia, 150, 154.
Bornia radiata, 384.
Bothrodendron Kiltorchense, 228.
Botrychioxylon, 500.
Botrychium, external characters, 441; spore-
 producing members, 452 (Figs. 244, 252,
 253); anatomy, 458, etc.; prothallus, 469;
 embryo, 269 (Figs. 261-266); *daucifolium*
 (Figs. 43, 44); *simplex*, 441 (Fig. 240);
Lunaria, 441 (Fig. 241); abnormal ferti-
 lity, 160 (Fig. 85); *daucifolium*, 441;
virginianum, 441; *obliquum*, 182, 471
 (Figs. 264-266).
 Botryopterideae, 498, 501 footnote; phyletic
 position of, 654 (Fig. 354).
Botryopteris, sporangia of, 501, 503.
 Bracts or sporophylls, 693.
 Branching of shoot, dichotomous primitive,
 682; transition to monopodial, 682;
 lateral branchings, 682; of spikes in
 Ophioglossaceae, 438 (Fig. 239).
 Braun's criticism of Phytotic theory, 138.
 Bryales, 277.
 Bryophyta, 257; balance of alternating
 generations in, 35.
Buxbaumia, 281 (Fig. 137).
Calamites pettycurvensis, 390.
Calamostachys, 150 (Fig. 80): 372, 374, 376
 (Fig. 202); morphology of cone, 384 and
 footnote; *Binniana*, 374, 380; *Germanica*,
 375; *Cashiana*, 381 (Fig. 210);
Zeileri, 392; *Binniana*, 408 (Fig. 225).
 Cambial activity, 335.
 Carinal strands of *Equisetum*, 388.
Casuarina, 97 (Figs. 55, 50).
Catharina, 35 (Fig. 19).
 Cauline bundles, 195; stele, 195.
 Cauloids (Lignier), 136.
Caulopteris, 507, 511 (Fig. 280), 625.
Ceratodon purpureus, 277 (Fig. 135).
Ceratopteris, leaf development, 628.
Cheirostrobus, 230, 404, 424 (Fig. 223, 224).
Chelepteris, 533-539.
 Chemiotactic action, 30.
 Chlorophyceae, 70.
 Choris of sporangiophores, 695 (Fig. 361);
 of bracts, 695 (Fig. 361).
 Chromatin, 47.
 Chromosome-cycle, irregularities of, 58.
 Chromosomes, 47; their numbers, 48.
Cingularia, 376 (Fig. 204).
 Cladophonic structure, 189, 198.
Clarkia, 96 (Fig. 54).
 Cleistocarpaceae, 282.
Closterium, 70 (Fig. 40).
Colochoete, 73 (Fig. 42), 260.
 Columella of *Anthoceros*, 268; of *Sphagnum*,
 273.
 Columella-less forms of *Notothylas*, 270.
 Common bundles, 195.
 Comparative morphology, 5.
 Conjugatae, zygotes of, 70.
 Corlaiteae, early existence of, 228.
Corsinia, 263.
Corynepteris, 503 (Fig. 273), 529.
 Cotyledon, variable in time and place of
 origin, 670; orientation constant, 671.
 Cotyledons, constant orientation of, 182.
Crossotheca, 528.
Culleria, 66.
Cyathea, 602; phyletic position of, 656
 (Fig. 354); *dealbata*, sorus, 604 (Fig. 335);
Imrayana, 606 (Fig. 337); sorus, 602;
 anatomy, 605 (Figs. 336, 337, 338).
Cyathodium, 237 (Fig. 116), 203 (Fig. 123).
Cyathotrachus altus, 521.
Cycadeoidea, 705.
 Cycads, reduced sporophylls of, 154.
Cyelanthera, 126.

- Cynosurus*, 128.
Cystopteris, phyletic position of, 655 (Fig. 354); *bulbifera*, 19 (Fig. 3).
Cystopus, 68.
 Cytological distinction of alternating generations, 61.
Cyrtopteris fragilis, 615 (Fig. 341).
- Danaea*, 94 (Fig. 49), 505 (Fig. 275): sorus of, 512 (Figs. 278, 281, 283, 286): anatomy of, 525: embryo of (Fig. 277): *alata*, symmetry of, 212 (Fig. 106).
Danaeites, 523 (Fig. 290).
Davallia, 613: phyletic position of, 655 (Fig. 354): *Griiffithiana* (Fig. 66), 613 (Fig. 339): *hymenophylloides*, 615 (Fig. 340).
 Decentralisation in Mosses, 286.
Dennstaedtia, 613 (Fig. 332 bis): *D. rubiginosa* (Fig. 333 C), (Fig. 65), 601, 616, 597 (Fig. 332 bis): irregular arrangement of sporangia of, 598: solenostely in, 600 (Figs. 333 A-C); *apiifolia* (Fig. 65): *Davallia* series, 613: phyletic position of, 655 (Fig. 354).
Dennstaedtiinae, 595.
Deparia, phyletic position of, 655 (Fig. 354).
 Dermatogen, 178.
 Desmids, 70.
Diacalpe, 617.
 Dichotomous branching of stem in Ferns, 626; theory of origin of shoot, 630.
 Dichotomy in Fern leaves, 627, 628.
Dicksonia, 592 (Figs. 330, 331); phyletic position of, 655 (Fig. 354); *Barometz*, 193 (Fig. 97); *punctiloba*, 190 (Fig. 95).
 Dicksoniaceae, subdivision of the family, 591.
 Dictyostele, 190.
 Dictyostelic state in Ferns, 647.
Dictyota dichotoma, 66, 81.
Diphyscium, symmetry of, 205 (Fig. 104).
 Diploid phase, 47, 52.
Diplomema, 554.
 Dipteridinae, 618, solenostely in, 621.
Dipteris, 618 (Figs. 343-346).
D. conjugata, mixed sorus, 621: phyletic position of, 656 (Fig. 354).
 Dispersal of spores, 645.
 Divergent series, 10.
 Dorsiventral construction, 201.
 Dorsiventrality of shoot, 208: derivative in Ferns, 626.
 Double leaf-trace, 689, footnote.
- Equisetales, 366: external characters, 368: spore-producing member, 377: anatomy, 385; embryology, 392: summary, 395.
Equisetum, 94 (Fig. 50): anatomy of, 191 (Fig. 96): reduced leaves of, 239: sporangial development, 377: sterilisation in, 378: stelar structure of, 386 (Figs. 211, 212, 213): *maximum*, 149 (Fig. 79): 368 (Fig. 193): 370 (Fig. 194); *pratense*, 367 (Fig. 192): 373 (Fig. 196); *scirpoides*, 176 (Fig. 91); *sylvaticum*, *polystachyum*, 370 (Fig. 194): *hiemale*, 369; anatomy of seedling, 391; root apex (Fig. 92): *limosum*, 369; *arvense*, 370; *sylvaticum*, 370; *myriochaetum*, 370.
 Elaterophore, 90, 266.
 Elaters, 262.
 Eligulatae, 291; embryology of, 340.
 Embryo, biological study of, 181: dependent on prothallus, 238; of *Equisetum*, 392 (Fig. 214).
 Embryology, 173, 251; initial and continued, 174; primary in Bryophytes, 660; continued in Vascular Plants, 678; of Pteridophytes, 663; segmentation of embryos, 664 (Fig. 355): of Ferns, 649; of Filicales, 649; of Lycopods, 340; of Ophioglossales, 489; of *Ophioglossum vulgatum*, 466 (Figs. 260, 260 bis); of *O. moluccanum* and *O. pendulum*, 466; of *Botrychium virginianum*, 469 (Fig. 261); of *B. Lunaria*, 470 (Figs. 262, 263); of *B. obliquum*, 471 (Figs. 264-266); of *H. linnthostachys*, 473 (Fig. 267).
 Enation of leaf, 141; of leaves from axis, 680; objections answered, 681.
 Endothecium, 272, 278, 285.
 Enumerations of spores, 641.
Ephemerum, 208.
Eucharidium, 96 (Fig. 54).
Eu-Davallia, mixed sorus, 613.
 Eusporangiate Ferns, relatively primitive, 496.
 Epibasal tier, 666.
 Exogenous roots, 219.
 Experimental Morphology, 6.
 External characters of Filicales, 625.
 Extra-prothallial swellings, 673.
- Factors of advance, 85.
Fegatella (Conocophthalmus), 260.
 Fern, life history of, 14: vascular skeleton of, 15; sorus of, 20; spores of, 20;

- sporangium, development of, 22; spore-mother-cells of, 23; spore tetrads of, 23; sexual organs of, 27; antheridium of, 27; spermatozooids of, 28; archegonium of, 28; fertilisation of, 29; embryo of, 30, 31; life cycle of, 32 (Fig. 16).
- Fern leaf, origin of, 630, 631; differentiation of, 631.
- Ferns, resistance to drought, 18; vegetative propagation of, 19.
- Fern spores, dispersion of, 24.
- Fertile and sterile regions, their relations, 156, 251.
- Fertile spike of Ophioglossaceae, general morphology of, 432-447, 480; development of, 447, etc.
- Filicales, 495; general comparison of, 624; external characters of, 625; spore-producing members of, 632; sporangium of, 637; anatomy of, 646; embryology of, 649; phylogeny of, 652; essentially strobiloid, 657; of strobiloid origin, 715.
- Filmy Ferns, classification of, 585; structural specialisation of, 586; reduction of sporangia of, 587.
- Fission of spike in Ophioglossaceae, 479.
- Florideae, 67.
- Flower, symmetry of, 207.
- Foliar trace, disintegration of, 668.
- Foot, 672; intra-prothallial of *Lycopodium*, 225; in Lycopods, 348; in *Selaginella*, 356.
- Formative regions of Hanstein, 178.
- Free-living sporophyte, establishment of, 218.
- Frullania*, 264 (Fig. 124).
- Fucus*, 66.
- Funaria*, 278 (Figs. 136, 137); symmetry of, 204 (Fig. 103); *hygrometrica*, 91.
- Fungi, alternation in, 68.
- Gametophyte, 32.
- Gametophytic budding, 27, 61.
- General comparison of Filicales, 624.
- Geographical distribution, 5.
- Geothallus*, 263.
- Germinal layers, theory of, 175.
- Germs, distribution of, 1.
- Gleicheniaceae, phyletic position of, 654 (Fig. 354); external characters, 553; spore-producing members, 555; anatomy, 561; spore-enumerations, 559.
- Gleichenia*, 553; *circinata*, 555 (Fig. 310), 557; spore-enumerations, 559; *dicarpa* (Fig. 98); anatomy, 563 (Fig. 314); *dichotoma* (Figs. 63, 64), 554 (Fig. 310), 557 (Fig. 311); anatomy, 561 (Fig. 313); *circinata* (Figs. 63, 64); *flabellata* (Fig. 64), 554 (Fig. 309), 557 (Fig. 311); anatomy, 561 (Fig. 313); a central type, 564; *pectinata*, 554; anatomy, 561 (Fig. 313).
- Glossopteris, 625.
- Gradatae, 117, 497, 498, 470, 634; transition to Mixtae, 602.
- Grammatopteris Rigolloti*, 408 (Fig. 269), 501, 532, 539.
- Gnetum gnetum*, 97.
- Gunnera* polysteyli, 192.
- Gymnosperms, early existence of, 228.
- Gymnosporangium*, 69.
- Hairs of Ferns, 632.
- Haploid phase, 48, 52.
- Hawlea Miltoni*, 522 (Fig. 289).
- Haustoria, 181, 672.
- Haustorium, intra-prothallial, 347.
- Helminthostachys*, 151 (Fig. 83), 443 (Figs. 243, 244); external characters, 443 (Figs. 243, 244); spore-producing members, 455 (Figs. 254, 255); anatomy, 458, etc. (Fig. 256); embryo, 473 (Fig. 267).
- Hepaticae, 257.
- Heterosporous condition, 114.
- Heterospory, 703, 716; in *Selaginella*, 317; in *Isoetes*, 318; in *Lepidostrobus*, 324; in *Calamostachys*, 381.
- Hippuris*, 178.
- Hofmeister's Vergleichende Untersuchungen, 14, 33.
- Homogeny, 76.
- Homologous alternation, 76, 79.
- Homologous theory of alteration, 47.
- Homosporous condition, 113; ferns in Palaeozoic period, 497.
- Horsetails, 366.
- Hydrodictyon*, 64.
- Hymenophyllaceae, phyletic position of, 654 (Fig. 354); external characters, 575 (Figs. 322, 323); spore-producing members, 570 (Figs. 324, 327); anatomy, 582 (Fig. 328); classification, 585.
- Hymenophyllites delicatulus*, 582; *Wicissii*, 582.
- Hymenophyllum*, habit, 575 (Fig. 322); sorus, 579 (Fig. 324 bis); sporangia, 579 (Fig. 325); spore-enumerations, 580;

- filmy structure, 582; stock, 584 (Fig. 328); *dilatatum* (Fig. 68).
- Hypobasal appendage of Jungermanniaceae, analogy with suspensor, 661.
- Hypobasal tier, 666.
- Hypoderris*, 617.
- Hypolepis*, 615, 616: phyletic position of, 655 (Fig. 354).
- Hypothetical archegoniate algae of Tansley, 137, 216.
- Imperfectly developed parts, 162.
- Indusium, 636; reduction of, 637.
- Initiation of sporophyte not demonstrated in any one phylum, 658.
- Intercalation of sporophyte, 260.
- Interpolation of sporangia, 612.
- Irregularities of chromosome-cycle, 58.
- Isaetes*, 95 (Figs. 52, 53), 307 (Fig. 155): sporangia of, 318 (Figs. 165, 166); anatomy of, 337 (Fig. 177); embryology of, 358 (Fig. 191); sporophytic budding, 57; stele of, 337; secondary thickening of, 338; *echinospora*, 319; *lystris*, 337 (Fig. 177).
- Jungermanniales, 264.
- Juniiferus communis*, 127 (Fig. 69).
- Kaulfussia*, 151, 505 (Fig. 276); sorus of, 512 (Figs. 278, 281, 283); anatomy of, 525.
- Klukia*, 546 (Fig. 304).
- Lacopteris*, 565, 622.
- Lastraea pseudo-mas*, v. *cristata*, 60.
- Leaf, "free-living," 183; its vascular supply, 192; wings of in ferns, 651 (Fig. 353).
- Leaf-formation, in Liverworts, 133; in vascular plants, 134.
- Leaf-trace, 193; of Ophioglossaceae, 462, 488; in ferns, 648.
- Leaves, sterile and fertile, 87; polyphyletic origin of, 133.
- Lepidocarpon*, 704.
- Lepidodendron Juliginosum*, 338; *Harcourtii*, 334 (Fig. 174); *rhodomense*, 334; *salsfeldense*, 334; *petticurvensis*, 334; *schlaginoiaes*, 336 (Fig. 176).
- Lepidophloios*, 304 (Fig. 152).
- Lepidostrobos*, 305 (Fig. 153); *Brownii*, 95, 322; anatomy of, 335.
- Lepidostrobos Veltheimianus*, 324 (Fig. 170).
- Leptopteris*, 530.
- Leptosporangiate Ferns, symmetry of, 213; not primitive, 496.
- Leucostegia*, 615 (Fig. 340).
- Ligulatae, 291, 299; embryology of, 356; "Selago" condition, 700; truly primitive, 711.
- Lily, pollen-mother-cells of, 49 (Fig. 32).
- Lindsaya*, 617; phyletic position of, 665 (Fig. 354).
- Lomatophloios macrolepidotus*, 305.
- Loranthus*, 126.
- Loxsona*, systematic position of, 574; phyletic position of, 655 (Fig. 354).
- Loxsona Cunninghamii*, 105 (Fig. 60).
- Loxsonaceae, 571; spore-producing members, 571; anatomy, 573.
- Loxsonopsis*, see addendum, p. xii.
- Lycopodiales, progressive disintegration of stele, 231; general morphology of, 290; spore-producing members of, 311; comparative anatomy of, 328; embryology of, 340; summary on, 303.
- Lycopodium Stockii*, 298 (Fig. 147, 321); whorled leaves, 230; *Guthieri*, 301; *primaevus*, 301; *Suissei*, 301; *ciliatum*, 305; *Reidii*, 305.
- Lycopodium*, origin of sporangium, 146 (Fig. 75); leaf arrangement of, 291 (Fig. 141); section *Urostachya*, 294, 313; section *Rhopalostachya*, 294, 314; subgenus *Lepidotis*, 296; subgenus *Diphysium*, 296; *Selago*, 292; *Subselago*, 292; *alpinum*, sporangia, 314 (Fig. 161); *amotinum*, anatomy of, 329 (Fig. 171); prothallus of, 341 (Fig. 179); embryo of, 347 (Fig. 186); *cernuum*, 296 (Fig. 143); prothallus of, 341 (Fig. 178); embryology of, 351 (Fig. 187), 188, 101; gametophyte of, 37 (Fig. 21); sporophyte of, 38 (Fig. 22); detached leaf-traces, 199 (Fig. 101); *chamaecyparissus*, 125 (Fig. 67); *claratum*, 296; sporangium of, 314; prothallus of, 343; embryo of, 347; reduced scales of seedling, 239 (Fig. 117); *compactum*, 292; *Trencilla*, 292; *firmitum*, 292; *rigidum*, 292; *Dalhouisianum*, 292; *carinatum*, 292; *gnidioides*, 292; *squamosum*, 292; *Phlegmaria*, 293; (Fig. 142); *varium*, 294; *subulatum*, 294; *nummularifolium*, 294; *ophioglossoides*, 294; *pinifolium*, 294; *inundatum*, 294; *Drummondii*, 294; *cernuum*, 295 (Fig. 148); *claratum*, 296;

- carolinianum*, 296 (Fig. 144); *complanatum*, prothallus of, 334; *dichotomum*, sporangial wall, 325; *inundatum*, 294; sporangium of, 313; prothallus of, 340; embryo of, 351; *phlegmaria*, 293; habit of (Fig. 142); sporangium of, 313 (Fig. 158); prothallus of, 342; embryo of, 346 (Fig. 185); *salakense*, prothallus of, 340; *Selago*, frontispiece: form of, 292; sporangium of, 311; anatomy of, 328; prothallus of, 343 (Figs. 180, 181); embryo of, 345 (Figs. 183, 184); comparison of, 363.
- Lycopods, symmetry of, 210.
- Lycopsidea, 486.
- Lyginodendron*, 705.
- Lygodium*, 542 (Figs. 301, 302); anatomy, 547 (Figs. 306, 307); *subalatum*, fertile primordial leaves, 187; early fertility, 632.
- Male shield fern, 15.
- Malformations, 481.
- Marattia*, external characters, 505; sorus, 513 (Figs. 278, 283, 285); anatomy of, 525; embryology of, 527 (Fig. 292).
- Marattiaceae, symmetry of, 211; external characters, 505; spore-producing members, 512; anatomy, 524; embryology, 527; phyletic position of, 654 (Fig. 354).
- Marchantiales, 257.
- Marsilia*, 511; *Drummondii*, 59.
- Marsiaceae, 551.
- Matonia*, see Matonineae; phyletic position of, 656 (Fig. 354); *Dipteris* series, 618.
- Matonidium*, 597.
- Matonineae, 564 (Fig. 315); spore-producing members, 565 (Figs. 316, 317); anatomy, 569 (Fig. 319).
- Medullation in *Lepidodendron*, 334.
- Megaphylly, secondary in Ferns, 657.
- Megaphyton*, 508, 625.
- Megasporangia, of *Selaginella*, 317; of *Isoetes*, 320.
- Meristele, 190.
- Meristems of Ferns, comparative study of, 650.
- Meroblastic segmentation, 661, 605.
- Mesarch xylem, of *Helminthostachys*, 486; of *Tmesipteris*, 486 (Fig. 268).
- Metamorphosis, 157, 151.
- Metzgeria, 266.
- Miadesmia*, 704; *membranacea*, 301.
- Microdictyon*, 567.
- Microlepia*, 596 (Fig. 332), 613, 614.
- Microsporangia of *Selaginella*, 317; of *Isoetes*, 310.
- Migration from water to land, 83.
- Mixtae, 117, 497, 498, 612, 634.
- Mohria*, 542 (Figs. 301, 302); anatomy, 548.
- Monarch roots in Ophioglossaceae, 458 (Fig. 256) in Lycopods, 259.
- Monoctlea*, 262 (Fig. 122); symmetry of, 204.
- Monophyllous habit in Ophioglossaceae, 431.
- Monostele, 190.
- Moss, cauline stellar column, 195.
- Musci, 272.
- Mycorrhiza, in *Cyathea*, 240; in *Neottia* and *Sarcodes*, 240; in Psilotaceae, 241; in Ophioglossales, 241, 477; in Lycopods, 478; in Ferns, 478.
- Mycorrhizic symbiosis, its relation to reduction, 240.
- Myosurus*, 128.
- Najas*, 127.
- Nanomitrium*, 283 (Fig. 140).
- Nephrodium dilatatum*, apogamy, 53 (Fig. 35).
- Nemalion*, 67.
- Nematophycus*, 228.
- Nephrodium Filix-mas*, 15-25 (Figs. 1, 2, 4, 5, 6, 9, 10, 11); *pseudo-mas*, v. *cristata*, apogamy and apospory, 56 (Fig. 88); v. *polydactylum*, 57, 58 (Fig. 39).
- Neuropteris*, 705.
- Non-medullated monostele, 330.
- Non-soral state in Ferns, 633.
- Netothylas*, 269 (Fig. 131).
- Nuclear division, 47, 48 (Fig. 31).
- Nutrition of sporophyte, 242.
- Nutritive cells, 263.
- Ocotants, theory of, 170.
- Oligocarpia*, 554, 500 (Fig. 312); *lindsaeoides*, 522 (Fig. 289).
- Onagraceae, 96.
- Onoclea*, 617; *sensibilis*, 29 (Fig. 13); *Struthiopteris*, differentiation of leaves, 169 (Fig. 89).
- Ophioglossales, symmetry of, 212, 430; external characters, 431; spore-producing members, 447, 484; anatomy, 458; embryology, 464, 489; comparative discussion of, 476; mycorrhiza in, 477; not a reduction series, 477; origin from sporangiphoric Pteridophytes, 493.

- Ophioglossum*, external characters, 431; spore-producing members, 447; spore-mother-cells, 451 (Figs. 250, 251); anatomy, 458 (Figs. 256, 258, 259); embryo, 466 (Fig. 260); prothallus, 464; *cratolophoroides*, 431; *opacum*, 431; *vulgatum*, 431 (Fig. 235); *Bergianum*, 433; *bulbosum*, 433; *nudicaule*, 433; *lusitanicum*, 423; *pendulum*, 435; *palmatum*, 435 (Figs. 238, 239); *simplex*, 441; *intermedium*, 441; *reticulatum*, 439, 448 (Fig. 246); 451 (Fig. 250).
- Orientation of embryo variable, 666.
- Origin of members as new structures, 659; objections answered, 680.
- Osmunda*, 530 (Fig. 293); sporangia of, 532, 535 (Figs. 296 bis, 296); anatomy of, 536 (Figs. 208, 299); embryology of, 540; reduced leaves of, 239; *regalis* and *javonica*, 169 (Fig. 90).
- Osmundaceae, external characters, 530 (Fig. 293); spore-producing members, 533; anatomy, 536; embryology, 540; phyletic position of, 654 (Fig. 354).
- Osmundites*, 539.
- Overtopping, 135, 136.
- Pachytheca*, 228.
- Palaeophytology, evidence of, 227; its limitations, 229.
- Palaeopteris hibernica*, 582.
- Palaeostachya*, 150 (Fig. 81); *vera*, 375 (Fig. 203); morphology of cone, 384 footnote.
- Parts, independent origin of, 183.
- Pecopteris*, 528; (*Dicksonites*) *Pluckenoti*, 528; *dentata*, 519 (Fig. 287); *unita*, 520.
- Pellia*, 266 (Fig. 128).
- Periblem, 178.
- Periodic reduction, 84.
- Pironospora*, 68.
- Phacum*, 282 (Fig. 139).
- Phragmidium*, 69.
- Phyllanthus, 126.
- Phylloglossum*, 297 (Figs. 145, 146); sporangium of, 315; embryology of, 352, 355 (Fig. 180); detached leaf-traces, 199; protocorm of, 225.
- Phylloids (Lignier), 136.
- Phyllopodium, 629.
- Phyllosiphonic structure, 139, 198; state, may be derived from chalosiphonic, 487-8; secondary, 648.
- Phyllothea*, 150, 167, 372 (Fig. 107), 384.
- Phylogeny of Filicales, 652.
- Physomitrella patens*, 36 (Fig. 20).
- Physomitrium*, 280 (Fig. 137).
- Physiological experiment, 6; a check on phyletic speculation, 236.
- Phytonic theory, anatomical aspect of, 188; of Delpino, 135.
- Picea excelsa*, ovule of, 41 (Fig. 27).
- Pilularia*, 551.
- Pinakodendron musicum*, 304.
- Pinus Laricio*, germination of pollen, 42 (Fig. 28).
- Platycrium*, 631.
- Platyzoma*, 553.
- Plerome, 178.
- Pleurozoia*, 220 (Fig. 114), 302 (Fig. 151); strobilus of, 304 (Fig. 154).
- Podostemaceae, symmetry of, 201.
- Polarity, 203; of embryo variable, 666; inversion of, 675.
- Pollen-mother-cells, 49 (Fig. 32).
- Polygonum*, ovary of, 44 (Fig. 30).
- Polyphyletic development, 11.
- Polypodium*, 628; phyletic position of, 656 (Fig. 354); *punctatum*, 616; *vulgare*, 23, 28, 214 (Figs. 7, 12, 110); symmetry of seedling, 214 (Fig. 110).
- Polysiphonia*, 67, 81.
- Polysporangiate state, 113.
- Polystelic type, 189.
- Polystichum angulare*, v. *fulcherrimum*; apospory in, 55 (Fig. 37).
- Polytrichaceae, stem-structure, 195-6.
- Polytrichum*, 281.
- Porella*, 265 (Fig. 126).
- Precocity of cotyledon, 670, 671; of root, 672.
- Primitive shoot, 716.
- Progressive metamorphosis of Goethe, 157, 251.
- Prohepatic type of Lignier, 137, 216.
- Prothalli of *Lycopodium*, 340; saprophytic, 342; subterranean, 343.
- Prothallus of Fern, 25.
- Protocalamariaceae, 373.
- Protocorm, 181, 223, 253, 672; in Phanerogams, 224; of Lycopods, 351.
- Protostelic state in primitive Ferns, 647.
- Protoxylem, peripheral in *Lycopodium*, 328; central in *Selaginella*, 332.
- Psaronius*, 507, 526, 528.
- Pseudobornia*, 373, 424.

- Pseudosteles, 193.
 Psilotaceae, 398, 408.
Psilotum, 88 (Fig. 45); sporangiophore, 147; spore-producing members of, 416 (Fig. 232); anatomy of, 418 (Fig. 233); 408, 412 (Fig. 229).
 Pteridophyta, 288; balance of alternating generations, 36.
 Pteridosperms, their discovery, 496.
Pteris, phyletic position of, 655 (Fig. 354); *clata*, 616 (Fig. 342); *heterophylla*, 632.
 Pteropsida, 486.
Psycocaryus, 511, 520 (Fig. 288); *unitus*, 151 (Fig. 84).
Rachiopteris Oldhamia, 501.
 Radial construction, 201, 252.
Radula, 264 (Fig. 125).
 Recapitulation, theory of, 173; applicable within limits, 185; exceptions to its applications, 159, 636, 660.
 Receptacle of sorus, 634; not a result of "metamorphosis," 635.
 Red Seaweeds, 67.
 Reduction, 233, 253; its prevalence in phyletic speculation, 235; of leaf, 139; in moss-sporogonia, 238; in *Ophioderma*, 241; follows on seed-habit, 717; of chromosomes, 50 (Fig. 32); phyletic delay in, 77.
 Reduction-series, synthetic necessity of, 482.
Rhizophora, 96, 142 (Fig. 72).
 Rhizophores, of *Selaginella*, 219.
Rhopaledia, 71 (Fig. 41).
Riccia, 33, 34 (Fig. 17); absence of polarity, 203; archegonium of, 257 (Fig. 118).
Ricciocarpos, 34 (Figs. 18, 18A); sporogonium of, 257 (Figs. 119, 120).
Riccia, 263.
 Root of embryo, variable in time and place of origin, 671, 672; origin of, 216; exogenous, 219; capless, 219.
 Root-apex of Osmundaceae, 649 (Fig. 351).
 Rootless sporophytes, 218.
 Roots, "free-living," 183.
 Root-structure in Ophioglossaceae, 458 (Fig. 250), 489.
Salvinia, 176, 610.
 Salviniaceae, 610; related to Gradatae, 611.
Schizaea, 543 (Figs. 300, 301, 302); anatomy, 549.
 Schizaeaceae, external characters, 542; spore-producing members, 544; anatomy, 547; segmentation of sporangium, 547 (Fig. 305); phyletic position of, 654 (Fig. 354).
Schizocnema, 372 (Fig. 198).
 Schizostelic state, 192.
Scolopendrium vulgare (Fig. 93); apogamy, 52, 54 (Figs. 34, 35).
Scolopoteris, 511 (Fig. 282), 521 (Fig. 289); *polymorpha*, 522 (Fig. 289).
 Secondary thickening, 690; in *Lepidodendron*, 334; in Ophioglossaceae, 488.
 Seed-habit, 703, 716; often leads to reduction, 705.
 Seed-plants, balance of alternating generations, 43.
 Segmentation, 176; of embryo, 179; of zygote in Lycopods, 345.
Selaginella, origin of sporangium, 146 (Fig. 74); symmetry of, 211.
Selaginella apus, microsporangium of, 39 (Fig. 23); megasporangium of, 40 (Fig. 24); microspore of, 40 (Figs. 25, 26).
Selaginella sanguinolenta, 299; *Martensii*, 299; *apus*, 317; *rufostriis*, 317; *helvetica*, 316; *Wallichii*, 310; *Kraussiana*, 316; *inaequalifolia*, 334; *Willdonovii*, 334; *lacvigata*, 334; *spinulosa*, 299 (Fig. 51); basal knot of, 220 (Fig. 113); general morphology of, 300 (Figs. 148, 149); sporangia of, 316 (Figs. 163, 164); anatomy of, 332 (Fig. 173); embryology of, 356 (Fig. 190).
 "Selago" condition, 164; in Lycopods, 164; in *Isoetes*, 165; in Psilotaceae, 165; in Ophioglossaceae, 166; in Ferns, 167.
Senftenbergia, 546 (Fig. 303); *Ophiodermatica*, 522 (Fig. 280).
 Septa, origin of, 97, 110.
 Septum in *Tmesopteris*, 411, 415.
 Series of progression, 10; of reduction, 10.
 Sexual cycle, 75.
 Sexuality, a constantly recurring feature, 6.
Sigillaria, stelar structure, 231; fructifications of, 325; *elongata*, 337; *elegans*, 337; *Menardi*, 337; *spinulosa*, 337.
Sigillariostrobus Crepinii, 325.
 Simplices, 117, 497, 498, 934.
 Small-leaved types primitive, 139.
 Solenostelar structure, of *Gleichenia*, 502 (Fig. 313); of *Mariaia*, 500 (Fig. 319); of *Loxosma*, 573 (Fig. 321); of *Dennstaedtiinae*, 600 (Fig. 333); of *Pteris*, 616 (Fig. 342).

- Solenostele, 190; in Ferns, 647.
- Somatic expansion, 77.
- Soral state in Ferns, 633.
- Sorus, a sporangiophore, 151; fission of, 633; primitive position of, 633; shifting of position of, 636; extension of, in Ferns, 699.
- Speculative morphology, 6.
- Spencerites*, 146 (Fig. 76); *insignis*, 321 (Fig. 167).
- Spermatozoids, fertilisation by, 2, 244.
- Sphaerocarpus*, 92, 263.
- Sphaeropteris*, 617.
- Sphagnales, 272.
- Sphagnum*, 93 (Fig. 48), 272 (Fig. 132).
- Sphenophyllum*, vegetative system, 399; anatomy, 400; strobilus, 401.
- Sphenophyllales, 398; summary for, 423.
- Sphenophylleae, 230, 398.
- Sphenophyllum cuneifolium*, 400 (Fig. 216) (= *S. Dawsoni*), 402, 425 (Fig. 219); *S. tenerrimum*, 400 (Fig. 216); *S. verticillatum*, 400 (Fig. 216); *S. majus*, 147 (Fig. 78); *insigne*, 400 (Fig. 217); *S. trichomatosum*, 402 (Fig. 218); *S. angustifolium*, 402; *tenerrimum*, 402; *Römeri*, 402, 425 (Fig. 220); *majus*, 402, 424 (Figs. 221, 222); *fertile*, 404.
- Spha-num*, 281 (Fig. 138); *luteum*, 203 (Fig. 102).
- Sporangia, 693; positions of, 694 (Fig. 360); increase and decrease of, 86; uniformity of dimensions of, 114; indefiniteness of number, 115; relation to axis, 115; individual identity of, 117; simultaneous or successive, 117; variations in number of, 119, 129, 249; increase in number of, 120, 249; decrease in number of, 120, 249; septation of, 120, 249; interpolation of, 120, 121, 249; interpolation restricted to certain groups, 130; fusion of, 120, 126, 130, 249; abortion of, 120, 127, 161, 249.
- Sporangiophore, 144, 250, 693; of *Tmesipteris*, 409, 410, 414; of *Psilotum*, 412, 416; number of sporangia, 425; position, 425; development, 426; a part *sui generis*, 153, 426; amplification of, 699; positions of, 694 (Fig. 360); of *Helminthostachys*, origin of, 455 (Figs. 254, 255); of *Equisetum*, 371, 377, 379; morphology of, 382.
- Sporangiophoric Pteridophytes, 366; summary for, 423; a brush of related phyletic lines, 712-714.
- Sporangium defined, 103, 112; individuality of, 110; septation of, 110; of Ferns, segmentation of, 637 (Fig. 349); stalk of, 638; head of, 638; annulus of, 638; pluriserial annulus, 639; contents of, 641; succession of, 644; of Filicales, 637.
- Sporangiogenic band, 447, 449 (Figs. 247, 248).
- Spore-enumerations, 641; variation in number in near affinities, 643; in Botryopterideae, 502; in Marattiaceae, 516, 520; in Osmundaceae, 536; in Schizaeaceae, 547.
- Spore-output of Male Fern, 23.
- Spore-producing members, 693; of Filicales, 632.
- Spore-production a constantly recurring event, 9.
- Spores, dispersal of, 645; in Simplices, 645; in Gradatae, 646 (Fig. 350); in Mixtae, 646.
- Sporogonia, symmetry of, 203; of Mosses, general comparison of, 285.
- Sporogenous group, 87; tissue, segregation of, 85; hypodermal origin of, 109; not strictly circumscribed, 112; time of distinctive development, 116; disintegration of, 142.
- Sporophyll converted to foliage leaf (Goebel), 171; of *Tmesipteris*, 409, 410, 414; of *Psilotum*, 411, 416.
- Sporophyte, 32.
- Sporophytic budding, 20, 61.
- Sporophylls, 144.
- Spross-glied-lehre of Celakovsky, 135.
- Stachannularia*, 377.
- Stauropteris oldhamia* spores germinate in sporangium, 497, 498 (Fig. 271), 501.
- Stigmarian trunks, 220 (Fig. 112); 302 (Fig. 150).
- Stegocarpae, 277.
- Stelar theory, 189.
- Stele, 189; non-medullated monostele primitive, 685; medullation, 687; disintegration, 687; xylem-sponge of Lycopods, 688; intrusion of outer tissues leads to solenostele, 688; of Lycopods, 328; of *Selaginella*, 332 (Fig. 173); of *Lepidodendron*, 333 (Fig. 174).
- Stem-apex of *Angiopteris* and *Osmunda*, 650 (Fig. 352).
- Sterile and fertile regions, their relations, 156, 251.
- Sterile region secondary, 161.

- Sterilisation, 84, 87, 161, 246: in Pteridophyta, 89, 93; in Bryophyta, 90; in Seed-Plants, 96, 97 (Fig. 57); in Marchantiales, 263; in Jungermanniales, 267; in Anthocerotales, 209; in Hepaticae generally, 271; in Mosses, 286; in Bryophytes, 660.
- Stock of Ophioglossaceae, structure of, 459, etc. (Fig. 236); of *O. Bergianum*, 460 (Fig. 258); of *Helminthostachys*, 460 (Fig. 257).
- Stomata, functionless in *Sphagnum*, 274.
- Storage-tuber of *Phylloglossum*, 352.
- Strobili, symmetry of, 208.
- Strobilus, theory of, 132, 138, 248; of *Equisetum*, 370.
- Stromatopteris*, 553.
- Struthiopteris*, 631.
- Subtending position of bract, 695 (Fig. 361).
- Suppression, 162.
- Suspensor, its variability, 182; in *Botrychium obliquum*, 472 (Figs. 264-266): present or absent, 675.
- Symmetry, 201, 252: radial primitive for sporophyte, 203, 217, 252.
- Synangia, in *Botrychium Lunaria*, 453 (Fig. 252); in *Botrychium daucifolium*, 454 (Fig. 253); of Marattiaceae, 512.
- Synapsis, 50 (Fig. 32).
- Synthetic types, 230.
- Tapetum, 104.
- Thyrsopterideae, 589.
- Thyrsopteris*, 589 (Fig. 329): phyletic position of, 655 (Fig. 354).
- Tetrad-division, 49, 50 (Fig. 32), 87.
- Tetraspores, 66, 67, 68.
- Thallophytes, alternation in, 63.
- Tmesipteris*, 144 (Fig. 73): 408 (Figs. 226, 227, 228); spore-producing members of, 413 (Figs. 230, 231); anatomy of, 419 (Fig. 234); sporangiophore, 147 (Fig. 77); *Tannensis*, septum fertile, 99 (Fig. 58).
- Uda*, 530, sporangia of, 532 (Fig. 294), 533 (Figs. 295, 296): anatomy of, 530 (Fig. 298); *superba*, 582.
- Trabeculae of *Isoetes*, 95, 318; of *Lepidostrobos*, 323.
- Tradescantia*, pollen grain of, 43 (Fig. 29).
- Trichomanes*, habit, 575 (Fig. 323); sorus, 578 (Fig. 324); sporangia, 579 (Figs. 325, 327); spore enumerations, 580; filmy structure, 582; stock, 584; § *Fica*, 631; *alatum*, apogamy and apospory, 56.
- Tubicaulis*, 501.
- Uebergipfelung theory of Potonié, 135.
- Ulex* seedlings, 185.
- Ulothrix*, 73.
- Uredineae, 69.
- Vaccinium Myrtillus*, symmetry of, 209.
- Radial type of early Ferns, 625.
- Vascular shoot, symmetry of, 206.
- Vascular skeleton, 685.
- Vaucheria*, 64.
- Vegetatio languensiens*, 157.
- Vegetative region of Pteridophytes, symmetry of, 209.
- Velum, origin of, 319.
- Venation in Ophioglossaceae, 463.
- Ventral lobe, 153, 426, 481.
- Water-relation, 2.
- Welwitschia*, floral symmetry, 208.
- Whorled leaves, probably primitive, 711.
- Wings of leaf in Ferns, comparative study of, 651 (Fig. 359).
- Woodsia*, 617.
- Working hypothesis, summary of, 244.
- Xylem-core, 334.
- Xylem-islands, 330.
- Xylem-sponge in *Lycopodium*, 330.
- Zygopteris*, 585, sporangia of, 501, 508 (Fig. 272); 529, *Guaya*, 490 (Fig. 270).

WORKS ON BOTANY.

Practical Botany for Beginners.

By Prof. F. O. BOWER and D. T. GWYNNE VAUGHAN, M.A.
Globe 8vo. 3s. 6d.

GUARDIAN.—"We should say there is no more complete handbook published; it satisfies the supreme test, for with its assistance an absolute novice could procure and set up apparatus and teach himself, dispensing with oral instruction."

University Text-Book of Botany.

By Professor DOUGLAS HOUGHTON CAMPBELL, Ph.D. 8vo. 17s. net.

ATHENÆUM.—"We may congratulate the author on the success of his attempt. There was no room for much novelty in the arrangement of materials, but the presentment of the details is concise, lucid, and up-to-date. It is, by reason of its condensation, not a book which we should place in the hands of a beginner, but to more advanced students it will be of very great value."

The Structure and Development of Mosses and Ferns. (*Archegoniatae*.)

By Professor DOUGLAS HOUGHTON CAMPBELL, Ph.D. 8vo. 18s. 6d. net.

KNOWLEDGE.—"Botanists should be grateful for this solid and comprehensive contribution to the literature of the Archegoniate series—the best that has appeared for some years. Prof. Campbell's work will be long recognised as a standard one for students of the structure, development, and inter-relationships of the lowly but important families of plants described in it."

Lectures on the Evolution of Plants.

By Professor DOUGLAS HOUGHTON CAMPBELL, Ph.D. Crown 8vo. 4s. 6d. net.

ATHENÆUM.—"The present book is admirably adapted to convey a general knowledge of the subject, and to serve as an introduction to more recondite treatises. Not only does it pass in review the main groups of plants, but it deals also with such subjects as the geographical and the geological distribution of plants, the relationships of animals and plants, and the influence of what we used to call external conditions, but which is now universally spoken of as the 'environment.'"

WORKS ON BOTANY.

A New Edition. Revised with the Eighth German Edition by
DR. W. H. LANG.

A TEXT-BOOK OF BOTANY

BY

DR. E. STRASBURGER.

DR. FRITZ NOLL.

DR. H. SCHENCK.

DR. A. F. W. SCHIMPER.

Translated by H. C. PORTER, PH.D.

With all the Illustrations that appeared in the previous edition, and some additional ones.

ATHENÆUM.—"The book is thoroughly comprehensive, and masterly in its width of range and knowledge. . . . It will hold its own as the standard work, we should say, for some time to come."

The Student's Flora of the British Islands.

By Sir J. D. HOOKER, M.D., D.C.L., LL.D., F.R.S. Third edition.
Globe 8vo. 10s. 6d.

Structural Botany ; or, Organography on the
Basis of Morphology. To which is added the Principles of Taxonomy
and Phytography, and a Glossary of Botanical Terms. By ASA GRAY,
LL.D., Fisher Professor of Natural History (Botany) in Harvard
University. 8vo. 10s. 6d.

Physical Botany.

I. Outline of the History of Phaenogamous Plants. II. Vegetable
Physiology. By G. L. GOODALE. 8vo. 10s. 6d.

Notes on the Life History of British Flowering

Plants. By LORD AVEBURY, F.R.S. Illustrated. 8vo. 15s. net.

Timber and some of its Diseases.

By H. MARSHALL WARD, D.Sc., F.R.S., F.L.S., formerly Professor of
Botany in the University of Cambridge. Illustrated. Crown 8vo. 6s.

Disease in Plants.

By H. MARSHALL WARD, D.Sc., F.R.S., F.L.S., formerly Professor of
Botany in the University of Cambridge. Crown 8vo. 7s. 6d.

LONDON: MACMILLAN & CO., LTD.

WORKS ON CHEMISTRY.

- A TREATISE ON CHEMISTRY. By Sir H. E. ROSCOE, F.R.S., and the late C. SCHORLEMMER, F.R.S. Vol. I. The Non-Metallic Elements. New edition, completely revised by Sir H. E. ROSCOE, assisted by Dr. H. C. COLMAN and Dr. A. HARDEN. Svo. 21s. net. Vol. II. The Metals. New edition completely revised by Sir H. E. ROSCOE and Dr. A. HARDEN. Svo. 30s. net.
- ANALYTICAL CHEMISTRY. By A. MENSCHUTKIN. Translated from the Third German Edition, under the supervision of the Author, by JAMES LOCKE. Medium Svo. 17s. net.
- ESSAYS IN HISTORICAL CHEMISTRY. By T. E. THORPE, C.B., F.R.S. Second Edition, enlarged. Svo. 12s. net.
- HISTORY OF CHEMISTRY FROM THE EARLIEST TIMES TO THE PRESENT DAY. By ERNST VON MEYER, Ph.D. Third Edition. Translated by GEORGE MCGOWAN, Ph.D. Svo. 17s. net.
- THEORETICAL CHEMISTRY FROM THE STANDPOINT OF AVOGADRO'S RULE AND THERMO-DYNAMICS. By Prof. WALTER NERNST, Ph.D. Revised in accordance with the Fourth German Edition. Svo. 15s. net.
- CHEMISTRY OF THE PROTEIDS. By Dr. GUSTAV MANN. Based on Professor COHNHEIM'S *Chemie der Eiweiss Körper*. Svo. 15s. net.
- THE SCIENTIFIC FOUNDATIONS OF ANALYTICAL CHEMISTRY TREATED IN AN ELEMENTARY MANNER. By WILHELM OSTWALD, Ph.D. Translated by GEORGE MCGOWAN, Ph.D. Crown Svo. 6s. net.
- PRINCIPLES OF INORGANIC CHEMISTRY. By Prof. W. OSTWALD. Translated by A. FINDLAY. Svo. 18s. net.
- A DICTIONARY OF CHEMICAL SOLUBILITIES, INORGANIC. By ARTHUR MESSENGER COMEY, Ph.D. Demy Svo. 15s. net.
- A NEW VIEW OF THE ORIGIN OF DALTON'S ATOMIC THEORY. A Contribution to Chemical History. Together with Letters and Documents concerning the Life and Labours of John Dalton, now for the first time published from manuscript in the possession of the Literary and Philosophical Society of Manchester. By Sir HENRY E. ROSCOE, F.R.S., and ARTHUR HARDEN. With Portrait. Six page plates. Svo. 6s. net.
- THE EXPERIMENTAL STUDY OF GASES. By Dr. MORRIS W. TRAVERS, University College, London. With Introduction by Sir W. RAMSAY. Svo. 10s. net.
- INTRODUCTION TO PHYSICAL CHEMISTRY. By JAMES WALKER, D.Sc., Ph.D. Fourth Edition. Svo. 10s. net.
- A TEXT-BOOK OF INORGANIC CHEMISTRY. By Prof. IRA REMSEN. Svo. 16s.
- THE ELEMENTS OF PHYSICAL CHEMISTRY. By HARRY C. JONES. Svo. 17s. net.
- PRINCIPLES OF INORGANIC CHEMISTRY. By the same. Svo. 17s. net.
- CHEMICAL TECHNOLOGY AND ANALYSIS OF OILS, FATS, AND WAXES. From the German of Prof. Dr. R. BENEDIKT. Third Edition, entirely re-written and enlarged by Dr. J. LEWKOWITSCH, F.I.C., F.C.S. Two Vols. Svo. 36s. net.
- LABORATORY COMPANION TO FATS AND OILS INDUSTRIES. By Dr. J. LEWKOWITSCH. Svo. 6s. net.

WORKS ON PHYSICS.

- PHYSICS: Advanced Course. By GEO. F. BARKER, Professor of Physics in the University of Pennsylvania. Svo. 21s.
- ELEMENTS OF THEORETICAL PHYSICS. By Dr. C. CHRISTIANSEN. Translated into English by W. F. MAGIE, Ph.D. Svo. 12s 6d. net.
- A TEXT-BOOK OF THE PRINCIPLES OF PHYSICS. By ALFRED DANIELL, M.A., D.Sc. Illustrated. Third Edition. Medium Svo. 21s.
- THE MATHEMATICAL THEORY OF PERFECTLY ELASTIC SOLIDS, with a Short Account of Viscous Fluids. By W. J. IBBETSON. 8vo. 21s.
- UTILITY OF QUATERNIONS IN PHYSICS. By ALEX. M'AULAY. Svo. 5s. net.
- THE FIRST THREE SECTIONS OF NEWTON'S PRINCIPIA. With Notes, Illustrations, and Problems. By P. FROST, M.A., D.Sc. Third Edition. Svo. 12s.
- LABORATORY MANUAL OF PHYSICS AND APPLIED ELECTRICITY. Arranged and Edited by EDWARD L. NICHOLS, Professor of Physics in Cornell University. Svo. Vol. I. Junior Course in General Physics. With Tables. 12s. 6d. net. Vol. II. Senior Courses. 12s. 6d. net.
- ELEMENTS OF PHYSICS. By E. L. NICHOLS and W. S. FRANKLIN. Svo. Vol. I. Mechanics and Heat; Vol. II. Electricity and Magnetism; Vol. III. Light and Sound. 6s. net each.
- THE ELEMENTS OF ALTERNATING CURRENTS. By W. S. FRANKLIN and R. B. WILLIAMSON. Svo. 10s. net.
- A TREATISE ON MAGNETISM AND ELECTRICITY. By ANDREW GRAY, M.A. Svo. Part I. 14s. net.
- ELECTRIC WAVES. By H. HERTZ. Translated by D. E. JONES, B.Sc. Second Edition. Svo. 10s. net.
- MISCELLANEOUS PAPERS. By H. HERTZ. Translated by D. E. JONES, B.Sc., and B. A. SCHOTT, B.Sc. Svo. 10s. net.
- TEXT-BOOK ON ELECTRO-MAGNETISM. By DUGALD C. JACKSON, B.Sc., C.E., Professor of Electrical Engineering in the University of Wisconsin. Extra Crown Svo. Vol. I., 9s. net; Vol. II., 14s. net.
- ELECTRO-MAGNETIC THEORY OF LIGHT. By CHARLES EMERSON CURRY, Ph.D. Part I. Svo. 12s. net.
- THE THEORY OF LIGHT. By THOMAS PRESTON, M.A., late Professor of Natural Philosophy, University College, Dublin. Third Edition, edited by Prof. C. J. JOLY. Svo. 15s. net.
- THE THEORY OF HEAT. By THOMAS PRESTON, M.A. Second Edition, revised by J. R. COTTER, M.A. Svo. 18s. net.

LONDON: MACMILLAN & CO., LTD.

WORKS ON BOTANY.

Practical Botany for Beginners.

By Prof. F. O. BOWER and D. T. GWYNNE VAUGHAN, M.A.
Globe Svo. 3s. 6d.

GUARDIAN.—"We should say there is no more complete handbook published: it satisfies the supreme test, for with its assistance an absolute novice could procure and set up apparatus and teach himself, dispensing with oral instruction."

University Text-Book of Botany.

By Professor DOUGLAS HOUGHTON CAMPBELL, Ph.D. Svo. 17s. net.

ATHENÆUM.—"We may congratulate the author on the success of his attempt. There was no room for much novelty in the arrangement of materials, but the presentment of the details is concise, lucid, and up-to-date. It is, by reason of its condensation, not a book which we should place in the hands of a beginner, but to more advanced students it will be of very great value."

The Structure and Development of Mosses and Ferns. (*Archegoniatae.*)

By Professor DOUGLAS HOUGHTON CAMPBELL, Ph.D. Svo. 18s. 6d. net.

KNOWLEDGE.—"Botanists should be grateful for this solid and comprehensive contribution to the literature of the Archegoniate series—the best that has appeared for some years. Prof. Campbell's work will be long recognised as a standard one for students of the structure, development, and inter-relationships of the lowly but important families of plants described in it."

Lectures on the Evolution of Plants.

By Professor DOUGLAS HOUGHTON CAMPBELL, Ph.D. Crown Svo. 4s. 6d. net.

ATHENÆUM.—"The present book is admirably adapted to convey a general knowledge of the subject, and to serve as an introduction to more recondite treatises. Not only does it pass in review the main groups of plants, but it deals also with such subjects as the geographical and the geological distribution of plants, the relationships of animals and plants, and the influence of what we used to call external conditions, but which is now universally spoken of as the 'environment.'"

WORKS ON BOTANY.

A New Edition. Revised with the Eighth German Edition by
DR. W. H. LANG.

A TEXT-BOOK OF BOTANY

BY

DR. E. STRASBURGER.

DR. FRITZ NOLL.

DR. H. SCHENCK.

DR. A. F. W. SCHIMPER.

Translated by H. C. PORTER, PH.D.

With all the Illustrations that appeared in the previous edition, and some additional ones.

ATHENÆUM.—“The book is thoroughly comprehensive, and masterly in its width of range and knowledge. . . . It will hold its own as the standard work, we should say, for some time to come.”

The Student's Flora of the British Islands.

By Sir J. D. HOOKER, M.D., D.C.L., LL.D., F.R.S. Third edition.
Globe 8vo. 10s. 6d.

Notes on the Life History of British Flowering

Plants. By LORD AVEBURY, F.R.S. Illustrated. 8vo. 15s. net.

Timber and some of its Diseases.

By H. MARSHALL WARD, D.Sc., F.R.S., F.L.S., formerly Professor of Botany in the University of Cambridge. Illustrated. Crown 8vo. 6s.

Disease in Plants.

By H. MARSHALL WARD, D.Sc., F.R.S., F.L.S., formerly Professor of Botany in the University of Cambridge. Crown 8vo. 7s. 6d.

GRAY'S BOTANICAL TEXT-BOOK.

Vol. I. Structural Botany ; or, Organography

on the Basis of Morphology. To which is added the Principles of Taxonomy and Phytography, and a Glossary of Botanical Terms. By ASA GRAY, LL.D., Fisher Professor of Natural History (Botany) in Harvard University. 8vo. 10s. 6d.

Vol. II. Physiological Botany.

I. Outline of the History of Phaenogamous Plants. II. Vegetable Physiology. By G. L. GOODALE. 8vo. 10s. 6d.

LONDON: MACMILLAN & CO., LTD.

